

HyperX QuadCast™ Microphone

Find the language and latest documentation for your HyperX QuadCast™ Microphone here.

HyperX QuadCast™ Microphone Headset Installation Guide

-  For instructions in English
-  Para instrucciones en Español
-  Für Anleitungen in Deutsch
-  Pour des instructions en Français
-  Per le istruzioni in Italiano
-  Por as instruções em Português
-  Instrukcje w języku Polskim
-  Для инструкции на Русском
-  Turkce talimatlar icin
-  日本語マニュアル用
-  한국어 안내
-  คำแนะนำภาษาไทย
-  Để xem hướng dẫn bằng tiếng Việt
- Simplified Chinese 简体中文说明书
- Traditional Chinese 繁體中文說明



HyperX QuadCast[™]



Part Numbers

HX-MICQC-BK

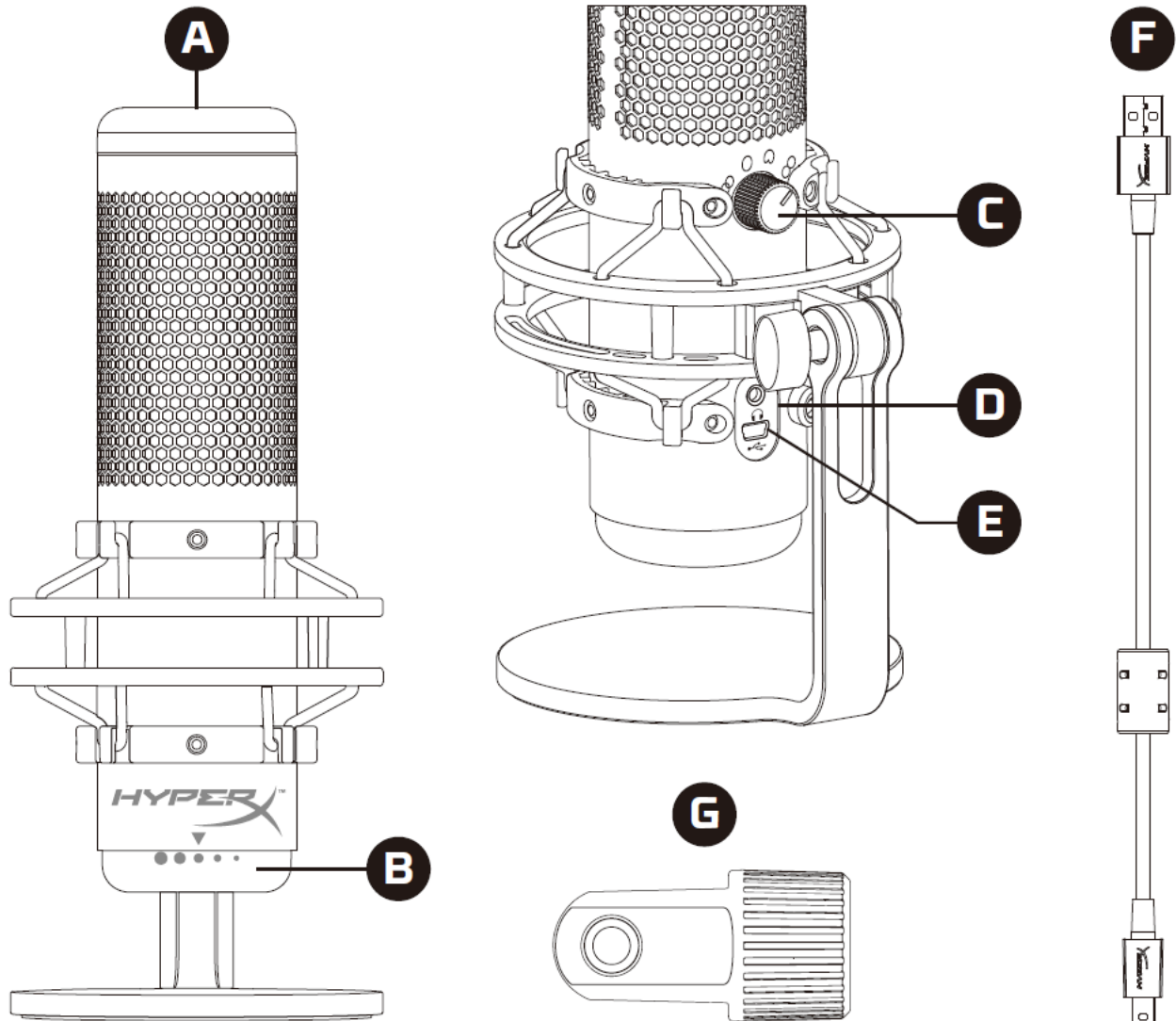

TABLE OF CONTENTS

Overview.....	3
Specifications	4
Microphone Controls.....	5
Using with PC or Mac	7
Using with PS4™	11
Connecting Headphones.....	12
Controlling Microphone Monitoring.....	13
Installing the Mount Adapter	15



Overview



- A. Tap-to-Mute Sensor
- B. Gain Control Knob
- C. Polar Pattern Knob
- D. Headphone Jack
- E. USB Cable Port
- F. USB Cable
- G. Mount Adapter*

*Supports both 3/8" and 5/8" thread sizes



Specifications

Microphone

Power consumption: 5V 125mA

Sample/bit rate: 48kHz/16-bit

Element: Electret condenser microphone

Condenser type: Three 14mm condensers

Polar patterns: Stereo, Omnidirectional, Cardioid, Bidirectional

Frequency response: 20Hz - 20kHz

Sensitivity: -36dB (1V/Pa at 1kHz)

Cable length: 3m

Weight:

- Microphone: 254g
- Shock mount and stand: 364g
- Total with USB cable: 710g

Headphone Output

Impedance: 32 Ω

Frequency response: 20Hz - 20kHz

Maximum power output: 7mW

THD: $\leq 0.05\%$ (1kHz/0dBFS)

SNR: $\geq 90\text{dB}$ (1kHz, $R_L = \infty$)



Microphone Controls

Selecting a Polar Pattern

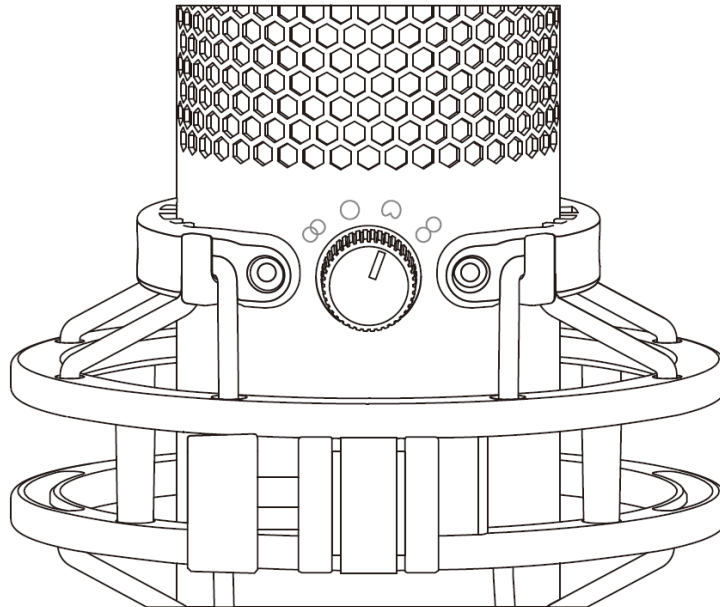

Rotate the polar pattern knob to select one of the four polar patterns.

Symbol	Sound Direction	Polar Pattern	Scenarios
		Stereo	Vocals, instruments
		Omnidirectional	Multi-person podcasts, conference calls
		Cardioid	Podcasts, streaming, voiceovers, instruments
		Bidirectional	Face-to-face interviews



Adjusting Gain Control

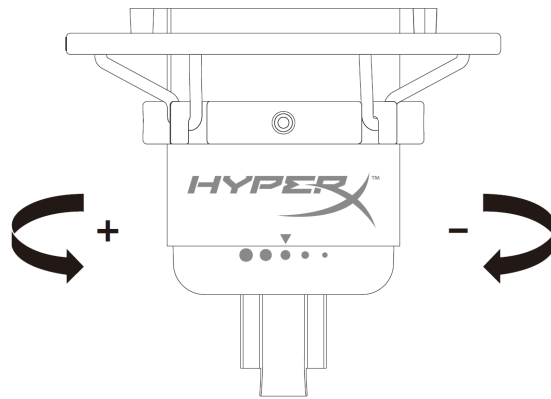

Rotate the gain control knob to adjust the gain of the microphone.

Muting the Microphone

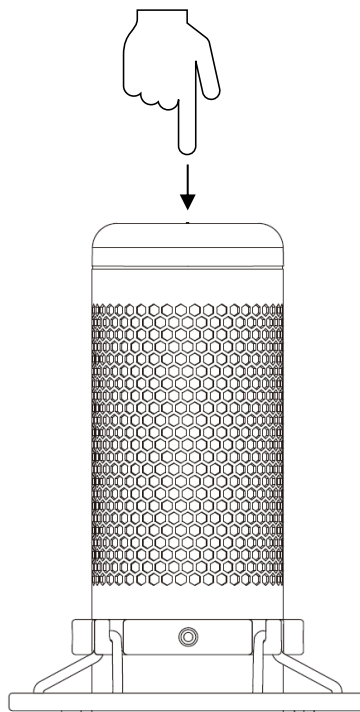

Tap the top of the microphone to mute/unmute the microphone. The microphone LED will indicate the current mute status of the microphone.

Microphone LED	Mute Status
Red	Mute off
Off	Mute on



Using with PC or Mac

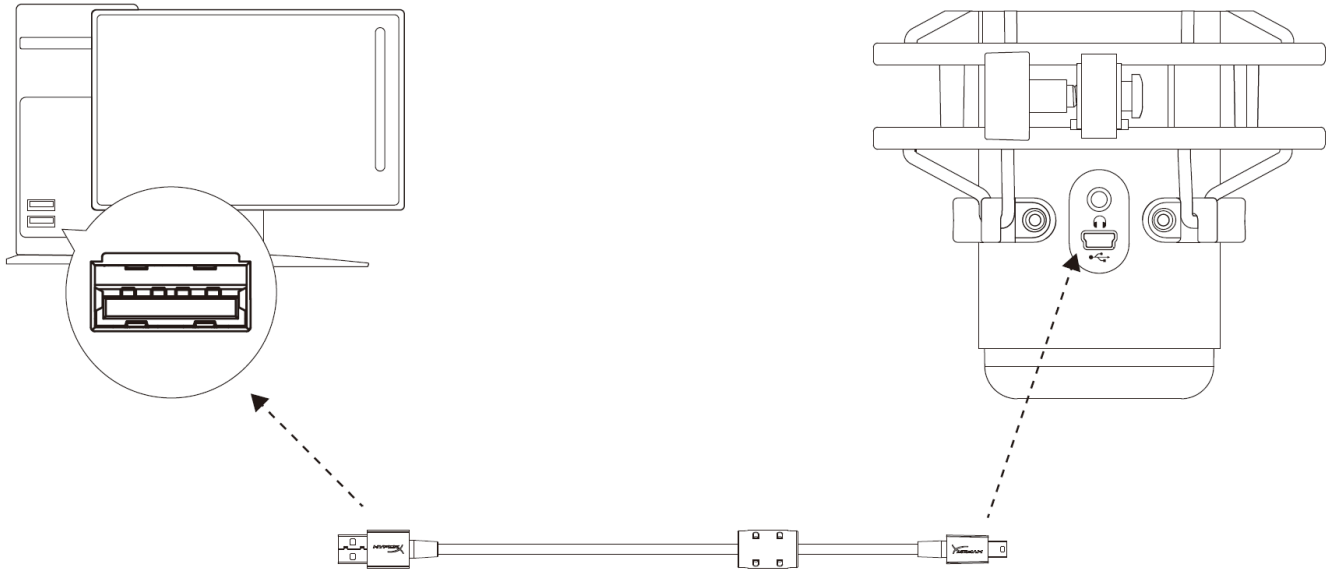

Connect the microphone to a USB port on the PC or Mac with the included USB cable.

Windows

To ensure the microphone is configured correctly on the PC, follow the steps below:

1. Right-click on the sound icon on the system tray and select **Sounds**.

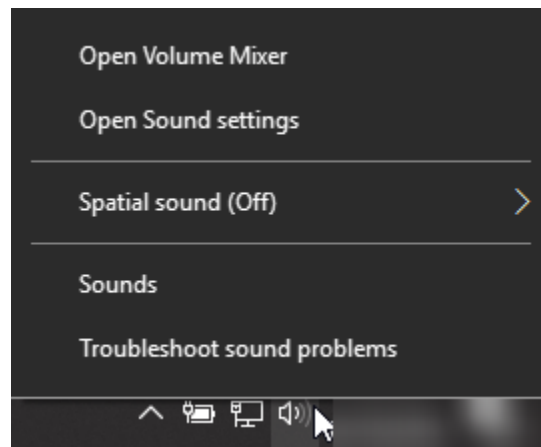



2. On the *Playback* tab, select **Speakers HyperX QuadCast** and click on the **Set Default** button.

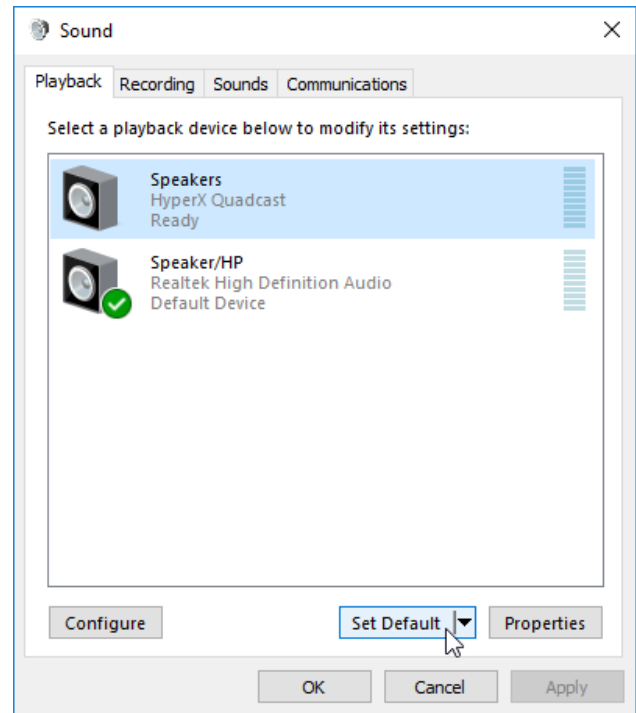

3. On the *Recording* tab, select **Microphone HyperX QuadCast** and click on the **Set Default** button.

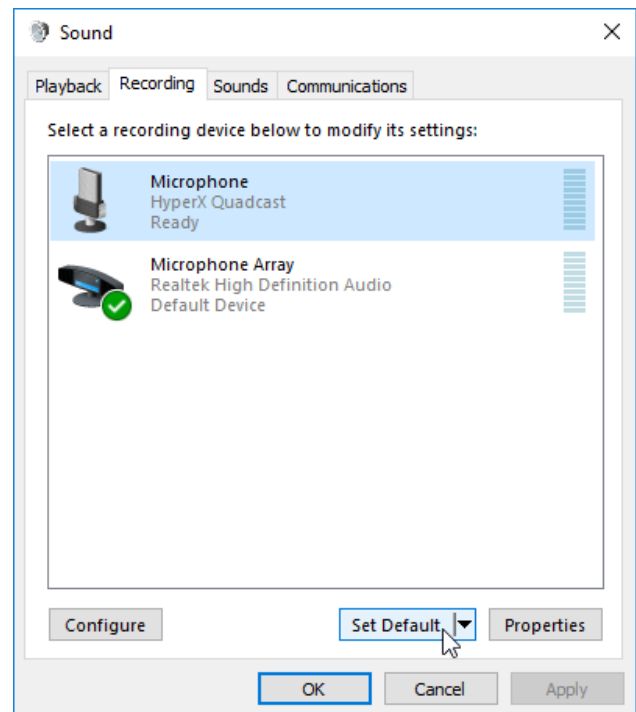



macOS

To ensure the microphone is configured correctly on the macOS, follow the steps below:

1. Open **System Preferences** and select **Sound**.

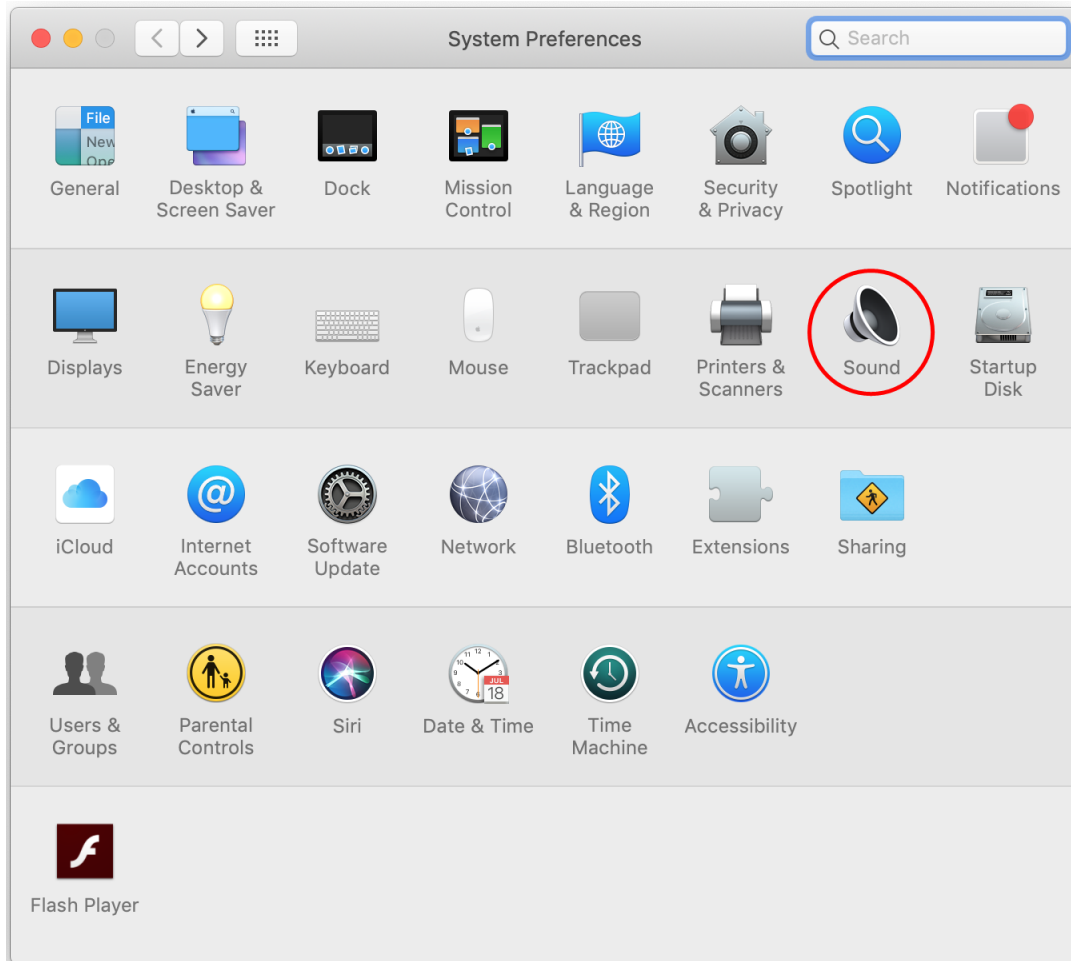



2. On the *Output* tab, select **HyperX QuadCast**.

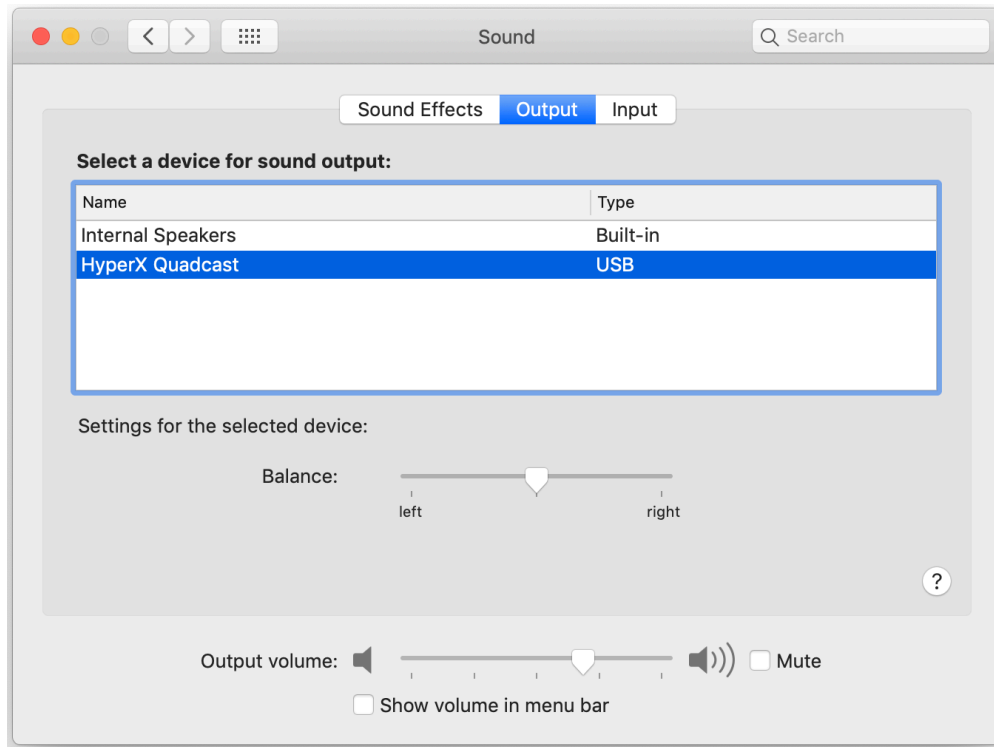

3. On the *Input* tab, select **HyperX QuadCast**.

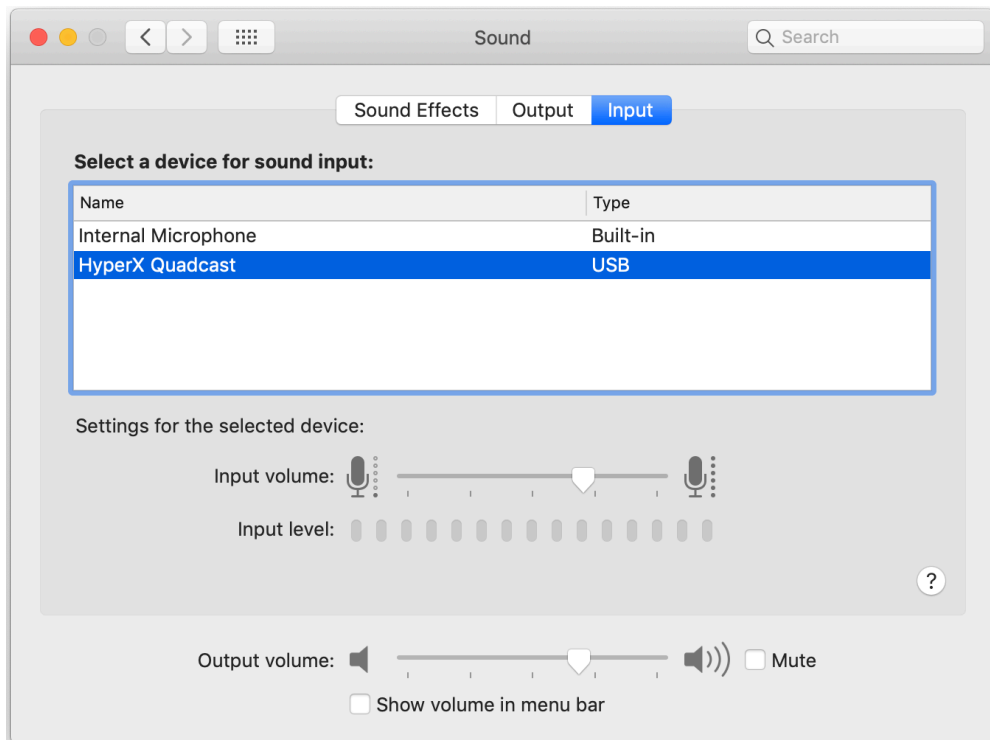



Using with PS4™

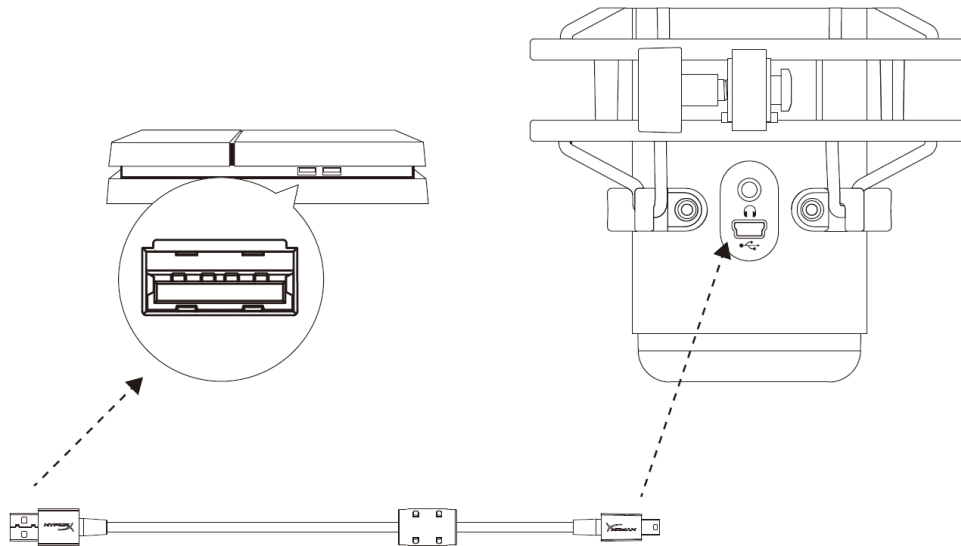

Connect the microphone to a USB port on the PS4 with the included USB cable.

To ensure the microphone is configured with the most optimal settings on the PS4, follow the steps below:

1. From the PS4 main menu, go to **Settings > Devices > Audio Devices**
2. Set *Input Device* to **USB Headset (HyperX QuadCast)**
3. Set *Output Device* to **USB Headset (HyperX QuadCast)**
4. Set *Output to Headphones* to **All Audio**
5. Set *Volume Control (Headphones)* to desired volume.

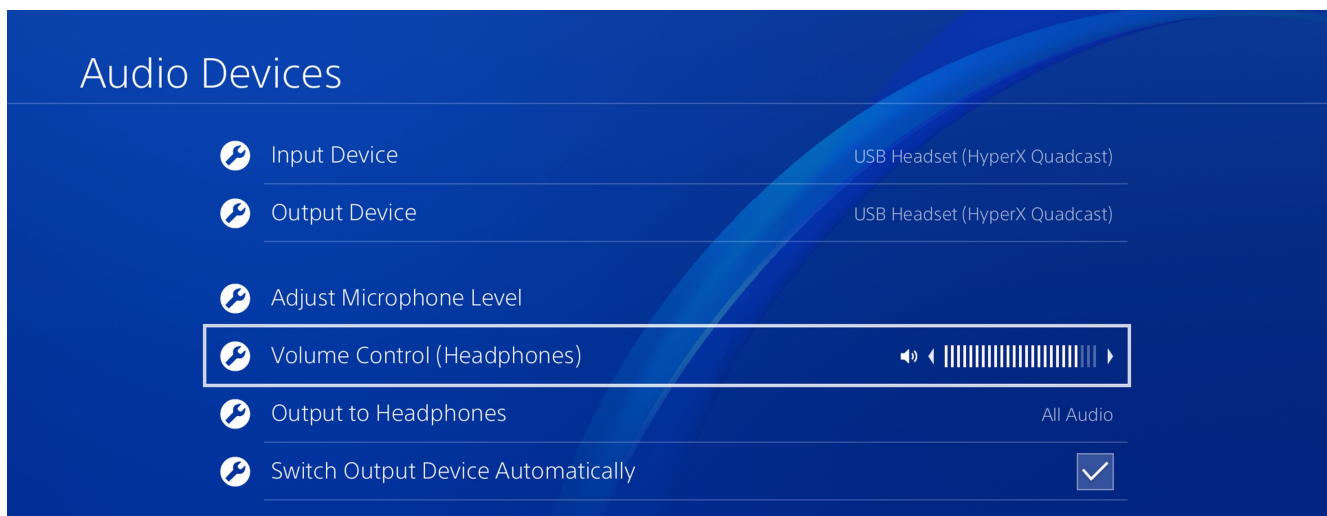



Connecting Headphones

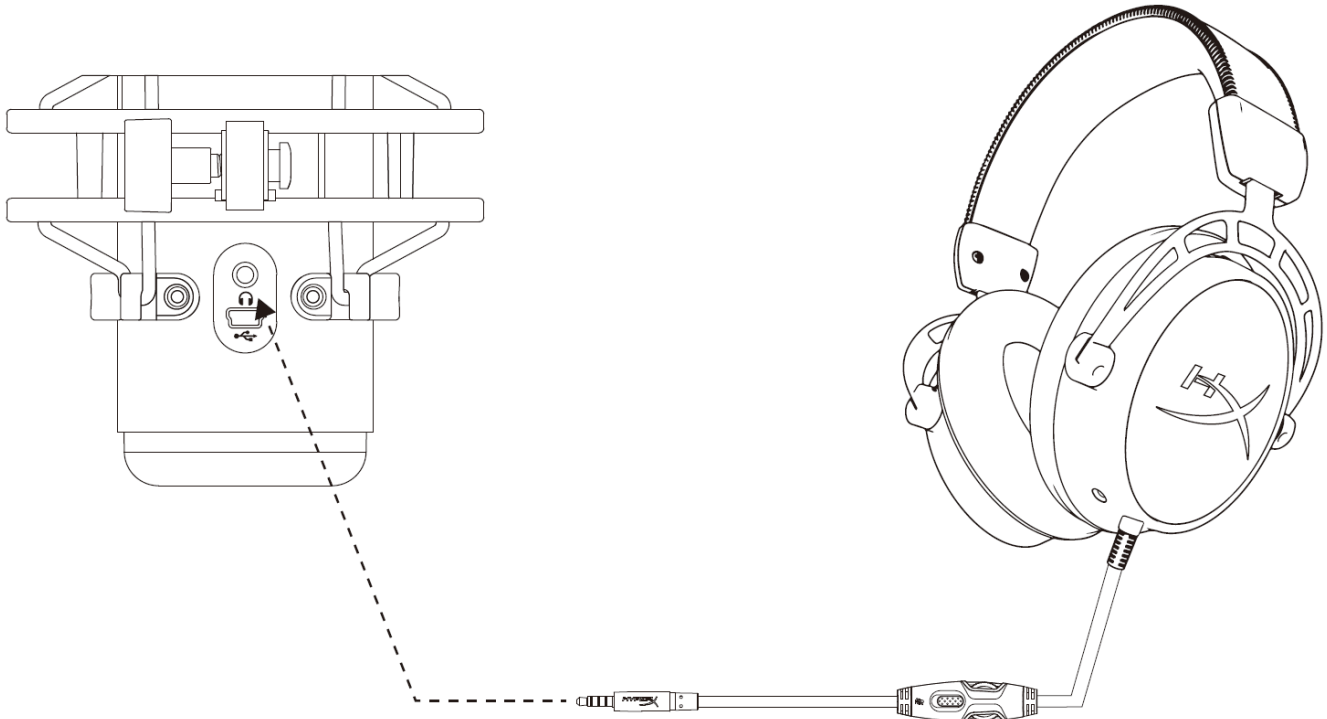

Connect headphones to the headphone jack on the microphone for microphone monitoring and playback audio.



Controlling Microphone Monitoring

PC

1. From the Sound control panel, on the *Playback* tab, right-click on **Speakers HyperX QuadCast** and select **Properties**.

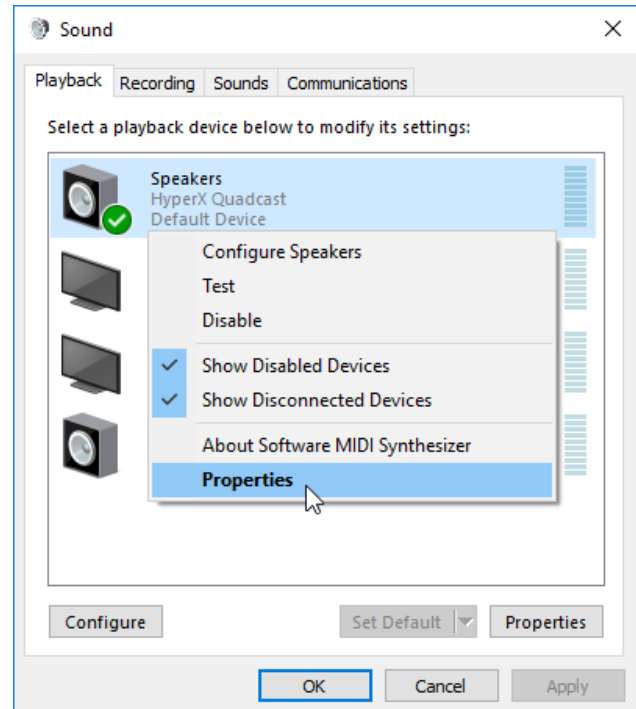

2. On the *Levels* tab, adjust the **Microphone** volume slider to adjust the level of microphone monitoring.

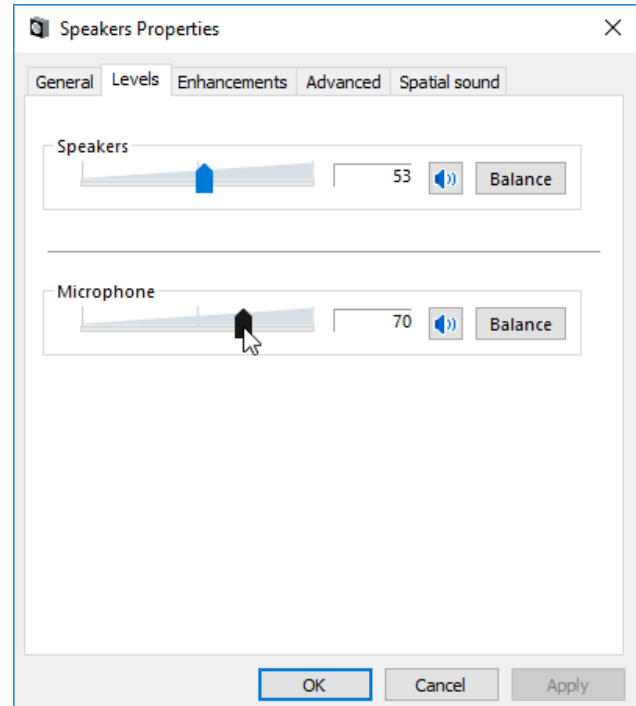



macOS

1. Open the **Finder** app and go to **Applications > Utilities > Audio MIDI Setup**

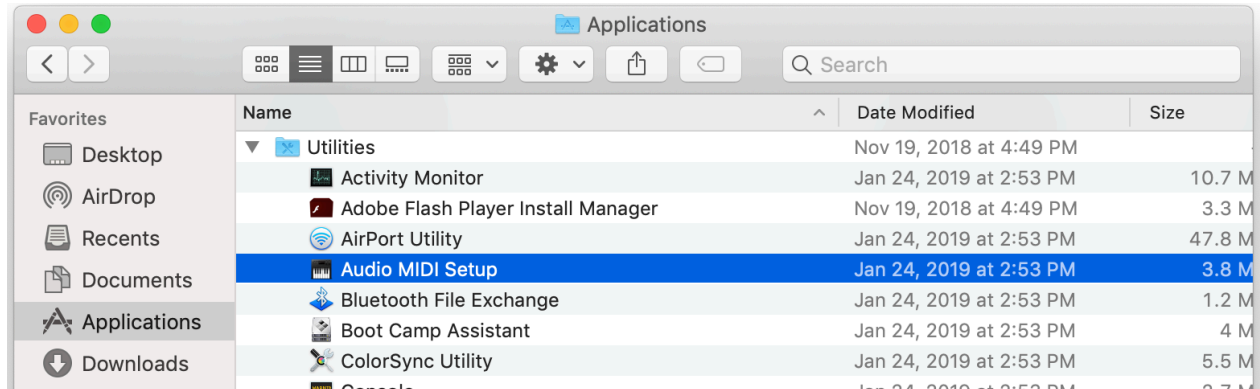

2. Click on **HyperX QuadCast 2** and click on the checkbox under the *Thru* column to toggle microphone monitoring on or off.

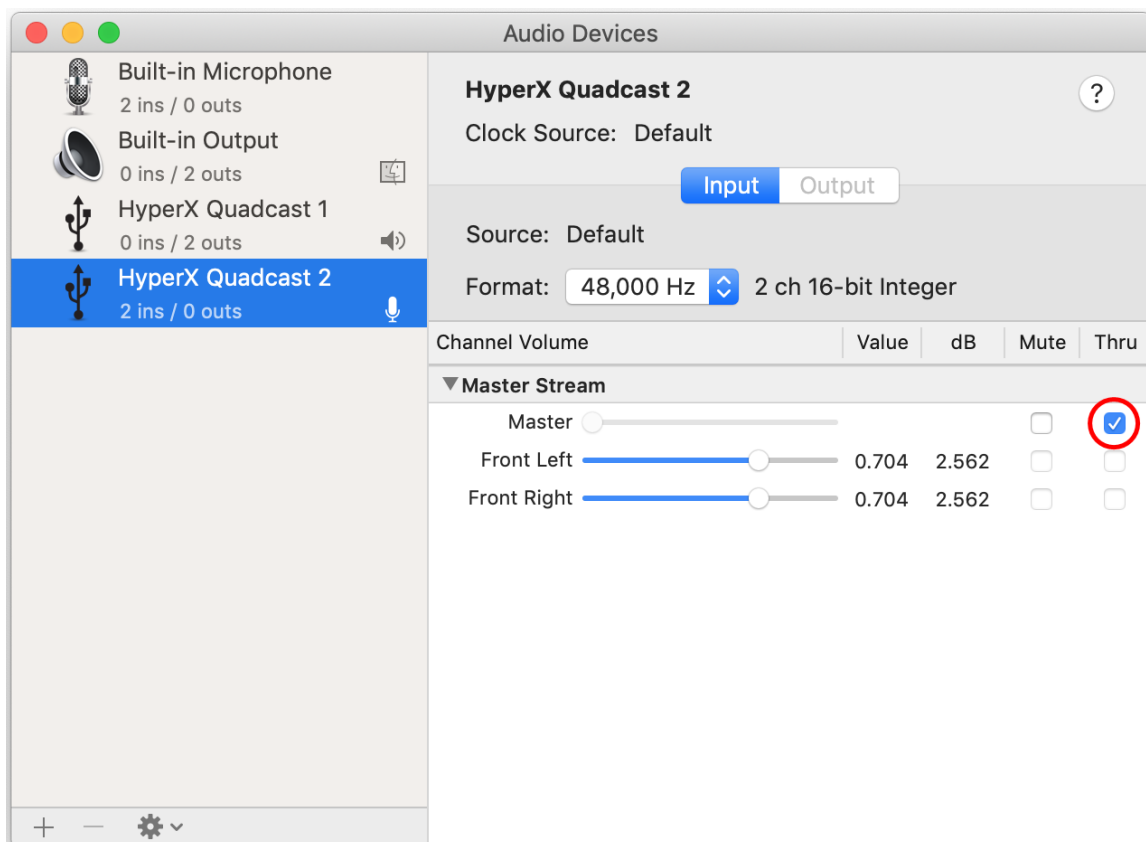

PS4

Microphone monitoring level cannot be directly controlled on PS4.



Installing the Mount Adapter

1. Secure the included mount adapter onto a microphone boom arm. The mount adapter supports 3/8" and 5/8" thread sizes.
2. Remove both the thumb screw and nut from the microphone stand.
3. Remove the microphone stand from the microphone.
4. Align the mount adapter with the microphone mount holes and secure the adapter with the thumb screw and nut.



Questions or Setup Issues?

Contact the HyperX support team at: hyperxgaming.com/support/



HyperX QuadCast[™]



Números de referencia

HX-MICQC-BK



ÍNDICE

Información general	3
Especificaciones	4
Controles del micrófono	5
Uso con PC o Mac	7
Uso con PS4™	11
Conexión de los auriculares	12
Control de la supervisión del micrófono	13
Instalación del adaptador de montaje.....	15



Información general

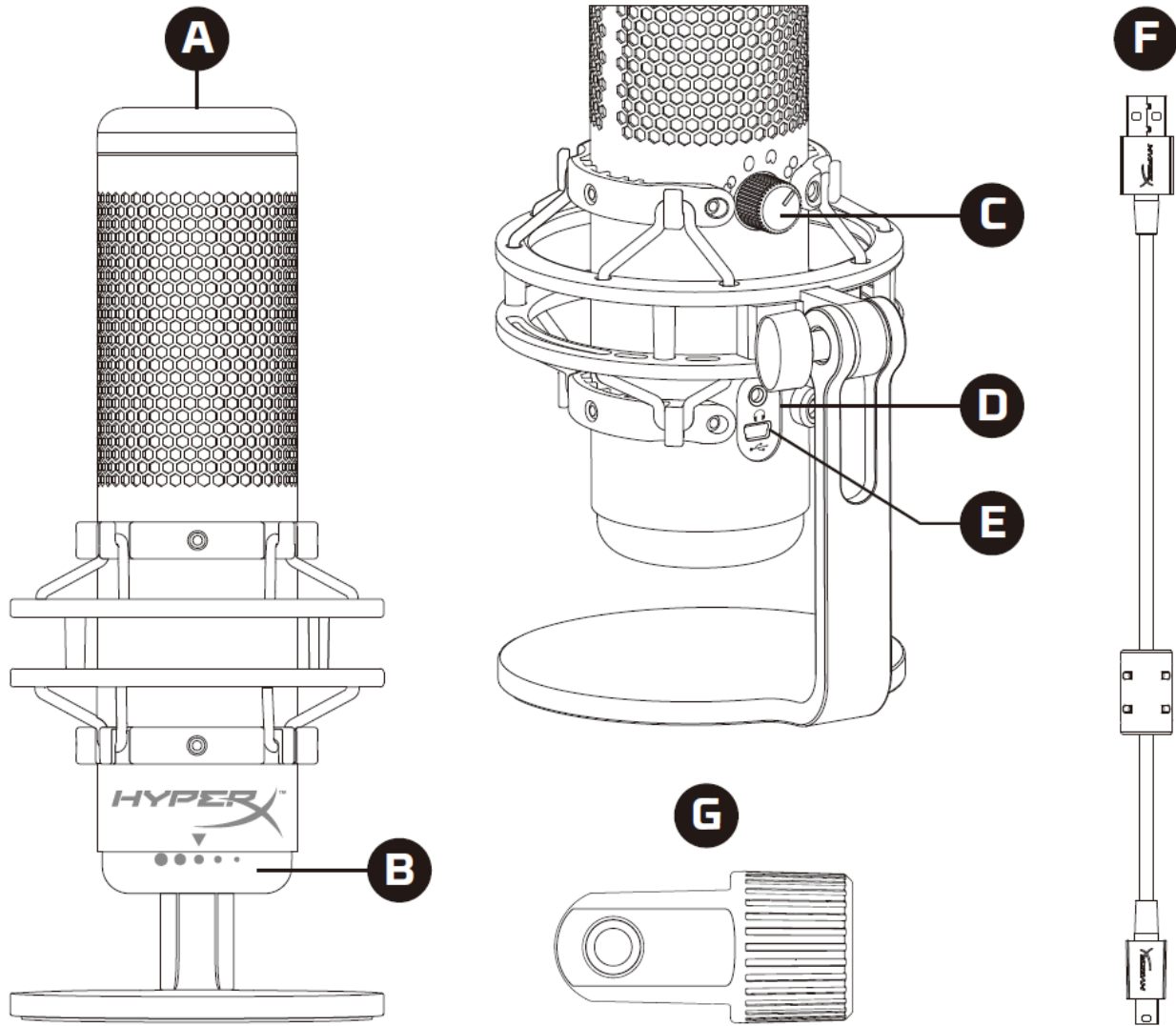

- A. Sensor de silenciamiento con un toque
- B. Perilla de control de ganancia
- C. Perilla de patrones polares
- D. Toma para auriculares
- E. Puerto de cable USB
- F. Cable USB
- G. Adaptador de montaje*

*Compatible con tamaños de rosca de 3/8 de pulgada y 5/8 de pulgada



Especificaciones

Micrófono

Consumo de energía: 5 V 125 mA

Frecuencia de muestreo/velocidad de bits: 48 kHz/16 bits

Elemento: Micrófono de condensador electret

Tipo de condensador: Tres condensadores de 14 mm

Patrones polares: Estéreo, omnidireccional, cardioide, bidireccional

Respuesta de frecuencia: 20 Hz - 20 kHz

Sensibilidad: -36 dB (1V/Pa a 1kHz)

Longitud del cable: 3 m

Peso:

- Micrófono: 254g
- Suspensión elástica y soporte: 364g
- Total con cable USB: 710 g

Salida de auriculares

Impedancia: 32 Ω

Respuesta de frecuencia: 20 Hz - 20 kHz

Salida de potencia máxima: 7 mW

THD: $\leq 0,05$ % (1 kHz/0 dBFS)

SNR: ≥ 90 dB (1 kHz, RL= ∞)



Controles del micrófono

Selección de un patrón polar

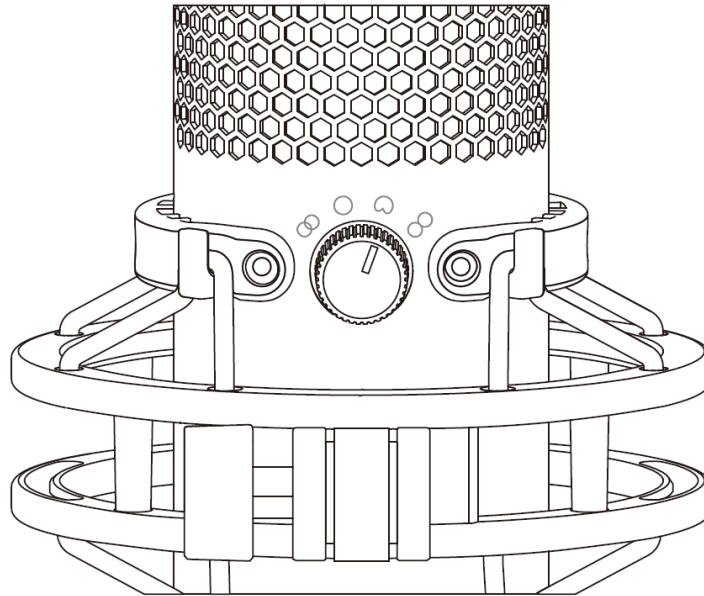

Gira la perilla de patrones polares para seleccionar uno de los cuatro patrones.

Símbolo	Dirección del sonido	Patrón polar	Situaciones
		Estéreo	Voz, instrumentos
		Omnidireccional	Podcast multipersona, llamadas de conferencia
		Cardioide	Podcasts, retransmisiones, locuciones, instrumentos
		Bidireccional	Entrevistas cara a cara



Ajuste del control de ganancia

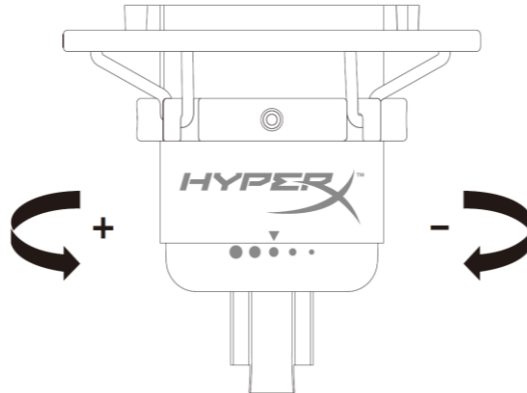

Gira la perilla de control de ganancia para ajustar la ganancia del micrófono.

Silenciamiento del micrófono

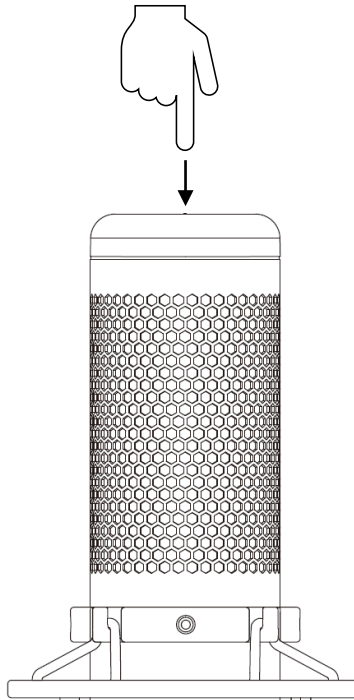

Toca la parte superior del micrófono para silenciar/activar el micrófono. El LED del micrófono indicará su estado actual de silenciamiento.

LED del micrófono	Estado de silenciamiento
Rojo	Activado
Apagado	Silenciado



Uso con PC o Mac

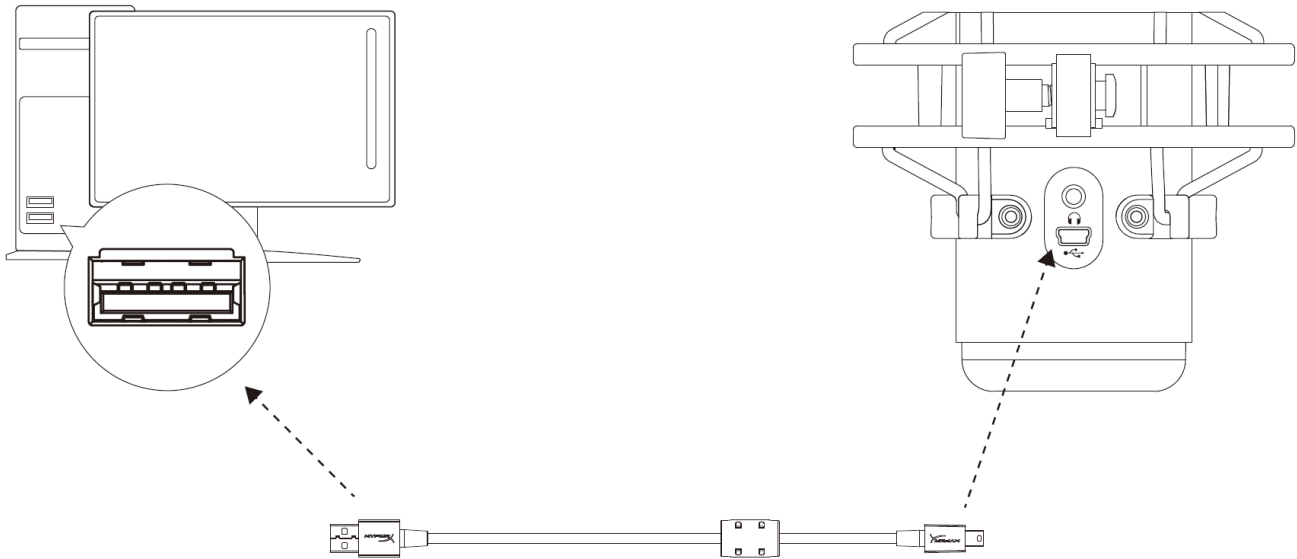

Conecta el micrófono a un puerto USB del PC o Mac con el cable USB incluido.

Windows

Para garantizar que el micrófono está correctamente configurado en el PC, sigue los pasos que se indican a continuación:

1. Haz clic con el botón derecho en el icono de sonido de la bandeja del sistema y selecciona **Sonidos**.

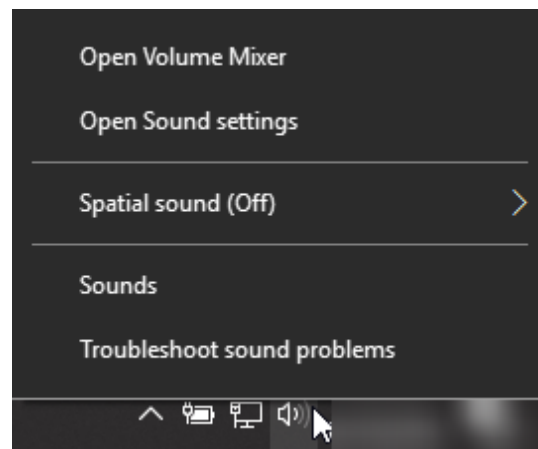



2. En la pestaña *Reproducción*, selecciona **Altavoces HyperX QuadCast** y haz clic en el botón **Establecer como predeterminado**.

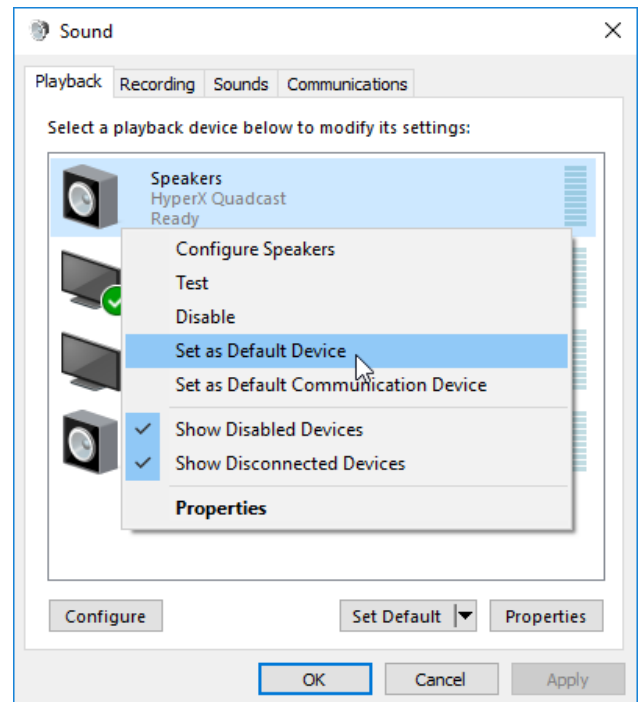

3. En la pestaña *Grabación*, selecciona **Micrófono HyperX QuadCast** y haz clic en el botón **Establecer como predeterminado**.

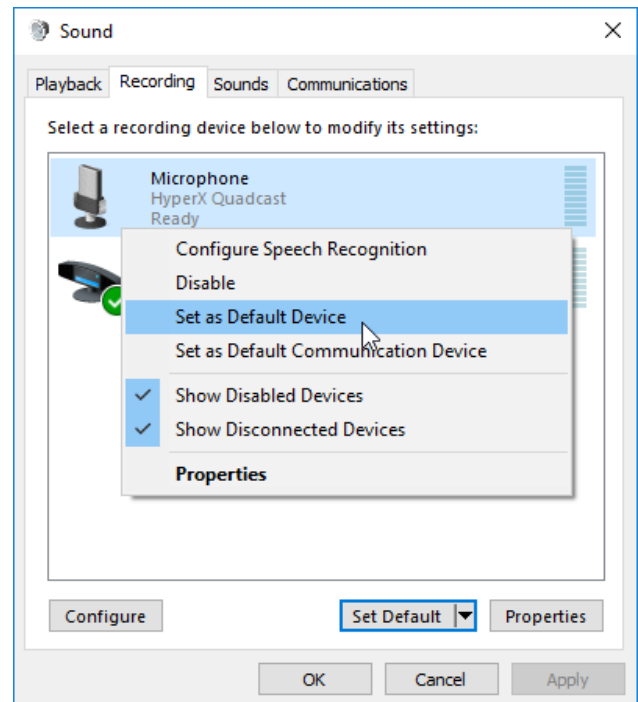



macOS

Para garantizar la correcta configuración del micrófono en el macOS, sigue los pasos que se indican a continuación:

1. Abre **Preferencias del sistema** y selecciona **Sonido**.

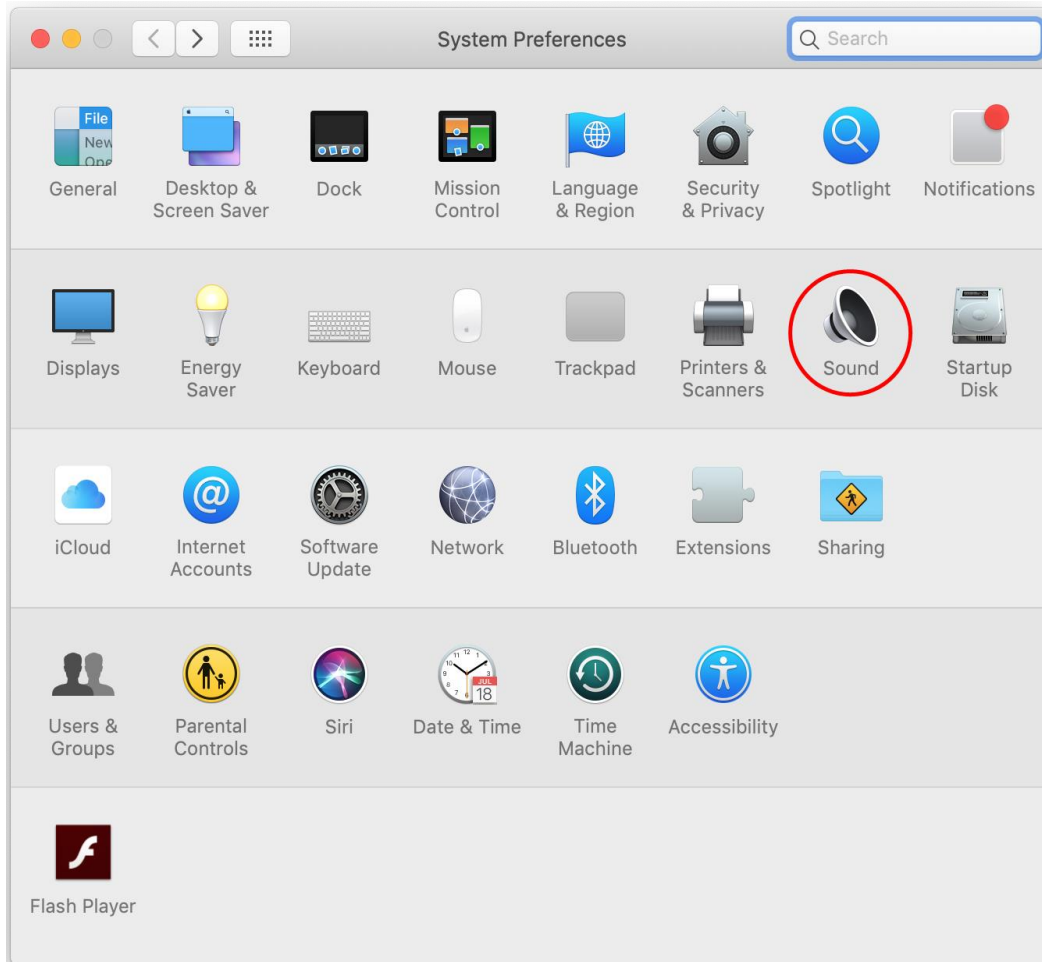



2. En la pestaña *Salida*, selecciona **HyperX QuadCast**.

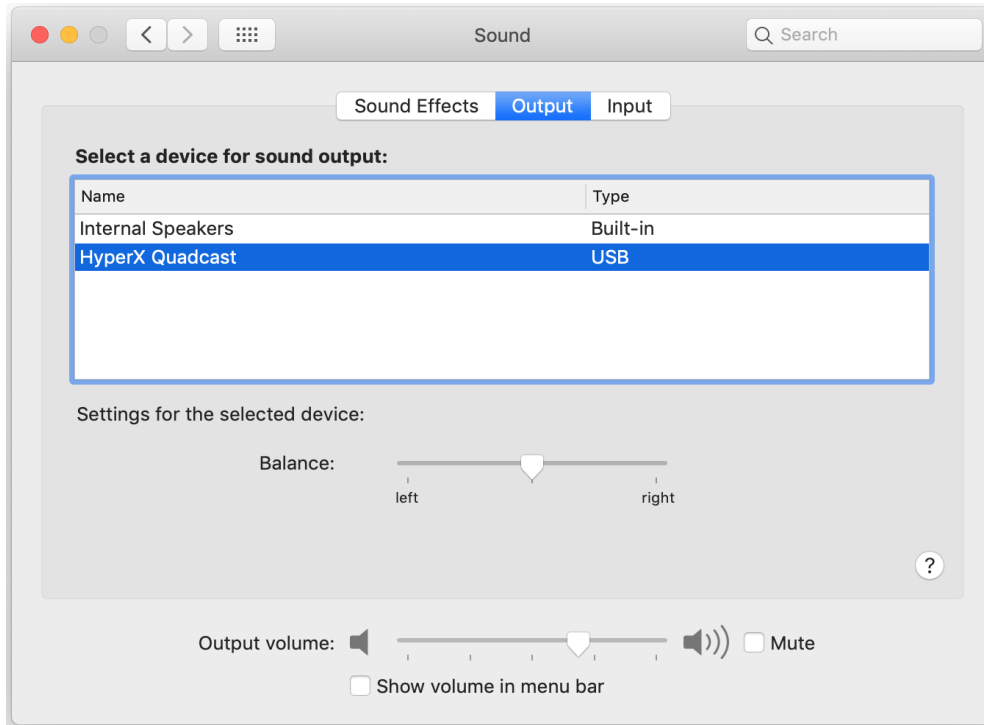

3. En la pestaña *Entrada*, selecciona **HyperX QuadCast**.

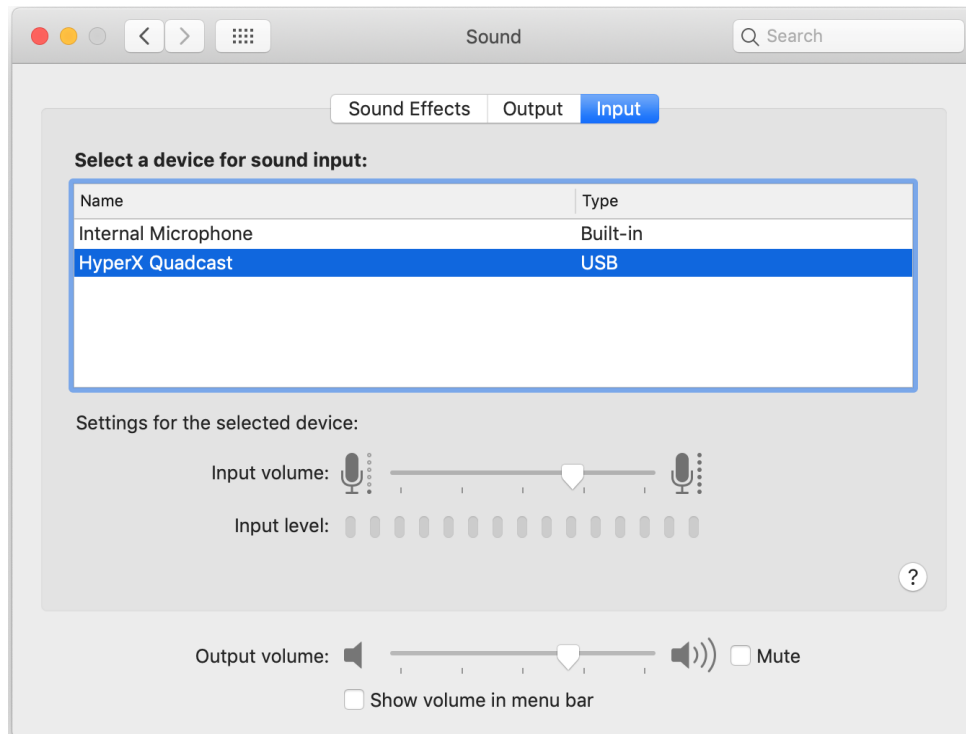



Uso con PS4™

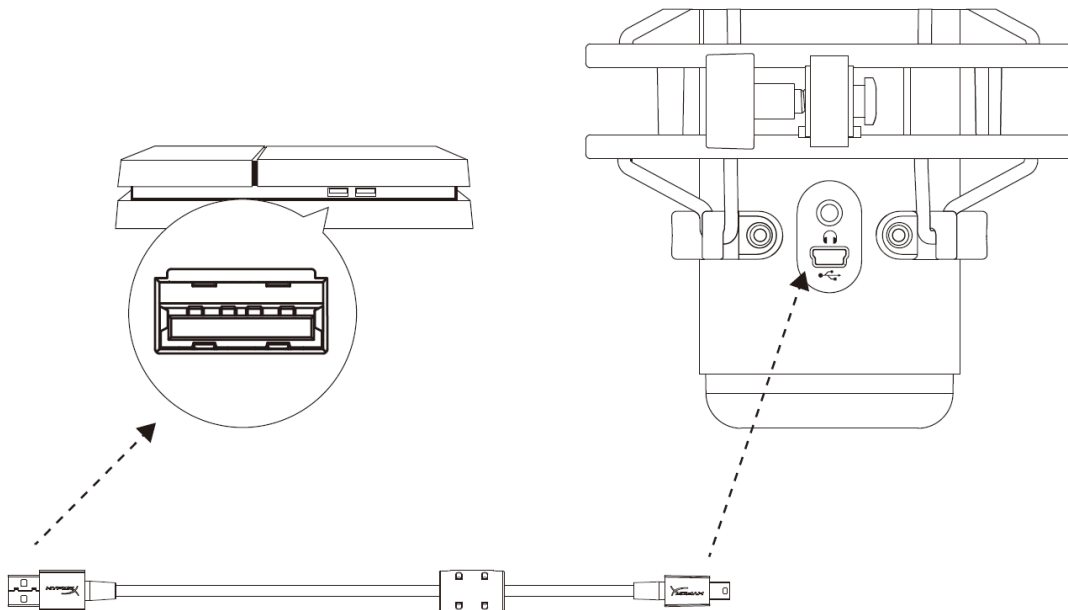

Conecta el micrófono a un puerto USB de la PS4 con el cable USB incluido.

Para garantizar que el micrófono está configurado con los ajustes más adecuados para la PS4, sigue los pasos que se indican a continuación:

1. Desde el menú principal de la PS4, dirígete a **Ajustes > Dispositivos > Dispositivos de audio**
2. En *Dispositivo de entrada*, selecciona **Auriculares USB (HyperX QuadCast)**
3. En *Dispositivo de salida*, selecciona **Auriculares USB (HyperX QuadCast)**
4. Establece *Salida a auriculares* en **Todo el audio**
5. Establece *Control de volumen (auriculares)* en el volumen que quieras

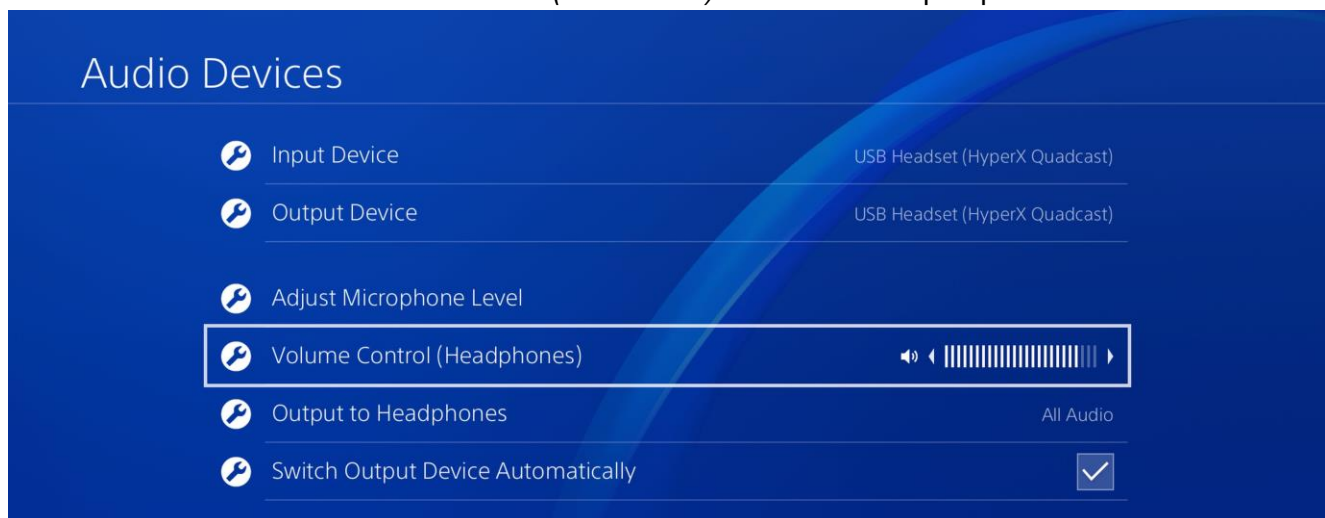



Conexión de los auriculares

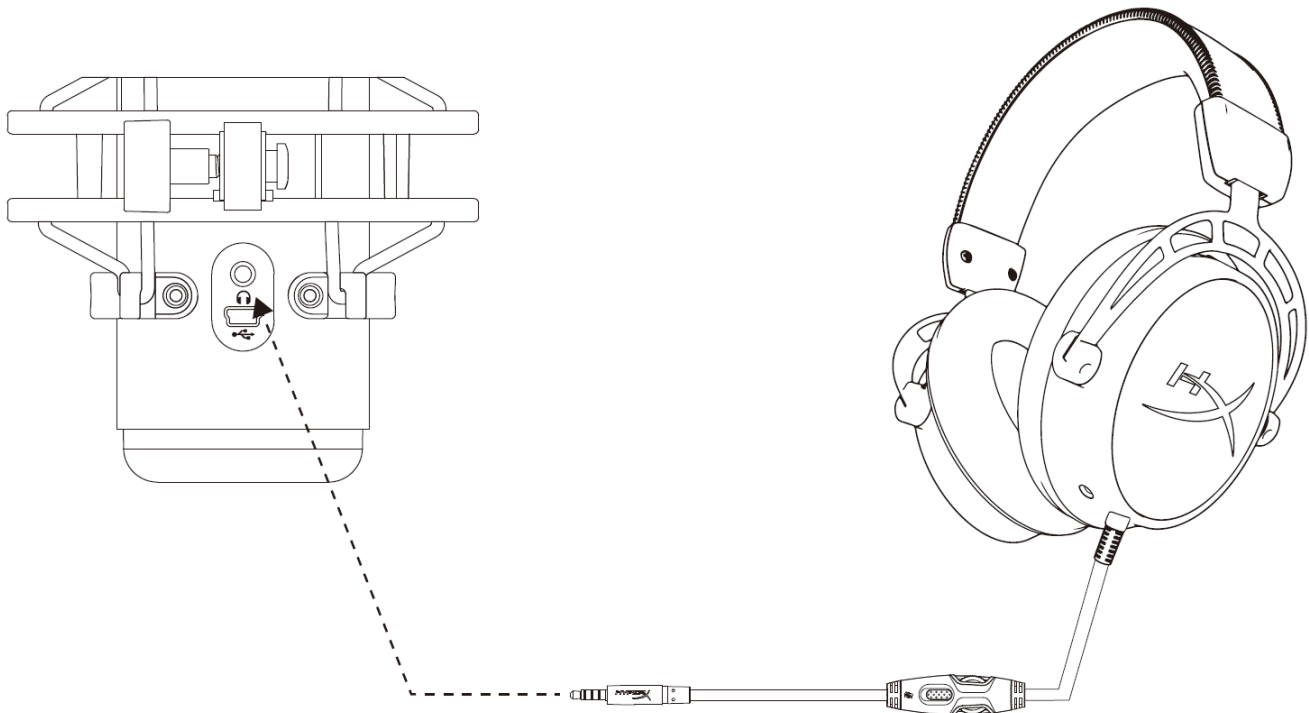

Conecta los auriculares a la toma correspondiente del micrófono para monitorización del micrófono y la reproducción de audio.



Control de la supervisión del micrófono

PC

1. En el panel de control del sonido, en la pestaña *Reproducción*, haz clic con el botón derecho en **Altavoces HyperX QuadCast** y selecciona **Propiedades**.

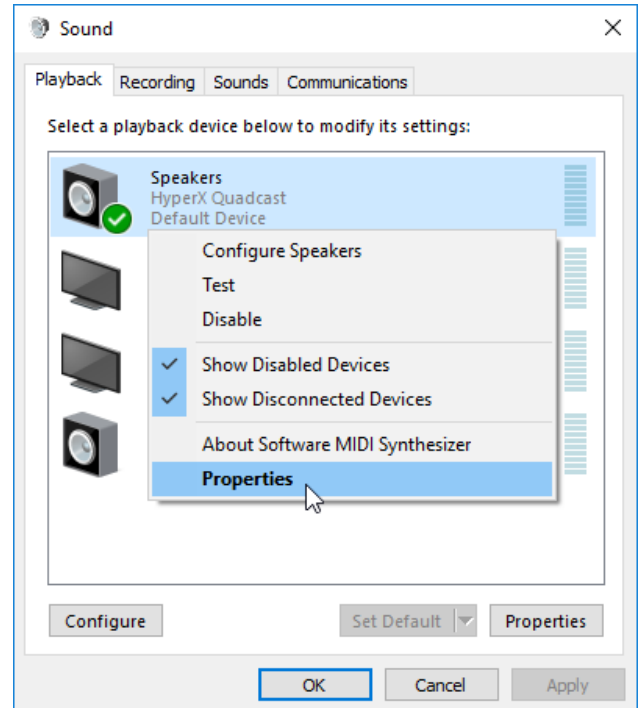

2. En la pestaña *Niveles*, ajusta el control deslizante de volumen del **micrófono** para definir el nivel de monitorización del micrófono.

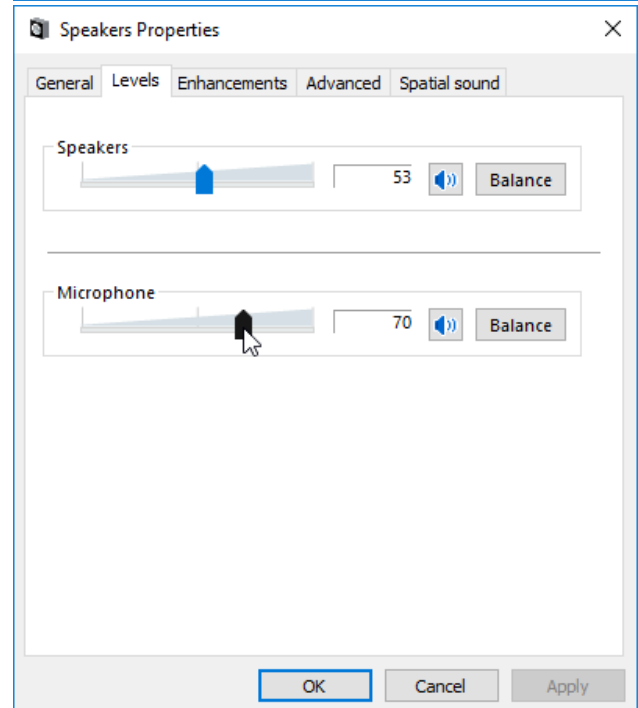



macOS

1. Abra la aplicación **Finder** y vete a **Aplicaciones > Utilidades > Configuración de Audio MIDI**

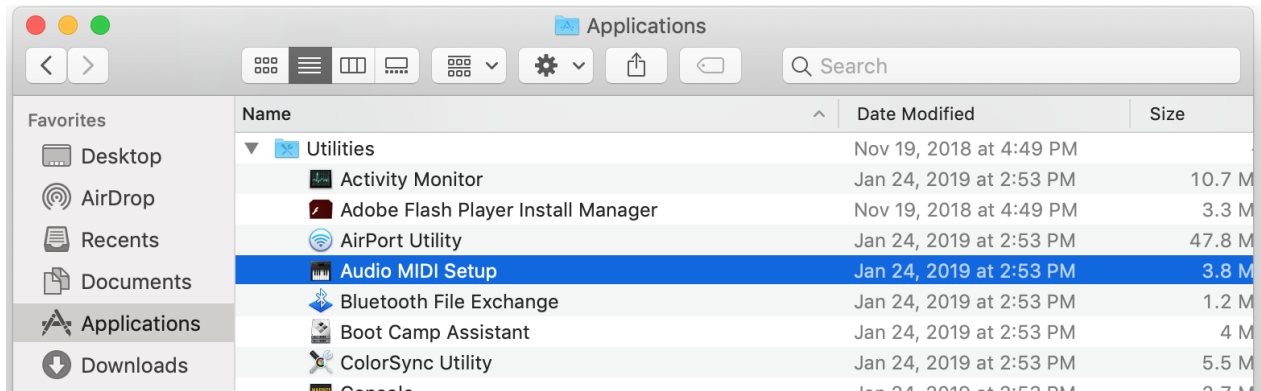

2. Haz clic en **HyperX QuadCast 2** y después haz clic en la casilla de verificación que se encuentra debajo de la columna *Thru* para activar o desactivar la supervisión del micrófono.

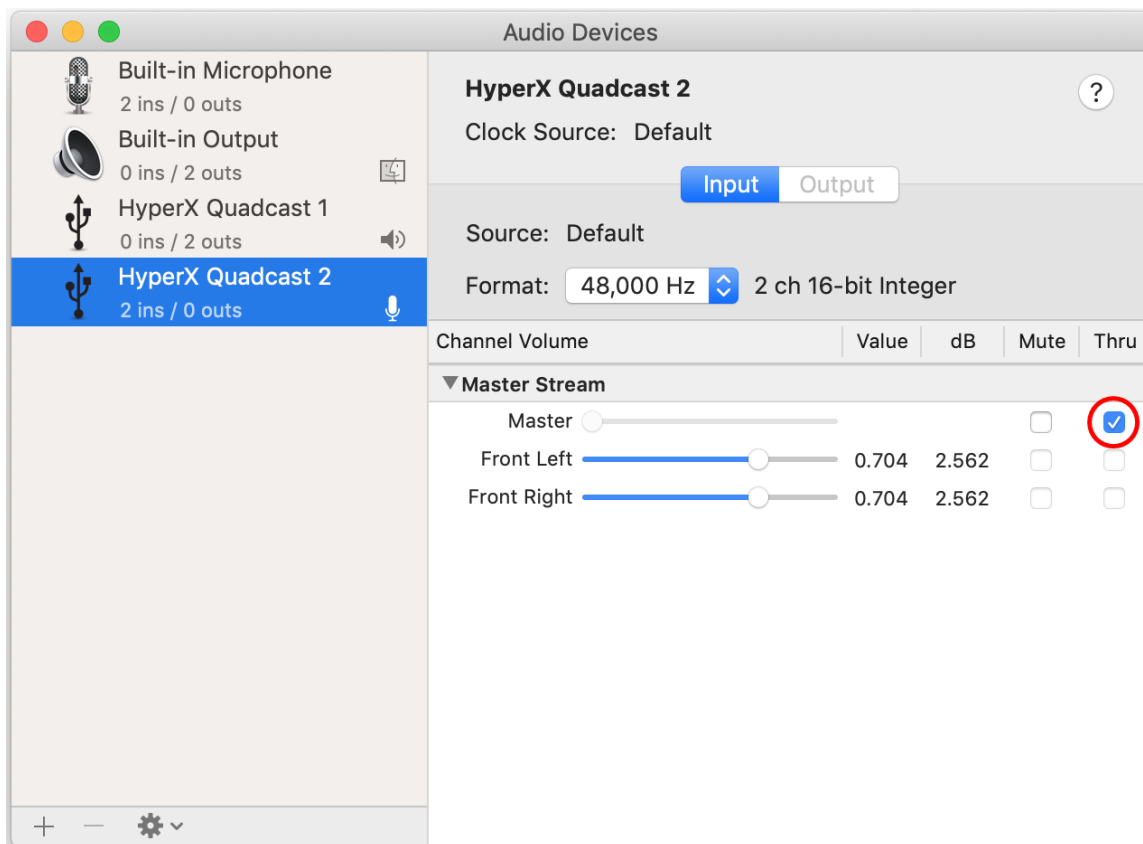

PS4

No puede controlar directamente el nivel de supervisión del micrófono en la PS4.



Instalación del adaptador de montaje

1. Fija el adaptador de montaje incluido en un brazo del micrófono. El adaptador de montaje es compatible con tamaños de rosca de 3/8 de pulgada y 5/8 de pulgada.
2. Retira el tornillo de mariposa y la tuerca del soporte del micrófono.
3. Retira el soporte del micrófono.
4. Alinea el adaptador de montaje con los orificios de montaje del micrófono y fija el adaptador con el tornillo y la tuerca.



¿Tienes alguna pregunta o problema de configuración?

Ponte en contacto con el equipo de soporte de HyperX en: hyperxgaming.com/support/



HyperX QuadCast[™]



Artikelnummern

HX-MICQC-BK



INHALT

Übersicht	3
Spezifikationen	4
Mikrofonsteuerung	5
Nutzung mit einem PC oder Mac	7
Nutzung mit PS4™	11
Anschließen der Kopfhörer	12
Steuerung der Mikrofonüberwachung	13
Installation des Halterungsadapters	15



Übersicht

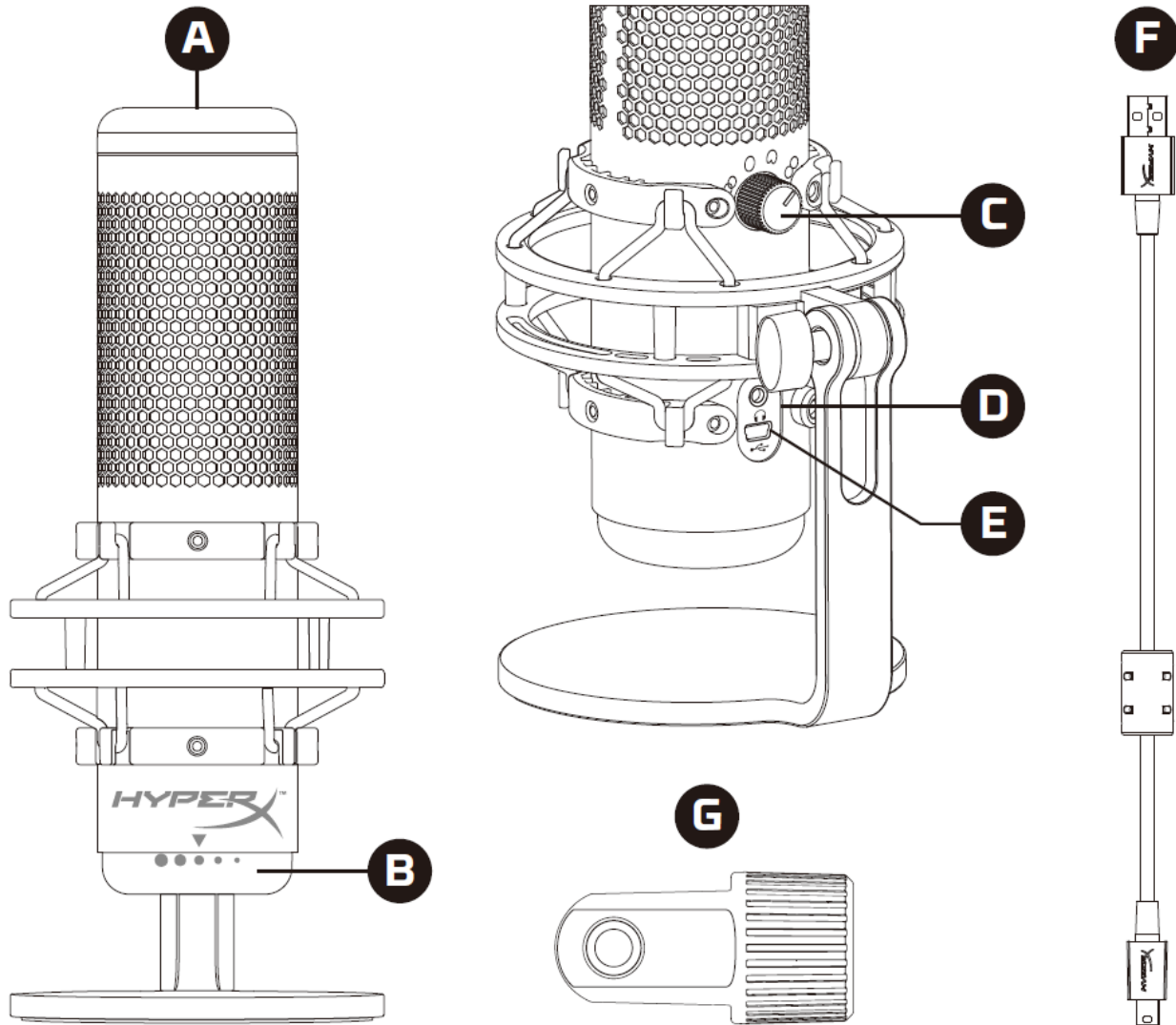

- A. Tippen-zum-Stummschalten-Sensor
- B. Verstärkungsregel-Knopf
- C. Richtcharakteristik-Knopf
- D. Kopfhöreranschluss
- E. USB-Kabelanschluss
- F. USB-Kabel
- G. Halterungsadapter*

*Unterstützt sowohl 3/8"- als auch 5/8"-Gewindegrößen



Spezifikationen

Mikrofon

Energieverbrauch: 5V 125mA

Sample-/Bitrate: 48kHz/16-bit

Element: Elektrolytkondensator-Mikrofon

Kondensator: Drei 14mm-Kondensatoren

Richtcharakteristiken: stereo, omnidirektional, kardioid, bidirektional

Frequenzbereich: 20Hz–20kHz

Empfindlichkeit: -36dB (1V/Pa bei 1kHz)

Kabellänge: 3m

Gewicht:

- Mikrofon: 254g
- Stoßschutzhalterung und -ständer: 364g
- Insgesamt mit USB-Kabel: 710g

Kopfhörerausgang

Impedanz: 32 Ω

Frequenzbereich: 20Hz – 20kHz

Maximale Leistung: 7mW

THD: ≤ 0,05% (1kHz/0dBFS)

SNR: ≥ 90dB (1kHz, RL=∞)



Mikrofonsteuerung

Auswählen einer Richtcharakteristik

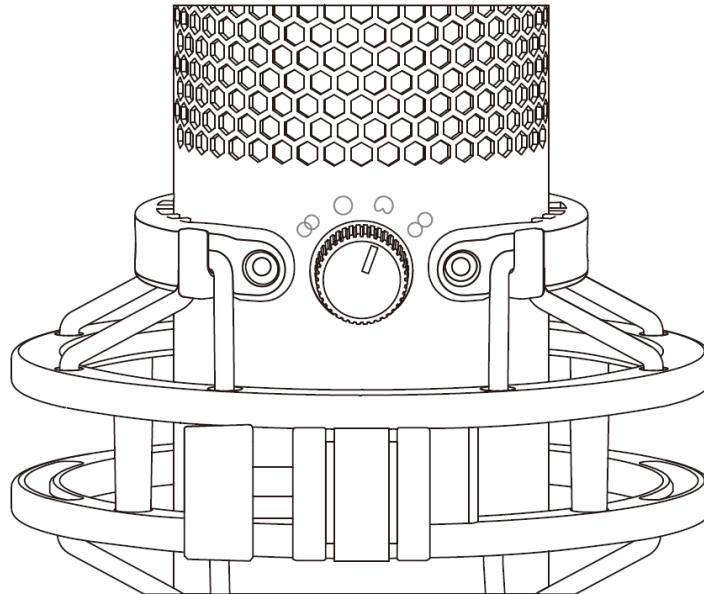

Drehen Sie den Richtcharakteristikknopf, um eine der vier Richtcharakteristiken auszuwählen.

Symbol	Sound-Richtung	Richtcharakteristik	Szenarien
		Stereo	Gesang, Instrumente
		Omnidirektional	Podcasts mit mehreren Teilnehmern, Konferenzschaltungen
		Kardioid	Podcasts, Streaming, Voice-Overs, Instrumente
		Bidirektional	Persönliche Interviews



Anpassen der Verstärkungsregelung

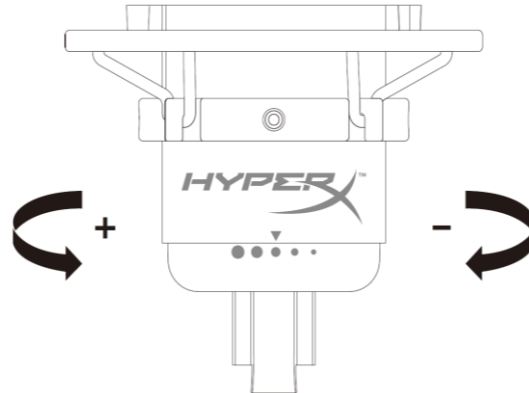

Drehe zum Anpassen der Mikrofonverstärkung den Verstärkungsregel-Knopf.

Stummschalten des Mikrofons

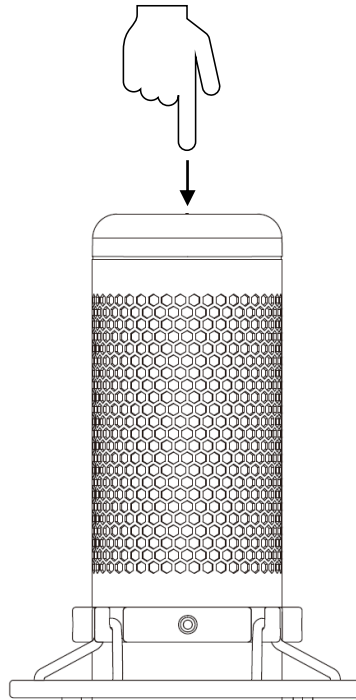

Tippe zum Stummschalten des Mikrofons bzw. zum Aufheben der Stummschaltung oben auf das Mikrofon. Die Mikrofon-LED zeigt den aktuellen Stummschalt-Status an.

Mikrofon-LED	Stummschalt-Status
Rot	Stummschaltung ausgeschaltet
Aus	Stummschaltung eingeschaltet



Nutzung mit einem PC oder Mac

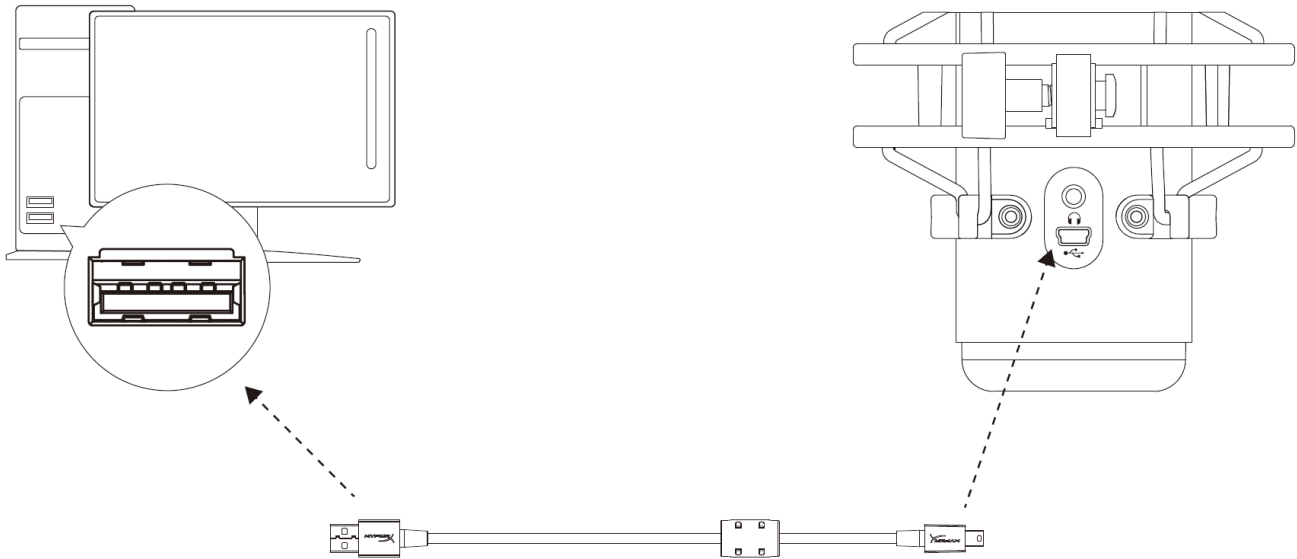

Das Mikrofon wird über das im Lieferumfang enthaltene USB-Kabel an einem USB-Anschluss mit dem PC oder Mac verbunden.

Windows

Gehe für das optimale Konfigurieren des Mikrofons am PC wie folgt vor:

1. Klicke mit der rechten Maustaste in der Taskleiste auf das Lautsprechersymbol und wähle **Sounds**.

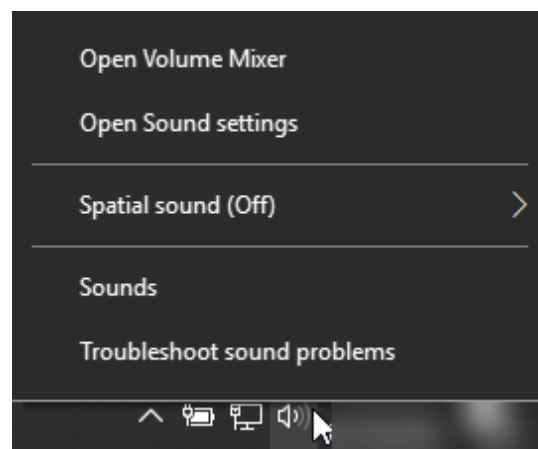



2. Wähle auf der Registerkarte *Wiedergabe* **Speakers HyperX QuadCast** und klicke dann auf die Schaltfläche **Als Standard**.

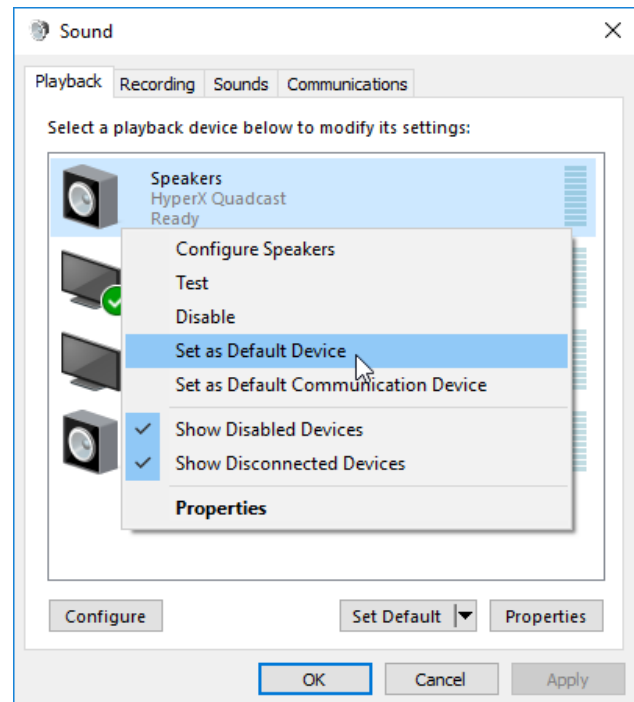

3. Wähle auf der Registerkarte *Aufnahme* **Speakers HyperX QuadCast** und klicke dann auf die Schaltfläche **Als Standard**.

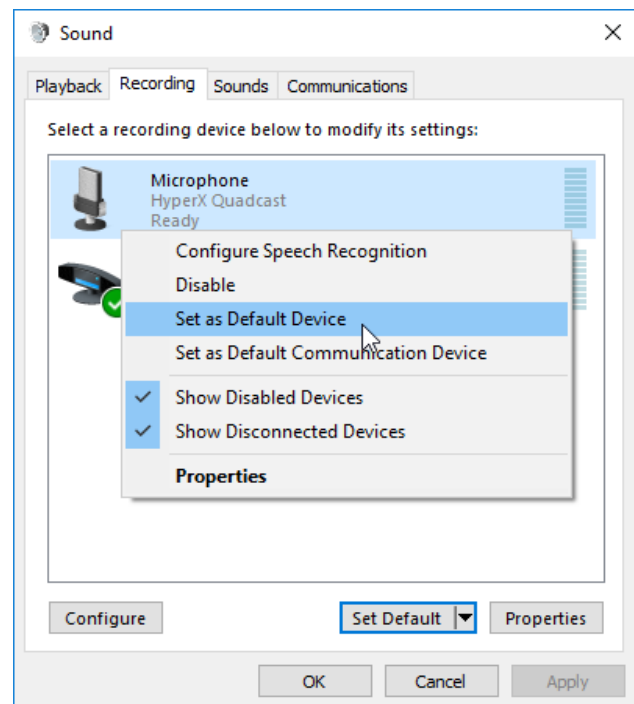



macOS

Gehe für das optimale Konfigurieren des Mikrofons unter macOS wie folgt vor:

1. Öffne **Systemeinstellungen** und wähle **Ton**.

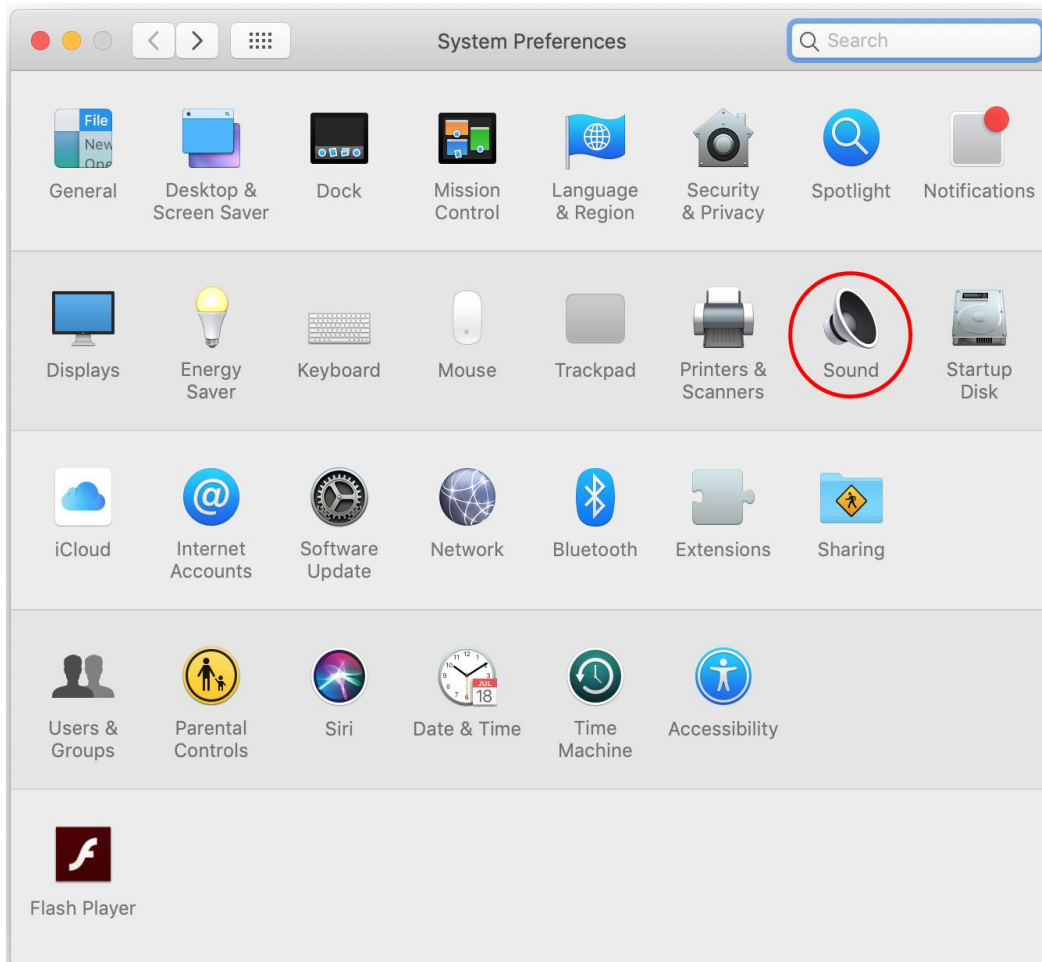



2. Wähle auf der Registerkarte *Ausgabe* **HyperX QuadCast**.

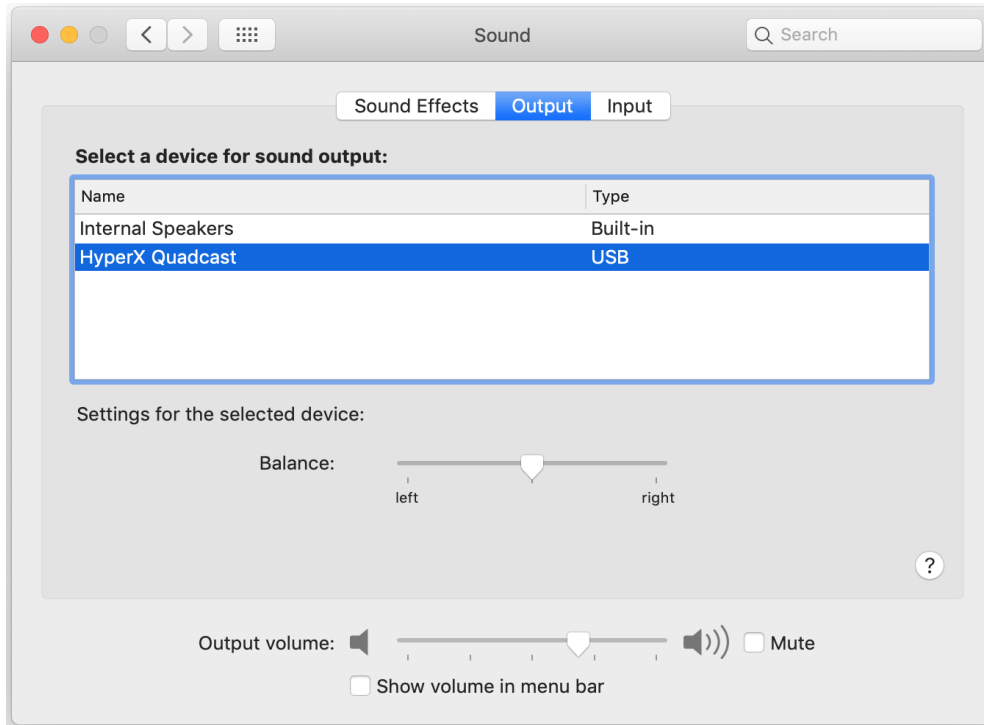

3. Wähle auf der Registerkarte *Eingabe* **HyperX QuadCast**.

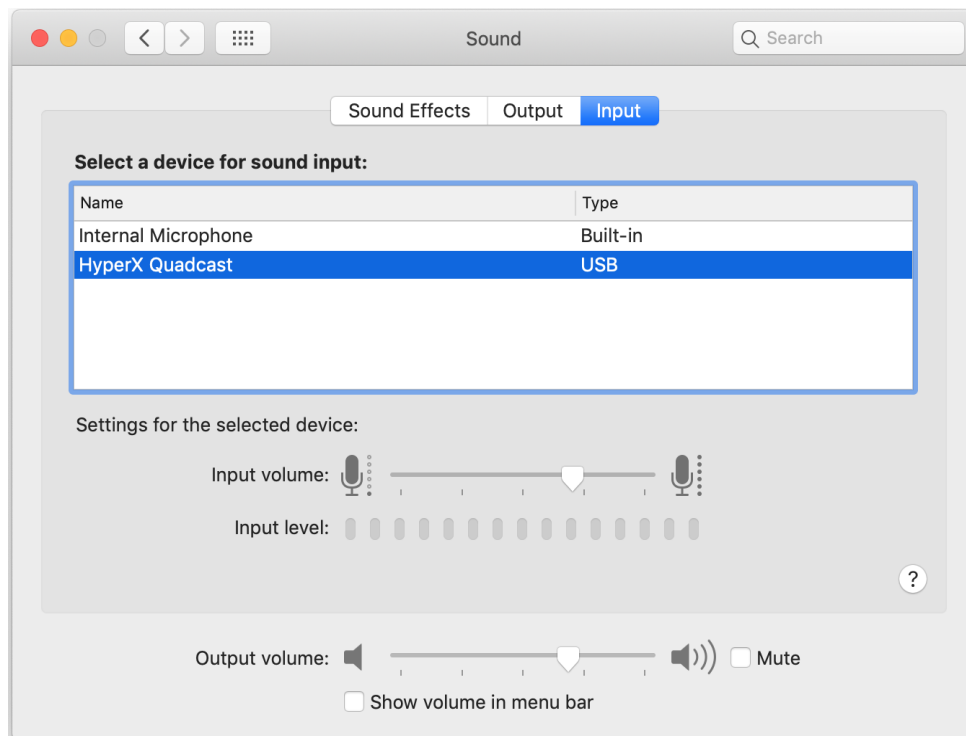



Nutzung mit PS4[™]

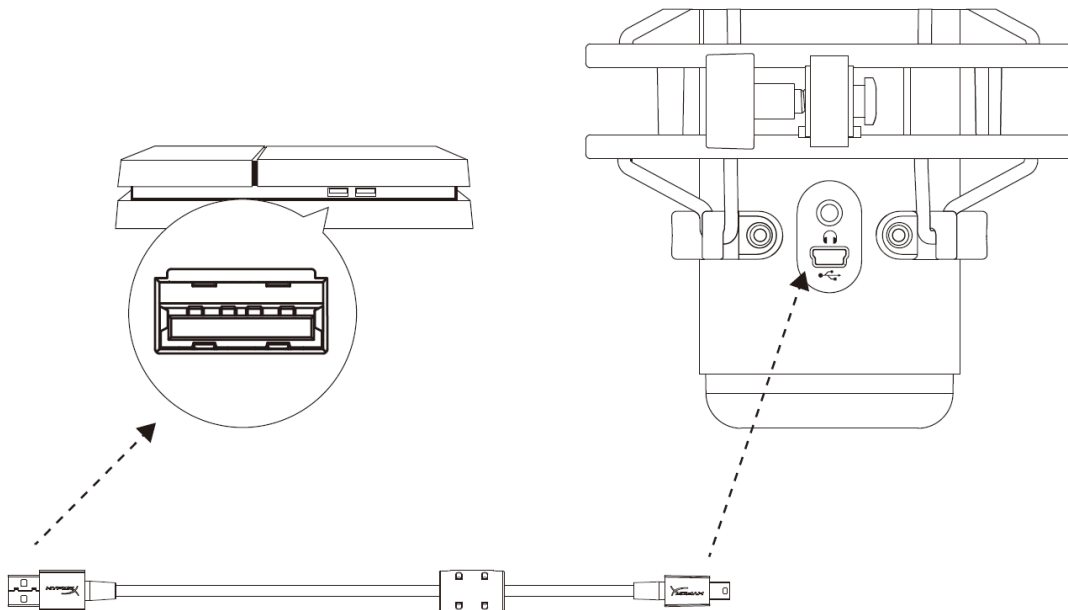

Das Mikrofon wird über das im Lieferumfang enthaltene USB-Kabel an einem USB-Anschluss mit der PS4 verbunden.

Gehe für das Konfigurieren des Mikrofons mit den optimalen Einstellungen auf der PS4 wie folgt vor:

1. Gehe im PS4-Hauptmenü auf **Settings (Einstellungen) > Devices (Geräte) > Audio Devices (Audio-Geräte)**
2. Wähle für *Input Device (Eingabegerät)* **USB Headset (HyperX QuadCast)**
3. Wähle für *Output Device (Ausgabegerät)* **USB Headset (HyperX QuadCast)**
4. Stelle *Output to Headphones (Kopfhörerausgabe)* auf **All Audio (Alles Audio)**
5. Stelle die *Lautstärkeinstellung (Kopfhörer)* auf die gewünschte Lautstärke

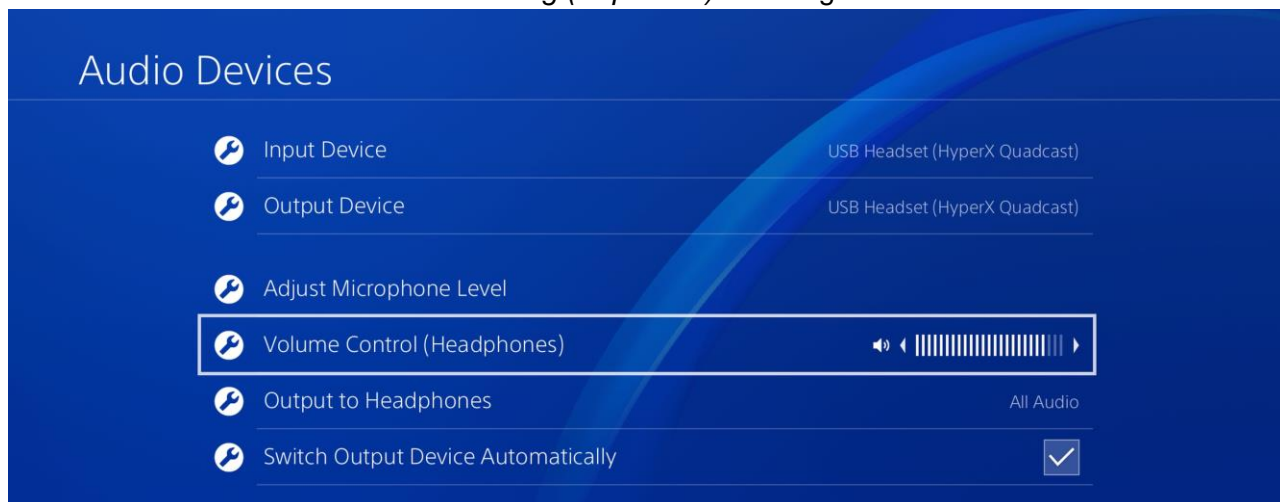



Anschließen der Kopfhörer

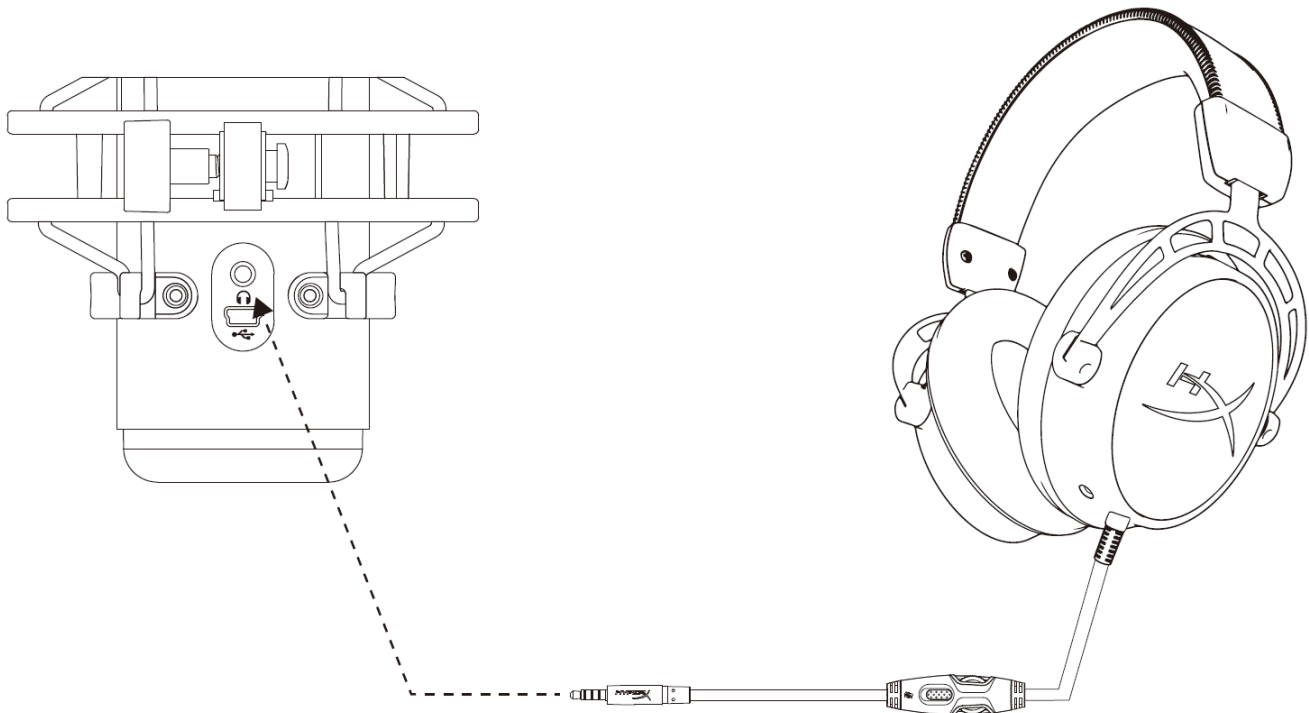

Schließe die Kopfhörer an die Kopfhörerbuchse am Mikrofon an, um das Mikrofon zu überwachen und Audio wiederzugeben.



Steuerung der Mikrofonüberwachung

PC

1. Klicke in der Audio-Systemsteuerung auf der Registerkarte *Wiedergabe* mit der rechten Maustaste auf **Speakers HyperX QuadCast** und wähle **Eigenschaften**.
2. Verschiebe auf der Registerkarte *Pegel (Levels)* den **Mikrofon-Lautstärkeregl**, um die Mikrofonüberwachung einzustellen.

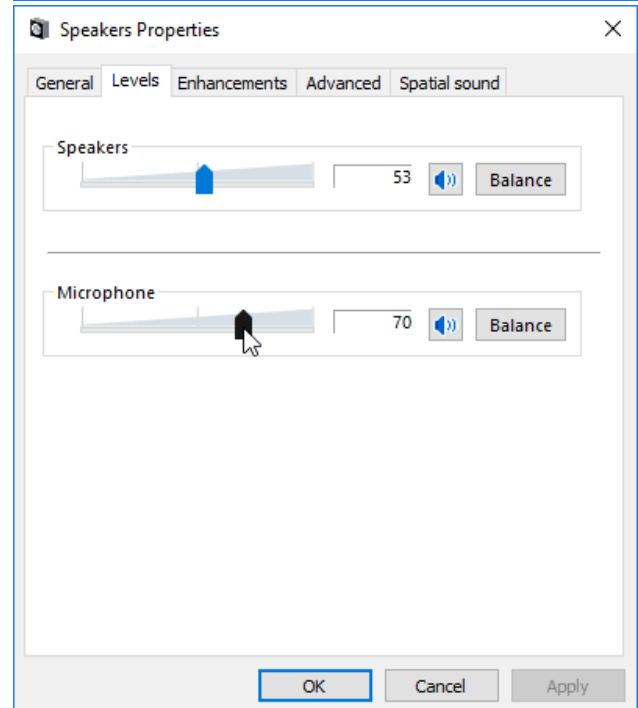
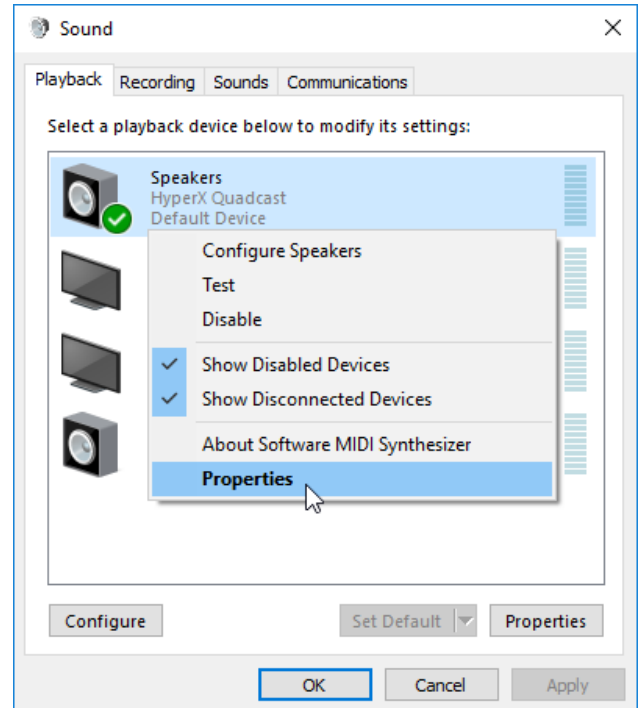



macOS

1. Öffne die **Finder**-App und gehe zu **Anwendungen > Dienstprogramme > Audio MIDI Setup**

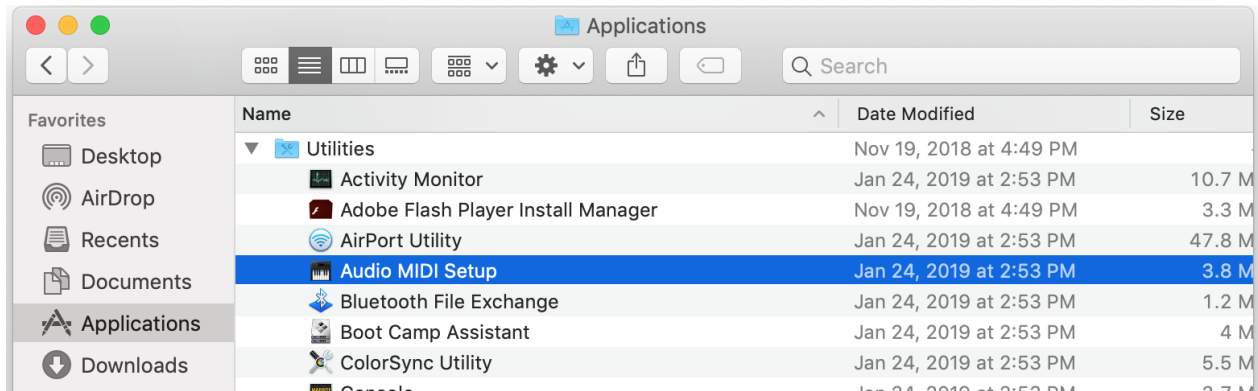

2. Klicke auf **HyperX QuadCast 2** und danach auf das Kontrollkästchen unter der Spalte *Thru*, um die Mikrofonüberwachung ein- bzw. auszuschalten.

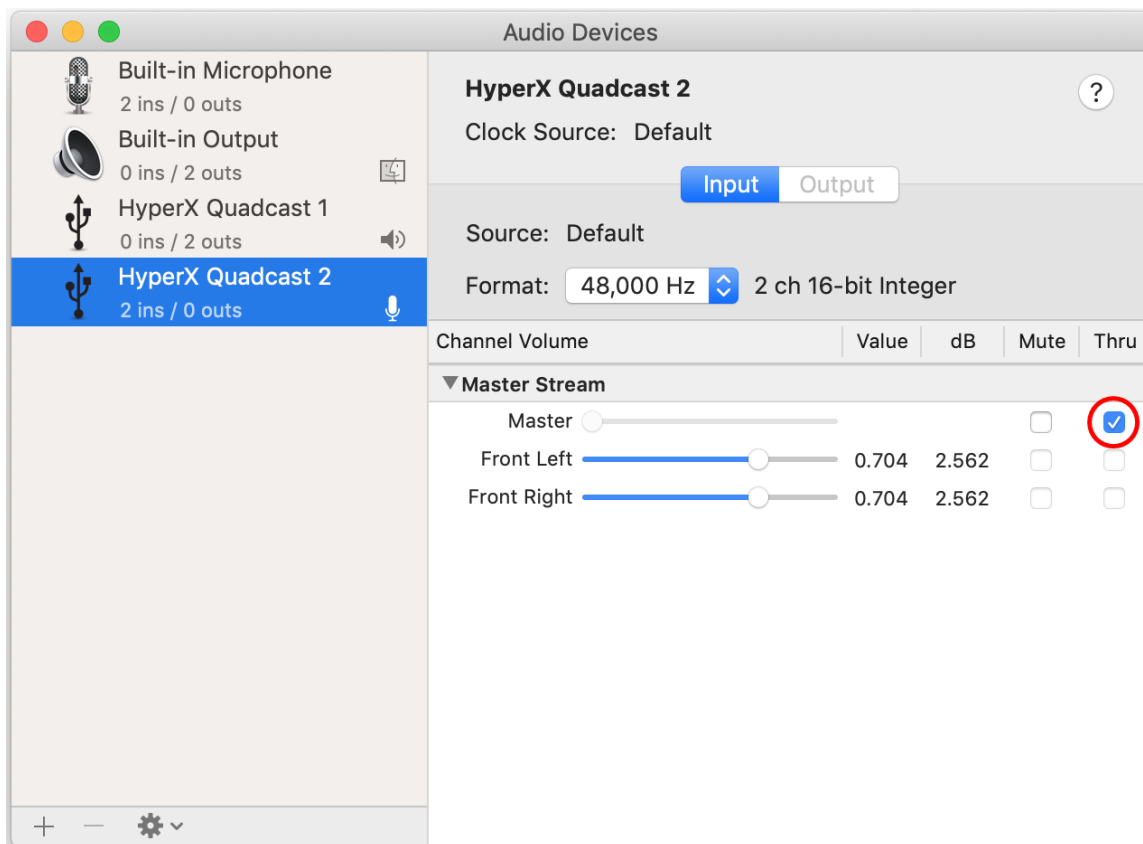

PS4

Die Mikrofonüberwachung kann nicht direkt über die PS4 gesteuert werden.



Installation des Halterungsadapters

1. Befestige den im Lieferumfang enthaltenen Halterungsadapter am Mikrofongalgenarm. Der Adapter eignet sich für 3/8"- und 5/8"-Gewindegrößen.
2. Entferne die Flügelschraube und -mutter vom Mikrofonhalter.
3. Nimm das Mikrofon aus dem Mikrofonhalter.
4. Setze den Adapter in die Mikrofonmontagebohrungen ein und befestige den Adapter mit der Flügelschraube und -mutter.



Fragen oder Probleme bei der Einrichtung?

Wende dich an das HyperX Support-Team unter: hyperxgaming.com/support/



HyperX QuadCast[™]



Références produits

HX-MICQC-BK

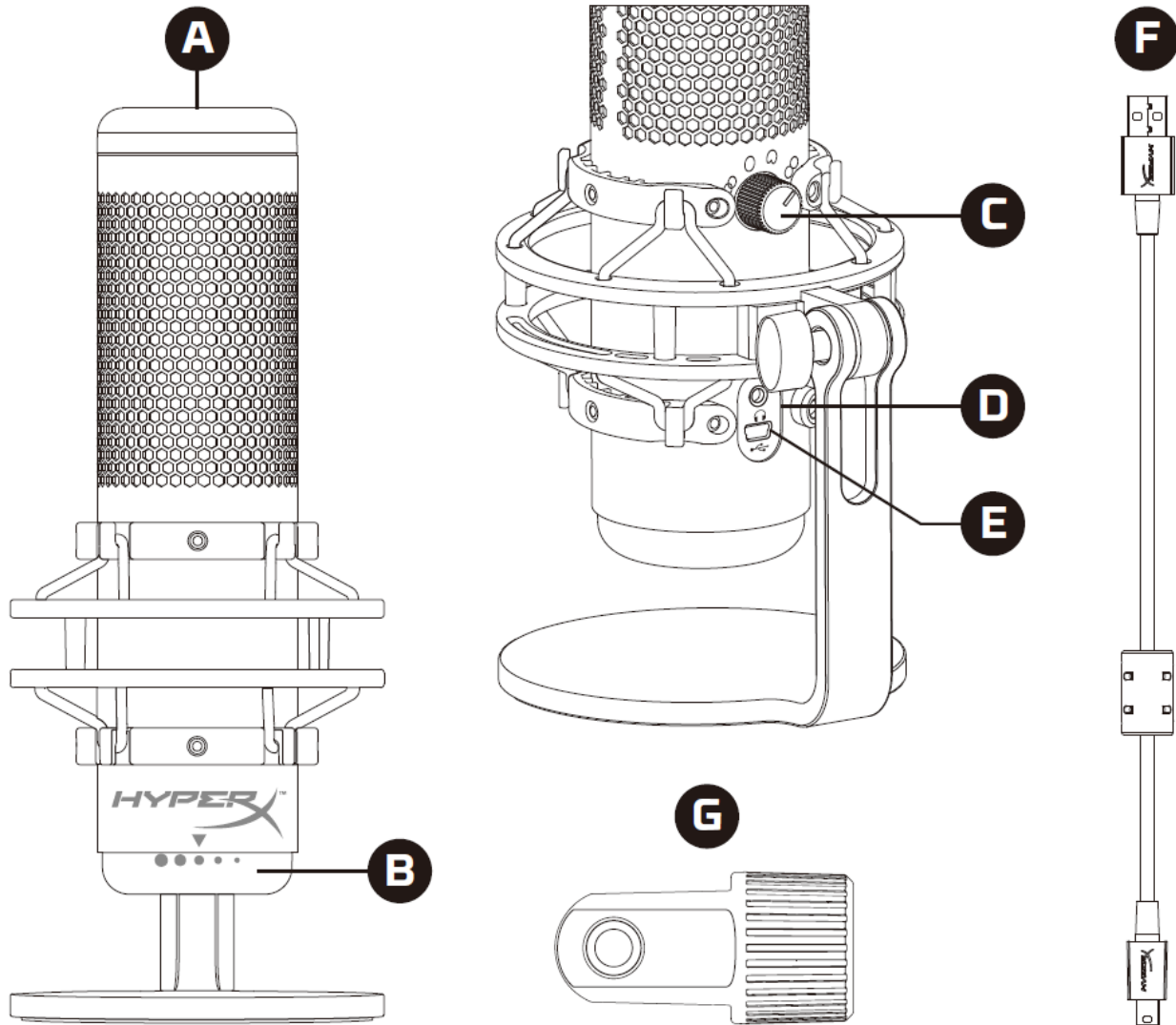

TABLE DES MATIÈRES

Présentation	3
Spécifications	4
Commandes du microphone	5
Utilisation avec un PC ou un Mac	7
Utilisation avec une PS4™	11
Connexion du casque	12
Réglage du contrôle du micro	13
Installation de l'adaptateur de pied.....	15



Présentation



- A. Capteur Coupure par pression
- B. Bouton du contrôle de gain
- C. Bouton de diagramme polaire
- D. Jack du casque
- E. Port de câble USB
- F. Câble USB
- G. Adaptateur de pied*

*Compatible avec les filetages de 3/8 et 5/8 de pouce



Spécifications

Microphone

Consommation d'énergie : 5V 125mA

Fréquence d'échantillonnage/débit binaire : 48kHz/16bits

Élément : microphone à condensateur Electret

Type de condensateur: trois condensateurs de 14mm

Diagramme polaire : stéréo, omnidirectionnel, cardioïde, bidirectionnel

Réponse en fréquence : de 20Hz à 20kHz

Sensibilité : -36dB (1V/Pa à 1kHz)

Longueur du câble : 3m

Poids :

- Microphone : 254g
- Pied et support amortisseur : 364g
- Total avec cordon USB : 710g

Sortie casque

Impédance : 32Ω

Réponse en fréquence : de 20Hz à 20kHz

Puissance maximale : 7mW

THD : ≤ 0,05% (1kHz/0dBFS)

Rapport signal-bruit : ≥ 90dB (1kHz, RL=∞)



Commandes du microphone

Sélection d'un diagramme polaire

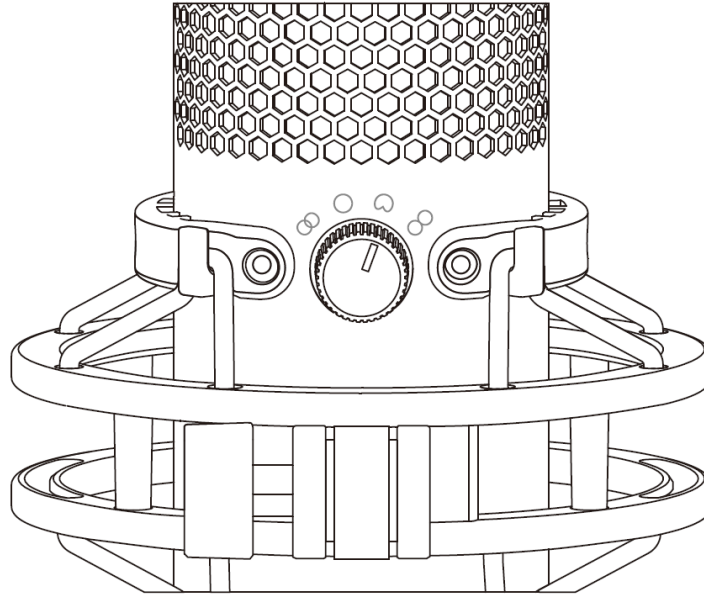

Tournez le bouton de diagramme polaire afin de choisir une des quatre options.

Symbole	Direction du son	Diagramme polaire	Scénarios
		Stéréo	Voix, instruments
		Omnidirectionnelle	Podcasts avec plusieurs intervenants, téléconférences
		Cardioïde	Podcasts, streaming, voice-over, instruments
		Bidirectionnelle	Entretiens en face à face



Réglage du contrôle de gain

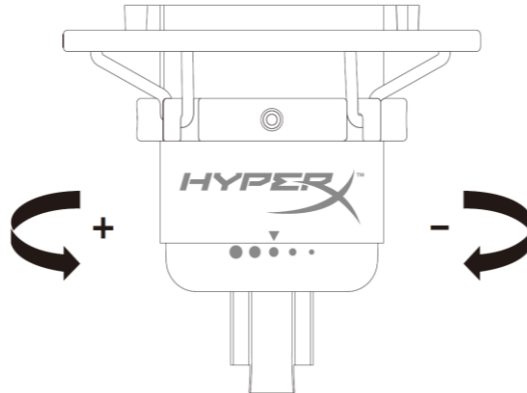

Tournez le bouton de réglage du gain pour ajuster le gain du micro.

Désactivation du micro

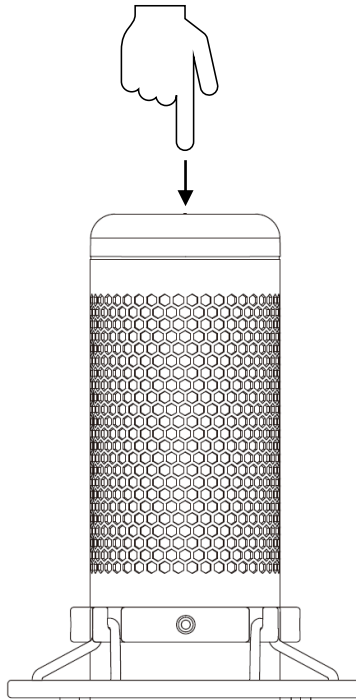

Touchez le haut du micro pour le désactiver/l'activer. Le voyant LED du microphone indique l'état de désactivation en cours du microphone.

Voyant LED du microphone	Etat de la désactivation
Rouge	Micro activé
Désactiver	Micro désactivé



Utilisation avec un PC ou un Mac

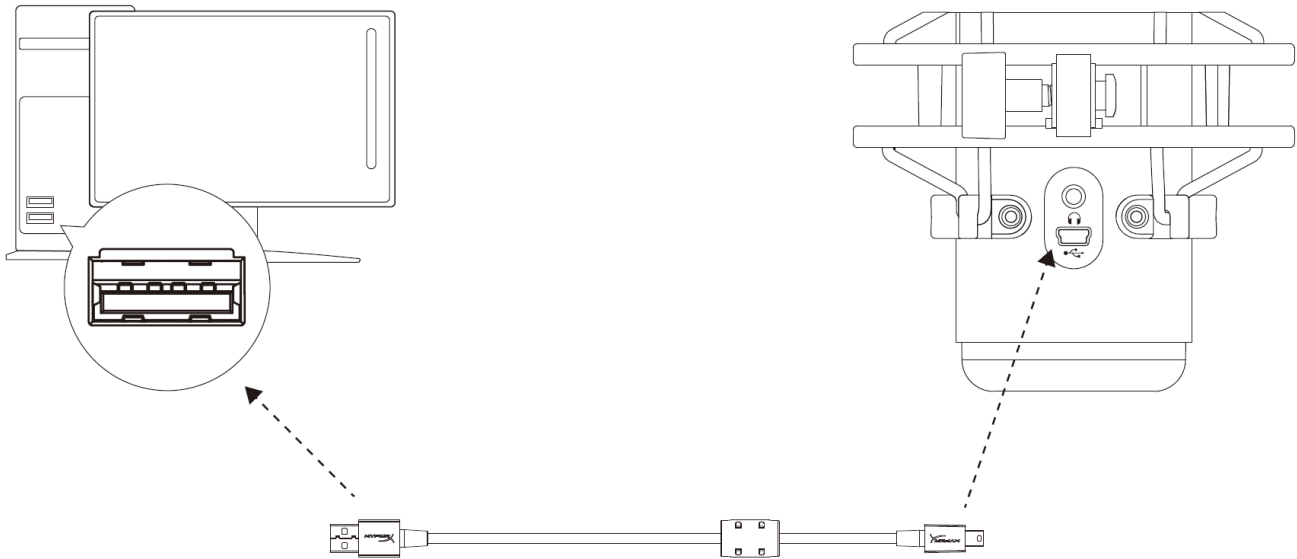

Branchez le câble USB livré avec le micro sur un des ports USB du PC ou du Mac.

Windows

Pour confirmer que le micro est configuré correctement sur le PC, suivez les étapes ci-après :

1. Cliquez-droit sur l'icône de son dans la barre d'état système, puis sélectionnez **Sons**.

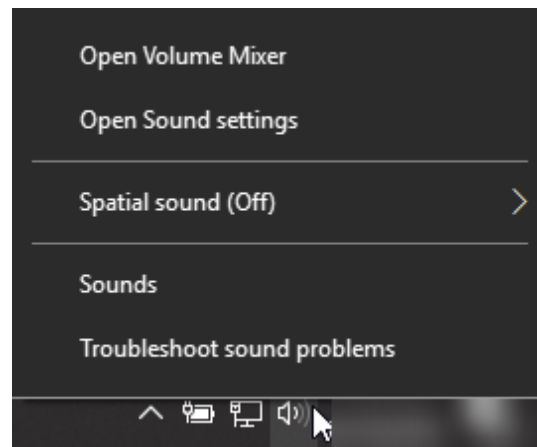



2. Sous l'onglet *Lecture*, sélectionnez **Haut-parleurs HyperX QuadCast**, puis cliquez sur le bouton **Définir par défaut**.

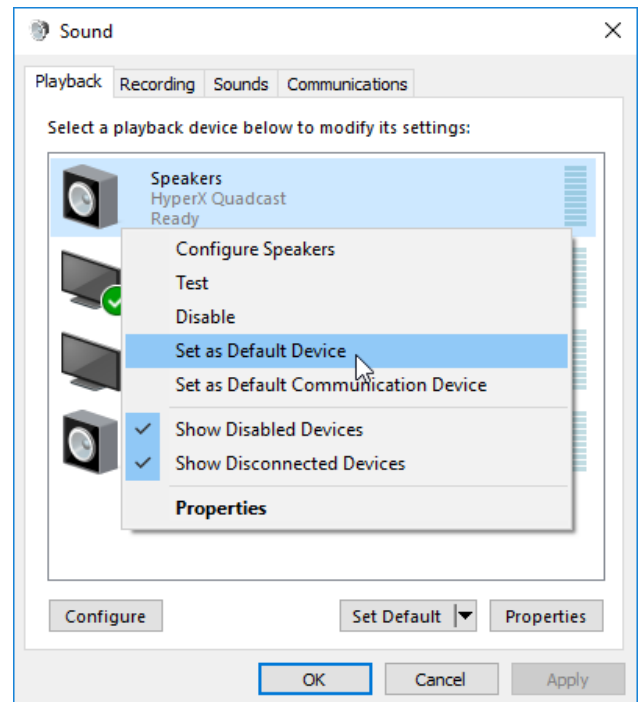

3. Sous l'onglet *Enregistrement*, sélectionnez **Micro du casque HyperX QuadCast**, puis cliquez sur le bouton **Définir par défaut**.

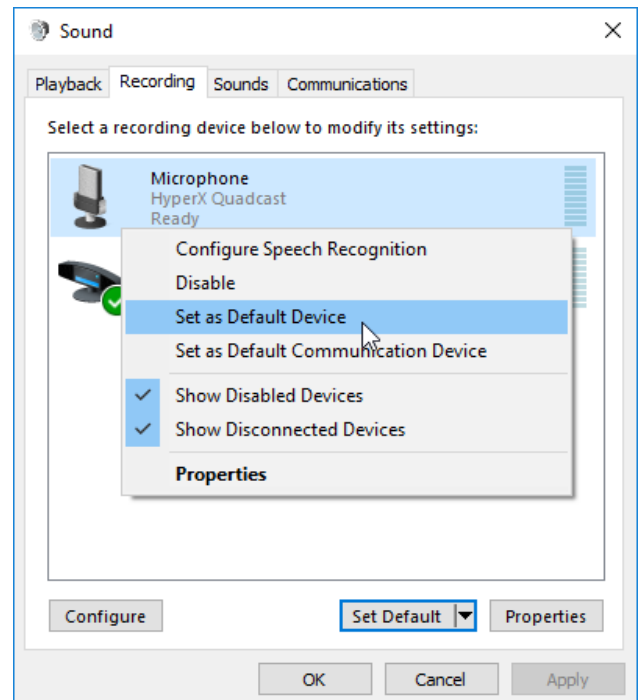



macOS

Pour confirmer que le micro est configuré correctement sur Mac, suivez les étapes ci-après :

1. Ouvrez les **Préférences Système** et choisissez **Son**.

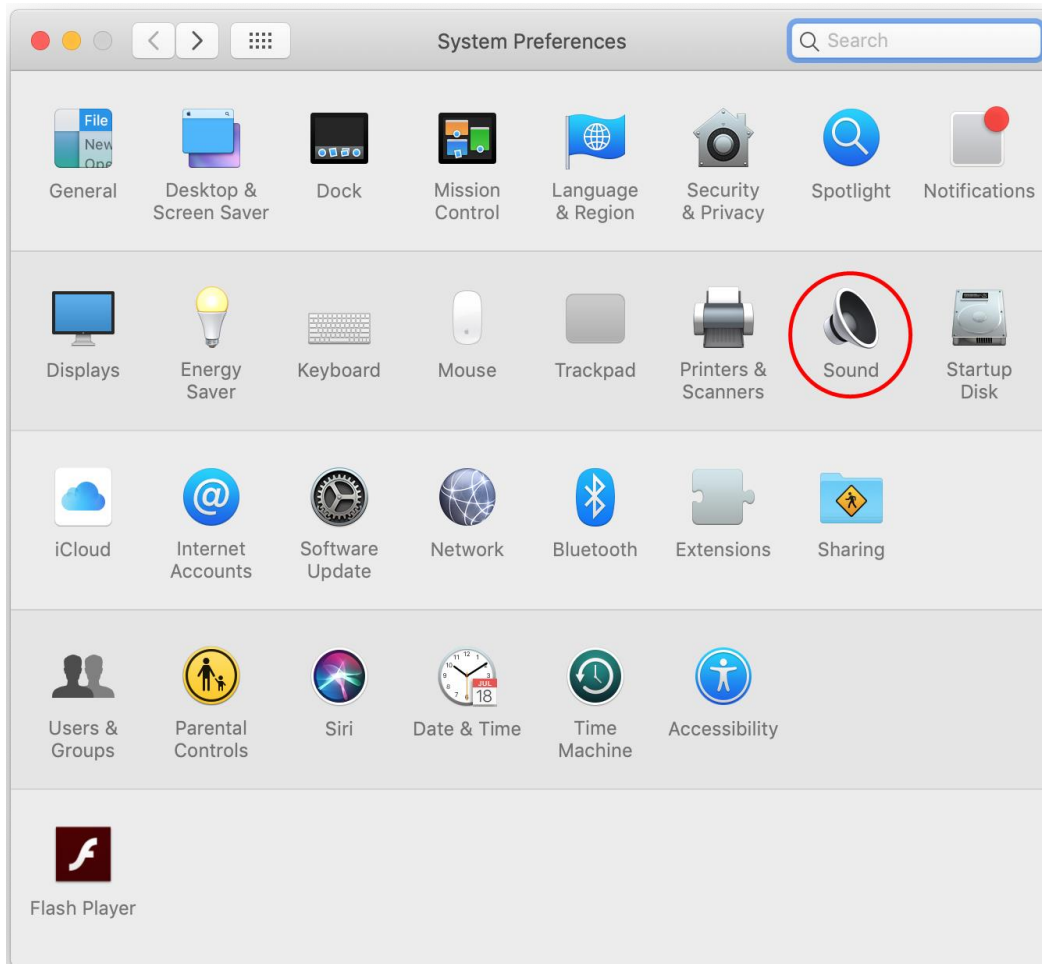



2. Sous l'onglet *Sortie*, sélectionnez **HyperX QuadCast**.

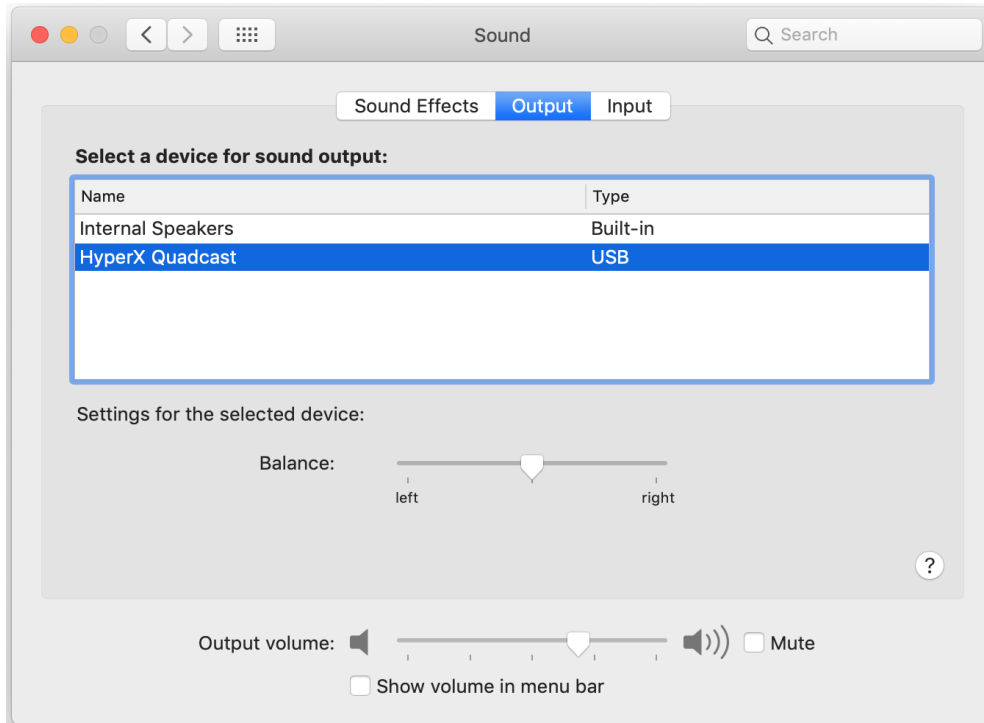

3. Sous l'onglet *Entrée*, sélectionnez **HyperX QuadCast**.

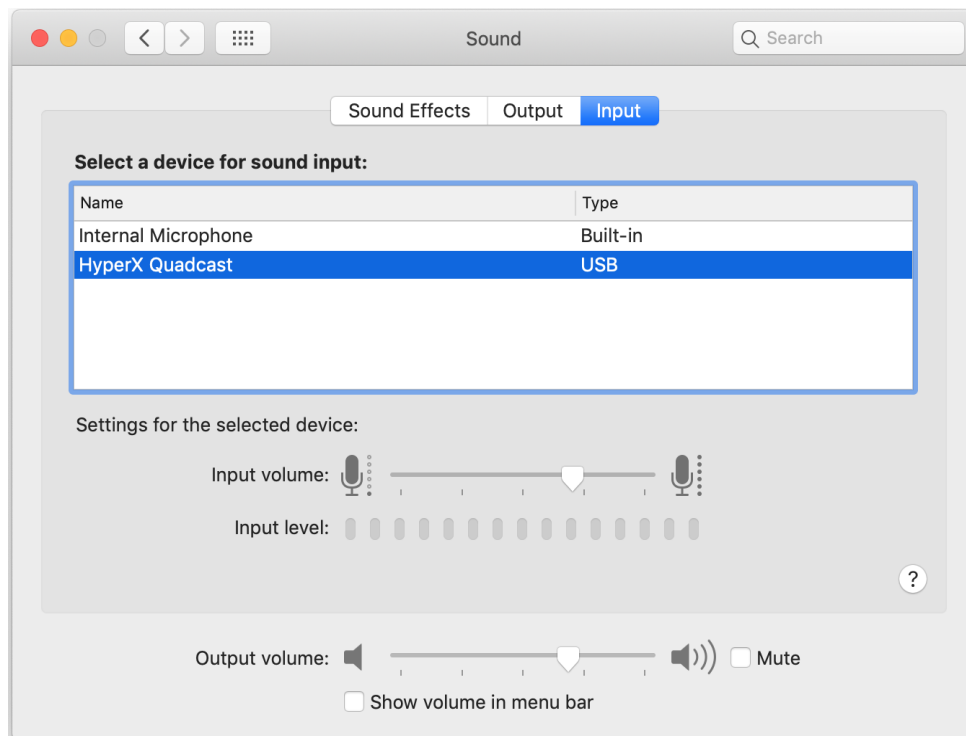



Utilisation avec une PS4™

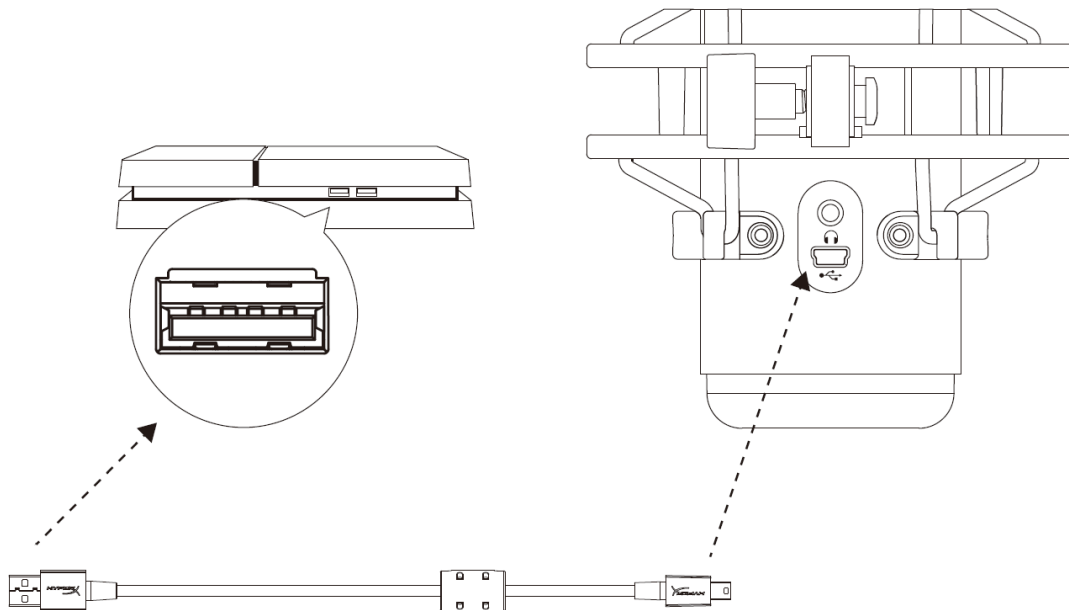

Branchez le câble USB du micro (fourni) sur un des ports USB de la PS4.

Pour confirmer que le micro est configuré selon les paramètres les mieux adaptés pour PS4, suivez les étapes ci-après :

1. Dans le menu principal de PS4, ouvrez **Paramètres > Périphériques > Périphériques audio**
2. Pour le *Périphérique d'entrée*, sélectionnez **Casque USB (HyperX QuadCast)**
3. Pour le *Périphérique de sortie*, sélectionnez **Casque USB (HyperX QuadCast)**
4. Pour *Sortie vers le casque*, sélectionnez **Tout audio**
5. *Réglez le volume (casque)* sur le niveau

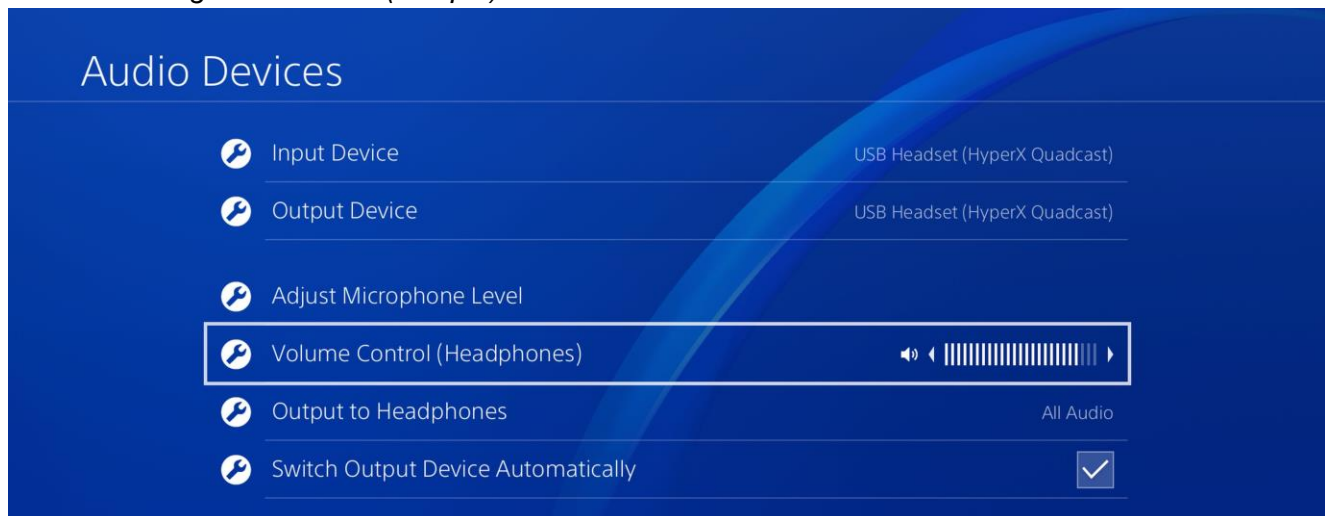



Connexion du casque

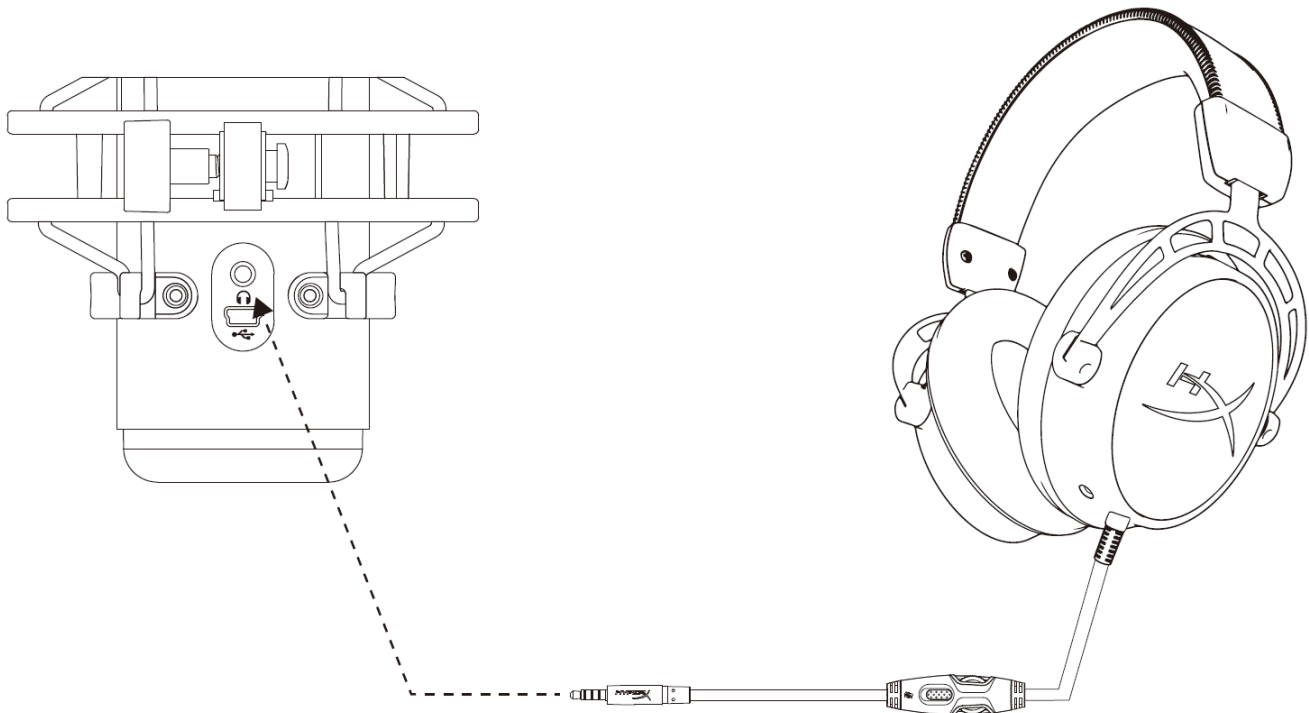

Connectez le casque sur la prise casque du micro afin de contrôler le micro et d'écouter l'audio.



Réglage du contrôle du micro

PC

1. Dans le panneau de configuration Son, sous l'onglet *Lecture*, cliquez-droit sur **Haut-parleurs HyperX QuadCast**, puis sélectionnez **Propriétés**.

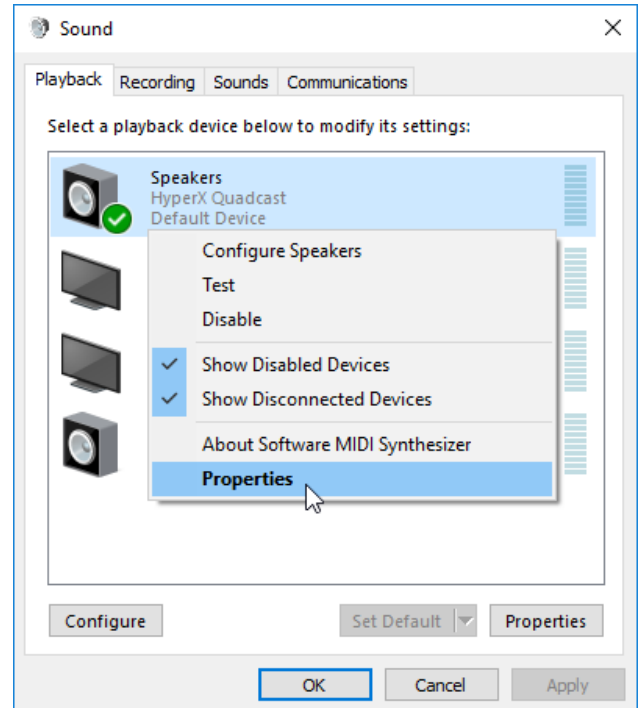

2. Sous l'onglet *Niveaux*, déplacez le curseur du volume **Microphone** pour régler le niveau de contrôle du micro.

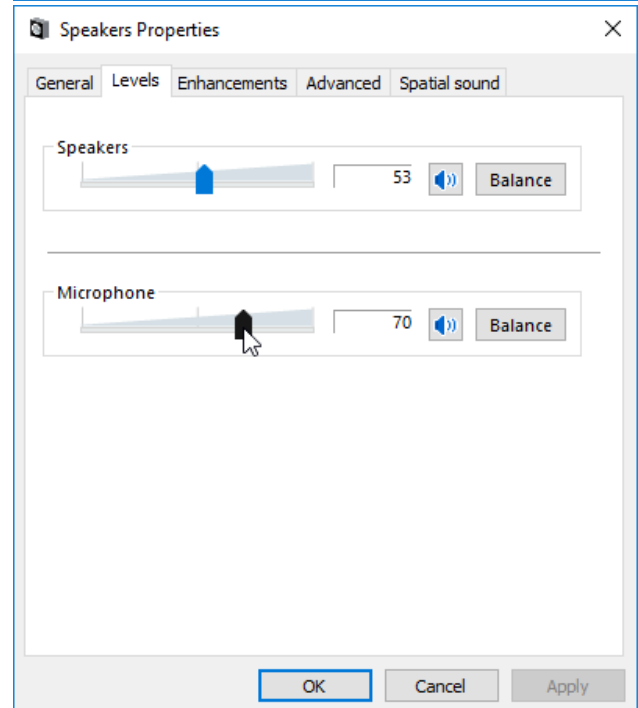



macOS

1. Ouvrez le **Finder**, puis sélectionnez **Applications > Utilitaires > Configuration audio et MIDI**

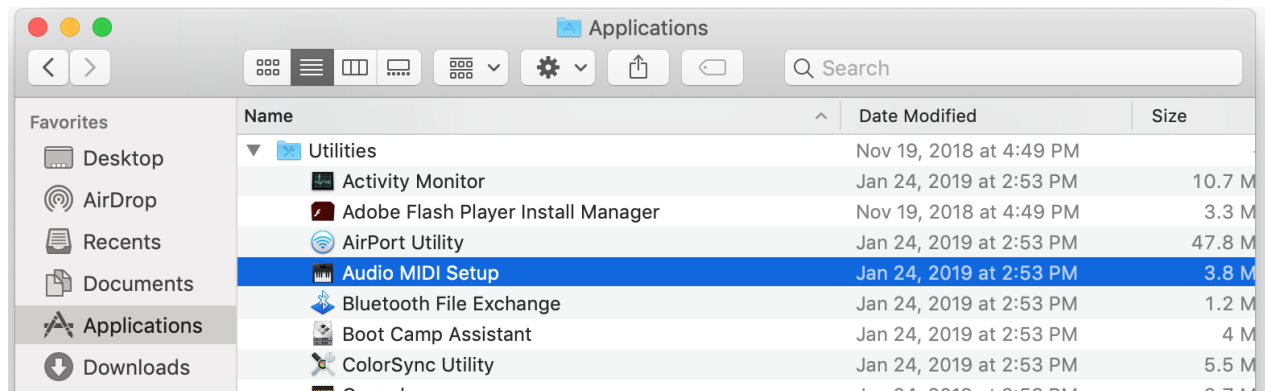

2. Cliquez sur **HyperX QuadCast 2**, puis cochez la case de la colonne *Thru* pour activer ou désactiver le contrôle du micro.

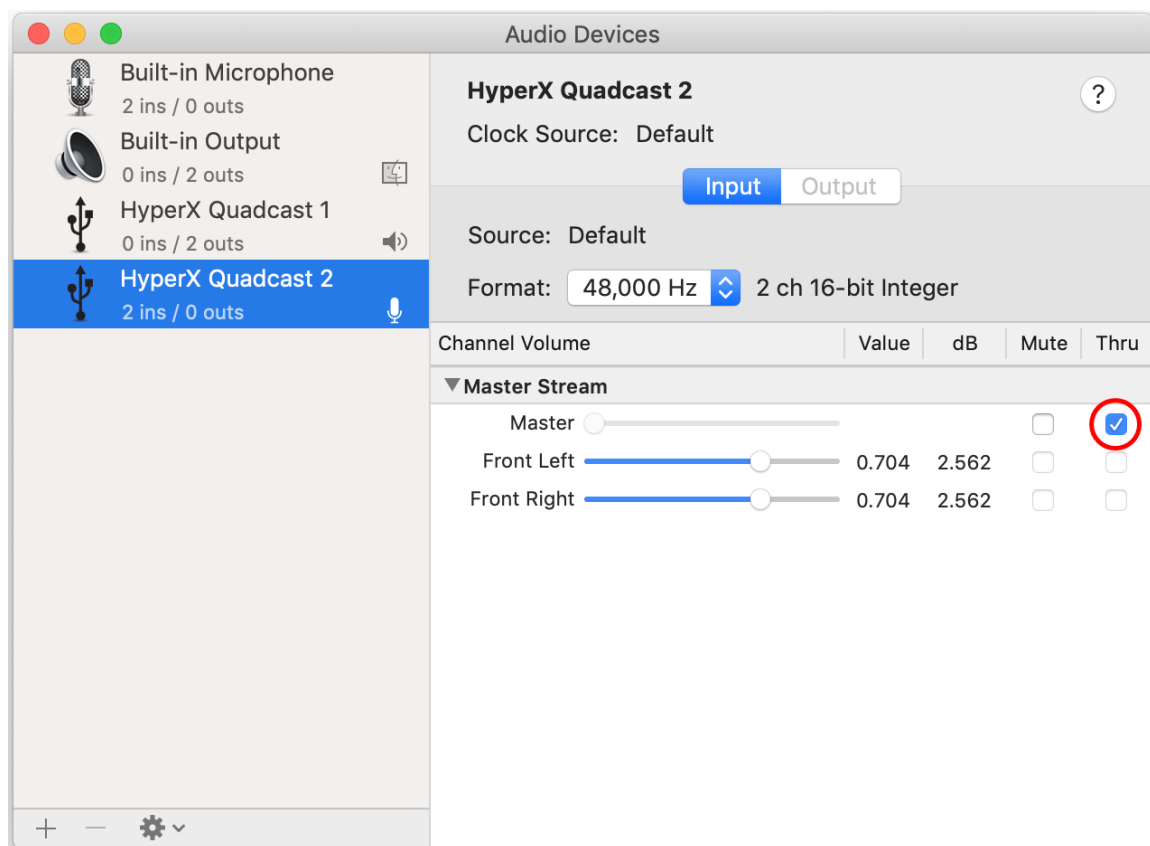

PS4

Il est impossible de régler le niveau de contrôle du micro directement sur PS4.



Installation de l'adaptateur de pied

1. Fixez l'adaptateur de pied inclus sur la tige du micro. L'adaptateur de pied est compatible avec les filetages de 3/8 et 5/8 de pouce.
2. Dévissez la vis papillon et l'écrou du pied du micro.
3. Séparez le pied et le micro.
4. Alignez l'adaptateur de pied sur les orifices de fixation du micro et fixez l'adaptateur à l'aide de la vis papillon et de l'écrou.



Questions ou problèmes de configuration ?

Contactez l'équipe d'assistance HyperX à l'adresse : hyperxgaming.com/support/



HyperX QuadCast[™]



Numeri di parte

HX-MICQC-BK



INDICE

Descrizione generale del prodotto	3
Specifiche tecniche	4
Controllo microfono	5
Utilizzo con PC o Mac.....	7
Utilizzo con la console PS4™	11
Collegamento delle cuffie	12
Controllo del monitoraggio microfono	13
Installazione dell'adattatore per attacco.....	15



Descrizione generale del prodotto

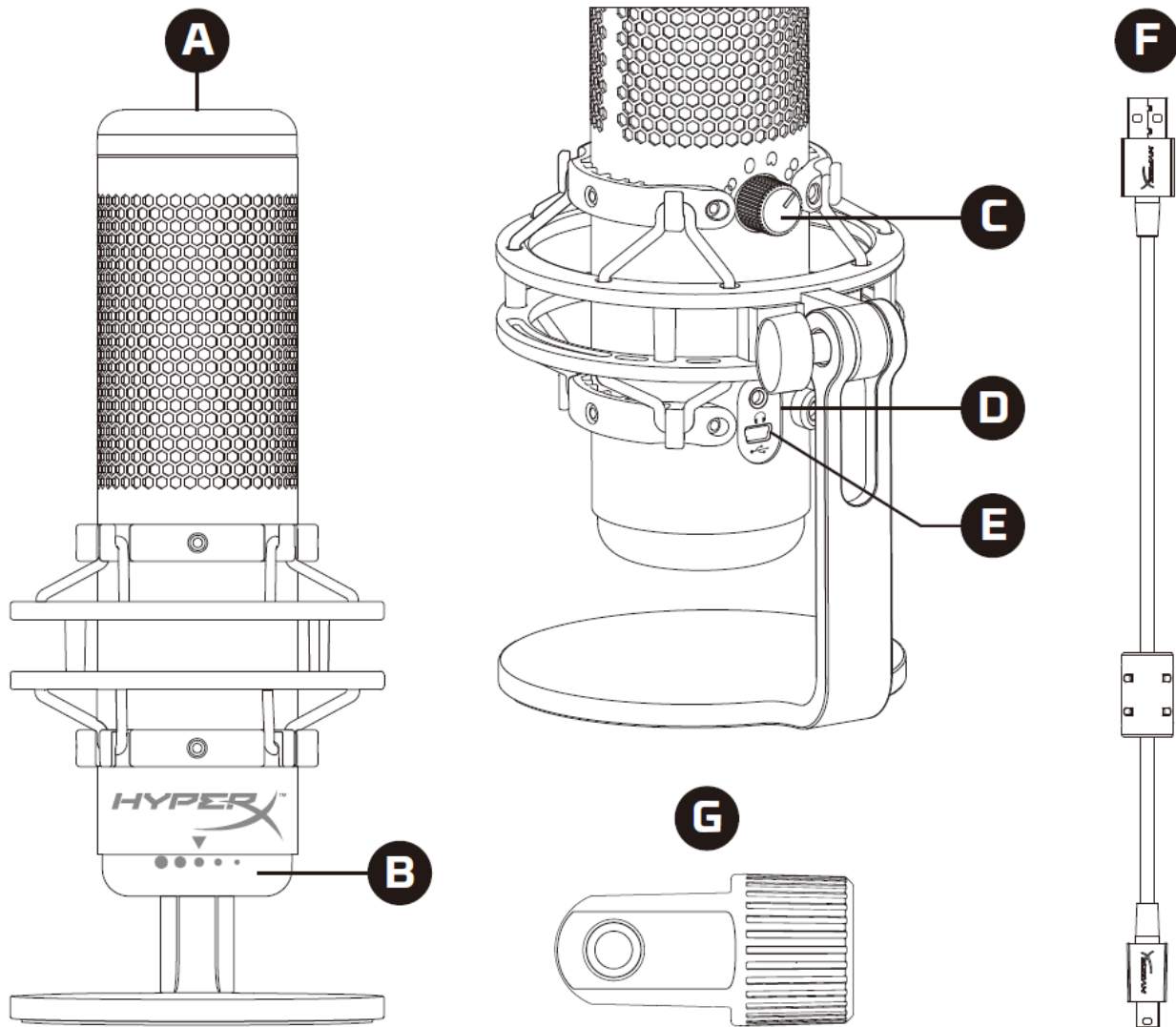

- A. Sensore “Tap-to-Mute”
- B. Manopola controllo del guadagno
- C. Manopola pattern polare
- D. Jack cuffie
- E. Porta per cavo USB
- F. Cavo USB
- G. Adattatore per attacco*

*Supporta filettature da 3/8” e 5/8”



Specifiche tecniche

Microfono

Consumo di energia: 5 V 125 mA

Frequenza di campionamento/bit: 48 kHz/16 bit

Elemento: Microfono con condensatore a elettretre

Tipo di condensatore: 3 condensatori da 14mm

Pattern polare: Stereo, omnidirezionale, cardioide, bidirezionale

Risposta in frequenza: 20Hz - 20kHz

Sensibilità: -36 dB (1V/Pa a 1kHz)

Lunghezza cavo: 3 m

Peso:

- Microfono: 254g
- Supporto antiurto: 364g
- Peso complessivo con cavo USB: 710 g

Uscita cuffie

Impedenza: 32 Ω

Risposta in frequenza: 20Hz - 20kHz

Potenza di uscita massima: 7mW

THD: $\leq 0,05\%$ (1kHz/0dBFS)

SNR: ≥ 90 dB (1 kHz, RL= ∞)







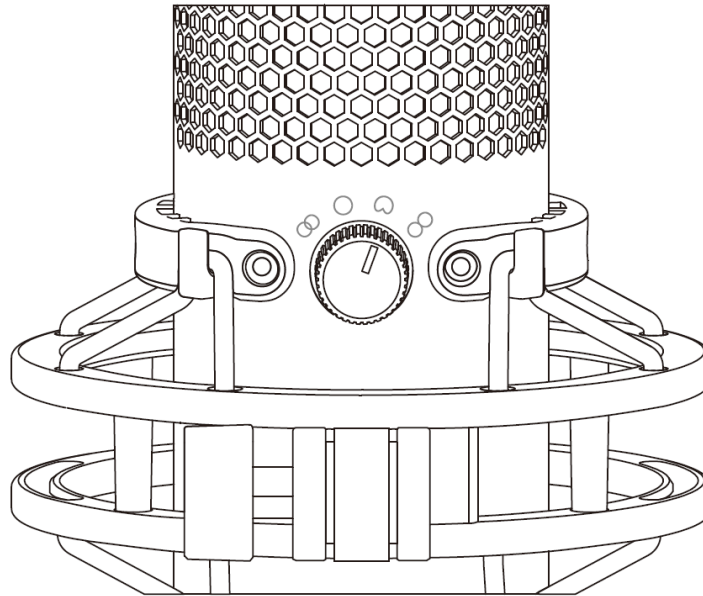

Controllo microfono

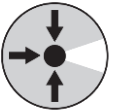
Selezione di un pattern polare

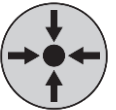

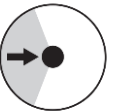
Ruotare l'apposita manopola per selezionare uno dei quattro pattern polari.

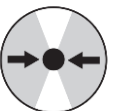
Simbolo	Direzione dell'audio	Pattern polare	Scenari
		Stereo	Voce, strumenti
		Omnidirezionale	Podcast multi-persone, conference call
		Cardioide	Podcast, streaming, doppiaggi, strumenti
		Bidirezionale	Interviste "faccia a faccia"



Controlli di regolazione guadagno

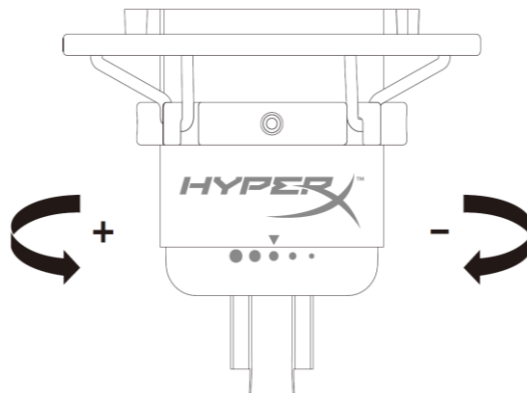

Ruotare l'apposita manopola di controllo per regolare il guadagno del microfono.

Silenziamento del microfono

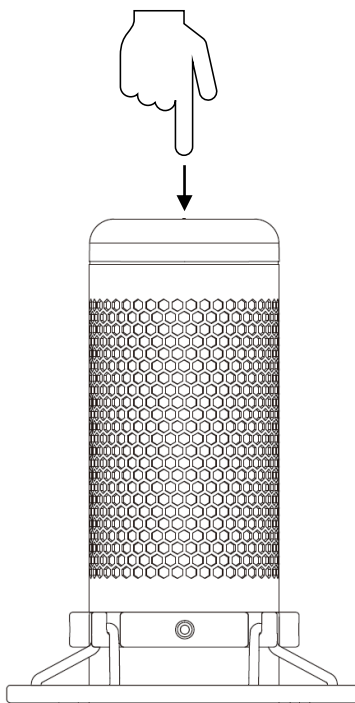

Toccare la parte superiore del microfono per silenziare o riattivare il microfono. Il LED del microfono indicherà lo stato attuale di silenziamento del microfono.

LED del microfono	Stato di esclusione
Rosso	Silenziamento disattivato
Spento	Silenziamento attivo



Utilizzo con PC o Mac

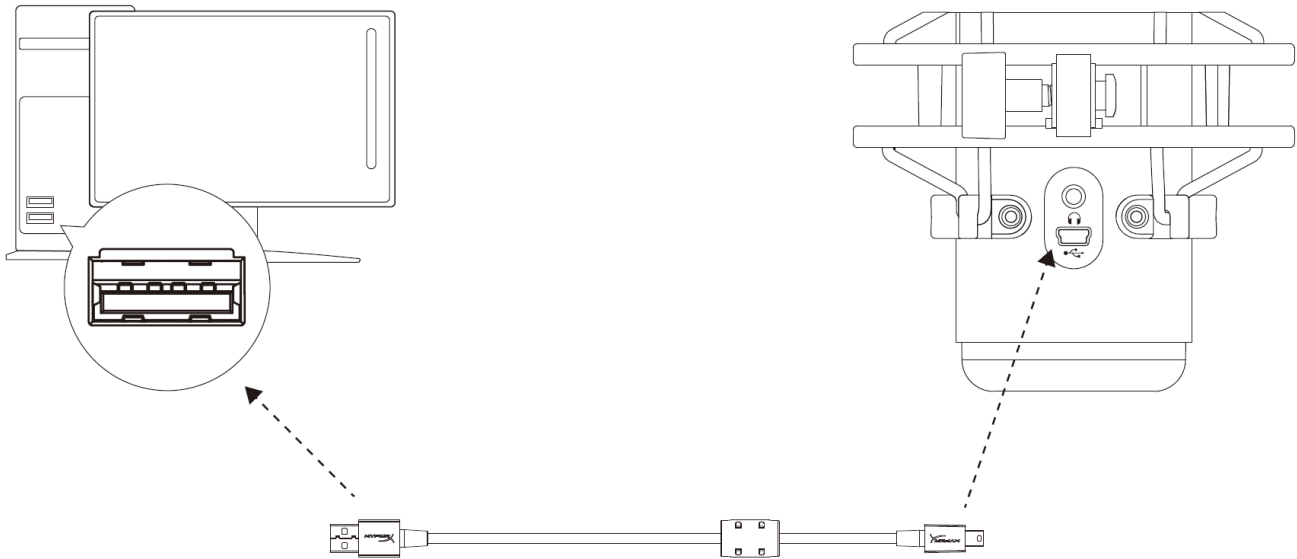

Collegare il microfono a una porta USB del PC o del Mac tramite il cavo USB incluso.

Windows

Per verificare che la connessione tra il microfono e il PC sia correttamente configurata, procedere come indicato di seguito:

1. Fare clic con il pulsante destro del mouse sull'icona dell'altoparlante che si trova nella barra di notifica e selezionare **Suoni**.

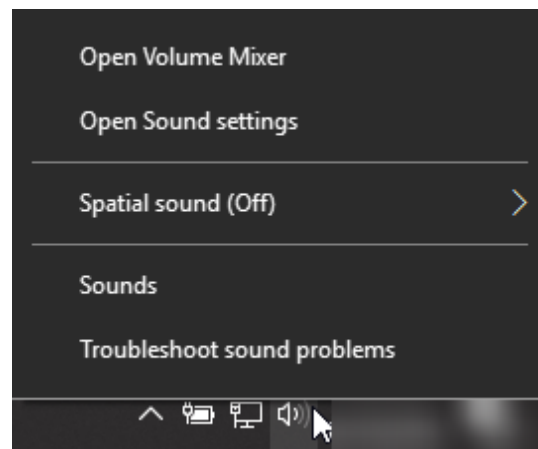



2. Nella scheda *Riproduzione*, selezionare **Speakers HyperX QuadCast** e fare clic sul pulsante **Imposta come predefinito**.

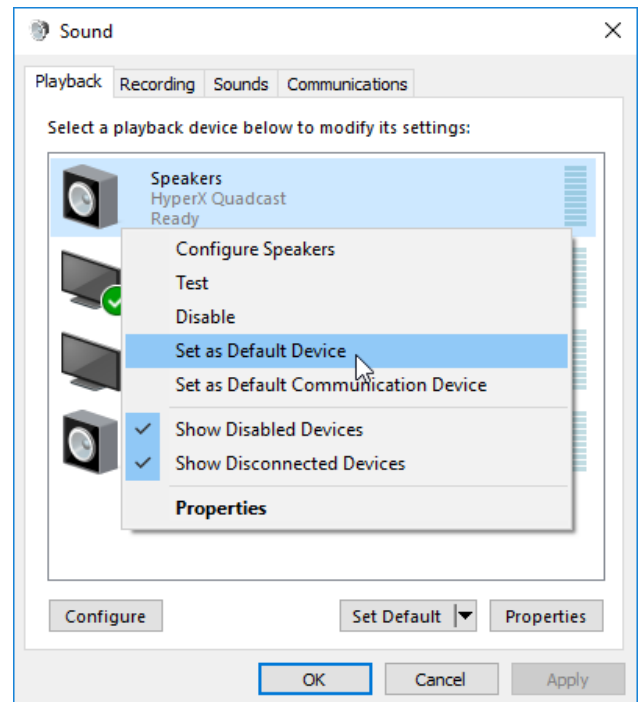

3. Nella scheda *Registrazione*, selezionare **Microphone HyperX QuadCast** e fare clic sul pulsante **Imposta come predefinito**.

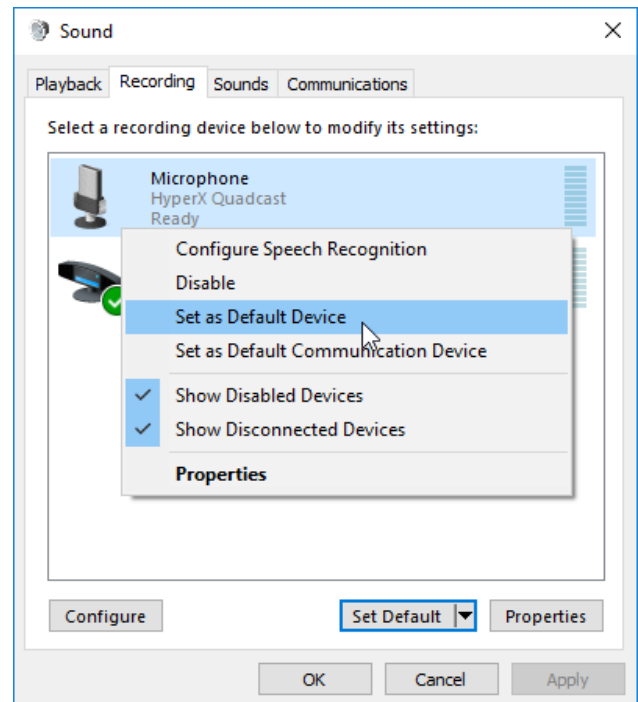



macOS

Per verificare che la connessione tra il microfono e il macOS sia correttamente configurata, procedere come indicato di seguito:

1. Aprire “**Preferenze di sistema** e selezionare **Suoni**.”

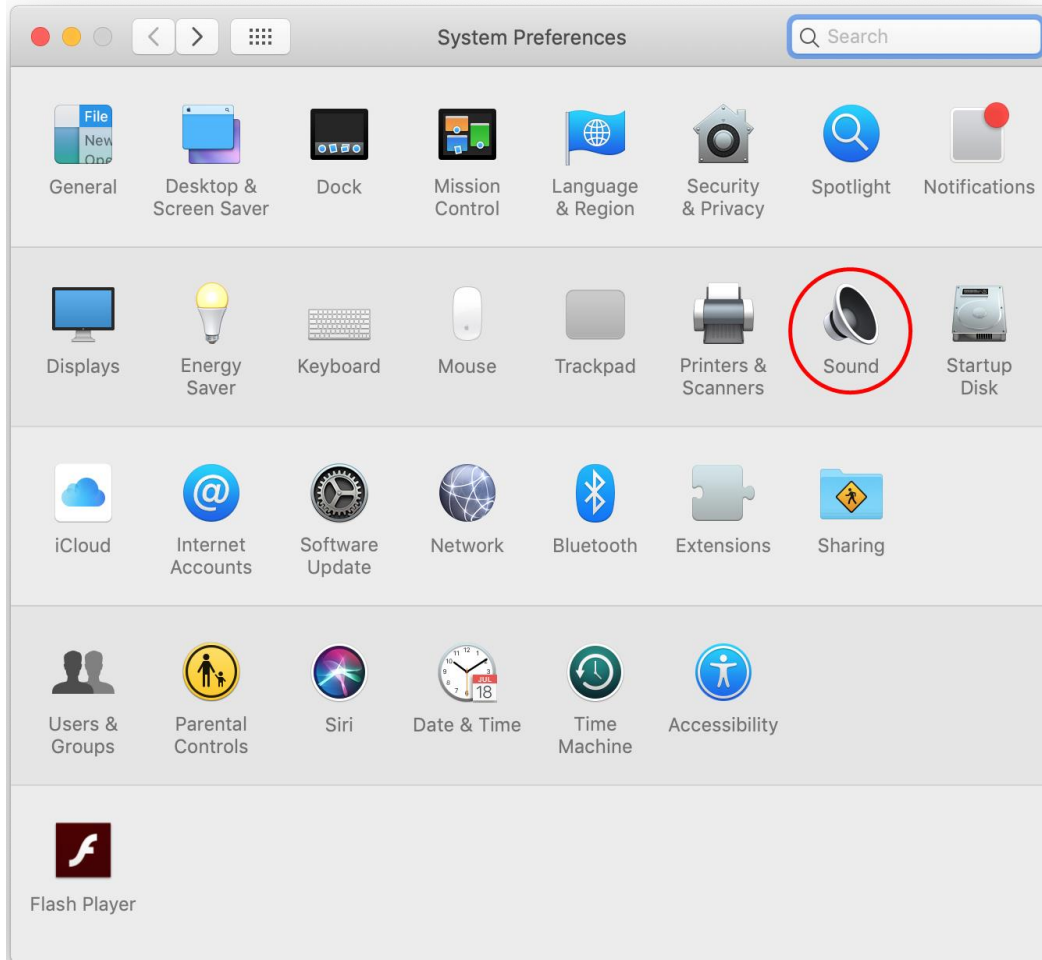



2. Nella scheda *Uscita*, selezionare **HyperX QuadCast**.

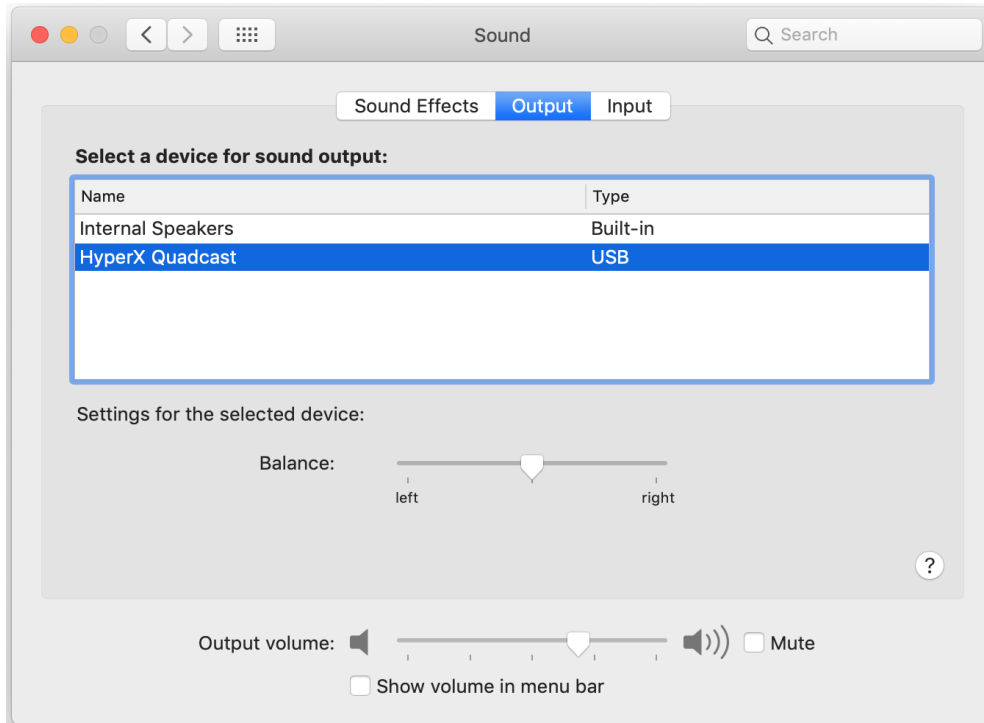

3. Nella scheda *Ingresso*, selezionare **HyperX QuadCast**.

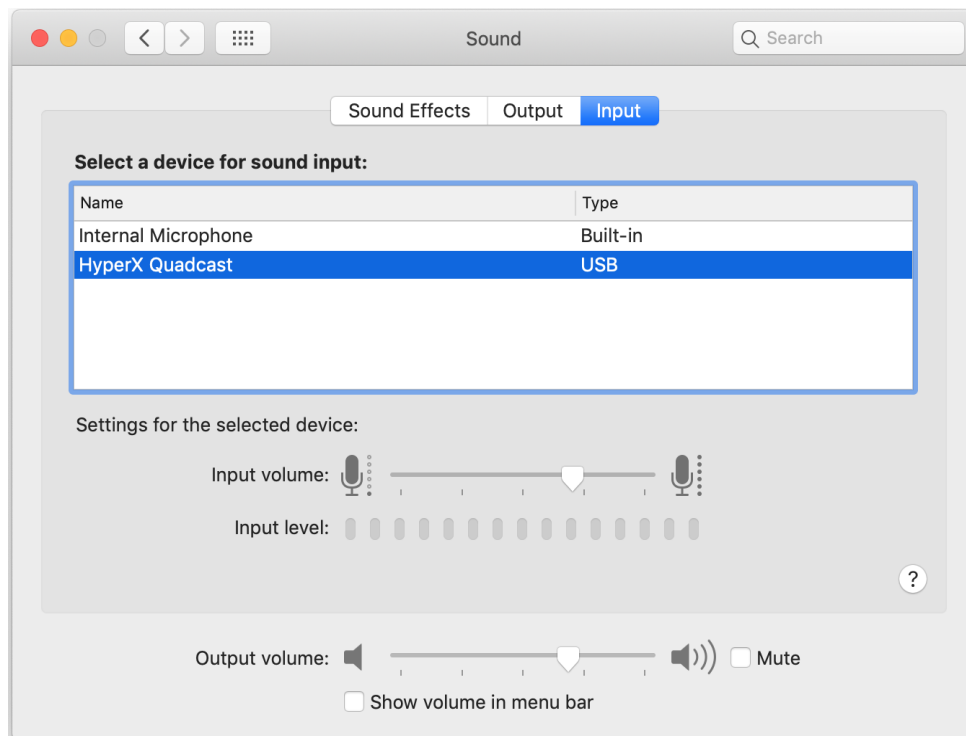



Utilizzo con la console PS4™

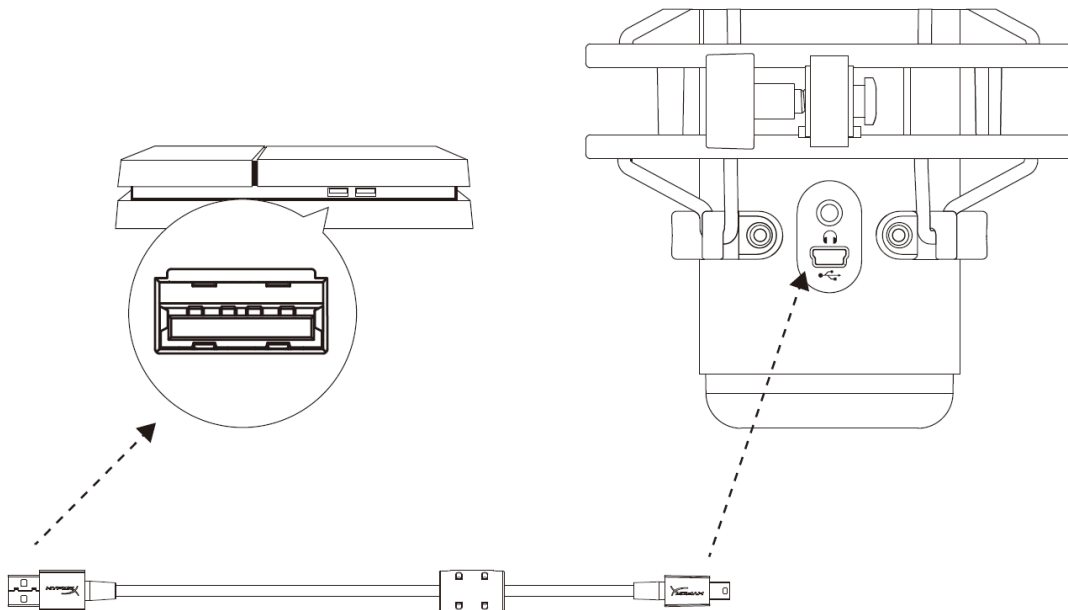

Collegare il microfono a una porta USB della console PS4 tramite il cavo USB incluso.

Per verificare che la connessione tra il microfono e la console PS4 sia avvenuta con la configurazione ottimale, procedere come indicato di seguito:

1. Dal menu principale della console PS4, selezionare **Impostazioni > Dispositivi > Dispositivi audio**
2. Impostare l'opzione *Dispositivo di ingresso* su **Cuffie USB (HyperX QuadCast)**
3. Impostare l'opzione *Dispositivo di uscita* su **Cuffie USB (HyperX QuadCast)**
4. Impostare l'opzione *Riproduci l'audio tramite cuffie* su **Tutto l'audio**
5. Impostare l'opzione *Controllo volume (Cuffie)* al volume preferito

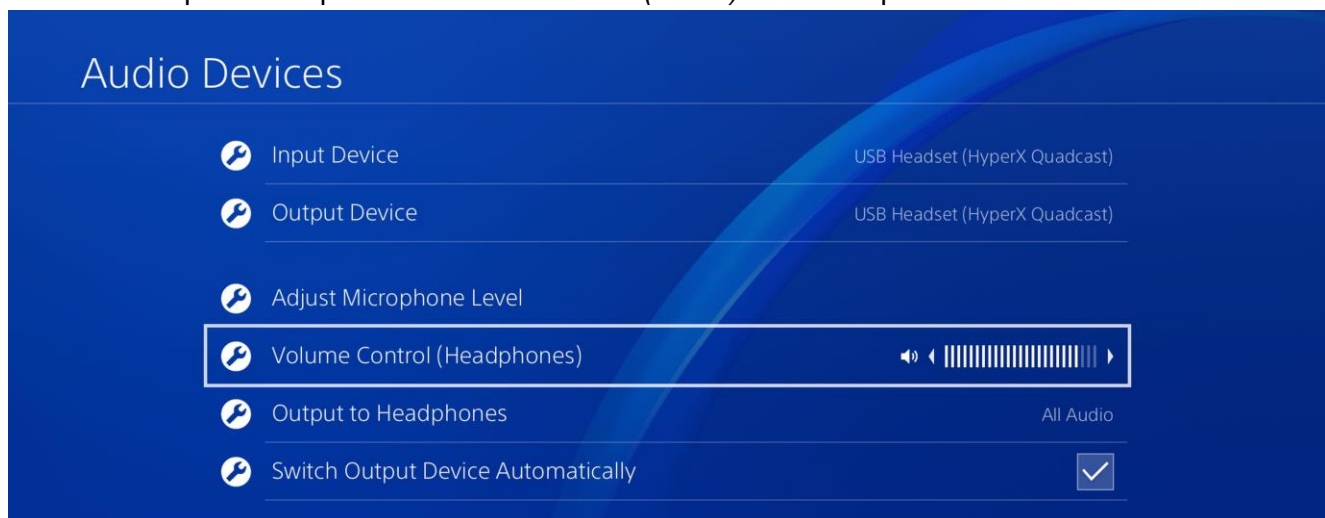



Collegamento delle cuffie

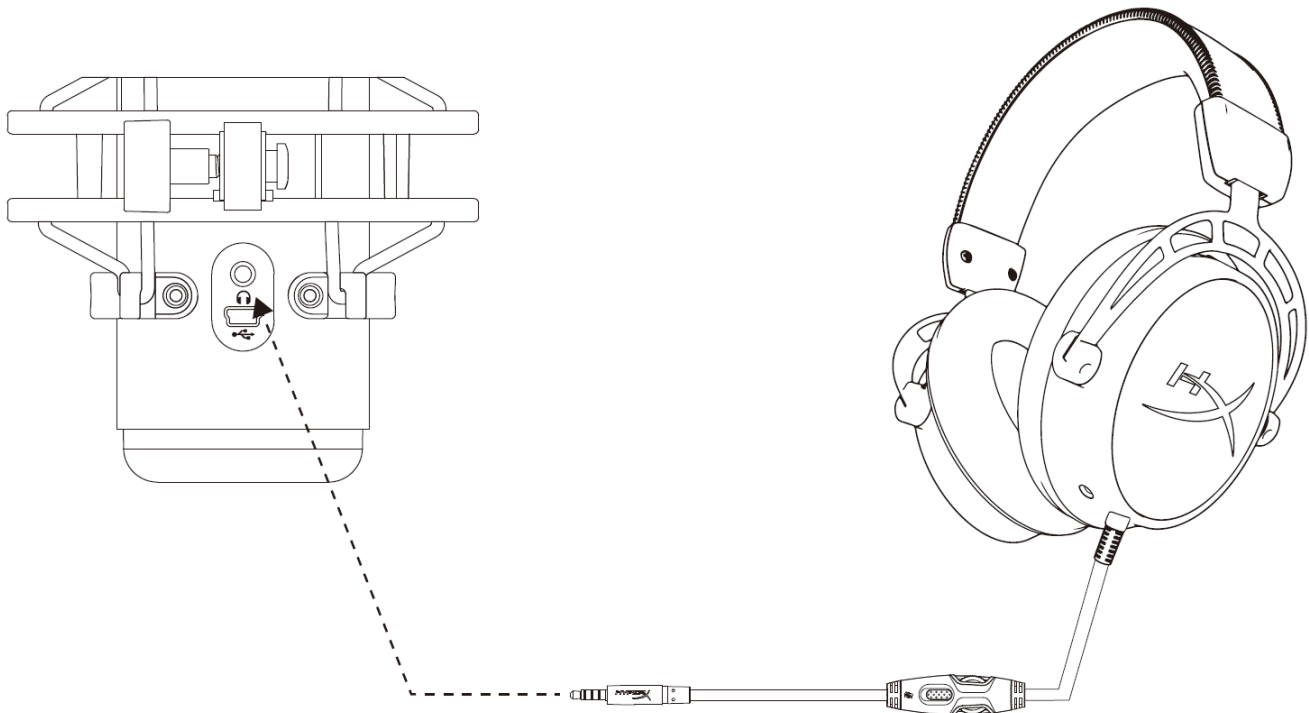

Collegare le cuffie all'ingresso per cuffie presente sul microfono, per monitorare il microfono e ascoltare l'audio.



Controllo del monitoraggio microfono

PC

1. Aprire il pannello di controllo Suoni e, nella scheda *Riproduzione*, fare clic con il pulsante destro su **Speakers HyperX QuadCast** quindi selezionare **Proprietà**.

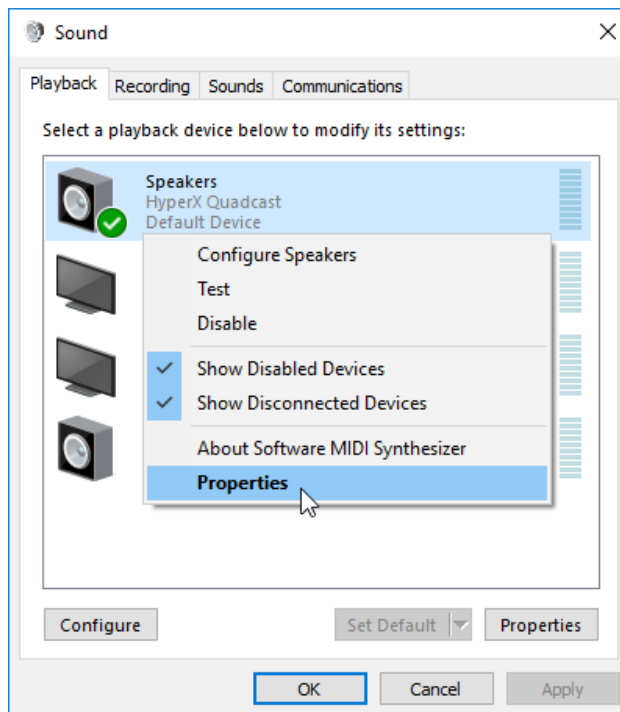

2. Nella scheda *Livelli*, regolare il cursore del volume del **Microfono** in modo da personalizzare il livello di ascolto del microfono.

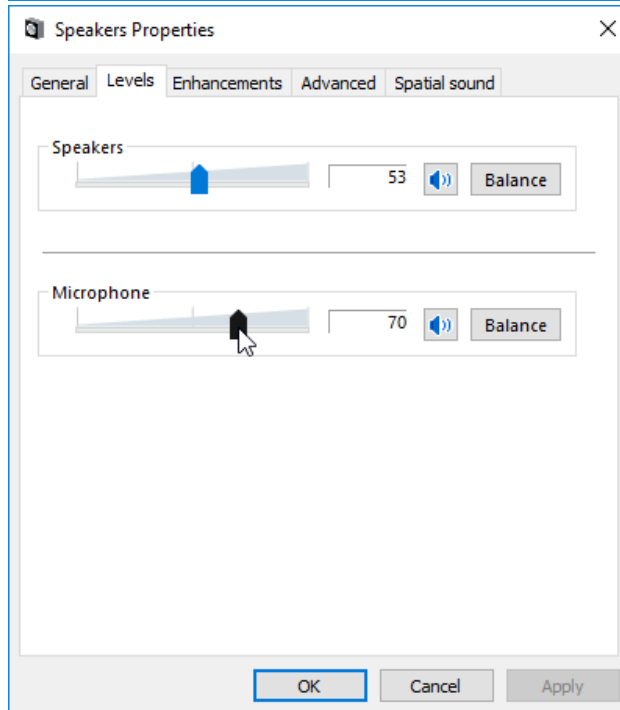



macOS

1. Aprire il **Finder** e passare a **Applicazioni > Utility > Configurazione Audio MIDI**

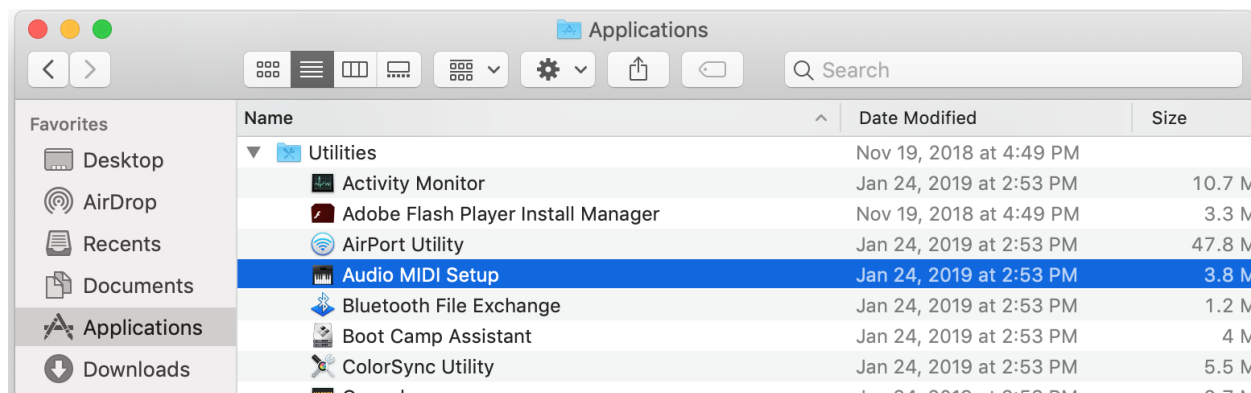

2. Fare clic su **HyperX QuadCast 2** e poi selezionare la casella di controllo alla base della colonna *Thru* per attivare o disattivare il monitoraggio del microfono.

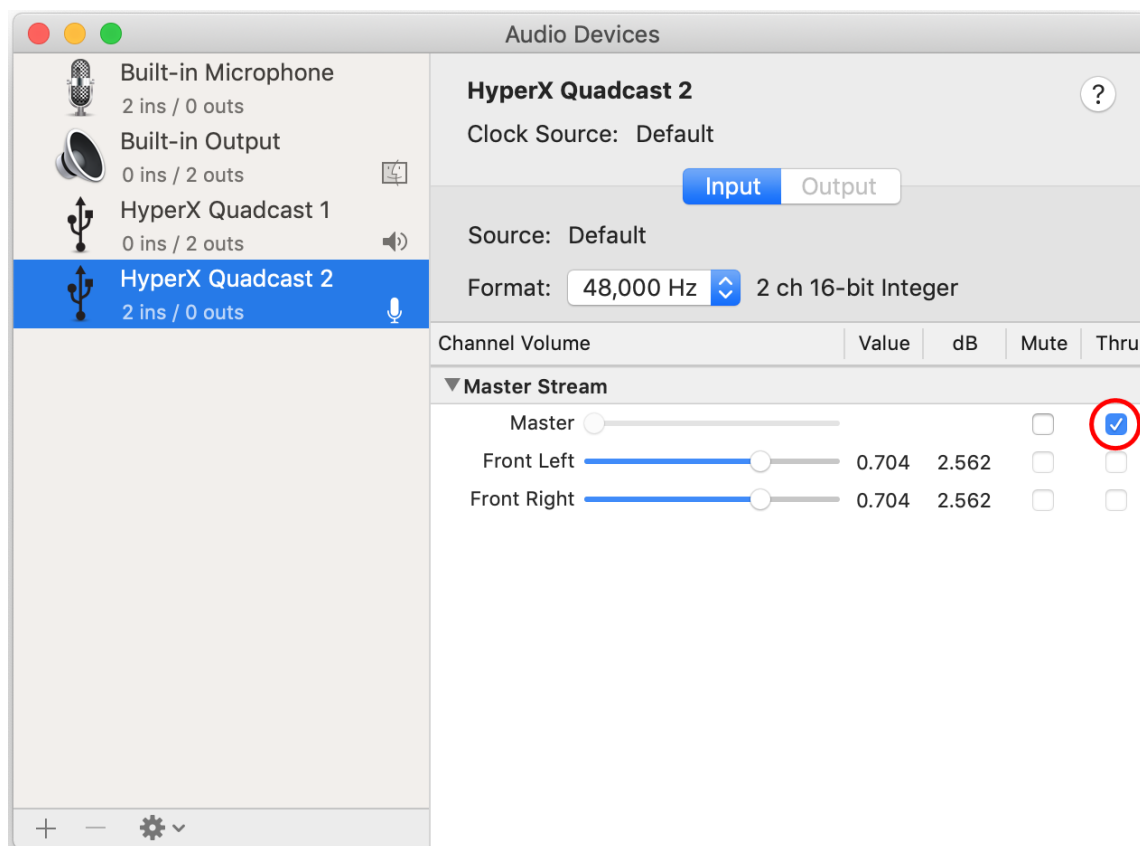

PS4

La console PS4 non consente di controllare direttamente il livello di monitoraggio del microfono.



Installazione dell'adattatore per attacco

1. Fissare l'adattatore per attacco fornito in dotazione a un braccio di sostegno per microfono.
L'adattatore per attacco supporta filettature da 3/8" e 5/8".
2. Rimuovere la vite e il dado dal supporto del microfono.
3. Rimuovere il supporto dal microfono.
4. Allineare l'adattatore per attacco con i fori del supporto per microfono e fissare l'adattatore usando la vite e il dado.



Domande o dubbi sulla configurazione?

Contattare il team di supporto HyperX all'indirizzo: hyperxgaming.com/support/



HyperX QuadCast[™]



Código do Produto

HX-MICQC-BK



ÍNDICE

Visão geral	3
Especificações.....	4
Controles do Microfone	5
Utilizando com PC ou Mac.....	7
Utilizando com PS4™	11
Conectando os fones de ouvido	12
Monitoramento do Controle do Microfone	13
Instalando o Adaptador de montagem	15



Visão geral

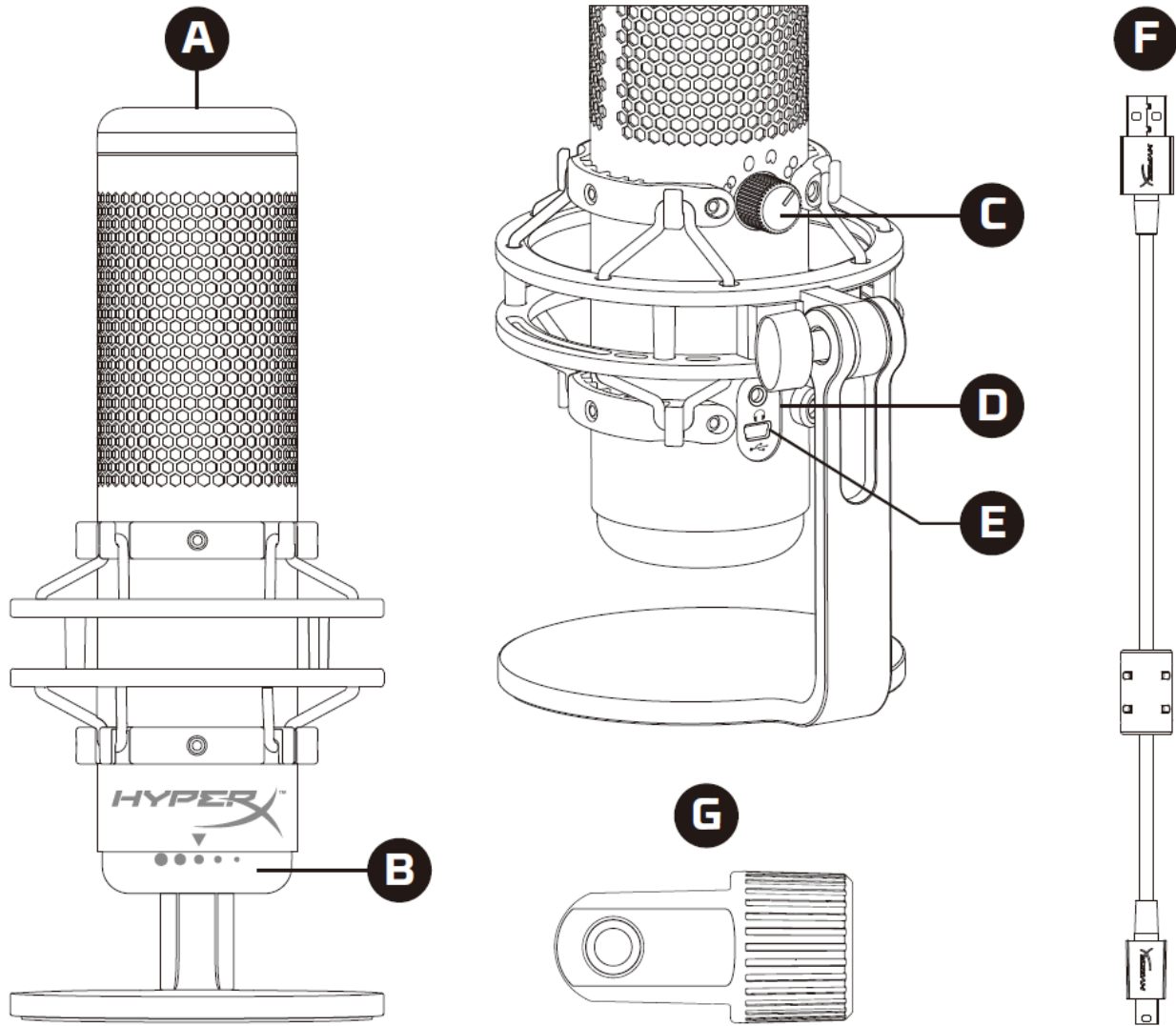

- A. Sensor de toque para colocar em mudo
- B. Botão de Controle de Ganho
- C. Botão de Padrão Polar
- D. Porta do fone de ouvido
- E. Porta do cabo USB
- F. Cabo USB
- G. Adaptador de montagem*

*Compatível com tamanhos de fio de 3/8 pol e 5/8 pol



Especificações

Microfone

Consumo de Energia: 5V 125mA

Taxa de bits/amostra: 48kHz/16-bits

Elemento: Microfone condensador Electret

Tipo de condensador: Três condensadores de 14 mm

Padrão polar: Estéreo, Omnidirecional, Cardióide, Bidirecional

Resposta de frequência: 20Hz - 20kHz

Sensibilidade: -36dB (1V/Pa a 1kHz)

Comprimento do cabo: 3m

Peso:

- Microfone: 254g
- Base shock mount e pedestal: 364g
- Total com cabo USB: 710g

Saída do fone de ouvido

Impedância: 32 Ω

Resposta de frequência: 20Hz - 20kHz

Máxima saída de energia: 7mW

THD: $\leq 0.05\%$ (1kHz/0dBFS)

SNR: $\geq 90\text{dB}$ (1kHz, $R_L = \infty$)



Controles do Microfone

Selecionando um Padrão Polar

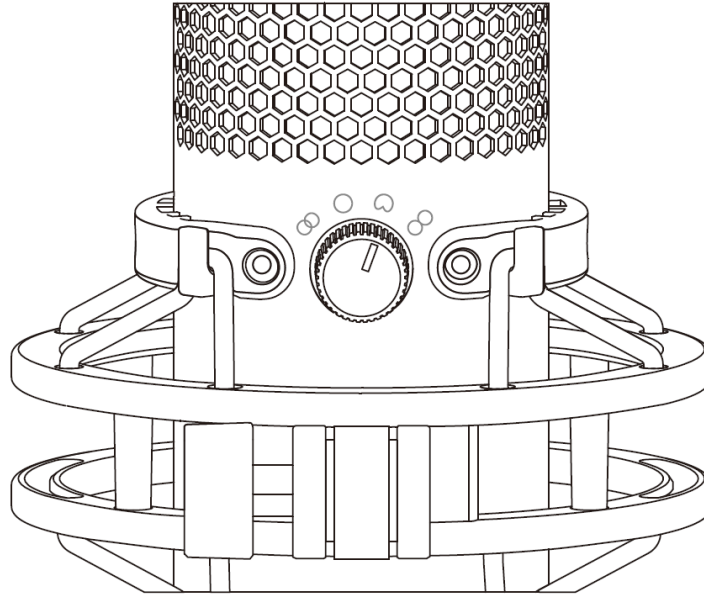

Gire o botão do padrão polar para selecionar um dos quatro padrões polares.

Símbolo	Direção do som	Padrão Polar	Cenários
		Estéreo	Vocais, instrumentos
		Omnidirecional	Podcasts com várias pessoas, conferências
		Cardióide	Podcasts, streaming, narração, instrumentos
		Bidirecional	Entrevistas pessoais



Ajustando o controle de ganho

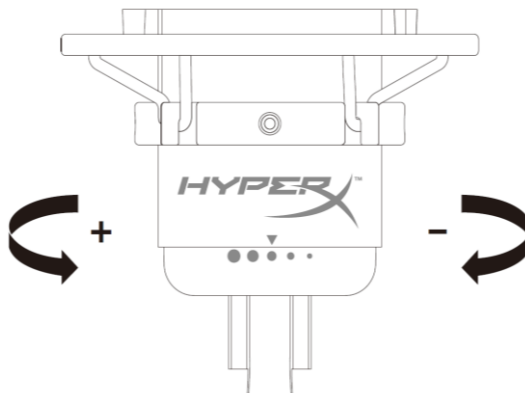

Gire o botão de controle de ganho para ajustar o ganho do microfone.

Colocar o microfone em mudo

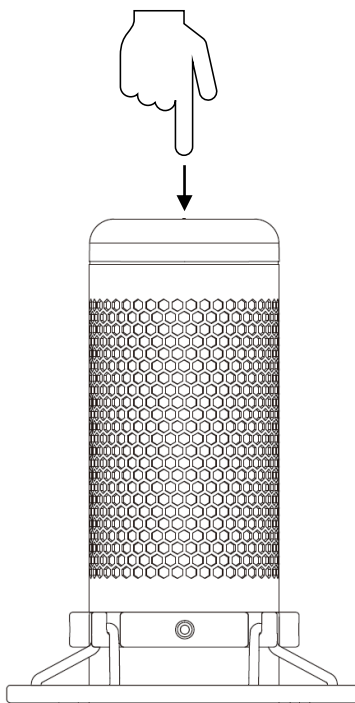

Toque na parte superior do microfone para colocar em mudo/ativo o som do microfone. O LED do microfone indicará o status atual do som do microfone.

LED do microfone	Status do som do microfone
Vermelho	Ativo
Desligado	Mudo



Utilizando com PC ou Mac

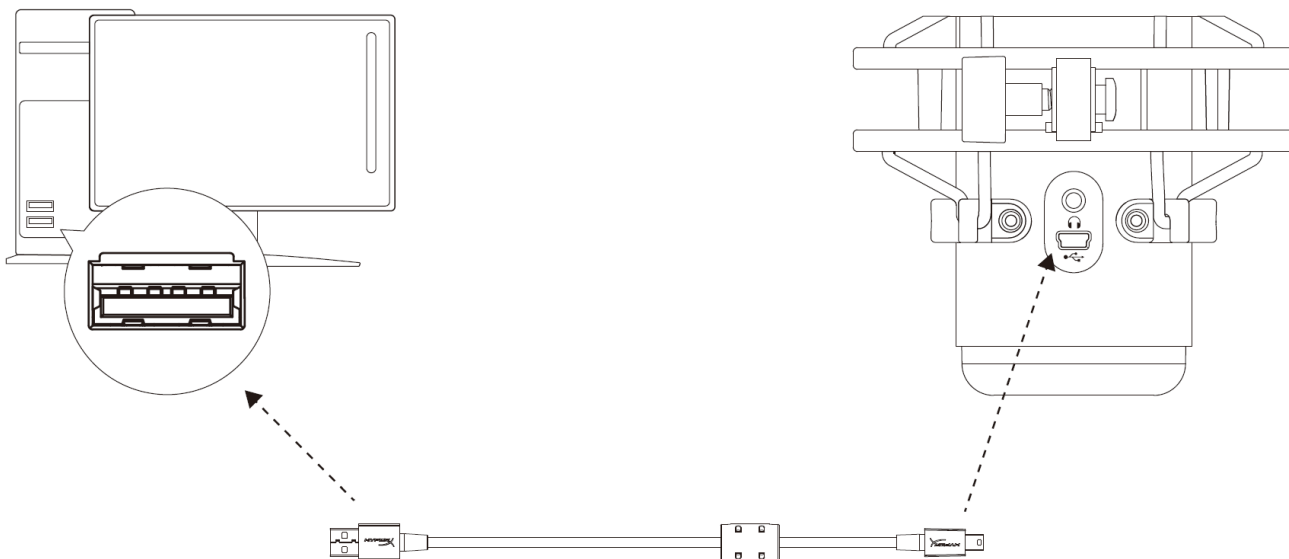

Conecte o microfone a uma porta USB no PC ou Mac com o cabo USB incluído.

Windows

Para assegurar que o microfone esteja configurado corretamente no PC, siga os passos abaixo:

1. Clique com o botão direito do mouse no ícone de som na bandeja do sistema e selecione **Sons**.

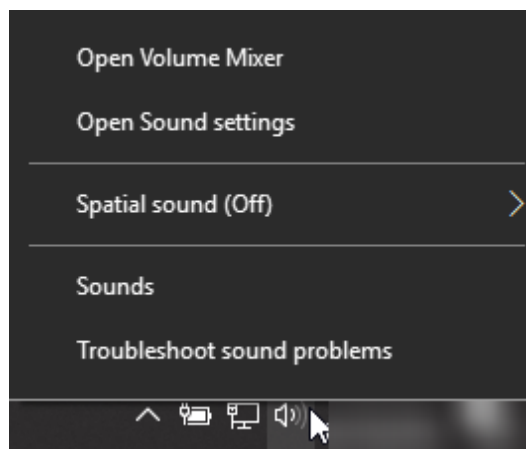



- Na guia *Reprodução*, selecione **Alto-Falantes HyperX QuadCast** e clique no botão **Definir padrão**.

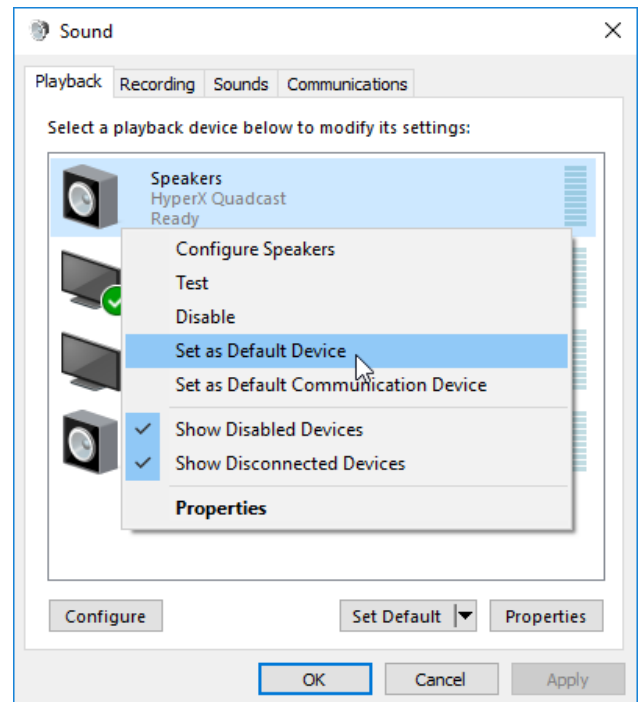

- Na guia *Gravação*, selecione **Microfone HyperX QuadCast** e clique no botão **Definir padrão**.

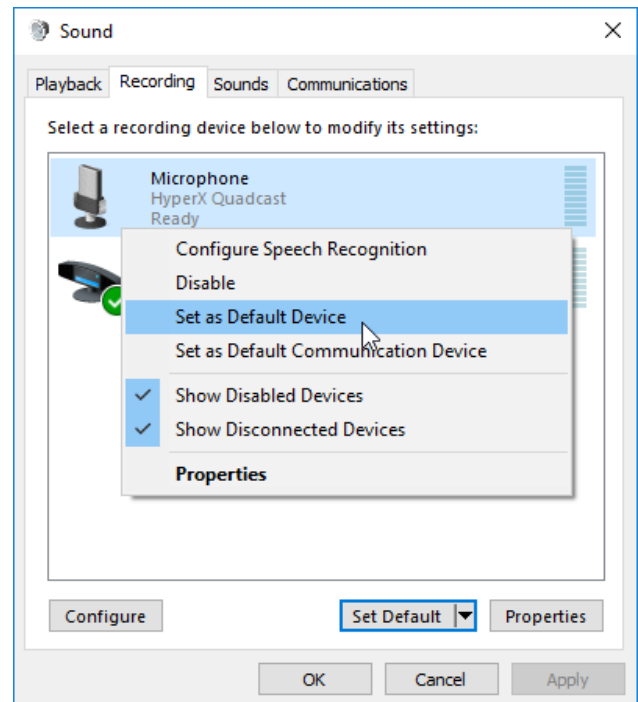



macOS

Para assegurar que o microfone esteja configurado corretamente no macOS, siga os passos abaixo:

1. Abra **Preferências do Sistema** e selecione **Som**.

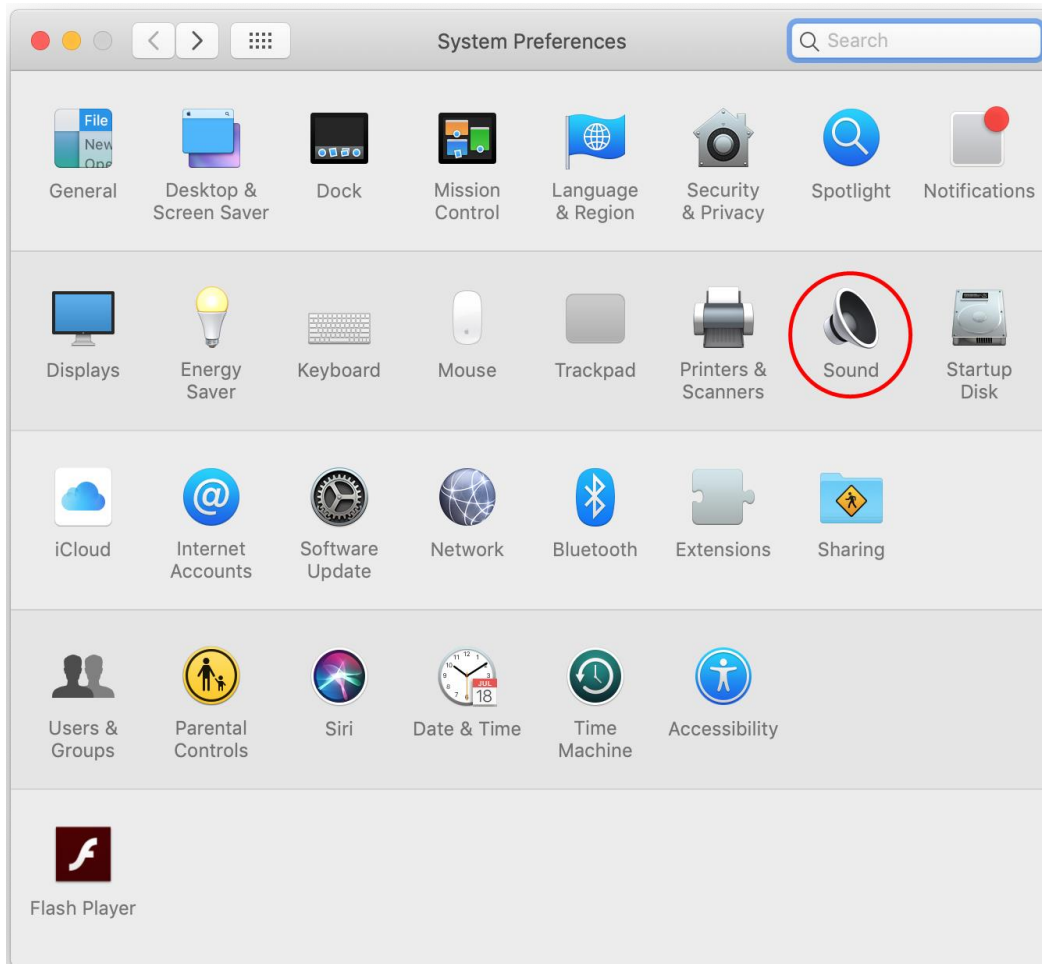



2. Na aba *Saída*, selecione **HyperX QuadCast**.

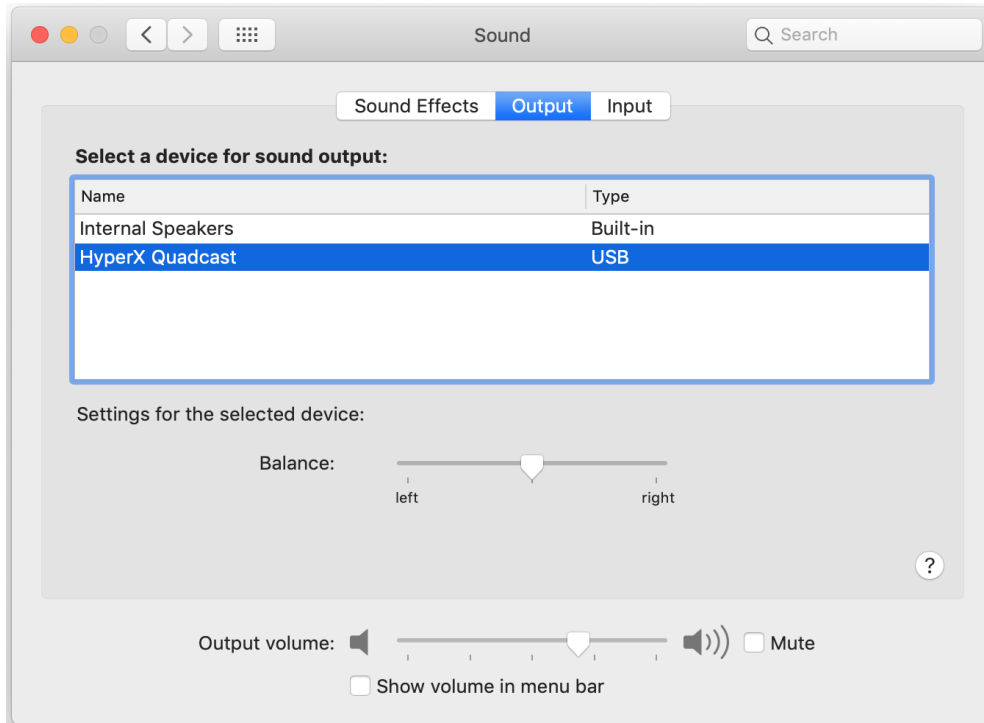

3. Na aba *Entrada*, selecione **HyperX QuadCast**.

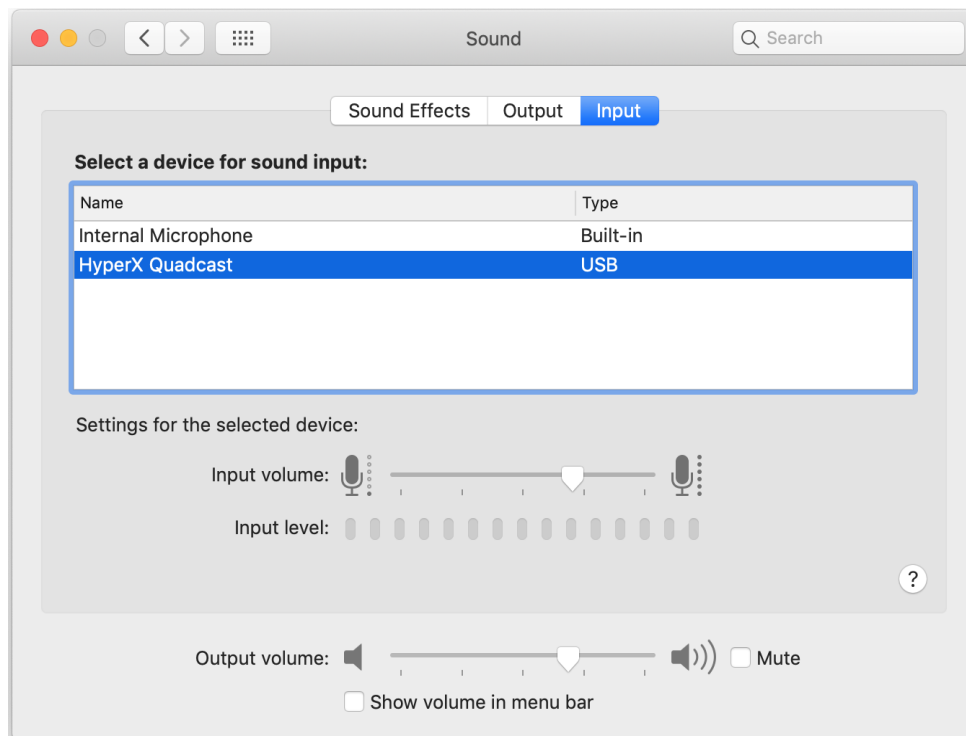



Utilizando com PS4™

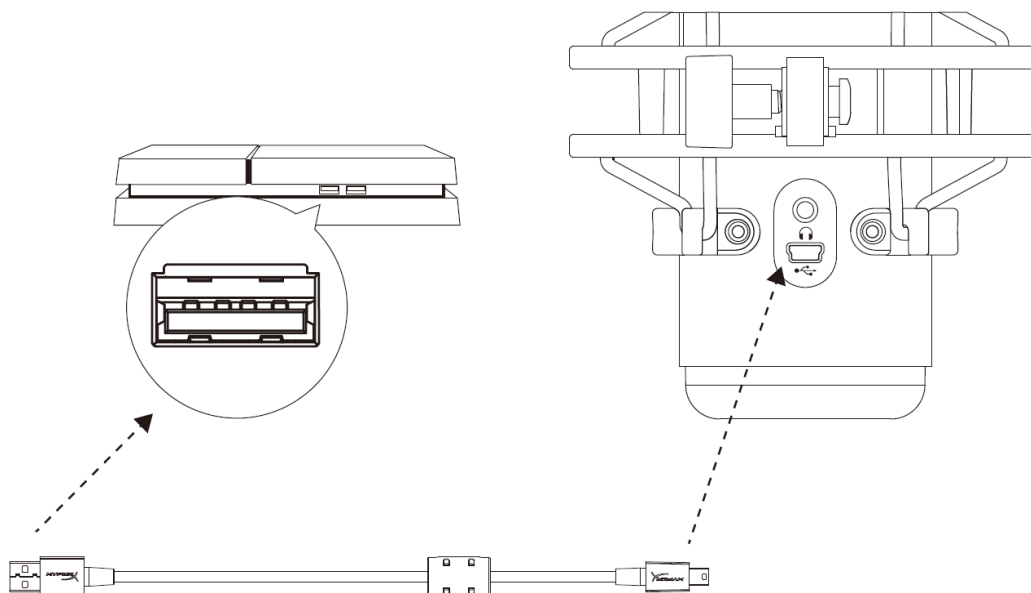

Conecte o microfone a uma porta USB no PS4 com o cabo USB incluído.

Para assegurar que o microfone esteja ajustado com as configurações otimizadas no PS4, siga os passos abaixo:

1. No menu principal do PS4, vá para **Configurações > Dispositivos > Dispositivos de Áudio**
2. Defina *Dispositivo de Entrada* para **USB Headset (HyperX QuadCast)**
3. Defina *Dispositivo de Saída* para **USB Headset (HyperX QuadCast)**
4. Defina *Saída para fones de ouvido* para **Todo o Áudio**
5. Ajuste o *Controle de Volume (Fones de ouvido)* para o volume desejado

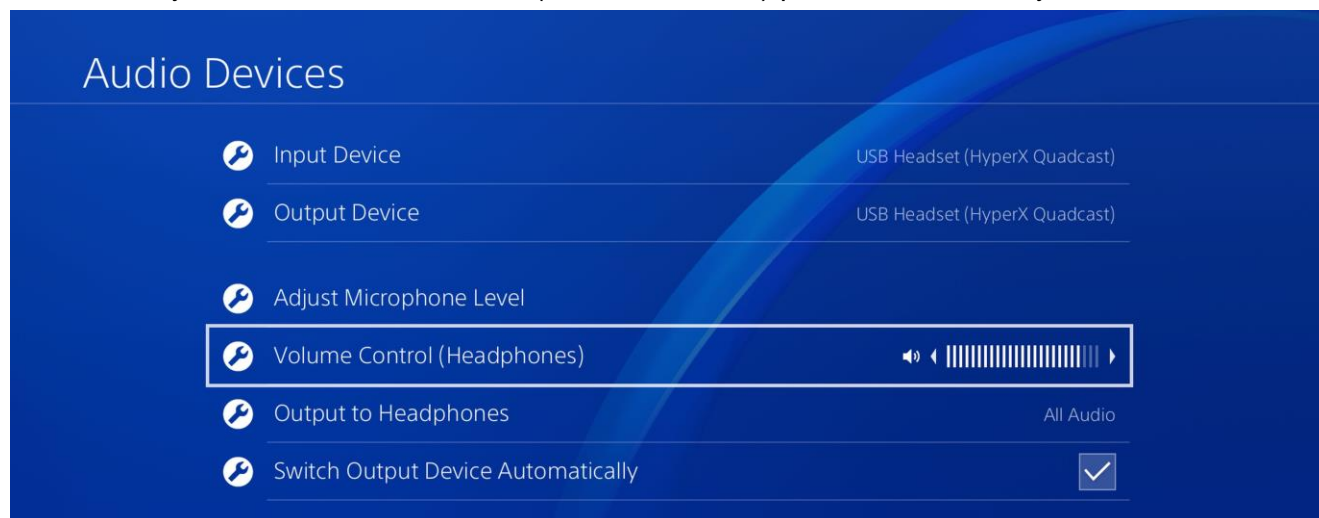



Conectando os fones de ouvido

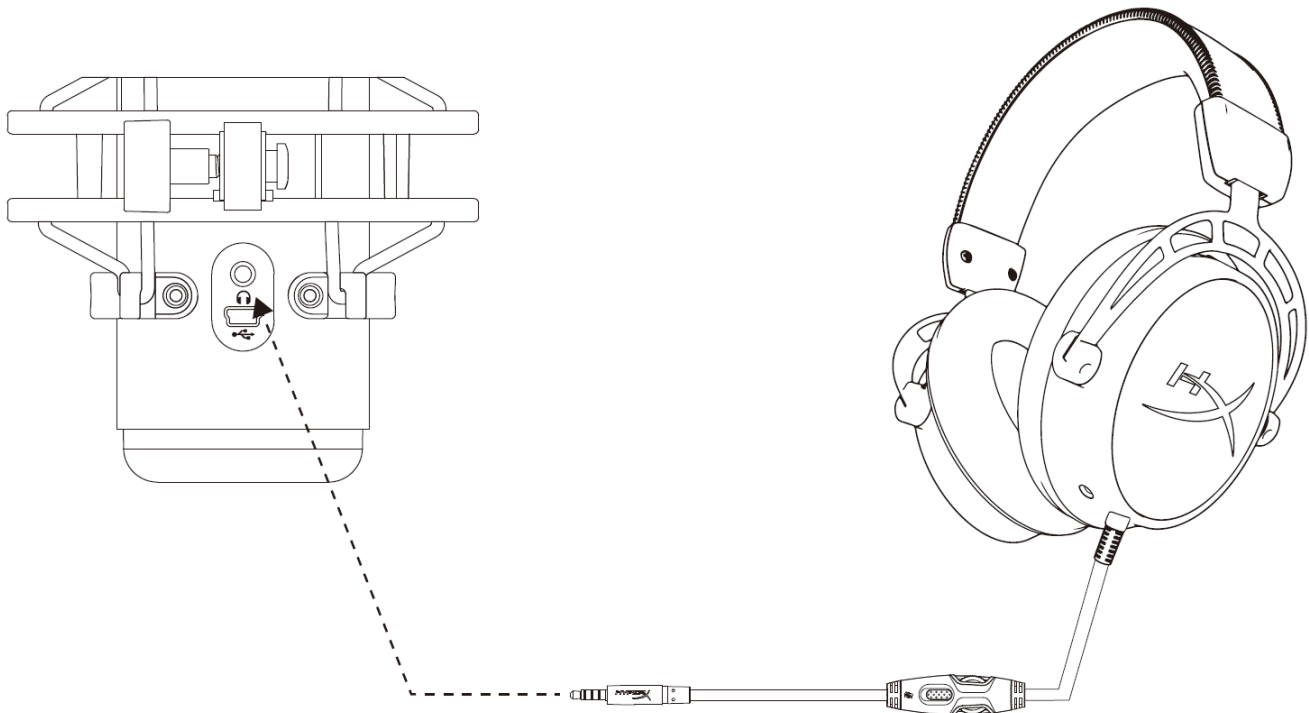

Conecte os fones de ouvido à porta do fone de ouvido no microfone para monitoramento do microfone e reprodução de áudio.



Monitoramento do Controle do Microfone

PC

1. No painel de controle de Som na aba *Reprodução*, clique com o botão direito em **Speakers HyperX QuadCast** e selecione **Propriedades**.

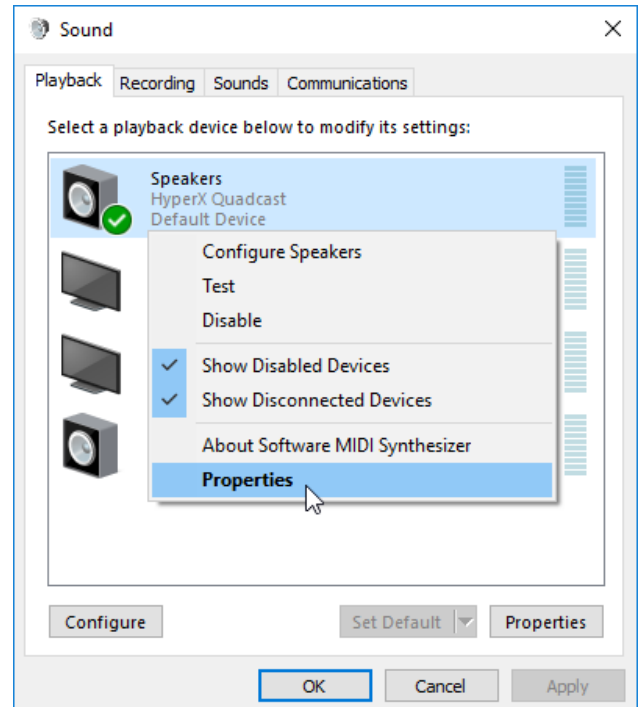

2. Na aba *Níveis*, ajuste o controle deslizante de volume do **Microfone** para ajustar o nível de monitoramento do microfone.

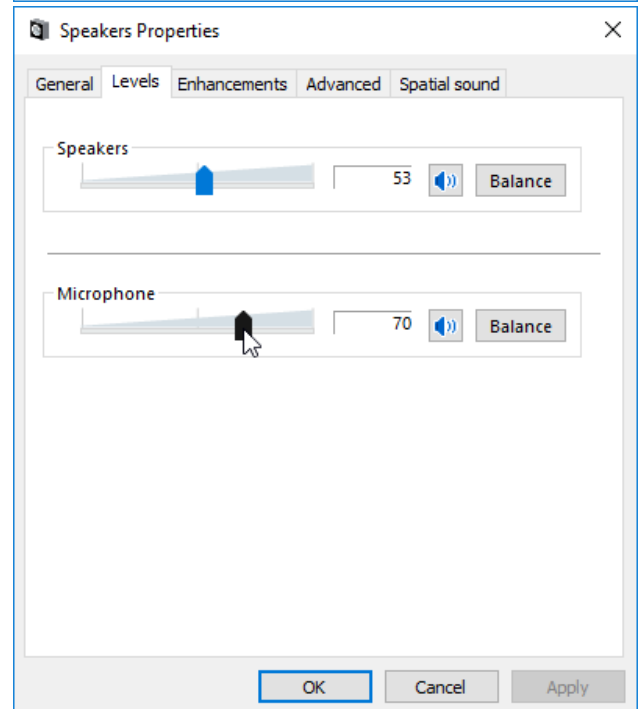



macOS

1. Abra o aplicativo **Finder** e vá para **Aplicativos > Utilitários > Configuração Áudio e MIDI**

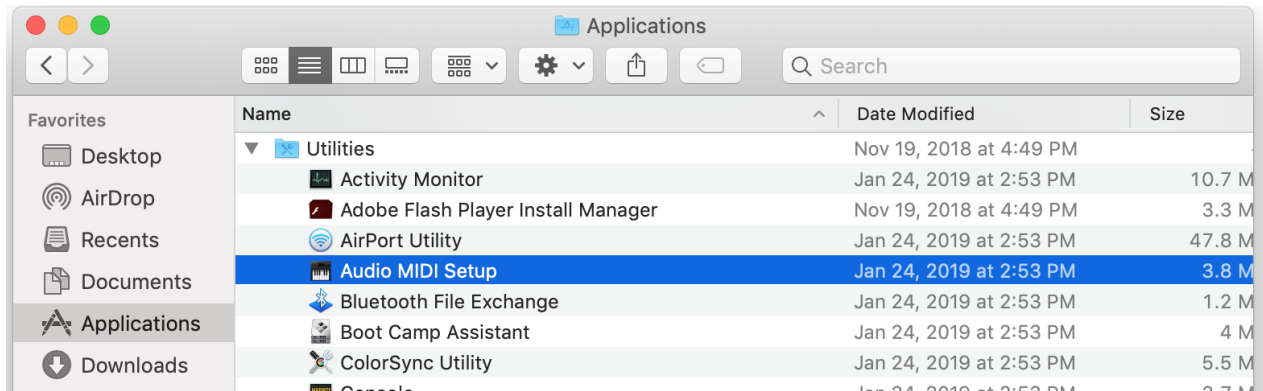

2. Clique em **HyperX QuadCast 2** e clique na caixa de verificação sob a coluna *Thru* para alternar o monitoramento do microfone entre ligado e desligado.

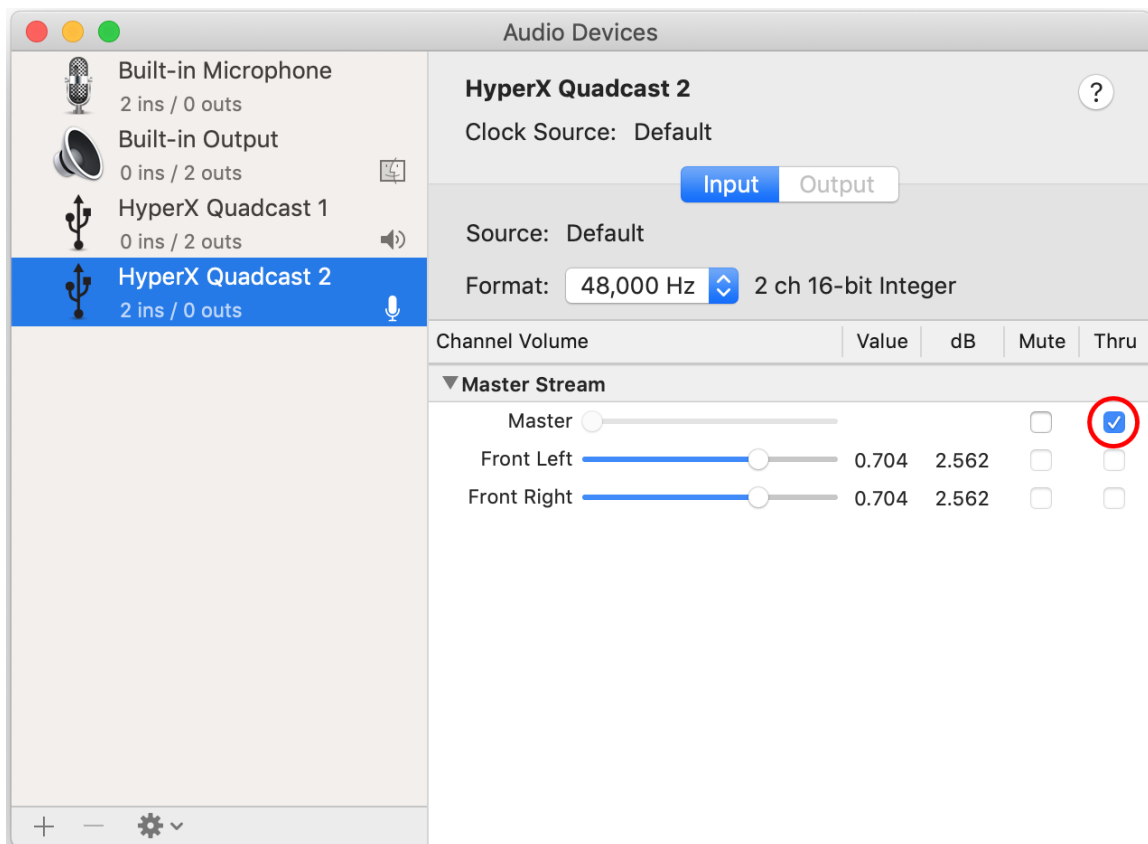

PS4

O nível de monitoramento do microfone não pode ser controlado diretamente no PS4.



Instalando o Adaptador de montagem

1. Prenda o adaptador de montagem incluído a haste do microfone. O adaptador de montagem é compatível com tamanhos de fio de 3/8 pol e 5/8 pol
2. Remova o parafuso e a porca do pedestal do microfone.
3. Retire o pedestal do microfone do microfone.
4. Alinhe o adaptador de montagem com os furos de montagem do microfone e prenda o adaptador com o parafuso e a porca.



Dúvidas ou Problemas na Instalação?

Entre em contato com a equipe de suporte HyperX em: hyperxgaming.com/support/



HyperX QuadCast[™]



Numery katalogowe

HX-MICQC-BK



SPIS TREŚCI

Prezentacja.....	3
Dane techniczne	4
Elementy sterujące mikrofonu	5
Użytkowanie urządzenia z komputerem PC lub Mac.....	7
Użytkowanie urządzenia z konsolą PS4™	11
Podłączanie słuchawek.....	12
Sterowanie monitorowaniem mikrofonu	13
Montowanie adaptera do mocowania	15



Prezentacja

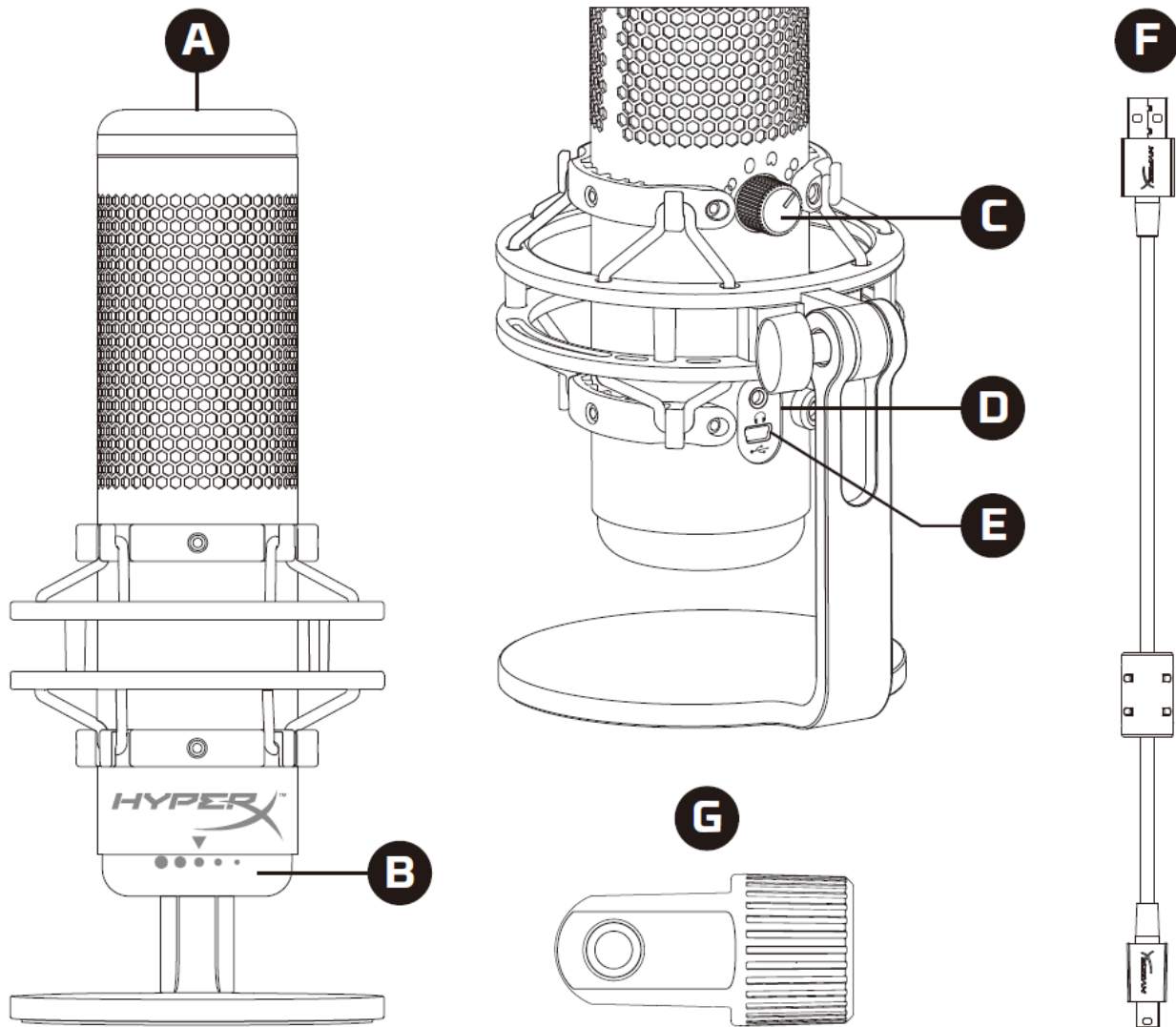

- A. Czujnik wyciszania dotykaniem
- B. Pokrętko wzmocnienia
- C. Pokrętko wzorca polaryzacji
- D. Gniazdo słuchawkowe
- E. Gniazdo przewodu USB
- F. Przewód USB
- G. Adapter do mocowania*

* Zgodny z gwintami 3/8 i 5/8 cala



Dane techniczne

Mikrofon

Pobór energii: 5 V, 125 mA

Próbkowanie: 48 kHz / 16-bitowe

Element: elektretowy mikrofon pojemnościowy

Rodzaj kondensatora: trzy kondensatory 14 mm

Wzorce polaryzacji: stereo, dookólny, kardioidalny, dwukierunkowy

Pasma przenoszenia: 20 Hz–20 kHz

Czułość: -36 dB (1 V/Pa przy 1 kHz)

Długość przewodu: 3 m

Waga:

- Mikrofon: 254 g
- Zawieszenie przeciwwstrząsowe i podstawka: 364 g
- Razem z przewodem USB: 710 g

Wyjście słuchawkowe

Impedancja: 32 Ω

Pasma przenoszenia: 20 Hz–20 kHz

Moc maksymalna: 7 mW

Zniekształcenia harmoniczne (THD): $\leq 0,05\%$ (1 kHz / 0 dBFS)

Stosunek sygnału do szumu (SNR): ≥ 90 dB (1 kHz, $R_L = \infty$)







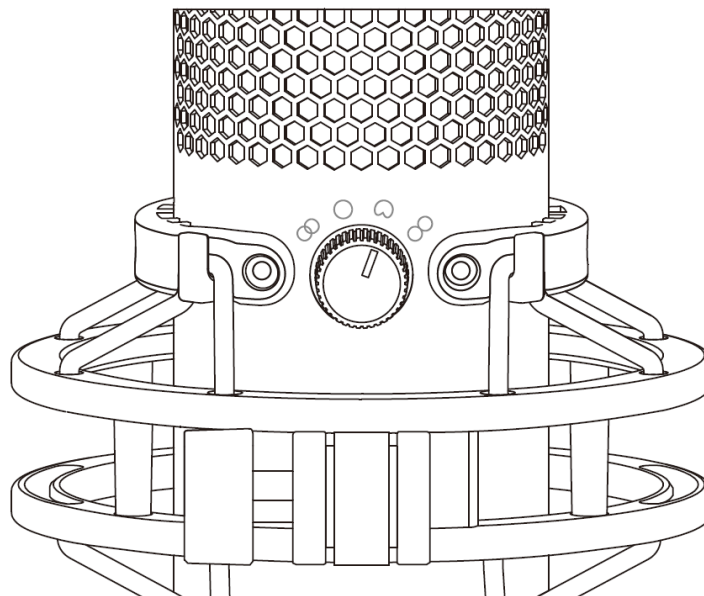

Elementy sterujące mikrofonu

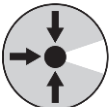
Wybór wzorca polaryzacji

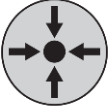

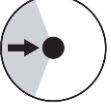
Przekręć pokrętkę wzorca polaryzacji, aby wybrać jeden z czterech wzorców polaryzacji.

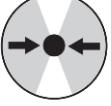
Symbol	Kierunek dźwięku	Wzorec polaryzacji	Przykładowe zastosowania
		Stereo	Głosy, instrumenty
		Dookólny	Podcasty z wieloma osobami, telekonferencje
		Kardoidalny	Podcasty, przesyłanie strumieniowe, podkłady głosowe, instrumenty
		Dwukierunkowy	Rozmowy z dwoma uczestnikami



Regulacja wzmacnienia

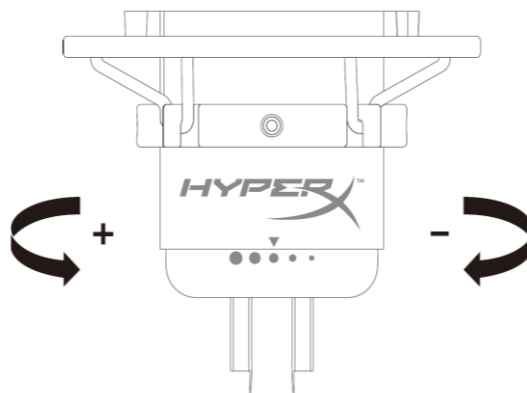

Przekręć pokrętko wzmacnienia, aby wyregulować wzmacnienie mikrofonu.

Wyciszanie mikrofonu

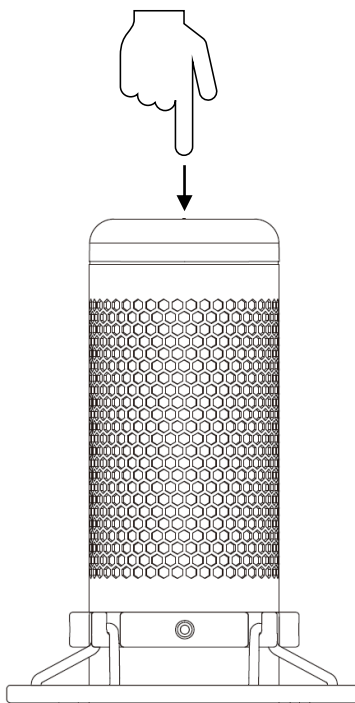

Dotknij górnej części mikrofonu, aby go wyciszyć lub ponownie uaktywnić. Wskaźnik LED pokazuje bieżący stan wyciszenia mikrofonu.

Wskaźnik LED mikrofonu	Stan wyciszenia
Czerwony	Wyciszenie wyłączone
Nie świeci	Wyciszenie włączone



Użytkowanie urządzenia z komputerem PC lub Mac

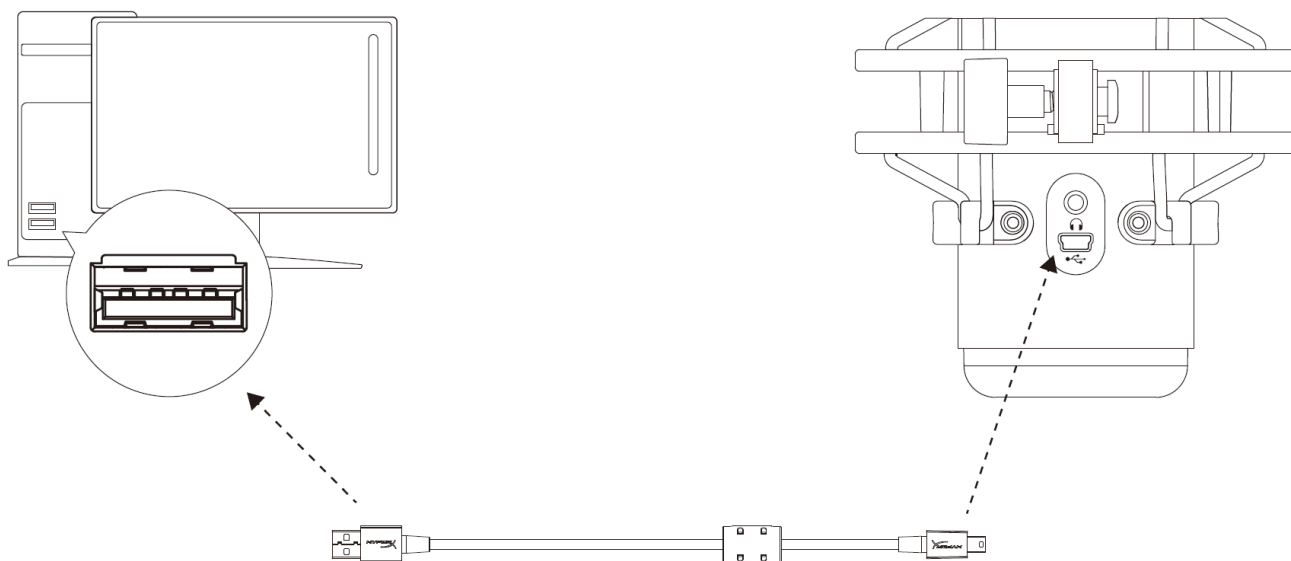

Podłącz mikrofon do portu USB w komputerze PC lub Mac za pomocą dołączonego przewodu USB.

System Windows

Wykonaj poniższe czynności, aby prawidłowo skonfigurować komputer PC do pracy z mikrofonem:

1. Kliknij prawym przyciskiem myszy ikonę dźwięku w obszarze powiadomień systemu i wybierz polecenie **Dźwięki**.

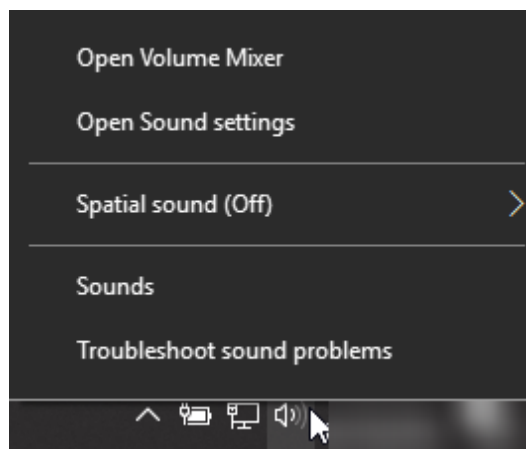



2. Na karcie *Playback* (Odtwarzanie) zaznacz pozycję **Speakers HyperX QuadCast** i kliknij przycisk **Set Default** (Ustaw jako urządzenie domyślne).

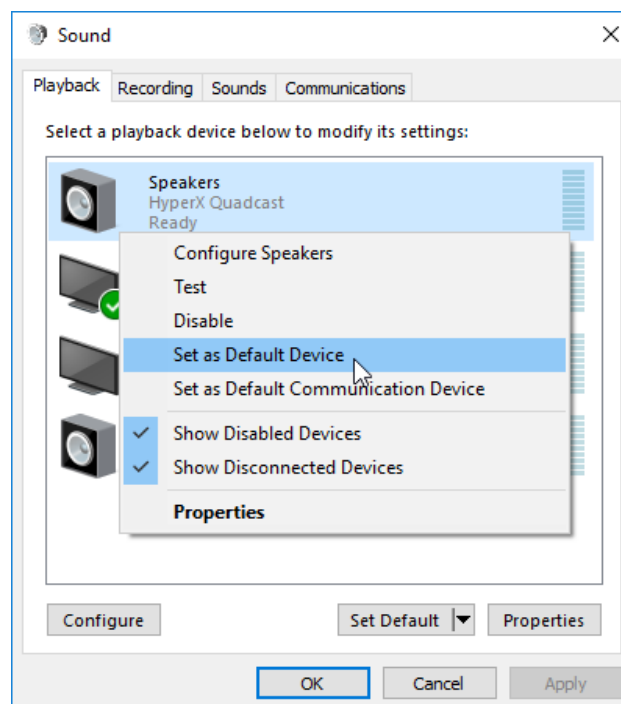

3. Na karcie *Recording* (Nagrywanie) zaznacz pozycję **Microphone HyperX QuadCast** i kliknij przycisk **Set Default** (Ustaw jako urządzenie domyślne).

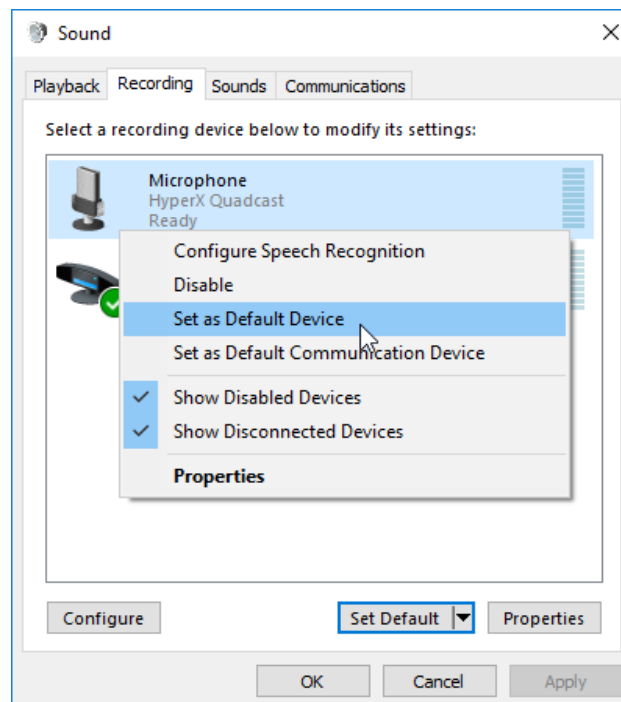



System macOS

Wykonaj poniższe czynności, aby prawidłowo skonfigurować komputer z systemem macOS do pracy z mikrofonem:

1. Otwórz **Preferencje systemowe** i wybierz opcję **Dźwięk**.

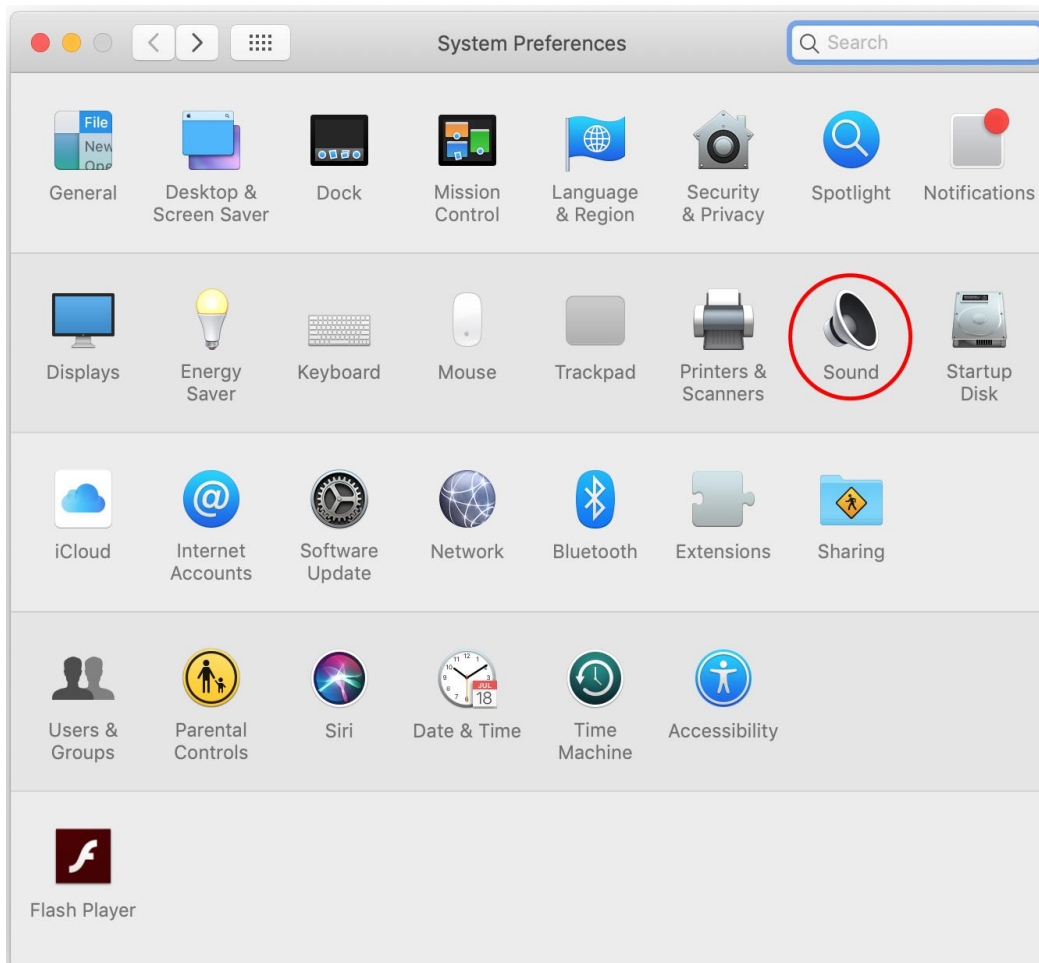



2. Na karcie *Wyjście* wybierz **HyperX QuadCast**.

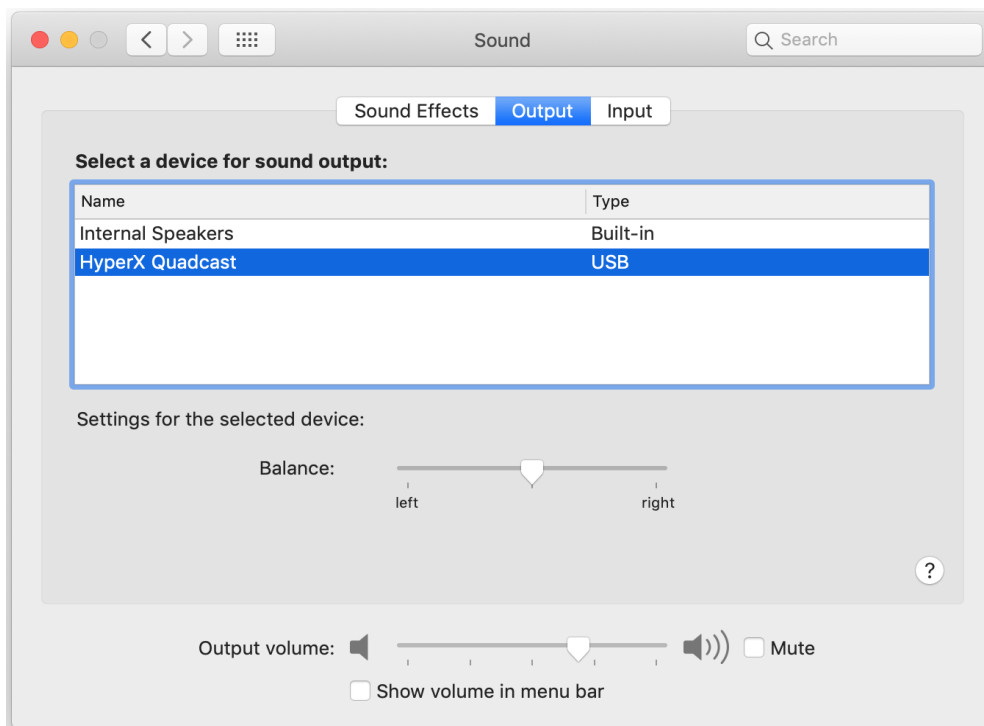

3. Na karcie *Wejście* wybierz **HyperX QuadCast**.

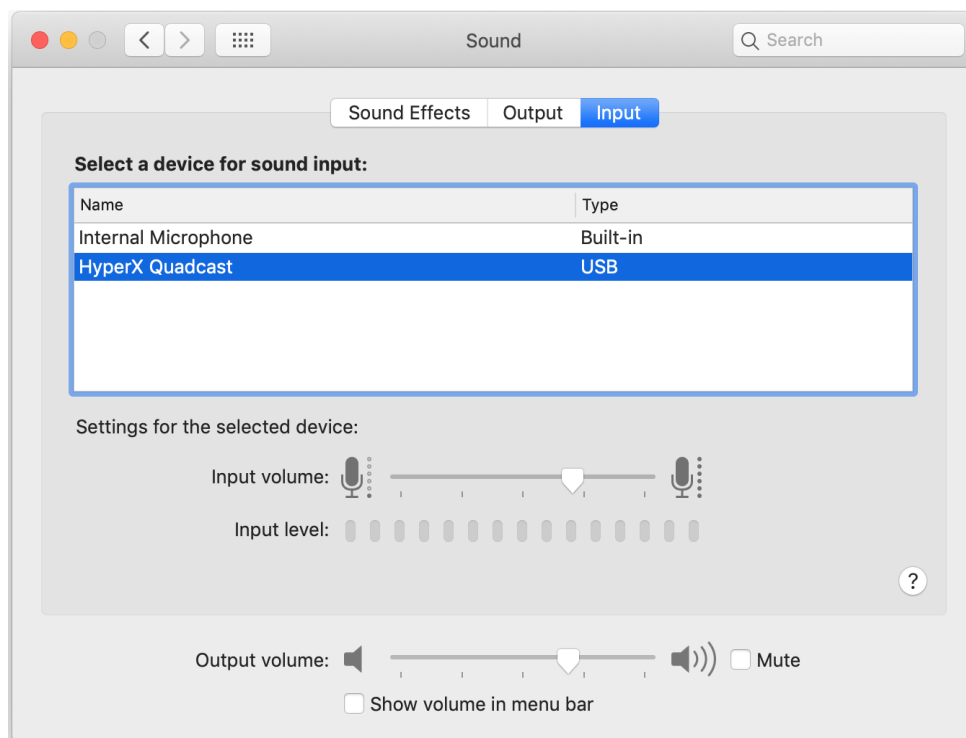



Użytkowanie urządzenia z konsolą PS4[™]

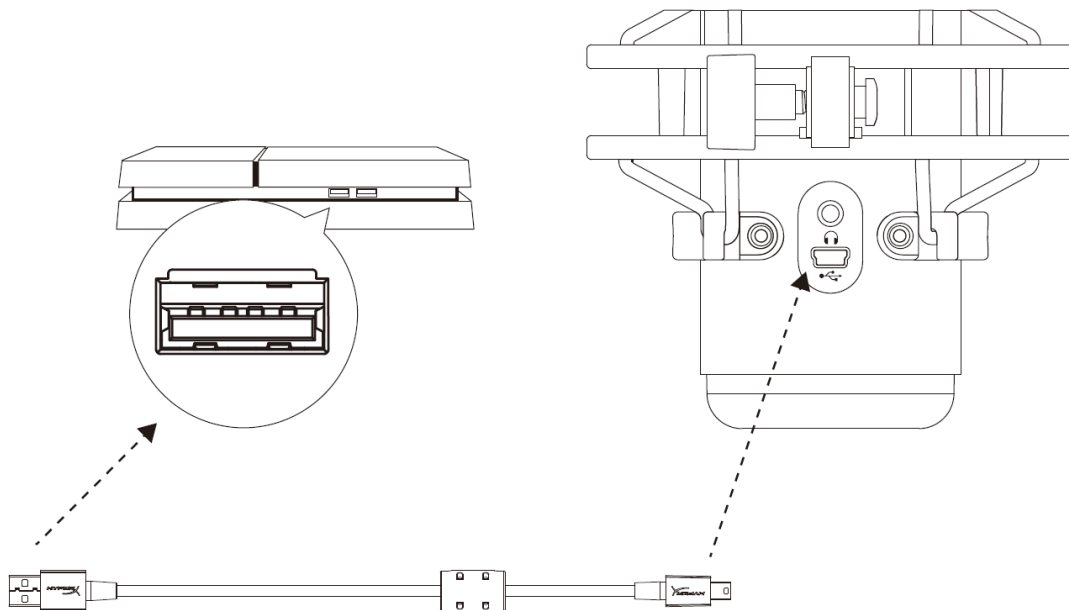

Podłącz mikrofon do portu USB w konsoli PS4 za pomocą dołączonego przewodu USB.

Wykonaj poniższe czynności, aby optymalnie skonfigurować konsolę PS4 do pracy z mikrofonem:

1. W menu konsoli PS4 wybierz kolejno polecenia **Settings (Ustawienia) > Devices (Urządzenia) > Audio Devices (Urządzenia audio)**.
2. W pozycji *Input Device (Urządzenie wejściowe)* wybierz opcję **USB Headset (HyperX QuadCast) (Zestaw słuchawkowy USB HyperX QuadCast)**.
3. W pozycji *Output Device (Urządzenie wyjściowe)* wybierz opcję **USB Headset (HyperX QuadCast) (Zestaw słuchawkowy USB HyperX QuadCast)**.
4. W pozycji *Output to Headphones (Wyjście na słuchawki)* wybierz opcję **All Audio (Cały dźwięk)**.
5. Ustaw odpowiednią głośność słuchawek

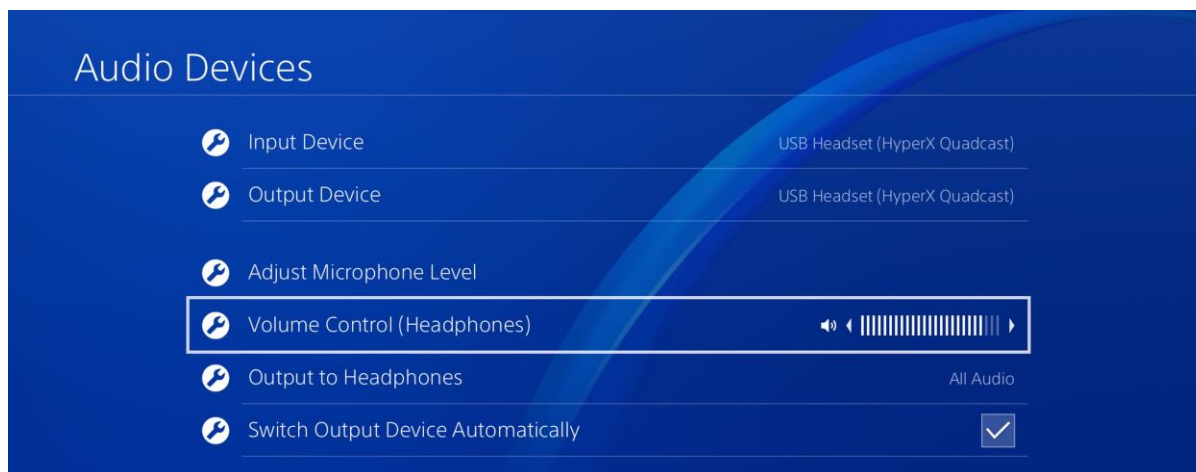



Podłączanie słuchawek

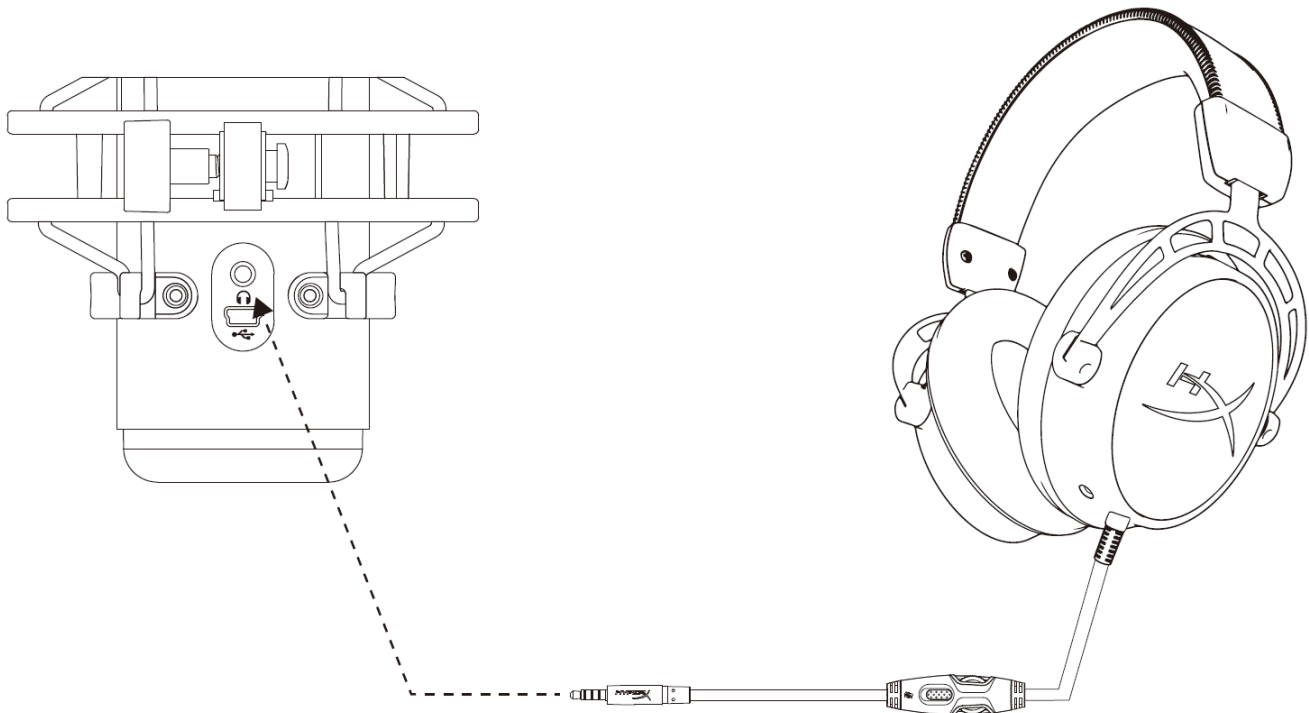

Połącz słuchawki do gniazda słuchawkowego mikrofonu, aby monitorować działanie mikrofonu i odtwarzać dźwięk.



Sterowanie monitorowaniem mikrofonu

PC

1. W panelu sterowania dźwiękiem na karcie *Odtwarzanie* kliknij prawym przyciskiem myszy pozycję **Głośniki HyperX QuadCast** i wybierz opcję **Właściwości**.

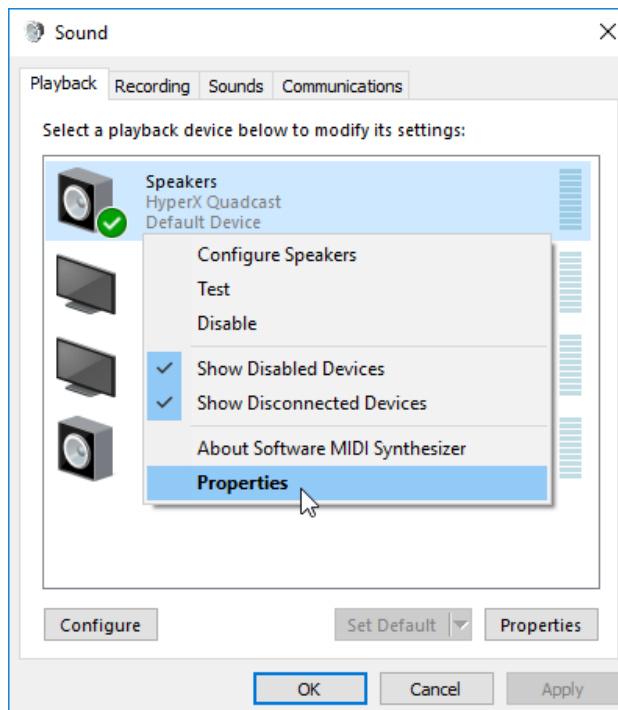

2. Na karcie *Poziomy* ustaw suwak głośności **Mikrofon**, aby dostosować monitorowanie mikrofonu.

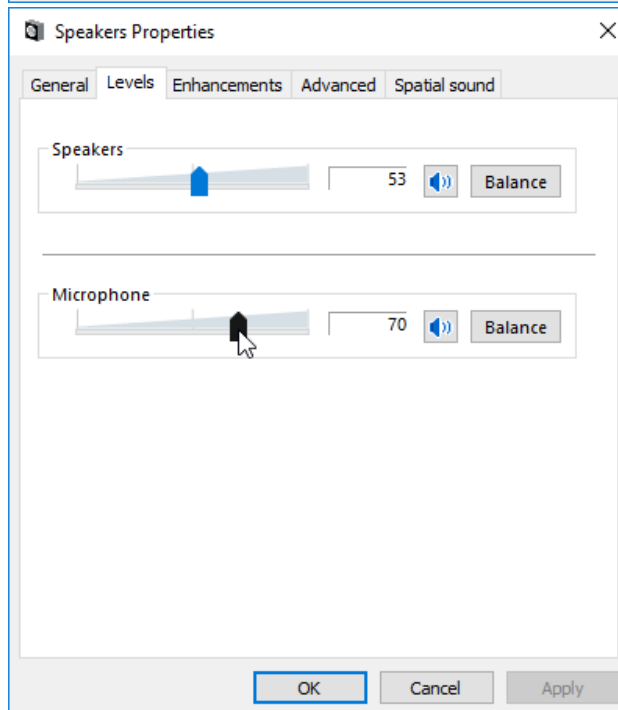



macOS

1. Otwórz aplikację **Finder**, a następnie wybierz kolejno pozycje **Aplikacje > Narzędzia > Konfigurator MIDI Audio**.

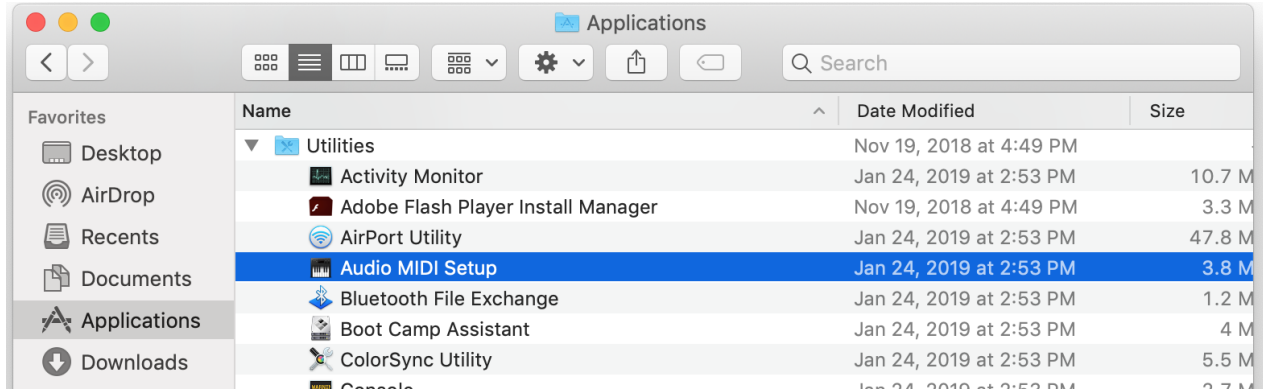

2. Kliknij pozycję **HyperX QuadCast 2**, a następnie kliknij pole wyboru w kolumnie *Thru*, aby włączyć lub wyłączyć monitorowanie mikrofonu.

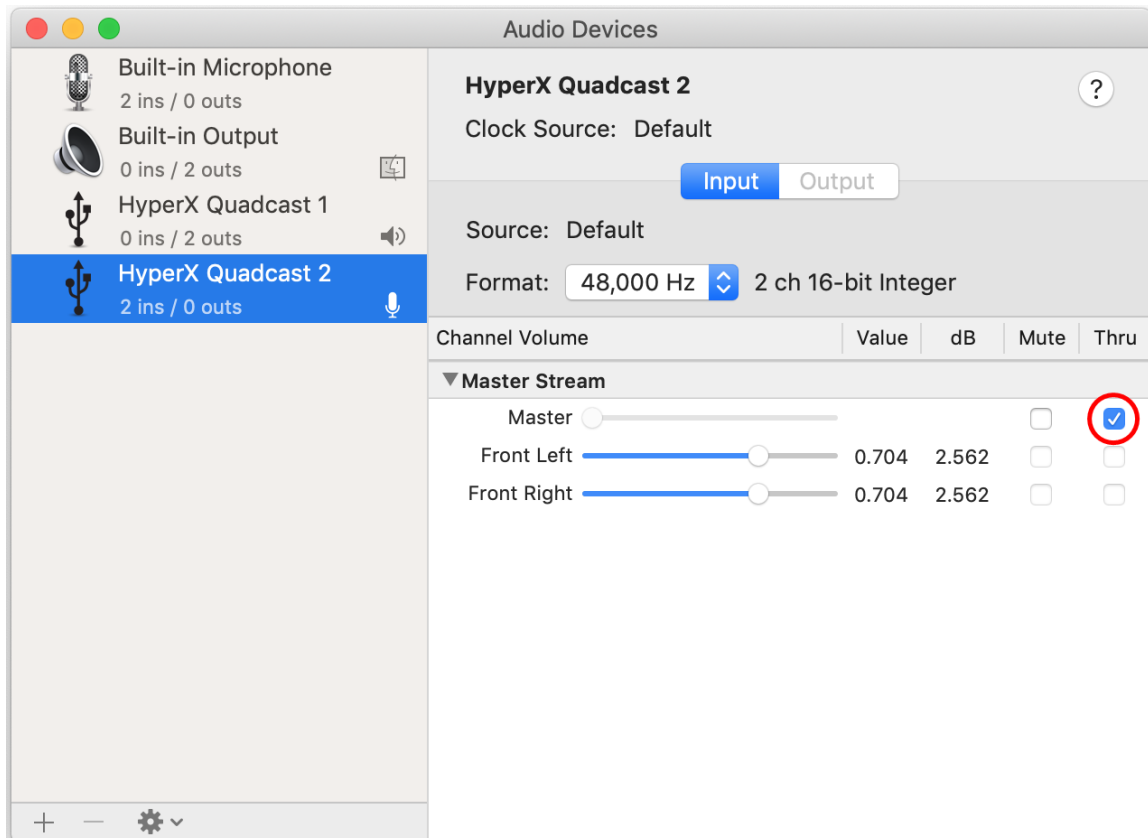

PS4

W konsoli PS4 nie ma możliwości bezpośredniego sterowania poziomem monitorowania mikrofonu.



Montowanie adaptera do mocowania

1. Przymocuj dołączony adapter do mocowania do wysięgnika mikrofonu. Do adaptera do mocowania pasują gwinty 3/8 i 5/8 cala.
2. Odkręć śrubę motylkową i nakrętkę z podstawki mikrofonu.
3. Odłącz podstawkę od mikrofonu.
4. Wyrównaj adapter do mocowania z otworami montażowymi w mikrofonie i przykręć adapter za pomocą śruby motylkowej i nakrętki.



Pytania? Problemy z konfiguracją?

Skontaktuj się z działem pomocy technicznej HyperX na stronie: hyperxgaming.com/support/



HyperX QuadCast[™]



Номера по каталогу

HX-MICQC-BK



СОДЕРЖАНИЕ

Обзор	3
Технические характеристики	4
Элементы управления микрофоном.....	5
Использование с ПК или компьютером Mac.....	7
Использование с PS4™	11
Подключение наушников	12
Управление регистрацией данных микрофона.....	13
Установка переходника крепления.....	15



Обзор

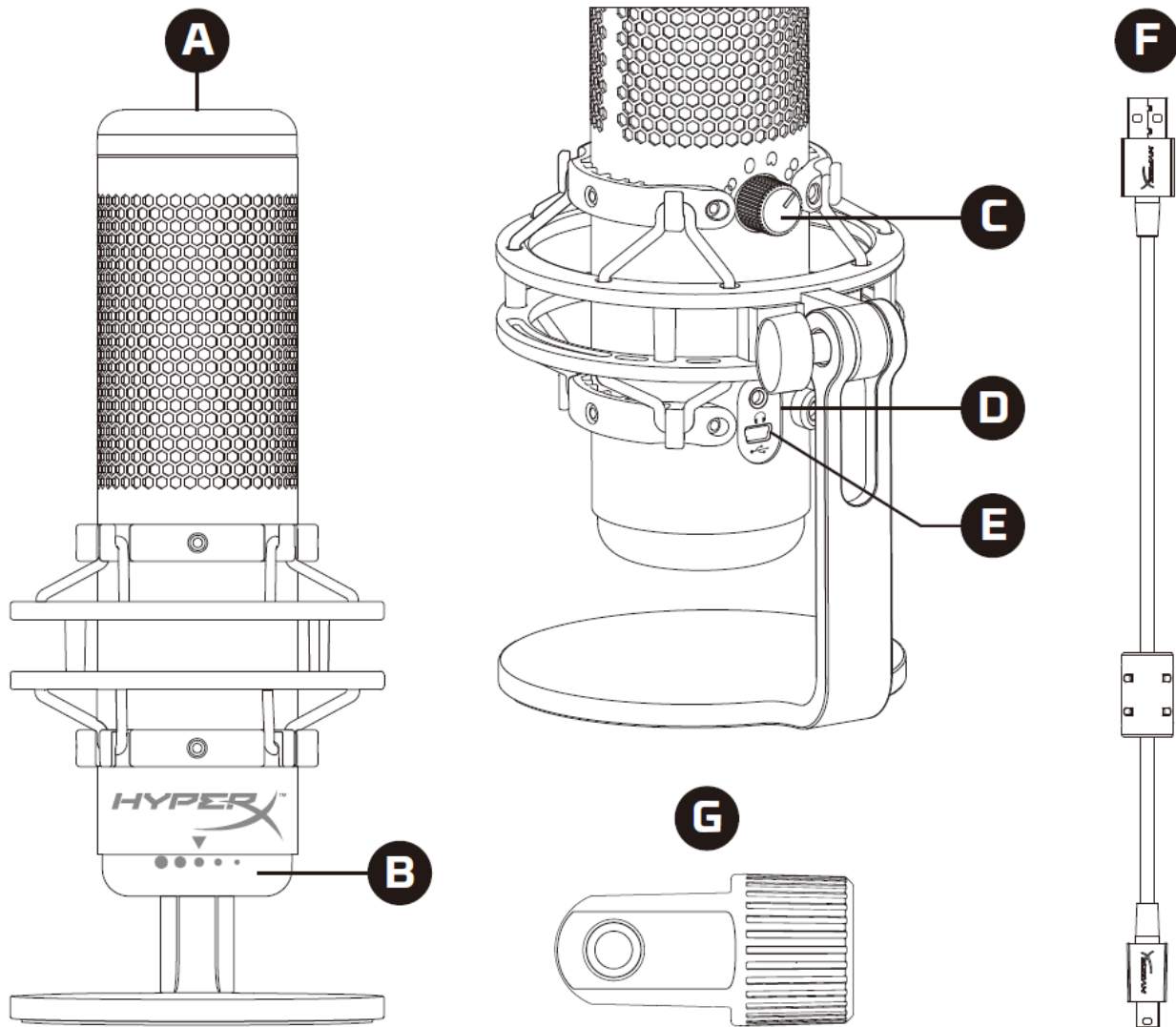

- A. Сенсорный датчик отключения звука
- B. Регулятор усиления
- C. Регулятор диаграммы направленности
- D. Разъем для наушников
- E. Порт для USB-кабеля
- F. USB-кабель
- G. Переходник крепления*

*Подходит для резьбы размеров 3/8" и 5/8"



Технические характеристики

Микрофон

Энергопотребление: 5В 125мА

Частота дискретизации/скорость потока: 48кГц/16бит

Элемент: Электретный конденсаторный микрофон

Тип конденсатора: Три 14мм конденсатора

Диаграммы направленности: Стерео, всенаправленная, кардиоидная, двунаправленная

Частотная характеристика: 20Гц–20кГц

Чувствительность: -36дБ (1В/Па при 1кГц)

Длина кабеля: 3м

Вес:

- Микрофон: 254г
- Антишоковый подвес и подставка: 364г
- Общий вес с USB-кабелем: 710г

Выход для наушников

Импеданс: 32Ом

Частотная характеристика: 20Гц–20кГц

Максимальная выходная мощность: 7МВт

Коэффициент нелинейных искажений: $\leq 0,05\%$ (1кГц/0dBFS)

Отношение сигнала к шуму: ≥ 90 дБ (1кГц, $R_L = \infty$)



Элементы управления микрофоном

Выбор диаграммы направленности

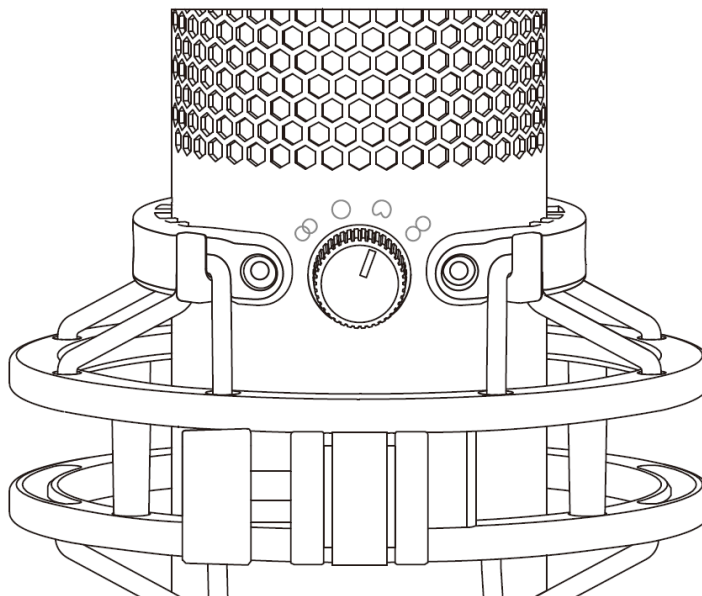

Чтобы выбрать одну из четырех диаграмм направленности, поверните регулятор диаграммы направленности.

Символ	Направление звука	Диаграмма направленности	Сценарии
		Сtereo	Вокал, инструменты
		Всенаправленная	Подкасты для нескольких человек, конференц-звонки
		Кардиоидная	Подкасты, стриминг, дубляж, инструменты
		Двунаправленная	Личные интервью



Регулировка усиления

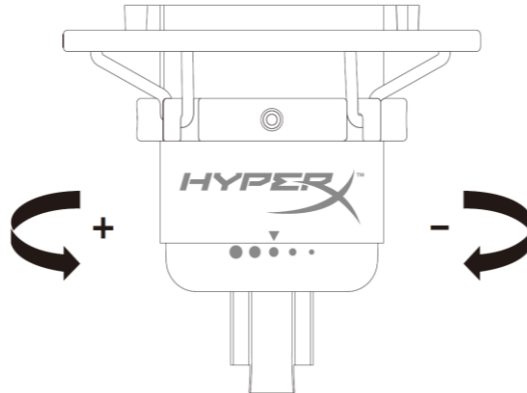

Чтобы отрегулировать усиление микрофона, поверните кнопку регулировки усиления.

Отключение звука микрофона

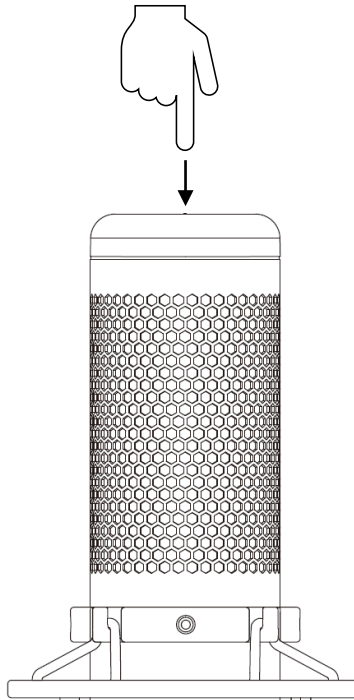

Чтобы отключить или включить звук микрофона, коснитесь его верхней части. Светодиод микрофона отображает текущее состояние режима «Без звука».

Светодиод микрофона	Состояние режима «Без звука»
Красный	Режим «Без звука» выключен
Выключен	Режим «Без звука» включен



Использование с ПК или компьютером Mac

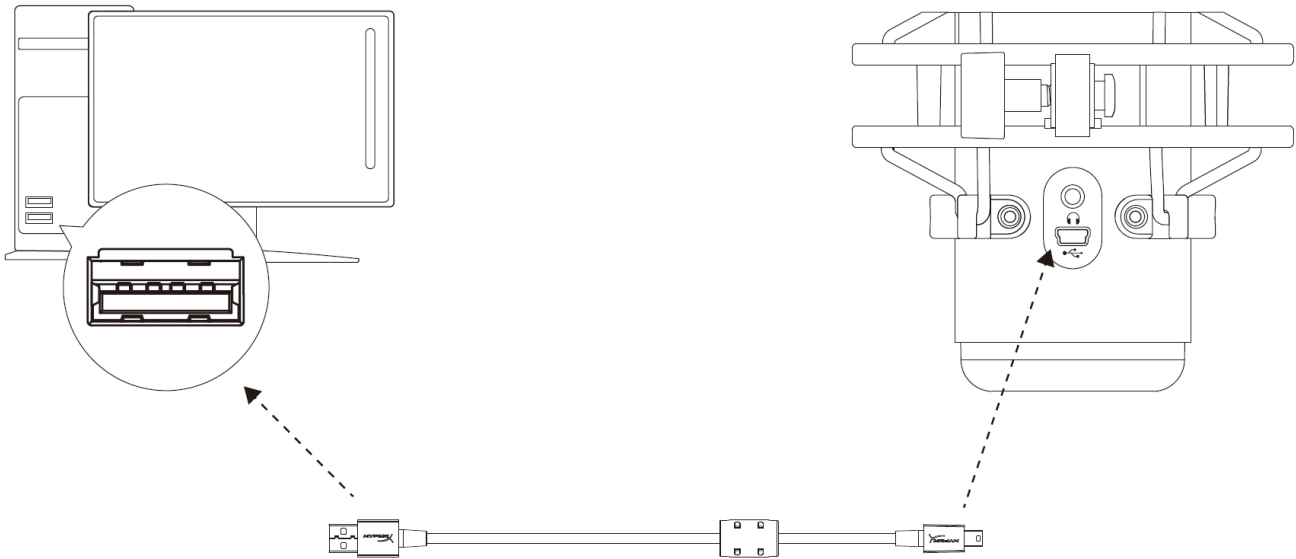

Подключите микрофон к USB-порту ПК или компьютера Mac с помощью прилагаемого USB-кабеля.

Windows

Чтобы обеспечить правильную настройку микрофона на ПК, выполните следующие действия:

1. Щелкните правой кнопкой мыши значок звука в системном трее и выберите **Sounds** (Звуки).

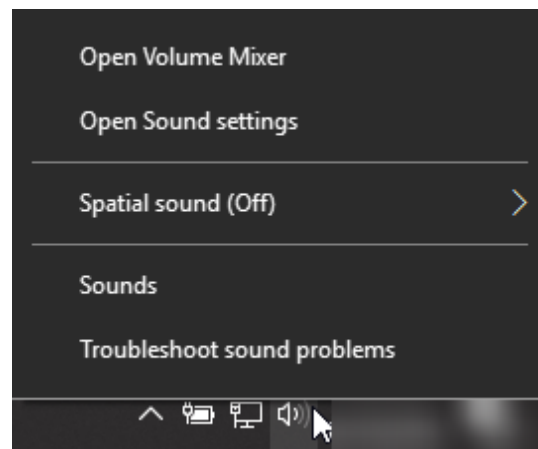



2. На вкладке *Playback* (*Воспроизведение*) выберите **Speakers HyperX QuadCast** (**Аудиоколонки HyperX QuadCast**) и нажмите кнопку **Set Default** (**Установить по умолчанию**).

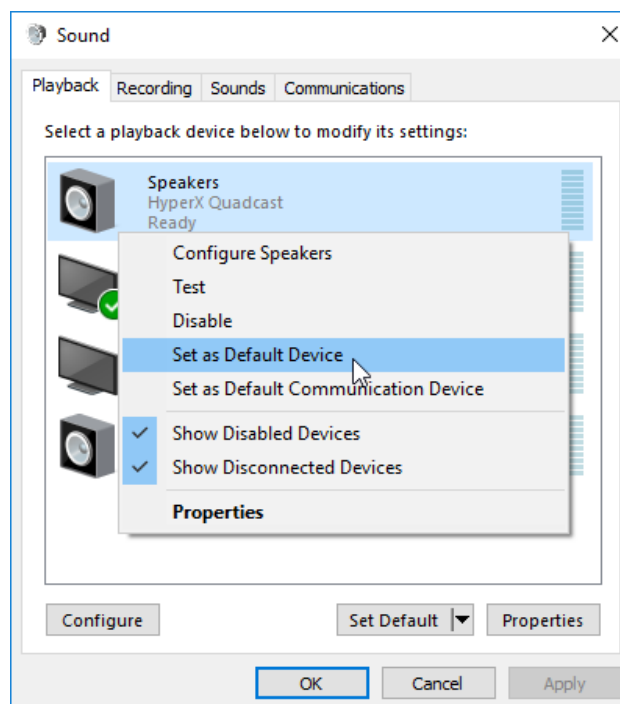

3. На вкладке *Recording* (*Запись*) выберите **Microphone HyperX QuadCast** (**Микрофон HyperX QuadCast**) и нажмите кнопку **Set Default** (**Установить по умолчанию**).

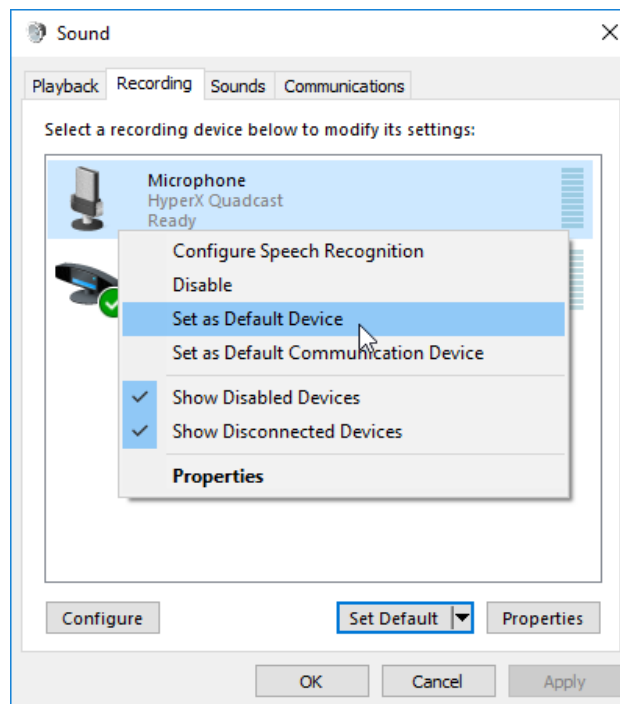



macOS

Чтобы обеспечить правильную настройку микрофона в macOS, выполните следующие действия:

1. Откройте меню **System Preferences** (Системные настройки) и выберите **Sound** (Звук).

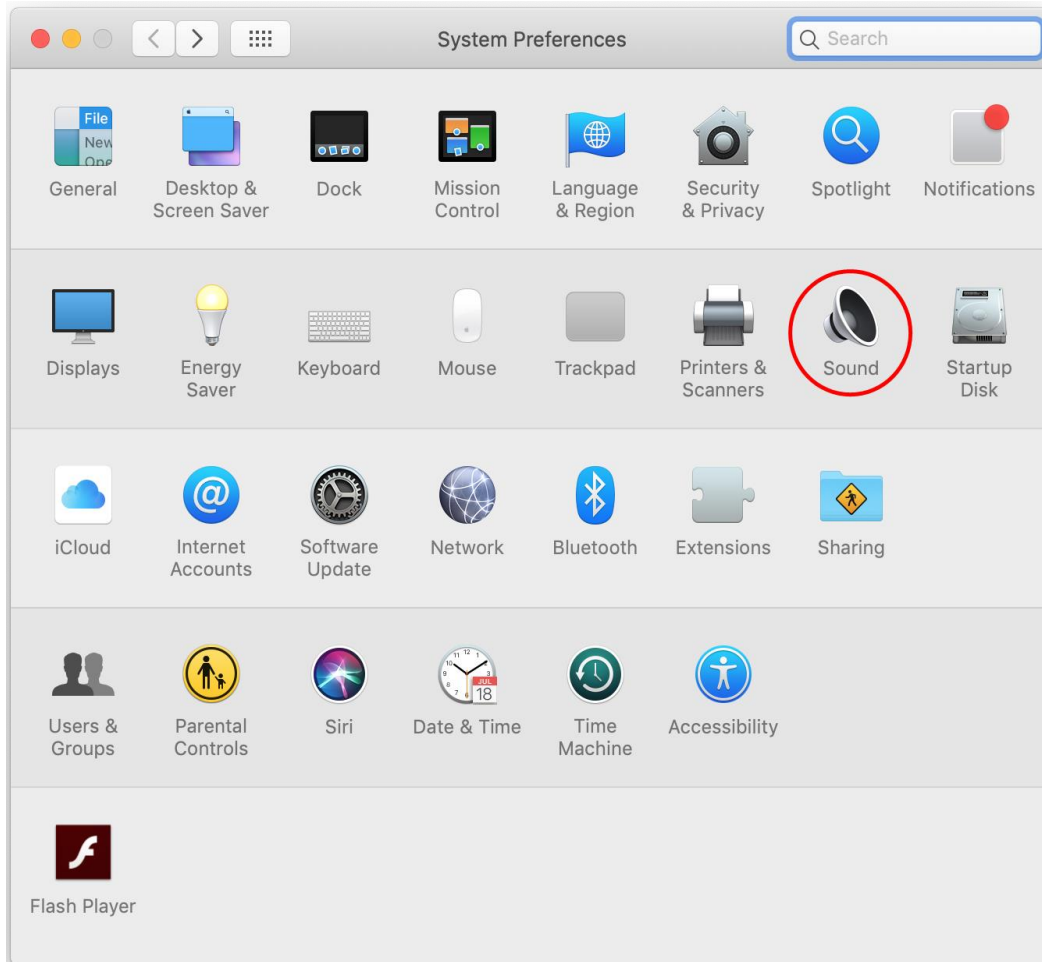



2. На вкладке *Output* (Выход) выберите **HyperX QuadCast**.

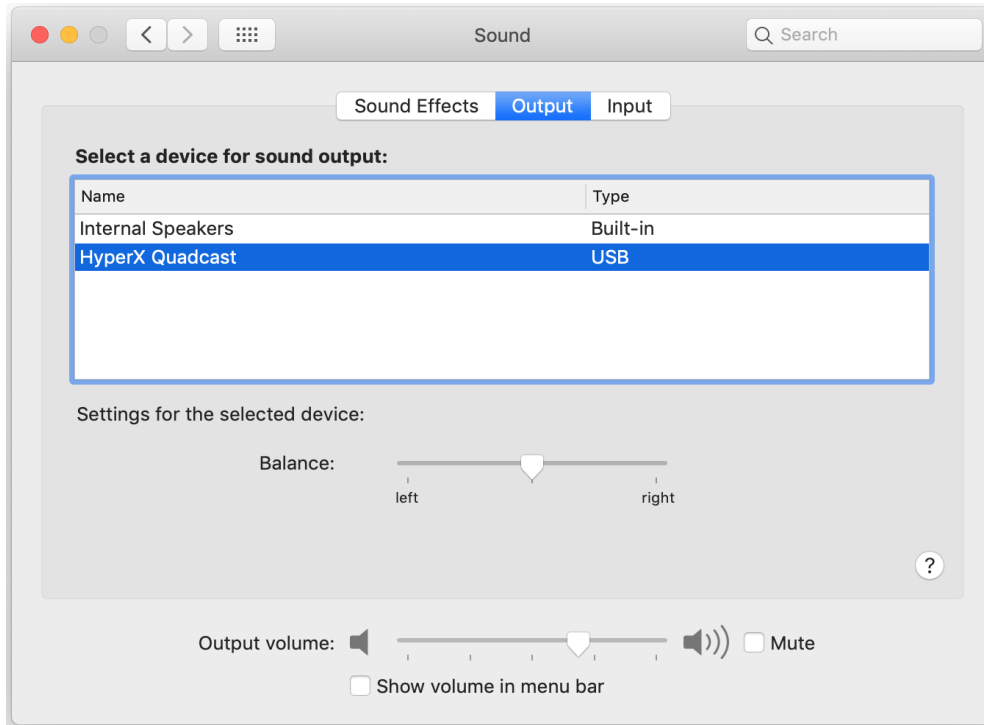

3. На вкладке *Input* (Вход) выберите **HyperX QuadCast**.

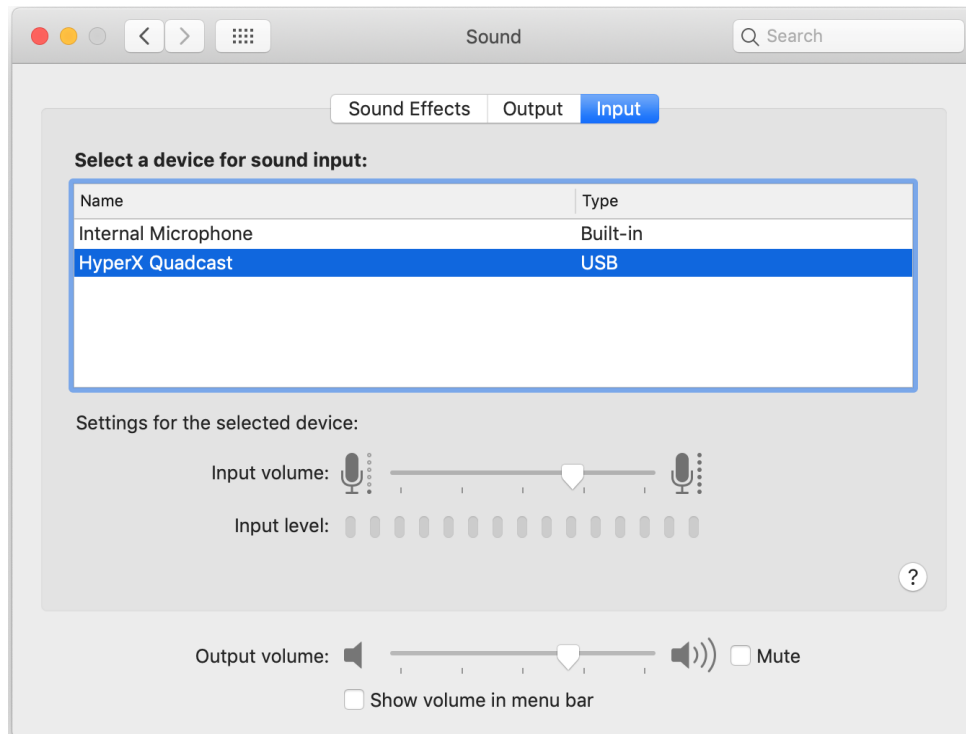



Использование с PS4™

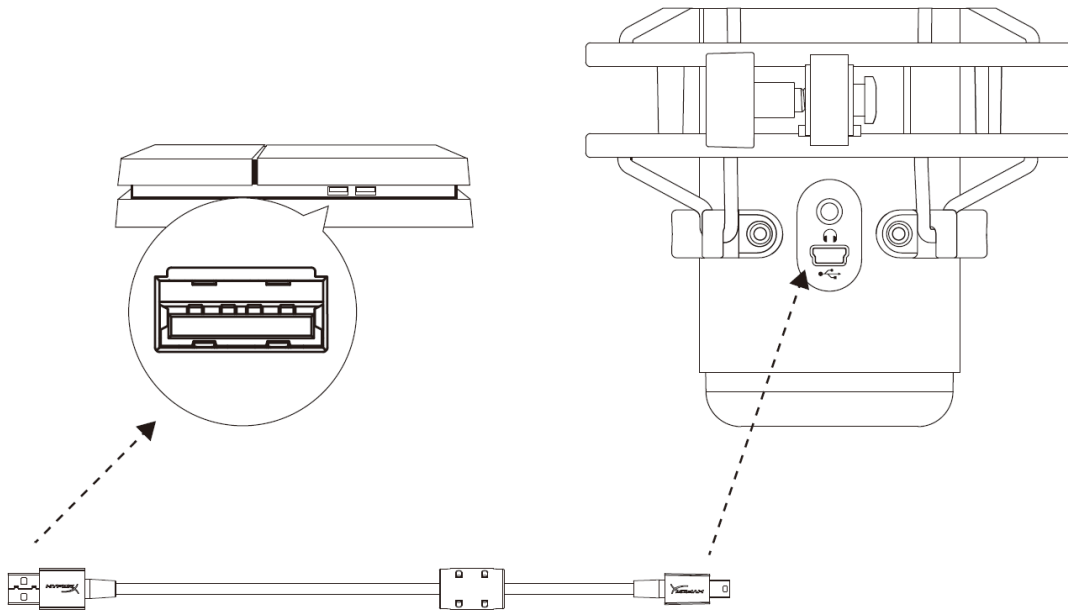

Подключите микрофон к USB-порту PS4 с помощью прилагаемого USB-кабеля.

Чтобы настроить наиболее оптимальные для PS4 параметры микрофона, выполните следующие действия:

1. Из основного меню PS4 перейдите в раздел **Settings (Настройки) > Devices (Устройства) > Audio Devices (Аудиоустройства)**.
2. Установите для параметра *Input Device* (Входное устройство) значение **USB Headset (HyperX QuadCast) (USB-гарнитура (HyperX QuadCast))**.
3. Установите для параметра *Output Device* (Выходное устройство) значение **USB Headset (HyperX QuadCast) (USB-гарнитура (HyperX QuadCast))**.
4. Установите для параметра *Output to Headphones* (Выход на наушники) значение **All Audio (Звук полностью)**.
5. Установите нужную громкость на регуляторе *громкости (наушниках)*.

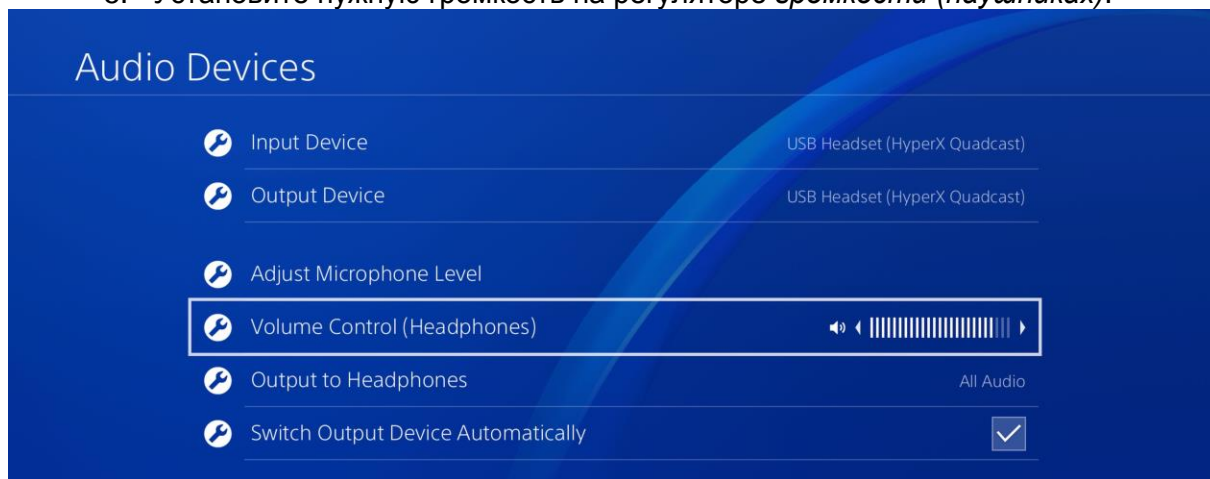



Подключение наушников

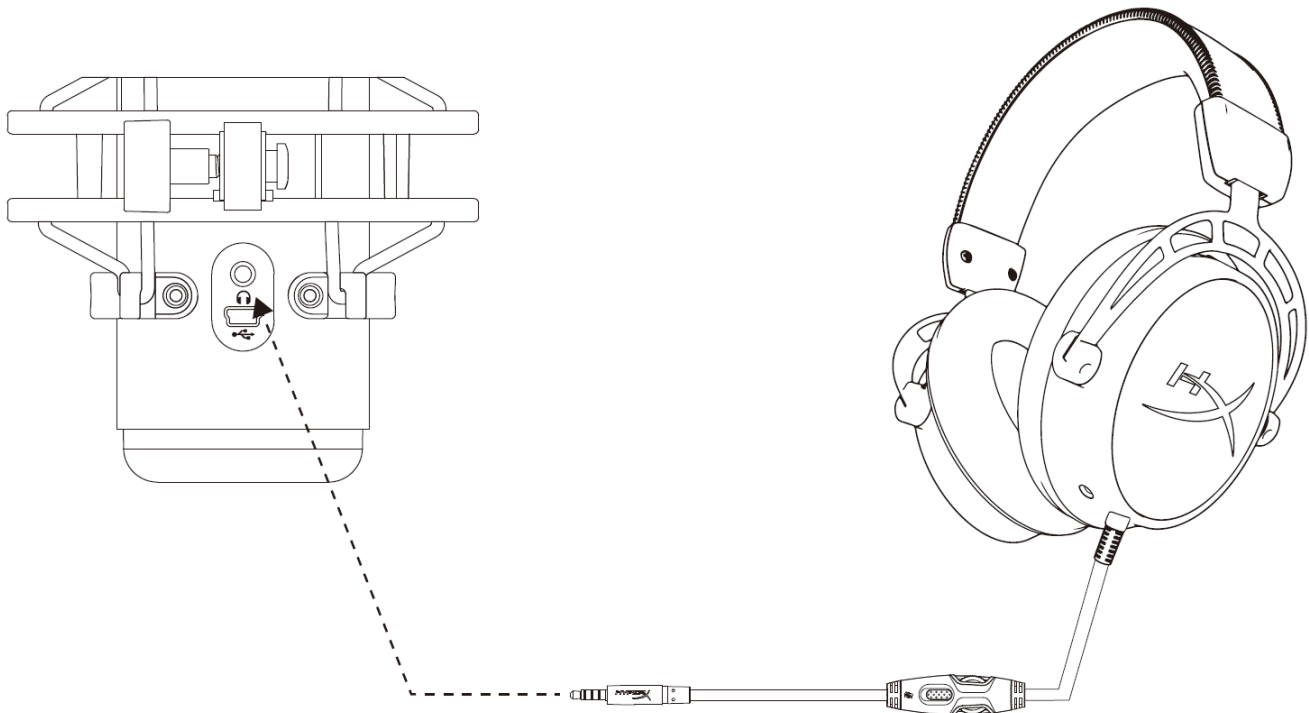

Подключите наушники к разъему для наушников на микрофоне для мониторинга микрофона и воспроизведения звука.



Управление регистрацией данных микрофона

PC

1. С панели управления звуком перейдите на вкладку *Playback* (Воспроизведение), щелкните правой кнопкой мыши элемент **Speakers HyperX QuadCast** (Динамики HyperX QuadCast) и выберите **Properties** (Свойства).

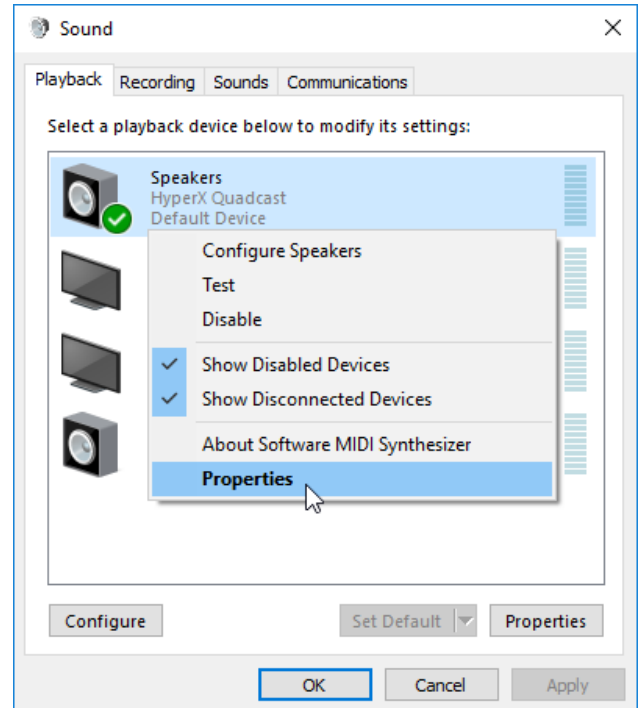

2. Перейдите на вкладку *Levels* (Уровни) и отрегулируйте ползунок громкости **Microphone** (Микрофон), чтобы настроить уровень мониторинга микрофона.

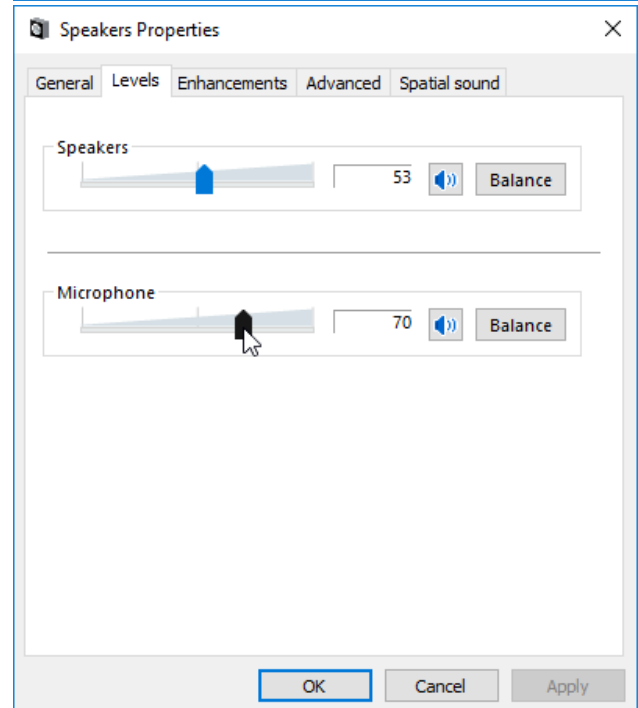



macOS

1. Откройте приложение **Finder** и перейдите в **Applications (Приложения) > Utilities (Утилиты) > Audio MIDI Setup (Настройка MIDI-интерфейса аудио)**

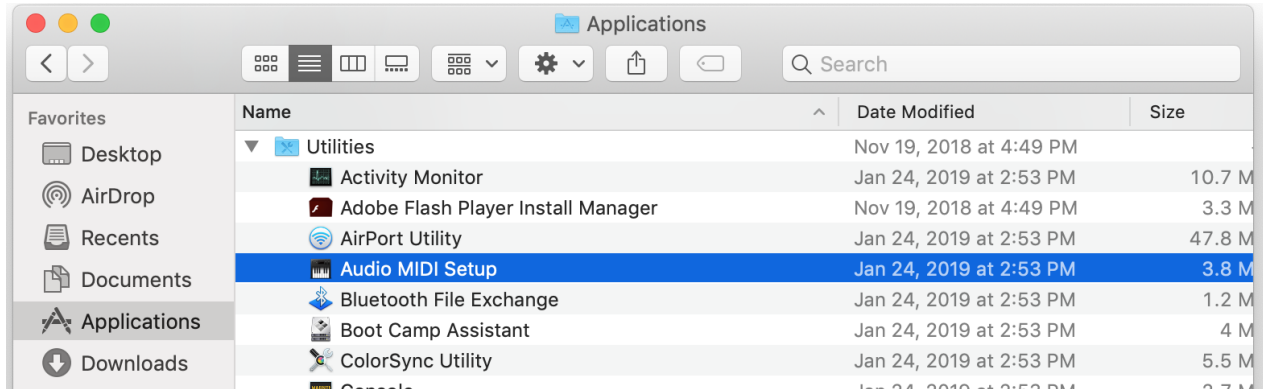

2. Нажмите на **HyperX QuadCast 2** и установите флажок под столбцом *Thru*, чтобы включить или выключить регистрацию данных микрофона.

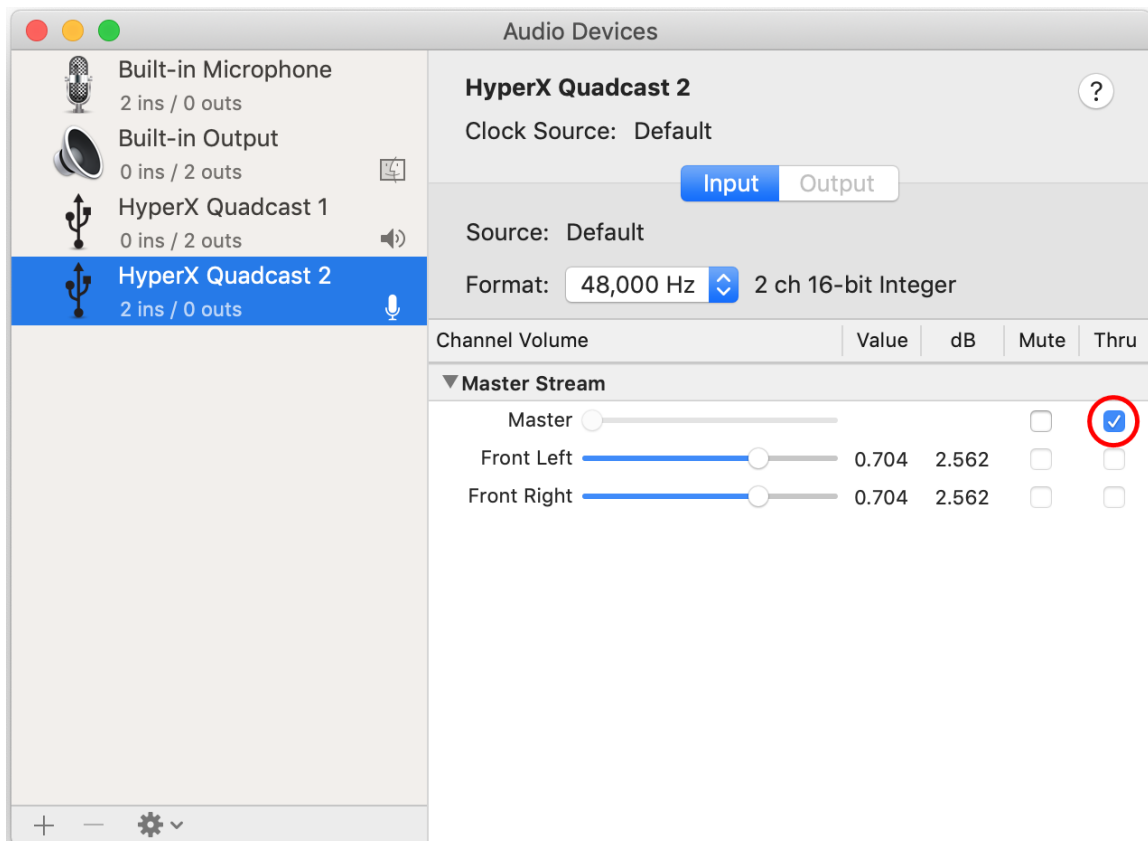

PS4

На PS4 нельзя напрямую управлять уровнем регистрации данных микрофона.



Установка переходника крепления

1. Прикрепите прилагаемый переходник к микрофонной стойке. Переходник подходит для резьбы размеров 3/8" и 5/8".
2. Снимите винт с накатанной головкой и гайку с подставки для микрофона.
3. Снимите микрофон с подставки.
4. Совместите переходник с отверстиями для крепления микрофона и закрепите переходник винтом с накатанной головкой и гайкой.



Вопросы или проблемы с настройкой?

Свяжитесь с командой технической поддержки HyperX: hyperxgaming.com/support/



HyperX QuadCast[™]



Parça Numaraları

HX-MICQC-BK



İÇİNDEKILER

Genel Görünüm	3
Teknik özellikler	4
Mikrofon Kontrolleri	5
PC veya Mac ile kullanım	7
PS4™ ile kullanım.....	11
Kulaklık Bağlantıları	12
Mikrofon İzleme Denetimi	13
Montaj Adaptörünün Kurulumu.....	15



Genel Görünüm

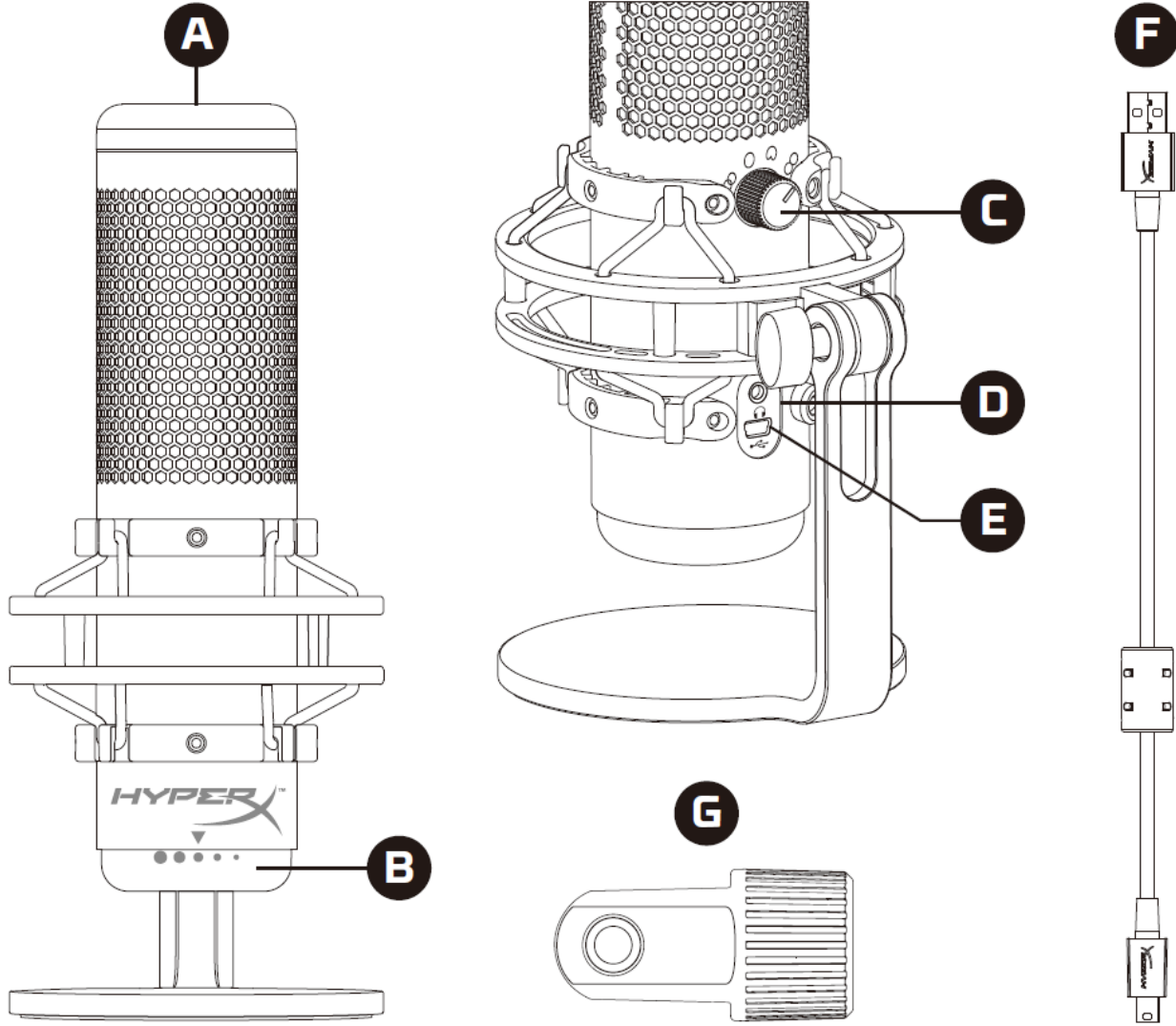

- A. Dokunarak Sessize Alma Sensörü
- B. Kazanım Denetimi Düğmesi
- C. Kutup Düzeni Düğmesi
- D. Kulaklık Jaki
- E. USB Kablosu Bağlantı Noktası
- F. USB Kablosu
- G. Montaj Adaptörü*

*Hem 3/8" hem de 5/8" diş boyutlarını destekler



Teknik özellikler

Mikrofon

Güç tüketimi: 5 V 125 mA

Örnekleme/bit hızı: 48 kHz/16 bit

Eleman: Elektret kondenser mikrofon

Bağlantı tipi: Üç adet 14 mm kondenser

Kutup düzeni: Stereo, Heryönlü, Kardiyoit, İki yönlü

Frekans yanıtı: 20 Hz – 20 kHz

Hassasiyet: -36 dB (1 V/Pa, 1 kHz'de)

Kablo uzunluğu: 3 m

Ağırlık:

- Mikrofon: 254 g
- Darbe emici aparat ve stand: 364 g
- USB kabloyla birlikte toplam ağırlık: 710 g

Kulaklık Çıkışı

Empedans: 32 Ω

Frekans yanıtı: 20 Hz - 20 kHz

Maksimum güç çıkışı: 7 mW

THD: \leq %0,05 (1 kHz/0 dBFS)

SNR: \geq 90 dB (1 kHz, RL= ∞)



Mikrofon Kontrolleri

Kutup Düzeni Seçimi

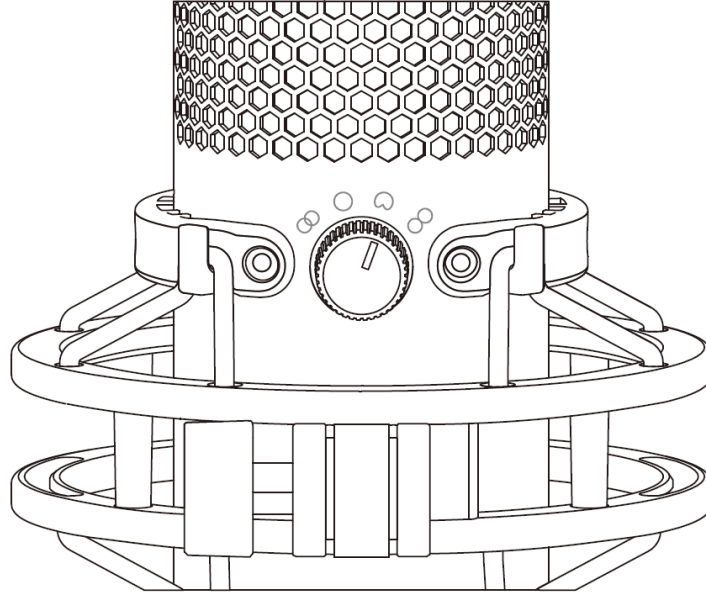

Dört kutup düzeninden birini seçmek için kutup düzeni düğmesini döndürün.

Simge	Ses Yönü	Kutup Düzeni	Senaryolar
		Stereo	Vokaller, enstrümanlar
		Heryönlü	Birden fazla kişinin yer aldığı podcast'ler, konferans görüşmeleri
		Kardioit	Podcast'ler, yayın yapma, seslendirmeler, enstrümanlar
		İki yönlü	Yüz yüze görüşmeler



Kazanım Denetimi Ayarı

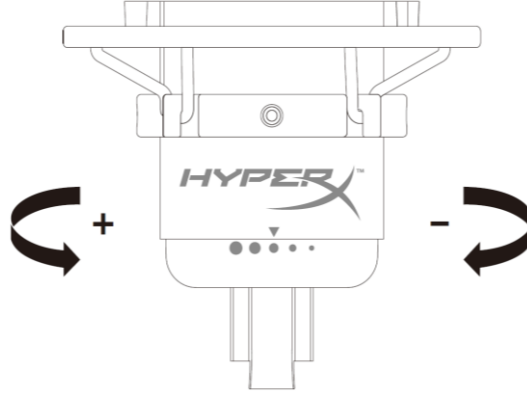

Mikrofon kazanımını ayarlamak için mikrofon kazanımı düğmesini döndürün.

Mikrofonu Sessize Alma

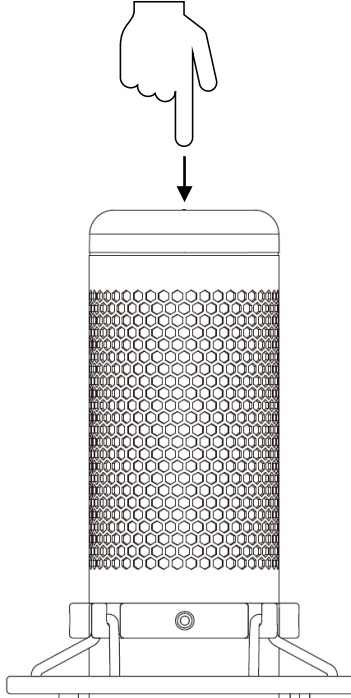

Mikrofonu sessize almak veya sesini açmak için mikrofonun üst kısmına dokununuz. Mikrofon LED'i, mikrofonun geçerli ses durumunu gösterir.

Mikrofon LED'i	Sessizde Olma Durumu
Kırmızı	Sessize alma kapalı
Kapalı	Sessize alma açık



PC veya Mac ile kullanım

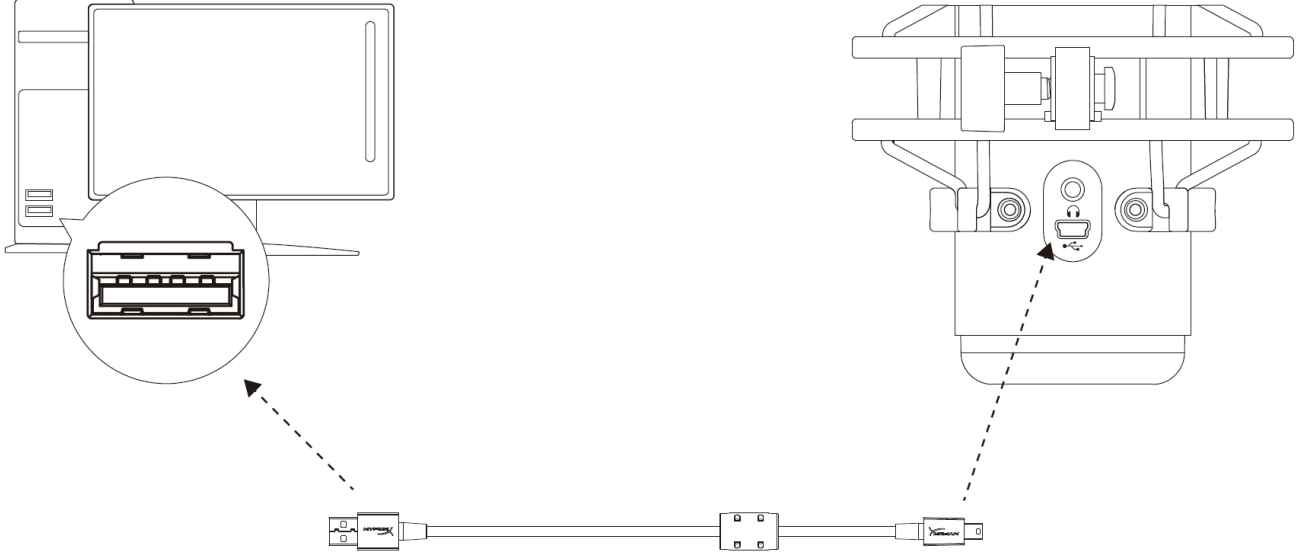

Mikrofonun USB kablosunu kullanarak mikrofonu PC veya Mac'teki USB bağlantı noktasına bağlayın.

Windows

Mikrofonun, PC'de doğru bir biçimde yapılandırıldığından emin olmak için aşağıdaki adımları uygulayın:

1. Sistem tepsisindeki ses simgesine sağ tıklayıp **Sesler** ögesini seçin.

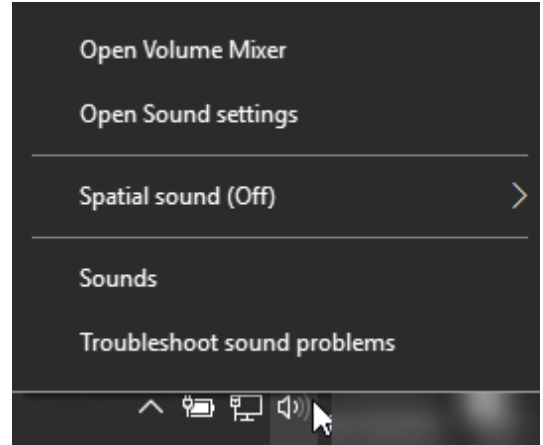



2. *Oynatma* sekmesinde, **Hoparlörler HyperX QuadCast** öğesini seçin ve **Varsayılan Olarak Ayarla** düğmesine tıklayın.

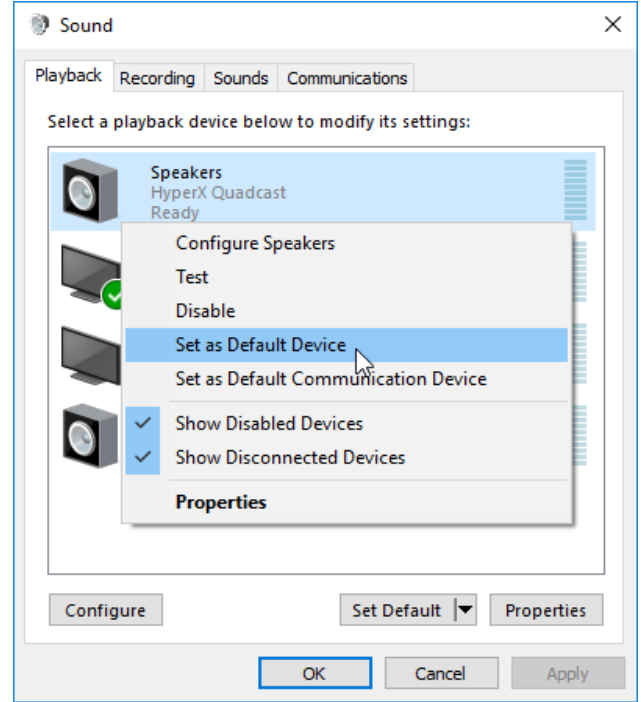

3. *Oynatma* sekmesinde, **Mikrofon HyperX QuadCast** öğesini seçin ve **Varsayılan Olarak Ayarla** düğmesine tıklayın.

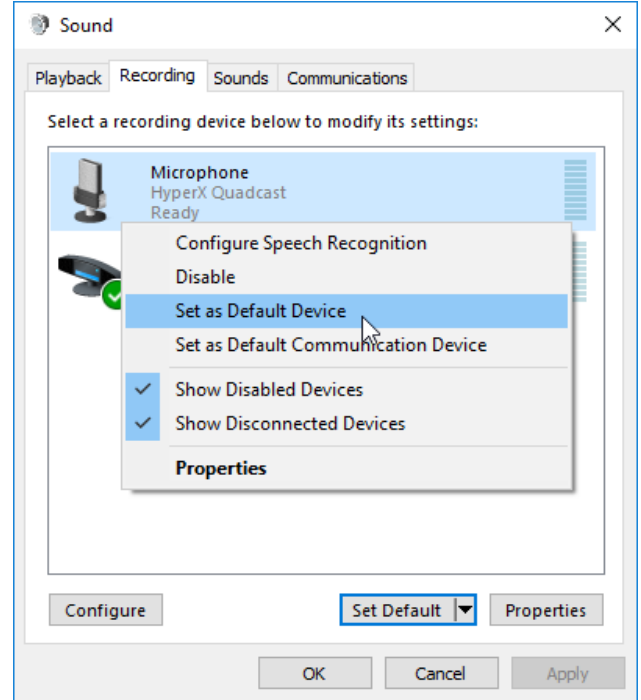



macOS

Mikrofonun, macOS'ta doğru bir biçimde yapılandırıldığından emin olmak için aşağıdaki adımları uygulayın:

1. **Sistem Tercihleri** menüsünden **Ses** bölümünü açın.

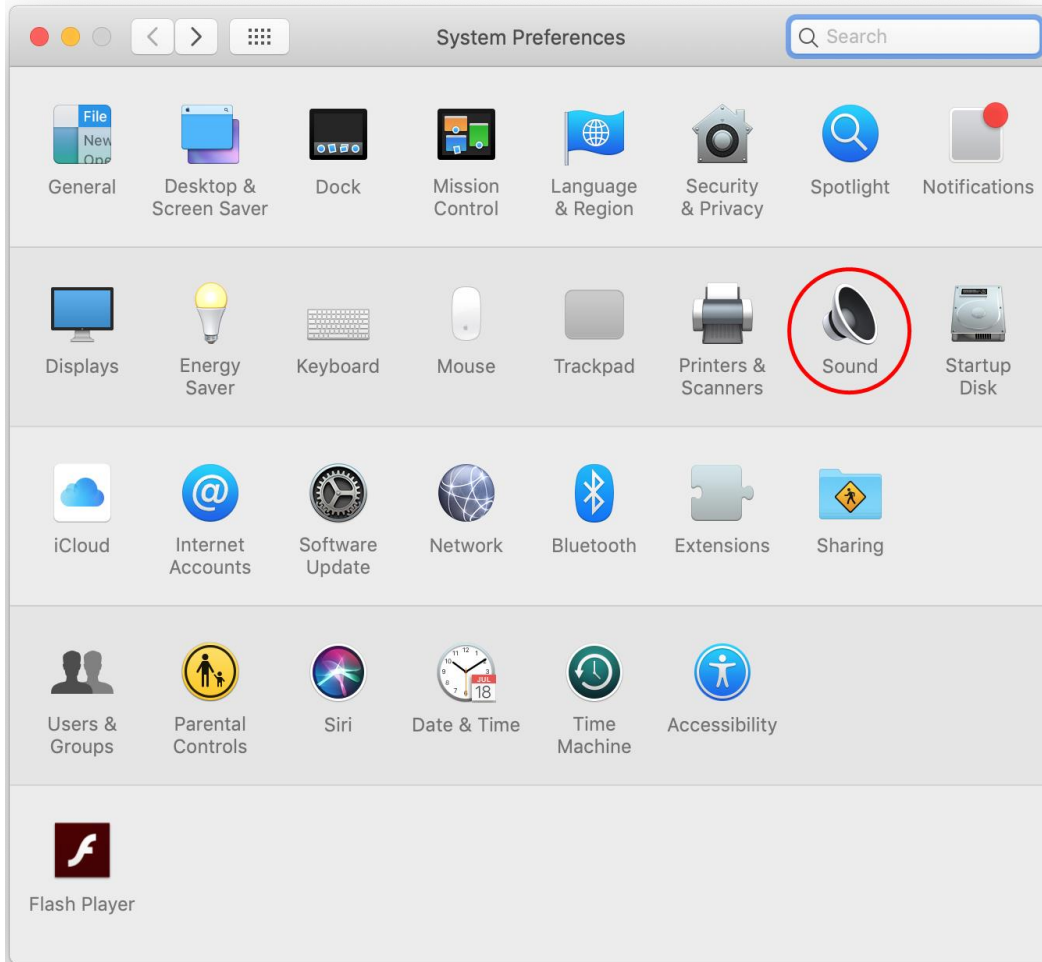



2. *Çıkış* sekmesinden **HyperX QuadCast**'i seçin.

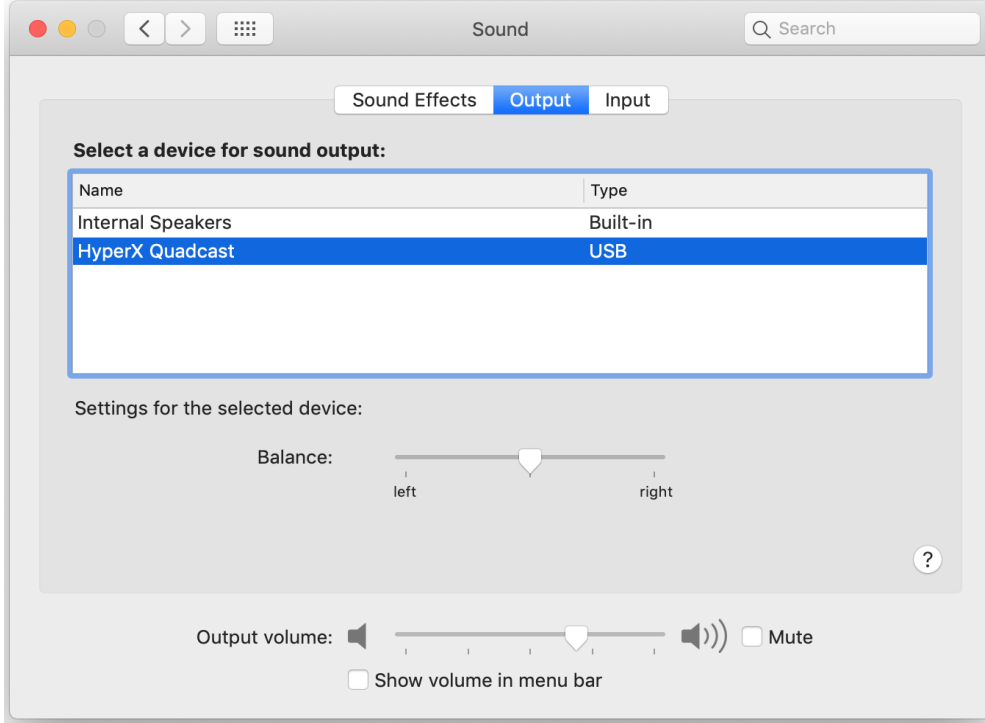

3. *Giriş* sekmesinden **HyperX QuadCast**'i seçin.

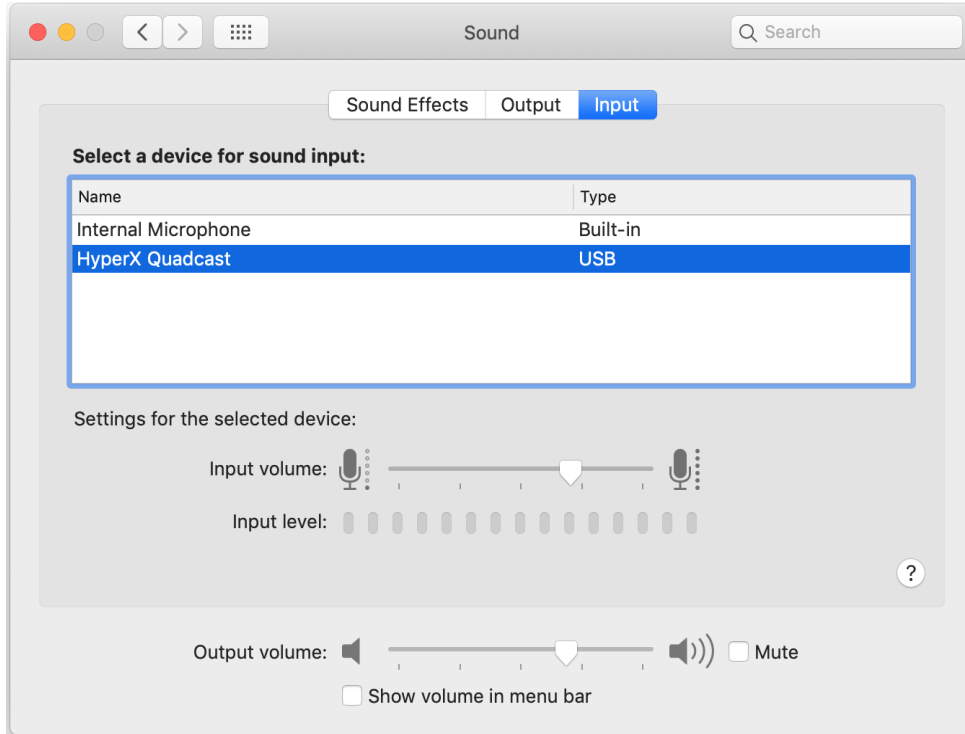



PS4™ ile kullanım

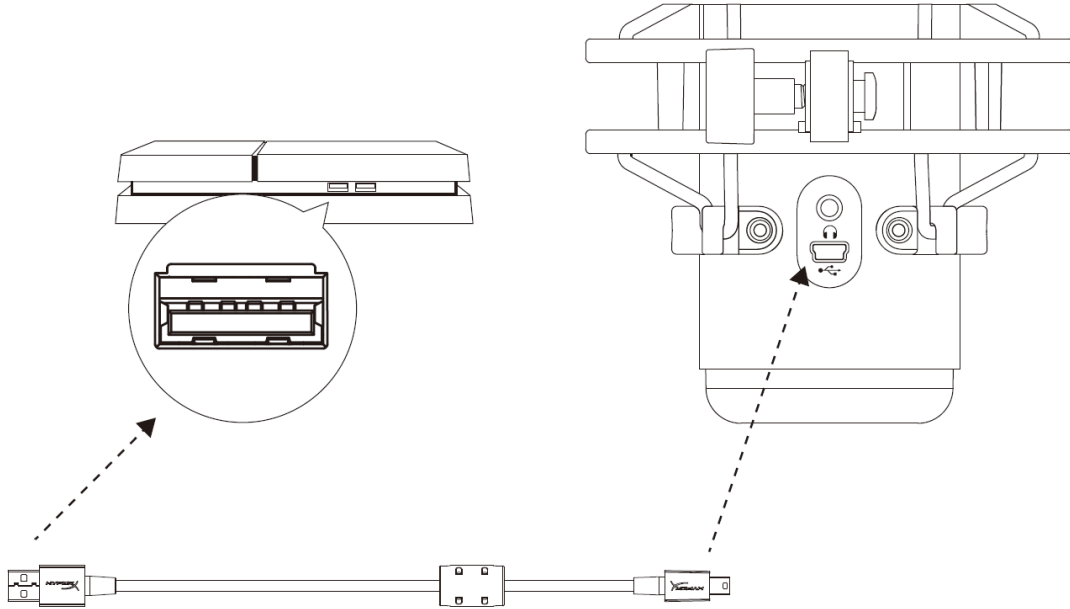

Mikrofonun USB kablosunu kullanarak mikrofonu PS4'teki USB bağlantı noktasına bağlayın.

Mikrofonun, PS4'teki en iyi ayarlarla yapılandırıldığından emin olmak için aşağıdaki adımları uygulayın:

1. PS4 ana menüsünden şu yolu izleyin: **Ayarlar > Cihazlar > Ses Cihazları**
2. *Giriş Cihazı* için şu seçimi yapın: **USB Kulaklık (HyperX QuadCast)**
3. *Çıkış Cihazı* için şu seçimi yapın: **USB Kulaklık (HyperX QuadCast)**
4. *Kulaklığa Çıkış Ver* için şu seçimi yapın: **Tüm Ses**
5. *Ses Kontrolü (Kulaklıklar)* istediğiniz şekilde ayarlayın

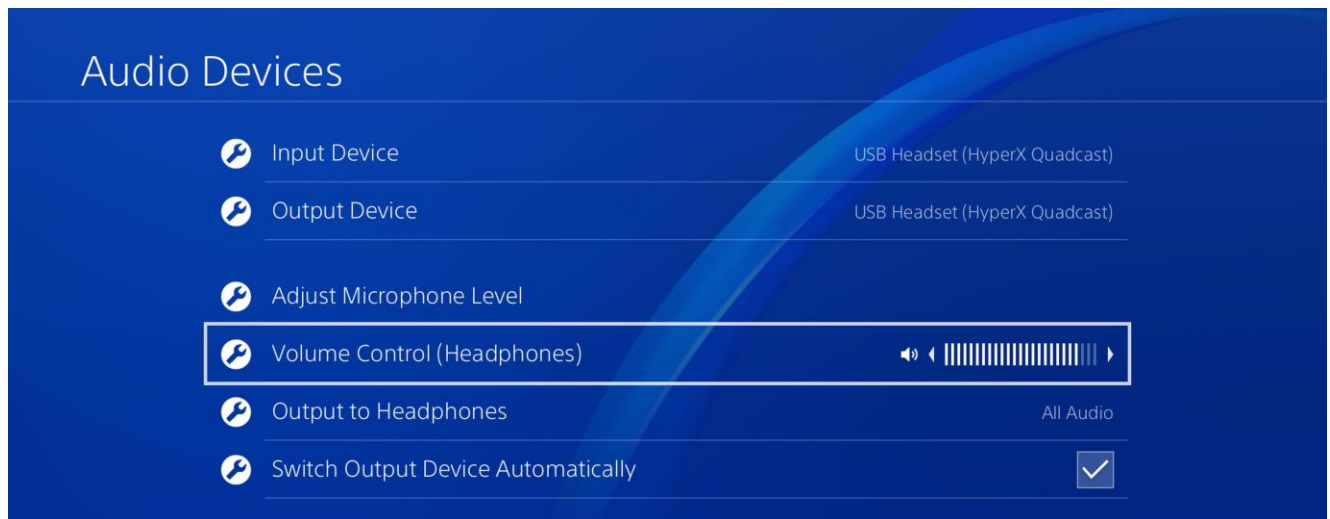



Kulaklık Baęlantıları

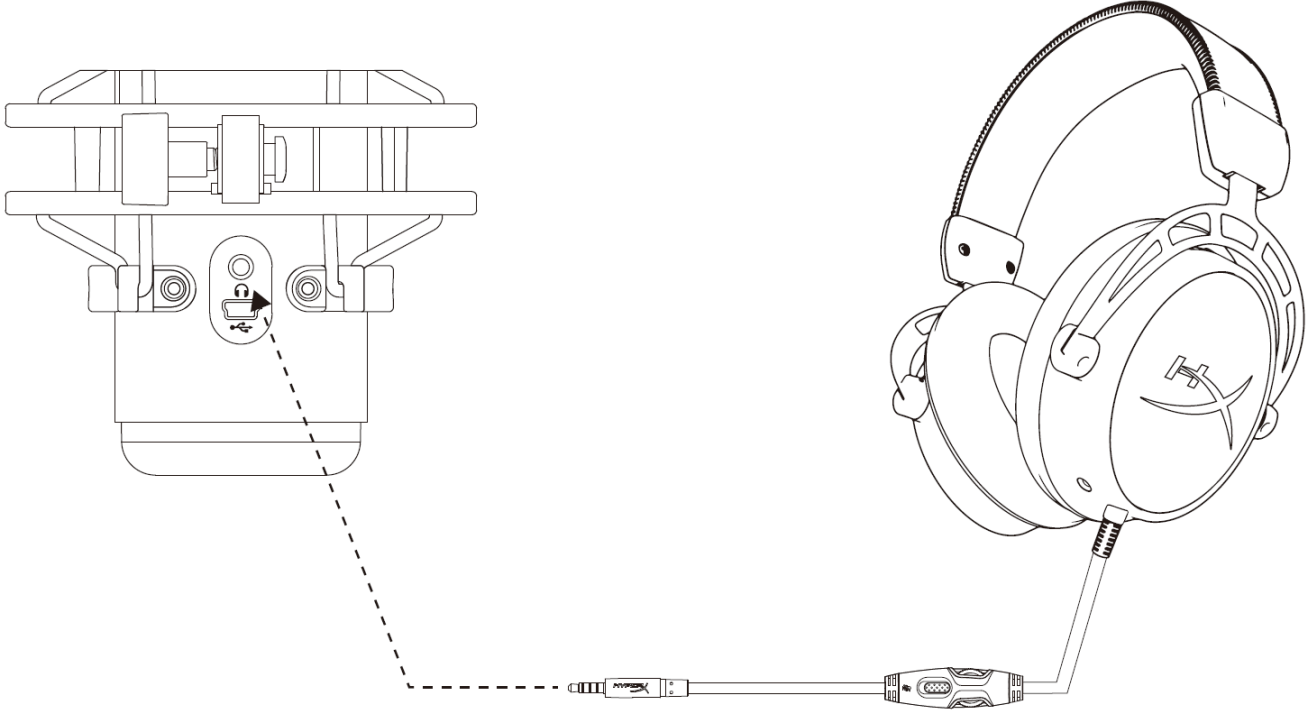

Mikrofon izleme ve ses oynatma için, kulaklıęı mikrofondaki kulaklık jakına baęlayın.



Mikrofon İzleme Denetimi

PC

1. Ses kontrol panelinden *Oynatma* sekmesine gelin, **Hoparlör HyperX QuadCast'e** sağ tıklayın ve **Özellikler'i** seçin.

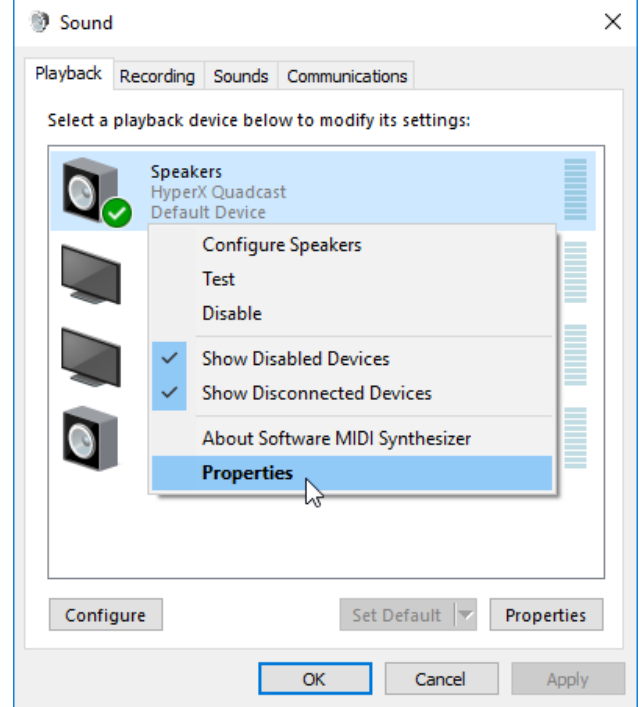

2. *Seviyeler* sekmesinde, **Mikrofon** ses seviyesi kaydırmalı düğmesinden mikrofon izleme seviyesini ayarlayın.

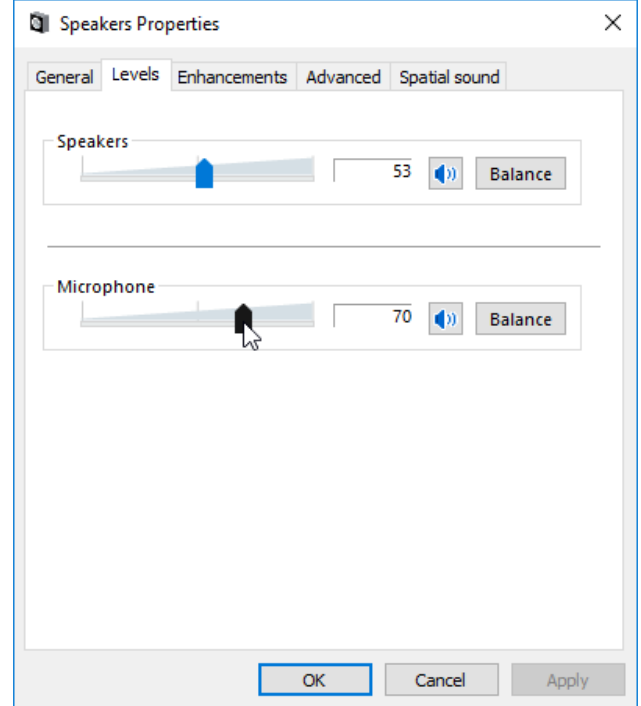



macOS

1. Finder'dan **Applications > Utilities > Audio MIDI Setup** menü yolunu takip edin.

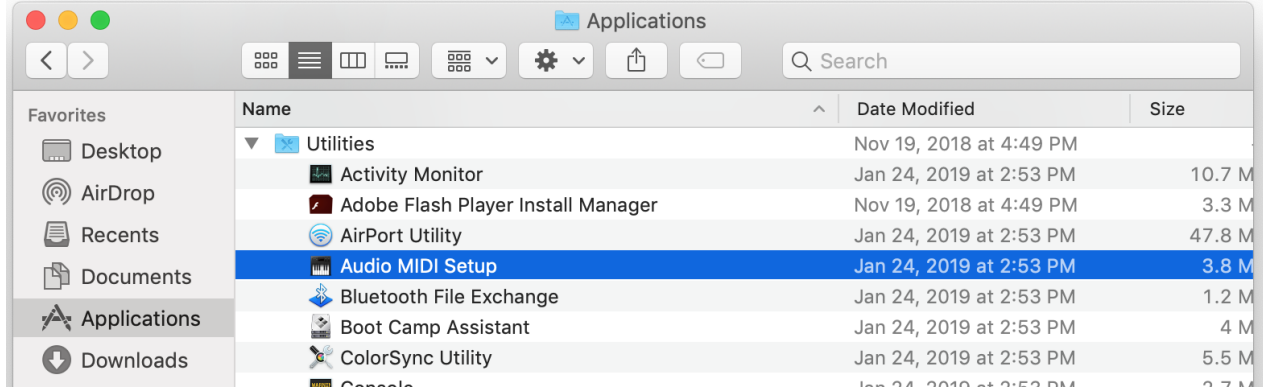

2. **HyperX QuadCast 2**'ye tıklayın ve mikrofon izlemeyi açıp kapatmak için Thru sütununun altındaki onay kutusuna tıklayın.

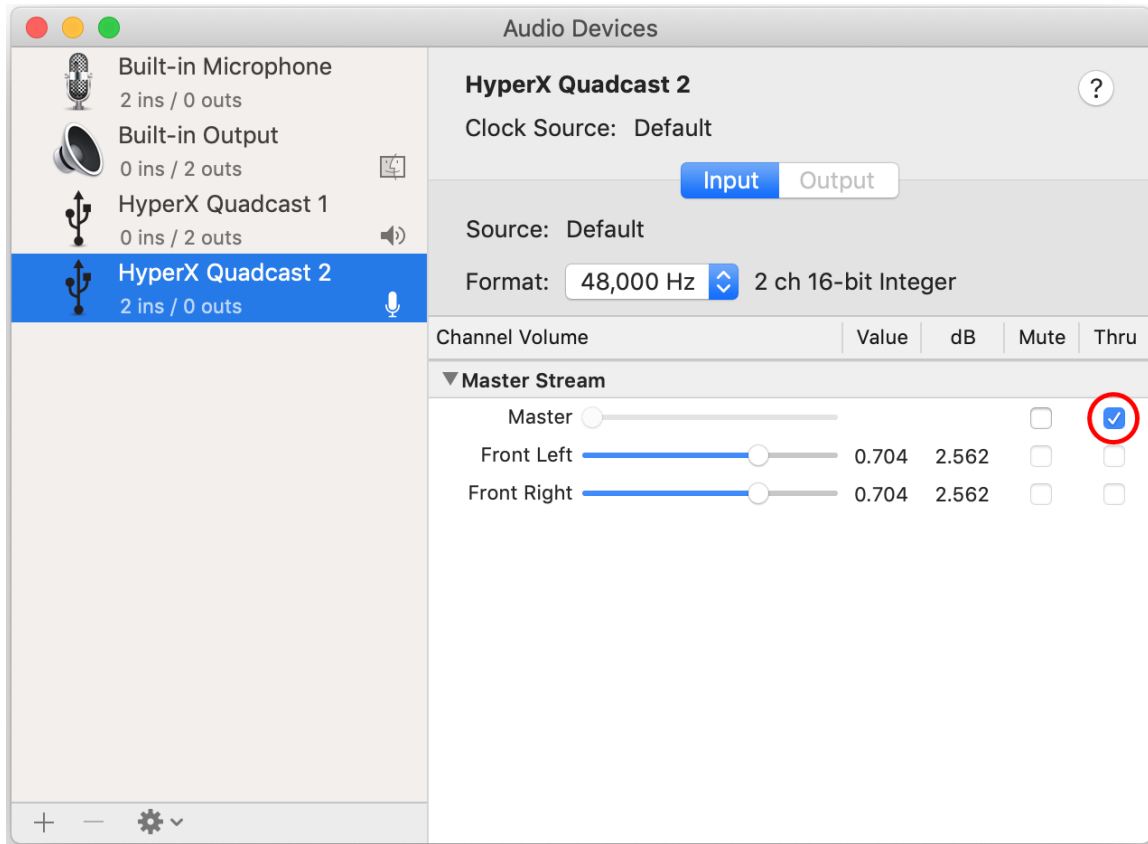

PS4

Mikrofon izleme seviyesi doğrudan PS4 üzerinden kontrol edilemez.



Montaj Adaptörünün Kurulumu

1. Ürünle birlikte gönderilen montaj adaptörünü, mikrofon boom kolunun üzerine sabitleyin. Montaj adaptörü, hem 3/8" hem de 5/8" dış boyutlarını destekler.
2. Ayar cıvatasını ve somunu mikrofon standından çıkarın.
3. Mikrofon standını mikrofon standından sökün.
4. Montaj adaptörünü mikrofon montaj delikleriyle hizalayın ve adaptörü, ayar cıvatası ve somun ile sabitleyin.



Sorunuz mu var? Kurulum sorunları mı yaşıyorsunuz?

HyperX destek ekibi ile irtibata geçin: hyperxgaming.com/support/



HyperX QuadCast[™]



製品番号

HX-MICQC-BK



目次

概要	3
仕様	4
マイクコントロール	5
PC または Mac での使用	7
PS4™での使用	11
ヘッドホンの接続	12
マイクモニターのコントロール	13
マウントアダプターの取り付け	15



概要

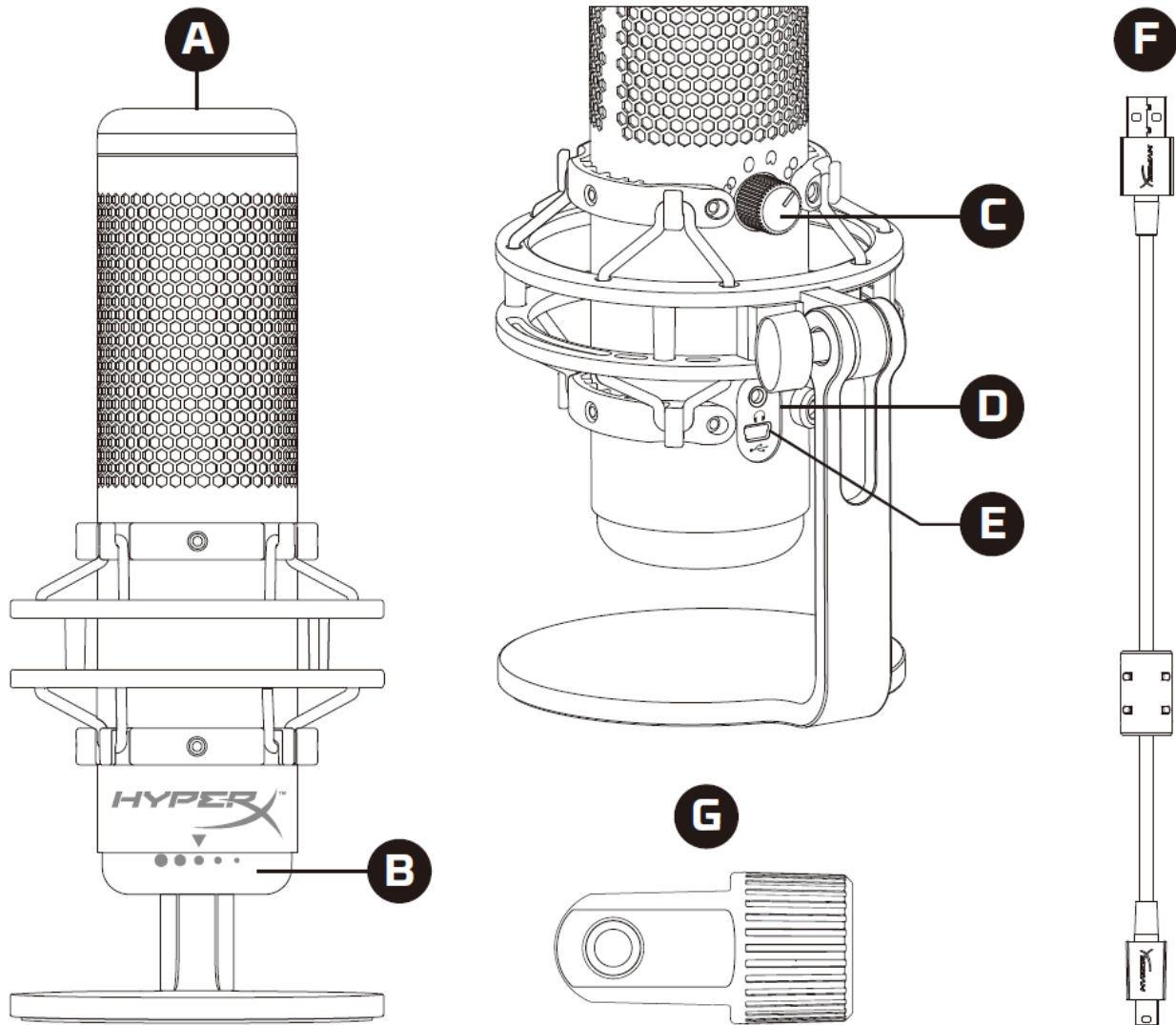

- A. タッチ式ミュートセンサー
- B. 利得制御ノブ
- C. 極性パターンノブ
- D. ヘッドホンジャック
- E. USB ケーブルポート
- F. USB ケーブル
- G. マウントアダプター*

*3/8 インチネジと 5/8 インチネジを両方のサイズをサポートします



仕様

マイク

消費電力 : 5V 125mA

サンプル/ビットレート : 48kHz/16 ビット

方式 : エレクトレットコンデンサーマイク

コンデンサータイプ : 3 個の 14mm コンデンサー

極性パターン : ステレオ、無指向、カーディオイド、双方向

周波数応答 : 20Hz - 20kHz

感度 : -36dB (1V/Pa 1kHz 時)

ケーブルの長さ : 3m

重量 :

- マイク : 254g
- 耐衝撃マウントおよびスタンド : 364g
- 合計(USB ケーブルを含む) : 710g

ヘッドホン出力

インピーダンス : 32Ω

周波数応答 : 20Hz~20kHz

最大出力 : 7mW

THD : 0.05%以下(1kHz/0dBFS)

信号対雑音比 : 90dB 以上(1kHz、RL=∞)







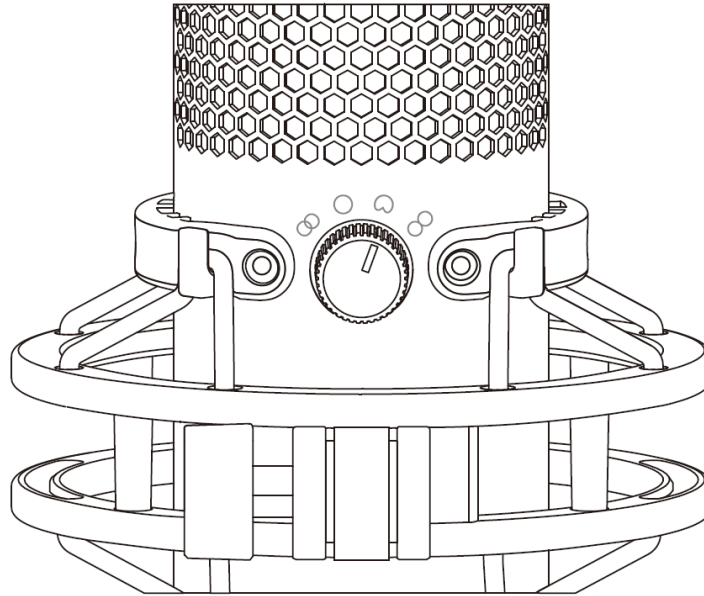

マイクコントロール

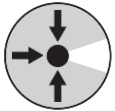
極性パターンの選択

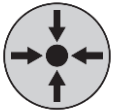

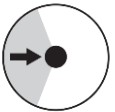
4つの極性パターンのいずれかを選ぶには、極性パターンノブを回します。

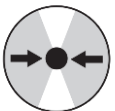
シンボル	音方向	極性パターン	シナリオ
		ステレオ	ボーカル、楽器
		無指向	複数の人間のポッドキャスト、電話会議
		カーディオイド	ポッドキャスト、ストリーミング、ナレーション、楽器
		双方向	対面のインタビュー



利得制御の調整

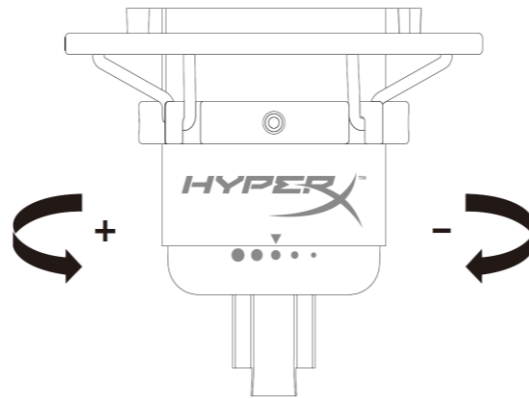

マイクの利得を調整するには利得調整ノブを回します。

マイクのミュート

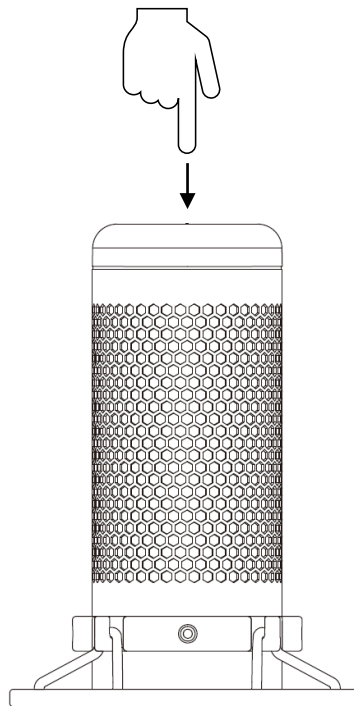

マイクをミュート/ミュート解除するには、マイクの上をタップします。マイクの現在のミュートステータスは、マイク LED に表示されます。

マイク LED	ミュートステータス
レッド	ミュートオフ
オフ	ミュートオン



PC または Mac での使用

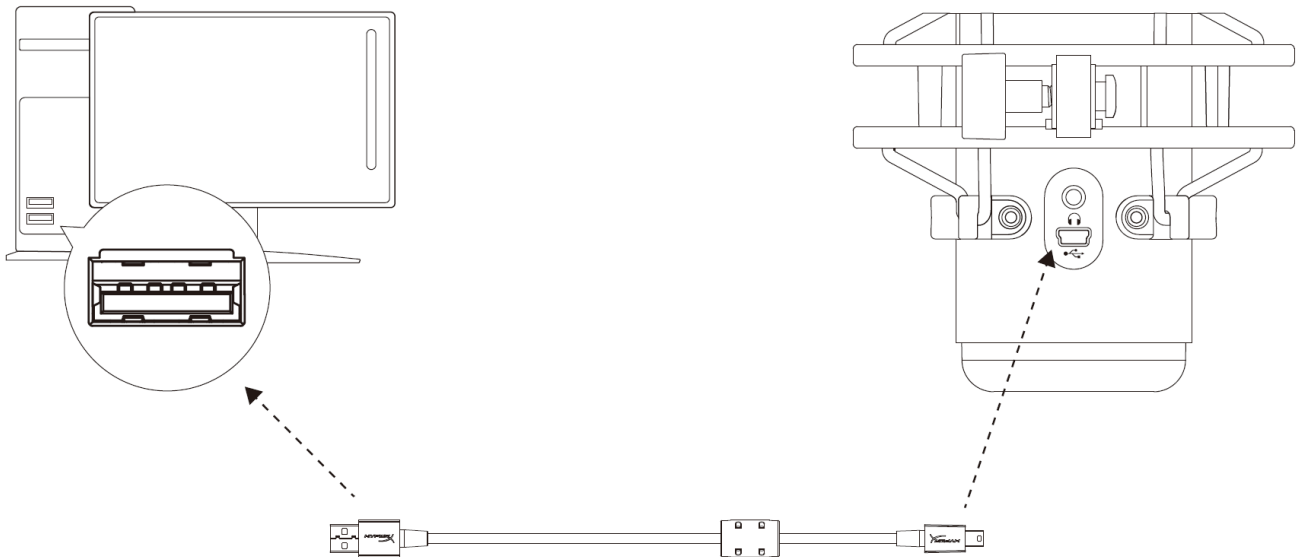

付属の USB ケーブルを使って、マイクを PC または Mac の USB ポートに接続します。

Windows

マイクを PC に適切な設定で構成するには、以下の手順を実行します。

1. システムトレイのサウンドアイコンを右クリックし、[サウンド]を選択します。

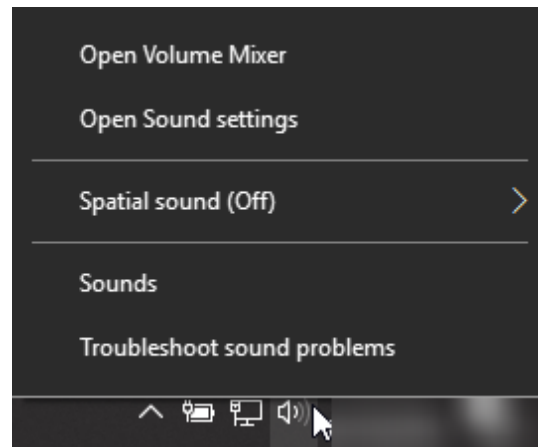



2. [再生]タブで[Speakers HyperX QuadCast]を選択し、[既定値に設定]ボタンをクリックします。

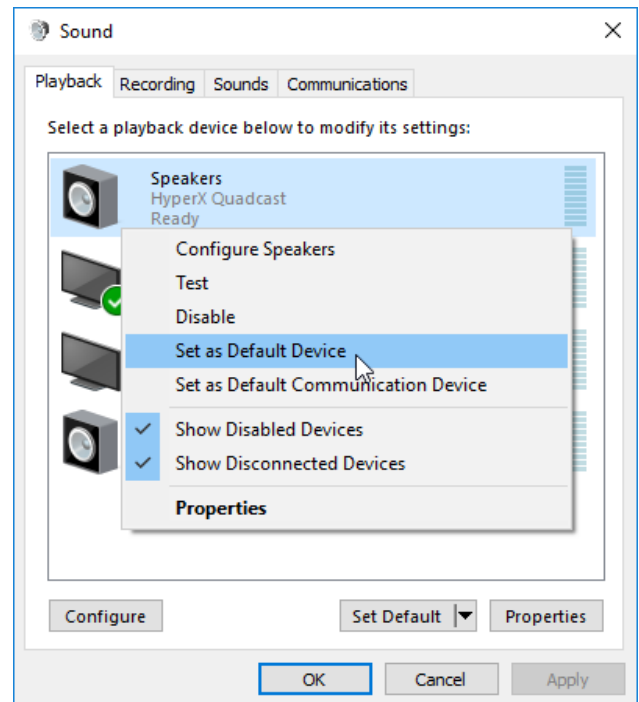

3. [録音]タブで[Microphone HyperX QuadCast]を選択し、[既定値に設定]ボタンをクリックします。

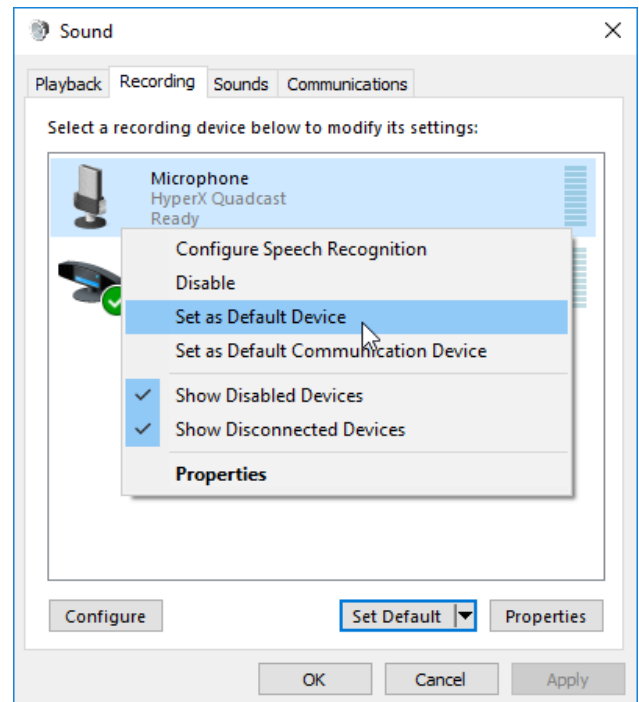



macOS

マイクを macOS の適切な設定で構成するには、以下の手順を実行します。

1. 「システム環境設定」を開き、「サウンド」を選択します。

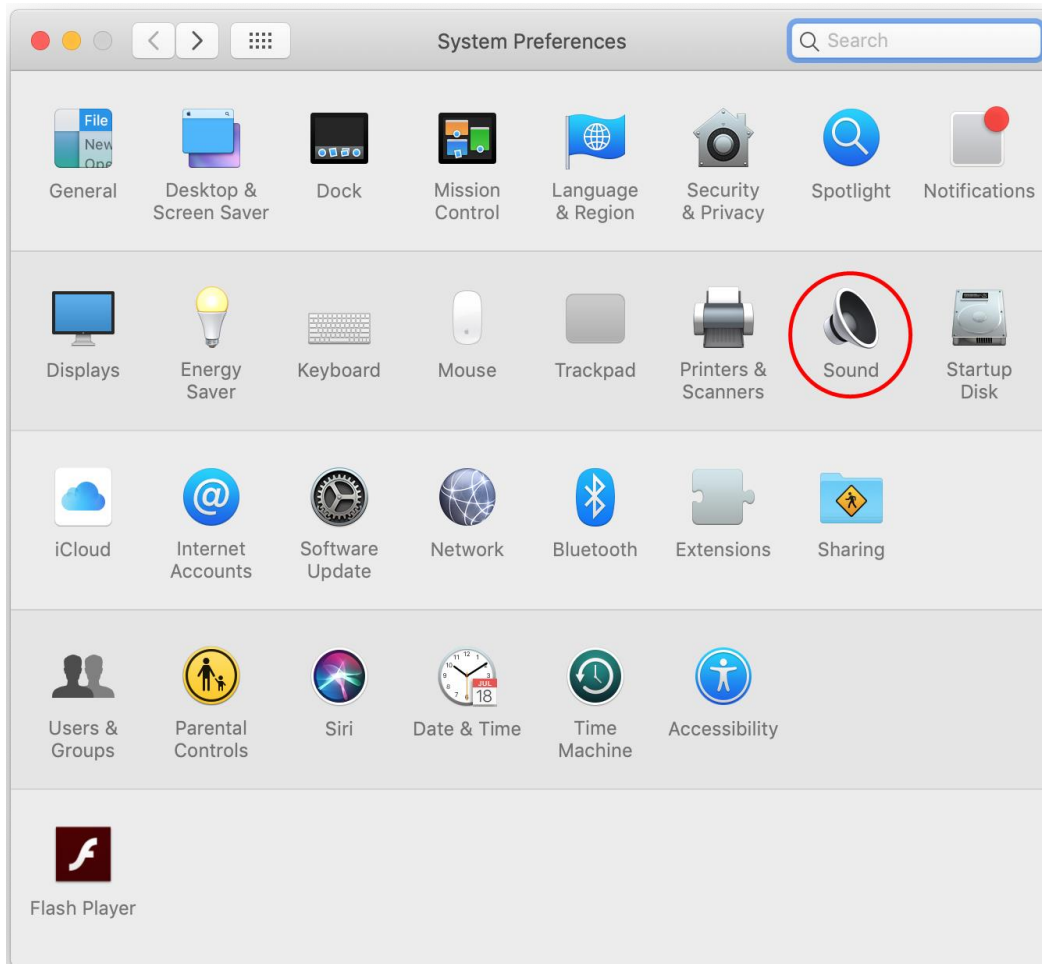



2. 「出力」タブで「HyperX QuadCast」を選択します。

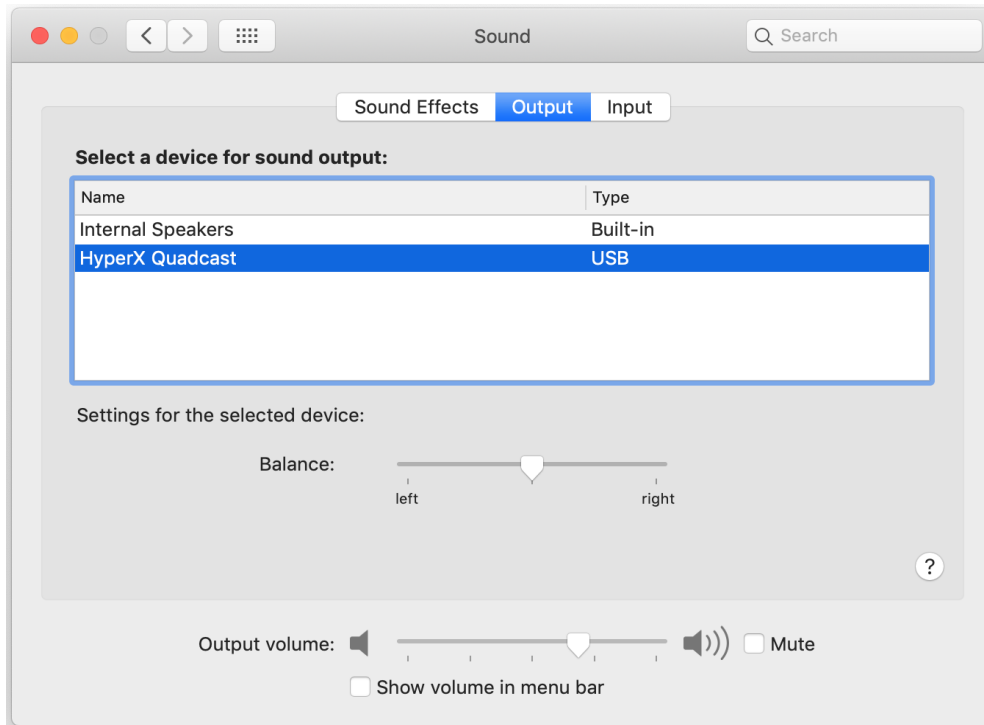

3. 「入力」タブで「HyperX QuadCast」を選択します。

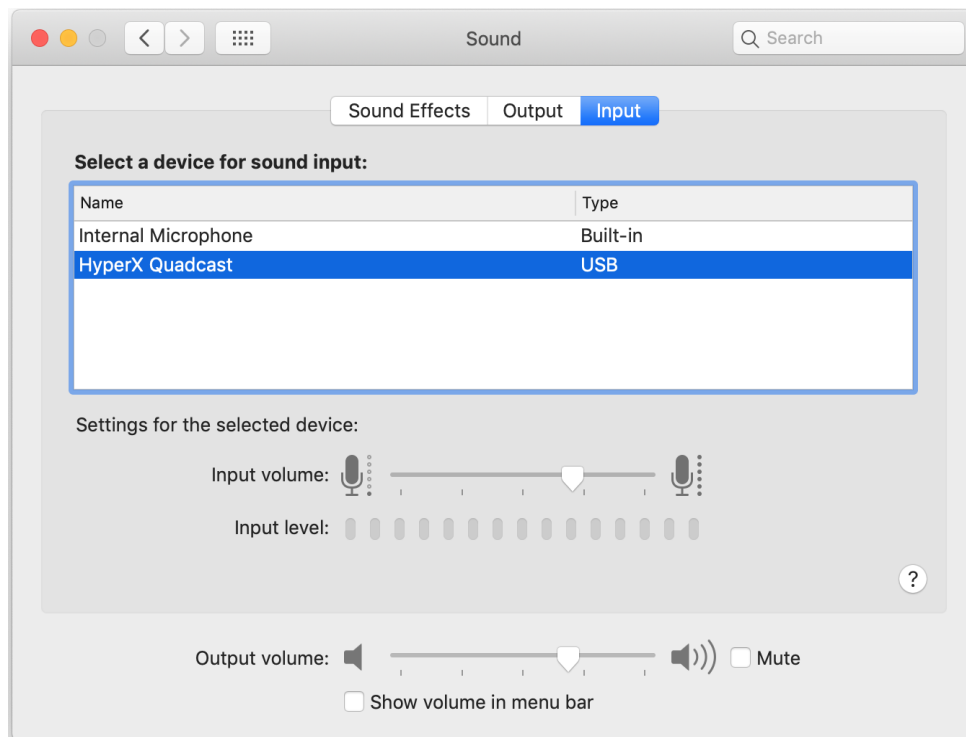



PS4[™]での使用

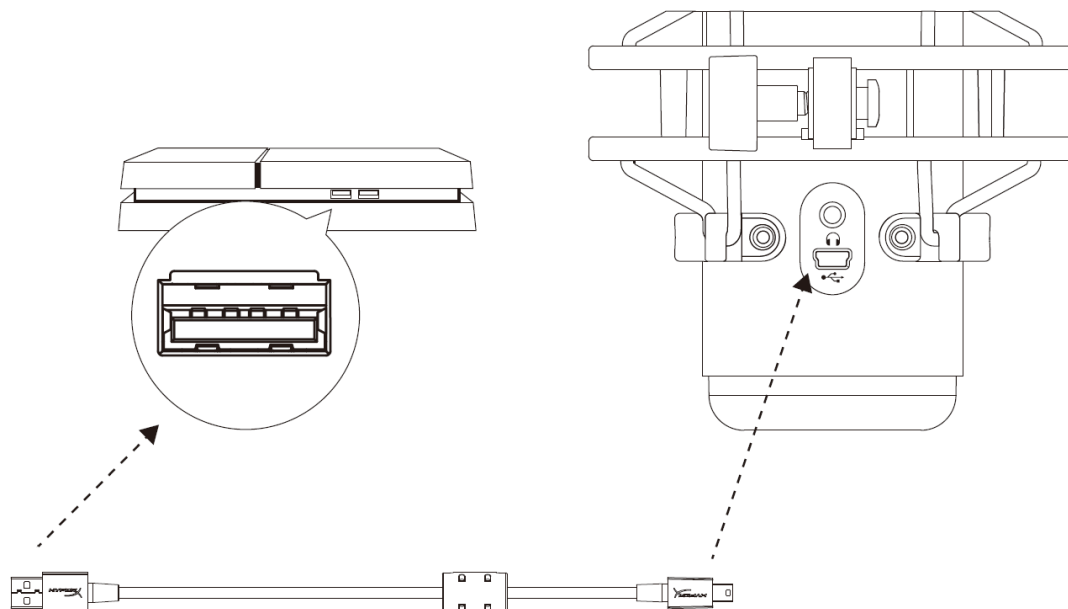

付属の USB ケーブルを使って、マイクを PS4 の USB ポートに接続します。

マイクを PS4 に最適な設定で構成するには、以下の手順を実行します。

1. PS4 のメインメニューから**[設定]>[周辺機器]>[オーディオ機器]**に移動します
2. **[入力機器]**に**[USB Headset (HyperX QuadCast)]**を設定します
3. **[出力機器]**に**[USB Headset (HyperX QuadCast)]**を設定します
4. **[ヘッドホンへの出力]**に**[すべての音声]**を設定します
5. **音量コントロール(ヘッドホン)**を必要な音量に設定します

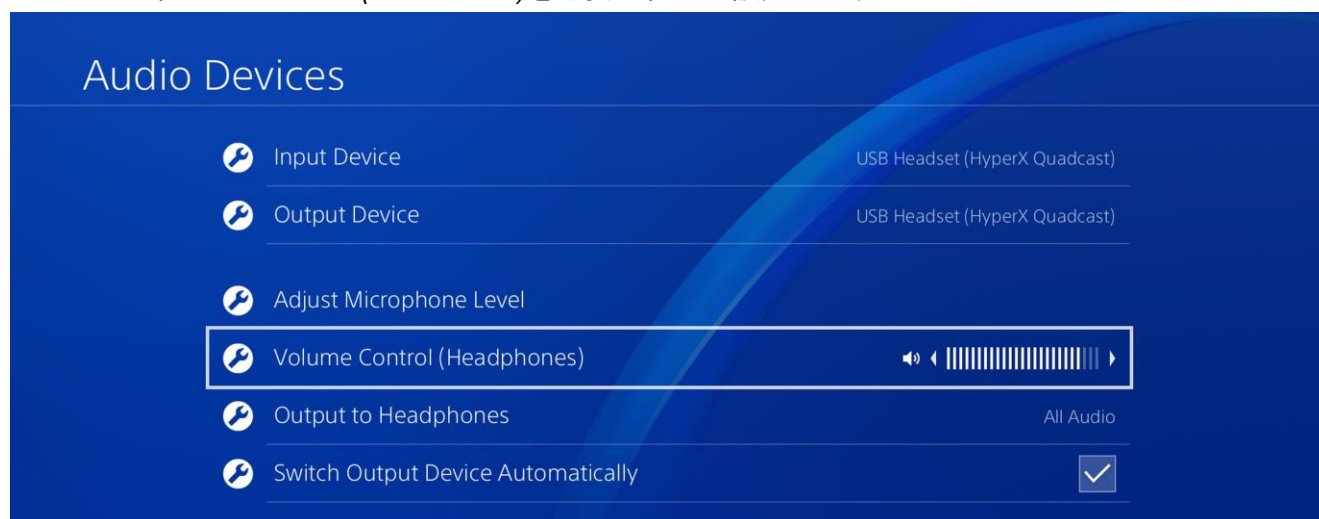



ヘッドホンの接続

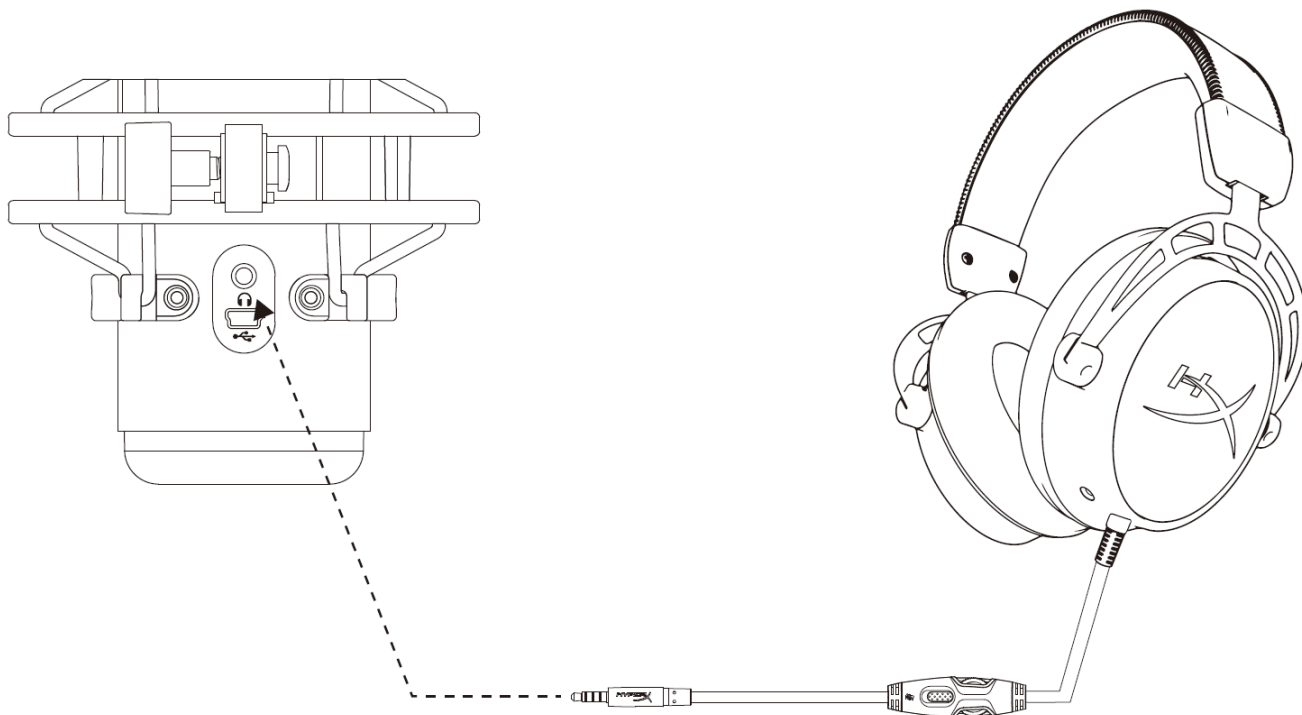

マイクをモニターし、音声を再生するには、ヘッドホンをヘッドホンジャックに接続します。



マイクモニターのコントロール

PC

1. [サウンド]コントロールパネルの[再生]タブで[Speakers HyperX QuadCast]を右クリックし、[プロパティ]：を選択します。
2. [レベル]タブで[マイク]の音量スライダーを調節し、マイクのモニターレベルを調節します。

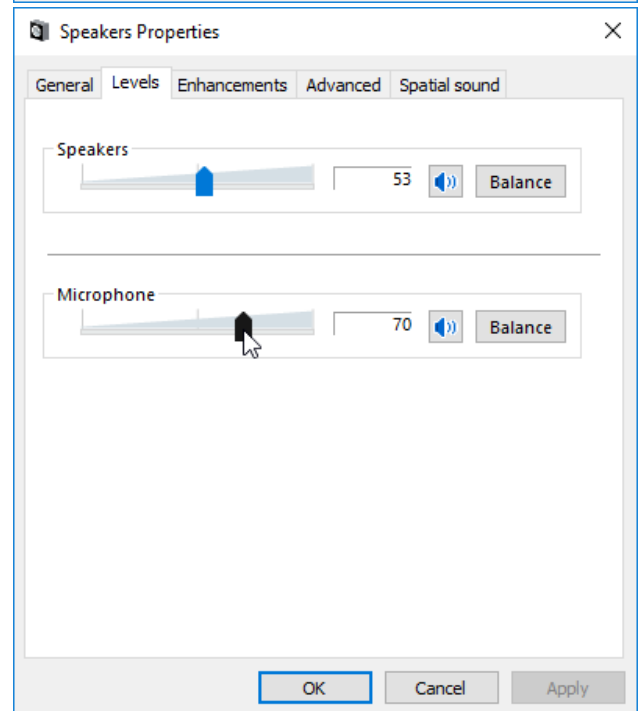
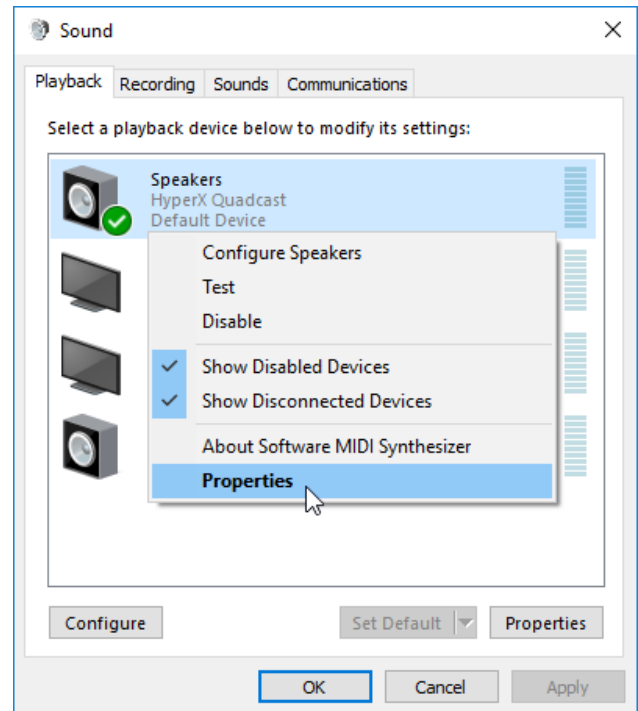



macOS

1. Finder アプリを開き、「アプリケーション」の「ユーティリティ」にある「Audio MIDI 設定」に移動します。

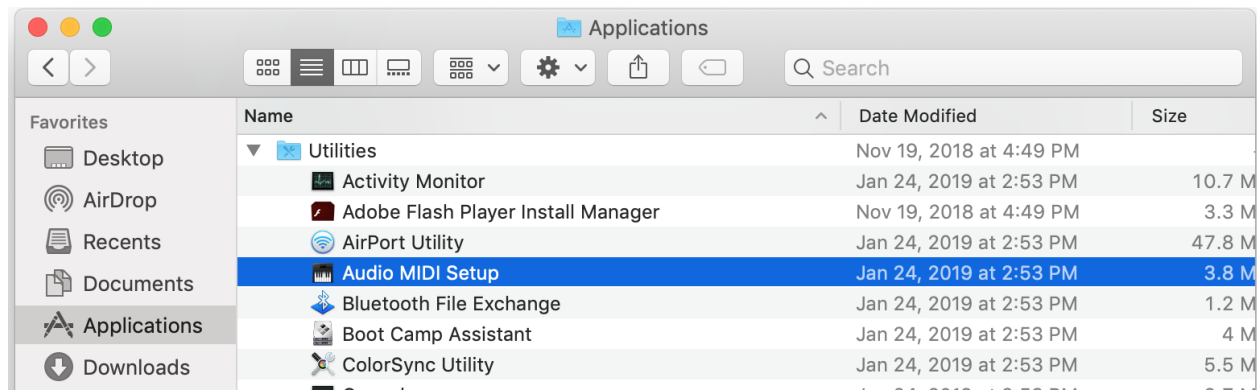

2. 「HyperX QuadCast 2」をクリックし、「Thru」列の下にあるチェックボックスをクリックして、マイクモニターのオンとオフを切り替えます。

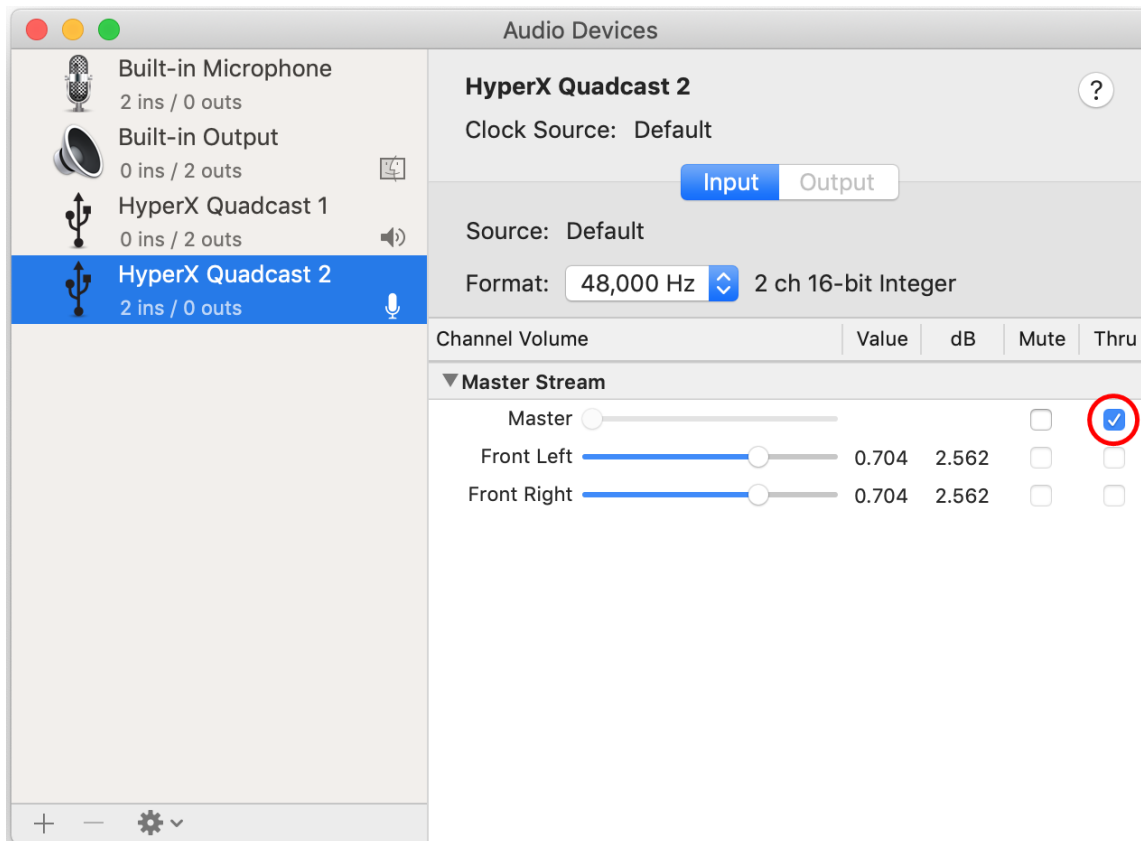

PS4

マイクモニターレベルは、PS4 では直接コントロールできません。



マウントアダプターの取り付け

1. 付属のマウントアダプターをマイクのブームアームにしっかりと取り付けます。マウントアダプターは、3/8 インチネジと 5/8 インチネジのサイズを対応します。
2. マイクスタンドのつまみネジとナットの両方を外します。
3. マイクからマイクスタンドを外します。
4. マウントアダプターとマイクの取り付け穴を合わせ、つまみネジとナットを使ってアダプターを固定します。



ご質問、またはセットアップに問題がありますか？

HyperX サポートチームにご連絡ください : hyperxgaming.com/support/



HyperX QuadCast[™]



부품 번호

HX-MICQC-BK



목차

개요	3
사양	4
마이크 제어장치	5
PC 또는 맥과 사용	7
PS4™에 사용.....	11
헤드폰 연결	12
마이크 모니터링 조절.....	13
마운트 어댑터 설치	15



개요

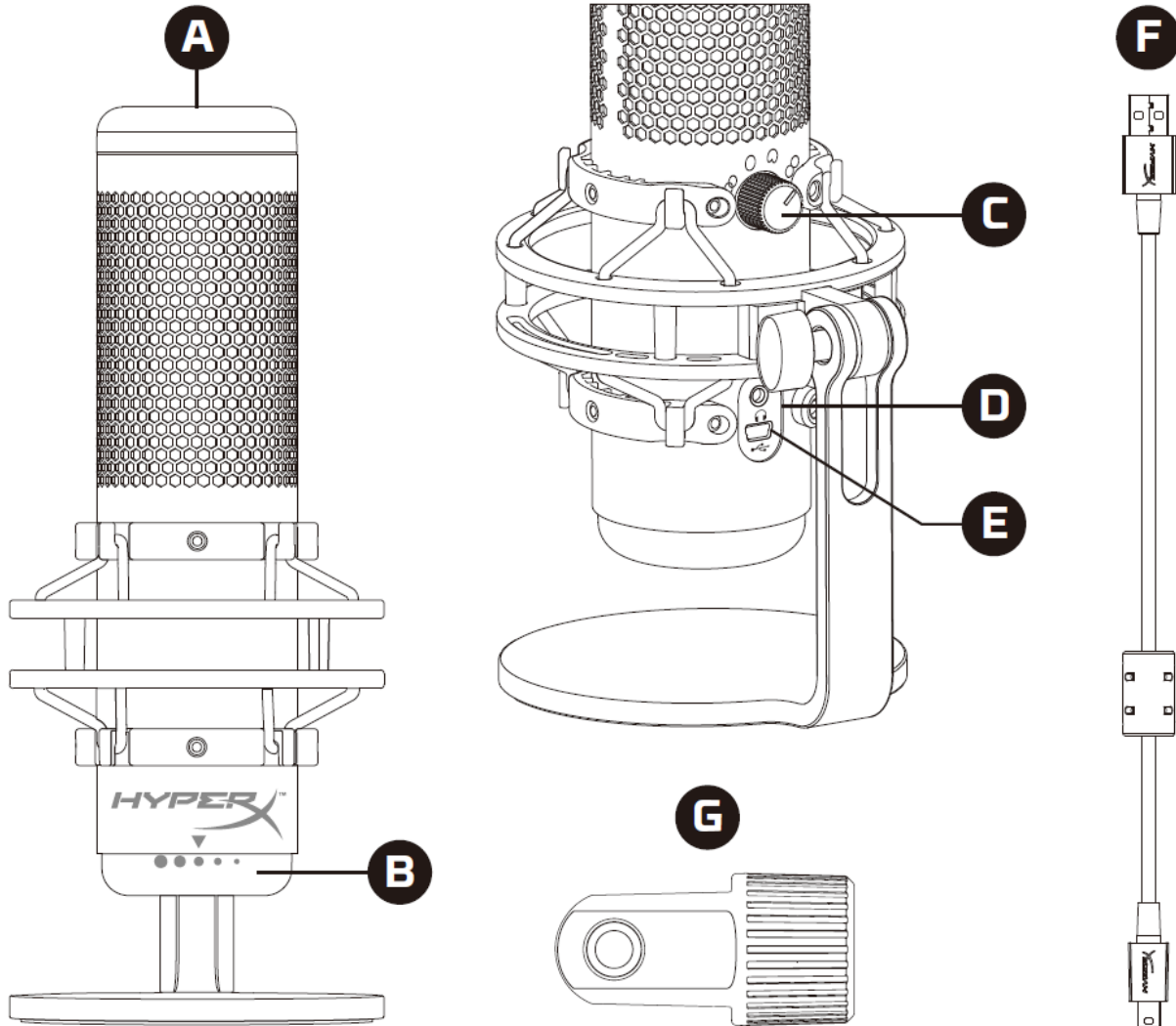

- A. 원터치 음소거 센서
- B. 이득 제어 노브
- C. 폴라 패턴 노브
- D. 헤드폰 잭
- E. USB 케이블 포트
- F. USB 케이블
- G. 마운트 어댑터*

*3/8" 및 5/8" 나사산 크기 모두 지원



사양

마이크

소비 전력: 5V 125mA

샘플/비트 레이트: 48kHz/16 비트

구성: 일렉트릿 콘덴서 마이크

콘덴서 유형: 14mm 콘덴서 세 개

플라 패턴: 스테레오, 전방향, 카디오이드, 양방향

주파수 응답: 20Hz - 20kHz

감도: -36dB(1kHz 에서 1V/Pa)

케이블 길이: 3m

무게:

- 마이크: 254g
- 완충마운트 및 스탠드: 364g
- USB 케이블 포함 총: 710g

헤드폰 출력

임피던스: 32 Ω

주파수 응답: 20Hz - 20kHz

최대 파워 출력: 7mW

THD: ≤ 0.05%(1kHz/0dBFS)

SNR: ≥ 90dB(1kHz, RL=∞)



마이크 제어장치

폴라 패턴 선택

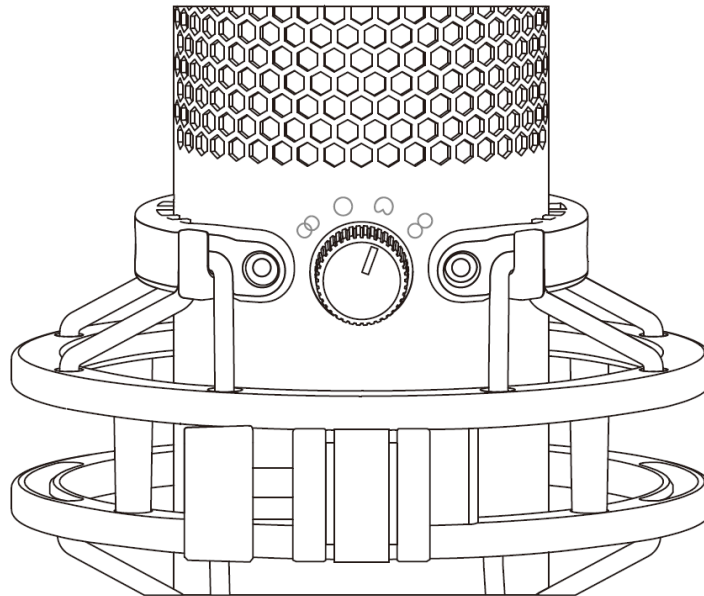

폴라 패턴 노브를 회전해 네 개의 폴라 패턴 중 하나를 선택하십시오.

기호	음향 방향	폴라 패턴	시나리오
		스테레오	보컬, 악기
		전방향	다자 팟캐스트, 컨퍼런스 콜
		카디오이드	팟캐스트, 스트리밍, 보이스오버, 악기
		양방향	1 대 1 인터뷰



이득 제어 조정

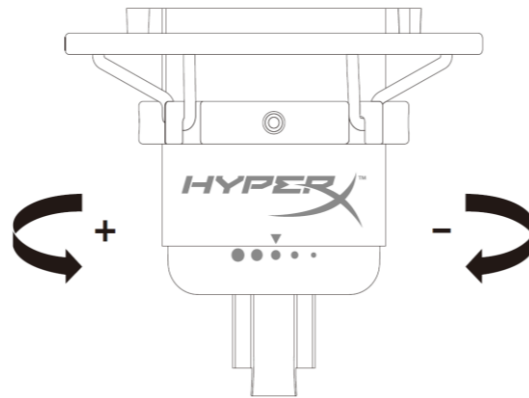

이득 제어 노브를 회전해 마이크 이득을 조정하십시오.

마이크 음소거

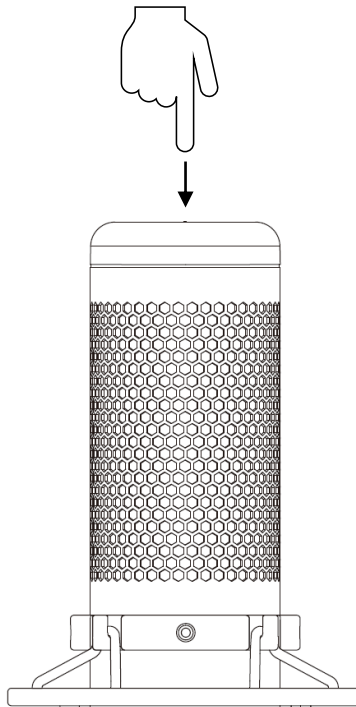

마이크 상단을 눌러 마이크를 음소거/음소거 해제하십시오. 마이크 LED는 현재 마이크의 음소거 상태를 나타냅니다.

마이크 LED	음소거 상태
빨간색	음소거 끄기
꺼짐	음소거 켜기



PC 또는 맥과 사용

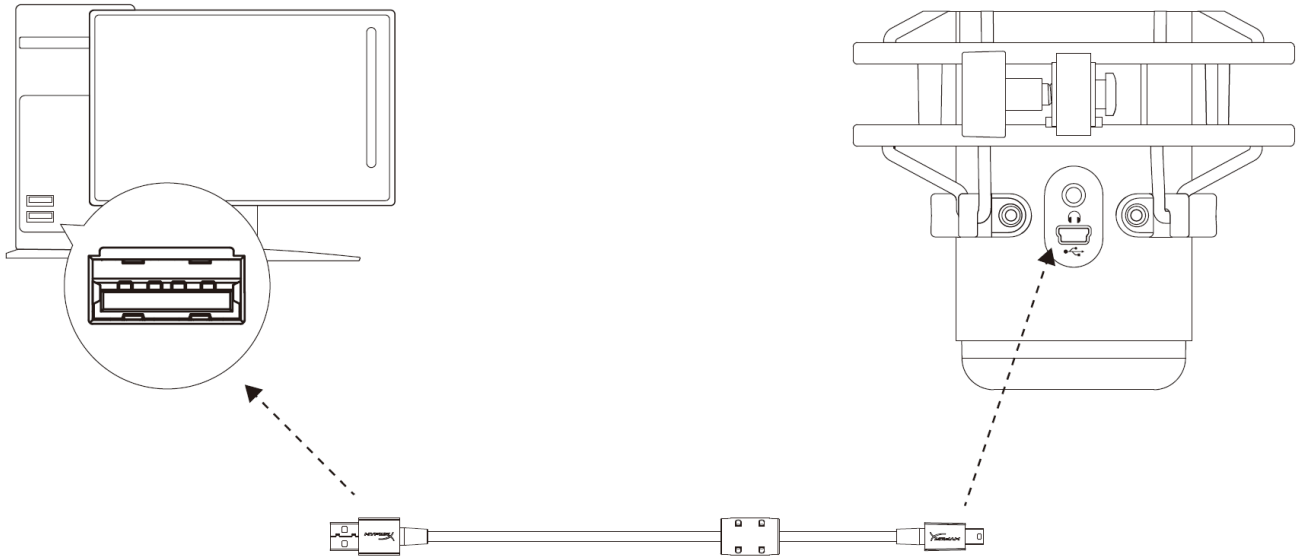

포함된 USB 케이블로 PC 나 Mac 에 있는 USB 포트에 마이크를 연결하십시오.

Windows

마이크를 PC 에 올바르게 구성하려면 아래 단계를 따르십시오.

1. 시스템 트레이의 소리 아이콘을 오른쪽 클릭하고 소리를 선택합니다.

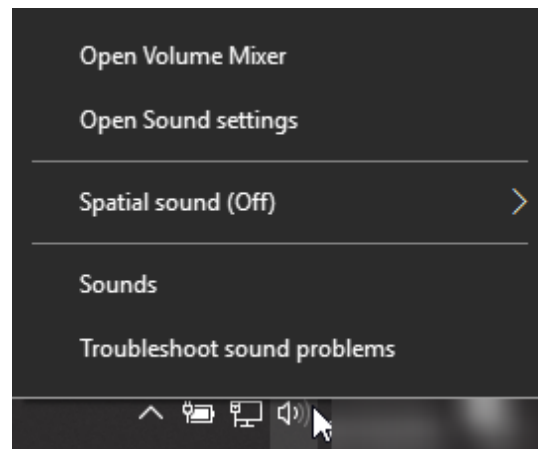



2. 재생 탭에서 **Speakers HyperX**
QuadCast 를 선택하고 기본 설정 버튼을
 클릭하십시오.

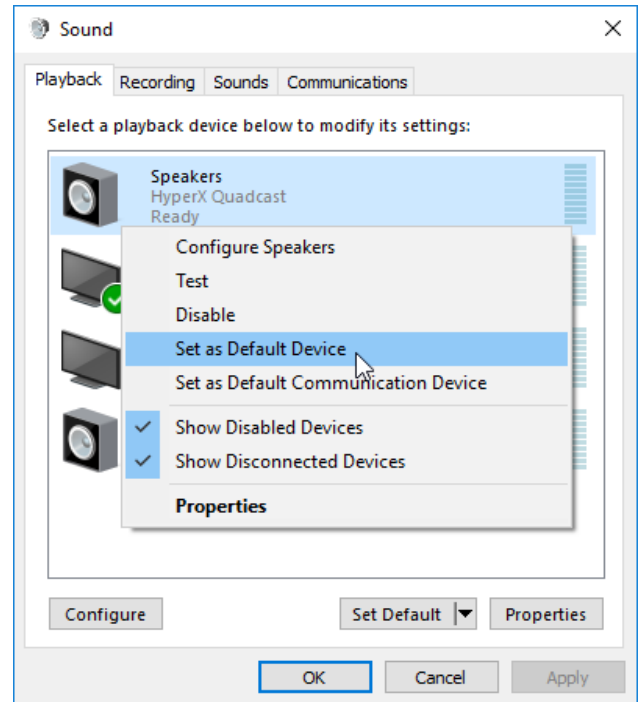

3. 녹음 탭에서 **Microphone HyperX**
QuadCast 를 선택하고 기본 설정 버튼을
 클릭하십시오.

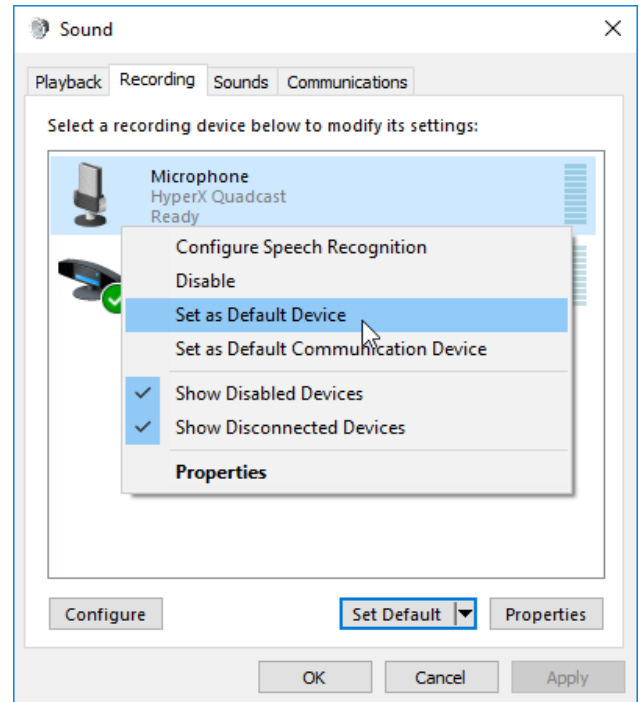



macOS

마이크를 macOS 에 올바르게 구성하려면 아래 단계를 따르십시오.

1. 시스템 환경설정을 열고 사운드를 선택하십시오.

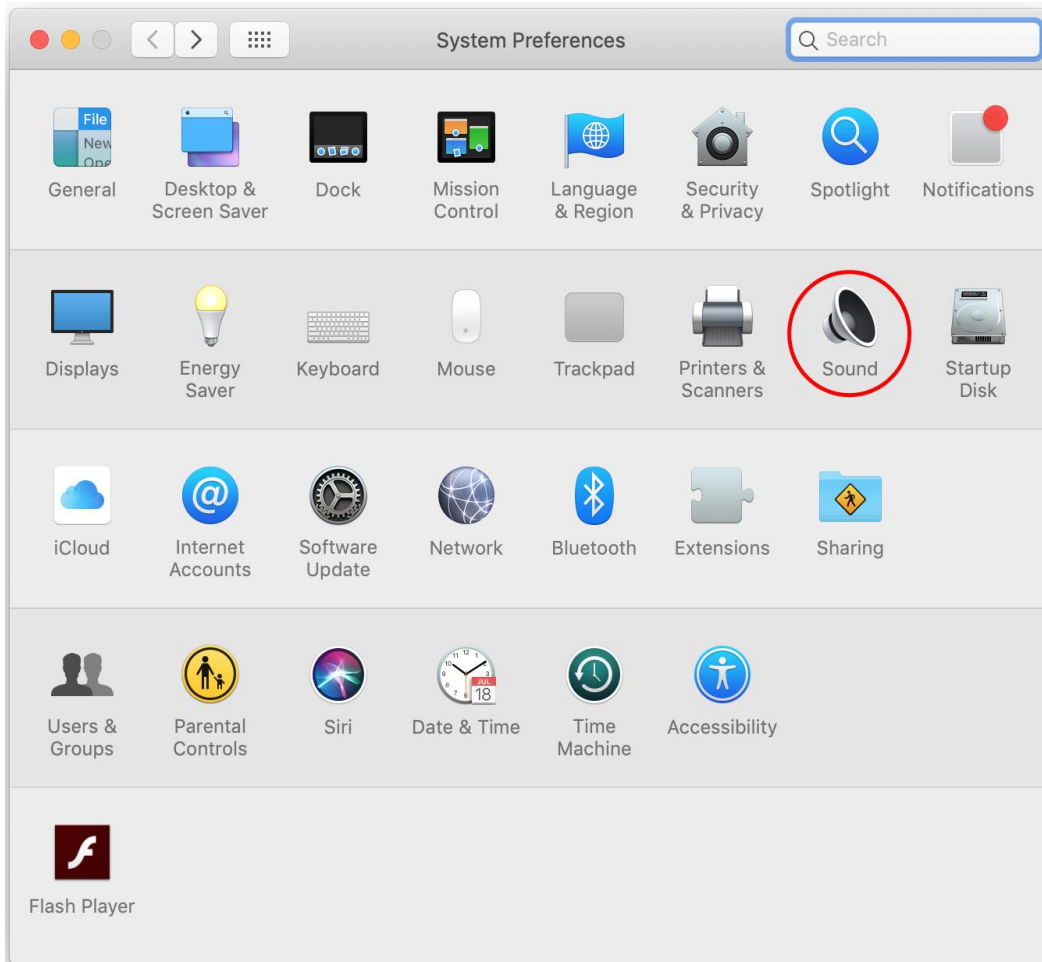



2. 출력 탭에서 **HyperX QuadCast** 를 선택하십시오.

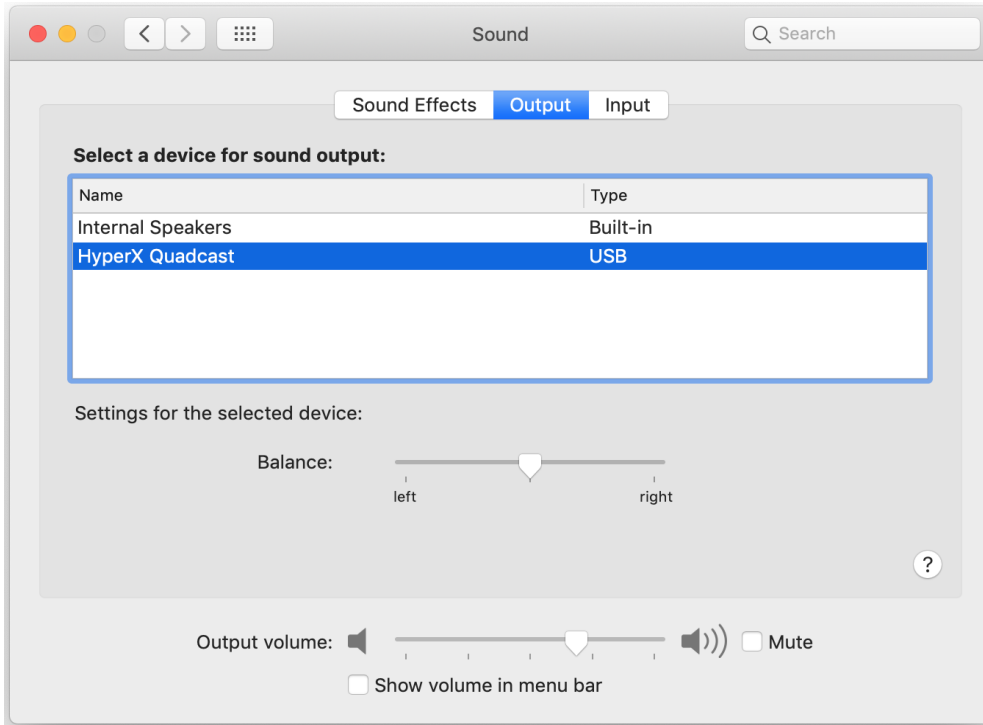

3. 입력 탭에서 **HyperX QuadCast** 를 선택하십시오.

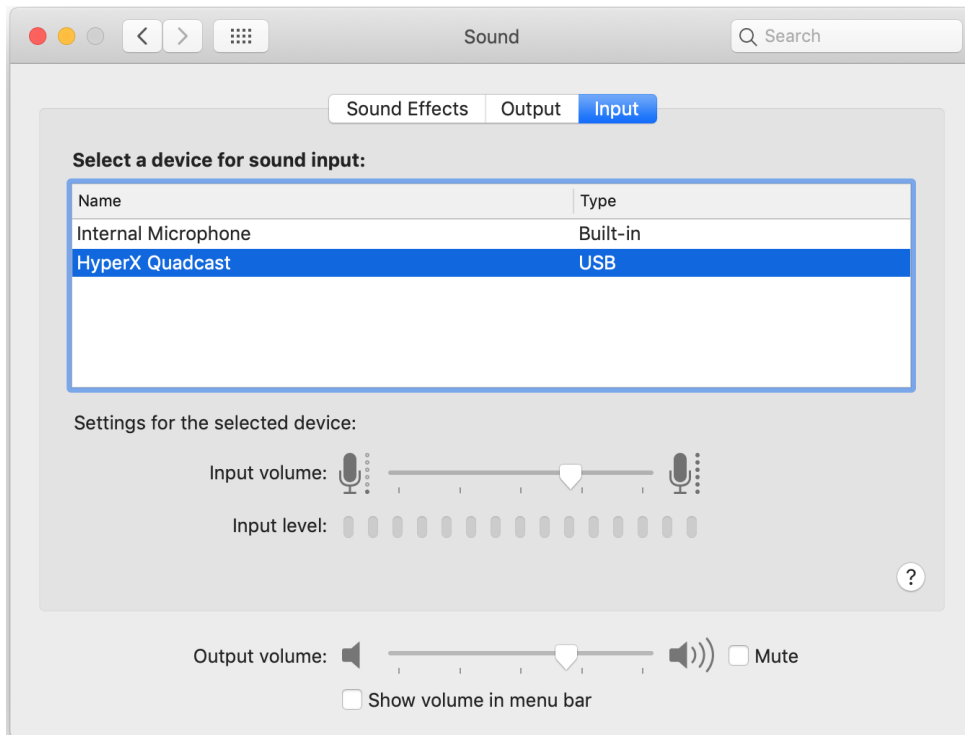



PS4[™]에 사용

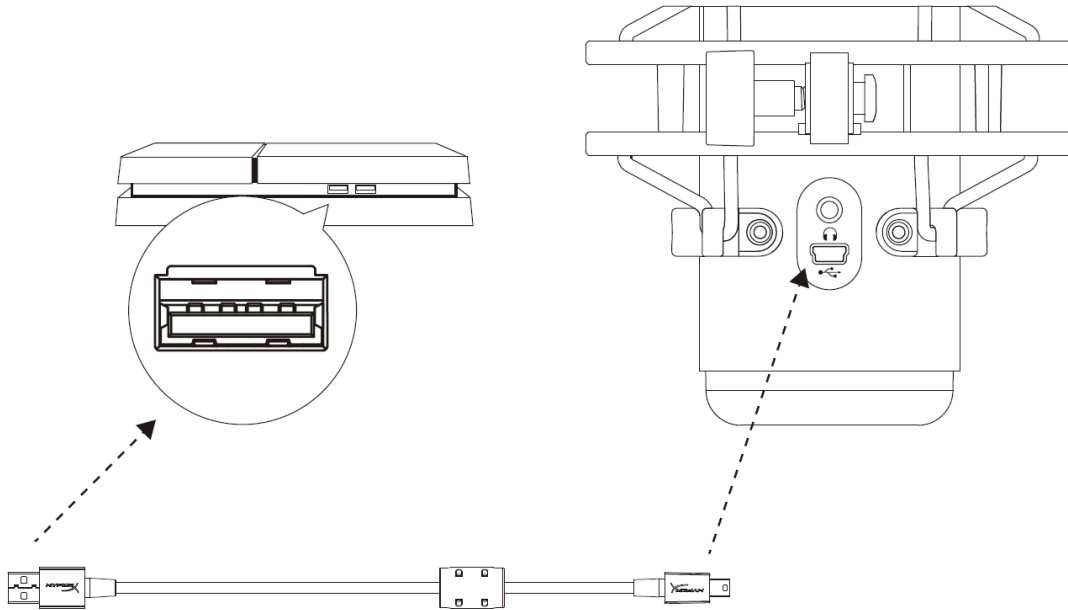

포함된 USB 케이블로 PS4에 있는 USB 포트에 마이크를 연결하십시오.

마이크를 PS4에 최적 설정으로 구성하려면 아래 단계를 따르십시오.

1. PS4 메인 메뉴에서 **설정 > 주변기기 > 오디오 기기**로 이동합니다
2. 입력 기기를 **USB 헤드셋(HyperX QuadCast)**으로 설정합니다
3. 출력 기기를 **USB 헤드셋(HyperX QuadCast)**으로 설정합니다
4. 헤드폰에 출력을 모든 오디오로 설정합니다
5. 음량 컨트롤(헤드폰)을 원하는 음량으로 설정합니다

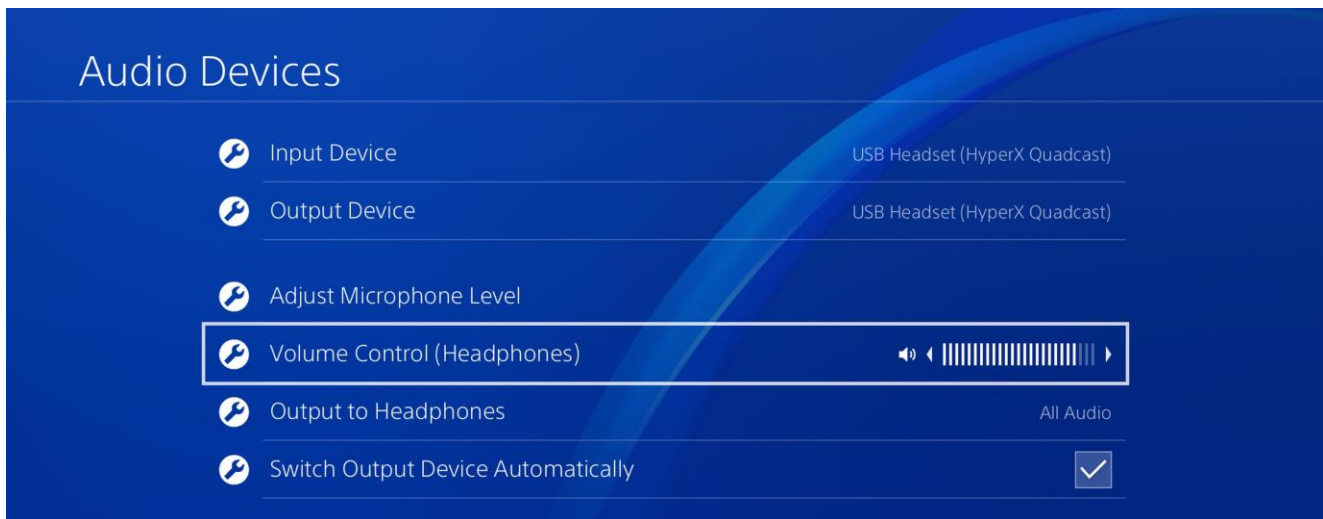



헤드폰 연결

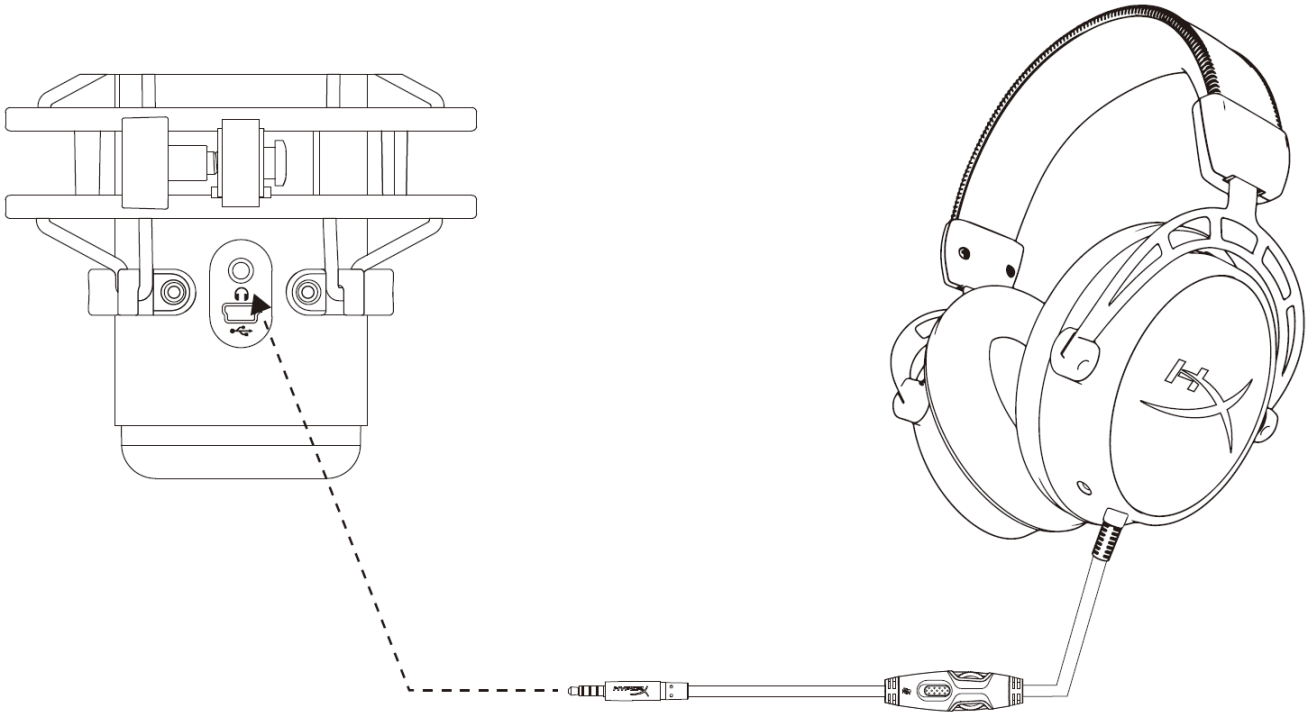

마이크 모니터링과 재생 오디오를 위해 헤드폰 잭을 헤드폰에 연결하십시오.



마이크 모니터링 조절

PC

- 음향 조절 패널의 *재생* 탭에서,
스피커 **HyperX QuadCast** 를 오른쪽
클릭하고 속성을 선택합니다.

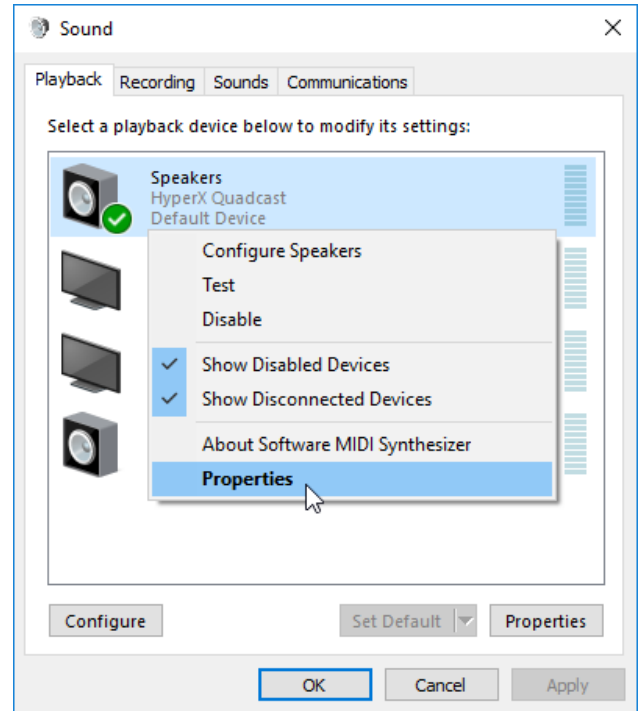

- 레벨* 탭에서 **마이크 볼륨** 슬라이더를 조정해
마이크 모니터링 레벨을 조정하십시오.

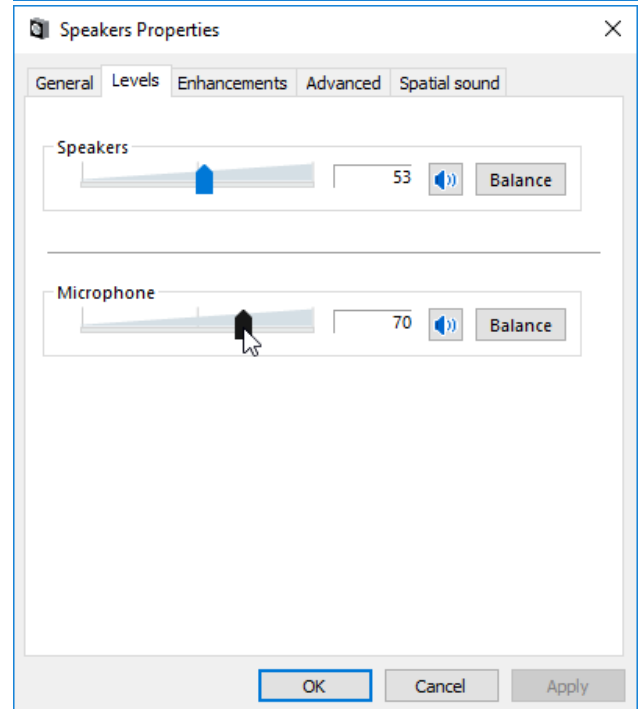



macOS

1. **Finder** 앱을 열고 **Applications(응용 프로그램) > Utilities(유틸리티) > Audio MIDI Setup**
(오디오 MIDI 설정)로 이동합니다

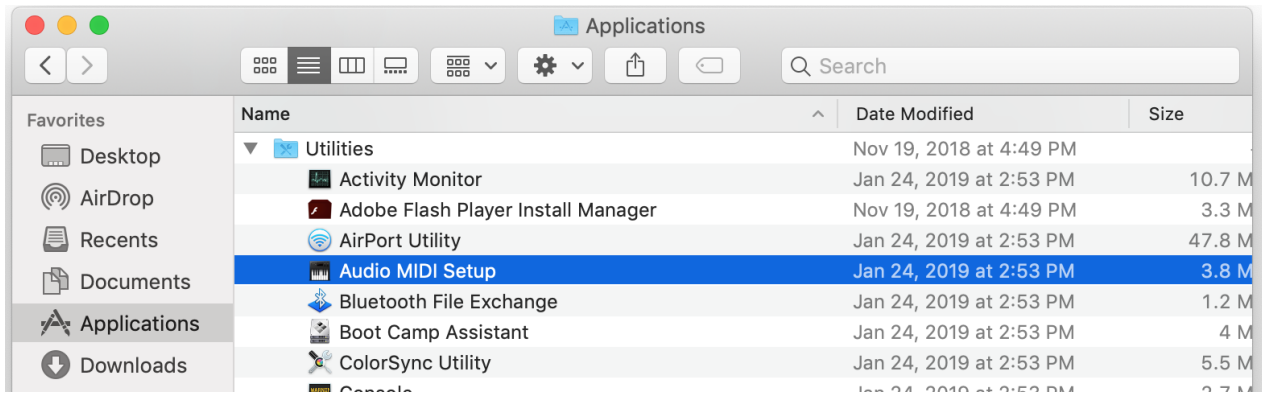

2. **HyperX QuadCast 2** 를 클릭하고 **Thru** 열 하단의 체크박스를 클릭하여 마이크 모니터링을 켜거나 끄기로 토글 전환하십시오.

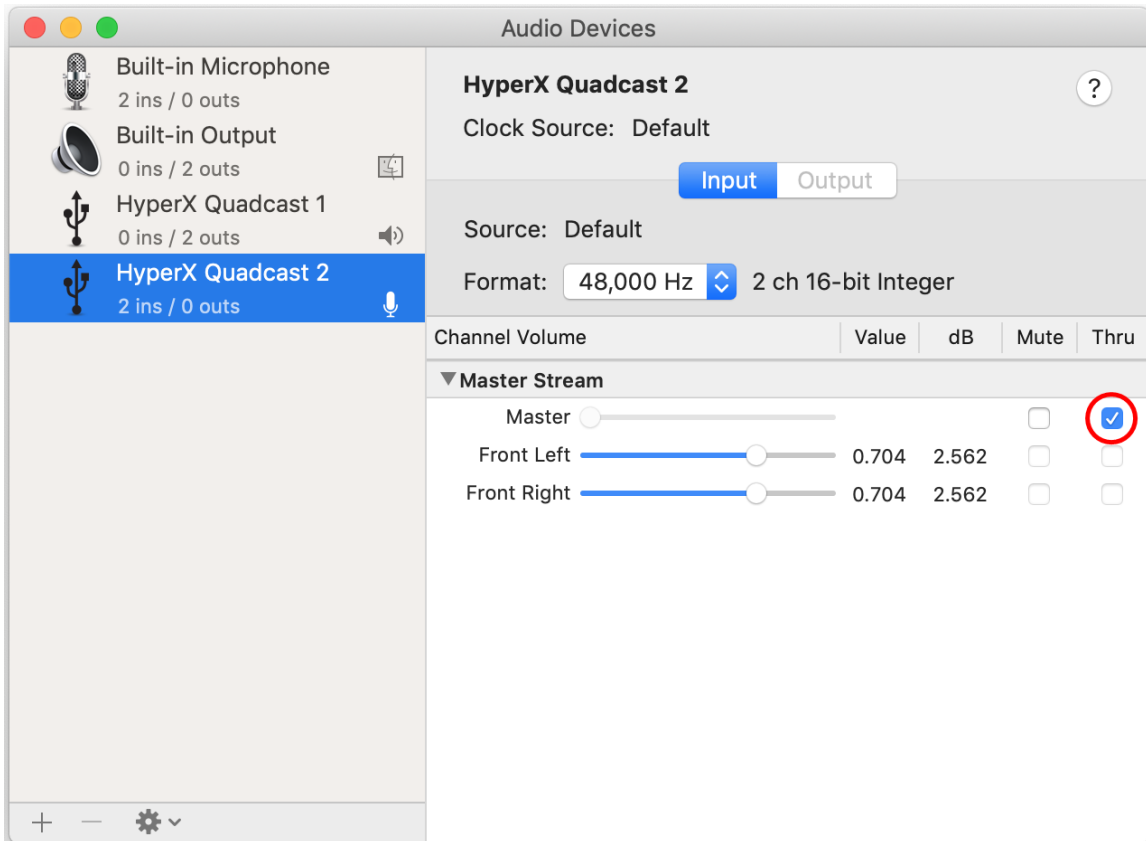

PS4

마이크 모니터링 수준은 PS4 에서 직접 관리할 수 없습니다.



마운트 어댑터 설치

1. 포함된 마운트 어댑터를 마이크 볼 암에 고정하십시오. 마운트 어댑터는 3/8" 및 5/8" 나사산 크기를 모두 지원합니다.
2. 마이크 스탠드에서 엄지 나사와 너트를 모두 제거하십시오.
3. 마이크 스탠드를 마이크에서 제거하십시오.
4. 마운트 어댑터를 마이크 마운트 구멍에 정렬하고 어댑터를 엄지 나사와 너트로 고정하십시오.



질문 또는 설치 문제가 있으십니까?

다음 주소로 HyperX 지원 팀에 연락하세요. hyperxgaming.com/support/



HyperX QuadCast[™]



หมายเลขชิ้นส่วน

HX-MICQC-BK



สารบัญ

ภาพรวม	3
รายละเอียดทางเทคนิค	4
ระบบควบคุมไมโครโฟน	5
การใช้งานกับ PC หรือ Mac.....	7
การใช้กับ PS4™	11
การเชื่อมต่อ headset	12
การควบคุมค่าการตรวจติดตามไมโครโฟน	13
การติดตั้งอะแดปเตอร์ยัด	15



ภาพรวม

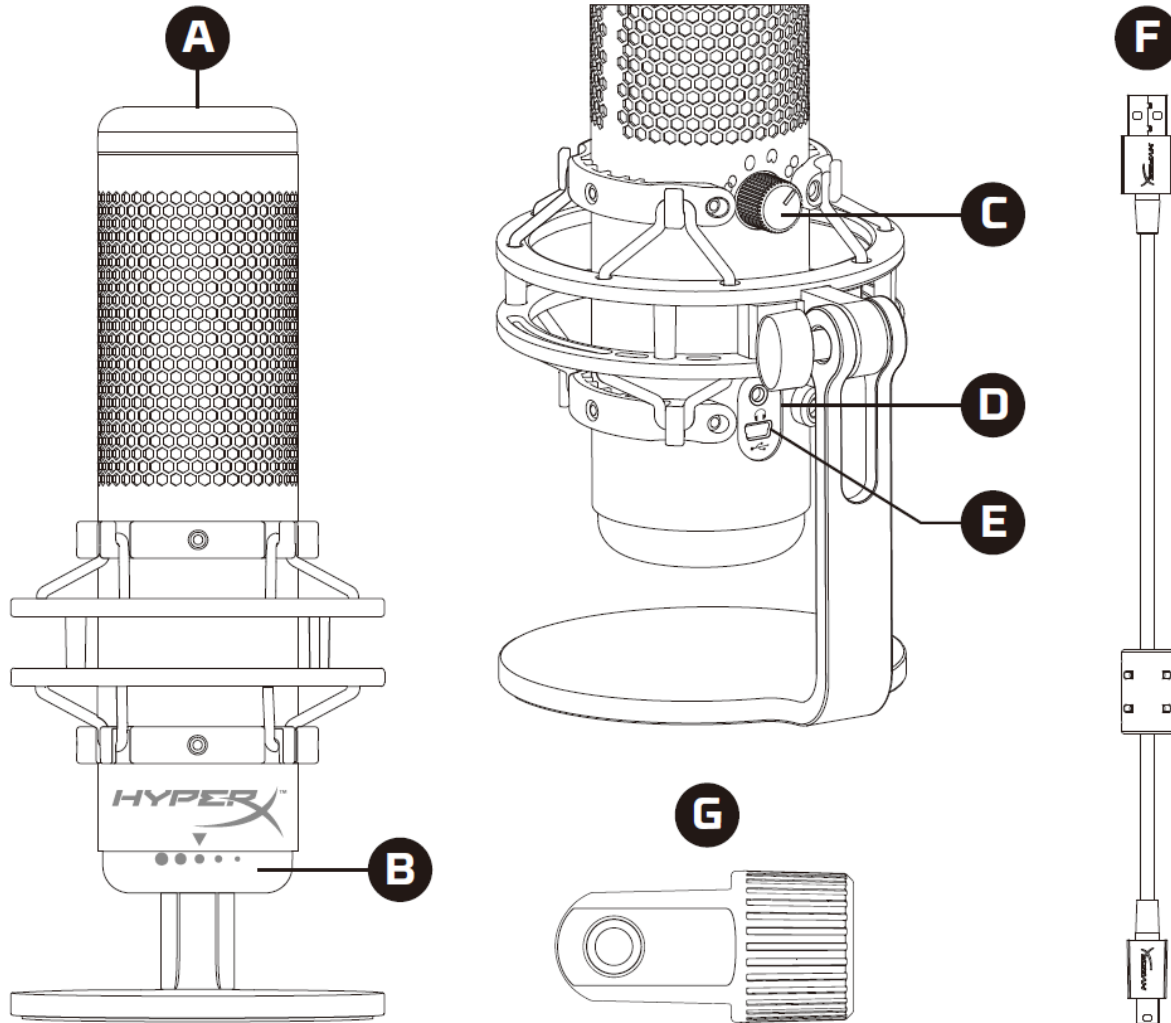

- A. เซ็นเซอร์การกดปิดเสียง
- B. แป้นควบคุมค่าเกน
- C. แป้นปรับรูปแบบขั้ว
- D. ช่องเสียบเสตอโฟน
- E. พอร์ตสาย USB
- F. สาย USB
- G. อะแดปเตอร์ต่อ*

*รองรับทั้งเกลียวขนาด 3/8 นิ้วและ 5/8 นิ้ว



รายละเอียดทางเทคนิค

ไมโครโฟน

อัตราสิ้นเปลืองพลังงาน: 5V 125mA

การสุ่มตัวอย่าง/บิตเรต: 48kHz/16 บิต

ส่วนประกอบ: ไมโครโฟนอิเล็กทรอนิกส์คอนเดนเซอร์

ประเภทคอนเดนเซอร์: คอนเดนเซอร์ 14 มม. สามตัว

รูปแบบขั้วสัญญาณ: สเตอริโอ รอบทิศทาง รับเสียงด้านหน้า สองทิศทาง

ความถี่: 20Hz - 20kHz

ความไว: -36dB (1V/Pa ที่ 1kHz)

ความยาวสาย: 3 มม.

น้ำหนัก:

- ไมโครโฟน: 254 ก.
- ตัวยึดและฐานตั้งกันกระแทก: 364 ก.
- รวมพร้อมสาย USB: 710 ก.

สัญญาณขาออกสเตอริโอ

ความต้านทาน: 32 Ω

ความถี่: 20Hz - 20kHz

กำลังขาออกสูงสุด: 7mW

THD: $\leq 0.05\%$ (1kHz/0dBFS)

SNR: $\geq 90\text{dB}$ (1kHz, $R_L = \infty$)







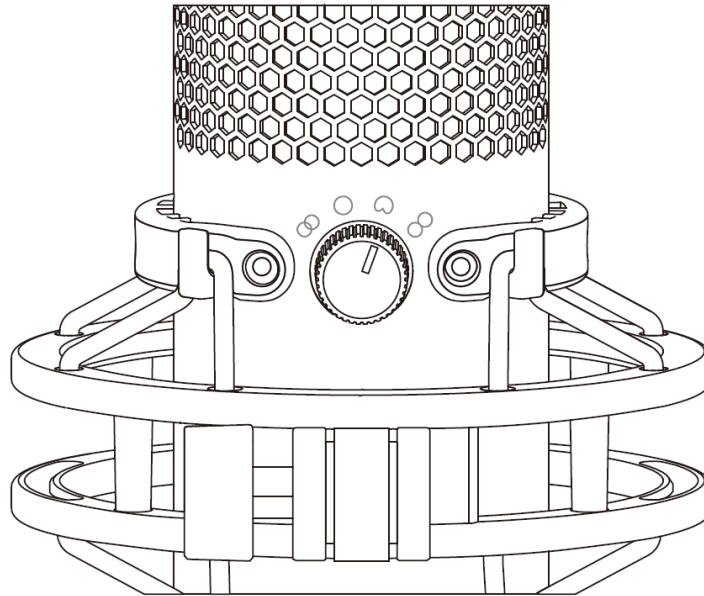

ระบบควบคุมไมโครโฟน

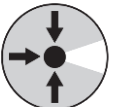
การเลือกรูปแบบขั้ว

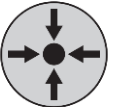

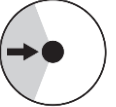
หมุนแป้นปรับรูปแบบขั้วเพื่อเลือกหนึ่งในสี่รูปแบบที่มีให้เลือก

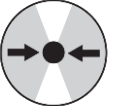
สัญลักษณ์	ทิศทางเสียง	รูปแบบขั้ว	สถานการณ์ตัวอย่าง
		สเตอริโอ	เสียงคน, เครื่องดนตรี
		รอบทิศทาง	พอดคาสต์หลายคน, การประชุมสาย
		Cardioid	พอดคาสต์, สตูดิโอ, เสียงพากษ์, เครื่องดนตรี
		สองทิศทาง	สัมภาษณ์ตัวต่อตัว



การปรับค่าเกน

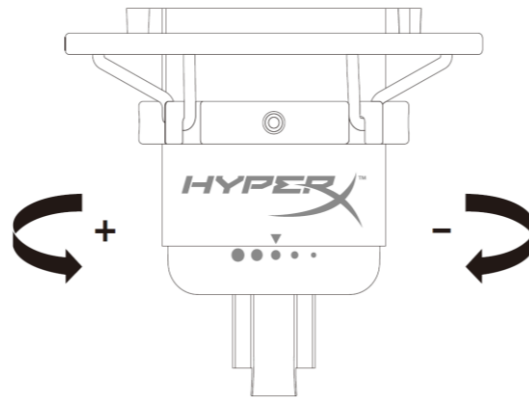

หมุนแป้นปรับค่าเกนเพื่อปรับเกนของไมโครโฟน

การปิดเสียงไมโครโฟน

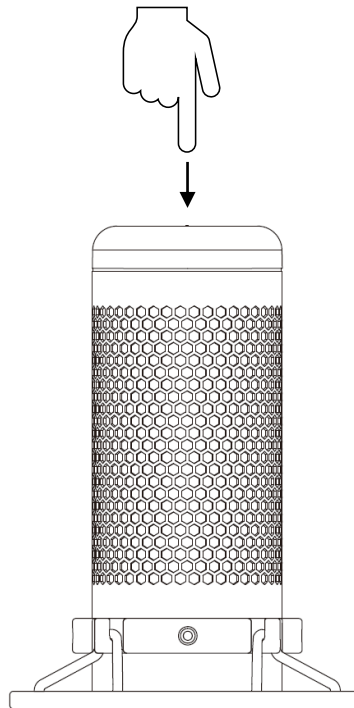

กดที่ด้านบนของไมโครโฟนเพื่อปิด/เปิดเสียงไมโครโฟน LED ของไมโครโฟนจะแจ้งสถานะการปิดเสียงในปัจจุบันของไมโครโฟน

LED ไมโครโฟน	สถานะปิดเสียง
แดง	เปิดเสียง
ดับ	ปิดเสียง



การใช้งานกับ PC หรือ Mac

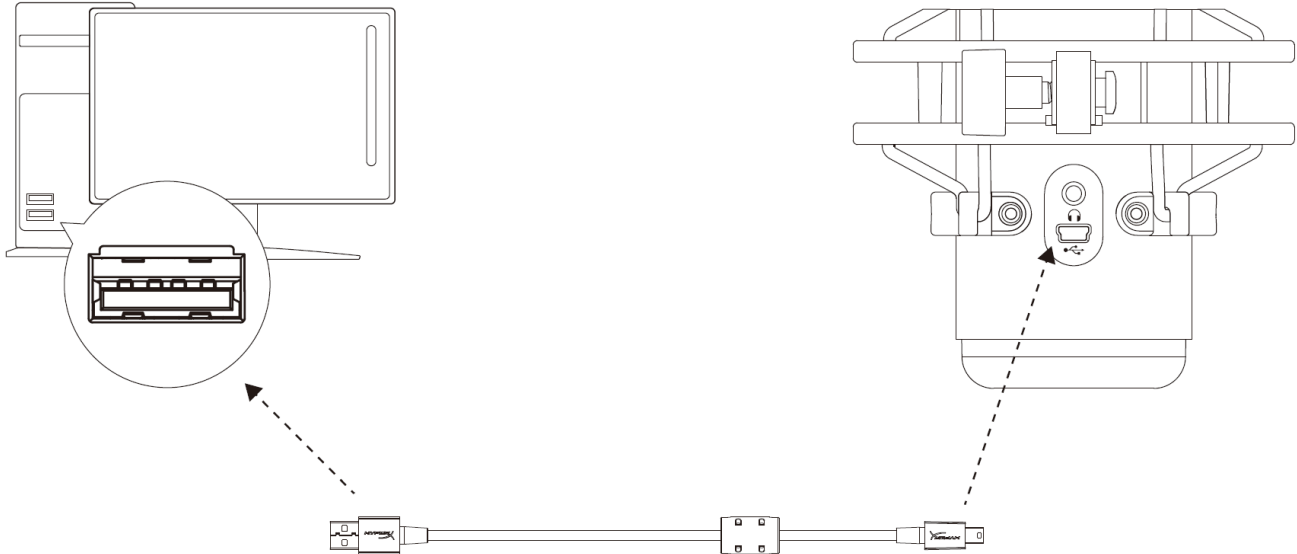

เชื่อมต่อไมโครโฟนกับพอร์ต USB ที่ PC หรือ Mac โดยใช้สาย USB ที่จัดมาให้

Windows

เพื่อให้แน่ใจว่ากำหนดโครงสร้างการทำงานของไมโครโฟนกับ PC ได้ถูกต้อง ให้ทำตามขั้นตอนต่อไปนี้

1. คลิกขวาที่ไอคอนเสียงที่ซิสเต็มเทรย์ จากนั้นเลือก

Sounds

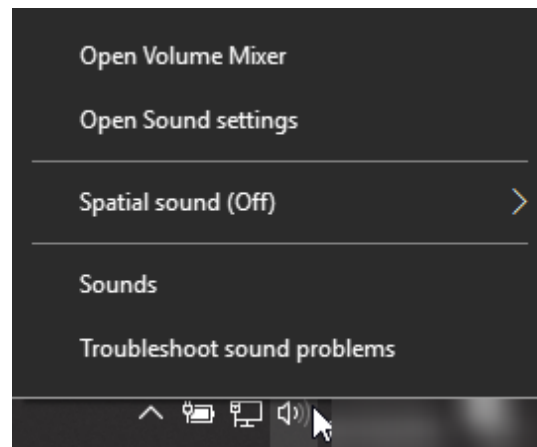



- จากแท็บ *Playback* เลือก **Speakers HyperX QuadCast** จากนั้นคลิกที่ปุ่ม **Set Default**

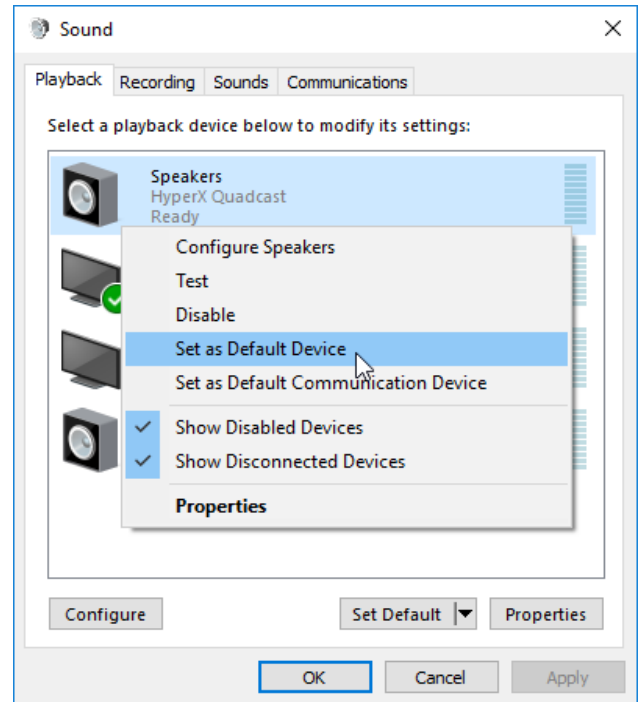

- จากแท็บ *Recording* เลือก **Microphone HyperX QuadCast** จากนั้นคลิกที่ปุ่ม **Set Default**

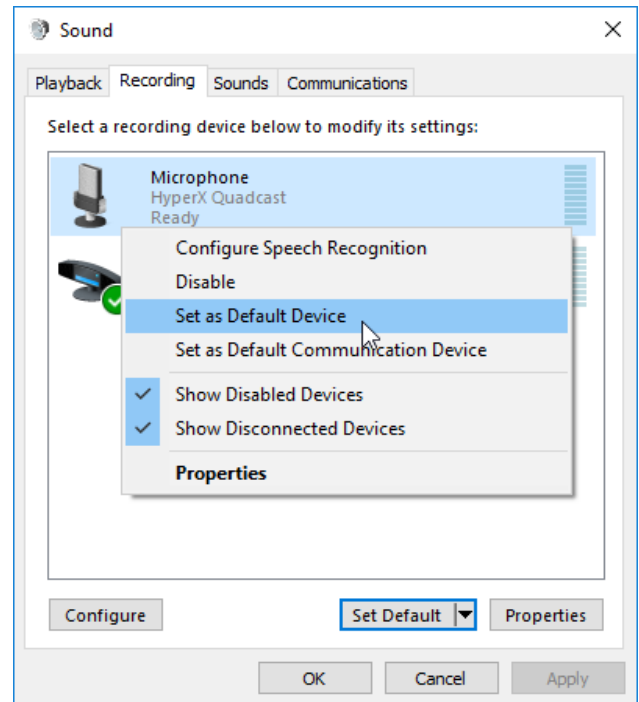



macOS

เพื่อให้แน่ใจว่ากำหนดโครงสร้างการทำงานของไมโครโฟนกับ macOS ได้ถูกต้อง ให้ทำตามขั้นตอนต่อไปนี้

1. เปิด System Preferences จากนั้นเลือก Sound

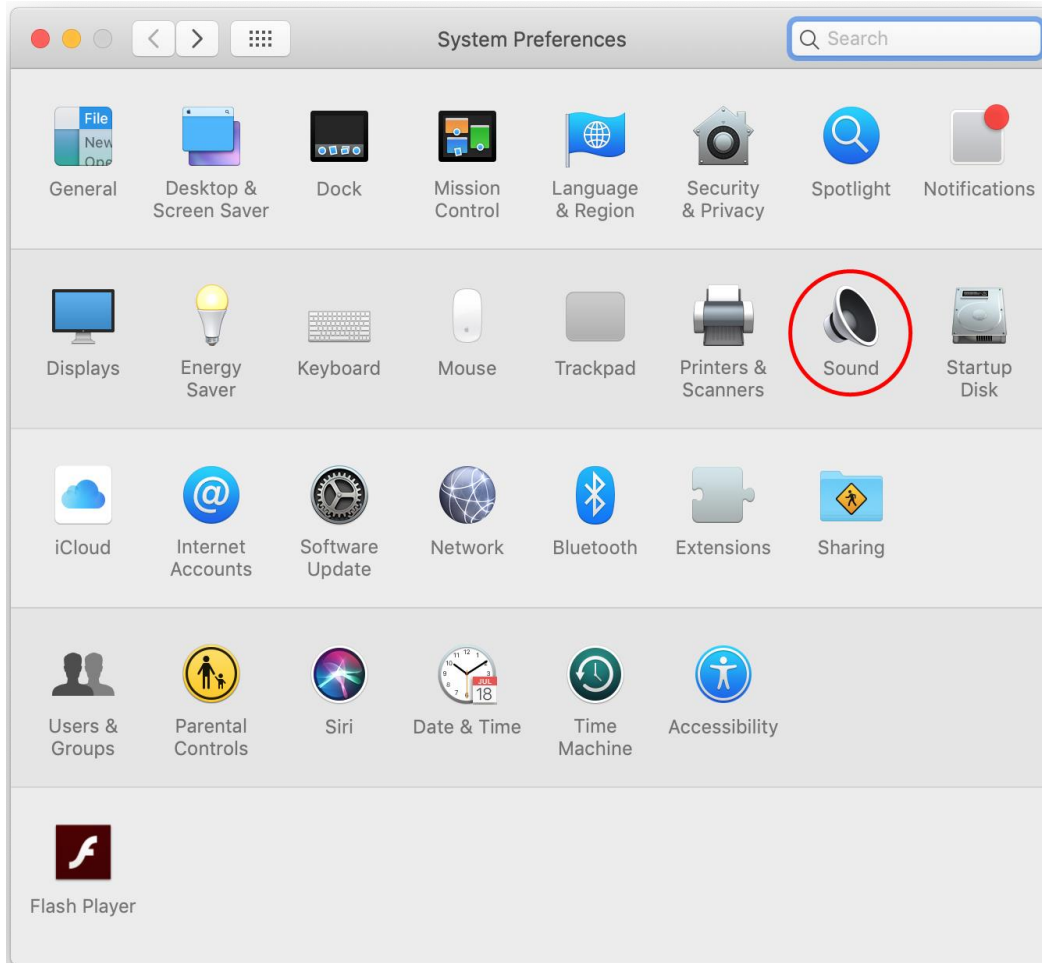



2. จากแท็บ *Output* เลือก **HyperX QuadCast**

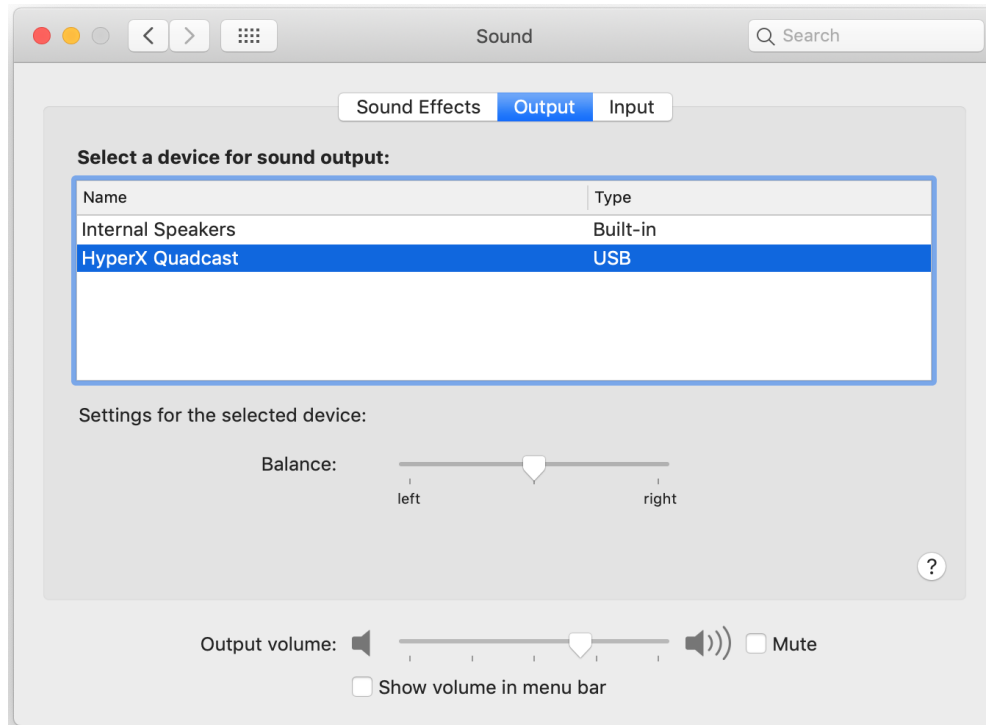

3. จากแท็บ *Input* เลือก **HyperX QuadCast**

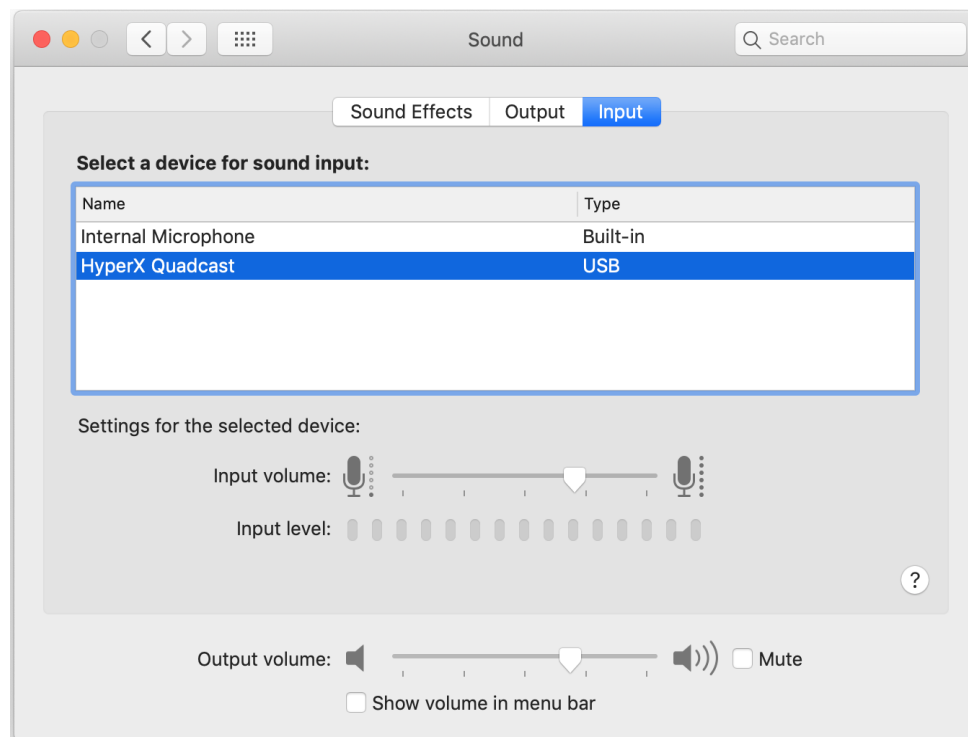



การใช้กับ PS4™

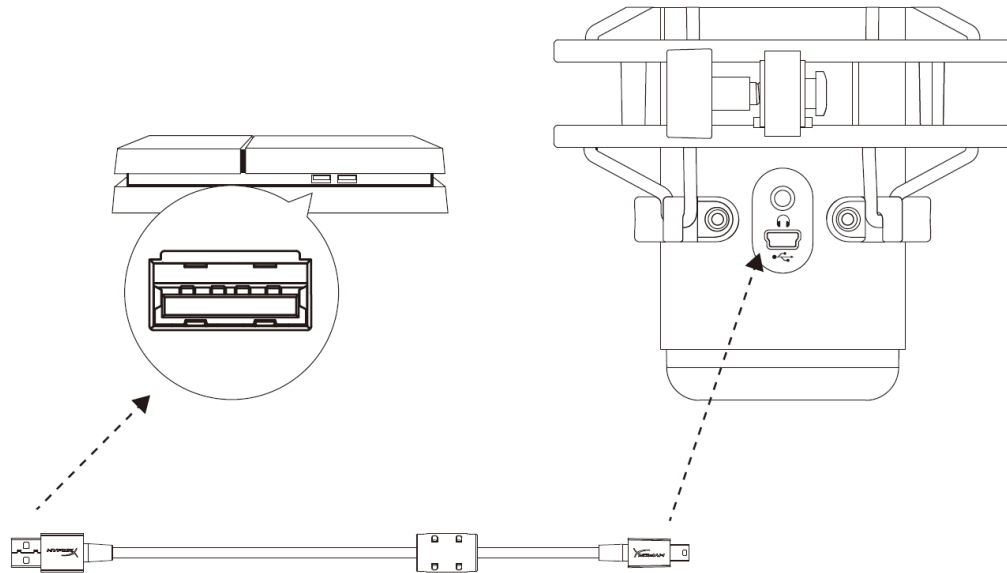

เชื่อมต่อไมโครโฟนกับพอร์ต USB ที่ PS4 โดยใช้สาย USB ที่จัดมาให้

เพื่อให้แน่ใจว่ากำหนดโครงสร้างการทำงานของไมโครโฟนไว้อย่างเหมาะสมกับ PS4 ให้ทำตามขั้นตอนต่อไปนี้

1. จากเมนูหลักของ PS4 ไปที่ **Settings > Devices > Audio Devices**
2. ตั้งค่า *Input Device* เป็น **USB Headset (HyperX QuadCast)**
3. ตั้งค่า *Output Device* เป็น **USB Headset (HyperX QuadCast)**
4. ตั้งค่า *Output to Headphones* เป็น **All Audio**
5. ตั้งค่า *Volume Control (Headphones)* เป็นระดับเสียงที่ต้องการ

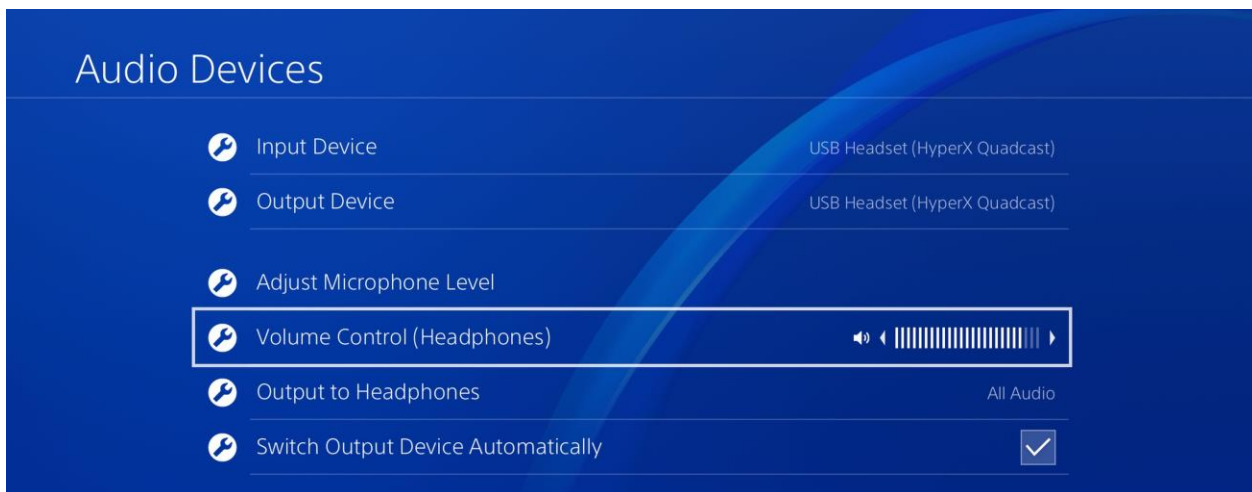



การเชื่อมต่อ headset

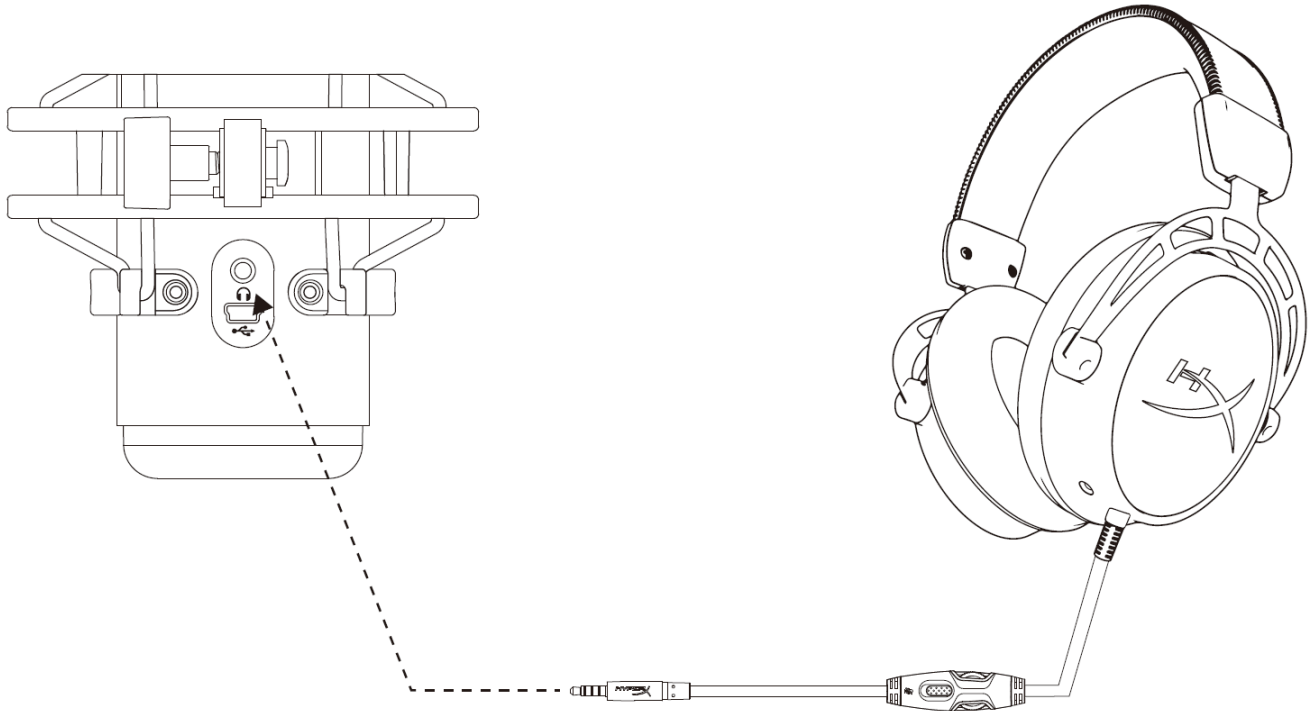

ต่อ headset เข้ากับช่องเสียง headset ที่มีไมโครโฟนสำหรับเสียงไมโครโฟนและเสียงที่เปิดเล่น



การควบคุมค่าการตรวจติดตามไมโครโฟน

PC

1. จากแผงควบคุมเสียง ในแท็บ *Playback* คลิกขวาที่

Speakers HyperX QuadCast

จากนั้นเลือก**Properties**

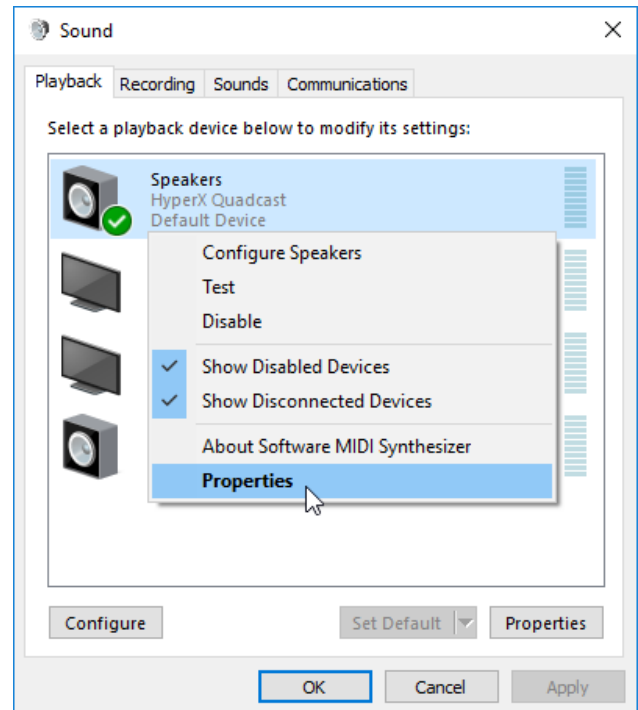

2. จากแท็บ *Levels* ให้ปรับแถบเลื่อนปรับระดับ

เสียงไมโครโฟน เพื่อปรับระดับเสียงไมโครโฟน

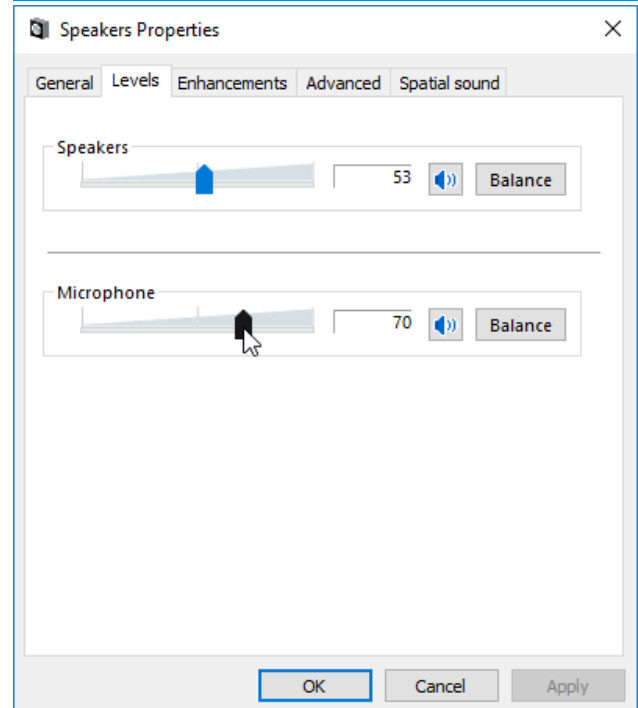



macOS

1. เปิด Finder แล้วไปที่ Application > Utilities > Audio MIDI Setup

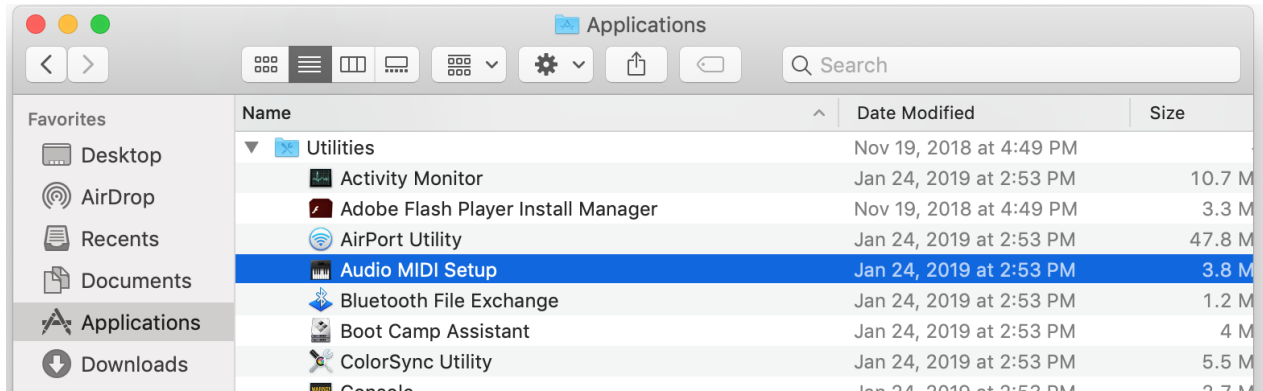

2. คลิกที่ HyperX QuadCast 2 แล้วคลิกที่ช่องทำเครื่องหมายในคอลัมน์ Thru เพื่อเปิดหรือปิดระบบตรวจสอบติดตามไมโครโฟน

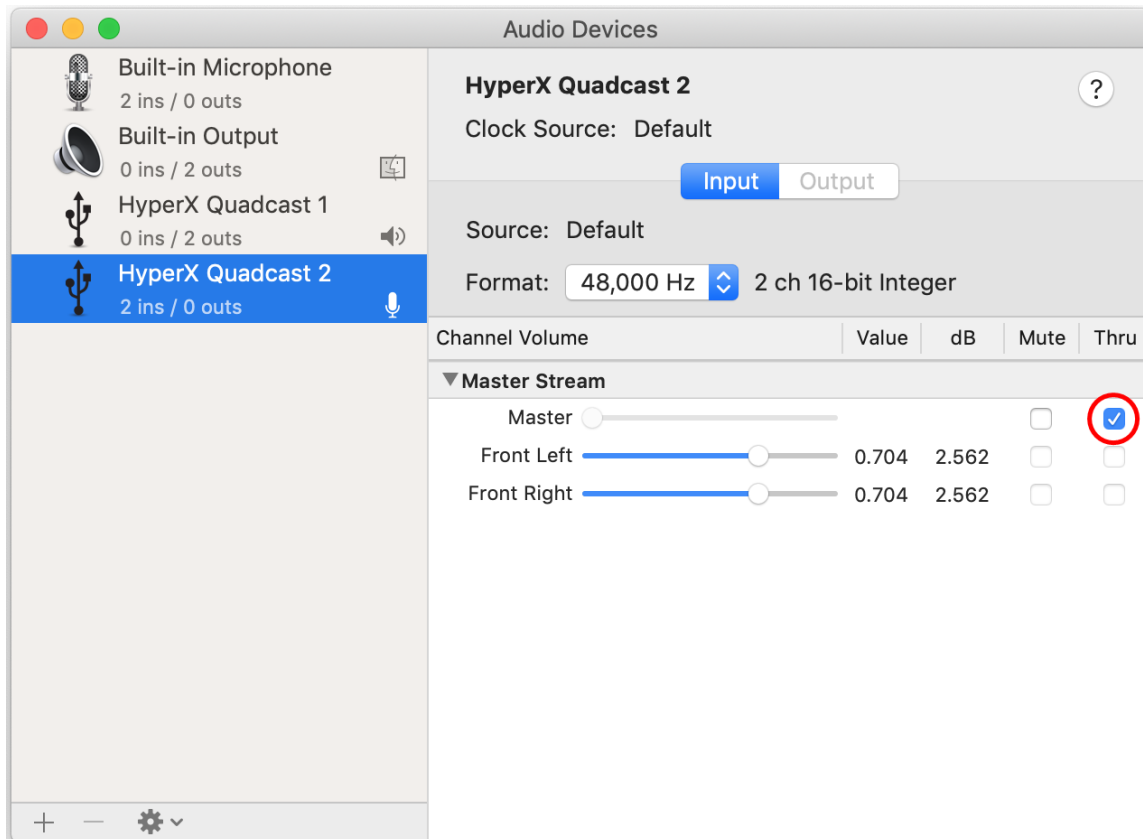

PS4

ระดับการตรวจสอบติดตามไมโครโฟนไม่สามารถควบคุมได้โดยตรงจาก PS4



การติดตั้งอะแดปเตอร์ยึด

1. ยึดอะแดปเตอร์ยึดที่จัดมาให้เข้ากับแกนบูมไมโครโฟน อะแดปเตอร์ยึดรองรับทั้งเกลียวขนาด 3/8 นิ้วและ 5/8 นิ้ว
2. ถอดสกรูหมุนมือและน็อตออกจากฐานไมโครโฟน
3. ถอดฐานไมโครโฟนออกจากไมโครโฟน
4. ปรับอะแดปเตอร์ยึดเข้าหาช่องยึดของไมโครโฟนแล้วยึดอะแดปเตอร์ด้วยสกรูหมุนมือและน็อต



มีข้อสงสัยหรือปัญหาในการติดตั้งหรือไม่

ติดต่อฝ่ายบริการของ HyperX ได้ที่ hyperxgaming.com/support/



HyperX QuadCast[™]



Mã sản phẩm

HX-MICQC-BK



MỤC LỤC

Tổng quát	3
Thông số kỹ thuật.....	4
Nút điều khiển micrô	5
Sử dụng với PC hoặc Mac	7
Sử dụng với PS4™	11
Kết nối tai nghe.....	12
Điều khiển giám sát tai nghe	13
Cài đặt bộ chuyển đổi giá	15



Tổng quát

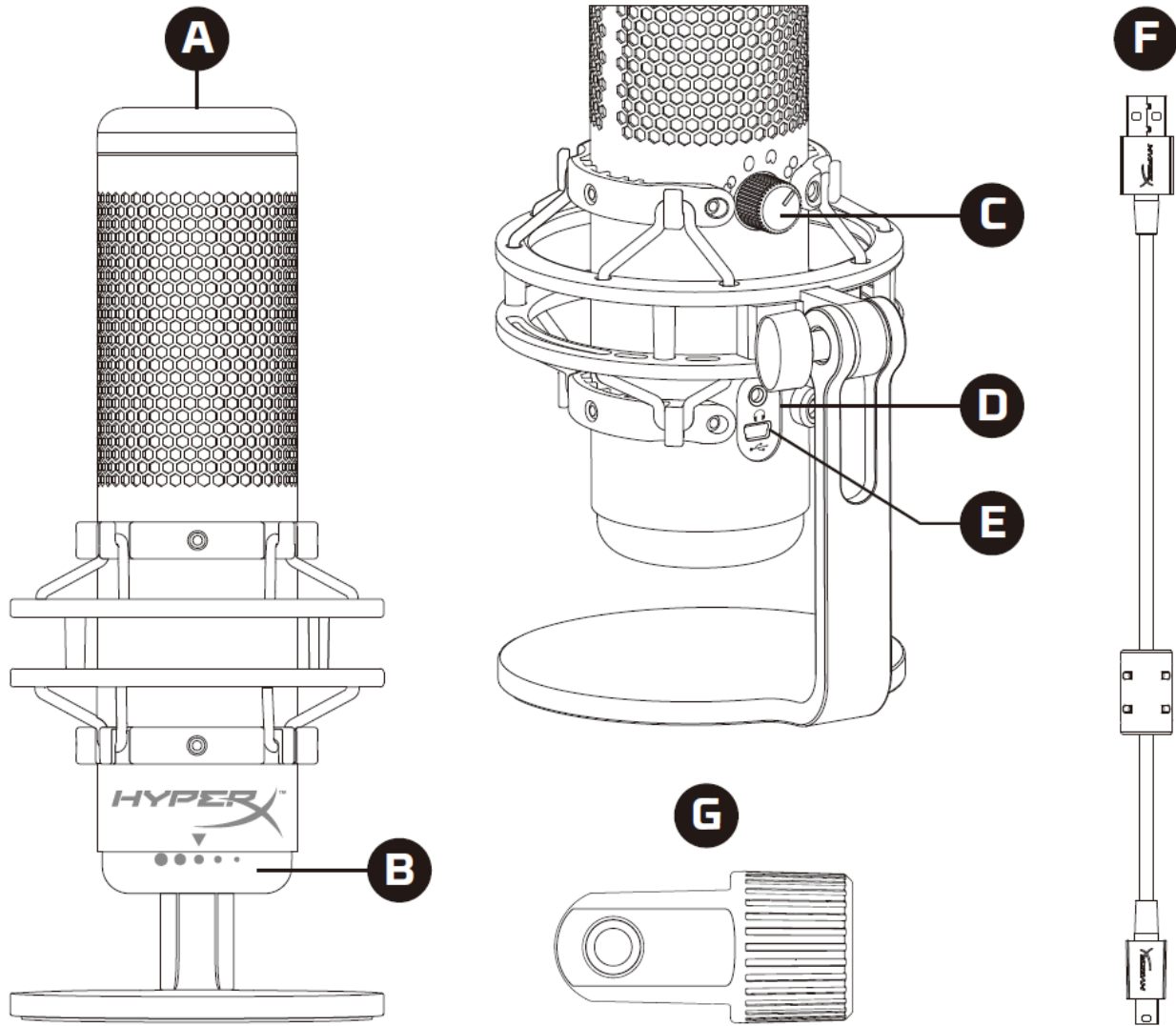

- A. Cảm biến chạm để tắt tiếng
- B. Nút khuếch đại
- C. Nút chọn kiểu định hướng
- D. Giắc tai nghe
- E. Cổng cáp USB
- F. Cáp USB
- G. Bộ chuyển đổi giá*

*Hỗ trợ kích thước răng ốc 3/8" và 5/8"



Thông số kỹ thuật

Micro

Tiêu thụ điện năng: 5V 125mA

Tốc độ lấy mẫu/bit: 48kHz/16-bit

Thành phần: Micro tụ điện

Loại tụ: Ba tụ 14mm

Loại cực: Lập thể, đa chiều, cardioid, hai chiều

Đáp tuyến tần số: 20Hz - 20kHz

Độ nhạy: -36dB (1V/Pa ở 1kHz)

Chiều dài dây cáp: 3m

Trọng lượng:

- Micrô: 254g
- Giá giảm xóc và chân đế: 364g
- Tổng trọng lượng khi có cáp USB: 710g

Đầu ra tai nghe

Trở kháng: 32 Ω

Đáp tuyến tần số: 20Hz - 20kHz

Công suất đầu ra tối đa: 7mW

Tổng độ biến dạng sóng hài (THD): ≤ 0,05% (1kHz/0dBFS)

SNR: ≥ 90dB (1kHz, RL=∞)



Nút điều khiển micrô

Chọn một kiểu định hướng

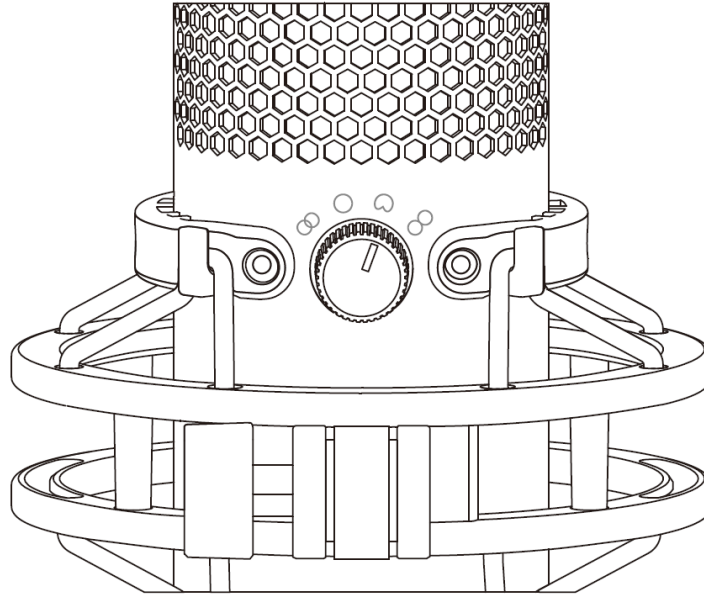

Xoay nút chọn kiểu định hướng để chọn một trong bốn kiểu định hướng.

Biểu tượng	Hướng âm thanh	Kiểu định hướng	Tình huống
		Nổi	Lời ca, nhạc cụ
		Đa chiều	Podcast nhiều người, cuộc gọi hội nghị
		Cardioid	Podcast, truyền phát, thuyết minh, nhạc cụ
		Hai chiều	Phòng vấn mặt đối mặt



Điều chỉnh khuếch đại

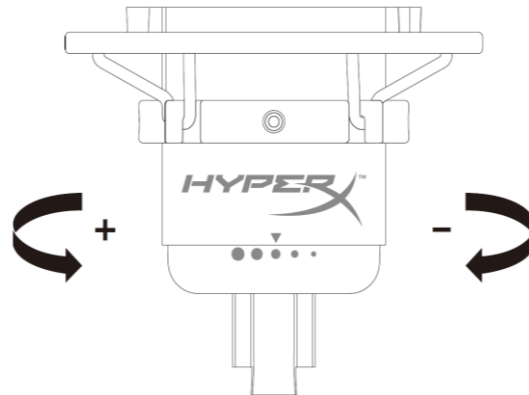

Xoay núm khuếch đại để điều chỉnh độ khuếch đại của micrô.

Tắt tiếng micrô

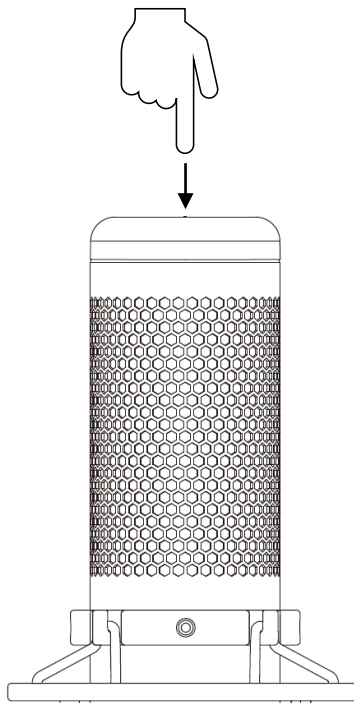

Chạm vào đỉnh của micrô để tắt tiếng/bật tiếng của micrô. Đèn LED của micrô sẽ thể hiện trạng thái tắt tiếng hiện tại của micrô.

Đèn LED của micrô	Trạng thái tắt tiếng
Đỏ	Đang bật tiếng
Tắt	Đang tắt tiếng



Sử dụng với PC hoặc Mac

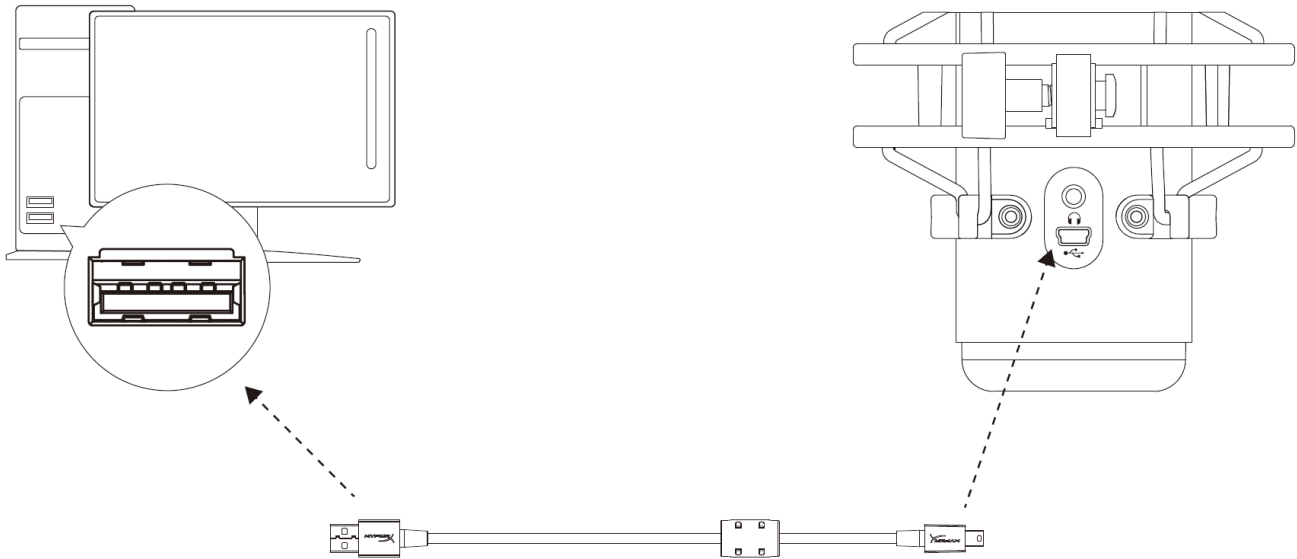

Kết nối micrô với cổng USB trên PC hoặc Mac với cáp USB đi kèm.

Windows

Để bảo đảm micrô được cấu hình đúng trên máy tính, hãy làm theo các bước dưới đây:

1. Nhấp chuột phải vào biểu tượng âm thanh trên khay hệ thống và chọn **Sounds**.

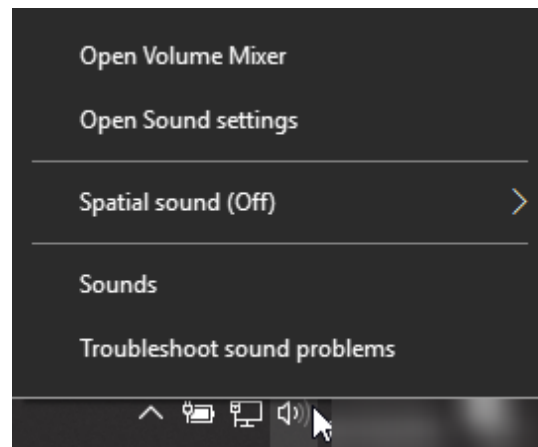



- Trên thẻ *Playback*, chọn **Speakers HyperX QuadCast** và nhấp vào nút **Set Default** .

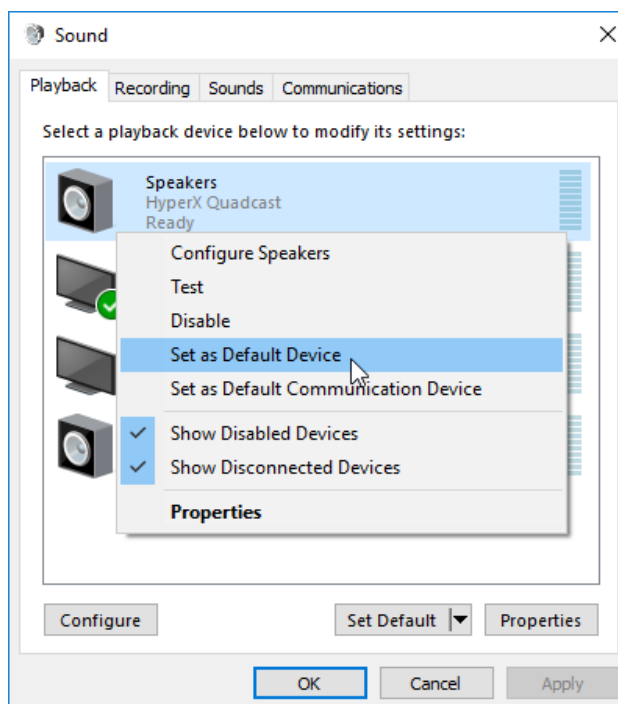

- Trên thẻ *Recording*, chọn **Microphone HyperX QuadCast** và nhấp vào nút **Set Default** .

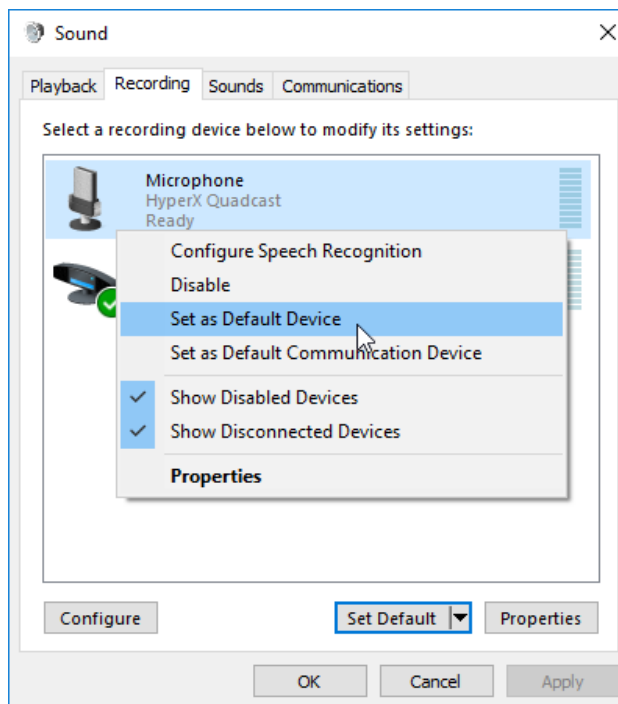



macOS

Để bảo đảm micrô được cấu hình đúng trên macOS, hãy làm theo các bước dưới đây:

1. Mở **System Preferences** và chọn **Sound**.

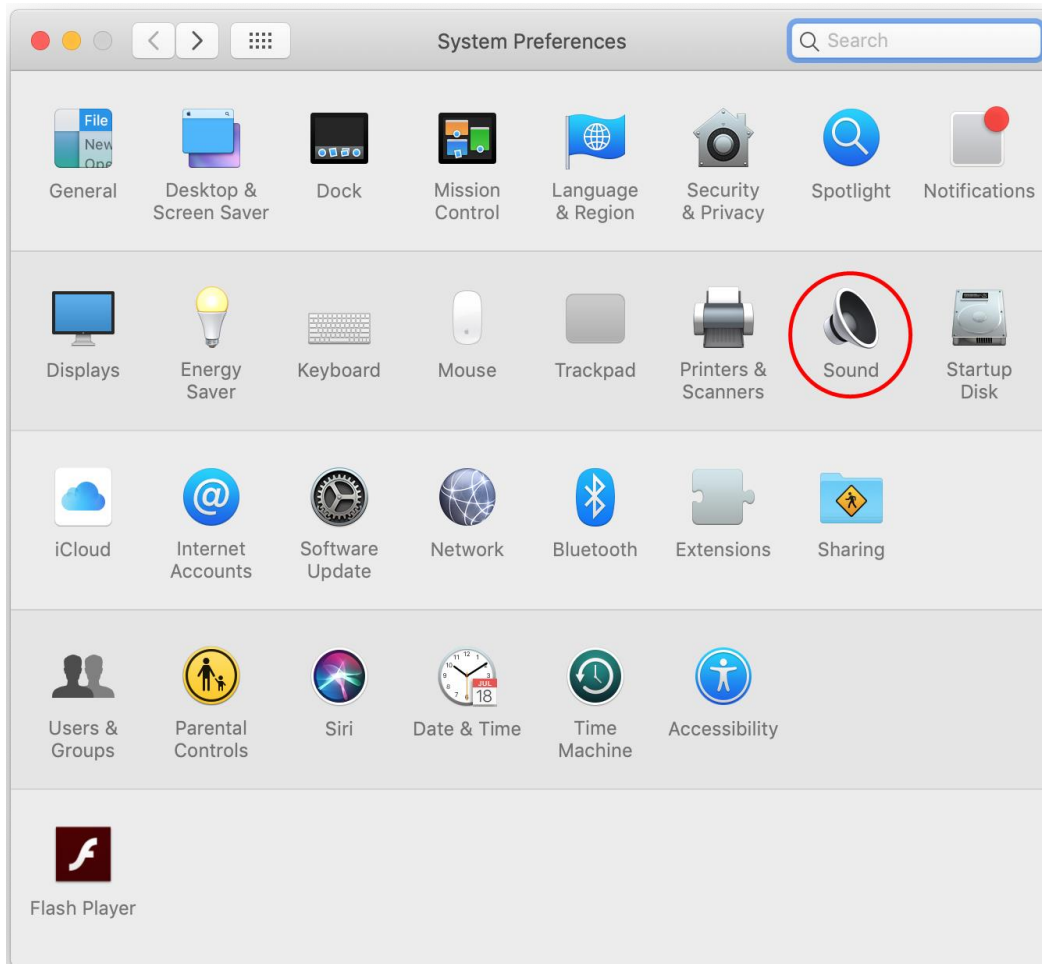



2. Trên tab *Output*, chọn **HyperX QuadCast**.

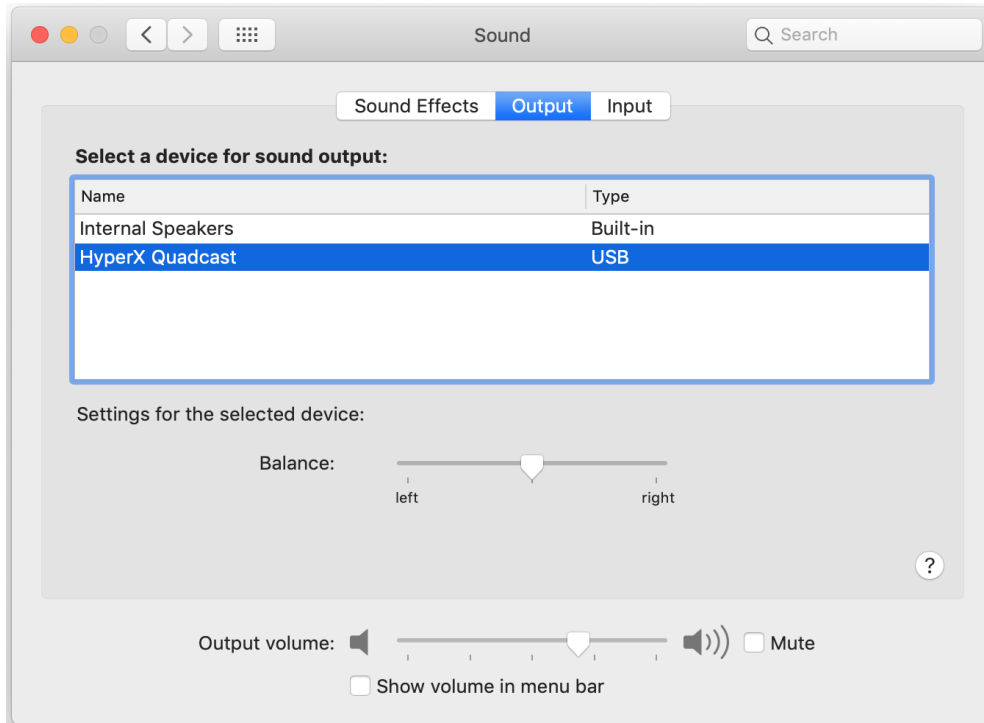

3. Trên tab *Input*, chọn **HyperX QuadCast**.

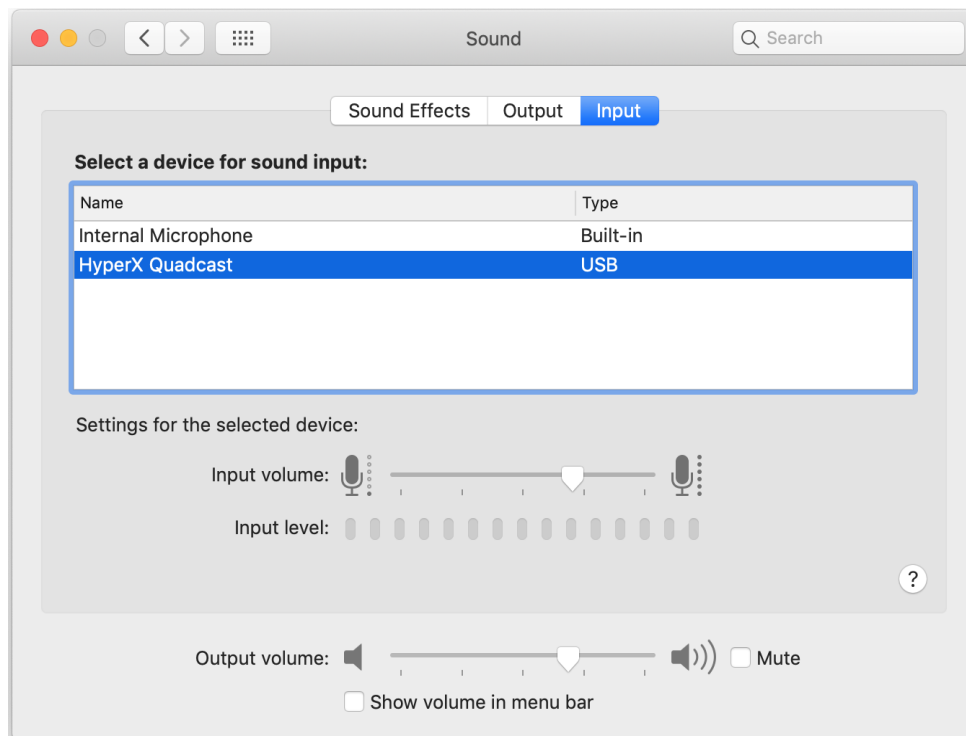



Sử dụng với PS4™

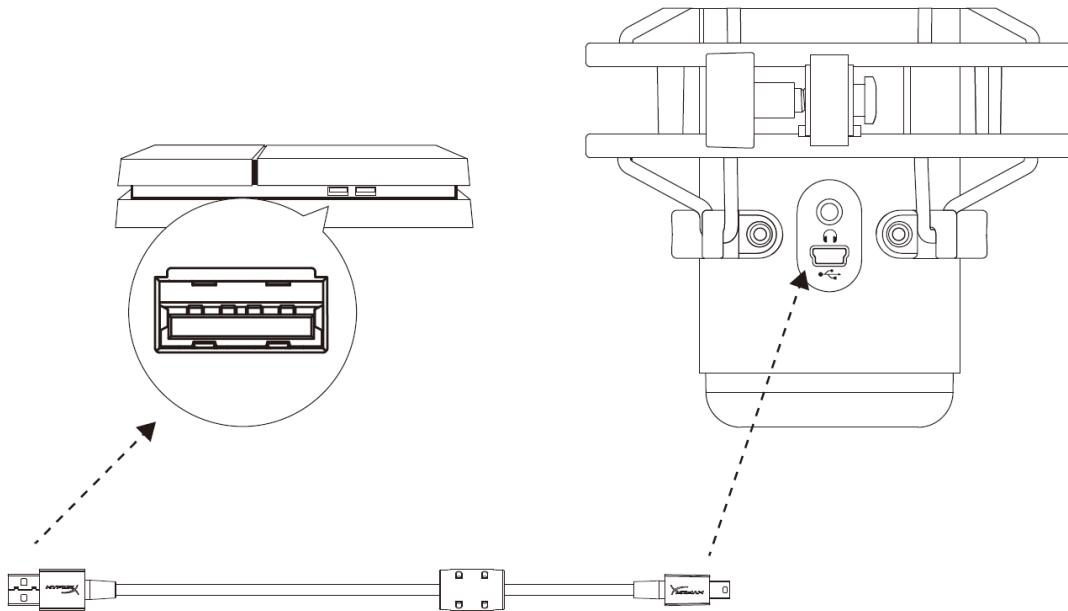

Kết nối micrô với cổng USB trên PS4 với cáp USB đi kèm.

Để bảo đảm micrô được cấu hình với thiết lập tối ưu trên PS4, hãy làm theo các bước dưới đây:

1. Từ trình đơn chính của PS4, vào **Settings > Devices > Audio Devices**
2. Đặt *Input Device* thành **USB Headset (HyperX QuadCast)**
3. Đặt *Output Device* thành **USB Headset (HyperX QuadCast)**
4. Đặt *Output to Headphones* thành **All Audio**
5. Đặt *Volume Control (Headphones)* thành mức âm lượng mong muốn

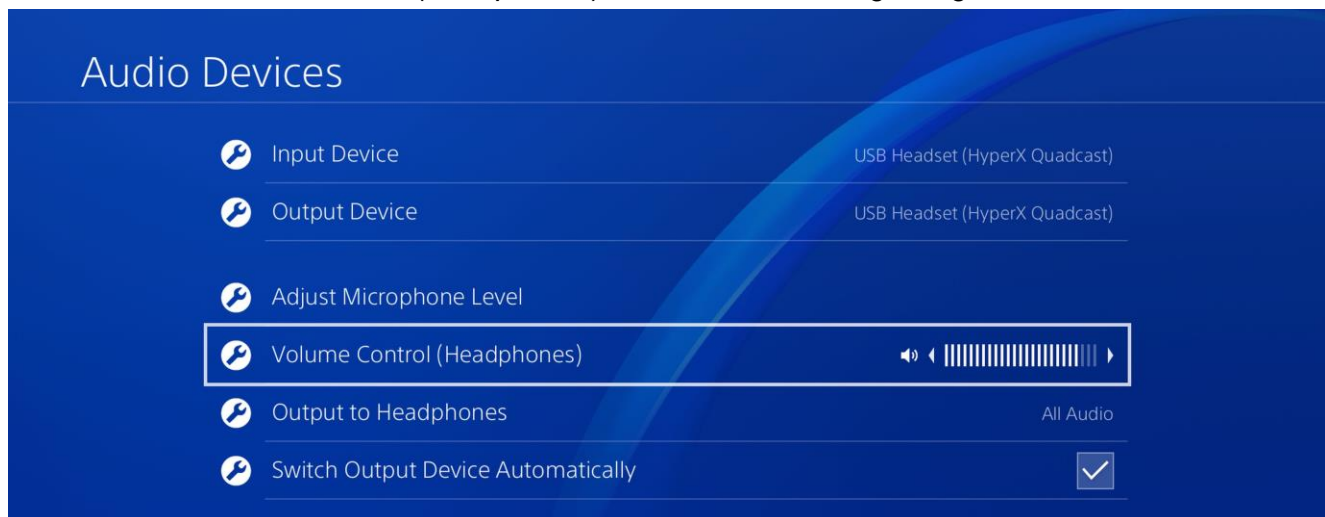



Kết nối tai nghe

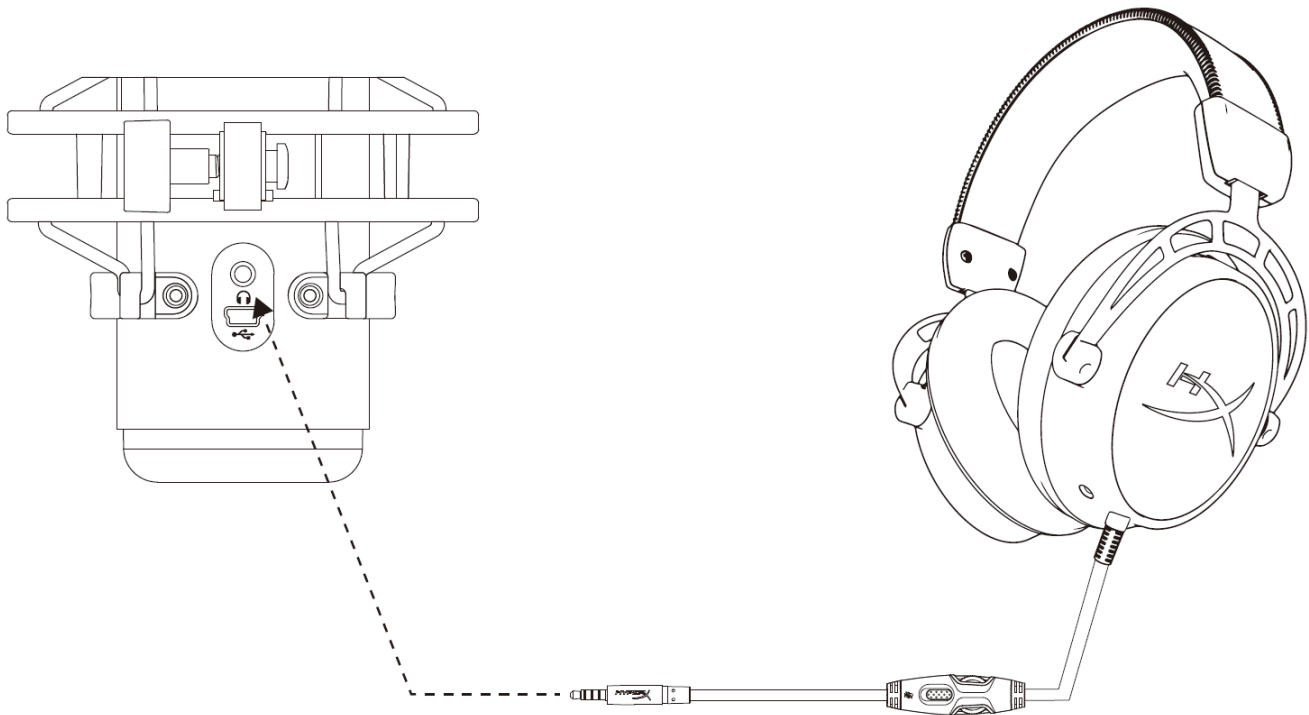

Kết nối tai nghe với giắc tai nghe trên micrô để theo dõi micrô và phát lại âm thanh.



Điều khiển giám sát tai nghe

PC

1. Từ bảng điều khiển Sound, trên tab *Playback*, nhấp chuột phải vào **Speakers HyperX QuadCast** và chọn **Properties**.

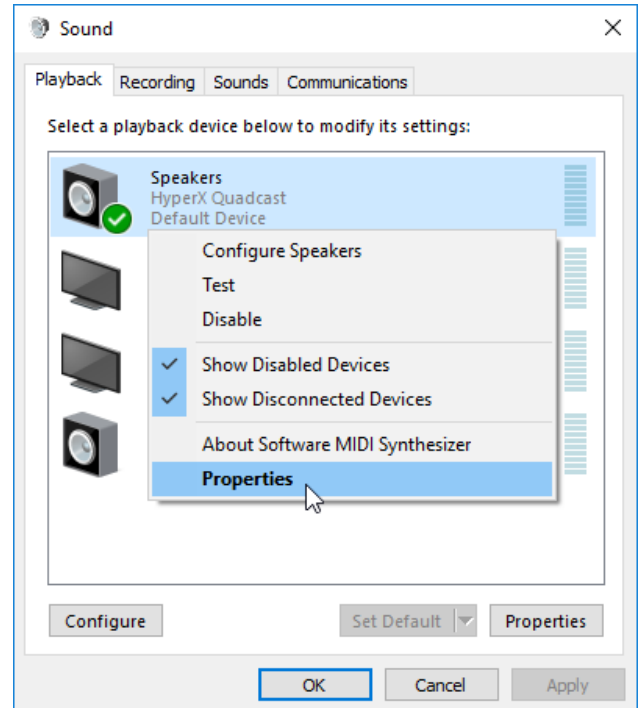

2. Trên tab *Levels*, điều chỉnh thanh trượt âm lượng **Microphone** để điều chỉnh mức độ theo dõi micrô.

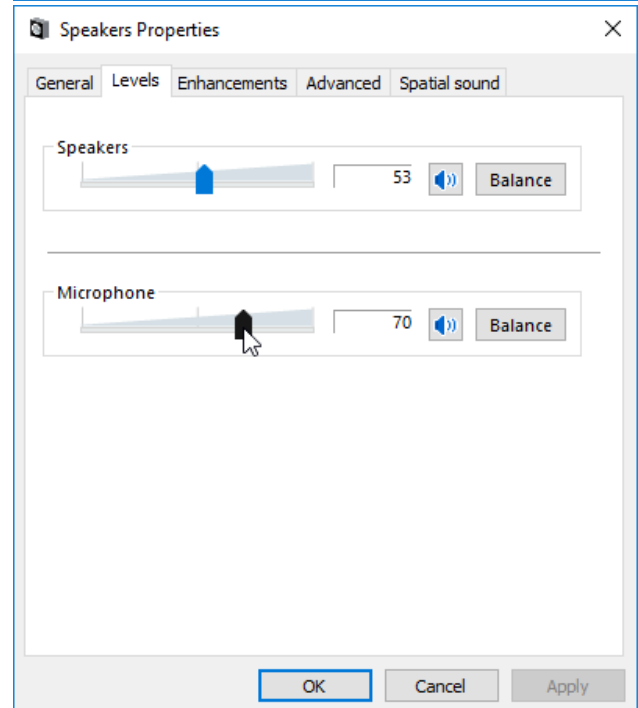



macOS

1. Mở ứng dụng **Finder** và vào **Applications > Utilities > Audio MIDI Setup**

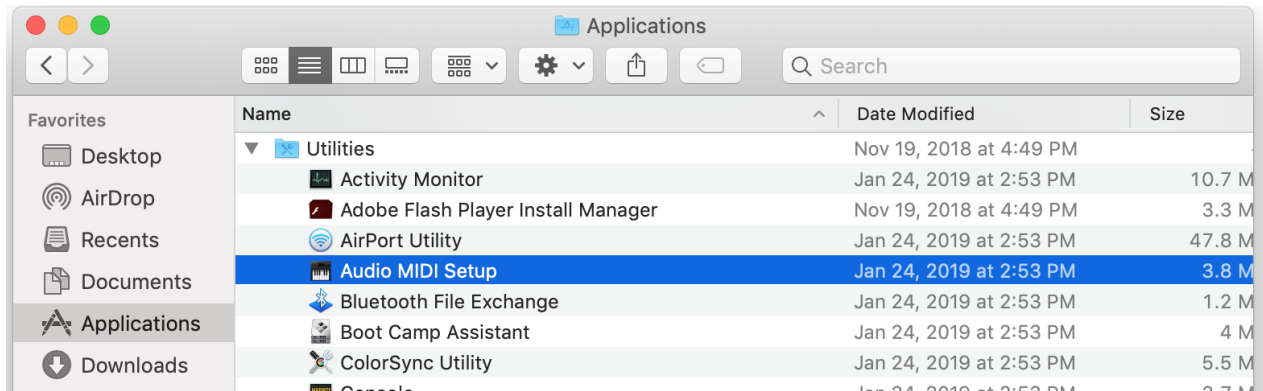

2. Nhấp vào **HyperX QuadCast 2** và nhấp vào hộp kiểm dưới cột *Thru* để bật hoặc tắt giám sát tai nghe.

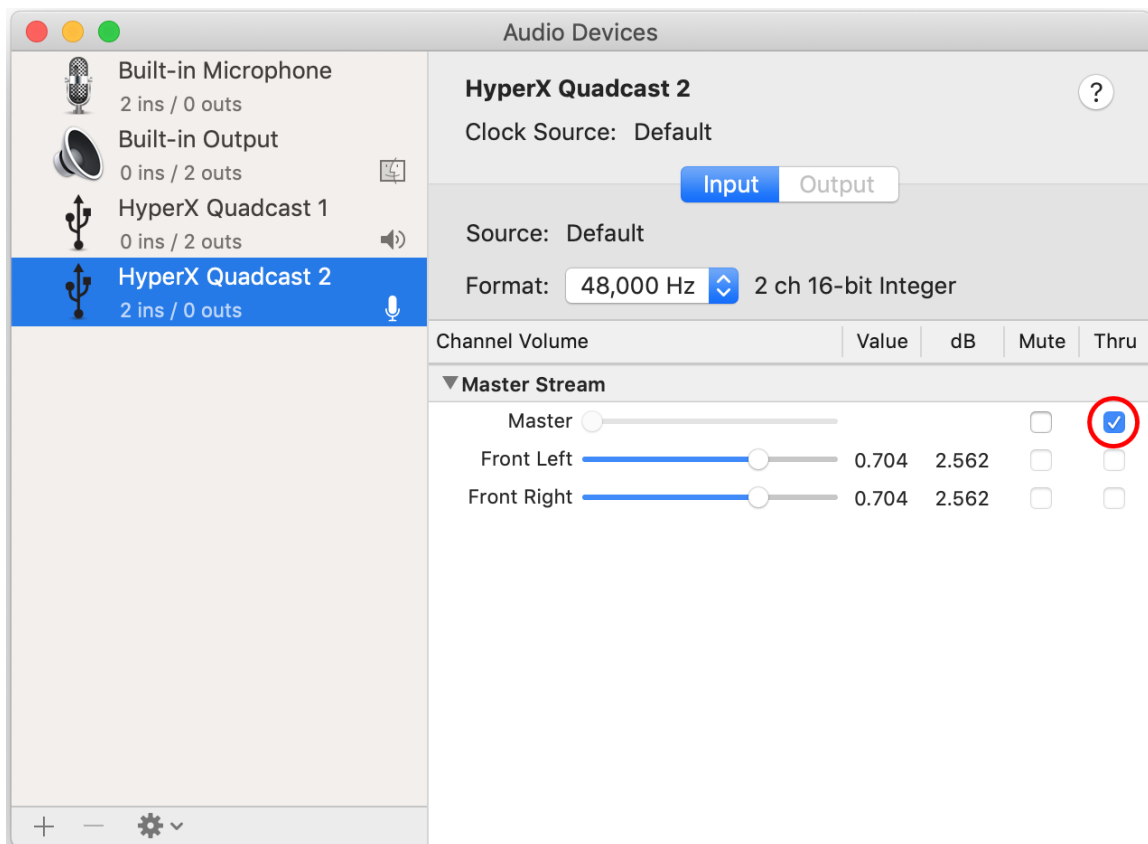

PS4

Không thể trực tiếp điều khiển mức độ giám sát tai nghe trên PS4.



Cài đặt bộ chuyển đổi giá

1. Gắn bộ chuyển đổi giá đi kèm vào tay cầm boom của micrô. Bộ chuyển đổi giá hỗ trợ kích thước răng ốc 3/8" và 5/8".
2. Tháo cả ốc vặn tay và đai ốc ra khỏi chân đế của micrô.
3. Tháo chân đế micrô ra khỏi micrô.
4. Căn bộ chuyển đổi giá với các lỗ lắp micrô và gắn bộ chuyển đổi bằng ốc vặn tay và đai ốc.



Có câu hỏi hay gặp vấn đề về cài đặt?

Liên hệ nhóm hỗ trợ HyperX tại: hyperxgaming.com/support/



HyperX QuadCast[™]



产品型号

HX-MICQC-BK



目录

概述	3
规格	4
麦克风控件.....	5
与 PC 或 Mac 一起使用	7
与 PS4 [™] 一起使用	11
连接耳机	12
控制耳机监控	13
安装支座适配器	15



概述

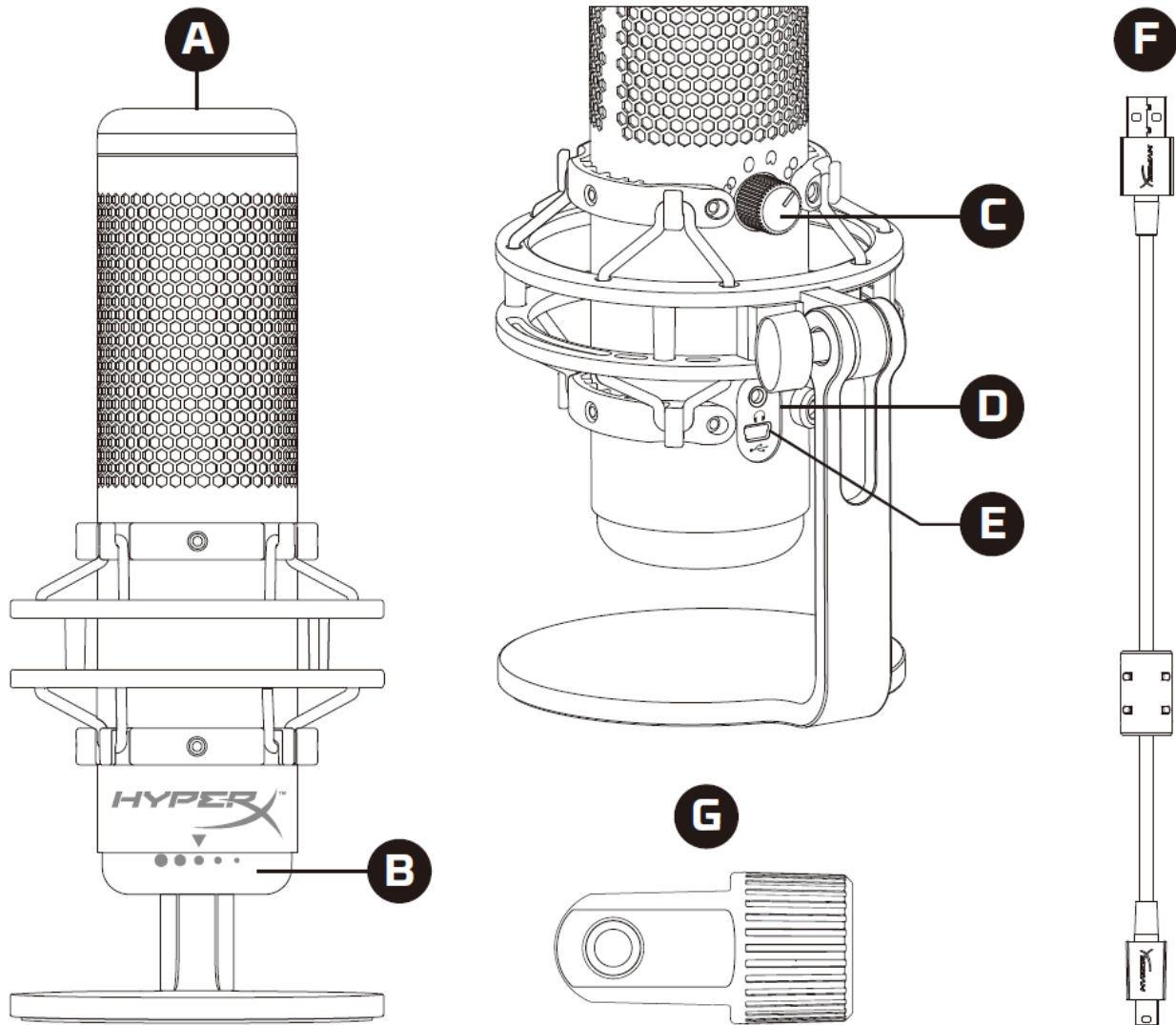

- A. 点击静音传感器
- B. 增益控制旋钮
- C. 极性模式旋钮
- D. 耳机插孔
- E. USB 电缆端口
- F. USB 连接线
- G. 支座适配器*

*支持 3/8" 和 5/8" 螺纹规格



规格

麦克风

功耗: 5V 125mA

采样/位速率: 48kHz/16 位

元件: 驻极体话筒

电容式类型: 三个 14 毫米电容

极性模式: 立体声、全向、心形、双向

频率响应: 20Hz - 20kHz

灵敏度: -36dB (1kHz 时 1V/Pa)

线缆长度: 3 米

重量:

- 麦克风: 254 克
- 缓冲支座和立架: 364 克
- 含 USB 线缆的总重量: 710 克

耳机输出

阻抗: 32 Ω

频率响应: 20Hz - 20kHz

最大功率输出: 7mW

总谐波失真 (THD): $\leq 0.05\%$ (1kHz/0dBFS)

SNR: $\geq 90\text{dB}$ (1kHz, $R_L = \infty$)







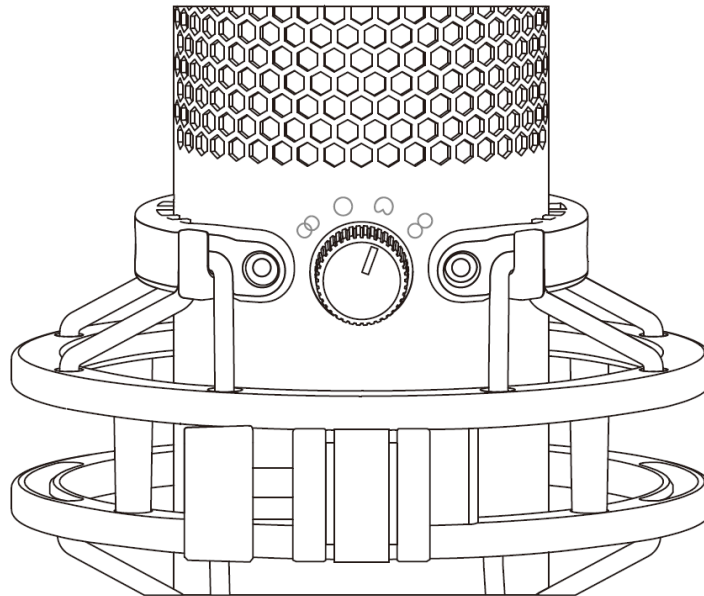

麦克风控件

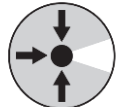
选择一种极性模式

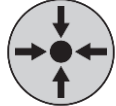

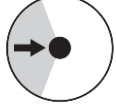
旋转极性模式旋钮，从四种极性模式中选择其中一种。

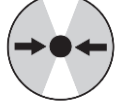
符号	声音方向	极性模式	情景
		立体声	声乐，乐器
		全向	多人播客，电话会议
		心型	播客，流媒体，旁白，乐器
		双向	面对面对话



调节增益控制

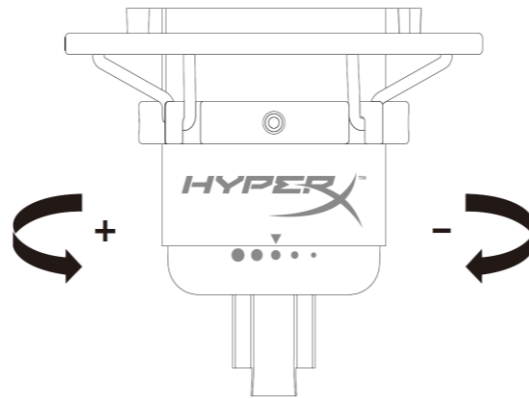

旋转增益控制旋钮，以调节麦克风增益。

麦克风静音

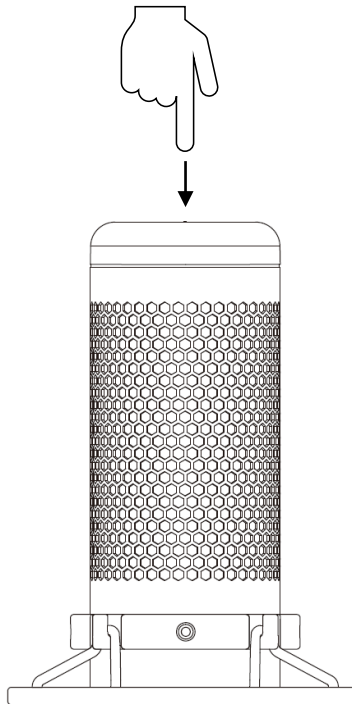

接触麦克风顶部，以静音麦克风/取消麦克风静音。麦克风 LED 灯将指明麦克风当前的静音状态。

麦克风 LED 灯	静音状态
红色	关闭静音
关闭	打开静音



与 PC 或 Mac 一起使用

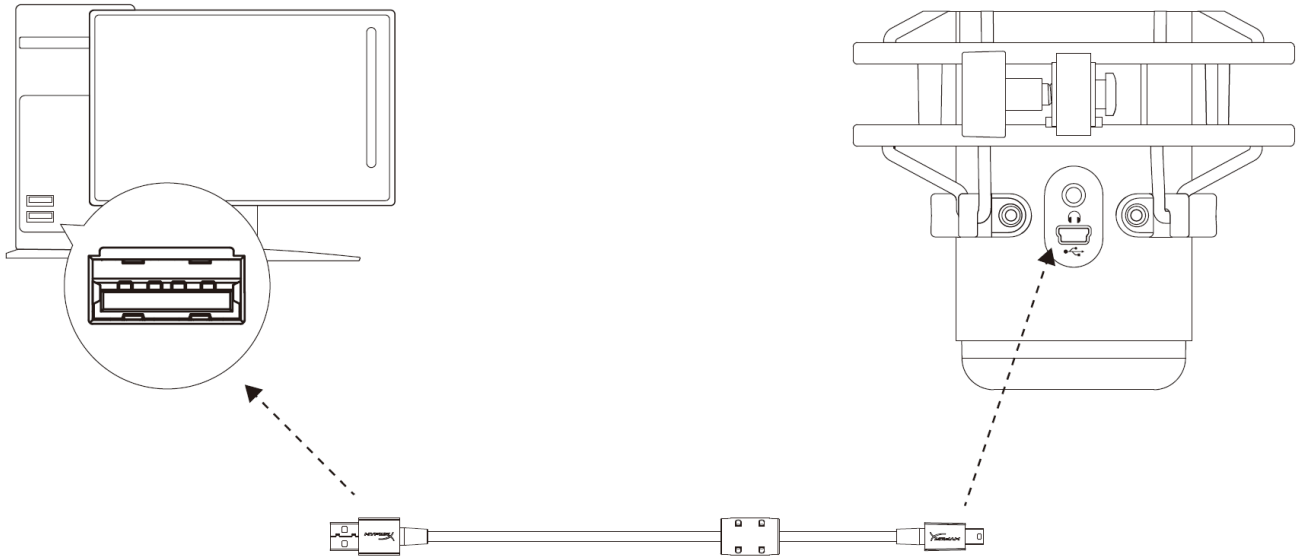

用随附的 USB 线缆将麦克风连接到 PC 或 Mac 上的 USB 端口。

Windows

为确保在 PC 上正确配置麦克风，请按如下步骤设置：

1. 右键单击系统托盘上的声音图标，
并选择声音。

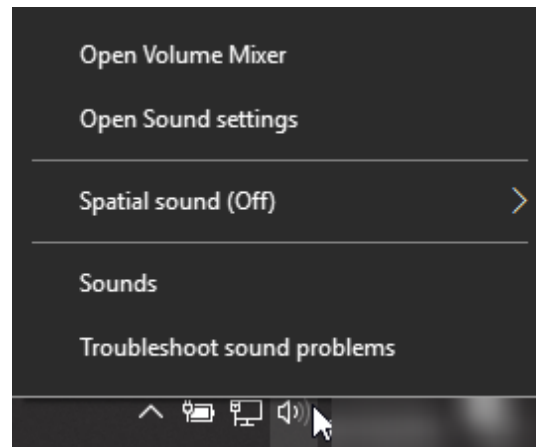



2. 在播放选项卡上，选择扬声器 **HyperX QuadCast**，并单击**设置默认值**按钮。

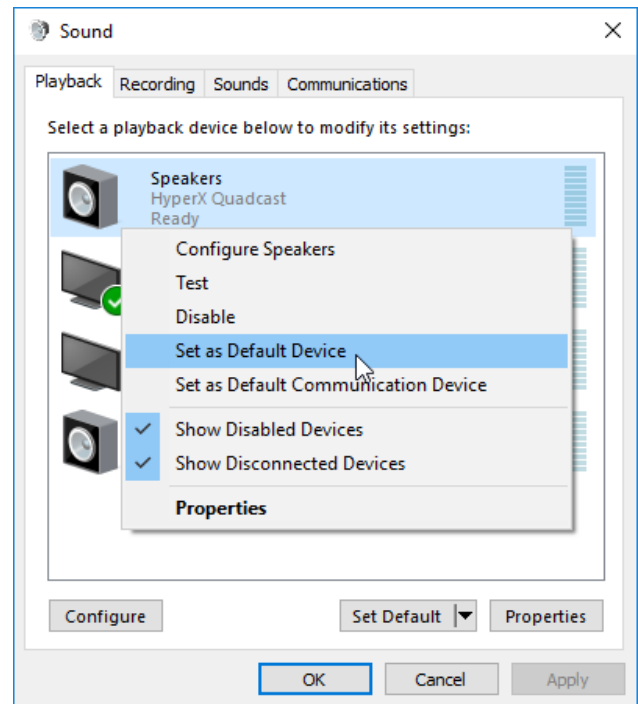

3. 在录音选项卡上，选择麦克风 **HyperX QuadCast**，并单击**设置默认值**按钮。

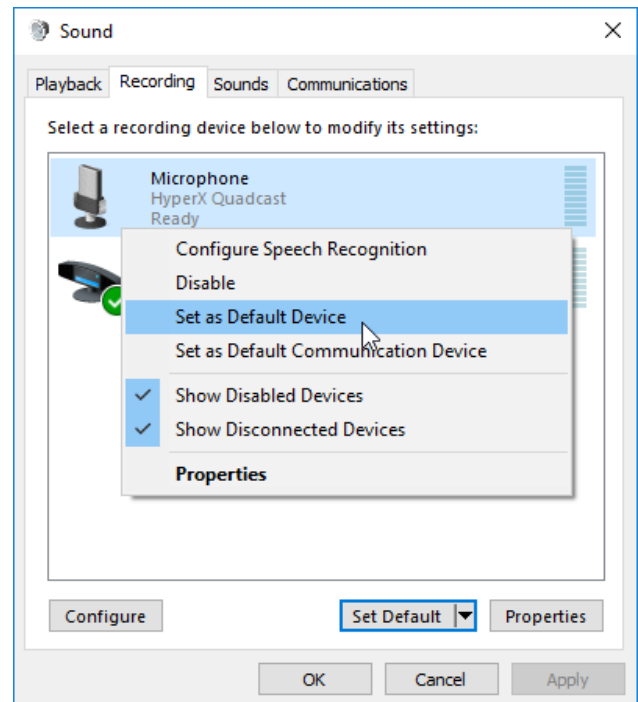



macOS

为确保在 macOS 上正确配置麦克风，请按如下步骤设置：

1. 打开**系统偏好**并选择**声音**。

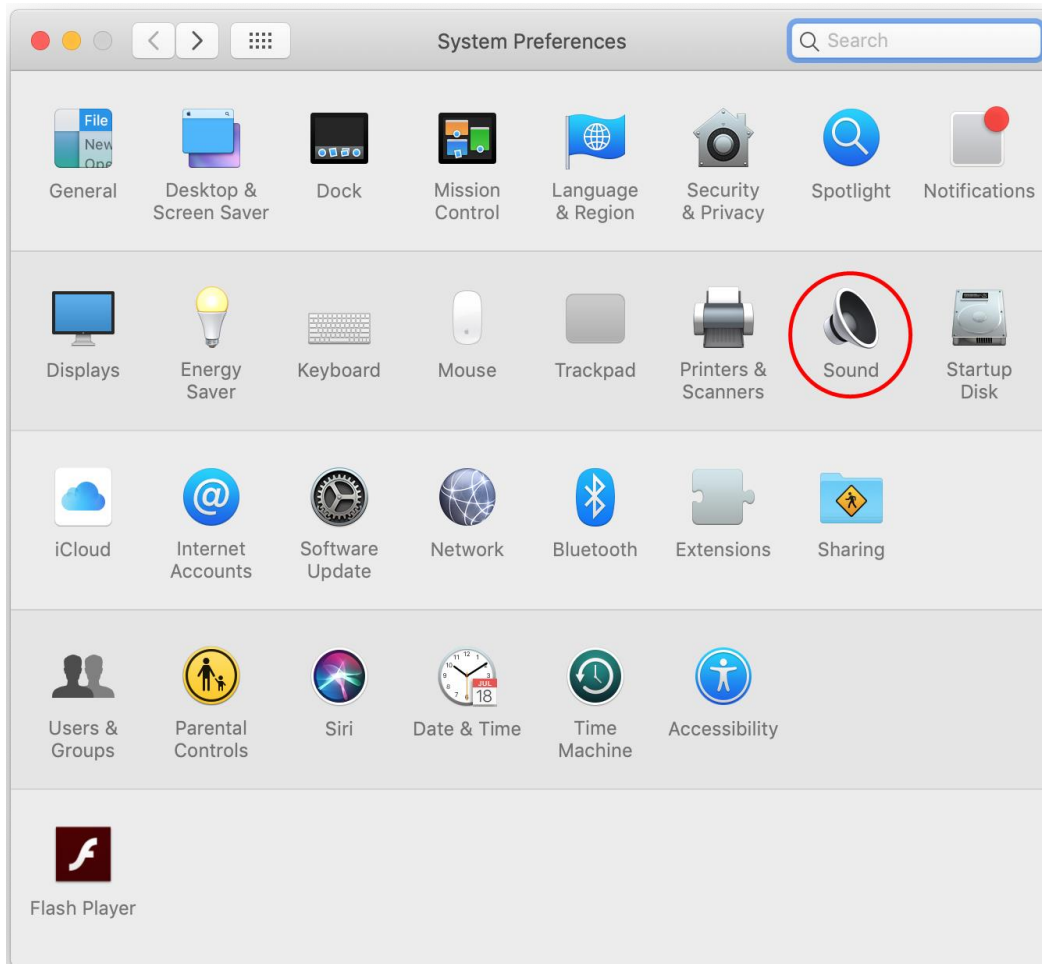



2. 在输出选项卡上，选择 **HyperX QuadCast**。

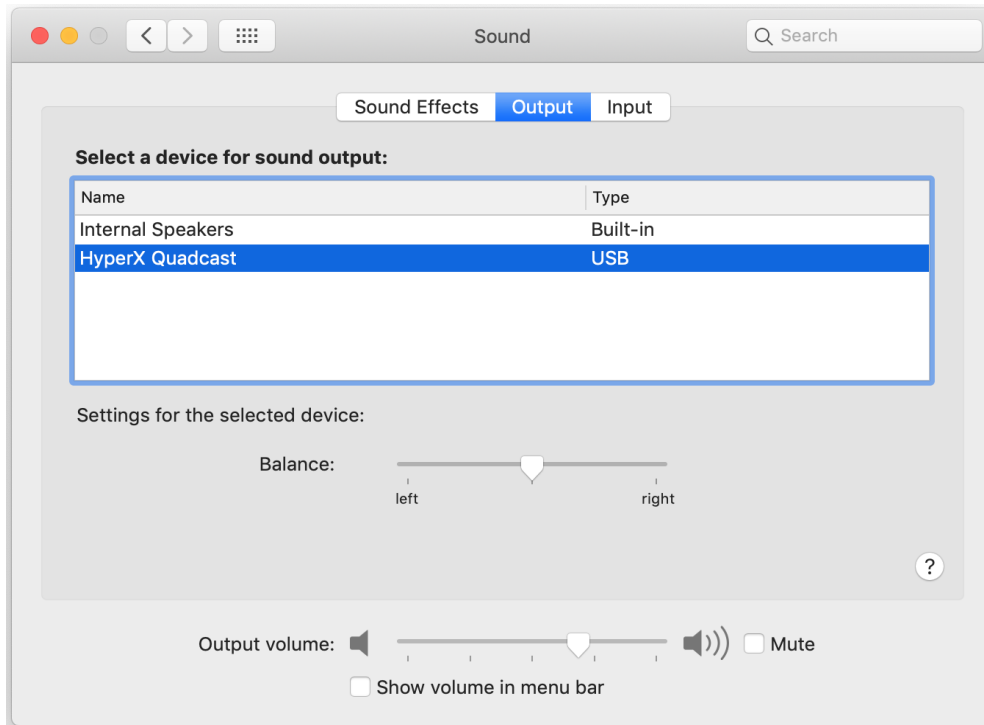

3. 在输入选项卡上，选择 **HyperX QuadCast**。

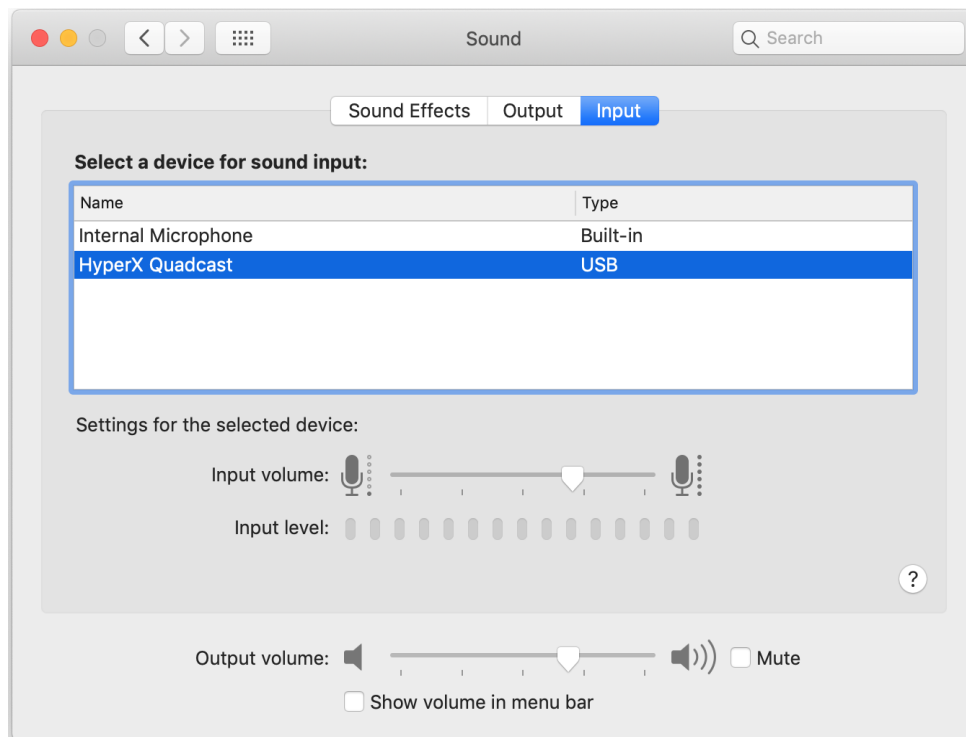



与 PS4™ 一起使用

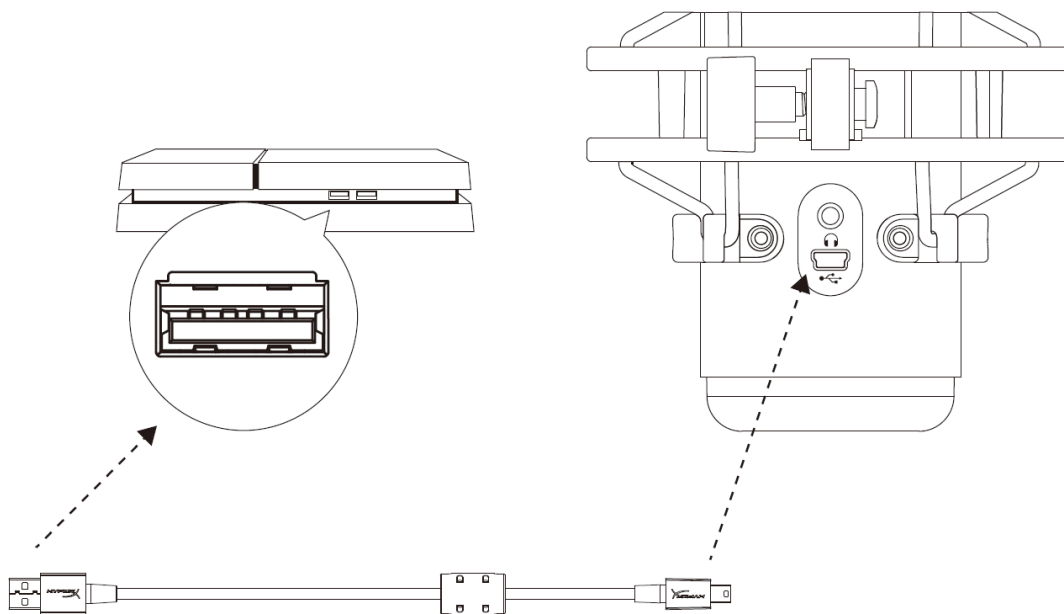

用随附的 USB 线缆将麦克风连接到 PS4 上的 USB 端口。

为确保麦克风在 PS4 上配置了最优设置，请按如下步骤设置：

1. 从 PS4 主菜单中，转至 **设置 > 设备 > 音频设备**
2. 将 **输入设备** 设置为 **USB 耳机 (HyperX QuadCast)**
3. 将 **输出设备** 设置为 **USB 耳机 (HyperX QuadCast)**
4. 将 **输出到耳机** 设置为 **所有音频**
5. 将 **音量控制 (耳机)** 设置成所需的音量

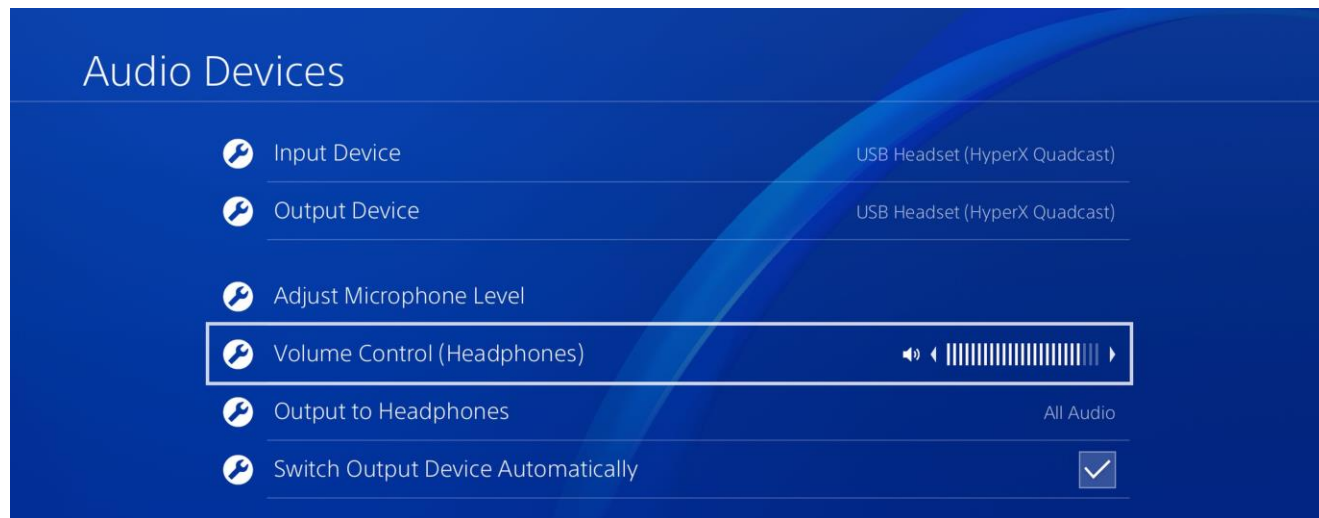



连接耳机

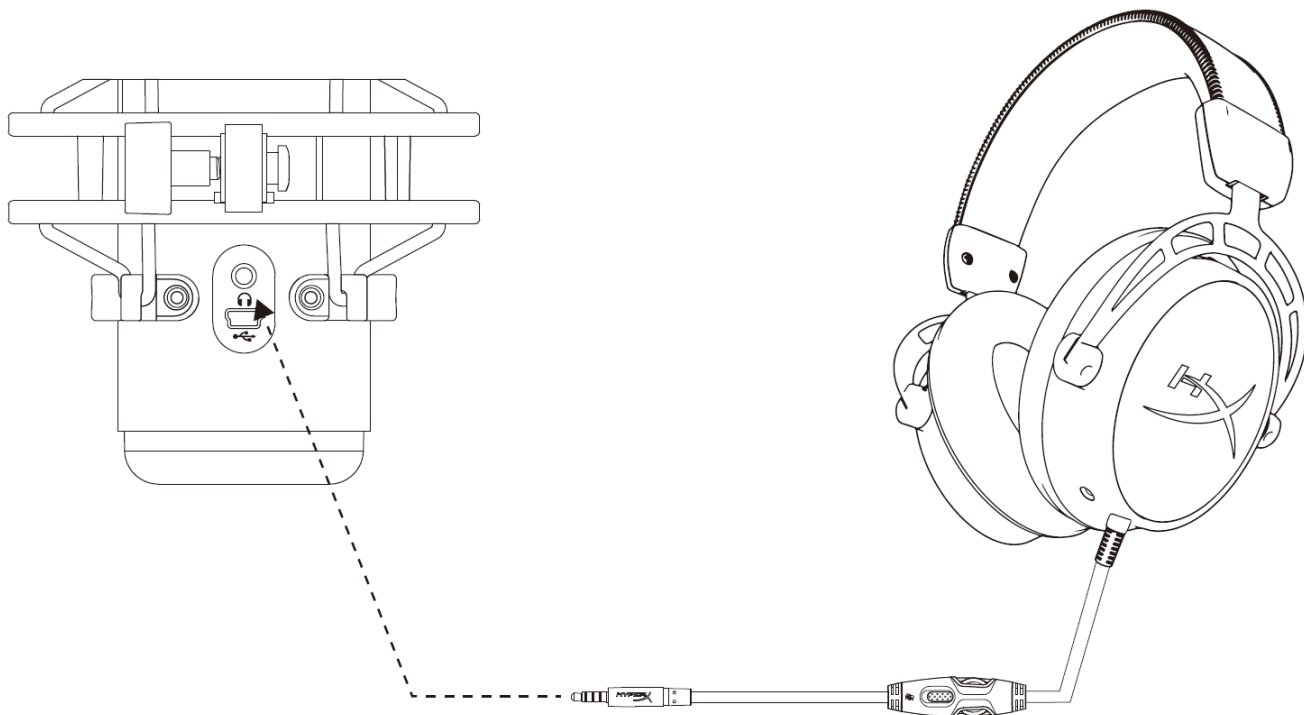

将耳机连接至麦克风上的耳机插孔，以监控麦克风并播放视频。



控制耳机监控

PC

1. 打开“声音”控制面板，在播放选项卡上右键单击扬声器 HyperX QuadCast，并选择属性。

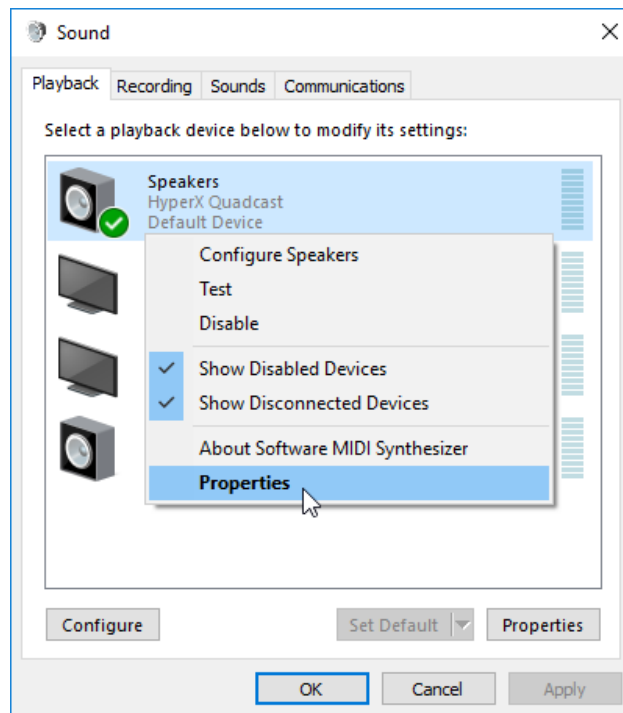

2. 在级别选项卡上调整麦克风音量滑块，以调整麦克风监控的级别。

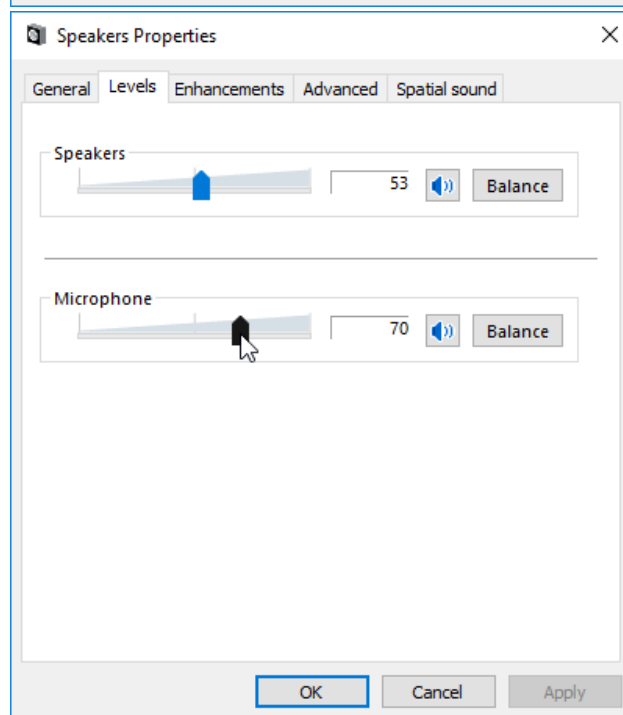



macOS

1. 打开“**Finder**”应用程序，转至**应用程序 > 实用程序 > 音频 MIDI 设置**

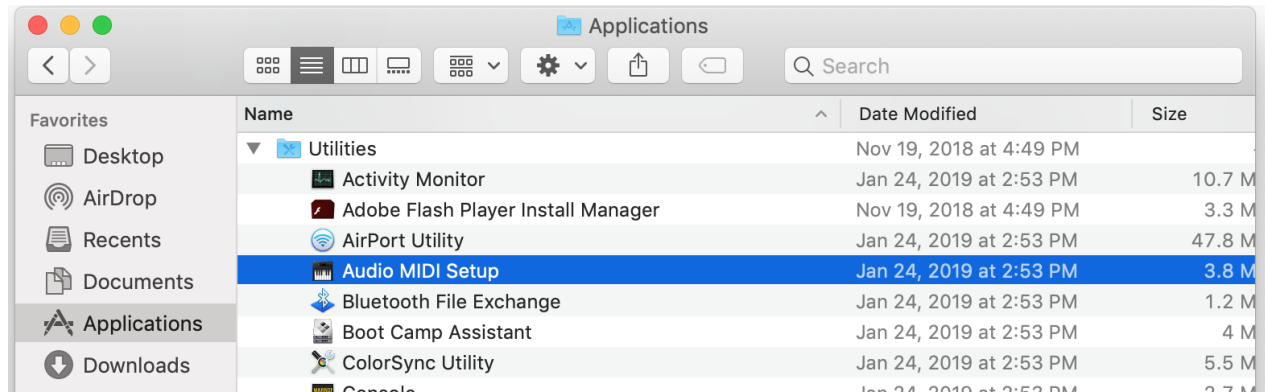

2. 单击 **HyperX QuadCast 2**，然后单击“*Thru*”列下的复选框，以打开或关闭麦克风监控。

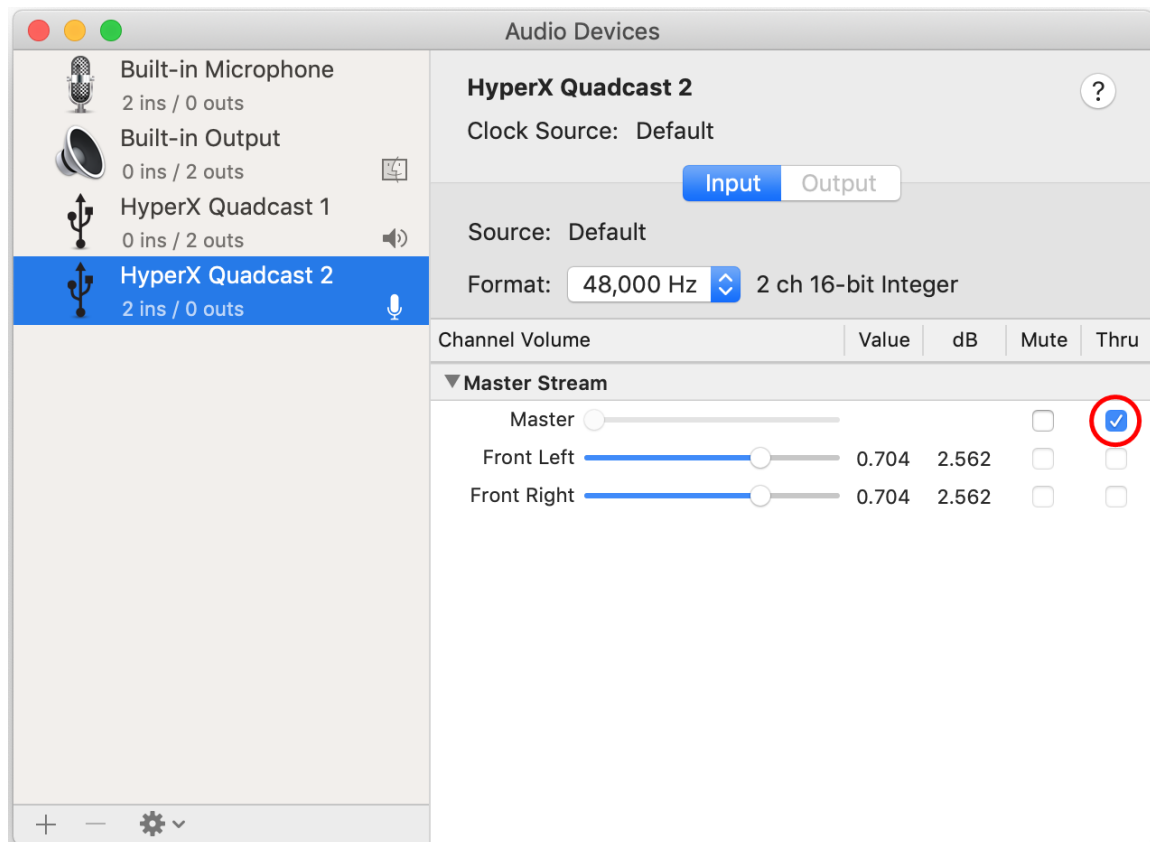

PS4

不能在 PS4 上直接控制麦克风监控级别。



安装支座适配器

1. 将随附的支座适配器固定在麦克风悬臂上。支座适配器支持 3/8" 和 5/8" 螺纹规格。
2. 从麦克风支架上取下拇指螺丝和螺母。
3. 从麦克风上取下麦克风立架。
4. 将支座适配器与麦克风支座孔对齐，并用拇指螺丝和螺母固定适配器。



存有疑问或遇到设置问题？

请联系 HyperX 支持团队：hyperxgaming.com/support/



HyperX QuadCast[™]



產品型號

HX-MICQC-BK



目錄

概觀	3
產品規格	4
麥克風控制.....	5
使用於 PC 或 Mac	7
使用於 PS4™	11
連接麥克風.....	12
控制麥克風收音音量	13
安裝轉接頭.....	15



概觀

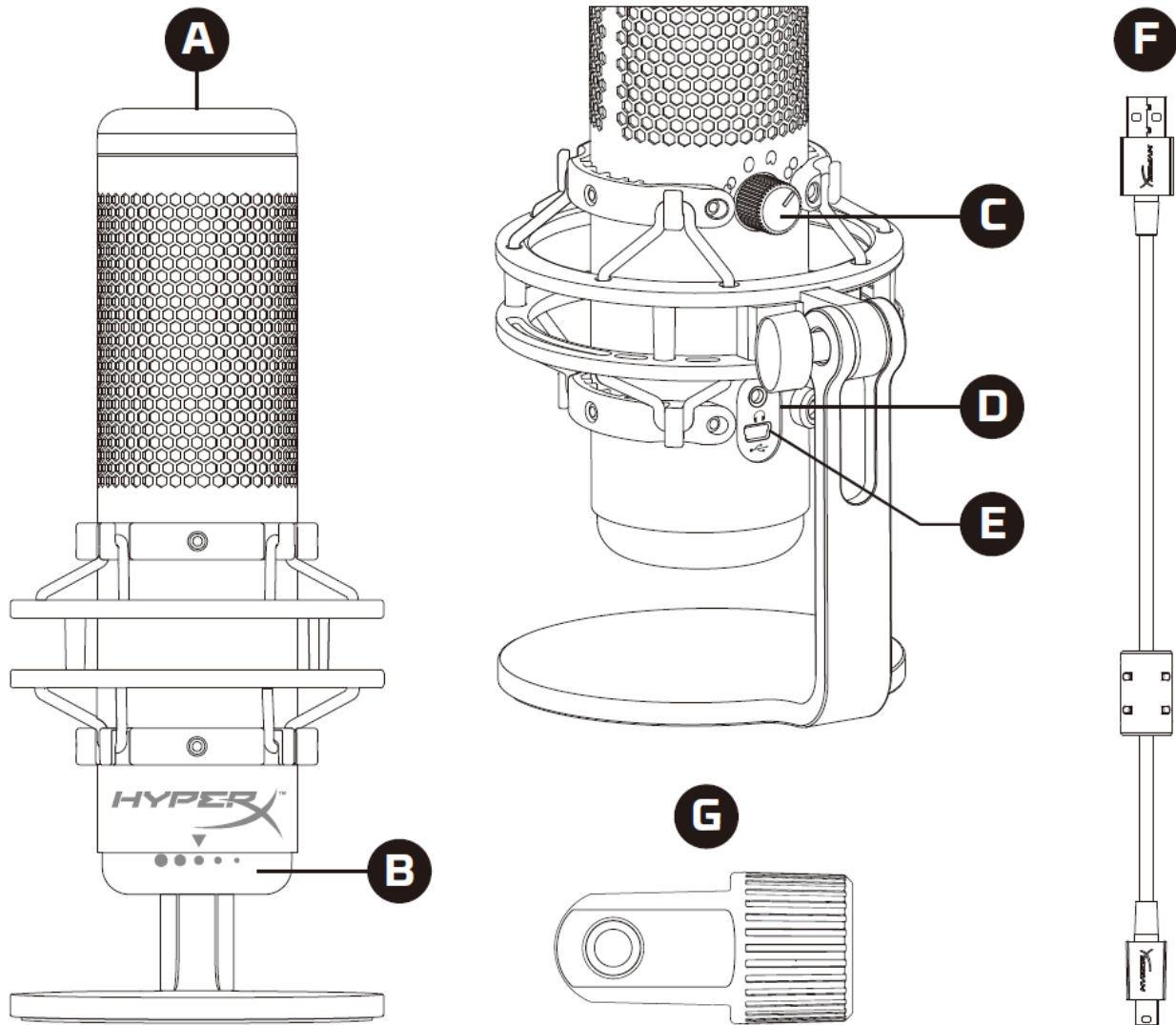

- A. 觸控式靜音控制
- B. 增益控制旋鈕
- C. 指向性型式旋鈕
- D. 耳機插孔
- E. USB 線連接埠
- F. USB 線
- G. 安裝用轉接頭*

*支援 3/8" 和 5/8" 螺紋尺寸



產品規格

麥克風

耗電量：5V 125mA

取樣/位元率：48kHz/16 位元

元件：駐極體電容式麥克風

電容式類型：三個 14mm 電容式振膜艙

指向性型式：立體聲、全向性、心型、雙指向

頻率響應：20Hz - 20kHz

靈敏度：-36dB (1kHz 時為 1V/Pa)

線長：3m

重量：

- 麥克風：254g
- 避震架及底座：364g
- 含 USB 線總重：710g

耳機輸出

阻抗：32 Ω

頻率響應：20Hz - 20kHz

最大功率輸出：7mW

總諧波失真: $\leq 0.05\%$ (1kHz/0dBFS)

SNR: $\geq 90\text{dB}$ (1kHz, $R_L = \infty$)







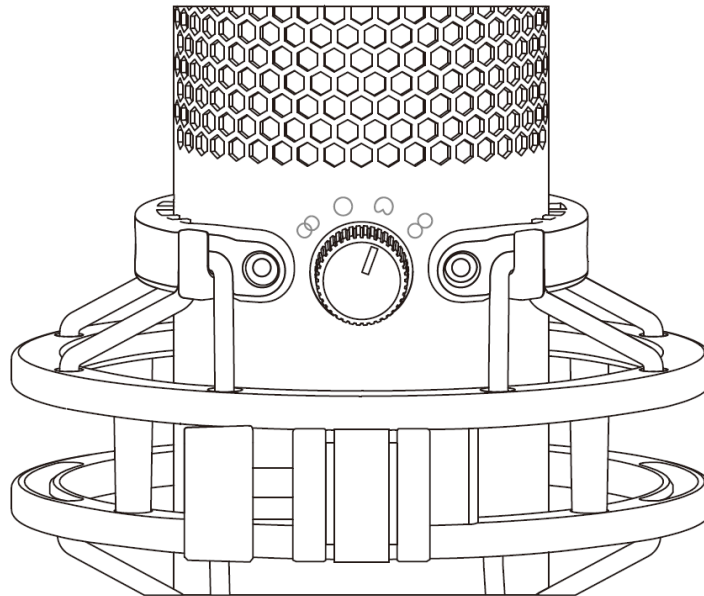

麥克風控制

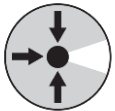
選擇指向性型式

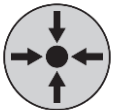

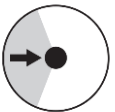
轉動旋鈕，切換指向性型式。

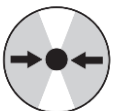
符號	收音方向	指向性型式	適用情境
		立體聲	人聲、樂器
		全向性	多人 podcast、 電話會議
		心型	Podcast、 實況、旁白、樂器
		雙指向	面對面採訪



調整增益控制

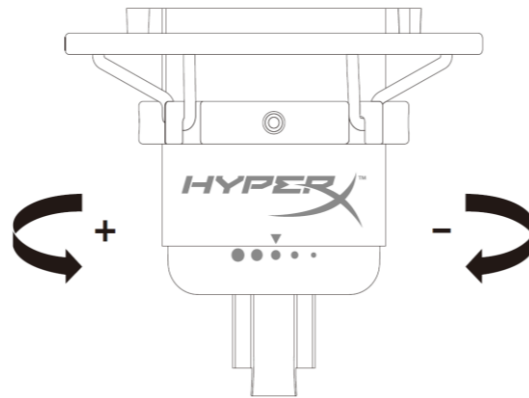

轉動控制旋鈕來調整麥克風增益。

靜音麥克風

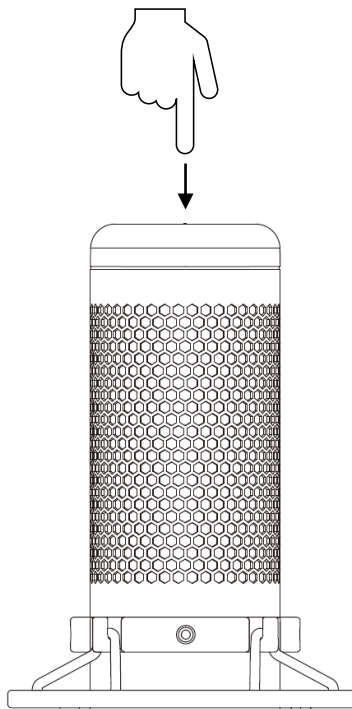

觸控麥克風上方可啟用或解除麥克風靜音。LED 燈將顯示目前的麥克風靜音狀態。

麥克風 LED 指示燈	靜音狀態
指示燈亮起 (紅色)	麥克風收音中
指示燈熄滅	麥克風靜音



使用於 PC 或 Mac

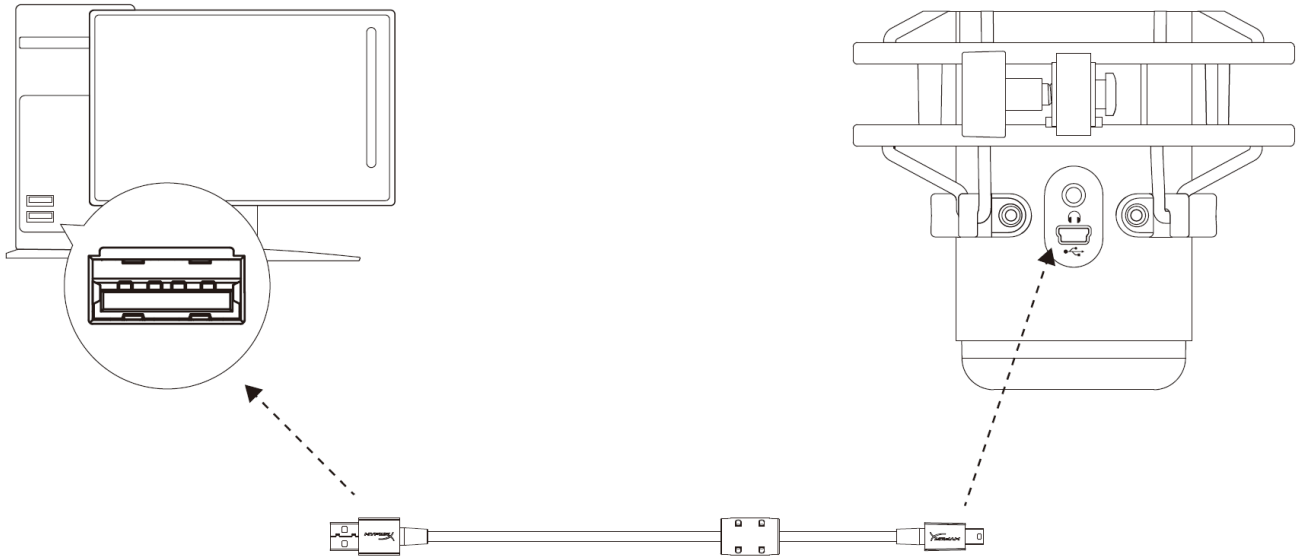

透過隨附的 USB 線將麥克風連接到 PC 或 Mac 上的 USB 連接埠。

Windows

為了確保麥克風在電腦上是以正確設定運作，請依照以下步驟進行設置：

1. 以右鍵按下系統工具列的音量圖示，
並選擇 **音效**。

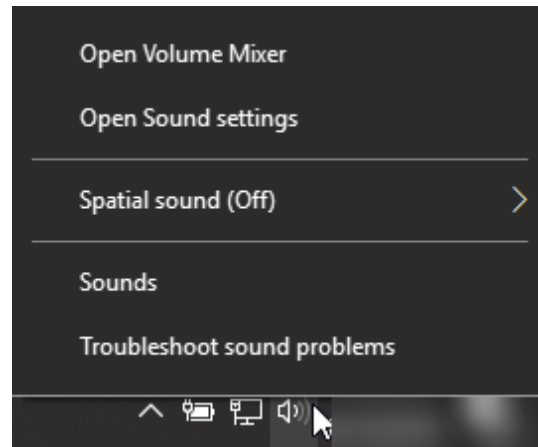



- 在[播放]分頁，選擇[喇叭 HyperX QuadCast]後，點選[設為預設裝置]按鍵。

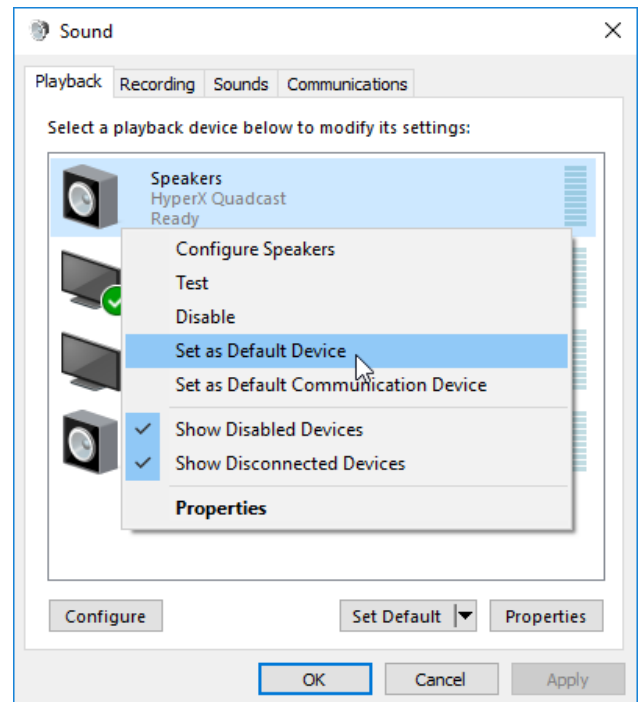

- 在[錄製]分頁，選擇[麥克風 HyperX QuadCast]後，點選[設為預設裝置]按鍵。

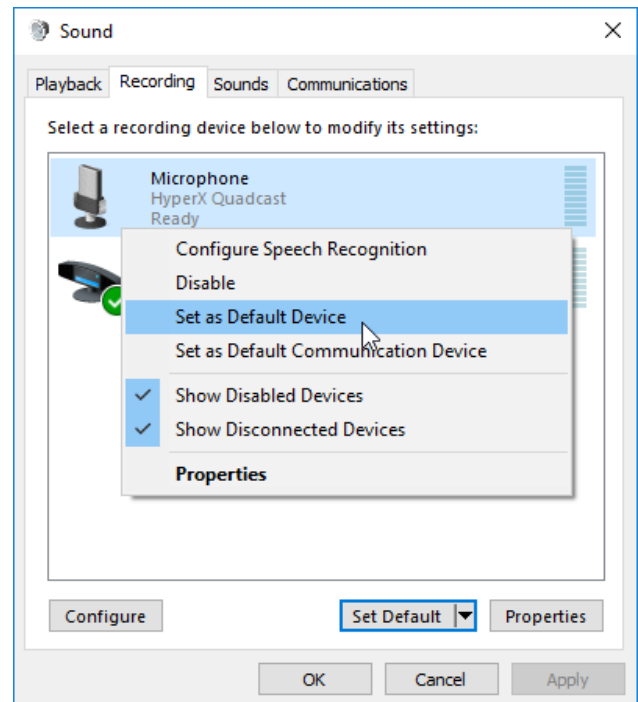



macOS

為了確保麥克風在 macOS 上是以正確設定運作，請依照以下步驟進行設置：

1. 開啟【系統偏好設定】後，選擇【聲音】。

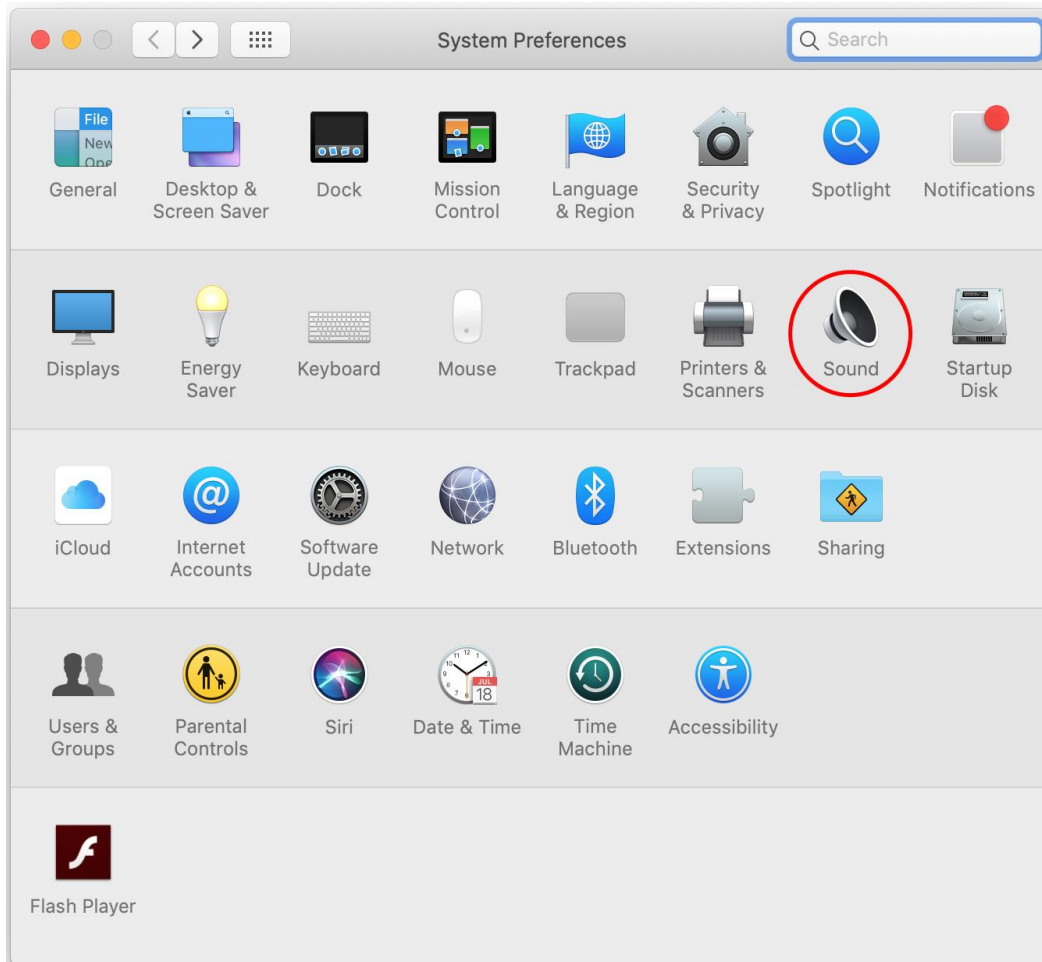



2. 在[輸出]分頁，選擇[HyperX QuadCast]。

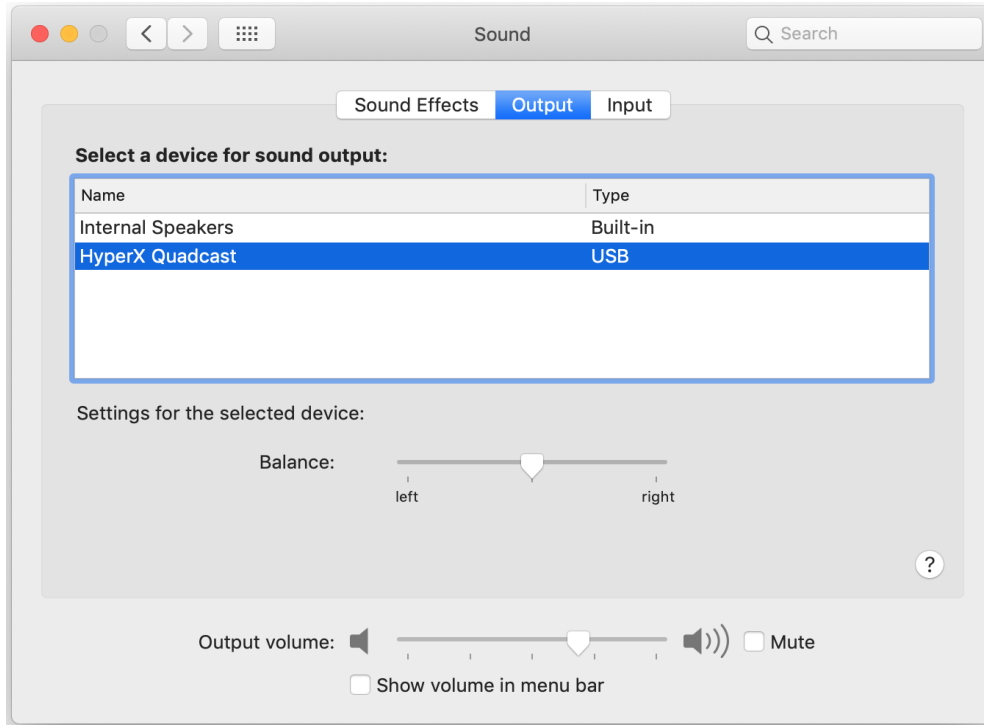

3. 在[輸入]分頁，選擇[HyperX QuadCast]。

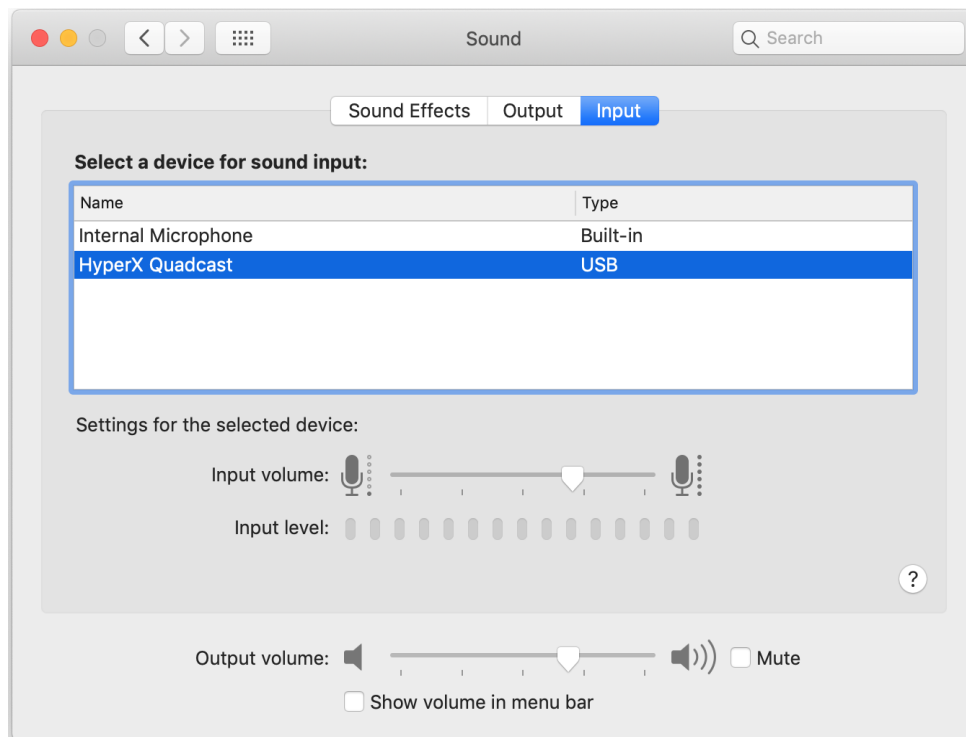



使用於 PS4™

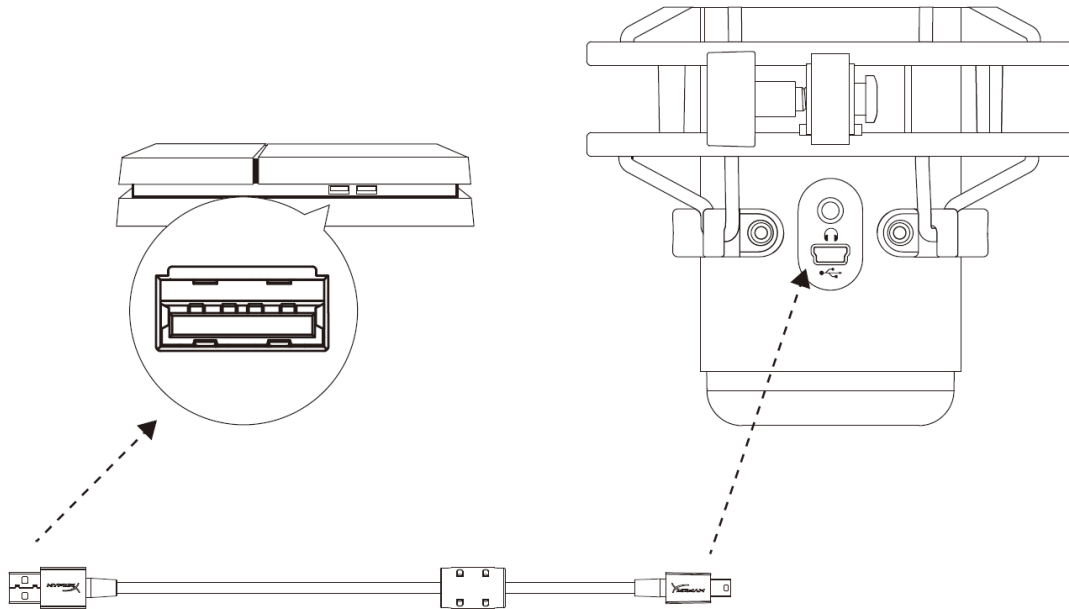

透過隨附的 USB 線將麥克風連接到 PS4 上的 USB 連接埠。

為了確保麥克風在 PS4 上是以最佳化設定運作，請依照以下步驟進行設置：

1. 在 PS4 主選單，前往**[設定] > [裝置] > [音效裝置]**
2. 將**[輸入裝置]**設定為**[USB 耳機] (HyperX QuadCast)**
3. 將**[輸出裝置]**設定為**[USB 耳機] (HyperX QuadCast)**
4. 將**[輸出至耳機]**設定為**[所有聲音]**
5. 將**[音量控制] (耳機)**設定為想要的音量

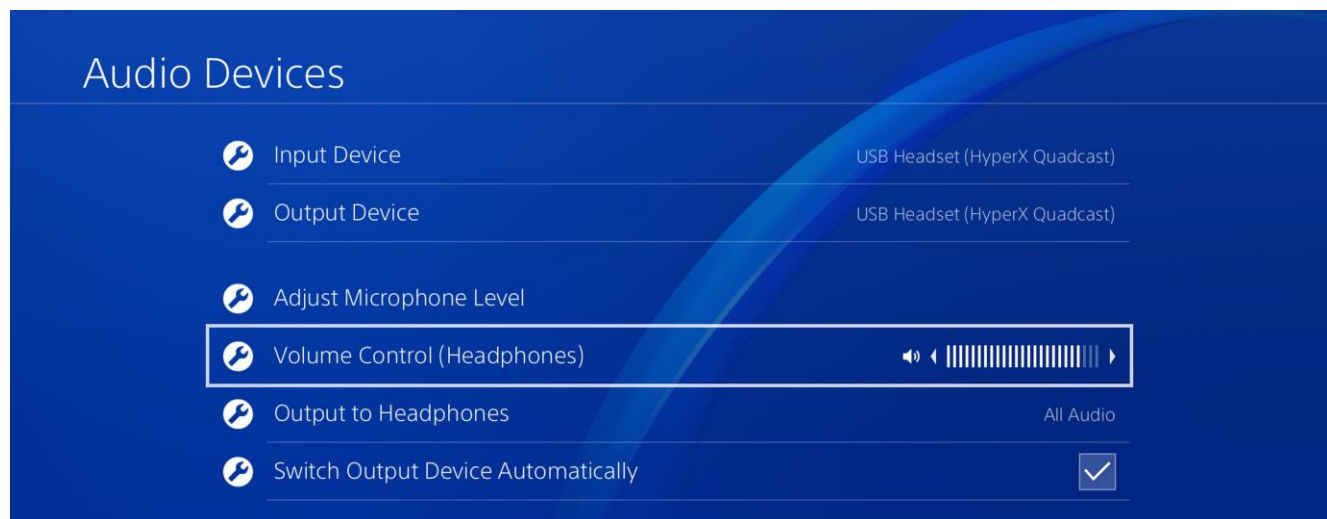



連接麥克風

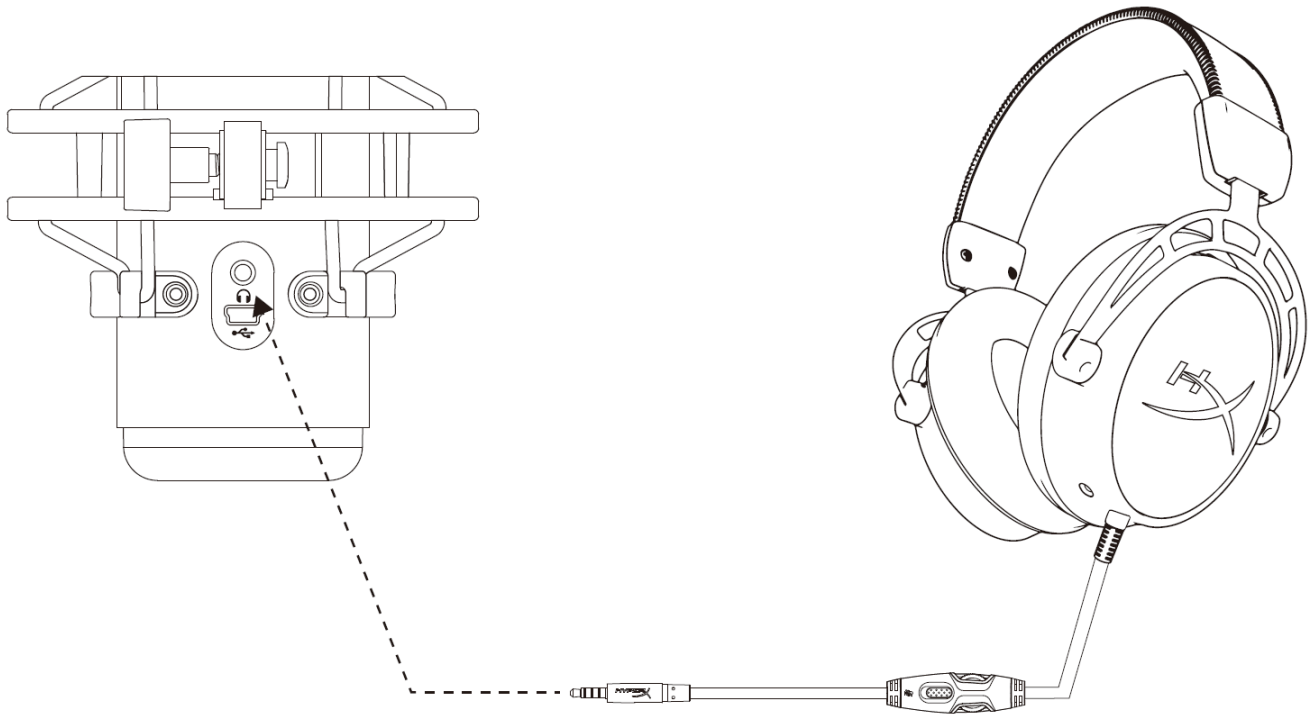

將耳機連接至麥克風上的耳機插孔，即可透過耳機即時監控麥克風錄音內容和播放聲音。



控制麥克風收音音量

PC

1. 在音效控制台的[播放]分頁，以右鍵點選
[喇叭 HyperX QuadCast]並選擇[內容]。

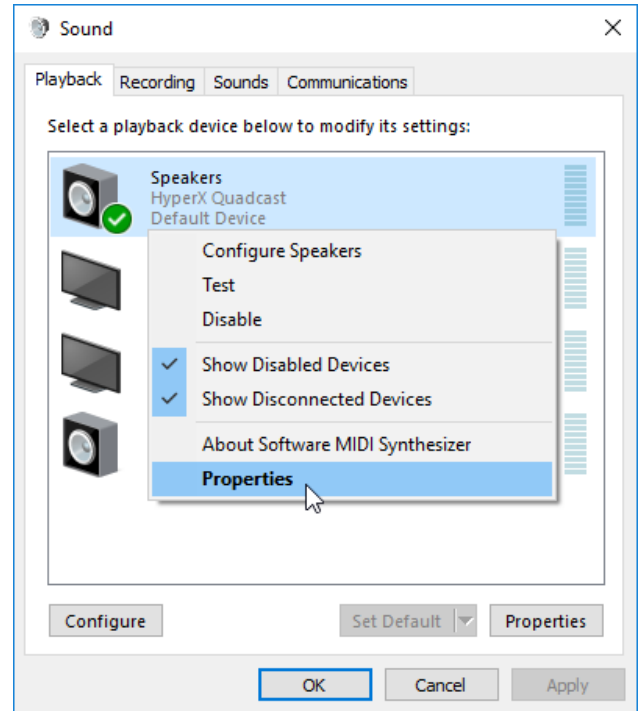

2. 在[等級]分頁，調整[麥克風]音量滑桿，
即可調整麥克風收音音量。

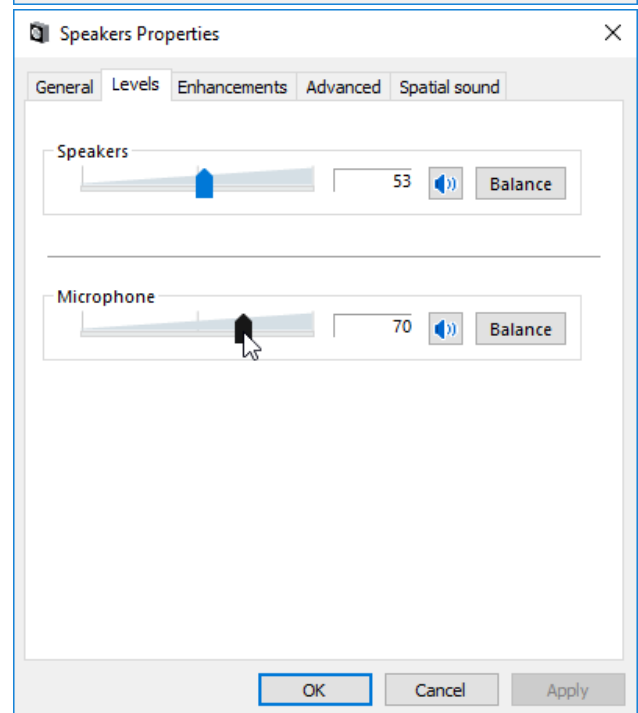



macOS

1. 開啟 **[Finder]** 應用程式並前往 **[應用程式]>[工具程式]>[音訊 MIDI 設定]**

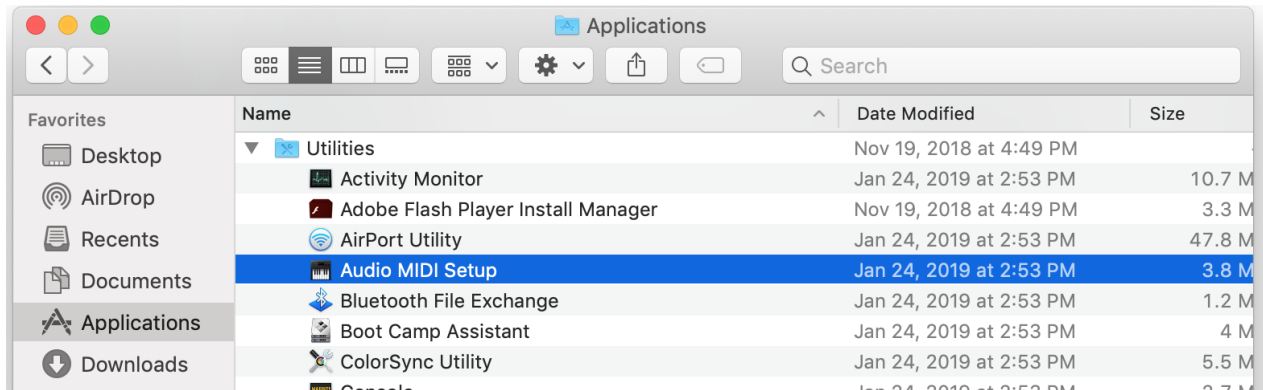

2. 點擊 **[HyperX QuadCast 2]** 並點擊 **[監聽]** 欄位下方的核取方塊，即可開關麥克風監聽。

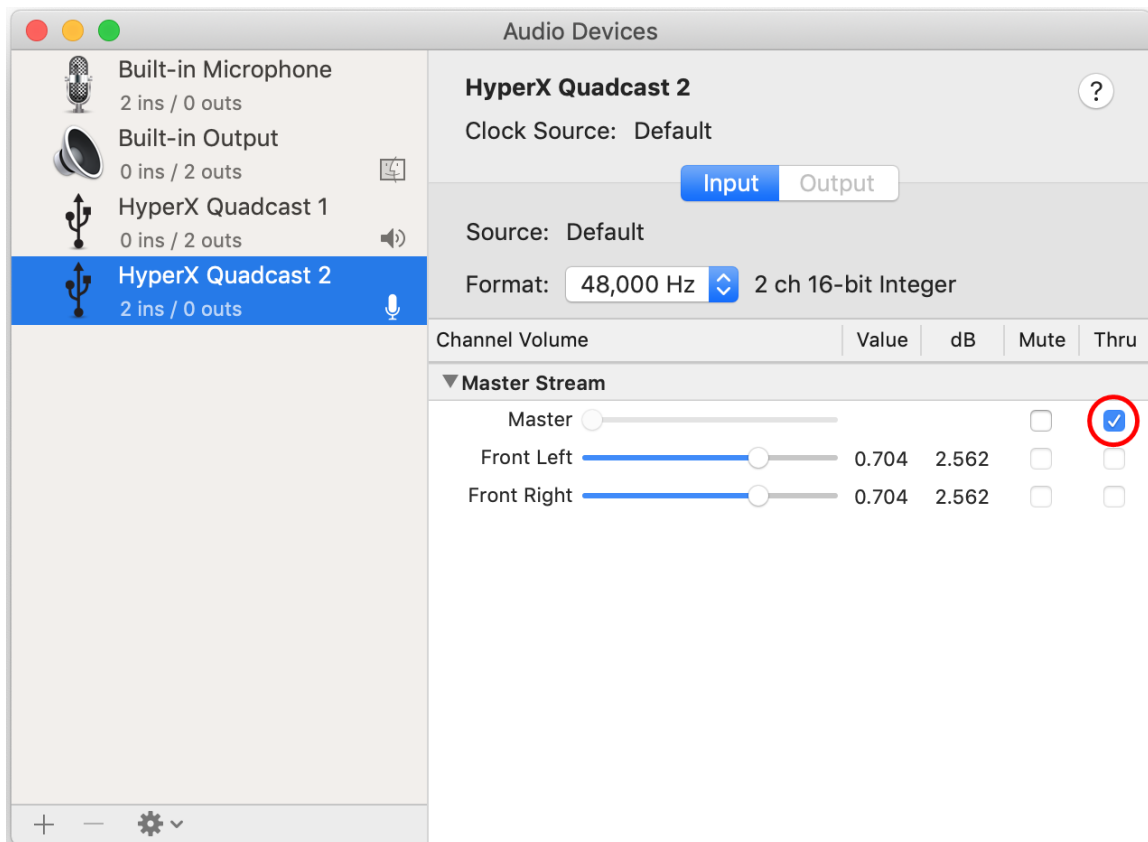

PS4

您無法在 PS4 直接控制麥克風監聽音量。



安裝轉接頭

1. 將隨附的安裝轉接器固定於麥克風吊臂。轉接頭支援 3/8" 和 5/8" 螺紋尺寸。
2. 轉動麥克風支架上的螺釘。
3. 將麥克風從支架上拆下。
4. 將轉接頭與麥克風安裝孔對齊，並使用螺釘和螺母固定。



有任何安裝或使用問題？

請聯絡 HyperX 支援團隊，網址為：hyperxgaming.com/support/