

Scanner User's Guide

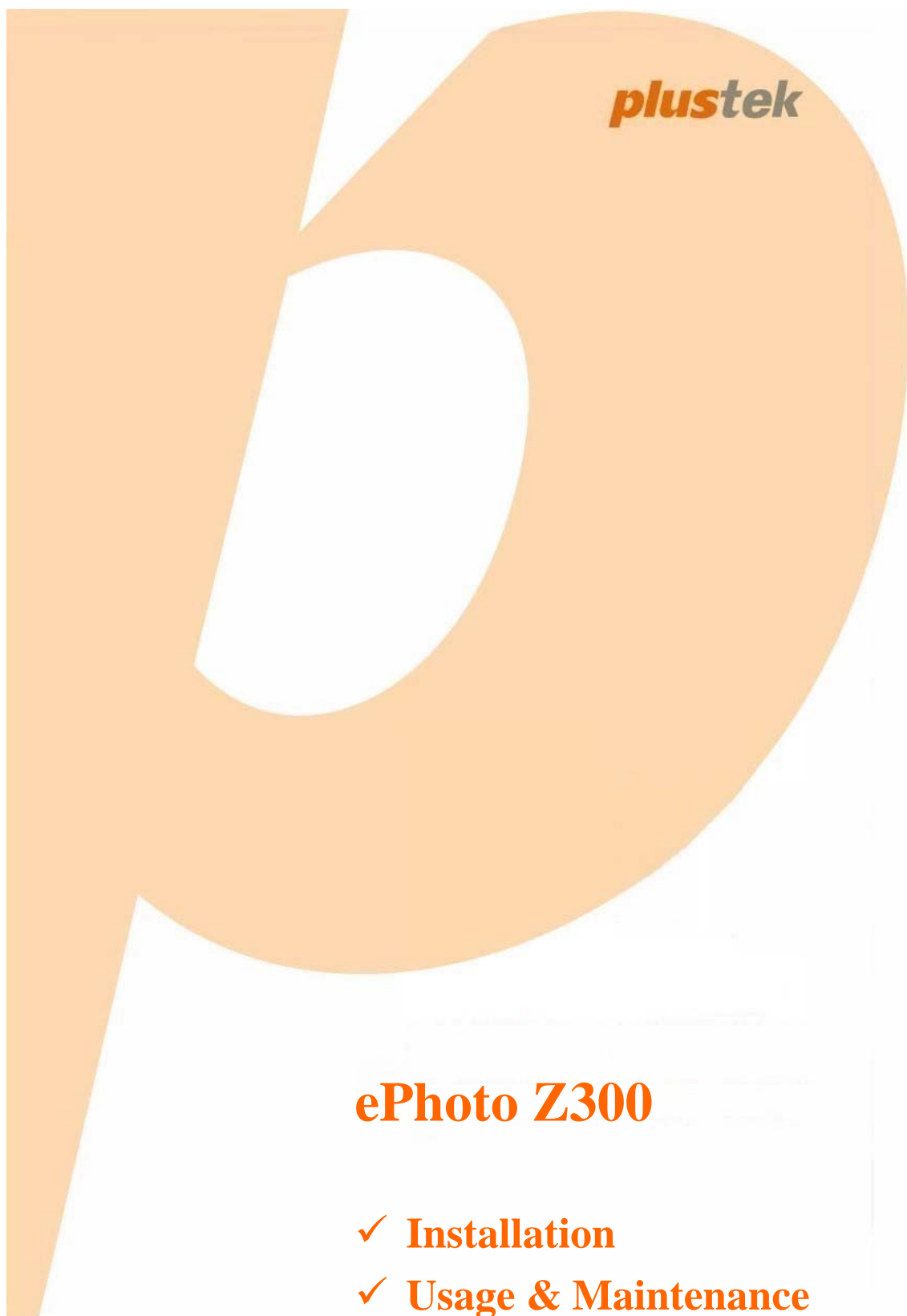

plusTek

ePhoto Z300

- ✓ **Installation**
- ✓ **Usage & Maintenance**

Trademarks

© 2016 Plustek Inc. All rights are reserved. No portion of this document may be reproduced without permission.

All trademarks and brand names mentioned in this publication are property of their respective owners.

Liability

While all efforts have been made to ensure the accuracy of all contents in this manual, we assume no liability for errors or omissions or by statements of any kind in this manual, whether such errors are omissions or statements resulting from negligence, accidents, or any other cause. The contents of this manual are subject to change without notice. We will not shoulder any legal liability, if users failed to follow the operation instructions in this manual.

Copyright

The scanning of certain documents, for example checks, bank notes, I.D. cards, government bonds, or public documents, may be prohibited by law and/or subject to criminal prosecution. We recommend you to be responsible and respectful of the copyrights laws when you are scanning books, magazines, journals and other materials.

Environmental Information

Recycle or disposal at end-of-life information, please ask local distributors or suppliers for recycle and disposal information. The product is designed and produced to achieve sustainable environmental improvement. We strive to produce products in compliance with global environmental standards. Please consult your local authorities for proper disposal.

The product packaging is recyclable.

Attention for recycling (For EU country only)

Protect your environment! This product should not be thrown into the household waste container. Please give it to the free collecting center in your community.

Screen Examples in This Manual

The screen shots in this guide were made with Windows 7. If you are using Windows 8 / 10, your screen will look somewhat different but functions the same.

Table of Contents

INTRODUCTION	1
HOW TO USE THIS GUIDE.....	1
A NOTE ABOUT ICONS.....	1
SAFETY PRECAUTIONS.....	2
SYSTEM REQUIREMENTS.....	3
BOX CONTENTS.....	4
SCANNER OVERVIEW.....	5
LED INDICATOR.....	6
POWER SAVE.....	6
CHAPTER I. INSTALLING THE SCANNER	7
INSTALLING AND SETTING UP THE SCANNER.....	7
<i>Windows Installation</i>	8
<i>Mac OS X Installation</i>	9
CHAPTER II. OPERATING THE SCANNER	11
STEP 1. TURN ON YOUR SCANNER.....	11
STEP 2. LAUNCH PLUSTEK EPHOTO.....	11
STEP 3. SCAN.....	12
CHAPTER III. CARE AND MAINTENANCE	13
CLEANING THE SCANNER.....	13
<i>Cleaning Materials</i>	13
<i>Cleaning the Scanner</i>	13
CALIBRATING THE SCANNER.....	15
USAGE & MAINTENANCE TIPS.....	16
APPENDIX A: SPECIFICATIONS	17
APPENDIX B: CUSTOMER SERVICE AND WARRANTY	18
SERVICE & SUPPORT INFORMATION (FOR EU COUNTRY ONLY).....	18
STATEMENT OF LIMITED WARRANTY.....	19
FCC RADIO FREQUENCY STATEMENT.....	20

Introduction

Welcome to the world of Plustek scanners – the ultimate in computer imaging. Your new scanner will improve the professionalism of your day-to-day computing tasks by allowing you to input images into your computer system.

Like all of our products, your new scanner is thoroughly tested and backed by our reputation for unsurpassed dependability and customer satisfaction.

Thank you for choosing us as your scanner supplier. We hope you will continue to turn to us for additional quality products as your computing needs and interests grow.

How to Use This Guide

This User's Guide provides instructions and illustrations on how to install and operate your scanner. This guide assumes the user is familiar with Microsoft Windows. If this is not the case, we suggest you learn more about Microsoft Windows by referring to your Microsoft Windows manual before using your scanner.

The Introduction section of this manual describes the box contents and minimum computer requirements to use this scanner. Before you start installing your scanner, check the box contents to make sure all parts are included. If any items are damaged or missing, please contact the vendor where you purchased your scanner or our customer service directly.

Chapter I. Installing the Scanner describes how to install scanner's software and connect the scanner to your computer.

Chapter II. Operating the Scanner describes how to operate the scanner.



Chapter III. Care and Maintenance describes how to maintain and clean your scanner.

Appendix A: Specifications contains the Specifications of the scanner you purchased.

Appendix B: Customer Service and Warranty contains our limited warranty agreement and FCC statement concerning the product.

A Note about Icons

This guide uses the following icons to point out information that deserves special attention.

 Warning	Warning: A procedure that must be followed carefully to prevent injury, or accidents.
 Attention	Attention: Instructions that are important to remember and may prevent mistakes.



Information

Information: Optional tips for your reference.

Safety Precautions

Before using this device, please read the following important information to eliminate or reduce any possibility of causing damage and personal injury.

1. Usage, the product is for indoor use in dry locations. Moisture condensation may occur inside this device and cause malfunction at these conditions:
 - when this device is moved directly from a cold to a warm location;
 - after a cold room is heated;
 - when this device is placed in a damp room.

To avoid the moisture condensation, you are recommended to follow the procedure:

- i. Seal this device in a plastic bag for it to adapt to room conditions.
 - ii. Wait for 1-2 hours before removing this device from the bag.
2. Do not use the power adapter and USB cable provided with the scanner. Use of other power adapter and cables may lead to malfunction.
 3. Keep the space around the AC adapter clear in case you need to quickly unplug the AC adapter during emergencies.
 4. Damaged wire could cause fire or electrical shock. Keep the power cord straight and without being twisted, bended, or scraped.
 5. Unplug this device if you don't need to use for a certain period of time, such as, during night or long weekend, to avoid any risks of causing fire.
 6. Do not attempt to disassemble the scanner. There is danger of an electrical shock and opening your scanner will void your warranty.
 7. Be sure not to bump or knock the scanner as it is fragile and could break.
 8. Before installing the device drivers, please disconnect all other imaging devices (other scanners, printers, digital cameras, web cameras) from the PC.
 9. Save the Setup/Application CD. You may need to reinstall the driver and software in the future. Save the Calibration Sheet in case you need to calibrate the scanner in the future.

System Requirements¹

Windows

- ☛ 2 GHz CPU or above
- ☛ 2 GB RAM (4 GB RAM recommended)
- ☛ 10 GB Free Hard Disk Space
- ☛ CD/DVD Drive or Internet Connection
- ☛ USB Port
- ☛ Microsoft Windows 7 / 8 / 10 (Specifications are subject to change without notification, for more information please check our official website.)

Macintosh

- ☛ 2 GHz CPU or above (INTEL based CPU, NO PowerPC)
- ☛ 2 GB RAM (4 GB RAM recommended)
- ☛ 10 GB Free Hard Disk Space
- ☛ CD/DVD Drive or Internet Connection
- ☛ USB Port
- ☛ Mac OS X 10.8.x, 10.9.x, 10.10.x, 10.11.x (Specifications are subject to change without notification, for more information please check our official website.)

¹ Higher requirements might be needed when you scan or edit a large quantity of image data. The system requirements here are only a guideline, as in general the better the computer (motherboard, processor, hard disk, RAM, video graphic card), the better the results.

Box Contents²

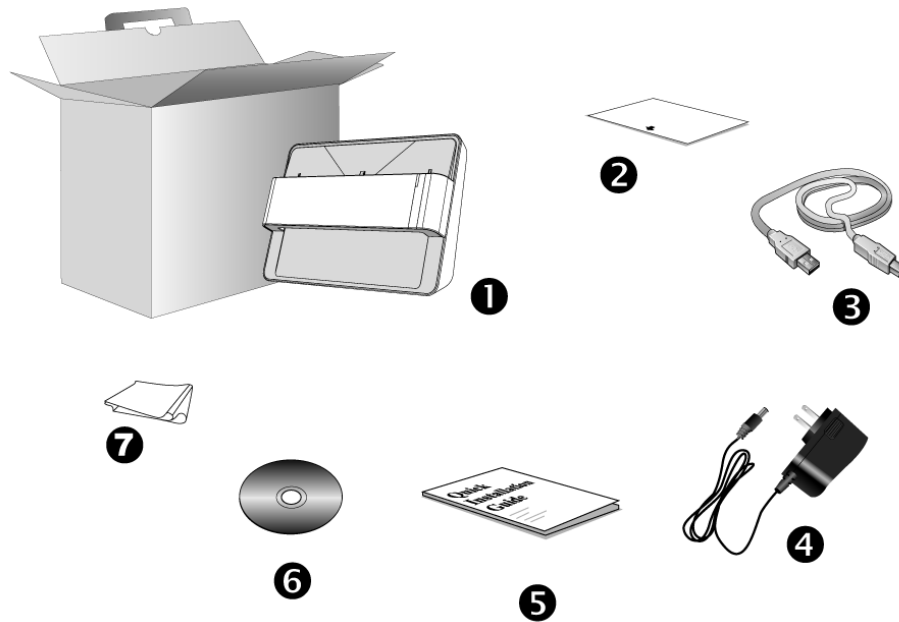

1. Scanner
2. Calibration Sheet
3. USB Cable
4. Power Adapter
5. Quick Guide
6. Plustek Setup / Application CD-ROM
7. Cleansing Cloth

² Save the box and packing materials in case you need to transport this scanner in the future.
Box contents may change at any time without prior notice.

Scanner Overview

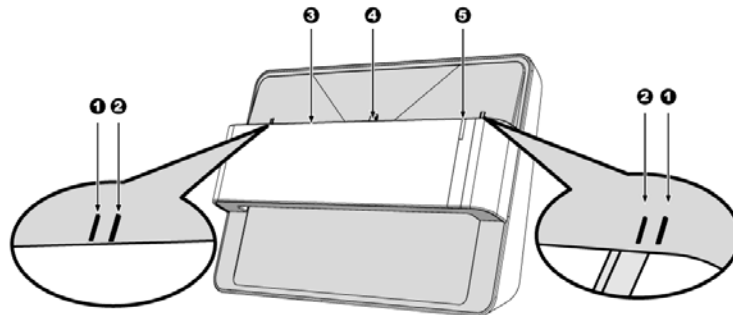

1. **Calibration Alignment Mark**

Always align the edges of the calibration sheet to both calibration alignment marks.

2. **Maximum Scan Area Mark**

Please place the edges of your photo / document between both maximum scan area marks.

3. **Page Feed Slot**

Feed the photo / document into the scanner from this slot. You can feel the photo / document being grabbed by the scanner.

4. **Scan Alignment Mark**

Always align the center of your photo / document edge to this alignment mark .

5. **LED Indicator**

It indicates the scanner's current status.

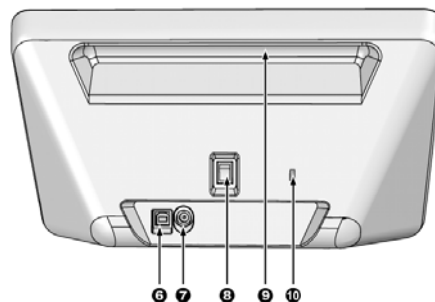

6. **USB Port**

It connects the scanner to a USB port on your computer by the included USB cable.

7. **Power Receptor**

It connects the scanner to a standard AC power outlet by the included power adapter.

8. **Power switch**

Use this to turn the scanner ON or OFF.

9. **Hand Holder**

It is ergonomically designed for you to carry the scanner with ease.

10. **Kensington Security Slot**

Used for attaching lock-and-cable apparatuses to prevent device theft.

LED Indicator

The LED indicates different scanner status.

Light	Status
Orange	The scanner is turned on.
Blue	The Plustek ePhoto is activated. The scanner is ready to scan.
Blinking Blue	The scanner is scanning.
Off	The scanner is off, either because the power is not turned on, or because the AC adapter is not properly plugged into an AC power outlet.

Power Save

To save power consumption, the scanner light source always automatically turns itself off after the scanning process is finished.

Chapter I. Installing the Scanner

Before installing your scanner, please verify that you have all of the proper components. A list of the package contents is provided in the Box Contents section of this guide.

Installing and Setting up the Scanner

Please follow the step-by-step procedures described below to install the USB scanner.

Windows Installation



1. Insert the Setup/Application CD-ROM, included with your scanner, into your CD-ROM drive.

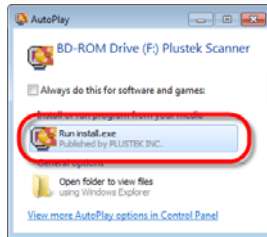

2. Click [Run install.exe] in the [AutoPlay] window. If the installation does not start automatically, browse your CD-ROM drive and manually run the [install.exe] file. Click on the [Yes] button if the [User Account Control] dialog pops up.

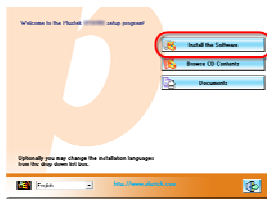

3. Follow the on-screen instructions to install all software that your new USB scanner requires.

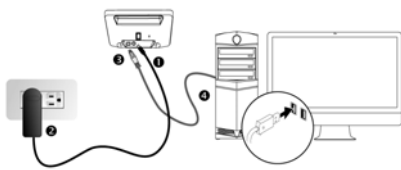

4. Plug the power adapter into the scanner's power receptor. Plug the other end of the power adapter into a standard AC power outlet. Plug the square end of the included USB cable to the USB port at the rear of the scanner. Plug the rectangular end of the USB cable to the USB port on the back of your computer. Switch the scanner power on. When the scanner is detected by the operation system, the connection is completed.

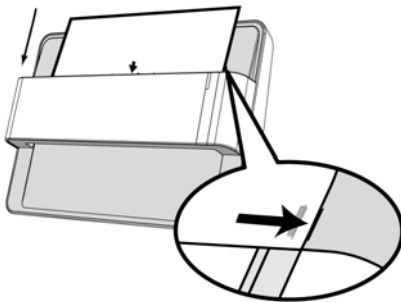

5. After the software is installed, you will be prompted to perform the scanner calibration. Insert the special calibration sheet, included with the scanner, face down into the page feed of the scanner. Align the calibration sheet to the calibration alignment mark on the scanner. Follow the on-screen instructions to complete the scanner calibration.



6. After the software is installed, close all open applications and click on the [Finish] button to restart your computer.

Mac OS X Installation



1. Insert the Setup/Application CD-ROM, included with your scanner, into your CD-ROM drive and a

[Plustek Scanner] CD icon  will show on the desktop of your Mac OS X. Double-click on the CD icon, and a window will pop up displaying the file folder.

2. Double-click on the app file, and the Scanner Installer will start to guide you through the installation. Follow the on-screen guide in the installer window.



Attention

For Windows 8 / 10, please follow the on-screen installation instructions after connecting the scanner.

For Windows OS:

If you are facing difficulty in installing the scanner driver, please try manually installing the software.

1. Please open [Start] > [Control Panel] > [System] > [Hardware] > [Device Manager]. In the [Device Manager] window, right-click on this scanner under [Other devices] and select [Update Driver Software] from the pop-up menu.

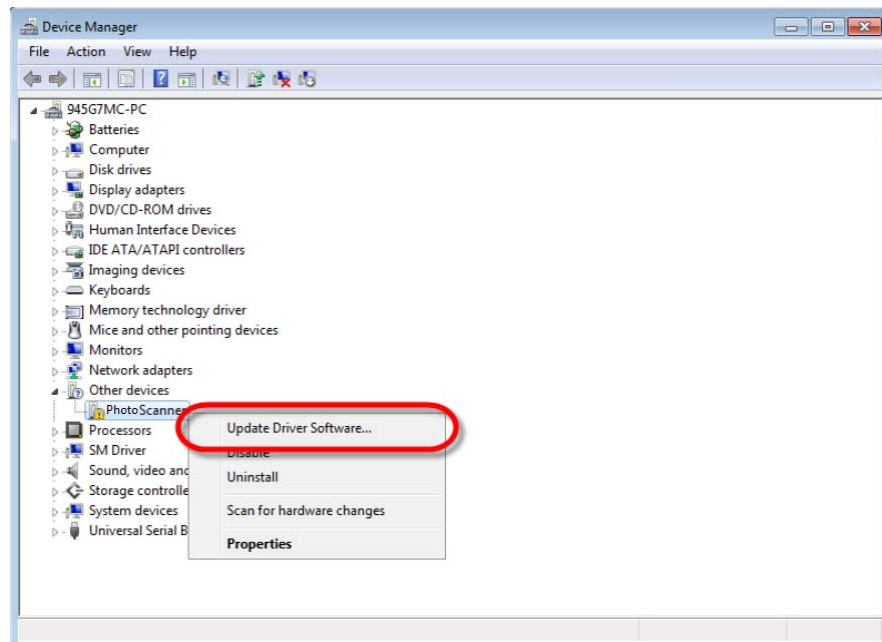

Information

2. Click [Browse my computer for driver software] in the window that appears, and click the [Browse] button. In the [Browse For Folder] window, select the folder or the CD-ROM drive that contains this scanner's driver and click the [OK] button to return to the previous screen. Click the [Next] button and click [Install this driver software anyway] if the [Windows Security] window appears.
3. Browse your CD-ROM drive and manually run the [install.exe] file. Click on the [Yes] button if the [User Account Control] dialog pops up. Follow the on-screen instructions to install all software that your new USB scanner requires.

Chapter II. Operating the Scanner

Your scanner accepts photos and documents. However, some software programs have limitations as to the information they can handle. The capacity of the computer's memory and free space on your hard drive can also limit the physical size of the film that you scan.

Your scanner comes with the advanced and feature rich scanning application Plustek ePhoto. This stand alone program allows you to perform advanced scanning features.

Step 1. Turn on Your Scanner

Please make sure the scanner's USB and power cables are properly connected and that the scanner is turned on. The LED will turn on to indicate that the device is powered on.

Step 2. Launch Plustek ePhoto

Launch Plustek ePhoto using the Plustek ePhoto shortcut on your Desktop. Adjust the scan settings. Please refer to the Plustek ePhoto on-line help for more information about available scan settings.

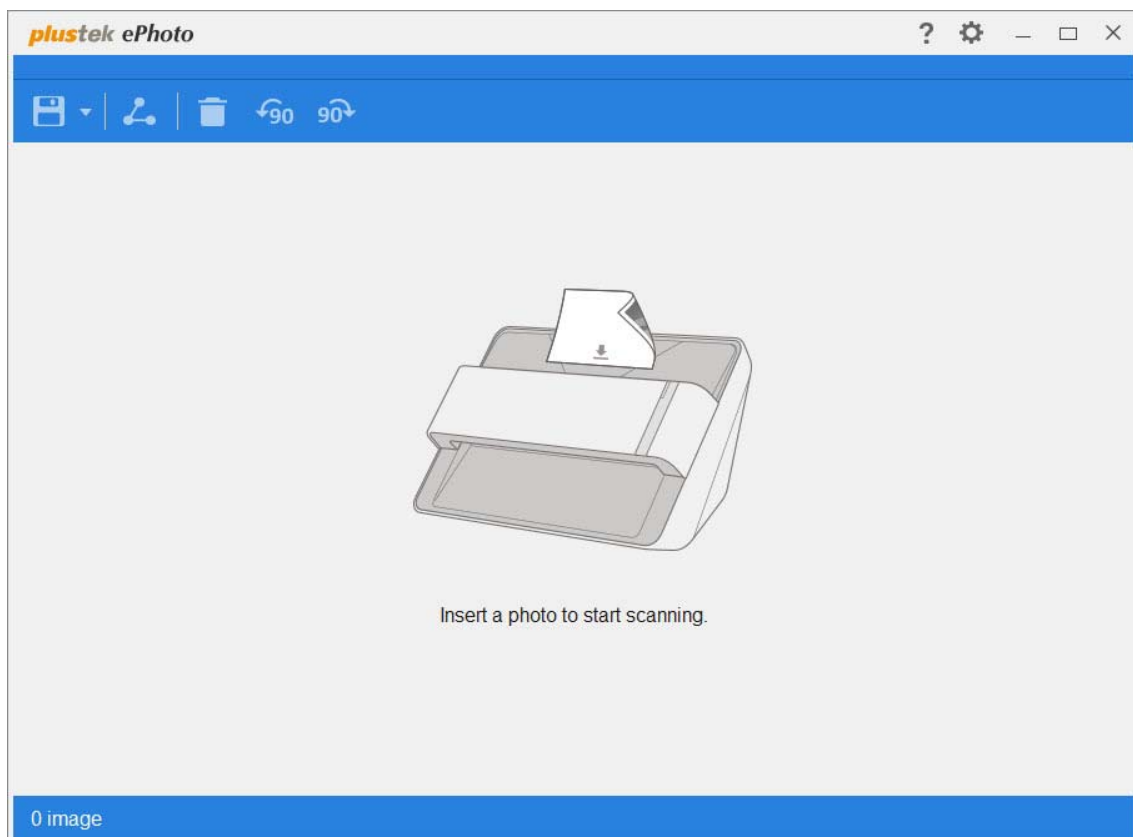

Step 3. Scan

Insert the photo / document face down into the scanner. Always align the center of your photo / document edge to this alignment mark . Please place the edges of your photo / document between both maximum scan area marks. The scanning starts immediately. The scanned images are displayed in Plustek ePhoto, and you may perform the image editing tasks. To scan more photos or documents, please wait until the blue light LED stop blinking, and then place another photo / document into the scanner to continue the scanning.

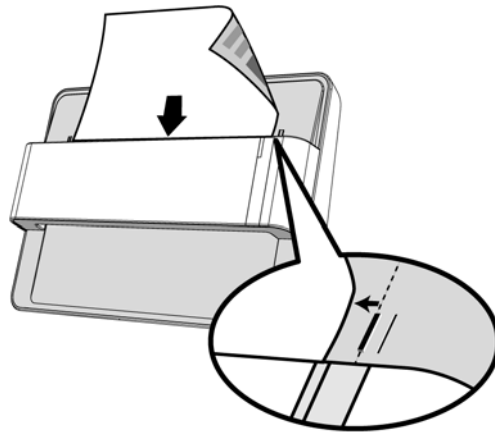

Chapter III. Care and Maintenance

Your scanner is designed to be maintenance-free. However, constant care and maintenance can keep your scanner working smoothly.

Cleaning the Scanner

Paper powder, dust, ink and toner from paper being scanned may make the inner scanner dirty, which leads to poor image quality or document-feeding errors. How often to clean your scanner depends on the type of paper and number of pages being scanned.

Perform the following procedures to clean the scanner. Gently wipe locations described herein. Do not rub too hard.



Warning

- Before cleaning the scanner, turn off the scanner and disconnect the scanner's power cable and USB cable, and then wait a few minutes for the glass and/or the inner scanner to cool to ambient temperature.
- Wash your hands with soap and water after cleaning the scanner.

Cleaning Materials

Have the following cleaning materials ready to clean the scanner:

- soft, dry, lint-free cloth (or a cotton swab)
- **non-abrasive cleaner**—Isopropyl alcohol (95%). **DO NOT** use water.



Attention

- Alternatively you can use glass cleaner or neutral detergent for windows cleaning to clean the scanner glass.
- However, **DO NOT** use either of them to clean the feed roller.
- Use of other cleaning materials could damage your scanner.

Cleaning the Scanner

1. Open the scanner cover gently.

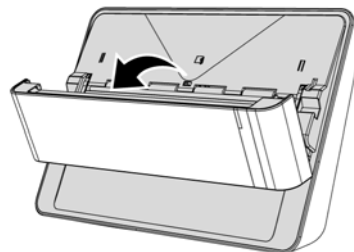

2. Gently wipe the following areas with the cloth dampened with the cleaner. Be careful **NOT** to scratch their surfaces.

Clean Feed Roller:

Wipe the Feed Roller from side to side and then rotate it. Repeat this until its entire surface is cleaned.

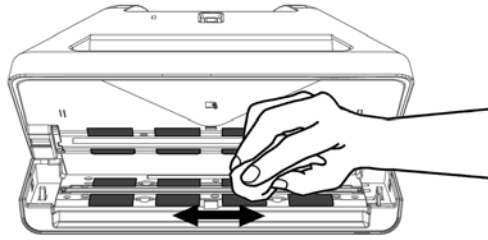

Clean Scanner Glass:

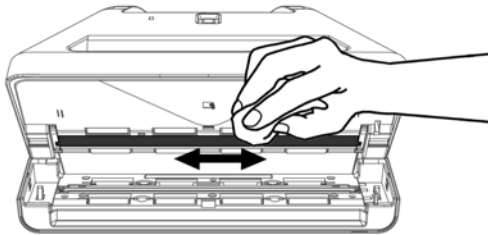

 <p>Attention</p>	<p>Do not spray cleaner directly onto the scanner glass. Excess liquid residue may fog or damage the scanner.</p>
------------------------------------------------------------------------------------------------------------	-------------------------------------------------------------------------------------------------------------------

- 3. Wait for cleaned areas to dry completely.
- 4. Close the cover by pushing it back down until it snaps back into place.

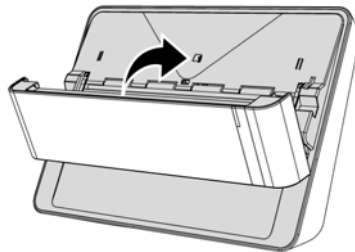

Calibrating the Scanner

Calibrate the scanner if colors appear in areas that should be white, or colors of the scanned image and the original vary a lot. This allows you to adjust and compensate for variations that can occur in the optical component over time by its nature.

The following describes how to calibrate the scanner:

1. Insert the special calibration sheet face down into the page feed slot of the scanner. Align the calibration sheet to the calibration alignment mark on the scanner.

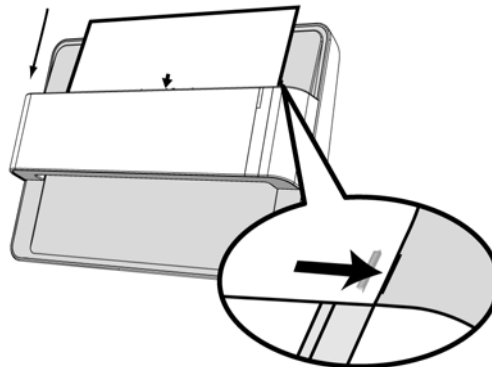

Please insert the special calibration sheet included with the scanner. Alternatively you may also use any plain white sheet of paper sized in Letter size (8.5" x 11.69") instead; however, the calibration effect may be less good than the special calibration sheet.

2. Click **Start** > **All Programs** > **Your scanner model name** > **Calibration Wizard**. (For Windows 8.1 users: Point your mouse cursor to the upper or lower right corner of your screen to open the **Charm** bar. Click on the **Start** charm, then click on the downwards arrow button in the lower left corner of the screen. The **Apps** screen will be shown. Move your cursor to the right edge of the screen to scroll right until you find **Your scanner model name**, and then click on **Calibration Wizard**.)
3. Click **Next** from the Calibration Wizard that pops up and then click **Calibrate Now...**
4. Click on the **Start** button to begin the calibration process.
5. The scanner pulls the calibration sheet through the scanner, which completes this scanner calibration. After the calibration is complete, click **OK** and then click **Finish**.



Usage & Maintenance Tips



Information

To keep your scanner working smoothly, take a moment to review the following maintenance tips.

- ⚠️ Avoid using the scanner in a dusty environment. When it is not in use, keep the scanner covered. Dust particles and other foreign objects may damage the unit.
- ⚠️ Do not attempt to disassemble the scanner. There is danger of an electrical shock and opening your scanner will void your warranty.
- ⚠️ Do not subject the scanner to excessive vibration. It may damage the internal components.
- ⚠️ Your scanner operates best in temperatures between 10° C to 40° C (50° F to 104° F).

Appendix A: Specifications³

ePhoto Z300	
Image Sensor	Color CCD
Light Source	LED
Optical Resolution	300 dpi
Scan Modes	Color: Input 48-bit , Output 24-bit Grayscale: Input 16-bit , Output 8-bit
Scanning Speed	4" x 6" Photo: Approx. 2 sec. Document (A4): Approx. 5 sec.
Scanning Area (W x L)	Min.: 1" x 1" Max.: 8.5" x 11.7"
Acceptable Paper Weight (Thickness)	Non-embossed: 0.76 mm or less
Daily Duty Scan (Sheets)	500
Power Supply	24 Vdc / 0.75 A
Interface	USB 2.0
Net Weight	1.48 Kg (3.26 Lbs)
Dimensions (W x D x H)	289.9 mm x 160.6 mm x 158mm (11.4" x 6.3" x 6.2")

³ Hardware specifications may change at any time without prior notice.

Appendix B: Customer Service and Warranty

If you encounter problems with your scanner, please review the installation instructions and troubleshooting suggestions contained in this guide.

Visit our website www.plustek.com for more customer service information. For further assistance call our customer support phone number listed on the website. One of our representatives will be happy to assist you from Monday through Friday in office working hours as shown below:

Europe	9:00 a.m. – 5:30 p.m. (CET)
Other Countries or Areas	9:00 a.m. – 6:00 p.m. Taiwan Time

To avoid delays, please have the following information available before calling:

- 📞 **Scanner name and model number**
- 📞 **Scanner serial number**
- 📞 **A detailed description of the problem**
- 📞 **Your computer manufacturer and its model number**
- 📞 **The speed of your CPU (Pentium 133, etc.)**
- 📞 **Your current operating system and BIOS (optional)**
- 📞 **Name of software package(s), version or release number and manufacturer of the software**
- 📞 **Other USB devices installed**

Service & Support Information (For EU country only)

Where appropriate, the period of availability of spare parts and the possibilities of upgrading products information. Please ask local distributors and suppliers for spare parts information and product upgrade information.

Information requested by relevant Implementing Measure. Please ask local distributors and suppliers for the related information of Implementing Measure test report.

Do not dispose anything of products before you ask local distributors and suppliers to get correct information for decreases of environmental impact with right methods and procedures.

If you want to disposals the product and/or an accessory, please ask local distributors and suppliers to get the contact information of nearest disposal manufactures.

If you have any maintenance inquiry, please ask local distributors and suppliers to get the contact information of nearest maintenance center in order to extend the product usage life time.

If you want to maintain and clear the product, please ask local distributors and suppliers to get the right information of nearest stores.

Statement of Limited Warranty

This Statement of Limited Warranty applies only to the options you originally purchase for your use, and not for resale, from an authorized reseller.

The manufacturer warranty includes all parts and labor, and is not valid without the receipt of original purchase. To obtain warranty service, you may contact the authorized dealer or distributor, or visit our website to check out the available service information, or send a request via E-mail for further help.

If you transfer this product to another user, warranty service is available to that user for the remainder of the warranty period. You should give your proof of purchase and this statement to that user.

We warrant that this machine will be in good working order and will conform to its functional descriptions in the documentation provided. Upon provision of proof of purchase, replacement parts assume the remaining warranty of the parts they replace.

Before presenting this product for warranty service, you must remove all programmes, data and removable storage media. Products returned without guides and software will be replaced without guides and software.

This Limited Warranty service does not provide for carry-in exchange when the problem results from accident, disaster, vandalism, misuse, abuse, unsuitable environment, programme modification, another machine or non-vendor modification for this product.

If this product is an optional feature, this Limited Warranty applies only when the feature is used in a machine for which it was designed.

If you have any questions about your Limited Warranty, contact the approved retailer from whom you bought the product or the manufacturer.

THIS LIMITED WARRANTY REPLACES ALL OTHER WARRANTIES, EXPRESS OR IMPLIED, INCLUDING, BUT NOT LIMITED TO, THE IMPLIED WARRANTIES OF MERCHANTABILITY AND FITNESS FOR A PARTICULAR PURPOSE. HOWEVER, SOME LAWS DO NOT ALLOW THE EXCLUSION OF IMPLIED WARRANTIES. IF THESE LAWS APPLY, THEN ALL EXPRESS AND IMPLIED WARRANTIES ARE LIMITED IN DURATION TO THE WARRANTY PERIOD. NO OTHER WARRANTIES APPLY AFTER THAT PERIOD.

Some jurisdictions do not allow limitations on how long an implied warranty lasts, so the above limitation may not apply.

Under no circumstances are we liable for any of the following:

- ☛ Third party claims against you for losses or damages.

- ☛ Loss of, or damage to, your records or data; or
- ☛ Economic consequential damages (including lost profits or savings) or incidental damages, even if we are informed of their possibility.

Some jurisdictions do not allow the exclusion or limitations of incidental or consequential damages, so the above limitation or exclusion may not apply to you.

This Limited Warranty gives you specific legal rights, and you may also have other rights that vary from jurisdiction to jurisdiction.

To obtain the warranty service, you may:

- ☛ contact the authorized dealer or distributor.
- ☛ visit our website to check out the up-to-date service.
- ☛ send a request via E-mail for further help.

FCC Radio Frequency Statement

This equipment has been tested and found to comply with the limits for a Class B digital device, pursuant to part 15 of the FCC rules. These limits are designed to provide reasonable protection against harmful interference in a residential installation.

This equipment generates, uses and can radiate radio frequency energy and, if not installed and used in accordance with the instructions, may cause harmful interference to radio communications. However, there is no guarantee that interference will not occur in a particular television reception (which can be determined by turning the equipment off and on), the user is encouraged to try to correct the interference by one or more of the following measures:

- ☛ Reorient or relocate the receiving antenna.
- ☛ Increase the separation between the equipment and receiver.
- ☛ Connect the equipment to an outlet on a circuit different from that which the receiver is connected.
- ☛ Shielded interconnect cables and shielded power cord which are supplied with this equipment must be employed with this equipment to ensure compliance with the pertinent RF emission limits governing this device.
- ☛ Consult the dealer or an experienced radio/TV technician for help if the conditions persist.
- ☛ Changes or modifications not expressly approved by the manufacturer or authorized service center could void the user's authority to operate this equipment.