

Dell EMC SmartFabric OS10 User Guide

Release 10.5.1

Notes, cautions, and warnings

 **NOTE:** A NOTE indicates important information that helps you make better use of your product.

 **CAUTION:** A CAUTION indicates either potential damage to hardware or loss of data and tells you how to avoid the problem.

 **WARNING:** A WARNING indicates a potential for property damage, personal injury, or death.

Chapter 1: About this guide	27
Conventions.....	27
Related Documents.....	27
Documentation Feedback.....	27
Chapter 2: Change history	28
Chapter 3: Getting Started with Dell EMC SmartFabric OS10	30
Switch with factory-installed OS10.....	31
Log in	31
Check OS10 version.....	32
OS10 upgrade.....	32
Check OS10 license.....	40
Re-install license	41
Switch without OS installed.....	41
Uninstall existing OS.....	42
Download OS10 image.....	42
Installation using ONIE.....	43
Log in	46
Install OS10 license.....	46
Downgrade to Release 10.5.0.0 or earlier releases.....	49
Roll back from 10.5.1.0 or later release to 10.5.0.0 or earlier release.....	50
Switch deployment options.....	50
Manual CLI configuration.....	51
ZTD-automated switch deployment.....	51
Ansible-automated switch provisioning.....	51
Feature limitation on the Z9100-ON and S5200-ON series switches.....	51
Feature limitations on Z9332F-ON switch.....	51
Remote access.....	51
Configure Management IP address.....	52
Configure Management route	52
Configure username and password.....	53
Chapter 4: CLI Basics	54
CONFIGURATION mode.....	55
Check device status.....	56
Related Videos.....	57
Command help.....	57
Candidate configuration.....	58
Copy running configuration	61
Restore startup configuration	62
Reload system image.....	63
Filter show commands.....	63
Common OS10 commands.....	64

boot.....	64
commit.....	64
configure.....	64
copy.....	65
delete.....	66
dir.....	67
discard.....	68
do.....	68
end.....	69
exit.....	69
hostname.....	69
license.....	70
lock.....	70
management route.....	71
move.....	71
no.....	72
ping.....	72
ping6.....	74
reload.....	75
show boot.....	76
show candidate-configuration.....	76
show environment.....	79
show inventory.....	79
show ip management-route.....	80
show ipv6 management-route.....	80
show license status.....	81
show running-configuration.....	81
show startup-configuration.....	84
show system.....	85
show version.....	87
start.....	87
system.....	87
system-cli disable.....	88
system-user linuxadmin disable.....	88
system identifier.....	89
terminal.....	89
traceroute.....	89
unlock.....	90
username password role.....	91
write.....	92
Chapter 5: Advanced CLI tasks.....	93
Command alias.....	93
Multi-line alias.....	94
alias.....	96
alias (multi-line).....	97
default (alias).....	98
description (alias).....	98
line (alias).....	98
show alias.....	99

Batch mode.....	100
batch.....	100
Linux shell commands.....	101
Using OS9 commands.....	103
feature config-os9-style.....	103
Chapter 6: Dell EMC SmartFabric OS10 zero-touch deployment.....	104
ZTD DHCP server configuration.....	106
ZTD provisioning script.....	106
ZTD CLI batch file.....	107
Post-ZTD script.....	108
ZTD commands.....	108
reload ztd.....	108
show ztd-status.....	108
ztd cancel.....	109
Chapter 7: Dell EMC SmartFabric OS10 provisioning.....	110
Using Ansible.....	110
Example: Configure an OS10 switch using Ansible.....	111
Chapter 8: System management.....	114
System banners.....	114
Login banner.....	114
Message of the day banner.....	115
System banner commands.....	115
User session management.....	116
User session management commands.....	117
Telnet server.....	118
Telnet commands.....	119
Simple Network Management Protocol.....	119
SNMP security models and levels.....	120
MIBs.....	120
SNMPv3.....	121
Configure SNMP.....	122
SNMP commands.....	126
Example: Configure SNMP.....	135
System clock.....	136
Time zones and UTC offset reference.....	137
System Clock commands.....	153
Network Time Protocol.....	155
Enable NTP.....	156
Broadcasts.....	156
Source IP address.....	157
Authentication.....	157
Sample NTP configuration.....	158
NTP commands.....	161
Precision Time Protocol.....	166
Supported platforms.....	169
PTP installation scale and limits.....	169

Configuration notes.....	169
Configure Precision Time Protocol.....	170
View PTP information.....	173
Example: Configure boundary clock with L2 transport method.....	175
Example: Configure boundary clock with IPv4 multicast transport method.....	176
Example: Configure boundary clock with IPv4 unicast transport method.....	176
Example: Configure end-to-end transparent clock.....	177
Example: Configure boundary clock with IPv4 unicast transport method and L3 VLAN.....	178
Example: Configure PTP in a multinode setup.....	179
PTP commands.....	186
Dynamic Host Configuration Protocol.....	201
Packet format and options.....	203
DHCP server.....	204
Automatic address allocation.....	204
Hostname resolution.....	206
Manual binding entries.....	206
View DHCP Information.....	208
DHCP relay agent.....	208
DHCP snooping.....	208
System domain name and list.....	225
DHCP commands.....	226
DNS commands.....	242
Containers.....	244
Chapter 9: Interfaces.....	247
Ethernet interfaces.....	247
Unified port groups.....	248
Z9264F-ON port-group profiles.....	249
Port-groups on S5200F-ON switches.....	250
L2 mode configuration.....	257
L3 mode configuration.....	258
Fibre Channel interfaces.....	259
Configuring wavelength.....	260
Management interface	261
Management interface	261
VLAN interfaces.....	261
User-configured default VLAN.....	262
VLAN scale profile.....	262
Loopback interfaces.....	263
Port-channel interfaces.....	264
Create port-channel.....	264
Add port member.....	264
Minimum links.....	265
Assign Port Channel IP Address.....	265
Remove or disable port-channel.....	266
Load balance traffic.....	266
Change hash algorithm.....	267
Configure interface ranges.....	267
Switch-port profiles.....	268
S4148-ON Series port profiles.....	269

S4148U-ON port profiles.....	269
Configure negotiation modes on interfaces.....	270
Configure breakout mode.....	272
Breakout auto-configuration.....	272
Reset default configuration.....	273
Forward error correction.....	274
Energy-efficient Ethernet.....	275
Enable energy-efficient Ethernet.....	276
Clear EEE counters.....	276
View EEE status/statistics.....	276
EEE commands.....	277
View interface configuration.....	280
Digital optical monitoring.....	283
Enable DOM and DOM traps.....	284
Default MTU Configuration.....	285
Interface commands.....	286
channel-group.....	286
default interface.....	286
default vlan-id.....	289
description (Interface).....	289
duplex.....	290
enable dom.....	290
enable dom traps.....	290
feature auto-breakout.....	291
fec.....	291
interface breakout.....	292
interface ethernet.....	292
interface loopback.....	293
interface mgmt.....	293
interface null.....	293
interface port-channel.....	294
interface range.....	294
interface vlan.....	295
link-bundle-utilization.....	295
mode.....	295
mode l3.....	296
mtu.....	297
negotiation.....	297
port mode Eth.....	298
port-group.....	299
profile.....	299
scale-profile vlan.....	300
show discovered-expanders.....	300
show interface.....	301
show interface transceiver "Tunable wavelength".....	303
show inventory media.....	303
show link-bundle-utilization.....	304
show port-channel summary.....	305
show port-group.....	305
show switch-port-profile.....	306

show system.....	307
show unit-provision.....	307
show vlan.....	308
shutdown.....	308
speed (Fibre Channel).....	309
speed (Management).....	309
switch-port-profile.....	310
switchport access vlan.....	312
switchport mode.....	312
switchport trunk allowed vlan.....	313
unit-provision.....	313
wavelength.....	313
default mtu.....	314
show default mtu.....	314
Chapter 10: PowerEdge MX Ethernet I/O modules.....	315
Operating modes.....	315
Changing operating modes.....	317
Restrictions.....	317
Port groups on I/O modules.....	317
Double-density QSFP28 interfaces.....	317
Virtual ports.....	320
Single-density QSFP28 interfaces.....	323
Server-facing interfaces.....	324
Replace MX Ethernet I/O modules.....	325
Deployment instructions.....	325
Replace an IOM in Full-Switch VLT.....	326
Replace an IOM in SmartFabric.....	326
MX-IOM Hardware Replacement.....	329
View SmartFabric Services configuration.....	329
Chapter 11: Fibre Channel.....	331
Fibre Channel over Ethernet.....	332
Configure FIP snooping.....	333
Terminology.....	334
Virtual fabric.....	334
Fibre Channel zoning.....	337
F_Port on Ethernet.....	338
Pinning FCoE traffic to a specific port of a port-channel.....	339
Sample FSB configuration on VLT network.....	341
Sample FC Switch configuration on VLT network.....	343
Sample FSB configuration on non-VLT network.....	345
Sample FC Switch configuration on non-VLT network.....	346
Multiswitch fabric (E Port).....	348
Configure multiswitch fabric (E Port).....	350
Verify multiswitch fabric (E Port) configuration.....	352
Multiswitch fabric (E Port) CLI commands.....	357
Multi-hop FIP-snooping bridge.....	372
Configuration notes.....	373

Configure multi-hop FSB.....	373
Verify multi-hop FSB configuration.....	379
Sample Multi-hop FSB configuration.....	380
Configuration guidelines.....	393
NPIV Proxy Gateway cascading.....	394
Support for untagged VLAN in FCoE.....	396
Rebalance FC sessions (NPG).....	396
Load balancing after system reboot.....	397
NPG rebalance topology.....	397
NPG switch configurations.....	397
Example: Manual rebalance trigger.....	399
Equivalent RESTCONF request for the rebalancing CLIs.....	401
F_Port commands.....	401
fc alias.....	402
fc zone.....	402
fc zoneset.....	402
feature fc.....	403
member (alias).....	403
member (zone).....	404
member (zoneset).....	404
show fc alias.....	404
show fc interface-area-id mapping.....	405
show fc ns switch.....	405
show fc zone.....	406
show fc zoneset.....	406
zone default-zone permit.....	408
zoneset activate.....	408
NPG commands.....	408
fc port-mode F.....	408
feature fc npg.....	409
show npg devices.....	409
show npg uplink-interface.....	410
F_Port and NPG commands.....	411
clear fc statistics.....	412
fcoe	412
fcoe delay fcf-adv.....	412
name.....	413
Re-balance the FC sessions.....	413
show npg uplink-interface.....	415
show npg node-interface.....	417
show fc statistics.....	418
show fc switch.....	419
show running-config vfabric.....	419
show vfabric.....	419
vfabric.....	420
vfabric (interface).....	420
vlan.....	421
FIP-snooping commands.....	421
feature fip-snooping.....	421
fip-snooping enable.....	422

fip-snooping fc-map.....	422
fip-snooping port-mode.....	422
FCoE commands.....	423
clear fcoe database.....	423
clear fcoe statistics.....	423
fcoe delay fcf-adv.....	424
fcoe-pinned-port	424
fcoe max-sessions-per-enodemac.....	424
fcoe priority-bits.....	425
lldp tlv-select dcbxp-appln fcoe.....	425
re-balance fc npg sessions vfabric.....	426
show fcoe enode.....	427
show fcoe fcf.....	428
show fcoe pinned-port.....	429
show fcoe sessions.....	429
show fcoe statistics.....	430
show fcoe system.....	430
show fcoe vlan.....	431

Chapter 12: Layer 2.....432

802.1X.....	432
Port authentication.....	433
EAP over RADIUS.....	434
Configure 802.1X.....	434
Enable 802.1X.....	435
Identity retransmissions.....	436
Failure quiet period.....	436
Port control mode.....	437
Reauthenticate a port.....	438
Configure timeouts.....	439
Configure RADIUS server.....	440
802.1X commands.....	440
RADIUS server commands.....	445
Far-end failure detection.....	448
Enable FEFD globally.....	449
Enable FEFD on interface.....	450
Reset FEFD err-disabled interface.....	450
Display FEFD information.....	451
FEFD Commands.....	451
Link Aggregation Control Protocol.....	454
Modes.....	454
Configuration.....	455
Interfaces.....	455
Rates.....	456
Sample configuration.....	457
LACP fallback.....	460
LACP commands.....	463
Link Layer Discovery Protocol.....	469
Mandatory TLVs.....	470
Optional TLVs.....	470

Configure LLDP.....	473
Example: Advertise TLVs configuration.....	480
View LLDP configuration.....	480
View LLDP neighbor advertisements.....	481
LLDP-MED.....	483
LLDP commands.....	486
Media Access Control.....	499
Static MAC Address.....	499
MAC Address Table.....	499
Clear MAC Address Table.....	500
MAC Commands.....	500
Spanning-tree protocol.....	503
Introduction to STP.....	503
Common STP commands.....	510
Rapid per-VLAN spanning-tree.....	516
Rapid Spanning-Tree Protocol.....	526
Multiple Spanning-Tree.....	533
Virtual LANs.....	547
Default VLAN.....	547
Create or remove VLANs.....	548
Access mode.....	549
Trunk mode.....	550
Assign IP address.....	550
View VLAN configuration.....	551
VLAN Scaling.....	553
VLAN commands.....	553
Port monitoring.....	555
Local port monitoring.....	555
Remote port monitoring.....	556
Encapsulated remote port monitoring.....	558
Flow-based monitoring.....	559
Remote port monitoring on VLT.....	560
Port monitoring commands.....	562
Chapter 13: Layer 3.....	568
Virtual routing and forwarding.....	568
Configure management VRF.....	568
Configure non-default VRF instances.....	571
VRF configuration.....	573
View VRF instance information.....	577
Static route leaking.....	578
VRF commands.....	585
Bidirectional Forwarding Detection.....	592
BFD session states.....	593
BFD three-way handshake.....	594
BFD configuration.....	594
Configure BFD globally.....	595
BFD for BGP.....	596
BFD for OSPF.....	599
BFD for Static routes.....	604

BFD commands.....	607
Border Gateway Protocol.....	613
Sessions and peers.....	614
Martian addresses.....	615
Route reflectors.....	615
Multiprotocol BGP.....	616
Attributes.....	616
Disable announcement of ASN values.....	616
Selection criteria.....	617
Weight and local preference.....	617
Multiexit discriminators.....	618
Origin.....	618
AS path and next-hop.....	619
Best path selection.....	619
More path support.....	620
Advertise cost.....	620
4-Byte AS numbers.....	620
AS number migration.....	621
Graceful restart.....	621
Configure Border Gateway Protocol.....	622
Enable BGP.....	622
BGP over unnumbered interfaces.....	625
Configure Dual Stack.....	626
Configure administrative distance.....	627
Peer templates.....	628
Neighbor fall-over.....	631
Configure password.....	633
Fast external fallover.....	634
Passive peering.....	635
Local AS.....	636
AS number limit.....	637
Redistribute routes.....	638
Additional paths.....	639
MED attributes.....	639
Local preference attribute.....	639
Weight attribute.....	640
Enable multipath.....	641
Route-map filters.....	641
Route reflector clusters.....	642
Aggregate routes.....	643
Confederations.....	643
Route dampening.....	644
Timers.....	645
Neighbor soft-reconfiguration.....	646
Redistribute iBGP route to OSPF.....	647
Example - BGP in a VLT topology.....	649
Example - Three-tier CLOS topology with eBGP.....	654
Debug BGP.....	659
BGP commands.....	660
Equal cost multi-path.....	700

Load balancing.....	701
Maximum ECMP groups and paths.....	705
ECMP commands.....	705
IPv4 routing.....	709
Assign interface IP address.....	709
Configure static routing.....	711
Address Resolution Protocol.....	711
IPv4 routing commands.....	712
IPv6 routing.....	717
Enable or disable IPv6.....	718
IPv6 addresses.....	718
Stateless autoconfiguration.....	720
Neighbor Discovery.....	720
Duplicate address discovery.....	722
Static IPv6 routing.....	722
IPv6 destination unreachable.....	723
IPv6 hop-by-hop options.....	723
View IPv6 information.....	723
IPv6 commands.....	724
Open shortest path first.....	735
Autonomous system areas.....	735
Areas, networks, and neighbors.....	736
Router types.....	736
Designated and backup designated routers.....	737
Link-state advertisements.....	738
Router priority.....	738
Shortest path first throttling.....	739
OSPFv2.....	740
OSPFv3.....	773
Object tracking manager.....	795
Interface tracking.....	796
Host tracking.....	796
Set tracking delays.....	797
Object tracking.....	797
View tracked objects.....	798
OTM commands.....	798
Policy-based routing.....	801
Access-list to match route-map.....	801
Set address to match route-map.....	802
Assign route-map to interface.....	802
View PBR information.....	802
Policy-based routing per VRF.....	803
Configuring PBR per VRF.....	803
PBR and VLT.....	804
Sample configuration.....	807
Track route reachability.....	808
Use PBR to permit and block specific traffic.....	808
View PBR configuration.....	809
PBR commands.....	810
Virtual Router Redundancy Protocol.....	813

Configuration.....	813
Create virtual router.....	814
Group version.....	815
Virtual IP addresses.....	815
Configure virtual IP address.....	815
Configure virtual IP address in a VRF.....	817
Set group priority.....	817
Authentication.....	818
Disable preempt.....	818
Advertisement interval.....	819
Interface/object tracking.....	820
Configure tracking.....	820
VRRP commands.....	821
Chapter 14: Multicast.....	827
Important notes.....	827
Configure multicast routing.....	828
Unknown multicast flood control.....	828
Enable multicast flood control.....	830
Multicast Commands.....	830
multicast snooping flood-restrict.....	830
Internet Group Management Protocol.....	830
Standards compliance.....	831
Important notes.....	831
Supported IGMP versions.....	831
Query interval.....	831
Last member query interval.....	831
Maximum response time.....	832
IGMP immediate leave.....	832
Select an IGMP version.....	832
View IGMP-enabled interfaces and groups.....	832
IGMP snooping.....	833
IGMP commands.....	835
Multicast Listener Discovery Protocol.....	846
MLD snooping.....	846
MLD snooping commands.....	848
Protocol Independent Multicast.....	854
PIM terminology.....	855
Standards compliance.....	855
PIM-SM.....	855
PIM-SSM.....	856
Configure expiry timers for S, G entries.....	857
Configure static rendezvous point.....	857
Configure dynamic RP using the BSR mechanism.....	858
Configure designated router priority.....	860
PIM commands.....	860
PIM-SM sample configuration.....	872
PIM-SSM sample configuration.....	876
Multicast VRF sample configuration.....	881
VLT multicast routing.....	889

Multicast routing table synchronization.....	889
IGMP message synchronization.....	890
Egress mask.....	890
Spanned VLAN.....	890
Deployment considerations.....	890
Example: Spanned L3 VLAN IIF.....	890
Example: Active-active PIM in a square VLT topology.....	898
VLT multicast routing commands.....	929
Chapter 15: VXLAN	931
VXLAN concepts.....	932
VXLAN as NVO solution.....	933
Configure VXLAN.....	933
Configure source IP address on VTEP.....	933
Configure a VXLAN virtual network.....	934
Configure VLAN-tagged access ports.....	934
Configure untagged access ports.....	935
Enable overlay routing between virtual networks.....	936
Advertise VXLAN source IP address	938
Configure VLT.....	939
L3 VXLAN route scaling	940
DHCP relay on VTEPs	941
View VXLAN configuration.....	941
VXLAN MAC addresses.....	944
VXLAN commands.....	946
hardware overlay-routing-profile.....	946
interface virtual-network.....	946
ip virtual-router address.....	947
ip virtual-router mac-address.....	947
member-interface.....	948
nve.....	948
remote-vtep.....	948
show hardware overlay-routing-profile mode.....	949
show interface virtual-network.....	949
show nve remote-vtep.....	950
show nve remote-vtep counters.....	950
show nve vxlan-vni.....	951
show virtual-network.....	951
show virtual-network counters.....	952
show virtual-network interface counters.....	952
show virtual-network interface.....	953
show virtual-network vlan.....	953
show vlan (virtual network).....	954
source-interface loopback.....	954
virtual-network.....	955
virtual-network untagged-vlan.....	955
vxlan-vni.....	955
VXLAN MAC commands.....	956
clear mac address-table dynamic nve remote-vtep.....	956
clear mac address-table dynamic virtual-network.....	956

show mac address-table count extended.....	957
show mac address-table count nve.....	957
show mac address-table count virtual-network.....	958
show mac address-table extended.....	958
show mac address-table nve.....	959
show mac address-table virtual-network.....	960
Example: VXLAN with static VTEP.....	961
BGP EVPN for VXLAN.....	973
BGP EVPN compared to static VXLAN.....	973
VXLAN BGP EVPN operation.....	974
Configure BGP EVPN for VXLAN.....	977
VXLAN BGP EVPN routing.....	981
BGP EVPN with VLT.....	984
VXLAN BGP commands.....	986
VXLAN EVPN commands.....	990
Example: VXLAN with BGP EVPN.....	1000
Example: VXLAN BGP EVPN — Multiple AS topology	1021
Example: VXLAN BGP EVPN — Centralized L3 gateway.....	1042
Example: VXLAN BGP EVPN — Border leaf gateway with asymmetric IRB.....	1044
Example: VXLAN BGP EVPN—Symmetric IRB.....	1048
Example - VXLAN BGP EVPN symmetric IRB with unnumbered BGP peering.....	1071
Example: Migrating from Asymmetric IRB to Symmetric IRB.....	1085
Controller-provisioned VXLAN.....	1088
Configure controller-provisioned VXLAN.....	1089
Configure and control VXLAN from VMware vCenter.....	1092
Example: VXLAN with a controller configuration.....	1095
VXLAN Controller commands.....	1099

Chapter 16: UFT modes..... 1105

Configure UFT modes.....	1106
IPv6 extended prefix routes.....	1107
UFT commands.....	1107
hardware forwarding-table mode.....	1107
hardware l3 ipv6-extended-prefix	1108
show hardware forwarding-table mode.....	1108
show hardware forwarding-table mode all.....	1109
show hardware l3.....	1109

Chapter 17: Security..... 1110

Switch security.....	1110
User management.....	1110
AAA.....	1124
Boot security.....	1138
Switch management access.....	1149
Switch management statistics.....	1161
X.509v3 certificates.....	1165
Network security.....	1189
Access control lists.....	1190
DHCP snooping.....	1190

802.1X port access control	1190
Port security.....	1190
Chapter 18: OpenFlow.....	1207
OpenFlow logical switch instance.....	1208
OpenFlow controller.....	1208
OpenFlow version 1.3.....	1208
Ports.....	1208
Flow table.....	1209
Group table.....	1209
Meter table.....	1209
Instructions.....	1209
Action set.....	1209
Action types.....	1210
Counters.....	1210
OpenFlow protocol.....	1212
OpenFlow use cases.....	1224
Configure OpenFlow.....	1225
Establish TLS connection.....	1226
OpenFlow commands.....	1227
controller.....	1227
dpid-mac-address.....	1228
in-band-mgmt.....	1228
max-backoff.....	1229
mode openflow-only.....	1229
openflow.....	1230
probe-interval.....	1230
protocol-version.....	1231
rate-limit packet_in.....	1231
show openflow.....	1232
show openflow flows.....	1233
show openflow ports.....	1233
show openflow switch.....	1235
show openflow switch controllers.....	1235
switch.....	1236
OpenFlow-only mode commands.....	1236
Chapter 19: Access Control Lists.....	1239
IP ACLs.....	1239
MAC ACLs.....	1239
Control-plane ACLs.....	1240
Control-plane ACL qualifiers.....	1240
IP fragment handling.....	1241
L3 ACL rules.....	1241
Assign sequence number to filter.....	1242
Delete ACL rule.....	1243
L2 and L3 ACLs.....	1243
Assign and apply ACL filters.....	1244
Ingress ACL filters.....	1245

Egress ACL filters.....	1245
VTY ACLs.....	1246
SNMP ACLs.....	1246
Clear access-list counters.....	1247
IP prefix-lists.....	1247
Route-maps.....	1247
Match routes.....	1249
Set conditions.....	1249
Continue clause.....	1250
ACL flow-based monitoring.....	1250
Enable flow-based monitoring.....	1251
View ACL table utilization report.....	1252
Known behavior.....	1253
ACL logging.....	1254
Important notes.....	1254
ACL commands.....	1254
clear ip access-list counters.....	1254
clear ipv6 access-list counters.....	1255
clear mac access-list counters.....	1255
deny.....	1255
deny (IPv6).....	1256
deny (MAC).....	1257
deny icmp.....	1257
deny icmp (IPv6).....	1258
deny ip.....	1258
deny ipv6.....	1259
deny tcp.....	1259
deny tcp (IPv6).....	1260
deny udp.....	1261
deny udp (IPv6).....	1262
description.....	1263
ip access-group.....	1263
ip access-list.....	1263
ip as-path access-list.....	1264
ip community-list standard deny.....	1264
ip community-list standard permit.....	1265
ip extcommunity-list standard deny.....	1265
ip extcommunity-list standard permit.....	1266
ip prefix-list description.....	1266
ip prefix-list deny.....	1266
ip prefix-list permit.....	1267
ip prefix-list seq deny.....	1267
ip prefix-list seq permit.....	1268
ipv6 access-group.....	1268
ipv6 access-list.....	1268
ipv6 prefix-list deny.....	1269
ipv6 prefix-list description.....	1269
ipv6 prefix-list permit.....	1270
ipv6 prefix-list seq deny.....	1270
ipv6 prefix-list seq permit.....	1270

mac access-group.....	1271
mac access-list.....	1271
permit.....	1272
permit (IPv6).....	1272
permit (MAC).....	1273
permit icmp.....	1274
permit icmp (IPv6).....	1274
permit ip.....	1275
permit ipv6.....	1275
permit tcp.....	1276
permit tcp (IPv6).....	1277
permit udp.....	1277
permit udp (IPv6).....	1278
remark.....	1279
seq deny.....	1279
seq deny (IPv6).....	1280
seq deny (MAC).....	1281
seq deny icmp.....	1281
seq deny icmp (IPv6).....	1282
seq deny ip.....	1282
seq deny ipv6.....	1283
seq deny tcp.....	1284
seq deny tcp (IPv6).....	1284
seq deny udp.....	1285
seq deny udp (IPv6).....	1286
seq permit.....	1287
seq permit (IPv6).....	1288
seq permit (MAC).....	1288
seq permit icmp.....	1289
seq permit icmp (IPv6).....	1290
seq permit ip.....	1290
seq permit ipv6.....	1291
seq permit tcp.....	1291
seq permit tcp (IPv6).....	1292
seq permit udp.....	1293
seq permit udp (IPv6).....	1294
show access-group.....	1295
show access-lists.....	1296
show acl-table-usage detail.....	1297
show ip as-path-access-list	1301
show ip community-list.....	1301
show ip extcommunity-list.....	1302
show ip prefix-list.....	1302
show logging access-list.....	1302
Route-map commands.....	1303
continue.....	1303
match as-path.....	1303
match community.....	1303
match extcommunity.....	1304
match interface.....	1304

match ip address.....	1305
match ip next-hop.....	1305
match ipv6 address.....	1305
match ipv6 next-hop.....	1306
match metric.....	1306
match origin.....	1306
match route-type.....	1307
match tag.....	1307
route-map.....	1307
set comm-list add.....	1308
set comm-list delete.....	1308
set community.....	1309
set extcomm-list add.....	1309
set extcomm-list delete.....	1309
set extcommunity.....	1310
set local-preference.....	1310
set metric.....	1311
set metric-type.....	1311
set next-hop.....	1312
set origin.....	1312
set tag.....	1312
set weight.....	1313
show route-map.....	1313

Chapter 20: Quality of service..... 1314

Configure quality of service.....	1314
Ingress traffic classification.....	1316
Data traffic classification.....	1316
Control-plane policing.....	1320
Egress traffic classification.....	1327
Policing traffic.....	1328
Mark Traffic.....	1329
Color traffic.....	1329
Modify packet fields.....	1329
Shaping traffic.....	1330
Bandwidth allocation.....	1330
Strict priority queuing.....	1331
Rate adjustment.....	1332
Buffer management.....	1333
Configure ingress buffer.....	1334
Configure egress buffer.....	1335
Deep Buffer mode.....	1336
Congestion avoidance.....	1337
Storm control.....	1339
RoCE for faster access and lossless connectivity.....	1339
Configure RoCE on the switch.....	1340
RoCE for VXLAN over VLT.....	1343
Buffer statistics tracking.....	1352
Port to port-pipe and MMU mapping.....	1353
QoS commands.....	1358

bandwidth.....	1358
buffer-statistics-tracking.....	1358
class.....	1358
class-map.....	1359
clear qos statistics.....	1359
clear qos statistics type.....	1360
control-plane.....	1360
control-plane-buffer-size.....	1361
flowcontrol.....	1361
hardware deep-buffer-mode.....	1361
match.....	1362
match cos.....	1363
match dscp.....	1363
match precedence.....	1363
match queue.....	1364
match vlan.....	1364
mtu.....	1365
pause.....	1365
pfc-cos.....	1366
pfc-max-buffer-size.....	1366
pfc-shared-buffer-size.....	1366
pfc-shared-headroom-buffer-size.....	1367
police.....	1367
policy-map.....	1368
priority.....	1368
priority-flow-control mode.....	1369
qos-group dot1p.....	1369
qos-group dscp.....	1369
qos-map traffic-class.....	1370
qos-rate-adjust.....	1370
queue-limit.....	1370
queue bandwidth.....	1371
queue qos-group.....	1372
queue qos-group (Z9332F-ON).....	1372
random-detect (interface).....	1372
random-detect (queue).....	1373
random-detect color.....	1373
random-detect ecn.....	1373
random-detect ecn.....	1374
random-detect pool.....	1374
random-detect weight.....	1375
service-policy.....	1375
set cos.....	1375
set dscp.....	1376
set qos-group.....	1376
shape.....	1377
show class-map.....	1377
show control-plane buffers.....	1378
show control-plane buffer-stats.....	1379
show control-plane info.....	1380

show control-plane statistics.....	1380
show hardware deep-buffer-mode.....	1381
show interface priority-flow-control.....	1382
show qos interface.....	1382
show policy-map.....	1383
show qos control-plane.....	1383
show qos egress buffers interface.....	1384
show qos egress buffer-statistics-tracking.....	1384
show qos egress buffer-stats interface.....	1385
show qos headroom-pool buffer-statistics-tracking.....	1385
show qos ingress buffers interface.....	1386
show qos ingress buffer-statistics-tracking.....	1387
show qos ingress buffer-stats interface.....	1387
show qos maps.....	1388
show qos maps (Z9332F-ON).....	1390
show qos port-map details.....	1390
show qos-rate-adjust.....	1395
show qos service-pool buffer-statistics-tracking.....	1395
show qos system.....	1396
show qos system buffers.....	1396
show qos wred-profile.....	1398
show queuing statistics.....	1398
system qos.....	1399
trust dot1p-map.....	1400
trust dscp-map.....	1400
trust-map.....	1400
wred.....	1401

Chapter 21: Virtual Link Trunking..... 1402

Terminology.....	1403
VLT domain.....	1403
VLT interconnect.....	1404
Graceful LACP with VLT.....	1404
Configure VLT.....	1406
Configure a Spanning Tree Protocol.....	1407
Create the VLT domain.....	1411
Configure the VLTi.....	1411
Configure the VLT MAC address.....	1412
Configure the delay restore timer.....	1412
Configure the VLT peer liveliness check.....	1412
Configure a VLT port channel.....	1416
Configure VLT peer routing.....	1417
Configure VRRP Active-Active mode.....	1417
Migrate VMs across data centers with eVLT.....	1418
View VLT information.....	1422
VLT commands.....	1422
backup destination.....	1422
delay-restore.....	1423
discovery-interface.....	1423
peer-routing.....	1424

peer-routing-timeout.....	1424
primary-priority.....	1424
show running-configuration vlt.....	1425
show spanning-tree virtual-interface	1425
show vlt.....	1427
show vlt backup-link.....	1428
show vlt mac-inconsistency.....	1429
show vlt mismatch.....	1429
show vlt role.....	1433
show vlt vlt-port-detail.....	1433
vlt-domain.....	1434
vlt-port-channel.....	1434
vlt-mac.....	1435
vrrp mode active-active.....	1435
Chapter 22: Uplink Failure Detection.....	1436
Configure uplink failure detection.....	1437
Uplink failure detection on VLT.....	1439
Sample configurations of UFD on VLT.....	1441
UFD commands.....	1443
clear ufd-disable.....	1443
defer-time.....	1443
downstream.....	1443
downstream auto-recover.....	1444
downstream disable links.....	1444
enable.....	1444
name.....	1445
show running-configuration uplink-state-group	1445
show uplink-state-group	1445
uplink-state-group	1447
upstream.....	1447
Chapter 23: Converged data center services.....	1448
Priority flow control.....	1448
PFC configuration notes.....	1449
Configure PFC.....	1451
PFC commands.....	1454
Enhanced transmission selection.....	1458
ETS configuration notes.....	1458
Configure ETS.....	1458
ETS commands.....	1461
Data center bridging eXchange	1461
DCBX configuration notes.....	1462
Verify DCBX configuration.....	1463
DCBX commands.....	1467
Internet small computer system interface.....	1472
iSCSI configuration notes.....	1473
Configure iSCSI optimization.....	1473
iSCSI synchronization on VLT.....	1476

iSCSI commands.....	1476
Converged network DCB example.....	1480
Chapter 24: sFlow.....	1487
Enable sFlow.....	1487
Max-header size configuration.....	1488
Collector configuration.....	1489
Polling-interval configuration.....	1490
Sample-rate configuration.....	1490
Source interface configuration.....	1491
View sFlow information.....	1492
sFlow commands.....	1493
sflow collector.....	1493
sflow enable.....	1493
sflow max-header-size.....	1494
sflow polling-interval.....	1494
sflow sample-rate.....	1495
sflow source-interface.....	1495
show sflow.....	1495
Chapter 25: Telemetry	1497
Telemetry terminology.....	1497
YANG-modeled telemetry data.....	1497
Configure telemetry.....	1499
View telemetry configuration.....	1501
Telemetry commands.....	1503
debug telemetry.....	1503
telemetry.....	1504
enable.....	1504
destination-group (telemetry).....	1504
destination.....	1505
subscription-profile.....	1505
destination-group (subscription-profile).....	1505
sensor-group (subscription-profile).....	1506
encoding.....	1507
transport.....	1508
source-interface.....	1508
show telemetry.....	1509
Example: Configure streaming telemetry.....	1512
Chapter 26: RESTCONF API.....	1515
Configure RESTCONF API.....	1515
RESTCONF request of CLI command.....	1516
Obtain RESTCONF API documentation from OS10.....	1517
Translated RESTCONF requests example.....	1517
REST Token-Based Authentication.....	1520
Acquire new token.....	1520
Access token.....	1521
Refresh token.....	1521

CLI commands for RESTCONF API.....	1521
rest api restconf.....	1521
rest https cipher-suite.....	1522
rest https server-certificate.....	1522
rest https session timeout.....	1522
cli mode rest-translate.....	1523
no cli mode.....	1523
show cli mode.....	1523
rest authentication token validity.....	1524
rest authentication token max-refresh.....	1524
rest authentication token algorithm.....	1525
RESTCONF API tasks.....	1525
View XML structure of CLI commands.....	1526
RESTCONF API Examples.....	1527

Chapter 27: Troubleshoot Dell EMC SmartFabric OS10..... 1529

Diagnostic tools.....	1529
Boot information.....	1530
Monitor processes.....	1530
LED settings.....	1531
Packet analysis.....	1531
Port adapters and modules.....	1532
Test network connectivity.....	1532
View solution ID.....	1534
View diagnostics.....	1535
Diagnostic commands.....	1536
Recover Linux password	1544
Recover OS10 user name password	1545
Restore factory defaults.....	1547
SupportAssist.....	1548
Important notes.....	1548
Configure SupportAssist.....	1548
Set company name.....	1549
Set contact information.....	1550
Schedule activity.....	1550
View status.....	1551
View warranty information.....	1552
View SupportAssist logs.....	1553
List of country names and codes.....	1553
SupportAssist commands.....	1560
Support bundle.....	1571
Event notifications.....	1571
generate support-bundle.....	1572
System monitoring.....	1572
System events and alarms.....	1572
System logging.....	1575
System logging over TLS.....	1576
View system logs.....	1578
Environmental monitoring.....	1579
Link-bundle monitoring.....	1579

Alarm commands.....	1580
Logging commands.....	1586
Log into OS10 device.....	1591
Frequently asked questions.....	1592
Installation.....	1592
Hardware.....	1593
Configuration.....	1593
Security.....	1593
Layer 2.....	1593
Layer 3.....	1593
System management.....	1594
Access control lists.....	1594
Quality of service.....	1594
Monitoring.....	1595
Chapter 28: Support resources.....	1596
Index.....	1597

About this guide

This guide is intended for system administrators who are responsible for configuring and maintaining networks. It covers the following details:

- Installation and set up of Dell EMC SmartFabric OS10.
- Description, configuration information, and examples of features that SmartFabric OS10 supports.
- Reference information and examples on configuring protocols. For complete information about protocols, see the related documentation, including Internet Engineering Task Force (IETF) and Request For Comments (RFC).
- Command reference information for all the SmartFabric OS10 CLI commands.

To use this guide, you must have a good knowledge of Layer 2 (L2) and Layer 3 (L3) networking technologies.

Conventions

This guide uses the following conventions to describe command syntax.

Keyword	Keywords are in Courier (a monospaced font) and must be entered in the CLI as listed.
<i>parameter</i>	Parameters are in italics and require a number or word to be entered in the CLI.
{X}	Keywords and parameters within braces must be entered in the CLI.
[X]	Keywords and parameters within brackets are optional.
x y	Keywords and parameters separated by a bar require you to choose one option.

Related Documents

For more information about the Dell EMC Networking switches, see the following documents:

- *Dell EMC SmartFabric OS10 Installation Guide*
- *Dell EMC SmartFabric OS10 Quick Start Guide*
- *Dell EMC SmartFabric OS10 Release Notes*
- *Dell EMC SmartFabric OS10 Security Guide*

For more reference documents and information, see the [Dell EMC Networking OS10 Info Hub](#) page.

For more technical information about the Dell Technologies networking solutions portfolio, see the [Networking Solutions](#) page.

Documentation Feedback

Dell Technologies strives to provide accurate and comprehensive documentation and welcomes your suggestions and comments. You can provide feedback in the following ways:

- Online feedback form—Rate the documentation or provide your feedback on any of our documentation pages at www.dell.com/support.
- Email—Send your feedback to networkingpub.feedback@dell.com. Include the document title, release number, chapter title, and section title of the text corresponding to the feedback.

For technical support or questions, please contact [Technical Support](#).

Change history

The following table provides an overview of the changes to this guide from a previous OS10 release to the 10.5.1 release. For more information about the new features, see the respective sections.

Table 1. New in 10.5.1.6

Revision	Date	Feature	Description
A01	2020-09-03	TACACS as Primary Authentication	Support for TACACS as the primary authentication method.
		MX-IOM Hardware Replacement	Procedure to replace an IOM module.

Table 2. New in 10.5.1.0

Revision	Date	Feature	Description
A00	2020-02-13	Precision Time Protocol	Precision Time Protocol <ul style="list-style-type: none"> • Overview • Configuration notes • Configure PTP • Examples
		Re-map protocols to queues	Configure protocol to queue remapping
		802.1x with EAP-TLS support	<ul style="list-style-type: none"> • Configure 802.1x—Added support for EAP-TLS • Configure RADIUS server
		Switch warranty information	View warranty information for OS10 switch
		DCBX commands	DCBX debug commands
		Multiswitch fabric (E Port) support	Multiswitch fabric (E Port) <ul style="list-style-type: none"> • Configure multiswitch fabric • Verify multiswitch fabric configuration • Multiswitch fabric CLI commands
		RESTCONF request of CLI command	REST APIs Dev Driven Auto-Docs <ul style="list-style-type: none"> • Find RESTCONF request of CLI command • CLI to RESTCONF translation examples
		REST Token-Based Authentication	REST Token-Based Authentication <ul style="list-style-type: none"> • Acquire new token • Access token • Refresh token
		Default MTU configuration	Default MTU configuration
		RSTP/MSTP/RPVST Force Version	Configure a forced version of spanning-tree to transmit BPDUs
		Symmetric IRB routing	Symmetric IRB routing <ul style="list-style-type: none"> • Configure Symmetric IRB for VXLAN BGP EVPN • Example: VXLAN BGP EVPN — Symmetric IRB
		BFD for specific static routes	BFD for specific static routes
External packages	Support for Docker containers		

Table 2. New in 10.5.1.0 (continued)

Revision	Date	Feature	Description
		BGP unnumbered interfaces	Support for BGP unnumbered interfaces
		Conflicting interface ranges	Conflicting interface ranges
		AAA authorization	Support for AAA authorization
		Port security	Port security features: <ul style="list-style-type: none">• MAC learning limit• Sticky MAC addresses• MAC move
		PBR in VLT setup	PBR support for VLT
		Configure BFD	Support for 50 ms BFD timer
		OSPF ignore MTU	Ignore the MTU size of the OSPF peer interface
		Secure boot	Verify the authenticity and integrity of OS10 image
		Downgrade to Release 10.5.0.0 or earlier releases	Downgrade and rollback instructions

Getting Started with Dell EMC SmartFabric OS10

Dell EMC SmartFabric OS10 is a network operating system (NOS) supporting multiple architectures and environments. The SmartFabric OS10 solution allows multi-layered disaggregation of network functionality. SmartFabric OS10 bundles industry-standard management, monitoring, and Layer 2 and Layer 3 networking stacks over CLI, SNMP, and REST interfaces. Users can choose their own third-party networking, monitoring, management, and orchestration applications. To develop scalable L2 and L3 networks, the SmartFabric OS10 delivers a modular and disaggregated solution in a single-binary image.

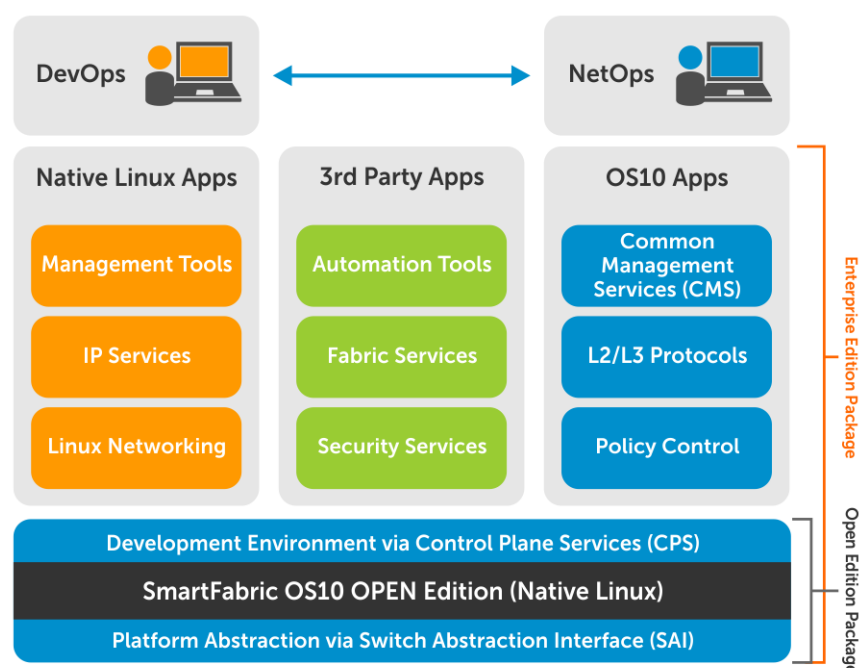

SmartFabric OS10 key features

- Standard networking features, interfaces, and scripting functions for legacy network operations integration
- Standards-based switching hardware abstraction through the Switch Abstraction Interface (SAI)
- Pervasive, unrestricted developer environment through Control Plane Services (CPS)
- Layer 2 switching and Layer 3 routing protocols with integrated IP services, quality of service, manageability, and automation features
- Increase VM Mobility region by extending L2 VLAN within or across two DCs with unique VLT capabilities
- Programmatic APIs and CLI automation using batch and aliases to simplify configuration management
- Converged network support for Data Center Bridging, with priority flow control (802.1Qbb), ETS (802.1Qaz), DCBx, and iSCSI TLV

Requirements

- Open network install environment (ONIE)-enabled Dell EMC device
- To install: Store SmartFabric OS10 software image on a server (HTTP, FTP, SCP, SFTP, TFTP) or universal serial bus (USB) media
- To configure: Set up remote access to the SmartFabric OS10 switch — see [Remote access](#).

Next steps: Determine if a Dell EMC ONIE-enabled switch has a factory-installed OS10 or no OS installed. Go to [Switch with factory-installed OS10](#) or [Switch without OS installed](#).



NOTE:

Starting from Release 10.5.1.0, SmartFabric OS10 comes with a single partition. Both the active and standby software images are stored in this partition. OS10 installation and upgrade procedures continue to work as usual.

However, after you install 10.5.1.0 (or later) image, if you want to downgrade to 10.5.0.0 (or earlier) image, you must backup the configuration and license files. See [Downgrade to Release 10.5.0.0 or earlier releases](#) for more information.

Supported platforms: For a list of currently supported Dell EMC switches for your SmartFabric OS10 release, see the *SmartFabric OS10 Release Notes*. The SmartFabric OS10 Release Notes are stored in the Dell Digital Locker (DDL) with SmartFabric OS10 software updates.

Third-party software: Dell EMC does not support third-party software and drivers, community projects, code development, or implementation and development of security rules and policies.

Configuration notes

All Dell EMC PowerSwitches except MX-Series:

- If you pre-order a Dell EMC switch with OS10, you do not need to install a license. If you download OS10 on a trial basis, OS10 comes with a 120-day trial license. Purchase and install a perpetual license after the trial period expires. Once the trial period expires, the switch generates an error log on the console once every hour as follows: <165>1 2020-08-05T21:39:53.497121+00:00 OS10 dn_alm 648 - - Node.1-Unit.1:PRI [event], Dell EMC (OS10) %LADF_LIC_EVAL_PRD_NOTICE: Evaluation license time limit notice. Evaluation license expired. Please install a valid perpetual license.
- After you install OS10 and log in, install the OS10 license by following the instructions in the OS10 User Guide - Install OS10 License section.
- When you install a license using the Management VRF, only some file transfer methods like FTP, HTTP, localfs, SCP, SFTP, TFTP and USB are supported. For more information, see the Install OS10 license section in the OS10 User Guide.

Switch with factory-installed OS10

A switch may come with OS10 Enterprise Edition factory-loaded. OS10 upgrades are available for download from the Dell Digital Locker (DDL). A factory-loaded OS10 image includes a perpetual license.

On a factory-installed OS10 switch, after you log in, you can perform these tasks:

- [Check the OS10 version.](#)
- [Upgrade the OS10 image.](#)
- [Re-install the license.](#)

If OS10 is pre-installed on a switch, zero-touch deployment (ZTD) is enabled by default. You can configure ZTD to install a new OS10 image. For more information about how to automate switch deployment, see [Zero-touch deployment](#).

 **NOTE:** If a factory-installed OS10 image is deleted after booting into ONIE: Install OS mode, you must re-install the license.

MX Ethernet I/O modules

On Dell EMC PowerEdge MX Ethernet I/O modules, OS10 is factory-installed on the MX9116n Fabric Switching Engine and MX5108n Ethernet Switch. The MX7116n Fabric Expander Module does not support OS10 and functions as an unmanaged Ethernet repeater connected to a Fabric Switching Engine.

Log in

Connect a terminal emulator to the console serial port on the switch using a serial cable. Serial port settings are 115200 baud rate, 8 data bits, and no parity.

To log in to an OS10 switch, power up and wait for the system to perform a power-on self-test (POST). Enter `admin` for both the default user name and user password.

Change the default `admin` password after the first OS10 login. The system saves the new password for future logins. After you change the password through the CLI, use the `write memory` command to save the configuration. For example:

```
OS10 login: admin
Password: admin
Last login: Sat Oct  6 00:25:33 UTC 2018 on ttyS0
Linux OS10 4.9.110 #1 SMP Debian 4.9.110-3+deb9u4 x86_64
```

```
The programs included with the Debian GNU/Linux system are free software;
the exact distribution terms for each program are described in the
individual files in /usr/share/doc/*/copyright.
```

```
Debian GNU/Linux comes with ABSOLUTELY NO WARRANTY, to the extent
permitted by applicable law.
```

```
-----
-*          Dell EMC  Network Operating System (OS10)          *-
-*                                                    *-
-* Copyright (c) 1999-2018 by Dell Inc. All Rights Reserved.  *-
-*                                                    *-
-----
```

```
This product is protected by U.S. and international copyright and
intellectual property laws. Dell EMC and the Dell EMC logo are
trademarks of Dell Inc. in the United States and/or other
jurisdictions. All other marks and names mentioned herein may be
trademarks of their respective companies.
```

```
OS10# configure terminal
% Error: ZTD is in progress(configuration is locked).
OS10# ztd cancel
OS10# configure terminal
OS10(config)# username admin password alpha404! role sysadmin
OS10(config)# exit
OS10# write memory
```

Configuration notes

All Dell EMC PowerSwitches:

When logging into a switch, it may take 6 to 10 seconds for the CLI prompt to display.

Check OS10 version

Dell EMC recommends that you upgrade a factory-loaded OS10 to the latest OS10 version.

- To check the current version of the OS10 image, use the `show version` command.
- To check the OS10 versions available for download, follow the procedure in [OS10 upgrade->Download OS10 for upgrade](#).

Check OS10 version

```
OS10# show version
Network Operating System
OS Version: 10.5.1.0
Build Version: 10.5.1.0.123
Build Time: 2020-02-12T02:34:02+0000
System Type: Z9100-ON
Architecture: x86_64
Up Time: 04:18:36
```

OS10 upgrade

To upgrade an OS10 image, first download and unpack the new OS10 binary image as described in [Download OS10 image for upgrade](#). Then copy the binary image file to a local server and follow the steps in [Install OS10 upgrade](#).

i **NOTE:** To upgrade a Dell EMC ONIE switch to OS10 from OS9 or another network operating system (NOS), follow the procedure in [Switch without OS installed](#).

Download OS10 image for upgrade

i **NOTE:** For MX-Series Ethernet I/O modules, OS10 updates are packaged as Dell Upgrade Packages (DUPs) and can be downloaded from www.dell.com/support/. For information on how to download the DUP files to upgrade OS10 on an MX9116n and MX5108n switch, see the *Dell EMC SmartFabric OS10 Release Notes—Release 10.5.0*.

To upgrade an existing OS10 image, first download a new OS10 Enterprise Edition image from DDL.

1. Sign into [DDL](#) using your account credentials.
2. Locate the entry for your entitlement ID and order number, and then select the product name.
3. Select the **Available Downloads** tab on the Product page.
4. Select the OS10 Enterprise Edition image to download, and then click **Download**.
5. Read the Dell End User License Agreement, and then scroll to the end of the agreement and click **Yes, I agree**.
6. Select how to download the software files, then click **Download Now**.
7. After you download the OS10 Enterprise Edition image, unpack the .tar file and store the OS10 binary image on a local server. To unpack the .tar file, follow these guidelines:

- Extract the OS10 binary file from the .tar file. For example, to unpack a .tar file on a Linux server or from the ONIE prompt, enter:

```
tar -xf tar_filename
```

i **NOTE:** Some Windows unzip applications insert extra carriage returns (CR) or line feeds (LF) when they extract the contents of a .tar file. The extra CRs and LFs may corrupt the downloaded OS10 binary image. Turn OFF this option if you use a Windows-based tool to untar an OS10 binary file. For example, in WinRAR under the Advanced Options tab, de-select the .tar file smart CR/LF conversion feature.

- Generate a checksum for the downloaded OS10 binary image by using the `md5sum` command on the image file. Ensure that the generated checksum matches the checksum in the image MD5 file that is extracted from the .tar file.

```
md5sum image_filename
```

8. Follow the procedure in [Install OS10 upgrade](#).

Install OS10 upgrade

After you download and unpack a new OS10 binary image as described in [Download OS10 image for upgrade](#), follow these steps:

- i** **NOTE:** During the OS10 image upgrade process in a VLT setup, when the VLT peers are running different software versions, make no configuration changes on a VLT peer. Ensure that both nodes are upgraded to the same version before you make any configuration change.
- i** **NOTE:** On an MX-Series I/O module, install OS10 upgrades in downloaded DUP files by following the instructions in the *Dell EMC SmartFabric OS10 Release Notes—Release 10.5.0*.
- i** **NOTE:** While performing an upgrade from 10.4.0E.R4S to 10.5.0.4 and later in GUI mode, all the IOMs may get upgraded with a time-out notification to the OME-M or an IOM (DNV Master) may not get upgraded. Check the IOMs to ascertain whether the upgrade was successful or not. If the IOMs did not get upgraded, re-initiate the upgrade for the impacted nodes.

1. (Optional) Back up the current running configuration to the startup configuration in EXEC mode.

```
OS10# copy running-configuration startup-configuration
```

2. Back up the startup configuration (`startup.xml`) in EXEC mode.

```
copy config://startup.xml ftp://userid:passwd@hostip/backup_filepath/10.5.0.4-startup.xml
```

3. Download the new OS10 binary image, also called the standby image, from a local server using the `image download server_filepath/filename` command in EXEC mode; for example:

```
OS10# image download sftp://admin:passwd@10.1.1.1/home/admin/images/OS10EE.bin
```

- (Optional) View the current software download status in EXEC mode.

```
OS10# show image status
```

- Cancel any staged firmware update using the `image cancel` command.

```
OS10# image cancel
```

- Install the OS10 standby image using the `image install file-url` command in EXEC mode, where `filename` is the name of the image file downloaded in Step 3 with the `image download` command; for example:

```
OS10# image install image://OS10EE.bin
```

NOTE: OS10 has two images: A and B. One image is active, which is the current running version and used as the running software at the next system reload. The other image remains standby, used for software upgrades.

The `image install` command installs the downloaded image to the system. If you had modified text files or installed custom packages, they would not be available with the standby image. Back up the modified files and reinstall the packages after downloading the standby image.

NOTE: On an MX9116n Fabric Switching Engine and MX5108n Ethernet Switch, if you install an OS10 image using a DUP file, all firmware components are upgraded. The firmware upgrade is stored as a pending installation until you reload the switch. To view the contents of the firmware upgrade, use the `show image firmware` command.

- (Optional) View the status of the software installation in EXEC mode.

```
OS10# show image status
```

- (Optional) Verify the standby image version in EXEC mode; for example:

```
OS10# show boot
Current system image information:
=====
Type          Boot Type      Active          Standby          Next-Boot
-----
---
Node-id 1 Flash Boot      [A] 10.5.0.4    [B] 10.5.1.0    [B] standby
```

```
OS10# show boot detail
Current system image information detail:
=====
Type:                Node-id 1
Boot Type:           Flash Boot
Active Partition:    A
Active SW Version:   10.5.0.4
Active SW Build Version: 10.5.0.4.650
Active Kernel Version: Linux 4.9.189
Active Build Date/Time: 2020-02-11T11:13:08Z
Standby Partition:   B
Standby SW Version:  10.5.1.0
Standby SW Build Version: 10.5.1.0.123
Standby Build Date/Time: 2020-02-12T02:34:02Z
Next-Boot:           standby[B]
```

NOTE: After the 10.5.1.0 image is installed successfully, using the `boot system {active | standby}` command does not have any effect and might not be reflected in the `show boot detail` command. The system boots up only with the 10.5.1.0 image in the next reload. This process is not reversible. Dell EMC recommends that you do not install 10.5.0.0 or an earlier image in this step.

- Reload the new software image in EXEC mode.

```
OS10# reload
```

NOTE: During reload, the system enters and exits the ONIE environment automatically and boots using the 10.5.1.0 image. This reload takes a longer time than usual. You must not interrupt this reload process.

10. Use the `show version` command in EXEC mode to verify that the downloaded OS10 image is installed as the current running version.

```
OS10# show version
Network Operating System
OS Version: 10.5.1.0
Build Version: 10.5.1.0.123
Build Time: 2020-02-12T02:34:02+0000
System Type: Z9100-ON
Architecture: x86_64
Up Time: 04:40:37
```

Restrictions on Upgrade to Release 10.5.1.0 or later version

After you install the 10.5.1.x image and before you perform a reload, the following images are available in the switch:

- Image A: 10.5.0.0 (active)
- Image B: 10.5.1.0 (standby)

During this state, you must not install 10.5.0.x or an earlier release again in the switch. Release 10.5.1.x ONIE preparation and setup is not reversible and the switch only boots using the 10.5.1.x image.

Install firmware upgrade

You may need to upgrade the firmware components on an OS10 switch without upgrading the OS10 image. To upgrade firmware components in a separate operation:

1. Download the OS10 firmware file from a server using the `image download server-filepath/firmware-filename` command in EXEC mode; for example:

```
OS10# image download http://10.11.8.184/tftpboot/users/regr//neteng/okelani/files/new/onie-firmware-x86_64-dellemc_s5200_c3538-r0.3.40.5.1-9.bin
```

2. Install the OS10 firmware file using the `image install firmware-file-url` command in EXEC mode, where `firmware-file` is the name of the firmware file downloaded in Step 1; for example:

```
OS10# image install image://onie-firmware-x86_64-dellemc_s5200_c3538-r0.3.40.5.1-9.bin
```

To view the pending firmware upgrade, use the `show image firmware` command. To cancel a firmware installation and remove any pending firmware upgrades, use the `image cancel` command.

3. Reload the switch in EXEC mode.

```
OS10# reload
```

Upgrade commands

boot system

Sets the boot image to use for the next reboot.

Syntax	<code>boot system {active standby}</code>
Parameters	<ul style="list-style-type: none">• <code>active</code> — Reset the running image as the next boot image.• <code>standby</code> — Set the standby image as the next boot image.
Default	Active
Command Mode	EXEC
Usage Information	Use this command to configure the location of the OS10 image used to reload the software at boot time. Use the <code>show boot</code> command to view the configured next boot image. This command applies immediately and does not require the <code>commit</code> command.

Example

```
OS10# boot system standby
```

Supported Releases

10.2.0E or later

image cancel

Cancels an image or firmware file download that is in progress.

Syntax `image cancel`

Parameters None

Default Not configured

Command Mode EXEC

Usage Information The `image cancel` command cancels a file download from a server, such as an OS10 binary image or firmware upgrade, that is in progress. After an image download completes, the command has no effect. The command also removes any pending firmware upgrades on the switch.

Example

```
OS10# image cancel
```

Supported Releases

10.2.0E or later

image copy

Copies the active image to the standby location.

Syntax `image copy active-to-standby`

Parameters `active-to-standby`—Enter to copy the entire active image to the standby location, a mirror image.

Default Not configured

Command Mode EXEC

Usage Information Duplicate the active, running software image to the standby image location.

Example

```
OS10# image copy active-to-standby
```

Supported Releases

10.2.0E or later

image download

Downloads a new software image or firmware file to the local file system.

Syntax `image download file-url`

Parameters `file-url`—Enter the URL of the image file:

- `ftp://userid:passwd@hostip/filepath`—Enter the path to copy from the remote FTP server.
- `http://hostip/filepath`—Enter the path to copy from the remote HTTP server.
- `scp://userid:passwd@hostip/filepath`—Enter the path to copy from the remote SCP file system.
- `sftp://userid:passwd@hostip/filepath`—Enter the path to copy from the remote SFTP file system.
- `tftp://hostip/filepath`—Enter the path to copy from the remote TFTP file system.

- `usb://filepath`—Enter the path to copy from the USB file system.

Default Not configured

Command Mode EXEC

Usage Information

The `image download` command downloads image files to the `image` directory. Use the `dir image` command to display the contents of the `image` directory. OS10 SW image files are large, and occupy a significant amount of disk space. Dell EMC Networking recommends that you remove unnecessary image files from the `image` directory by using the `delete` command; for example:

```
delete image://OS10EE-10.2.0.bin
```

Use the `show image status` command to view the download progress.

When using the `scp` and `sftp` options, always enter an absolute file path instead of a path relative to the home directory of the user account; for example:

```
image download sftp://dellos10:password@10.1.1.1/home/dellos10/images/PKGS_OS10EE-10.4.3.bin
```

Example

```
OS10# image download sftp://dellos10:adminTo%40%20@10.1.1.1/home/dellos10/images/PKGS_OS10-Enterprise-10.4.0E.55-installer-x86_64.bin
```

Supported Releases 10.2.0E or later

image install

Installs a new image or firmware file from a previously downloaded file or from a remote location.

Syntax `image install file-url`

Parameters

- `file-url`—Location of the image or firmware file:
 - `ftp://userid:passwd@hostip/filepath`—Enter the path to install from a remote FTP server.
 - `http://hostip/filepath`—Enter the path to install from the remote HTTP server.
 - `scp://userid:passwd@hostip/filepath`—Enter the path to install from a remote SCP file system.
 - `sftp://userid:passwd@hostip/filepath`—Enter the path to install from a remote SFTP file system.
 - `tftp://hostip/filepath`—Enter the path to install from a remote TFTP file system.
 - `image://filename`—Enter the path to use to install the image from a local file system.
 - `usb://filepath`—Enter the path to use to install the image from the USB file system.

Default All

Command Mode EXEC

Usage Information

Use the `show image status` command to view the installation progress.

Example

```
OS10# image install ftp://10.206.28.174:/PKGS_OS10-Enterprise-10.4.0E.55-installer-x86_64.bin
```

Supported Releases 10.2.0E or later

show boot

Displays boot-related information.

- Syntax** show boot [detail]
- Parameters** detail — (Optional) Enter to display detailed information.
- Default** Not configured
- Command Mode** EXEC
- Usage Information** Use the boot system command to set the boot image for the next reboot.

Example

```
OS10# show boot
Current system image information:
=====
Type          Boot Type      Active              Standby              Next-Boot
-----
Node-id 1 Flash Boot      [A] 10.5.0.4        [B] 10.5.1.0        [B] standby
```

Example (Detail)

```
OS10# show boot detail
Current system image information detail:
=====
Type:                Node-id 1
Boot Type:           Flash Boot
Active Partition:    A
Active SW Version:   10.5.0.4
Active SW Build Version: 10.5.0.4.650
Active Kernel Version: Linux 4.9.189
Active Build Date/Time: 2020-02-11T11:13:08Z
Standby Partition:   B
Standby SW Version:  10.5.1.0
Standby SW Build Version: 10.5.1.0.123
Standby Build Date/Time: 2020-02-12T02:34:02Z
Next-Boot:           standby[B]
```

- Supported Releases** 10.2.0E or later

show image firmware

Displays any pending firmware upgrades and the status of past firmware upgrades.

- Syntax** show image firmware
- Parameters** None
- Default** Not configured
- Command Mode** EXEC
- Usage Information** If you install an OS10 firmware file, the firmware upgrade is stored as a pending installation until you reload the switch. To view the contents of the firmware upgrade, use the show image firmware command. No entries are displayed in the show command output if there are no pending or past firmware upgrades available.

Example

```
OS10# show image firmware

Upgrade State: pending reload (staged)
Pending Firmware Upgrade(s)
# Name
  Version      Date
-----
1 onie-firmware-x86_64-dellemc_mxseries-r0.3.35.5.1-17.bin
```

```

3.35.5.1 2019-03-25 15:19:19
2 cpld-fw-mx5108n-r1.5.4.1.bin
1.5.4.1 2019-03-25 15:19:19
3 bios-20190225-xt-3.34.8.10a.bin
3.34.8.10 2019-03-25 15:19:19

```

```

Past Firmware Upgrade(s)
Name
Version    Result
-----
onie-firmware-x86_64-dellemc_mxseries-r0.3.35.5.1-15.bin
3.35.5.1    Success
onie-updater-x86_64-dellemc_mxseries-r0
3.35.1.1    Success

```

```
OS10# show image firmware
```

```
Pending Firmware Upgrade(s)
```

```
=====
```

```

#      Name
Version      Date
-----
-----

```

```
Past Firmware Upgrade(s)
```

```
=====
```

```

Name
Version      Result
-----
onie-firmware-x86_64-dellemc_s5200_c3538-r0.3.40.5.1-6.
3.40.5.1-6    Success
onie-updater
3.40.1.1-5    Fail
onie-updater-x86_64-dellemc_s5200_c3538-r0.3.40.1.1-6
3.40.1.1-6    Fail

```

Supported Releases

10.5.0 or later

show image status

Displays image transfer and installation information.

Syntax show image status

Parameters None

Default Not configured

Command Mode EXEC

Usage Information On older versions of OS10, the image install command may appear frozen and does not display the current image status. Duplicate the SSH or Telnet session and re-enter the show image status command to view the current status.

Example

```

OS10# show image status
Image Upgrade State:    install
=====
File Transfer State:    idle
-----
State Detail:           Completed: No error
Task Start:             2019-01-03T17:37:49Z
Task End:               2019-01-03T17:38:04Z
Transfer Progress:      100 %
Transfer Bytes:         489894821 bytes
File Size:              489894821 bytes
Transfer Rate:          31657 kbps

```

```

Installation State:      install
-----
State Detail:          In progress: Installing
Task Start:            2019-01-03T17:38:04Z
Task End:              0000-00-00T00:00:00Z

```

Supported Releases 10.2.0E or later

show version

Displays software version information.

Syntax show version

Parameters None

Default Not configured

Command Mode EXEC

Usage Information None

Example

```

OS10# show version
Network Operating System
OS Version: 10.5.1.0
Build Version: 10.5.1.0.123
Build Time: 2020-02-12T02:34:02+0000
System Type: Z9100-ON
Architecture: x86_64
Up Time: 04:40:37

```

Supported Releases 10.2.0E or later

Check OS10 license

To check the status of the pre-installed OS10 license, use the `show license status` command. A factory-installed OS10 image runs with a perpetual license.

If you pre-order a Dell EMC switch with OS10, you do not need to install a license. If you download OS10 on a trial basis, OS10 comes with a 120-day trial license. Purchase and install a perpetual license after the trial period expires. Once the trial period expires, the switch generates an error log on the console once every hour as follows:

```

<165>1 2019-07-22T21:39:53.497121+00:00 OS10 dn_alm 648 - - Node.1-Unit.1:PRI [event],
Dell EMC (OS10) %LADF_LIC_EVAL_PRD_NOTICE: Evaluation license time limit notice.
Evaluation license expired. Please install a valid perpetual license.

```

For more information, see the Setup Guide that is shipped with your device.

Check license status

```

OS10# show license status

System Information
-----
Vendor Name       : DELL EMC
Product Name     : S4148F-ON
Hardware Version  : X01
Platform Name    : x86_64-dell_s4100_c2338-r0
PPID             : TW09H9MN282987130026
Service Tag      : 9531XC2
Product Base     :
Product Serial Number:

```



```
Product Part Number :
License Details
-----
Software      :      OS10-Enterprise
Version       :      10.5.1.0
License Type  :      PERPETUAL
License Duration:      Unlimited
License Status :      Active
License location:      /mnt/license/9531XC2.lic
-----
```

Re-install license

OS10 Enterprise Edition runs with a perpetual license on a device with OS10 factory-loaded. The license file is pre-installed on the switch. If the license becomes corrupted or is deleted, you must download the license from DDL under the purchaser's account and re-install the license.

1. Sign in to [DDL](#) using your account credentials.
2. Locate the hardware product name with the entitlement ID and order number.
3. Check that the device service tag displays in the `Assigned To` field on the `Products` page.
4. Click **Key Available for Download**.
5. Select how to receive the license key — by email or downloaded to your local device.
6. Click **Submit**.
7. Save the License.zip file and follow the instructions in [Install license](#) to install the license.

Switch without OS installed

If your Dell EMC ONIE-enabled switch does not have a default OS installed, you can download an OS10 software image from the Dell Digital Locker and install it using ONIE. Also, install OS10 on a Dell EMC ONIE device when:

- You convert a switch from OS9 or any third-party OS.
- You receive a replacement device from Dell EMC return material authorization (RMA).

An OS10 image that you download has a 120-day trial license and requires a perpetual license to run beyond the trial period. For more information, see the Setup Guide that is shipped with your device and the following FAQs:

- [Frequently asked Questions](#)
- [My Account FAQs](#)

To install an OS10 image and extend the OS10 license beyond the trial period on a Dell EMC ONIE switch with no OS installed:

1. (Optional) If a different OS is installed on the switch, such as OS9 or a third-party OS, uninstall the existing OS — [Uninstall existing OS](#).
2. [Download an OS10 image](#).
3. [Install OS10 using ONIE](#).
4. [Log in to the switch](#).
5. [Download and install an OS10 license](#).

Related ONIE documentation

For additional information about using ONIE, see:

- [ONIE User Guide](#)
- [ONIE – Manually Loading DNOS on a Switch](#)

Upgrading OS9 to OS10

When you upgrade an OS9 switch to OS10, the first step is to uninstall OS9 using the `ONIE: Uninstall OS` option on the ONIE boot menu. The Uninstall option deletes the OS9 configuration and all disk partitions. After you uninstall OS9, follow the steps for an ONIE switch without an OS installed — see [Download OS10 image](#), [Installation using ONIE](#), and [Install OS10 license](#).

RMA replacement

A replacement switch comes without an OS or license installed. If you receive a replacement switch, you must assign the service tag (STAG) of the replacement switch to the SW entitlement in DDL and install the OS10 software and license.

To download OS10 Enterprise Edition and the license, follow the steps for an ONIE switch without an OS installed; see [Download OS10 image](#), [Installation using ONIE](#), and [Install OS10 license](#).

Uninstall existing OS

CAUTION: To install OS10 on a switch running OS9 or another third-party OS, you must first uninstall the existing OS. The Uninstall option deletes the switch configuration and all disk partitions.

To uninstall OS9 or a third-party OS on a Dell EMC ONIE switch, boot up the switch and watch for the ONIE boot menu to display. Immediately use the Arrow keys to scroll the asterisk and select the ONIE: Uninstall OS option to avoid the switch booting to ONIE: Install OS by default.

```
+-----+
| ONIE: Install OS          |
| ONIE: Rescue             |
| *ONIE: Uninstall OS     |
| ONIE: Update ONIE       |
| ONIE: Embed ONIE        |
| ONIE: Diag ONIE         |
+-----+
```

After the ONIE uninstall process completes, the switch boots to ONIE: Install OS mode.

Download OS10 image

If you purchase the OS10 Enterprise Edition image with an after point-of-sale order, your OS10 purchase allows you to download software images posted within the first 90 days of ownership. After the order is complete, you receive an email notification with a software entitlement ID, order number, and link to the DDL.

To extend the software-entitled download period, you must have a Dell EMC ProSupport or ProSupport Plus contract on your hardware. Bind the software entitlement to the switch service tag to be the same time as the support contract:

i **NOTE:** MX-Series Ethernet I/O modules support OS10 in the 10.5.0.1 and later releases. The OS10 image is packaged as a Dell Upgrade Package (DUP) and can be downloaded from www.dell.com/support/. For information on how to download the DUP files to upgrade OS10 on an MX9116n and MX5108n switch, see the *Dell EMC SmartFabric OS10 Release Notes—Release 10.5.0*.

1. Sign into [DDL](#) using your account credentials.
2. Locate your entitlement ID and order number that is sent by email, and then select the product name.
3. On the **Product** page, the `Assigned To` field on the Product tab is blank. Click **Key Available for Download**.
4. Enter the device service tag you purchased the OS10 Enterprise Edition for in the `Bind to` and `Re-enter ID` fields. This step binds the software entitlement to the service tag of the switch.
5. Select how to receive the license key: by email or downloaded to your local device.
6. Click **Submit** to download the License.zip file.
7. Select the **Available Downloads** tab.
8. Select the OS10 Enterprise Edition release to download, and then click **Download**.
9. Read the Dell End User License Agreement. Scroll to the end of the agreement, and then click **Yes, I agree**.
10. Select how to download the software files, and then click **Download Now**.
11. After you download the OS10 Enterprise Edition image, unpack the .tar file and store the OS10 binary image on a local server. To unpack the .tar file, follow these guidelines:
 - Extract the OS10 binary file from the .tar file. For example, to unpack a .tar file on a Linux server or from the ONIE prompt, enter:

```
tar -xf tar_filename
```

- Generate a checksum for the downloaded OS10 binary image by running the `md5sum` command on the image file. Ensure that the generated checksum matches the checksum in the image MD5 file that is extracted from the .tar file.

```
md5sum image_filename
```

12. Follow the procedures in [Installation using ONIE](#) and [Install OS10 license](#) to install an OS10 Enterprise Edition image and license.

Restrictions on Downgrade from 10.5.1.x to 10.5.0.x or earlier version

After rollback to release 10.5.0.x or an earlier release, the following images are available in the switch:

- Image A: 10.5.0.0 (active)
- Image B: N/A

During this state, you must not use the `boot system standby` command and `reload` as the switch might get stuck in the GRUB shell.

Installation using ONIE

CAUTION: Installing OS10 or another OS using ONIE erases all software configurations on the switch. The configuration settings are not recoverable. Back up all software configurations and installed licenses on the switch before performing OS updates or changes. Store a regular backup of the switch configuration off the switch.

If you purchase an ONIE-only switch or if you want to replace an existing OS, download an OS10 image as described in [Download OS10 image](#). Then install an OS10 software image using ONIE-based auto-discovery or a manual installation:

- **Automatic installation** — ONIE discovers network information including the Dynamic Host Configuration Protocol (DHCP) server, connects to an image server, and downloads and installs an image automatically.
- **Manual installation** — Manually configure your network information if a DHCP server is not available or if you install the OS10 software image using USB media.

System setup

Before installation, verify that the system is connected correctly:

- Connect a serial cable and terminal emulator to the console serial port — serial port settings are 115200 baud rate, 8 data bits, and no parity.
- Connect the Management port to the network to download an image over a network. To locate the Console port and the Management port, see the platform-specific *Installation Guide* at www.dell.com/support.

Install OS10

For an ONIE-enabled switch, go to the ONIE boot menu. An ONIE-enabled switch boots up with pre-loaded diagnostics (DIAGs) and ONIE software.

```
+-----+
|*ONIE: Install OS          |
| ONIE: Rescue              |
| ONIE: Uninstall OS       |
| ONIE: Update ONIE        |
| ONIE: Embed ONIE         |
| ONIE: Diag ONIE          |
+-----+
```

- **Install OS** — Boots to the ONIE prompt and installs an OS10 image using the Automatic Discovery process. When ONIE installs a new OS image, the previously installed image and OS10 configuration are deleted.
- **Rescue** — Boots to the ONIE prompt and enables manual installation of an OS10 image or ONIE update.
- **Uninstall OS** — Deletes the contents of all disk partitions, including the OS10 configuration, except ONIE and diagnostics.
- **Update ONIE** — Installs a new ONIE version.
- **Embed ONIE** — Formats the disk and installs ONIE.
- **EDA DIAG** — Runs the system diagnostics.

After the ONIE process installs an OS10 image and you later reboot the switch in `ONIE: Install OS` mode (default), ONIE takes ownership of the system and remains in Install mode (ONIE Install mode is sticky) until an OS10 image successfully installs again. To boot the switch from ONIE for any reason other than installation, select the `ONIE: Rescue` or `ONIE: Update ONIE` option from the ONIE boot menu.

CAUTION: During an automatic or manual OS10 installation, if an error condition occurs that results in an unsuccessful installation and if there is an existing OS on the device, select `Uninstall OS` to clear the partitions. If the problem persists, contact Dell EMC Technical Support.

Automatic installation

You can automatically install an OS10 image on a Dell EMC ONIE-enabled device. This process is known as zero-touch install. After the device boots to ONIE: Install OS, ONIE auto-discovery follows these steps to locate the installer file and uses the first successful method:

1. Use a statically configured path that is passed from the boot loader.
2. Search file systems on locally attached devices, such as USB.
3. Search the exact URLs from a DHCPv4 server.
4. Search the inexact URLs based on the DHCP responses.
5. Search IPv6 neighbors.
6. Start a TFTP waterfall.

The ONIE automatic discovery process locates the stored software image, downloads and installs it, and reboots the device with the new image. Auto-discovery repeats until a successful software image installation occurs and reboots the switch.

ONIE discovery — Usage information

- All ONIE auto-discovery methods download and run only supported default file names, such as `onie-installer`. The required file names and search order are described on the Open Network Install Environment website at [Image Discovery and Execution](#). For more information, see the *Open Networking Hardware Diagnostic Guide* on the [Dell EMC Support site](#).
- If you use a DHCPv4 server, ONIE auto-discovery obtains the hostname, domain name, Management interface IP address, and the IP address of the domain name server (DNS) from the DHCP server and DHCP options. It also searches SCP, FTP, or TFTP servers with the default DNS of the ONIE server. DHCP options are not used to provide the server IP.
- If you use a USB storage device, ONIE searches only FAT or EXT2 file systems for an OS10 image.

Example: OS10 automatic installation

1. On the TFTP server, rename the OS10 image to a supported installer file name, such as `onie-installer`, using the `mv image-name default-filename` command.

```
mv PKGS_OS10-Base-10.3.1B.144-installer-x86_64.bin onie-installer
```

2. Boot up the switch in ONIE: Install mode to install an OS10 image.

```
Starting: discover... done.
ONIE:/ # Info: eth0: Checking link... up.
Info: Trying DHCPv4 on interface: eth0
ONIE: Using DHCPv4 addr: eth0: 10.10.10.17 / 255.0.0.0
Info: eth1: Checking link... down.
ONIE: eth1: link down. Skipping configuration.
ONIE: Failed to configure eth1 interface
ONIE: Starting ONIE Service Discovery
Info: Fetching tftp://10.10.10.2/onie-installer-x86_64-dellemc_s4148fe_c2338 ...
Info: Fetching tftp://10.10.10.2/onie-installer-dellemc_s4148fe_c2338 ...
Info: Fetching tftp://10.10.10.2/onie-installer-x86_64-bcm ...
Info: Fetching tftp://10.10.10.2/onie-installer-x86_64 ...
Info: Fetching tftp://10.10.10.2/onie-installer ...
ONIE: Executing installer: tftp://10.10.10.2/onie-installer
...
...
...
Press <DEL> or <F2> to enter setup.
Welcome to GRUB!

GNU GRUB version 2.02~beta2+e4a1fe391
OS10-B
EDA-DIAG
ONIE Booting `OS10-A'
Loading OS10 ...

[ 3.883826] kvm: already loaded the other module
[ 3.967628] dummy-irq: no IRQ given. Use irq=N
[ 3.973212] mic_init not running on X100 ret -19
[ 3.980168] esas2r: driver will not be loaded because no ATTO esas2r devices were found
[ 4.021676] mtdoops: mtd device (mtddev=name/number) must be supplied
[ 5.092316] i8042: No controller found
[ 5.108356] fmc_write_eeprom fake-design-for-testing-f001: fmc_write_eeprom: no
```

```
busid passed, refusing all cards
[ 5.120111] intel_rapl: driver does not support CPU family 6 model 77
[ 4.226593] systemd-fsck[493]: OS10-SYSROOT1: clean, 23571/426544 files,
312838/1704960 blocks
Debian GNU/Linux 8 OS10 ttyS0
Dell EMC Networking Operating System (OS10)
OS10 login:
```

Manual installation

If you do not use the ONIE-based automatic installation of an OS10 image and if a DHCP server is not available, you can manually install the image. Configure the Management port and provide the software image file to start the installation.

1. Save the OS10 software image on an SCP/TFTP/FTP server.
2. Power up the switch and select `ONIE Rescue` for manual installation.
3. Stop DHCP discovery.

```
$ onie-discovery-stop
```

4. Configure the IP addresses on the Management port, where `x.x.x.x` represents your internal IP address. After you configure the Management port, the response is `up`.

```
$ ifconfig eth0 x.x.x.x netmask 255.255.0.0 up
```

5. Install the software on the device. The installation command accesses the OS10 software from the specified SCP, TFTP, or FTP URL, creates partitions, verifies installation, and reboots itself.

```
$ onie-nos-install image_url
```

For example, enter

```
ONIE:/ # onie-nos-install ftp://a.b.c.d/PKGS_OS10-Enterprise-x.x.xx.bin
```

Where `a.b.c.d` represents the location to download the image file from, and `x.x.xx` represents the version number of the software to install.

The OS10 installer image creates several partitions. After installation completes, the switch automatically reboots and loads OS10 active image. The other image becomes the standby image.

Install manually using a USB drive

You can manually install the OS10 software image using a USB device. Verify that the USB device supports a FAT or EXT2 file system. For instructions to format a USB device in FAT or EXT2 format, see the accompanying Windows documentation for FAT formatting or Linux documentation for FAT or EXT2 formatting.

1. Plug the USB storage device into the USB storage port on the switch.
2. Power up the switch to automatically boot using the `ONIE: Rescue` option.
3. (Optional) Stop ONIE discovery if the device boots to `ONIE: Install`.

```
$ onie-discovery-stop
```

4. Create a USB mount location on the system.

```
$ mkdir /mnt/media
```

5. Identify the path to the USB drive.

```
$ fdisk -l
```

6. Mount the USB media plugged in the USB port on the device.

```
$ mount -t vfat usb-drive-path /mnt/media
```

7. Install the software from the USB, where `/mnt/media` specifies the path where the USB partition is mounted.

```
$ onie-nos-install /mnt/media/image_file
```

The ONIE auto-discovery process discovers the image file at the specified USB path, loads the software image, and reboots the switch. For more information, see the [ONIE User Guide](#).

Log in

Connect a terminal emulator to the console serial port on the switch using a serial cable. Serial port settings are 115200 baud rate, 8 data bits, and no parity.

To log in to an OS10 switch, power up and wait for the system to perform a power-on self-test (POST). Enter `admin` for both the default user name and user password.

Change the default `admin` password after the first OS10 login. The system saves the new password for future logins. After you change the password through the CLI, use the `write memory` command to save the configuration. For example:

```
OS10 login: admin
Password: admin
Last login: Sat Oct  6 00:25:33 UTC 2018 on ttyS0
Linux OS10 4.9.110 #1 SMP Debian 4.9.110-3+deb9u4 x86_64

The programs included with the Debian GNU/Linux system are free software;
the exact distribution terms for each program are described in the
individual files in /usr/share/doc/*/copyright.

Debian GNU/Linux comes with ABSOLUTELY NO WARRANTY, to the extent
permitted by applicable law.

-----
-*-----*-----*-----*-----*-----*-----*-----*-----*-----*
-*           Dell EMC  Network Operating System (OS10)           *-
-*                                                                 *-
-* Copyright (c) 1999-2018 by Dell Inc. All Rights Reserved.    *-
-*                                                                 *-
-----

This product is protected by U.S. and international copyright and
intellectual property laws. Dell EMC and the Dell EMC logo are
trademarks of Dell Inc. in the United States and/or other
jurisdictions. All other marks and names mentioned herein may be
trademarks of their respective companies.

OS10# configure terminal
% Error: ZTD is in progress(configuration is locked).
OS10# ztd cancel
OS10# configure terminal
OS10(config)# username admin password alpha404! role sysadmin
OS10(config)# exit
OS10# write memory
```

Configuration notes

All Dell EMC PowerSwitches:

When logging into a switch, it may take 6 to 10 seconds for the CLI prompt to display.

Install OS10 license

If OS10 is factory-loaded on your switch, you do not need to install an OS10 license as it is pre-loaded with a perpetual license. If you download OS10 on a trial basis, OS10 comes with a 120-day trial license. ONIE installation on a factory-loaded Dell EMC switch wipes out the license partition. Hence, the switch on reload comes up with a default 120 day trial license. Purchase and install a perpetual license after the trial period expires. To continue with uninterrupted use, purchase and install a perpetual license to avoid the OS10 device rebooting every 72 hours after 120 days.

After you install OS10 and log in, install the perpetual license to run OS10 Enterprise Edition beyond the trial period. The OS10 license is installed in the `/mnt/license` directory.

1. Download the `License.zip` file from DDL as described in [Download OS10 image](#).
2. Open the zip file and locate the license file in the Dell folder. Copy the license file to a local or remote workstation.

3. Install the license file from the workstation in EXEC mode.

```
license install {ftp: | http: | localfs: | scp: | sftp: | tftp: | usb:} filepath/
filename
```

- `ftp://userid:passwd@hostip/filepath` — Copy from a remote FTP server.
- `http://hostip/filepath` — Copy from a remote HTTP server.
- `http://hostip` — Send a request to a remote HTTP server.
- `localfs://filepath` — Install from a local file directory.
- `scp://userid:passwd@hostip/filepath` — Copy from a remote SCP server.
- `sftp://userid:passwd@hostip/filepath` — Copy from a remote SFTP server.
- `tftp://hostip/filepath` — Copy from a remote TFTP server.
- `usb://filepath` — Install from a file directory on a storage device connected to the USB storage port on the switch.
- `filepath/filename` — Enter the directory path where the license file is stored.

NOTE: When installing a license through a VRF instance, OS10 supports only some file transfer methods. Refer to the following table for the file transfer methods supported in the default, management, and non-default VRF instances.

Table 3. Install license using VRF

File transfer method	Default VRF	Management VRF ¹	Non-default VRF
FTP	Yes	Yes	No
HTTP	Yes	Yes	No
localfs	Yes	Yes	Yes
SCP	Yes	Yes	No
SFTP	Yes	Yes	No
TFTP	Yes	Yes	No
USB	Yes	Yes	Yes

¹ Before you configure the management VRF for use in OS10 license installation, remove all IP addresses on the management interface.

Install license — SCP

```
OS10# license install scp://user:userpwd@10.1.1.10/0A900Q2-NOSEnterprise-License.xml
License installation success.
```

Install license — localfs

Follow these steps to install a license from a local file directory:

1. Copy the license file from the FTP server location to the home directory on the system.

```
OS10# copy ftp://admin:admin@10.11.95.101//home/admin/LADF/0A900Q2-NOSEnterprise-
License.XML home://7B900Q2-NOSEnterprise-License.XML
```

2. (optional) Check the status of the file copy using the `show copy-file status` command.

```
OS10# show copy-file status
File Transfer State:  idle
-----
State Detail:         idle
Task Start:           2019-02-15T00:46:35Z
Task End:             2019-02-15T00:46:36Z
Transfer Progress:    100 %
Transfer Bytes:       3795 bytes
File Size:            3795 bytes
Transfer Rate:        8 kbps
```

3. Verify that the license is present in the home directory of your system.

```
OS10# dir home

Directory contents for folder: home
Date (modified) Size (bytes) Name
-----
2019-02-15T00:47:25Z 3795 0A900Q2-NOSEnterprise-License.XML
```

4. Enter the `license install` command with the path to the home directory location where the license was downloaded in step 1.

```
OS10# license install localfs://home/admin/0A900Q2-NOSEnterprise-License.XML
[ 5784.994389] EXT4-fs error (device dm-0): ext4_has_uninit_itable:3039: comm
CPS_API_instanc: Inode table for bg 0 marked as needing zeroing
License installation success.
```

Install license using management VRF

```
OS10(config)# ip vrf management
OS10(conf-vrf)# interface management
OS10(conf-vrf)# exit
OS10(config)# ip sftp vrf management
OS10(config)# exit
OS10# license install sftp://user:userpwd@10.1.1.10/0ANNX42-NOSEnterprise-License.xml

License installation success.
```

Verify license installation

```
OS10# show license status

System Information
-----
Vendor Name       : DELL EMC
Product Name      : S4148F-ON
Hardware Version  : X01
Platform Name     : x86_64-dell_s4100_c2338-r0
PPID              : TW09H9MN282987130026
Service Tag       : 9531XC2
Product Base      :
Product Serial Number:
Product Part Number :
License Details
-----
Software          : OS10-Enterprise
Version           : 10.5.1.0
License Type      : PERPETUAL
License Duration  : Unlimited
License Status    : Active
License location  : /mnt/license/9531XC2.lic
-----
```

Troubleshoot license installation failure

An error message displays if the installation fails.

```
License installation failed
```

1. Verify the installation path to the local or remote license location.
2. Check the log on the remote server to find out why the FTP or TFTP file transfer failed.
3. Ping the remote server from the switch — use the [ping](#) and [traceroute](#) commands to test network connectivity. Check the following if the ping fails:
 - If the remote server is reachable through the management route, check if the management route is configured correctly.
 - If the remote server is reachable through a front-panel port, check if the static or dynamic route is present.
 - If the ping is successful and the FTP or TFTP log on to a remote server does not register a response, check if there is a firewall in the transfer path that is blocking the transfer protocol.
4. Install the server with the license file on the same subnet as the switch.

5. Check if the server is up and running.

Downgrade to Release 10.5.0.0 or earlier releases

In this example, the OS10 switch runs the 10.5.1.0 software and the following procedure downgrades the system to Release 10.5.0.0.

NOTE:

- If the version that you are downgrading to is present in the system as the standby image, you can rollback to that release without losing any configuration or license data. Use the `show boot detail` command to view the standby image version. See [Rollback from 10.5.1.0 or later release to 10.5.0.0 or earlier release](#) for more information.
- If the image that you are downgrading to is newly installed using the `image install` command, backup of the original configuration data will not be available. The system boots with the default configuration.

 **NOTE:** While downgrading to an earlier release, OS10 removes the existing 10.5.1.0 image. This process takes about 10 minutes to 20 minutes of downtime, depending on your device.

Prerequisites

Obtain a backup of the configuration data. Ensure that you have a copy of the license files. Reapply the configuration data and licenses files after you reload the 10.5.0.0 or earlier image.

1. Back up the current running configuration to the startup configuration in EXEC mode.

```
OS10# copy running-configuration startup-configuration
```

2. Back up the startup configuration (`startup.xml`) in EXEC mode.

```
copy config://startup.xml ftp://userid:passwd@hostip/filepath/10.5.0.0-startup.xml
```

3. Download the OS10 binary image for Release 10.5.0.0, also called the standby image, from a local server using the `image download server-filepath/filename` command in EXEC mode; for example:

```
OS10# image download sftp://admin:passwd@10.1.1.1/home/admin/images/OS10EE.bin
```

4. (Optional) View the current software download status in EXEC mode.

```
OS10# show image status
```

5. Install the OS10 standby image using the `image install file-url` command in EXEC mode, where `filename` is the name of the image file downloaded in Step 3 with the `image download` command; for example:

```
OS10# image install image://OS10EE.bin
```

6. (Optional) View the status of the software installation in EXEC mode.

```
OS10# show image status
Image Upgrade State:      idle
=====
File Transfer State:      transfer-success
-----
State Detail:              Completed: No error
Task Start:                2019-11-19T06:55:44Z
Task End:                  2019-11-19T06:55:53Z
Transfer Progress:         100 %
Transfer Bytes:            469343880 bytes
File Size:                 469343880 bytes
Transfer Rate:             67812 kbps

Installation State:        install-failed
-----
State Detail:              Failed: Downgrade image staged for clean
                           install. Reload to downgrade.
Task Start:                2019-11-19T06:55:53Z
Task End:                  2019-11-19T06:56:01Z
```

NOTE:

- During this stage, the `show boot detail` command displays the details of the previous image that was installed. The `boot system active | standby` command is not applicable during this state.
- If you install a new image using the `image install` command, the current staging image is replaced with the new image that you have installed and you cannot downgrade to the previous version.

7. Reload the new software image in EXEC mode. This command performs a fresh installation of Release 10.5.0.0. Release 10.5.0.0 is installed as both the active and standby images.

```
OS10# reload
```

8. Use the `show version` command in EXEC mode to verify that the downloaded OS10 image is installed as the current running version.

```
OS10# show version
Dell EMC Networking OS10 Enterprise
Copyright (c) 1999-2019 by Dell Inc. All Rights Reserved.
OS Version: 10.5.0.0
Build Version: 10.5.0.270
Build Time: 2019-07-29T23:35:01+0000
System Type: S4148F-ON
Architecture: x86_64
Up Time: 1 day 00:54:13
```

9. Apply the saved configuration and license files, and reload the switch.

```
OS10# copy ftp://userid:passwd@hostip/filepath/10.5.0.0-startup.xml config://
startup.xml
```

```
OS10# license install scp://user:passwd@hostip/0A900Q2-NOSEnterprise-License.xml
```

```
OS10# reload
```

- NOTE:** While reloading, if the CLI prompts to save, select `no` for the save option. Selecting `yes` overrides the configuration that was saved earlier.

Roll back from 10.5.1.0 or later release to 10.5.0.0 or earlier release

Use the rollback script that is bundled with your OS10 software image to move to an earlier release. Using the rollback script retains the earlier configuration and license information. You can use the rollback option only when the previous image is available in the system as the standby image. Use the `show boot detail` command to view the version of the standby image.

- NOTE:** The rollback script reboots the OS10 switch immediately.

To roll back, from the Linux shell prompt, enter:

```
OS10# system bash
bash (OS10) $ sudo os10-rollback-to-old-image
```

- NOTE:** After rollback is complete, the system comes up with the previous release. However, the standby image becomes nonbootable. To boot using the standby image, you have to install the image again using the `image install` command.

Switch deployment options

After you log in to OS10, configure the switch:

- Manually by using the command-line interface.
- Automatically using zero-touch deployment (ZTD).
- Automatically using customized scripts with Ansible.

Manual CLI configuration

Use the OS10 command-line interface to enter commands to monitor and configure an OS10 switch. Set up your switch by performing basic and advanced CLI tasks — [CLI basics](#) and [Advanced CLI tasks](#). Then proceed with other configuration settings according to how you deploy the switch in your network. For detailed configuration and CLI information, refer to the appropriate chapter.

ZTD-automated switch deployment

Automate OS10 switch deployment using zero-touch deployment, including:

- Upgrade an existing OS10 image.
- Execute a CLI batch file to configure the switch.
- Execute a post-ZTD script to perform additional functions.

See [Zero-touch deployment](#).

Ansible-automated switch provisioning

Automate OS10 switch configuration using Ansible, a third-party DevOps tool. Create and execute Ansible playbooks to configure multiple devices. For more information, see [Using Ansible](#).

Feature limitation on the Z9100-ON and S5200-ON series switches

On the Z9100-ON and S5200-ON series switches, system flow is enabled by default. You can also enable iSCSI and any three of the following features simultaneously:

- IPv4 user ACL
- IPv4 PBR ACL
- IPv4 QoS
- IPv6 user ACL
- IPv6 PBR
- IPv6 QoS
- L2 user ACL
- Dynamic ARP Inspection
- FCoE
- FIP snooping

Feature limitations on Z9332F-ON switch

The Z9332F-ON switch does not support the following:

- VXLAN
- UFT Mode
- Resilient hashing for port channels
- Storm control
- Port monitoring and remote port monitoring session with destination over port channel interface
- Location LED

Remote access

After you install or upgrade OS10 and log in, you can set up remote access to the OS10 command-line interface and the Linux shell. Connect to the switch using the serial port. Serial port settings are 115200 baud, 8 data bits, and no parity.

Configure remote access

1. Configure the Management IP address.
2. Configure Management route.
3. Configure user name and password.

Configure Management IP address

To remotely access OS10, assign an IP address to the management port. Use the management interface for out-of-band (OOB) switch management.

1. Configure the management interface from CONFIGURATION mode.

```
interface mgmt 1/1/1
```

2. By default, DHCP client is enabled on the Management interface. Disable the DHCP client operations in INTERFACE mode.

```
no ip address dhcp
```

3. Configure an IPv4 or IPv6 address on the Management interface in INTERFACE mode.

```
ip address A.B.C.D/mask
```

```
ipv6 address A:B/prefix-length
```

4. Enable the Management interface in INTERFACE mode.

```
no shutdown
```

Configure Management interface

```
OS10(config)# interface mgmt 1/1/1
OS10(conf-if-ma-1/1/1)# no ip address dhcp
OS10(conf-if-ma-1/1/1)# ip address 10.1.1.10/24
OS10(conf-if-ma-1/1/1)# no shutdown
```

Configure Management route

To set up remote access to OS10, configure a management route after you assign an IPv4 or IPv6 address to the Management port. The Management port uses the default management route to communicate with a different network. The management route allows you to separate Management traffic from data traffic.

1. (Optional) Ensure that the DHCP client is disabled on the Management interface in INTERFACE mode.

```
no ip address dhcp
```

2. Configure a management route for the Management port in CONFIGURATION mode. Repeat the command to configure multiple routes.

```
management route {ipv4-address/mask | ipv6-address/prefix-length}
{forwarding-router-address | managementethernet}
```

- *ipv4-address/mask* — Enter an IPv4 network address in dotted-decimal format (A.B.C.D), then a subnet mask in /prefix-length format (/x).
- *ipv6-address/prefix-length* — Enter an IPv6 address in x:x:x:x format with the prefix length in /x format. The prefix range is /0 to /128.
- *forwarding-router-address* — Enter the next-hop IPv4/IPv6 address of a forwarding router that serves as a management gateway to connect to a different subnet.
- *managementethernet* — Send traffic on the Management port for the configured IPv4/IPv6 subnet.

NOTE: Management routes are separate from IPv4 and IPv6 routes and are only used to manage the switch through the Management port.

NOTE: Do not configure the same prefix in both the static route and management route. If the same prefix has to be used, use management VRF.

NOTE: Management VRF is currently not supported on the MX7000 platforms.

Configure management route

```
OS10(config)# management route 10.10.20.0/24 10.1.1.1
OS10(config)# management route 172.16.0.0/16 managementethernet
```

Configure username and password

To set up remote access to OS10, create a username and password after you configure the management port and default route. The user role is a mandatory entry.

Enter the password in clear text. It is converted to SHA-512 format in the running configuration. A password must have at least nine characters, including alphanumeric and special characters, and at least five different characters from the password that is previously used for the same username. For example:

```
OS10(config)# username admin password alpha404! role sysadmin
```

For backward compatibility with OS10 release 10.3.1E and earlier, passwords entered in MD-5, SHA-256, and SHA-512 format are supported. To increase the required password strength, use the `password-attributes` command.

- Create a username and password in CONFIGURATION mode.

```
username username password password role role
```

- `username username` — Enter a text string. A maximum of 32 alphanumeric characters; one character minimum.
- `password password` — Enter a text string. A maximum of 32 alphanumeric characters; nine characters minimum.
- `role role` — Enter a user role:
 - `sysadmin` — Full access to all commands in the system, exclusive access to commands that manipulate the file system, and access to the system shell. A system administrator can create user IDs and user roles. The default privilege level is 15.
 - `secadmin` — Full access to configuration commands that set security policy and system access, such as password strength, AAA authorization, and cryptographic keys. A security administrator can display security information, such as cryptographic keys, login statistics, and log information. The default privilege level is 15.
 - `netadmin` — Full access to configuration commands that manage traffic flow through the switch, such as routes, interfaces, and ACLs. A network administrator cannot access configuration commands for security features or view security information. The default privilege level is 15.
 - `netoperator` — Access to EXEC mode to view the current configuration with limited access. A network operator cannot modify any configuration setting on a switch. The default privilege level is 1.

NOTE: To change a system administrator password, re-enter the command for the administrator username with a new password.

```
OS10(config)# username admin password beta@1 role sysadmin
```

CLI Basics

The OS10 CLI is the software interface you use to access a device running the software — from the console or through a network connection. The CLI is an OS10-specific command shell that runs on top of a Linux-based OS kernel. By leveraging industry-standard tools and utilities, the CLI provides a powerful set of commands that you can use to monitor and configure devices running OS10.

User accounts

OS10 defines two categories of user accounts:

- To log in to the CLI, use `admin` for the user name and password.
- To log in to the Linux shell, use `linuxadmin` for the user name and password.

i **NOTE:** You cannot delete the default `linuxadmin` user name. You can delete the default `admin` user name only if at least one OS10 user with the `sysadmin` role is configured.

For example, to access the OS10 CLI using an SSH connection:

1. Open an SSH session using the IP address of the device. You can also use PuTTY or a similar tool to access the device remotely.

```
ssh admin@ip-address
password: admin
```

2. Enter `admin` for both the default user name and password to log into OS10. You are automatically placed in EXEC mode.

```
OS10#
```

For example, to access the Linux shell using an SSH connection, enter `linuxadmin` as the user name and password:

- ```
ssh linuxadmin@management-ip-address
password: linuxadmin
```

## Key CLI features

|                                 |                                                                                                                                                                                                                                                                                                                                                                                                                                                                                                                                                                 |
|---------------------------------|-----------------------------------------------------------------------------------------------------------------------------------------------------------------------------------------------------------------------------------------------------------------------------------------------------------------------------------------------------------------------------------------------------------------------------------------------------------------------------------------------------------------------------------------------------------------|
| <b>Consistent command names</b> | Commands that provide the same type of function have the same name, regardless of the portion of the system on which they are operating. For example, all <code>show</code> commands display software information and statistics, and all <code>clear</code> commands erase various types of system information.                                                                                                                                                                                                                                                |
| <b>Available commands</b>       | Information about available commands is provided at each level of the CLI command hierarchy. You can enter a question mark (?) at any level and view a list of the available commands, along with a short description of each command.                                                                                                                                                                                                                                                                                                                          |
| <b>Command completion</b>       | Command completion for command names (keywords) and for command options is available at each level of the hierarchy. To complete a command or option that you have partially entered, click the <b>Tab</b> key or the <b>Spacebar</b> . If the partially entered letters are a string that uniquely identifies a command, the complete command name appears. A beep indicates that you have entered an ambiguous command, and the possible completions display. Completion also applies to other strings, such as interface names and configuration statements. |

## CLI command modes

The OS10 CLI has two top-level modes:

- EXEC mode — Monitor, troubleshoot, check status, and network connectivity.
- CONFIGURATION mode — Configure network devices.

When you enter CONFIGURATION mode, you are changing the current operating configuration, called the *running configuration*. By default, all configuration changes are automatically saved to the running configuration.

You can change this default behavior by switching to Transaction-Based Configuration mode. To switch to Transaction-Based Configuration mode, use the `start transaction` command. When you switch to the Transaction-Based Configuration mode and update the candidate configuration, changes to the candidate configuration are not added to the running configuration until

you commit them to activate the configuration. The `start transaction` command applies only to the current session. Changing the configuration mode of the current session to the Transaction-Based Configuration mode does not affect the configuration mode of other CLI sessions.

- After you explicitly enter the `commit` command to save changes to the candidate configuration, the session switches back to the default behavior of automatically saving the configuration changes to the running configuration.
- When a session terminates while in the Transaction-Based Configuration mode, and you have not entered the `commit` command, the changes are maintained in the candidate configuration. You can start a new Transaction-Based Configuration mode session and continue with the remaining configuration changes.
- All sessions in Transaction-Based Configuration mode update the same candidate configuration. When you use the `commit` command on any session in Transaction-Based Configuration mode or you make configuration changes on any session in Non-Transaction-Based mode, you also commit the changes made to the candidate configuration in all other sessions running in the transaction-based configuration mode. This implies that inconsistent configuration changes may be applied to the running configuration. Dell EMC recommends only making configuration changes on a single CLI session at a time.
- When you enter the `lock` command in a CLI session, configuration changes are disabled on all other sessions, whether they are in Transaction-Based Configuration mode or Non-Transaction-Based Configuration mode. For more information, see [Candidate configuration](#).

### CLI command hierarchy

CLI commands are organized in a hierarchy. Commands that perform a similar function are grouped together under the same level of hierarchy. For example, all commands that display information about the system and the system software are grouped under the `show system` command, and all commands that display information about the routing table are grouped under the `show ip route` command.

To move directly to EXEC mode from any sub-mode, enter the `end` command. To move up one command mode, enter the `exit` command.

## CONFIGURATION mode

When you initially log in to OS10, you are placed in EXEC mode. To access CONFIGURATION mode, enter the `configure terminal` command. Use CONFIGURATION mode to manage interfaces, protocols, and features.

```
OS10# configure terminal
OS10(config)#
```

Interface mode is a sub-mode of CONFIGURATION mode. In Interface mode, you configure Layer 2 (L2) and Layer 3 (L3) protocols, and IPv4 and IPv6 services on an interface:

- Physical interfaces include the Management interface and Ethernet ports.
- Logical interfaces include Loopback, port-channel, and virtual local area networks (VLANs).

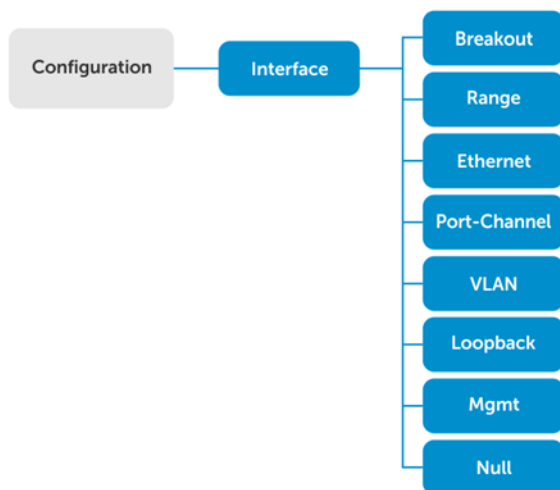

From CONFIGURATION mode, you can also configure L2 and L3 protocols with a specific protocol-configuration mode, such as Spanning-Tree Protocol (STP) or Border Gateway Protocol (BGP).

# Check device status

Use show commands to check the status of a device and monitor activities. Refer [Related Videos](#) section for more information.

- Enter `show ?` from EXEC mode to view a list of commands to monitor a device; for example:

```
OS10# show ?
acl-table-usage Show ACL table utilization
alarms Display all current alarm situation in the system
alias Show list of aliases
bfd Show bfd session commands
boot Show boot information
candidate-configuration Current candidate configuration
class-map Show QoS class-map configuration
clock Show the system date and time
...
users Show the current list of users logged into the system
 and show the session id
version Show the software version on the system
virtual-network Virtual-network info
vlan Vlan status and configuration
vlt Show VLT domain info
vrrp VRRP group status
ztd-status Show ztd status
```

- Enter `show command-history` from EXEC mode to view trace messages for each executed command.

```
OS10# show command-history
 1 Thu Apr 20 19:44:38 UTC 2017 show vlan
 2 Thu Apr 20 19:47:01 UTC 2017 admin
 3 Thu Apr 20 19:47:01 UTC 2017 monitor hardware-components controllers view 0
 4 Thu Apr 20 19:47:03 UTC 2017 system general info system-version view
 5 Thu Apr 20 19:47:16 UTC 2017 admin
 6 Thu Apr 20 19:47:16 UTC 2017 terminal length 0
 7 Thu Apr 20 19:47:18 UTC 2017 terminal datadump
 8 Thu Apr 20 19:47:20 UTC 2017 %abc
 9 Thu Apr 20 19:47:22 UTC 2017 switchshow
10 Thu Apr 20 19:47:24 UTC 2017 cmsh
```

- Enter `show system` from EXEC mode to view the system status information; for example:

```
OS10# show system

Node Id : 1
MAC : 14:18:77:15:c3:e8
Number of MACs : 256
Up Time : 1 day 00:48:58

-- Unit 1 --
Status : up
System Identifier : 1
Down Reason : unknown
Digital Optical Monitoring : disable
System Location LED : off
Required Type : S4148F
Current Type : S4148F
Hardware Revision : X01
Software Version : 10.5.1.0
Physical Ports : 48x10GbE, 2x40GbE, 4x100GbE
BIOS : 3.33.0.0-3
System CPLD : 0.4
Master CPLD : 0.10
Slave CPLD : 0.7

-- Power Supplies --
PSU-ID Status Type AirFlow Fan Speed(rpm) Status

1 up AC NORMAL 1 13312 up
2 fail
```



```
-- Fan Status --
FanTray Status AirFlow Fan Speed(rpm) Status

1 up NORMAL 1 13195 up
2 up NORMAL 1 13151 up
3 up NORMAL 1 13239 up
4 up NORMAL 1 13239 up
```

## Related Videos

[Check Device Status](#)

## Command help

To view a list of valid commands in any CLI mode, enter ?; for example:

```
OS10# ?
alarm Alarm commands
alias Set alias for a command
batch Batch Mode
boot Tell the system where to access the software image at bootup
clear Clear command
clock Configure the system clock
commit Commit candidate configuration
configure Enter configuration mode
copy Perform a file copy operation
crypto Cryptography commands
...
ping ping -h shows help
ping6 ping6 -h shows help
reload Reboot Networking Operating System
show Show running system information
start Activate transaction based configuration
support-assist-activity Support Assist related activity
system System command
terminal Set terminal settings
traceroute traceroute --help shows help
unlock Unlock candidate configuration
validate Validate candidate configuration
write Copy from current system configuration
ztd Cancel the current ZTD process.
```

```
OS10(config)# ?
aaa Configure AAA
alias Set alias for a command
banner Configure banners
bfd Enable bfd globally
class-map Configure class map
clock Configure clock parameters
control-plane Control-plane configuration
crypto Crypto commands
dcbx DCBX commands
default Configure default attributes
dot1x Configure dot1x global information
...
uplink-state-group Create uplink state group
username Create or modify users
userrole Create custom user role
virtual-network Create a Virtual Network
vlt-domain VLT domain configurations
vrrp Configure VRRP global attributes
wred Configure WRED profile
```

# Candidate configuration

When you use OS10 configuration commands in Transaction-based configuration mode, changes do not take effect immediately and are stored in the candidate configuration. The configuration changes become active only after you commit the changes using the `commit` command. Changes in the candidate configuration are validated and applied to the running configuration.

The candidate configuration allows you to avoid introducing errors during an OS10 configuration session. You can make changes and then check them before committing them to the active, running configuration on the switch.

To check differences between the running configuration and the candidate configuration, use the `show diff candidate-configuration running-configuration` command.

For example, before entering Transaction mode, you can check that no new configuration commands are entered. If the `show` command does not return output, the `candidate-configuration` and `running-configuration` files are the same. Then start Transaction mode, configure new settings, and view the differences between the candidate and running configurations. Decide if you want to commit the changes to the running configuration. To delete uncommitted changes, use the `discard` command.

## View differences between candidate and running configurations

```
OS10# show diff candidate-configuration running-configuration
OS10#
OS10# start transaction
OS10# configure terminal
OS10(config)# interface vlan 100
OS10(config-if-vl-100)# exit
OS10(config)# interface ethernet 1/1/15
OS10(config-if-eth1/1/15)# switchport mode trunk
OS10(config-if-eth1/1/15)# switchport trunk allowed vlan 100
OS10(config-if-eth1/1/15)# end

OS10# show diff candidate-configuration running-configuration
!
interface ethernet1/1/15
switchport mode trunk
switchport trunk allowed vlan 100
!
interface vlan100
no shutdown
OS10#
```

## Commit configuration changes in candidate configuration in Transaction mode

1. Change to Transaction-based configuration mode from EXEC mode.

```
start transaction
```

2. Enter configuration commands. For example, enable an interface from INTERFACE mode.

```
interface ethernet 1/1/1
no shutdown
```

3. Save the configuration changes to the running configuration.

```
do commit
```

After you enter the `commit` command, the current OS10 session switches back to the default behavior of committing all configuration changes automatically.

```
OS10# start transaction
OS10# configure terminal
OS10(config)#
OS10(config)# interface ethernet 1/1/1
OS10(config-if-eth1/1/1)# no shutdown
OS10(config-if-eth1/1/1)# do commit
```

## Compressed configuration views

To display only interface-related configurations in the candidate configuration, use the `show candidate-configuration compressed` and `show running-configuration compressed` commands. These views display only the configuration commands for VLAN and physical interfaces.

```
OS10# show candidate-configuration compressed
interface breakout 1/1/1 map 40g-1x
interface breakout 1/1/2 map 40g-1x
interface breakout 1/1/3 map 40g-1x
interface breakout 1/1/4 map 40g-1x
...
interface breakout 1/1/30 map 40g-1x
interface breakout 1/1/31 map 40g-1x
interface breakout 1/1/32 map 40g-1x
ipv6 forwarding enable
username admin password 6q9QBeYjZ$jfxzVqGhkxX3smxJSH9DDz7/30Jc6m5wjF8nnLD7/
VKx8SloIhp4NoGZs0I/UNwh8WVuxwfd9q4pWIgNs5BKH. role sysadmin
aaa authentication local
snmp-server contact http://www.dell.com/support
!
interface range ethernet 1/1/1-1/1/32
 switchport access vlan 1
 no shutdown
!
interface vlan 1
 no shutdown
!
interface mgmt1/1/1
 ip address dhcp
 no shutdown
 ipv6 enable
 ipv6 address autoconfig
!
support-assist
!
policy-map type application policy-iscsi
!
class-map type application class-iscsi
```

```
OS10# show running-configuration compressed
interface breakout 1/1/1 map 40g-1x
interface breakout 1/1/2 map 40g-1x
interface breakout 1/1/3 map 40g-1x
interface breakout 1/1/4 map 40g-1x
...
interface breakout 1/1/30 map 40g-1x
interface breakout 1/1/31 map 40g-1x
interface breakout 1/1/32 map 40g-1x
ipv6 forwarding enable
username admin password 6q9QBeYjZ$jfxzVqGhkxX3smxJSH9DDz7/30Jc6m5wjF8nnLD7/
VKx8SloIhp4NoGZs0I/UNwh8WVuxwfd9q4pWIgNs5BKH. role sysadmin
aaa authentication local
snmp-server contact http://www.dell.com/support
!
interface range ethernet 1/1/1-1/1/32
 switchport access vlan 1
 no shutdown
!
interface vlan 1
 no shutdown
!
interface mgmt1/1/1
 ip address dhcp
 no shutdown
 ipv6 enable
 ipv6 address autoconfig
!
support-assist
!
policy-map type application policy-iscsi
!
class-map type application class-iscsi
```

## Prevent configuration changes

You can prevent configuration changes that are made on the switch in sessions other than the current CLI session using the `lock` command. To prevent and allow configuration changes in other sessions, use the `lock` and `unlock` commands in EXEC mode.

When you enter the `lock` command, users in other active CLI sessions cannot make configuration changes. When you close the CLI session in which you entered the `lock` command, configuration changes are automatically allowed in all other sessions.

```
OS10# lock
```

```
OS10# unlock
```

## Conflicting interface ranges

After you apply one or more VLANs to an interface using the `switchport trunk allowed vlan` command, and try to delete some of the VLANs from the candidate configuration, the system displays an error message. For example, the following is a configuration without conflicts:

```
OS10# start transaction
OS10# configure terminal
OS10(config)# interface range vlan 2-3
OS10(config-range-vl-2-3)# exit
OS10(config)# interface range vlan 40-45
OS10(config-range-vl-40-45)# exit
OS10(config)#
OS10(config)# interface range port-channel 2-3
OS10(config-range-po-2-3)# switchport mode trunk
OS10(config-range-po-2-3)# switchport trunk allowed vlan 2-3
OS10(config-range-po-2-3)# switchport trunk allowed vlan 40-45
OS10(config-range-po-2-3)# exit
OS10(config)# no interface range vlan 20-30
OS10(config)# do commit
```

The system already contains the following configuration:

```
OS10(config)# do show running-configuration interface port-channel
!
interface port-channel3
no shutdown
switchport mode trunk
switchport access vlan 1
switchport trunk allowed vlan 2-3,40-45
OS10(config)#
OS10(config)# do show running-configuration interface vlan
!
interface vlan1
no shutdown
!
interface vlan2
no shutdown
!
interface vlan3
no shutdown
!
interface vlan4
no shutdown
!
interface vlan5
no shutdown
```

The following depicts a conflicting configuration wherein a few VLANs are created and applied to an interface and then a subset of VLANs are removed from the candidate configuration:

```
OS10(config)# do start transaction
OS10(config)# interface range port-channel 3
```

```
OS10(conf-range-po-3)# switchport trunk allowed vlan 2-5
OS10(conf-range-po-3)# exit
OS10(config)# no interface range vlan 2-4
OS10(conf-range-po-3)# % Error: Range configuration conflict - the last command was not applied. Please
commit (or discard) the rest of the configuration changes and retry.
```

If you see the error message in bold, commit the entire configuration and then delete a sub set of VLANs.

```
OS10(conf-range-po-3)#do commit
OS10(conf-range-po-3)# do show running-configuration interface port-channel
!
interface port-channel3
no shutdown
switchport mode trunk
switchport access vlan 1
switchport trunk allowed vlan 2-5
OS10(conf-range-po-3)# do show running-configuration interface vlan
!
interface vlan1
no shutdown
!
interface vlan2
no shutdown
!
interface vlan3
no shutdown
!
interface vlan4
no shutdown
!
interface vlan5
no shutdown
OS10(conf-range-po-3)# no interface range vlan 2-4
OS10(config)# do show running-configuration interface vlan
!
interface vlan1
no shutdown
!
interface vlan5
no shutdown
OS10(config)# do show running-configuration interface port-channel
!
interface port-channel3
no shutdown
switchport mode trunk
switchport access vlan 1
switchport trunk allowed vlan 5
```

Sometimes, partial removal of VLANs may fail and display the following error message:

```
% Error: The command failure resulted in disintegrated candidate configuration. Please
discard the current candidate configuration changes.
```

If you see this error message, discard the entire configuration using the `discard` command.

## Copy running configuration

The running configuration contains the current OS10 system configuration and consists of a series of OS10 commands. Copy the running configuration to a remote server or local directory as a backup or for viewing and editing. The running configuration is copied as a text file that you can view and edit with a text editor.

## Copy running configuration to local directory or remote server

```
OS10# copy running-configuration {config://filepath | home://filepath |
ftp://userid:passwd@hostip/filepath | scp://userid:passwd@hostip/filepath |
sftp://userid:passwd@hostip/filepath | tftp://hostip/filepath}
```

```
OS10# copy running-configuration scp://root:calvin@10.11.63.120/tmp/qaz.txt
```

## Copy file to running configuration

To apply a set of commands to the current running configuration and execute them immediately, copy a text file from a remote server or local directory. The copied commands do not replace the existing commands. If the `copy` command fails, any commands that were successfully copied before the failure occurred are maintained.

```
OS10# copy {config://filepath | home://filepath |
ftp://userid:passwd@hostip/filepath | scp://userid:passwd@hostip/filepath |
sftp://userid:passwd@hostip/filepath | tftp://hostip/filepath | http://userid@hostip/
filepath}
running-configuration
```

```
OS10# copy scp://root:calvin@10.11.63.120/tmp/qaz.txt running-configuration
```

## Copy running configuration to startup configuration

To display the configured settings in the current OS10 session, use the `show running-configuration`. To save new configuration settings across system reboots, copy the running configuration to the startup configuration file.

```
OS10# copy running-configuration startup-configuration
```

# Restore startup configuration

The startup configuration file, `startup.xml`, is stored in the `config` system folder. To create a backup version, copy the startup configuration to a remote server or the local `config:` or `home:` directories.

To restore a backup configuration, copy a local or remote file to the startup configuration and reload the switch. After downloading a backup configuration, enter the `reload` command, otherwise the configuration does not take effect until you reboot.

**NOTE:** A non-default switch-port profile is not automatically restored. If the downloaded startup configuration you want to restore contains a non-default switch-port profile, you must manually configure and save the profile on the switch, and then reload the switch for the profile settings to take effect. If the backup startup file contains the default switch-port profile, you can simply copy the startup configuration file from the server and reload the switch.

## Copy file to startup configuration

```
OS10# copy {config://filepath | home://filepath |
ftp://userid:passwd@hostip/filepath | scp://userid:passwd@hostip/filepath |
sftp://userid:passwd@hostip/filepath | tftp://hostip/filepath} config://startup.xml
```

## Back up startup file

```
OS10# copy config://startup.xml config://backup-9-28.xml
```

## Restore startup file from backup

```
OS10# copy config://backup-9-28.xml config://startup.xml
OS10# reload
System configuration has been modified. Save? [yes/no]:no
```

## Back up startup file to server

```
OS10# copy config://startup.xml scp://userid:password@hostip/backup-9-28.xml
```

## Restore startup file from server

```
OS10# copy scp://admin:admin@hostip/backup-9-28.xml config://startup.xml
OS10# reload
System configuration has been modified. Save? [yes/no]:no
```

## Reload system image

Reboot the system manually using the `reload` command in EXEC mode. You are prompted to confirm the operation.

```
OS10# reload
System configuration has been modified. Save? [yes/no]:yes
Saving system configuration
Proceed to reboot the system? [confirm yes/no]:yes
```

To configure the OS10 image loaded at the next system boot, enter the `boot system` command in EXEC mode.

```
boot system {active | standby}
```

- Enter `active` to load the active OS10 image.
- Enter `standby` to load the standby OS10 image.

### Set next boot image

```
OS10# boot system standby
OS10# show boot
Current system image information:
=====
Type Boot Type Active Standby Next-Boot

Node-id 1 Flash Boot [A] 10.2.9999E [B] 10.2.9999E [B] standby
```

## Filter show commands

You can filter `show` command output to view specific information, or start the command output at the first instance of a regular expression or phrase.

- `display-xml` — Displays output in XML format.
- `except` — Displays only text that does not match a pattern.
- `find` — Searches for the first occurrence of a pattern and displays all further configurations.
- `grep` — Displays only the text that matches a specified pattern. Special characters in regular expressions, such as `^` (matches the beginning of a text string), `$` (matches the end of a string), and `.` (matches any character in the string) are supported.
- `no-more` — Does not paginate output.
- `save` — Saves the output to a file.

### Display all output

```
OS10# show running-configuration | no-more
```

# Common OS10 commands

## boot

Configures the OS10 image to use the next time the system boots up.

|                           |                                                                                                                                                                                                             |
|---------------------------|-------------------------------------------------------------------------------------------------------------------------------------------------------------------------------------------------------------|
| <b>Syntax</b>             | <code>boot system [active   standby]</code>                                                                                                                                                                 |
| <b>Parameters</b>         | <ul style="list-style-type: none"><li>• <code>active</code> — Reset the running image as the next boot image.</li><li>• <code>standby</code> — Set the standby image as the next boot image.</li></ul>      |
| <b>Default</b>            | Not configured                                                                                                                                                                                              |
| <b>Command Mode</b>       | EXEC                                                                                                                                                                                                        |
| <b>Usage Information</b>  | Use this command to configure the OS10 image that is reloaded at boot time. Use the <code>show boot</code> command to verify the next boot image. The <code>boot system</code> command applies immediately. |
| <b>Example</b>            | <pre>OS10# boot system standby</pre>                                                                                                                                                                        |
| <b>Supported Releases</b> | 10.2.0E or later                                                                                                                                                                                            |

## commit

Commits changes in the candidate configuration to the running configuration.

|                                |                                                                                                                                              |
|--------------------------------|----------------------------------------------------------------------------------------------------------------------------------------------|
| <b>Syntax</b>                  | <code>commit</code>                                                                                                                          |
| <b>Parameters</b>              | None                                                                                                                                         |
| <b>Default</b>                 | Not configured                                                                                                                               |
| <b>Command Mode</b>            | EXEC                                                                                                                                         |
| <b>Usage Information</b>       | Use this command to save changes to the running configuration. Use the <code>do commit</code> command to save changes in CONFIGURATION mode. |
| <b>Example</b>                 | <pre>OS10# commit</pre>                                                                                                                      |
| <b>Example (configuration)</b> | <pre>OS10(config)# do commit</pre>                                                                                                           |
| <b>Supported Releases</b>      | 10.2.0E or later                                                                                                                             |

## configure

Enters CONFIGURATION mode from EXEC mode.

|                          |                                                                   |
|--------------------------|-------------------------------------------------------------------|
| <b>Syntax</b>            | <code>configure {terminal}</code>                                 |
| <b>Parameters</b>        | <code>terminal</code> — Enters CONFIGURATION mode from EXEC mode. |
| <b>Default</b>           | Not configured                                                    |
| <b>Command Mode</b>      | EXEC                                                              |
| <b>Usage Information</b> | Enter <code>conf t</code> for auto-completion.                    |



## Example

```
OS10# configure terminal
OS10(config)#
```

## Supported Releases

10.2.0E or later

## copy

Copies the current running configuration to the startup configuration and transfers files between an OS10 switch and a remote device.

## Syntax

```
copy running-configuration [startup-configuration | config://filepath |
coredump://filepath | ftp://filepath | home://filepath | scp://filepath |
sftp://filepath | supportbundle://filepath | severity-profile profile-name
| tftp://filepath | http://filepath | https://filepath | usb://filepath]
```

## Parameters

- `running-configuration startup-configuration`—(Optional) Copy the current running configuration file to the startup configuration file.
- `config://filepath`—(Optional) Copy from the configuration directory
- `coredump://filepath`—(Optional) Copy from the coredump directory
- `ftp://userid:passwd@hostip/filepath`—(Optional) Copy from a remote FTP server
- `home://username/filepath`—(Optional) Copy from the home directory
- `scp://userid:passwd@hostip/filepath`—(Optional) Copy from a remote SCP server
- `sftp://userid:passwd@hostip/filepath`—(Optional) Copy from a remote SFTP server
- `supportbundle://filepath`—(Optional) Copy from the support-bundle directory
- `severity-profile://filepath`—(Optional) Copy from the severity-profile directory
- `tftp://hostip/filepath`—(Optional) Copy from a remote TFTP server
- `http://hostip/filepath`—(Optional) Copy from a remote HTTP server
- `https://hostip/filepath`—(Optional) Copy from a remote HTTPS server
- `usb:filepath`—(Optional) Copy from a USB file system

## Default

Not configured

## Command Mode

EXEC

## Usage Information

Use this command to perform the following tasks:

- Save the running configuration to the startup configuration.
- Transfer coredump files to a remote location.
- Back up the startup configuration
- Retrieve a previously backed-up configuration.
- Replace the startup configuration file.
- Transfer support bundles

**CAUTION:** Dell EMC Networking recommends that you do not use a `copy` command to download an OS10 image to the switch. The downloaded image occupies a large amount of disk space. Use the `image download` command to download an OS10 image.

When using the `scp` and `sftp` options, always enter an absolute file path instead of a path relative to the home directory of the user account; for example:

```
copy config://startup.xml scp://dellos10:password@10.1.1.1/home/dellos10/
backup.xml
```

Use the `copy` command with the `severity-profile` option to download or upload severity profiles from a remote location. When you copy a severity profile from a remote location to an OS10 switch, ensure that the name of the severity profile is different than that of the default profile (`default.xml`) or the currently active severity profile.

### Example

```
OS10# dir coredump

Directory contents for folder: coredump
Date (modified) Size (bytes) Name

2017-02-15T19:05:41Z 12402278 core.netconfd-
pro.2017-02-15_19-05-09.gz

OS10# copy coredump://core.netconfd-pro.2017-02-15_19-05-09.gz scp://
os10user:os10passwd@10.11.222.1/home/os10/core.netconfd-pro.2017-02
-15_19-05-09.gz
```

### Example: Copy startup configuration

```
OS10# dir config

Directory contents for folder: config
Date (modified) Size (bytes) Name

2017-02-15T20:38:12Z 54525 startup.xml

OS10# copy config://startup.xml scp://os10user:os10passwd@10.11.222.1/
home/os10/backup.xml
```

### Example: Retrieve backed-up configuration.

```
OS10# copy scp://os10user:os10passwd@10.11.222.1/home/os10/backup.xml
home://config.xml

OS10(conf-if-eth1/1/5)# dir home

Directory contents for folder: home
Date (modified) Size (bytes) Name

...
2017-02-15T21:19:54Z 54525 config.xml
...
```

### Example: Download custom severity profile from a remote location.

```
copy scp://username:password@a.b.c.d//file-path/mySevProf.xml severity-
profile://mySevProf_1.xml
```

### Example: Replace startup configuration.

```
OS10# home://config.xml config://startup.xml
```

### Supported Releases

10.2.0E or later

## delete

Removes or deletes a file, including the startup configuration file.

### Syntax

```
delete [config://filepath | coredump://filepath | home://filepath |
image://filepath | startup-configuration | severity-profile profile-name |
supportbundle://filepath | usb://filepath]
```

### Parameters

- `config://filepath` — (Optional) Delete from the configuration directory.
- `coredump://filepath` — (Optional) Delete from the coredump directory.
- `home://filepath` — (Optional) Delete from the home directory.
- `image://filepath` — (Optional) Delete from the image directory.

- `startup-configuration` — (Optional) Delete the startup configuration.
- `severity-profile` — (Optional) Delete from severity profile directory, `severity-profile://filepath`.
- `supportbundle://filepath` — (Optional) Delete from the support-bundle directory.
- `usb://filepath` — (Optional) Delete from the USB file system.

**Default** Not configured

**Command Mode** EXEC

**Usage Information** Use this command to remove a regular file, software image, or startup configuration. Removing the startup configuration restores the system to the factory default. You must reboot the switch using the `reload` command for the operation to take effect.

**NOTE:**

- Use caution when removing the startup configuration.
- When the system disk space is low, a syslog message displays:

```
SYS_STAT_LOW_DISK_SPACE: Warning! Configuration directory has 0.0% free. Please delete unnecessary files from home directory.
```

When you see this error, delete unwanted files from the home directory or you may encounter degraded system performance.

**Example**

```
OS10# delete startup-configuration
```

```
OS10# delete severity-profile://mySevProf.xml
```

**Supported Releases** 10.2.0E or later

## dir

Displays files stored in available directories.

**Syntax** `dir {config | coredump | home | image | severity-profile | supportbundle | usb}`

- Parameters**
- `config` — (Optional) Folder containing configuration files.
  - `coredump` — (Optional) Folder containing coredump files.
  - `home` — (Optional) Folder containing files in your home directory.
  - `image` — (Optional) Folder containing image files.
  - `severity-profile` — (Optional) Folder containing alarm severity profiles.
  - `supportbundle` — (Optional) Folder containing support bundle files.
  - `usb` — (Optional) Folder containing files on a USB drive.

**Default** Not configured

**Command Mode** EXEC

**Usage Information** The `dir` command requires at least one parameter. Use the `dir config` command to display configuration files.

**Example**

```
OS10# dir
config Folder containing configuration files
coredump Folder containing coredump files
home Folder containing files in user's home directory
image Folder containing image files
severity-profile Folder containing severity profiles
supportbundle Folder containing support bundle files
```

### Example (config)

```
OS10# dir config
Directory contents for folder: config
Date (modified) Size (bytes) Name

2017-04-26T15:23:46Z 26704 startup.xml
```

```
OS10# dir severity-profile
Date (modified) Size (bytes) Name

2019-03-27T15:24:06Z 46741 default.xml
2019-04-01T11:22:33Z 456 mySevProf.xml
```

**Supported Releases** 10.2.0E or later

## discard

Discards changes made to the candidate configuration file.

**Syntax** discard

**Parameters** None

**Default** Not configured

**Command Mode** EXEC

**Usage Information** None

### Example

```
OS10# discard
```

**Supported Releases** 10.2.0E or later

## do

Executes most commands from all CONFIGURATION modes without returning to EXEC mode.

**Syntax** do *command*

**Parameters** *command* — Enter an EXEC-level command.

**Default** Not configured

**Command Mode** INTERFACE

**Usage Information** None

### Example

```
OS10(config)# interface ethernet 1/1/7
OS10(conf-if-eth1/1/7)# no shutdown
OS10(conf-if-eth1/1/7)# do show running-configuration
...
!
interface ethernet1/1/7
 no shutdown
!
...
```

**Supported Releases** 10.2.0E or later

## end

Returns to EXEC mode from any other command mode.

|                           |                                                                                                                                  |
|---------------------------|----------------------------------------------------------------------------------------------------------------------------------|
| <b>Syntax</b>             | end                                                                                                                              |
| <b>Parameters</b>         | None                                                                                                                             |
| <b>Default</b>            | Not configured                                                                                                                   |
| <b>Command Mode</b>       | All                                                                                                                              |
| <b>Usage Information</b>  | Use the <code>end</code> command to return to EXEC mode to verify currently configured settings with <code>show</code> commands. |
| <b>Example</b>            | <pre>OS10(config)# end OS10#</pre>                                                                                               |
| <b>Supported Releases</b> | 10.2.0E or later                                                                                                                 |

## exit

Returns to the next higher command mode.

|                           |                                                       |
|---------------------------|-------------------------------------------------------|
| <b>Syntax</b>             | exit                                                  |
| <b>Parameters</b>         | None                                                  |
| <b>Default</b>            | Not configured                                        |
| <b>Command Mode</b>       | All                                                   |
| <b>Usage Information</b>  | None                                                  |
| <b>Example</b>            | <pre>OS10(conf-if-eth1/1/1)# exit OS10(config)#</pre> |
| <b>Supported Releases</b> | 10.2.0E or later                                      |

## hostname

Sets the system host name.

|                          |                                                                                                                                                                                                                                                                                                                                                                                                                                                                                                                                                                                                                                                                                                                    |
|--------------------------|--------------------------------------------------------------------------------------------------------------------------------------------------------------------------------------------------------------------------------------------------------------------------------------------------------------------------------------------------------------------------------------------------------------------------------------------------------------------------------------------------------------------------------------------------------------------------------------------------------------------------------------------------------------------------------------------------------------------|
| <b>Syntax</b>            | hostname <i>name</i>                                                                                                                                                                                                                                                                                                                                                                                                                                                                                                                                                                                                                                                                                               |
| <b>Parameters</b>        | <i>name</i> — Enter the host name of the switch, a maximum of 64 characters.                                                                                                                                                                                                                                                                                                                                                                                                                                                                                                                                                                                                                                       |
| <b>Default</b>           | OS10                                                                                                                                                                                                                                                                                                                                                                                                                                                                                                                                                                                                                                                                                                               |
| <b>Command Mode</b>      | CONFIGURATION                                                                                                                                                                                                                                                                                                                                                                                                                                                                                                                                                                                                                                                                                                      |
| <b>Usage Information</b> | <p>The host name is used in the OS10 command-line prompt.</p> <p>The MX7000 series switch, not the Dell EMC SmartFabric OS10, automatically sets the default hostname using a <i>module-slot</i> format. To calculate the hostname, the switch takes into account the module that is currently plugged into the MX7000 chassis and the slot in the chassis where the module is inserted. The module can be either MX9116n or MX5108n.</p> <p><b>i</b> <b>NOTE:</b> To make the switch automatically set the default hostname using the <i>module-slot</i> format, before upgrading to version 10.5.0, remove the user-defined hostname or set the default hostname using the <code>no hostname</code> command.</p> |

Supported on the MX9116n and MX5108n switches in Full-Switch mode starting in release 10.4.0(R3S). Also supported in SmartFabric Services mode starting in 10.5.0.

The `no` version of this command resets the host name to OS10.

**Example**

```
OS10(config)# hostname R1
R1(config)#
```

**Supported Releases**

10.3.0E or later

## license

Installs a license file from a local or remote location.

**Syntax**

```
license install [ftp: | http: | localfs: | scp: | sftp: | tftp: | usb:]
filepath
```

**Parameters**

- `ftp:`—(Optional) Install from the remote file system (`ftp://userid:passwd@hostip/filepath`)
- `http:`—(Optional) Install from the remote file system (`http://hostip/filepath`)
- `http:`—(Optional) Request from remote server (`http://hostip`)
- `localfs:`—(Optional) Install from the local file system (`localfs://filepath`)
- `scp:`—(Optional) Request from the remote file system (`scp://userid:passwd@hostip/filepath`)
- `sftp:`—(Optional) Request from the remote file system (`sftp://userid:passwd@hostip/filepath`)
- `tftp:`—(Optional) Request from the remote file system (`tftp://hostip/filepath`)
- `usb:`—(Optional) Request from the USB file system (`usb://filepath`)

**Default**

Not configured

**Command Mode**

EXEC

**Usage Information**

Use this command to install the license file. For more information, see [Install OS10 license](#). OS10 requires a perpetual license to run beyond the 120-day trial period. The license file is installed in the `/mnt/license` directory.

**Example**

```
OS10# license install scp://user:userpwd/10.1.1.10/CFNNX42-NOSEnterprise-
License.lic
License installation success.
```

**Supported Releases**

10.3.0E or later

## lock

Locks the candidate configuration and prevents any configuration changes on any other CLI sessions, either in Transaction or Non-Transaction-Based Configuration mode.

**Syntax**

```
lock
```

**Parameters**

None

**Default**

Not configured

**Command Mode**

EXEC

**Usage Information**

The `lock` command fails if there are uncommitted changes in the candidate configuration.

**Example**

```
OS10# lock
```

**Supported Releases**

10.2.0E or later

## management route

Configures an IPv4/IPv6 static route the Management port uses. To configure multiple management routes, repeat the command.

**Syntax**

```
management route {ipv4-address/mask | ipv6-address/prefix-length}
{forwarding-router-address | managementethernet}
```

**Parameters**

- *ipv4-address/mask* — Enter an IPv4 network address in dotted-decimal format (A.B.C.D), then a subnet mask in prefix-length format (/xx).
- *ipv6-address/prefix-length* — Enter an IPv6 address in x:x:x:x format with the prefix length in /xxx format. The prefix range is /0 to /128.
- *forwarding-router-address* — Enter the next-hop IPv4/IPv6 address of a forwarding router (gateway) for network traffic from the Management port.
- *managementethernet* — Configure the Management port as the interface for the route and associates the route with the Management interface.

**Default**

Not configured

**Command Mode**

CONFIGURATION

**Usage Information**

Management routes are separate from IP routes and are only used to manage the switch through the Management port. To display the currently configured IPv4 and IPv6 management routes, use the `show ip management-route` and `show ipv6 management-route` commands.

**Example (IPv4)**

```
OS10(config)# management route 10.10.20.0/24 10.1.1.1
OS10(config)# management route 172.16.0.0/16 managementethernet
```

**Example (IPv6)**

```
OS10(config)# management route 10::/64 10::1
```

**Supported Releases**

10.2.2E or later

## move

Moves or renames a file in the configuration or home system directories.

**Syntax**

```
move [config: | home: | usb:]
```

**Parameters**

- *config:* — Move from the configuration directory (*config://filepath*).
- *home:* — Move from the home directory (*home://filepath*).
- *usb:* — Move from the USB file system (*usb://filepath*).

**Default**

Not configured

**Command Mode**

EXEC

**Usage Information**

Use the `dir config` command to view the directory contents.

**Example**

```
OS10# move config://startup.xml config://startup-backup.xml
```

**Example (dir)**

```
OS10# dir config
```

```
Directory contents for folder: config
Date (modified) Size (bytes) Name

2017-04-26T15:23:46Z 26704 startup.xml
```

**Supported Releases** 10.2.0E or later

## no

Disables or deletes commands in EXEC mode.

**Syntax** `no [alias | debug | support-assist-activity | terminal]`

- Parameters**
- `alias` — Remove an alias definition.
  - `debug` — Disable debugging.
  - `support-assist-activity` — SupportAssist-related activity.
  - `terminal` — Reset terminal settings.

**Default** Not configured

**Command Mode** EXEC

**Usage Information** Use this command in EXEC mode to disable or remove a configuration. Use the `no ?` in CONFIGURATION mode to view available commands.

**Example**

```
OS10# no alias goint
```

**Supported Releases** 10.2.0E or later

## ping

Tests network connectivity to an IPv4 device.

**Syntax** `ping [vrf {management | vrf-name}] [-4] [-aAbBdDfhLnOqrRUvV] [-c count] [-i interval] [-I interface] [-m mark] [-M pmtudisc_option] [-l preload] [-p pattern] [-Q tos] [-s packetsize] [-S sndbuf] [-t ttl] [-T timestamp_option] [-w deadline] [-W timeout] [hop1 ...] destination`

- Parameters**
- `vrf management` — (Optional) Pings an IPv4 address in the management virtual routing and forwarding (VRF) instance.
  - `vrf vrf-name` — (Optional) Ping an IP address in a specified VRF instance.
  - `-4` — (Optional) Uses the IPv4 route over the IPv6 route when both IPv4 as well as IPv6 default routes are configured, you must use the following option in the ping command: `-4`. For example, `OS10# ping vrf management -4 dell.com`.
  - `-a` — (Optional) Audible ping.
  - `-A` — (Optional) Adaptive ping. An inter-packet interval adapts to the round-trip time so that one (or more, if you set the preload option) unanswered probe is present in the network. The minimum interval is 200 msec for a non-super user, which corresponds to Flood mode on a network with a low round-trip time.
  - `-b` — (Optional) Pings a broadcast address.
  - `-B` — (Optional) Does not allow ping to change the source address of probes. The source address is bound to the address used when the ping starts.
  - `-c count` — (Optional) Stops the ping after sending the specified number of ECHO\_REQUEST packets until the timeout expires.
  - `-d` — (Optional) Sets the SO\_DEBUG option on the socket being used.
  - `-D` — (Optional) Prints the timestamp before each line.
  - `-h` — (Optional) Displays help for this command.



- `-i interval` — (Optional) Enter the interval in seconds to wait between sending each packet, the default is 1 second.
- `-I interface-name` or `interface-ip-address` — (Optional) Enter the source interface name without spaces or the interface IP address:
  - For a physical Ethernet interface, enter `ethernetnode/slot/port`; for example, `ethernet1/1/1`.
  - For a VLAN interface, enter `vlanvlan-id`; for example, `vlan10`.
  - For a Loopback interface, enter `loopbackid`; for example, `loopback1`.
  - For a port-channel interface, enter `port-channelchannel-id`; for example, `port-channel1`.
- `-l preload` — (Optional) Enter the number of packets that ping sends before waiting for a reply. Only a super user may preload more than three.
- `-L` — (Optional) Suppress the Loopback of multicast packets for a multicast target address.
- `-m mark` — (Optional) Tags the packets sent to ping a remote device. Use this option with policy routing.
- `-M pmtudisc_option` — (Optional) Enter the path MTU (PMTU) discovery strategy:
  - `do` prevents fragmentation, including local.
  - `want` performs PMTU discovery and fragments large packets locally.
  - `dont` does not set the Don't Fragment (DF) flag.
- `-p pattern` — (Optional) Enter a maximum of 16 pad bytes to fill out the packet you send to diagnose data-related problems in the network; for example, `-p ff` fills the sent packet with all 1's.
- `-Q tos` — (Optional) Enter a maximum of 1500 bytes in decimal or hex datagrams to set quality of service (QoS)-related bits.
- `-s packetsize` — (Optional) Enter the number of data bytes to send, from 1 to 65468, default 56.
- `-S sndbuf` — (Optional) Set the sndbuf socket. By default, the sndbuf socket buffers one packet maximum.
- `-t ttl` — (Optional) Enter the IPv4 time-to-live (TTL) value in seconds.
- `-T timestamp_option` — (Optional) Set special IP timestamp options. Valid values for `timestamp_option` — `tsonly` (only timestamps), `tsandaddr` (timestamps and addresses), or `tsprespec host1 [host2 [host3 [host4]]]` (timestamp pre-specified hops).
- `-v` — (Optional) Verbose output.
- `-V` — (Optional) Display the version and exit.
- `-w deadline` — (Optional) Enter the time-out value in seconds before the ping exits regardless of how many packets send or receive.
- `-W timeout` — (Optional) Enter the time to wait for a response in seconds. This setting affects the time-out only if there is no response, otherwise ping waits for two round-trip times (RTTs).
- `hop1 ...` (Optional) Enter the IPv4 addresses of the pre-specified hops for the ping packet to take.
- `destination` — Enter the IP address you are testing connectivity on.

**Default** Not configured

**Command Mode** EXEC

**Usage Information**

This command uses an ICMP ECHO\_REQUEST datagram to receive an ICMP ECHO\_RESPONSE from a network host or gateway. Each ping packet has an IPv4 and ICMP header, then a time value and a number of "pad" bytes used to fill out the packet. A ping operation sends a packet to a specified IP address and then measures the time that it takes to get a response from the address or device.

If the destination IP address is active, replies are sent back from the server including the IP address, number of bytes sent, lapse time in milliseconds, and TTL, which is the number of hops back from the source to the destination.

When you use the `-I` option and enter an IP address, OS10 considers it as the source address. If you use an interface name instead of the IP address, OS10 considers it as the egress interface.

With the `-I` option, if you ping a reachable IP address using the IP address of a loopback interface as the source interface, the ping succeeds. However, if you ping a reachable IP address using the name of the loopback interface as the source interface, the ping fails. This is because the system considers the loopback interface as the egress interface.

## Example

```
OS10# ping 20.1.1.1
PING 20.1.1.1 (20.1.1.1) 56(84) bytes of data.
64 bytes from 20.1.1.1: icmp_seq=1 ttl=64 time=0.079 ms
64 bytes from 20.1.1.1: icmp_seq=2 ttl=64 time=0.081 ms
64 bytes from 20.1.1.1: icmp_seq=3 ttl=64 time=0.133 ms
64 bytes from 20.1.1.1: icmp_seq=4 ttl=64 time=0.124 ms
^C
--- 20.1.1.1 ping statistics ---
4 packets transmitted, 4 received, 0% packet loss, time 2997ms
rtt min/avg/max/mdev = 0.079/0.104/0.133/0.025 ms
```

## Supported Releases

10.2.0E or later

# ping6

Tests network connectivity to an IPv6 device.

## Syntax

```
ping6 [vrf {management | vrf-name}] [-aAbBdDfhLnOqrRUvV] [-c count] [-i interval] [-I interface] [-l preload] [-m mark] [-M pmtudisc_option] [-N nodeinfo_option] [-p pattern] [-Q tclass] [-s packetsize] [-S sndbuf] [-t ttl] [-T timestamp_option] [-w deadline] [-W timeout] destination
```

## Parameters

- **vrf management** — (Optional) Pings an IPv6 address in the management VRF instance.
- **vrf vrf-name** — (Optional) Pings an IPv6 address in a specified VRF instance.
- **-a** — (Optional) Audible ping.
- **-A** — (Optional) Adaptive ping. An inter-packet interval adapts to the round-trip time so that one (or more, if you set the preload option) unanswered probe is present in the network. The minimum interval is 200 msec for a non-super user, which corresponds to Flood mode on a network with a low round-trip time.
- **-b** — (Optional) Pings a broadcast address.
- **-B** — (Optional) Does not allow ping to change the source address of probes. The source address is bound to the address used when the ping starts.
- **-c count** — (Optional) Stops the ping after sending the specified number of ECHO\_REQUEST packets until the timeout expires.
- **-d** — (Optional) Sets the SO\_DEBUG option on the socket being used.
- **-D** — (Optional) Prints the timestamp before each line.
- **-F flowlabel** — (Optional) Sets a 20-bit flow label on echo request packets. If value is zero, the kernel allocates a random flow label.
- **-h** — (Optional) Displays help for this command.
- **-i interval** — (Optional) Enter the interval in seconds to wait between sending each packet, the default is 1 second.
- **-I interface-name or interface-ip-address** — (Optional) Enter the source interface name without spaces or the interface IP address:
  - For a physical Ethernet interface, enter `ethernetnode/slot/port`; for example, `ethernet1/1/1`.
  - For a VLAN interface, enter `vlanvlan-id`; for example, `vlan10`.
  - For a Loopback interface, enter `loopbackid`; for example, `loopback1`.
  - For a port-channel interface, enter `port-channelchannel-id`; for example, `port-channel1`.
- **-l preload** — (Optional) Enter the number of packets that ping sends before waiting for a reply. Only a super-user may preload more than three.
- **-L** — (Optional) Suppress the Loopback of multicast packets for a multicast target address.
- **-m mark** — (Optional) Tags the packets sent to ping a remote device. Use this option with policy routing.
- **-M pmtudisc\_option** — (Optional) Enter the path MTU (PMTU) discovery strategy:
  - `do` prevents fragmentation, including local.
  - `want` performs PMTU discovery and fragments large packets locally.

- dont does not set the Don't Fragment (DF) flag.
- `-p pattern` — (Optional) Enter a maximum of 16 pad bytes to fill out the packet you send to diagnose data-related problems in the network; for example, `-p ff` fills the sent packet with all 1's.
- `-Q tos` — (Optional) Enter a maximum of 1500 bytes in decimal or hex datagrams to set the quality of service (QoS)-related bits.
- `-s packetsize` — (Optional) Enter the number of data bytes to send, from 1 to 65468, default 56.
- `-S sndbuf` — (Optional) Set the sndbuf socket. By default, the sndbuf socket buffers one packet maximum.
- `-t ttl` — (Optional) Enter the IPv6 time-to-live (TTL) value in seconds.
- `-T timestamp option` — (Optional) Set special IP timestamp options. Valid values for `timestamp option` — `tsonly` (only timestamps), `tsandaddr` (timestamps and addresses), or `tsprespec host1 [host2 [host3 [host4]]]` (timestamp pre-specified hops).
- `-v` — (Optional) Verbose output.
- `-V` — (Optional) Display the version and exit.
- `-w deadline` — (Optional) Enter the time-out value in seconds before the ping exits regardless of how many packets are sent or received.
- `-W timeout` — (Optional) Enter the time to wait for a response in seconds. This setting affects the time-out only if there is no response, otherwise ping waits for two round-trip times (RTTs).
- `hop1 ...` (Optional) Enter the IPv6 addresses of the pre-specified hops for the ping packet to take.
- `destination` — Enter the IPv6 destination address in A:B::C:D format, where you are testing connectivity.

**Default** Not configured

**Command Mode** EXEC

**Usage Information**

This command uses an ICMP ECHO\_REQUEST datagram to receive an ICMP ECHO\_RESPONSE from a network host or gateway. Each ping packet has an IPv6 and ICMP header, then a time value and a number of "pad" bytes used to fill out the packet. A pingv6 operation sends a packet to a specified IPv6 address and then measures the time it takes to get a response from the address or device.

When you use the `-I` option and enter an IP address, OS10 considers it as the source address. If you use an interface name instead of the IP address, OS10 considers it as the egress interface.

With the `-I` option, if you ping a reachable IP address using the IP address of a loopback interface as the source interface, the ping succeeds. However, if you ping a reachable IP address using the name of the loopback interface as the source interface, the ping fails. This is because the system considers the loopback interface as the egress interface.

**Example**

```
OS10# ping6 20::1
PING 20::1(20::1) 56 data bytes
64 bytes from 20::1: icmp_seq=1 ttl=64 time=2.07 ms
64 bytes from 20::1: icmp_seq=2 ttl=64 time=2.21 ms
64 bytes from 20::1: icmp_seq=3 ttl=64 time=2.37 ms
64 bytes from 20::1: icmp_seq=4 ttl=64 time=2.10 ms
^C
--- 20::1 ping statistics ---
4 packets transmitted, 4 received, 0% packet loss, time 3005ms
rtt min/avg/max/mdev = 2.078/2.194/2.379/0.127 ms
```

**Supported Releases** 10.2.0E or later

## reload

Reloads the software and reboots the ONIE-enabled device.

**Syntax** reload

**Parameters** None

**Default** Not configured

**Command Mode** EXEC

**Usage Information**  **NOTE:** Use caution while using this command as it reloads the OS10 image and reboots the device.

**Example**

```
OS10# reload

Proceed to reboot the system? [confirm yes/no]:y
```

**Supported Releases** 10.2.0E or later

## show boot

Displays detailed information about the boot image.

**Syntax** show boot [detail]

**Parameters** None

**Default** Not configured

**Command Mode** EXEC

**Usage Information** The Next-Boot field displays the image that the next reload uses.

**Example**

```
OS10# show boot
Current system image information:
=====
Type Boot Type Active Standby Next-Boot

Node-id 1 Flash Boot [A] 10.5.0.4 [B] 10.5.1.0 [B] standby
```

**Example (detail)**

```
OS10# show boot detail
Current system image information detail:
=====
Type: Node-id 1
Boot Type: Flash Boot
Active Partition: A
Active SW Version: 10.5.0.4
Active SW Build Version: 10.5.0.4.650
Active Kernel Version: Linux 4.9.189
Active Build Date/Time: 2020-02-11T11:13:08Z
Standby Partition: B
Standby SW Version: 10.5.1.0
Standby SW Build Version: 10.5.1.0.123
Standby Build Date/Time: 2020-02-12T02:34:02Z
Next-Boot: standby[B]
```

**Supported Releases** 10.2.0E or later

## show candidate-configuration

Displays the current candidate configuration file.

**Syntax** show candidate-configuration [aaa | access-list | as-path | bfd | bgp | class-map | community-list | compressed | control-plane | dot1x | extcommunity-list | evpn | fevd | igmp | interface [virtual-network vn-id] | ip dhcp snooping | lacp | line | lldp | logging | management-route | mld | monitor | ntp | nve | ospf | ospfv3 | password-attributes | pim | policy-

map | port-security | prefix-list | privilege | qos-map | radius-server | route | route-map | sflow | smartfabric | snmp | spanning-tree | support-assist | system-qos | tacacs-server | telemetry | trust-map | uplink-state-group | userrole | users | virtual-network | vlt | vrf | wred-profile]

## Parameters

- `aaa` — (Optional) Current operating AAA configuration.
- `access-list` — (Optional) Current operating access-list configuration.
- `as-path` — (Optional) Current operating as-path configuration.
- `bfd` — (Optional) Current operating BFD configuration.
- `bgp` — (Optional) Current operating BGP configuration.
- `class-map` — (Optional) Current operating class-map configuration.
- `community-list` — (Optional) Current operating community-list configuration.
- `compressed` — (Optional) Current operating configuration in compressed format.
- `control-plane` — (Optional) Current operating control-plane configuration.
- `dot1x` — (Optional) Current operating dot1x configuration.
- `evpn` — (Optional) Current operating EVPN configuration.
- `extcommunity-list` — (Optional) Current operating extcommunity-list configuration.
- `interface` — (Optional) Current operating interface configuration.
  - `virtual-network vn-id` — (Optional) Current virtual network configuration.
- `fejd` — (Optional) Current operating FEJD configuration.
- `igmp` — (Optional) Current operating IGMP configuration.
- `ip dhcp snooping` — (Optional) Current operating DHCP snooping information.
- `lACP` — (Optional) Current operating LACP configuration.
- `lldp` — (Optional) Current operating LLDP configuration.
- `logging` — (Optional) Current operating logging configuration.
- `management-route` — (Optional) Current operating management route configuration.
- `mld` — (Optional) Current operating MLD configuration.
- `monitor` — (Optional) Current operating monitor session configuration.
- `nTP` — (Optional) Current operating NTP configuration.
- `nve` — (Optional) Current operating NVE configuration.
- `ospf` — (Optional) Current operating OSPF configuration.
- `ospfv3` — (Optional) Current operating OSPFv3 configuration.
- `password-attributes` — (Optional) Current operating passwords attributes configuration.
- `pim` — (Optional) Current operating PIM configuration.
- `port-security` — (Optional) Current operating port security configuration.
- `policy-map` — (Optional) Current operating policy-map configuration.
- `prefix-list` — (Optional) Current operating prefix-list configuration.
- `privilege` — (Optional) Current operating user privilege configuration.
- `qos-map` — (Optional) Current operating qos-map configuration.
- `radius-server` — (Optional) Current operating radius-server configuration.
- `route` — (Optional) Current operating management route configuration.
- `route-map` — (Optional) Current operating route-map configuration.
- `sflow` — (Optional) Current operating sFlow configuration.
- `smartfabric` — (Optional) Current operating SmartFabric configuration.
- `snmp` — (Optional) Current operating SNMP configuration.
- `spanning-tree` — (Optional) Current operating spanning-tree configuration.
- `support-assist` — (Optional) Current operating support-assist configuration.
- `system-qos` — (Optional) Current operating system-qos configuration.
- `tacacs-server` — (Optional) Current operating TACACS server configuration.
- `telemetry` — (Optional) Current operating telemetry configuration.
- `trust-map` — (Optional) Current operating trust-map configuration.
- `uplink-state-group` — (Optional) Current operating Uplink State Group configuration.
- `users` — (Optional) Current operating users configuration.
- `userrole` — (Optional) Current operating user role configuration.

- `virtual-network` — (Optional) Current operating virtual network configuration.
- `vlt` — (Optional) Current operating VLT domain configuration.
- `vrf` — (Optional) Current operating VRF configuration.
- `wred-profile` — (Optional) Current operating WRED profile configuration.

**Default** Not configured

**Command Mode** EXEC

**Usage Information** None

**Example**

```
OS10# show candidate-configuration
! Version 10.2.9999E
! Last configuration change at Apr 11 10:36:43 2017
!
username admin password 6q9QBeYjZ
$jfxzVqGhkxX3smxJSH9DDz7/30Jc6m5wjF8nnLD7/VKx8S1oIhp4NoGZs0I/
UNwh8WVuxwfd9q4pWIGNs5BKH.
aaa authentication local
snmp-server contact http://www.dell.com/support
snmp-server location "United States"
logging monitor disable
ip route 0.0.0.0/0 10.11.58.1
!
interface ethernet1/1/1
 switchport access vlan 1
 no shutdown
!
interface ethernet1/1/2
 switchport access vlan 1
 no shutdown
!
interface ethernet1/1/3
 switchport access vlan 1
 no shutdown
!
interface ethernet1/1/4
 switchport access vlan 1
 no shutdown
!
interface ethernet1/1/5
 switchport access vlan 1
 no shutdown
!
--more--
```

**Example  
(compressed)**

```
OS10# show candidate-configuration compressed
username admin password 6q9QBeYjZ
$jfxzVqGhkxX3smxJSH9DDz7/30Jc6m5wjF8nnLD7/VKx8S1oIhp4NoGZs0I/
UNwh8WVuxwfd9q4pWIGNs5BKH.
aaa authentication local
snmp-server contact http://www.dell.com/support
snmp-server location "United States"
logging monitor disable
ip route 0.0.0.0/0 10.11.58.1
!
interface range ethernet 1/1/1-1/1/32
 switchport access vlan 1
 no shutdown
!
interface vlan 1
 no shutdown
!
interface mgmt1/1/1
 ip address 10.11.58.145/8
 no shutdown
 ipv6 enable
 ipv6 address autoconfig
```

```

!
support-assist
!
policy-map type application policy-iscsi
!
class-map type application class-iscsi

```

**Supported Releases** 10.2.0E or later

## show environment

Displays information about environmental system components, such as temperature, fan, and voltage.

**Syntax** show environment

**Parameters** None

**Default** Not configured

**Command Mode** EXEC

**Usage Information** None

### Example

```

OS10# show environment

Unit State Temperature

1 up 43

Thermal sensors
Unit Sensor-Id Sensor-name Temperature

1 1 CPU On-Board temp sensor 32
1 2 Switch board temp sensor 28
1 3 System Inlet Ambient-1 temp sensor 27
1 4 System Inlet Ambient-2 temp sensor 25
1 5 System Inlet Ambient-3 temp sensor 26
1 6 Switch board 2 temp sensor 31
1 7 Switch board 3 temp sensor 41
1 8 NPU temp sensor 43

```

**Supported Releases** 10.2.0E or later

## show inventory

Displays system inventory information.

**Syntax** show inventory

**Parameters** None

**Default** Not configured

**Command Mode** EXEC

**Usage Information** None

### Example

```

OS10# show inventory
Product : S4148F-ON
Description : S4148F-ON 48x10GbE, 2x40GbE QSFP+, 4x100GbE QSFP28 Interfa
Software version : 10.5.1.0

```

```
Product Base :
Product Serial Number :
Product Part Number :
```

| Unit | Type | Part Number         | Rev    | Piece Part ID | Svc Tag                  |         |
|------|------|---------------------|--------|---------------|--------------------------|---------|
| *    | 1    | S4148F-ON           | 09H9MN | X01           | TW-09H9MN-28298-713-0026 | 9531XC2 |
|      | 1    | S4148F-ON-PWR-1-AC  | 06FKHH | A00           | CN-06FKHH-28298-6B5-03NY |         |
|      | 1    | S4148F-ON-FANTRAY-1 | 0N7MH8 | X01           | TW-0N7MH8-28298-713-0101 |         |
|      | 1    | S4148F-ON-FANTRAY-2 | 0N7MH8 | X01           | TW-0N7MH8-28298-713-0102 |         |
|      | 1    | S4148F-ON-FANTRAY-3 | 0N7MH8 | X01           | TW-0N7MH8-28298-713-0103 |         |
|      | 1    | S4148F-ON-FANTRAY-4 | 0N7MH8 | X01           | TW-0N7MH8-28298-713-0104 |         |

**Supported Releases**

10.2.0E or later

## show ip management-route

Displays the IPv4 routes used to access the Management port.

**Syntax**

```
show ip management-route [all | connected | dynamic | static summary]
```

**Parameters**

- `all` — (Optional) Display the IPv4 routes that the Management port uses.
- `connected` — (Optional) Display only routes directly connected to the Management port.
- `dynamic` — (Optional) Display active management routes that are learned by a routing protocol.
- `summary` — (Optional) Display the number of active and non-active management routes and their remote destinations.
- `static` — (Optional) Display active static management routes.

**Default**

Not configured

**Command Mode**

EXEC

**Usage Information**

Use this command to view the IPv4 static and connected routes configured for the Management port. Use the `management route` command to configure an IPv4 or IPv6 management route.

**Example**

```
OS10# show ip management-route
Destination Gateway State Source

192.168.10.0/24 managementethernet Connected Connected
```

**Supported Releases**

10.2.2E or later

## show ipv6 management-route

Displays the IPv6 routes used to access the Management port.

**Syntax**

```
show ipv6 management-route [all | connected | static | summary]
```

**Parameters**

- `all` — (Optional) Display the IPv6 routes that the Management port uses.
- `connected` — (Optional) Display only routes directly connected to the Management port.
- `summary` — (Optional) Display the number of active and non-active management routes and their remote destinations.
- `static` — (Optional) Display active static management routes.

**Default**

Not configured

**Command Mode**

EXEC

**Usage Information**

Use this command to view the IPv6 static and connected routes configured for the Management port. Use the `management route` command to configure an IPv4 or IPv6 management route.



### Example

```
OS10# show ipv6 management-route

Destination Gateway State

2001:34::0/64 ManagementEthernet 1/1 Connected
2001:68::0/64 2001:34::16 Active
```

**Supported Releases** 10.2.2E or later

## show license status

Displays license status information.

**Syntax** show license status

**Parameters** None

**Default** Not configured

**Command Mode** EXEC

**Usage Information** Use the show license status command to verify the current license for running OS10, its duration, and the service tag assigned to the switch.

### Example

```
OS10# show license status

System Information

Vendor Name : DELL EMC
Product Name : S4148F-ON
Hardware Version : X01
Platform Name : x86_64-dell_s4100_c2338-r0
PPID : TW09H9MN282987130026
Service Tag : 9531XC2
Product Base :
Product Serial Number:
Product Part Number :
License Details

Software : OS10-Enterprise
Version : 10.5.1.0
License Type : PERPETUAL
License Duration : Unlimited
License Status : Active
License location : /mnt/license/9531XC2.lic

```

**Supported Releases** 10.3.0E or later

## show running-configuration

Displays the configuration currently running on the device.

**Syntax** show running-configuration [aaa | access-list | as-path | bfd | bgp [vrf vrf-name] [neighbor {ip-address | interface interface-type | class-map | community-list | compressed | control-plane | crypto | dot1x | extcommunity-list | evpn | fefd | igmp | interface [virtual-network vn-id] | ip dhcp snooping | lACP | line | lldp | logging | management-route | mld | monitor | ntp | nve | ospf | ospfv3 | password-attributes | pim | policy-map | port-security | prefix-list | privilege | qos-map | radius-server | route | route-map | sflow | smartfabric | snmp | spanning-tree | support-

assist | system-qos | tacacs-server | telemetry | trust-map | uplink-state-group | userrole | users | virtual-network | vlt | vrf | wred-profile]

## Parameters

- aaa — (Optional) Current operating AAA configuration.
- access-list — (Optional) Current operating access-list configuration.
- as-path — (Optional) Current operating as-path configuration.
- bfd — (Optional) Current operating BFD configuration.
- bgp] — (Optional) Current operating BGP configuration.
  - [vrf *vrf-name*] — Enter the VRF name.
  - [neighbor [*ip-address*] interface *interface-type*] Enter the interface IP address or interface name.
  -
- class-map — (Optional) Current operating class-map configuration.
- community-list — (Optional) Current operating community-list configuration.
- compressed — (Optional) Current operating configuration in compressed format.
- control-plane — (Optional) Current operating control-plane configuration.
- crypto — (Optional) Current operating cryptographic configuration.
- dot1x — (Optional) Current operating dot1x configuration.
- evpn — (Optional) Current operating EVPN configuration.
- extcommunity-list — (Optional) Current operating extcommunity-list configuration.
- interface — (Optional) Current operating interface configuration.
  - virtual-network *vn-id* — (Optional) Current virtual network configuration.
- fefd — (Optional) Current operating FEFD configuration.
- igmp — (Optional) Current operating IGMP configuration.
- ip dhcp snooping — (Optional) Current operating DHCP snooping information.
- lacp — (Optional) Current operating LACP configuration.
- lldp — (Optional) Current operating LLDP configuration.
- logging — (Optional) Current operating logging configuration.
- management-route — (Optional) Current operating management route configuration.
- mld — (Optional) Current operating MLD configuration.
- monitor — (Optional) Current operating monitor session configuration.
- ntp — (Optional) Current operating NTP configuration.
- nve — (Optional) Current operating NVE configuration.
- ospf — (Optional) Current operating OSPF configuration.
- ospfv3 — (Optional) Current operating OSPFv3 configuration.
- password-attributes — (Optional) Current operating passwords attributes configuration.
- pim — (Optional) Current operating PIM configuration.
- port-security — (Optional) Current operating port security configuration.
- policy-map — (Optional) Current operating policy-map configuration.
- prefix-list — (Optional) Current operating prefix-list configuration.
- privilege — (Optional) Current operating user privilege configuration.
- qos-map — (Optional) Current operating qos-map configuration.
- radius-server — (Optional) Current operating radius-server configuration.
- route — (Optional) Current operating management route configuration.
- route-map — (Optional) Current operating route-map configuration.
- sflow — (Optional) Current operating sFlow configuration.
- smartfabric — (Optional) Current operating SmartFabric configuration.
- snmp — (Optional) Current operating SNMP configuration.
- spanning-tree — (Optional) Current operating spanning-tree configuration.
- support-assist — (Optional) Current operating support-assist configuration.
- system-qos — (Optional) Current operating system-qos configuration.
- tacacs-server — (Optional) Current operating TACACS server configuration.
- telemetry — (Optional) Current operating telemetry configuration.
- trust-map — (Optional) Current operating trust-map configuration.

- `uplink-state-group` — (Optional) Current operating Uplink State Group configuration.
- `users` — (Optional) Current operating users configuration.
- `userrole` — (Optional) Current operating user role configuration.
- `virtual-network` — (Optional) Current operating virtual network configuration.
- `vlt` — (Optional) Current operating VLT domain configuration.
- `vrf` — (Optional) Current operating VRF configuration.
- `wred-profile` — (Optional) Current operating WRED profile configuration.

**Default** Not configured

**Command Mode** EXEC

**Usage Information** None

**Example**

```
OS10# show running-configuration
! Version 10.2.9999E
! Last configuration change at Apr 11 01:25:02 2017
!
username admin password 6q9QBeYjZ
$jfxzVqGhkxX3smxJSH9DDz7/30Jc6m5wjF8nnLD7/VKx8S1oIhp4NoGZs0I/
UNwh8WVuxwfd9q4pWIGNs5BKH.
aaa authentication local
snmp-server contact http://www.dell.com/support
snmp-server location "United States"
logging monitor disable
ip route 0.0.0.0/0 10.11.58.1
!
interface ethernet1/1/1
 switchport access vlan 1
 no shutdown
!
interface ethernet1/1/2
 switchport access vlan 1
 no shutdown
!
interface ethernet1/1/3
 switchport access vlan 1
 no shutdown
!
interface ethernet1/1/4
 switchport access vlan 1
 no shutdown
!
interface ethernet1/1/5
 switchport access vlan 1
 no shutdown
!
interface ethernet1/1/6
 switchport access vlan 1
 no shutdown
--more--
```

**Example (compressed)**

```
OS10# show running-configuration compressed
username admin password 6q9QBeYjZ
$jfxzVqGhkxX3smxJSH9DDz7/30Jc6m5wjF8nnLD7/VKx8S1oIhp4NoGZs0I/
UNwh8WVuxwfd9q4pWIGNs5BKH.
aaa authentication local
snmp-server contact http://www.dell.com/support
snmp-server location "United States"
logging monitor disable
ip route 0.0.0.0/0 10.11.58.1
!
interface range ethernet 1/1/1-1/1/32
 switchport access vlan 1
 no shutdown
!
interface vlan 1
```

```

no shutdown
!
interface mgmt1/1/1
 ip address 10.11.58.145/8
 no shutdown
 ipv6 enable
 ipv6 address autoconfig

!
support-assist
!
policy-map type application policy-iscsi
!
class-map type application class-iscsi

```

**Supported Releases** 10.2.0E or later

## show startup-configuration

Displays the contents of the startup configuration file.

**Syntax** show startup-configuration [compressed]

**Parameters** compressed — (Optional) View a compressed version of the startup configuration file.

**Default** Not configured

**Command Mode** EXEC

**Usage Information** None

**Example**

```

OS10# show startup-configuration
username admin password 6q9QBeYjZ
$jfxzVqGhkxX3smxJSH9DDz7/30Jc6m5wjF8nnLD7/VKx8S1oIhp4NoGZs0I/
UNwh8WVuxwfd9q4pWIGNs5BKH.
aaa authentication local
snmp-server contact http://www.dell.com/support
snmp-server location "United States"
ip route 0.0.0.0/0 10.11.58.1
!
interface ethernet1/1/1
 switchport access vlan 1
 no shutdown
!
interface ethernet1/1/2
 switchport access vlan 1
 no shutdown
!
interface ethernet1/1/3
 switchport access vlan 1
 no shutdown
!
interface ethernet1/1/4
 switchport access vlan 1
 no shutdown
!
interface ethernet1/1/5
 switchport access vlan 1
 no shutdown
!
--more--

```

**Example (compressed)**

```

OS10# show startup-configuration compressed
username admin password 6q9QBeYjZ
$jfxzVqGhkxX3smxJSH9DDz7/30Jc6m5wjF8nnLD7/VKx8S1oIhp4NoGZs0I/

```

```

UNwh8WVuxwfd9q4pWigNs5BKH.
aaa authentication local
snmp-server contact http://www.dell.com/support
snmp-server location "United States"
ip route 0.0.0.0/0 10.11.58.1
!
interface range ethernet 1/1/1-1/1/32
 switchport access vlan 1
 no shutdown
!
interface vlan 1
 no shutdown
!
interface mgmt1/1/1
 ip address 10.11.58.145/8
 no shutdown
 ipv6 enable
 ipv6 address autoconfig

!
support-assist
!
policy-map type application policy-iscsi
!
class-map type application class-iscsi

```

**Supported Releases** 10.2.0E or later

## show system

Displays system information.

**Syntax** show system [brief | node-id]

**Parameters**

- **brief** — View an abbreviated list of the system information.
- **node-id** — View the node ID number.

**Default** Not configured

**Command Mode** EXEC

**Usage Information** None

**Example**

```

OS10# show system

Node Id : 1
MAC : 14:18:77:15:c3:e8
Number of MACs : 256
Up Time : 1 day 00:48:58

-- Unit 1 --
Status : up
System Identifier : 1
Down Reason : unknown
Digital Optical Monitoring : disable
System Location LED : off
Required Type : S4148F
Current Type : S4148F
Hardware Revision : X01
Software Version : 10.5.1.0
Physical Ports : 48x10GbE, 2x40GbE, 4x100GbE
BIOS : 3.33.0.0-3
System CPLD : 0.4
Master CPLD : 0.10
Slave CPLD : 0.7

```

```

-- Power Supplies --
PSU-ID Status Type AirFlow Fan Speed(rpm) Status

1 up AC NORMAL 1 13312 up
2 fail

-- Fan Status --
FanTray Status AirFlow Fan Speed(rpm) Status

1 up NORMAL 1 13195 up
2 up NORMAL 1 13151 up
3 up NORMAL 1 13239 up
4 up NORMAL 1 13239 up

```

**Example (node-id)**

```
OS10# show system node-id 1 fanout-configured
```

```

Interface Breakout capable Breakout state

Eth 1/1/5 No BREAKOUT_1x1
Eth 1/1/6 No BREAKOUT_1x1
Eth 1/1/7 No BREAKOUT_1x1
Eth 1/1/8 No BREAKOUT_1x1
Eth 1/1/9 No BREAKOUT_1x1
Eth 1/1/10 No BREAKOUT_1x1
Eth 1/1/11 No BREAKOUT_1x1
Eth 1/1/12 No BREAKOUT_1x1
Eth 1/1/13 No BREAKOUT_1x1
Eth 1/1/14 No BREAKOUT_1x1
Eth 1/1/15 No BREAKOUT_1x1
Eth 1/1/16 No BREAKOUT_1x1
Eth 1/1/17 No BREAKOUT_1x1
Eth 1/1/18 No BREAKOUT_1x1
Eth 1/1/19 No BREAKOUT_1x1
Eth 1/1/20 No BREAKOUT_1x1
Eth 1/1/21 No BREAKOUT_1x1
Eth 1/1/22 No BREAKOUT_1x1
Eth 1/1/23 No BREAKOUT_1x1
Eth 1/1/24 No BREAKOUT_1x1
Eth 1/1/25 Yes BREAKOUT_1x1

```

**Example (brief)**

```
OS10# show system brief
```

```

Node Id : 1
MAC : 14:18:77:15:c3:e8

-- Unit --
Unit Status ReqType CurType Version

1 up S4148F S4148F 10.5.1.0

-- Power Supplies --
PSU-ID Status Type AirFlow Fan Speed(rpm) Status

1 up AC NORMAL 1 13312 up
2 fail

-- Fan Status --
FanTray Status AirFlow Fan Speed(rpm) Status

1 up NORMAL 1 13195 up
2 up NORMAL 1 13151 up
3 up NORMAL 1 13239 up

```

```
4 up NORMAL 1 13239 up
```

**Supported Releases** 10.2.0E or later

## show version

Displays software version information.

**Syntax** `show version`

**Parameters** None

**Default** Not configured

**Command Mode** EXEC

**Usage Information** None

### Example

```
OS10# show version
Network Operating System
OS Version: 10.5.1.0
Build Version: 10.5.1.0.123
Build Time: 2020-02-12T02:34:02+0000
System Type: Z9100-ON
Architecture: x86_64
Up Time: 04:40:37
```

**Supported Releases** 10.2.0E or later

## start

Activates Transaction-Based Configuration mode for the active session.

**Syntax** `start transaction`

**Parameters** `transaction` - Enables the transaction-based configuration.

**Default** Not configured

**Command Mode** EXEC

**Usage Information** Use the `start` command to save changes to the candidate configuration before applying configuration changes to the running configuration.

 **NOTE:** Before you start a transaction, you must lock the session using the `lock` command in EXEC mode. Otherwise, the configuration changes from other sessions are committed.

### Example

```
OS10# start transaction
```

**Supported Releases** 10.3.1E or later

## system

Executes a Linux command from within OS10.

**Syntax** `system command`

**Parameters** `command` — Enter the Linux command to execute.

|                           |                                                                                                                                                                   |
|---------------------------|-------------------------------------------------------------------------------------------------------------------------------------------------------------------|
| <b>Default</b>            | Not configured                                                                                                                                                    |
| <b>Command Mode</b>       | EXEC                                                                                                                                                              |
| <b>Usage Information</b>  | Supported on the MX9116n and MX5108n switches in Full Switch mode starting in release 10.4.0(R3S). Also supported in SmartFabric mode starting in release 10.5.0. |
| <b>Example</b>            | <pre>OS10# system bash admin@OS10:~\$ pwd /config/home/admin admin@OS10:~\$ exit OS10#</pre>                                                                      |
| <b>Supported Releases</b> | 10.2.0E or later                                                                                                                                                  |

## system-cli disable

Disables the `system` command.

|                           |                                                                                                                                                                                                                                                         |
|---------------------------|---------------------------------------------------------------------------------------------------------------------------------------------------------------------------------------------------------------------------------------------------------|
| <b>Syntax</b>             | <code>system-cli disable</code>                                                                                                                                                                                                                         |
| <b>Parameters</b>         | None                                                                                                                                                                                                                                                    |
| <b>Default</b>            | Enabled                                                                                                                                                                                                                                                 |
| <b>Command Mode</b>       | CONFIGURATION                                                                                                                                                                                                                                           |
| <b>Usage Information</b>  | Supported on the MX9116n and MX5108n switches in Full Switch mode starting in release 10.4.3.0. Also supported in SmartFabric mode starting in release 10.5.0.<br>The <code>no</code> version of this command enables OS10 <code>system</code> command. |
| <b>Example</b>            | <pre>OS10# configure terminal OS10(config)# system-cli disable</pre>                                                                                                                                                                                    |
| <b>Supported Releases</b> | 10.4.3.0 or later                                                                                                                                                                                                                                       |

## system-user linuxadmin disable

Disables the `linuxadmin` account.

|                           |                                                                                                                                                                                                                                                                                                                                                                                                              |
|---------------------------|--------------------------------------------------------------------------------------------------------------------------------------------------------------------------------------------------------------------------------------------------------------------------------------------------------------------------------------------------------------------------------------------------------------|
| <b>Syntax</b>             | <code>system-user linuxadmin disable</code>                                                                                                                                                                                                                                                                                                                                                                  |
| <b>Parameters</b>         | None                                                                                                                                                                                                                                                                                                                                                                                                         |
| <b>Default</b>            | Not configured                                                                                                                                                                                                                                                                                                                                                                                               |
| <b>Command Mode</b>       | CONFIGURATION                                                                                                                                                                                                                                                                                                                                                                                                |
| <b>Usage Information</b>  | The <code>linuxadmin</code> account allows you to access the Linux shell. Use the <code>system-user linuxadmin disable</code> command to disable Linux shell access. You can still run Linux commands from the OS10 command-line interface using the <code>system</code> command. To disable the <code>system</code> command from executing Linux commands, use the <code>system-cli disable</code> command. |
| <b>Example</b>            | <pre>OS10(config)# system-user linuxadmin disable</pre>                                                                                                                                                                                                                                                                                                                                                      |
| <b>Supported Releases</b> | 10.4.3.0 or later                                                                                                                                                                                                                                                                                                                                                                                            |



## system identifier

Sets a non-default unit ID in a non-stacking configuration.

|                           |                                                                                                                                                                                                                                         |
|---------------------------|-----------------------------------------------------------------------------------------------------------------------------------------------------------------------------------------------------------------------------------------|
| <b>Syntax</b>             | <code>system identifier system-id</code>                                                                                                                                                                                                |
| <b>Parameters</b>         | <code>system-id</code> — Enter the system ID, from 1 to 9.                                                                                                                                                                              |
| <b>Default</b>            | Not configured                                                                                                                                                                                                                          |
| <b>Command Mode</b>       | CONFIGURATION                                                                                                                                                                                                                           |
| <b>Usage Information</b>  | The system ID displays in the stack LED on the switch front panel.<br>Supported on the MX9116n and MX5108n switches in Full Switch mode starting in release 10.4.0(R3S). Also supported in SmartFabric mode starting in release 10.5.0. |
| <b>Example</b>            | <pre>OS10(config)# system identifier 1</pre>                                                                                                                                                                                            |
| <b>Supported Releases</b> | 10.3.0E or later                                                                                                                                                                                                                        |

## terminal

Sets the number of lines to display on the terminal and enables logging.

|                           |                                                                                                                                                                                                                             |
|---------------------------|-----------------------------------------------------------------------------------------------------------------------------------------------------------------------------------------------------------------------------|
| <b>Syntax</b>             | <code>terminal {length lines   monitor}</code>                                                                                                                                                                              |
| <b>Parameters</b>         | <ul style="list-style-type: none"><li><code>length lines</code> — Enter the number of lines to display on the terminal from 0 to 512; default 24.</li><li><code>monitor</code> — Enables logging on the terminal.</li></ul> |
| <b>Default</b>            | 24 terminal lines                                                                                                                                                                                                           |
| <b>Command Mode</b>       | EXEC                                                                                                                                                                                                                        |
| <b>Usage Information</b>  | Enter zero (0) for the terminal to display without pausing.                                                                                                                                                                 |
| <b>Example</b>            | <pre>OS10# terminal monitor</pre>                                                                                                                                                                                           |
| <b>Supported Releases</b> | 10.2.0E or later                                                                                                                                                                                                            |

## traceroute

Displays the routes that packets take to travel to an IP address.

|                   |                                                                                                                                                                                                                                                                                                                                                                                                                                                                                                                                                                                                                                                                                                                                                                                 |
|-------------------|---------------------------------------------------------------------------------------------------------------------------------------------------------------------------------------------------------------------------------------------------------------------------------------------------------------------------------------------------------------------------------------------------------------------------------------------------------------------------------------------------------------------------------------------------------------------------------------------------------------------------------------------------------------------------------------------------------------------------------------------------------------------------------|
| <b>Syntax</b>     | <code>traceroute [vrf {management   vrf-name}] host [-46dFITnreAUDV] [-f first_ttl] [-g gate,...] [-i device] [-m max_ttl] [-N squeries] [-p port] [-t tos] [-l flow_label] [-w waittime] [-q nqueries] [-s src_addr] [-z sendwait] [--fwmark=num] host [packetlen]</code>                                                                                                                                                                                                                                                                                                                                                                                                                                                                                                      |
| <b>Parameters</b> | <ul style="list-style-type: none"><li><code>vrf management</code> — (Optional) Traces the route to an IP address in the management VRF instance.</li><li><code>vrf vrf-name</code> — (Optional) Traces the route to an IP address in the specified VRF instance.</li><li><code>host</code> — Enter the host to trace packets from.</li><li><code>-i interface</code> — (Optional) Enter the IP address of the interface through which traceroute sends packets. By default, the interface is selected according to the routing table.</li><li><code>-m max_ttl</code> — (Optional) Enter the maximum number of hops for the maximum time-to-live value that traceroute probes. The default is 30.</li><li><code>-p port</code> — (Optional) Enter a destination port:</li></ul> |

- For UDP tracing, enter the destination port base that traceroute uses. The destination port number is incremented by each probe.
- For ICMP tracing, enter the initial ICMP sequence value, incremented by each probe.
- For TCP tracing, enter the constant destination port to connect.
- `-P protocol` — (Optional) Use a raw packet of the specified protocol for traceroute. The default protocol is 253 (RFC 3692).
- `-s source_address` — (Optional) Enter an alternative source address of one of the interfaces. By default, the address of the outgoing interface is used.
- `-q nqueries` — (Optional) Enter the number of probe packets per hop. The default is 3.
- `-N squeries` — (Optional) Enter the number of probe packets sent out simultaneously to accelerate traceroute. The default is 16.
- `-t tos` — (Optional) For IPv4, enter the type of service (ToS) and precedence values to use. 16 sets a low delay; 8 sets a high throughput.
- `-UL` — (Optional) Use UDPLITE for tracerouting. The default port is 53.
- `-w waittime` — (Optional) Enter the time in seconds to wait for a response to a probe. The default is 5 seconds.
- `-z sendwait` — (Optional) Enter the minimal time interval to wait between probes. The default is 0. A value greater than 10 specifies a number in milliseconds, otherwise it specifies a number of seconds. This option is useful when routers rate-limit ICMP messages.
- `--mtu` — (Optional) Discovers the maximum transmission unit (MTU) from the path being traced.
- `--back` — (Optional) Prints the number of backward hops when different from the forward direction.
- `host` — (Required) Enter the name or IP address of the destination device.
- `packet_len` — (Optional) Enter the total size of the probing packet. The default is 60 bytes for IPv4 and 80 for IPv6.

**Default** Not configured

**Command Mode** EXEC

**Usage Information** None

**Example**

```
OS10# traceroute www.dell.com
traceroute to www.dell.com (23.73.112.54), 30 hops max, 60 byte packets
 1 10.11.97.254 (10.11.97.254) 4.298 ms 4.417 ms 4.398 ms
 2 10.11.3.254 (10.11.3.254) 2.121 ms 2.326 ms 2.550 ms
 3 10.11.27.254 (10.11.27.254) 2.233 ms 2.207 ms 2.391 ms
 4 Host65.hbms.com (63.80.56.65) 3.583 ms 3.776 ms 3.757 ms
 5 host33.30.198.65 (65.198.30.33) 3.758 ms 4.286 ms 4.221 ms
 6 3.GigabitEthernet3-3.GW3.SCL2.ALTER.NET (152.179.99.173) 4.428 ms
 2.593 ms 3.243 ms
 7 0.xe-7-0-1.XL3.SJC7.ALTER.NET (152.63.48.254) 3.915 ms 3.603 ms
 3.790 ms
 8 TenGigE0-4-0-5.GW6.SJC7.ALTER.NET (152.63.49.254) 11.781 ms 10.600
 ms 9.402 ms
 9 23.73.112.54 (23.73.112.54) 3.606 ms 3.542 ms 3.773 ms
```

**Example (IPv6)**

```
OS10# traceroute 20::1
traceroute to 20::1 (20::1), 30 hops max, 80 byte packets
 1 20::1 (20::1) 2.622 ms 2.649 ms 2.964 ms
```

**Supported Releases** 10.2.0E or later

## unlock

Unlocks a previously locked candidate configuration file.

**Syntax** unlock

|                           |                         |
|---------------------------|-------------------------|
| <b>Parameters</b>         | None                    |
| <b>Default</b>            | Not configured          |
| <b>Command Mode</b>       | EXEC                    |
| <b>Usage Information</b>  | None                    |
| <b>Example</b>            | <pre>OS10# unlock</pre> |
| <b>Supported Releases</b> | 10.2.0E or later        |

## username password role

Creates an authentication entry based on a user name and password, and assigns a role to the user.

|                          |                                                                                                                                                                                                                                                                                                                                                                                                                                                                                                                                                                                                                                                                                                                                                                                                                                                                                                                                                                                                                                                                                                                                                                                                                                                                                                                                                                                                                                                                                                                                                                                                                                                                                                                                                                                                                                                                                                              |
|--------------------------|--------------------------------------------------------------------------------------------------------------------------------------------------------------------------------------------------------------------------------------------------------------------------------------------------------------------------------------------------------------------------------------------------------------------------------------------------------------------------------------------------------------------------------------------------------------------------------------------------------------------------------------------------------------------------------------------------------------------------------------------------------------------------------------------------------------------------------------------------------------------------------------------------------------------------------------------------------------------------------------------------------------------------------------------------------------------------------------------------------------------------------------------------------------------------------------------------------------------------------------------------------------------------------------------------------------------------------------------------------------------------------------------------------------------------------------------------------------------------------------------------------------------------------------------------------------------------------------------------------------------------------------------------------------------------------------------------------------------------------------------------------------------------------------------------------------------------------------------------------------------------------------------------------------|
| <b>Syntax</b>            | <code>username <i>username</i> password <i>password</i> role <i>role</i> [<i>priv-lvl</i> <i>privilege-level</i>]</code>                                                                                                                                                                                                                                                                                                                                                                                                                                                                                                                                                                                                                                                                                                                                                                                                                                                                                                                                                                                                                                                                                                                                                                                                                                                                                                                                                                                                                                                                                                                                                                                                                                                                                                                                                                                     |
| <b>Parameters</b>        | <ul style="list-style-type: none"> <li>• <code>username <i>username</i></code>—Enter a text string. A maximum of 32 alphanumeric characters; one character minimum.</li> <li>• <code>password <i>password</i></code>—Enter a text string. A maximum of 32 alphanumeric characters; nine characters minimum. Password prefixes \$1\$, \$5\$, and \$6\$ are not supported in clear-text passwords.</li> <li>• <code>role <i>role</i></code>—Enter a user role: <ul style="list-style-type: none"> <li>◦ <code>sysadmin</code> — Full access to all commands in the system, exclusive access to commands that manipulate the file system, and access to the system shell. A system administrator can create user IDs and user roles.</li> <li>◦ <code>secadmin</code> — Full access to configuration commands that set security policy and system access, such as password strength, AAA authorization, and cryptographic keys. A security administrator can display security information, such as cryptographic keys, login statistics, and log information.</li> <li>◦ <code>netadmin</code> — Full access to configuration commands that manage traffic flowing through the switch, such as routes, interfaces, and ACLs. A network administrator cannot access configuration commands for security features or view security information.</li> <li>◦ <code>netoperator</code> — Access to EXEC mode to view the current configuration with limited access. A network operator cannot modify any configuration setting on a switch.</li> </ul> </li> <li>• <code>priv-lvl <i>privilege-level</i></code> — Enter a privilege level, from 0 to 15. If you do not specify the <code>priv-lvl</code> option, the system assigns privilege level 1 for the <code>netoperator</code> role and privilege level 15 for the <code>sysadmin</code>, <code>secadmin</code>, and <code>netadmin</code> roles.</li> </ul> |
| <b>Default</b>           | <ul style="list-style-type: none"> <li>• User name and password entries are in clear text.</li> <li>• There is no default user role.</li> <li>• The default privilege levels are level 1 for <code>netoperator</code>, and level 15 for <code>sysadmin</code>, <code>secadmin</code>, and <code>netadmin</code>.</li> </ul>                                                                                                                                                                                                                                                                                                                                                                                                                                                                                                                                                                                                                                                                                                                                                                                                                                                                                                                                                                                                                                                                                                                                                                                                                                                                                                                                                                                                                                                                                                                                                                                  |
| <b>Command Mode</b>      | CONFIGURATION                                                                                                                                                                                                                                                                                                                                                                                                                                                                                                                                                                                                                                                                                                                                                                                                                                                                                                                                                                                                                                                                                                                                                                                                                                                                                                                                                                                                                                                                                                                                                                                                                                                                                                                                                                                                                                                                                                |
| <b>Usage Information</b> | <p>By default, the password must be at least nine alphanumeric characters. Only the following special characters are supported:</p> <pre>! # % &amp; ' ( ) ; &lt; = &gt; [ ] * + - . / : ^ _</pre> <p>Enter the password in clear text. It is converted to SHA-512 format in the running configuration. For backward compatibility with OS10 releases 10.3.1E and earlier, passwords entered in MD-5, SHA-256, and SHA-512 format are supported.</p> <p>You cannot assign a privilege level higher than privilege level 1 to a user with the <code>netoperator</code> role and higher than privilege level 2 for a <code>sysadmin</code>, <code>secadmin</code>, and <code>netadmin</code> roles.</p> <p>To increase the required password strength, use the <code>password-attributes</code> command. The <code>no</code> version of this command deletes the authentication for a user.</p>                                                                                                                                                                                                                                                                                                                                                                                                                                                                                                                                                                                                                                                                                                                                                                                                                                                                                                                                                                                                                |

Supported on the MX9116n and MX5108n switches in Full Switch mode starting in release 10.4.0E(R3S). Also supported in SmartFabric mode starting in release 10.5.0.1.

**Example**

```
OS10(config)# username user05 password newpwd404 role sysadmin priv-lvl 10
```

**Supported Releases**

10.2.0E or later

## write

Copies the current running configuration to the startup configuration file.

**Syntax**

`write {memory}`

**Parameters**

`memory` — Copy the current running configuration to the startup configuration.

**Default**

Not configured

**Command Mode**

EXEC

**Usage Information**

This command has the same effect as the `copy running-configuration startup-configuration` command. The running configuration is not saved to a local configuration file other than the startup configuration. Use the `copy` command to save running configuration changes to a local file.

**Example**

```
OS10# write memory
```

**Supported Releases**

10.2.0E or later

## Advanced CLI tasks

- Command alias** Provides information to create shortcuts for commonly used commands, see [Command alias](#).
- Batch mode** Provides information to run a batch file to execute multiple commands, see [Batch mode](#).
- Linux shell commands** Provides information to run commands from the Linux shell, see [Linux shell commands](#).
- OS9 commands** Provides information to enter configuration commands using an OS9 command syntax, see [Using OS9 commands](#).

### Command alias

To create shortcuts for commonly used or long commands, use the `alias` command. A command alias executes long commands with parameters.

- To create a command alias that is persistent and available in other OS10 sessions, create the alias in CONFIGURATION mode.
- To create a command alias that is non-persistent and is used only in the current OS10 session, create the alias in EXEC mode. After you close the session, the alias is removed from the switch.
- Create a command alias in EXEC or CONFIGURATION mode.

```
alias alias-name alias-value
```

- The `alias-name` is case-sensitive and has a maximum of 20 characters. It does not support existing keywords, parameters, and short form of keywords.
- The `alias-value` is the CLI command executed by the alias name. To enter command parameters, enter `$n`, where `n` is a number from 1 to 9 or an asterisk (\*). Enter `*$` to enter up to nine parameters with the alias name.
- You cannot create a shortcut for the `alias` command.
- To delete an alias, use the `no alias alias-name` command.
- To view the currently configured aliases, use the `show alias [brief | detail]` command.

#### Create an alias

```
OS10# alias showint "show interface $*"
OS10(config)# alias goint "interface ethernet $1"
```

#### View alias output for showint

```
OS10# showint status
```

| Port       | Description | Status | Speed | Duplex | Mode | Vlan | Tagged-Vlans |
|------------|-------------|--------|-------|--------|------|------|--------------|
| Eth 1/1/1  |             | up     | 40G   |        | A    | 1    | -            |
| Eth 1/1/2  |             | up     | 40G   |        | A    | 1    | -            |
| Eth 1/1/3  |             | up     | 40G   |        | A    | 1    | -            |
| Eth 1/1/4  |             | up     | 40G   |        | A    | 1    | -            |
| Eth 1/1/5  |             | up     | 40G   |        | A    | 1    | -            |
| Eth 1/1/6  |             | up     | 40G   |        | A    | 1    | -            |
| Eth 1/1/7  |             | up     | 40G   |        | A    | 1    | -            |
| Eth 1/1/8  |             | up     | 40G   |        | A    | 1    | -            |
| Eth 1/1/9  |             | up     | 40G   |        | A    | 1    | -            |
| Eth 1/1/10 |             | up     | 40G   |        | A    | 1    | -            |
| ...        |             |        |       |        |      |      |              |

## View alias output for goint

```
OS10(config)# goint 1/1/1
OS10(conf-if-eth1/1/1)#
```

## View alias information

```
OS10# show alias
Name Type
---- -
govlt Config
goint Config
shconfig Local
showint Local
shver Local

Number of config aliases : 2
Number of local aliases : 3
```

## View alias information brief. Displays the first 10 characters of the alias value.

```
OS10# show alias brief
Name Type Value
---- -
govlt Config "vlt-domain..."
goint Config "interface ..."
shconfig Local "show runni..."
showint Local "show inter..."
shver Local "show versi..."

Number of config aliases : 2
Number of local aliases : 3
```

## View alias information in detail. Displays the entire alias value.

```
OS10# show alias detail
Name Type Value
---- -
govlt Config "vlt-domain $1"
goint Config "interface ethernet $1"
shconfig Local "show running-configuration"
showint Local "show interface $*"
shver Local "show version"

Number of config aliases : 2
Number of local aliases : 3
```

## Multi-line alias

You can create a multi-line alias where you save a series of multiple commands in an alias. Multi-line alias is supported only in the Configuration mode.

You cannot use the exiting CLI keywords as alias names. The alias name is case-sensitive and can have a maximum of 20 characters.

- Create a multi-line alias in CONFIGURATION mode. The switch enters the ALIAS mode.

```
alias alias-name
```

- Enter the commands to execute prefixed by the `line n` command in ALIAS mode. Enter the commands in double quotation marks and use `$n` to enter input parameters. You can substitute `$n` with either numbers ranging from 1 to 9 or with an asterisk (\*) and enter the parameters while executing the commands using the alias. When you are using asterisk (\*), you can use all the input parameters. The maximum number of input parameters is 9.

```
line nn command
```

- (Optional) You can enter the default values to use for the parameters defined as \$n in ALIAS mode.

```
default n input-value
```

- (Optional) Enter a description for the multi-line alias in ALIAS mode.

```
description string
```

- Use the no form of the command to delete an alias in CONFIGURATION mode.

```
no alias alias-name
```

You can modify an existing multi-line alias by entering the corresponding ALIAS mode.

### Create a multi-line alias

```
OS10(config)# alias mTest
OS10(config-alias-mTest)# line 1 "interface $1 $2"
OS10(config-alias-mTest)# line 2 "no shutdown"
OS10(config-alias-mTest)# line 3 "show configuration"
OS10(config-alias-mTest)# default 1 "ethernet"
OS10(config-alias-mTest)# default 2 "1/1/1"
OS10(config-alias-mTest)# description InterfaceDetails
```

### View alias output for mTest with default values

```
OS10(config)# mTest
OS10(config)# interface ethernet 1/1/1
OS10(conf-if-eth1/1/1)# no shutdown
OS10(conf-if-eth1/1/1)# show configuration
!
interface ethernet1/1/1
 no shutdown
 switchport access vlan 1
```

### View alias output for mTest with different values

```
OS10(config)# mTest ethernet 1/1/10
OS10(config)# interface ethernet 1/1/10
OS10(conf-if-eth1/1/10)# no shutdown
OS10(conf-if-eth1/1/10)# show configuration
!
interface ethernet1/1/10
 no shutdown
 switchport access vlan 1
```

### Modify an existing multi-line alias

```
OS10(config)# alias mTest
OS10(config-alias-mTest)# line 4 "exit"
```

### View the commands saved in the multi-line alias

```
OS10(config-alias-mTest)# show configuration
!
alias mTest
 description InterfaceDetails
 default 1 ethernet
 default 2 1/1/1
 line 1 "interface $1 $2"
 line 2 "no shutdown"
 line 3 "show configuration"
 line 4 exit
```

### View alias information

```
OS10# show alias
Name Type
---- -
mTest Config
```

```
Number of config aliases : 1
Number of local aliases : 0
```

**View alias information brief. Displays the first 10 characters of each line of each alias.**

```
OS10# show alias brief
Name Type Value
---- -
mTest Config line 1 "interface ..."
 line 2 "no shutdown..."
 line 3 "show confi..."
 default 1 "ethernet"
 default 2 "1/1/1"
```

```
Number of config aliases : 1
Number of local aliases : 0
```

**View alias detail. Displays the entire alias value.**

```
OS10# show alias detail
Name Type Value
---- -
mTest Config line 1 "interface $1 $2"
 line 2 "no shutdown"
 line 3 "show configuration"
 default 1 "ethernet"
 default 2 "1/1/1"
```

```
Number of config aliases : 1
Number of local aliases : 0
```

**Delete an alias**

```
OS10(config)# no alias mTest
```

## alias

Creates a command alias.

**Syntax** `alias alias-name alias-value`

**Parameters**

- *alias-name* — Enter the name of the alias. A maximum of 20 characters.
- *alias-value* — Enter the command to execute in double quotation marks, then \$ followed by either numbers ranging from 1 to 9 or an asterisk (\*) with the parameters to execute in the command. Use asterisk (\*) to represent any number of parameters.

**Default** Not configured

**Command Mode** EXEC  
CONFIGURATION

**Usage Information**

Use this command to create a shortcut to long commands along with arguments. Use the numbers 1 to 9 along with \$ to provide input parameters. The no version of this command deletes an alias.

**Example**

In this example, when you enter `showint status`, note that the text on the CLI changes to `show interface status`. The alias changes to the command specified in the alias definition.

```
OS10# alias showint "show interface $*"
OS10# showint status

Port Description Status Speed Duplex Mode Vlan Tagged-Vlans

Eth 1/1/1 up 40G A 1 -
Eth 1/1/2 up 40G A 1 -
```



```

Eth 1/1/3 up 40G A 1 -
Eth 1/1/4 up 40G A 1 -
Eth 1/1/5 up 40G A 1 -
Eth 1/1/6 up 40G A 1 -
Eth 1/1/7 up 40G A 1 -
Eth 1/1/8 up 40G A 1 -
Eth 1/1/9 up 40G A 1 -
Eth 1/1/10 up 40G A 1 -
Eth 1/1/11 up 40G A 1 -
Eth 1/1/12 up 40G A 1 -
Eth 1/1/13 up 40G A 1 -
Eth 1/1/14 up 40G A 1 -
Eth 1/1/15 up 40G A 1 -
Eth 1/1/16 up 40G A 1 -
Eth 1/1/17 up 40G A 1 -
Eth 1/1/18 up 40G A 1 -
Eth 1/1/19 up 40G A 1 -
Eth 1/1/20 up 40G A 1 -
Eth 1/1/21 up 40G A 1 -
Eth 1/1/22 up 40G A 1 -
Eth 1/1/23 up 40G A 1 -
Eth 1/1/24 up 40G A 1 -
Eth 1/1/25 up 40G A 1 -
Eth 1/1/26 up 40G A 1 -
Eth 1/1/27 up 40G A 1 -
Eth 1/1/28 up 40G A 1 -
Eth 1/1/29 up 40G A 1 -
Eth 1/1/30 up 40G A 1 -
Eth 1/1/31 up 40G A 1 -
Eth 1/1/32 up 40G A 1 -

```

In this example, when you enter `goint 1/1/1`, note that the text on the CLI changes to `interface ethernet 1/1/1`.

```

OS10(config)# alias goint "interface ethernet $1"
OS10(config)# goint 1/1/1
OS10(conf-if-eth1/1/1)#

```

**Supported Releases** 10.3.0E or later

## alias (multi-line)

Creates a multi-line command alias.

**Syntax** `alias alias-name`

**Parameters** `alias-name` — Enter the name of the multi-line alias. A maximum of up to 20 characters.

**Default** Not configured

**Command Mode** CONFIGURATION

**Usage Information** Use this command to save a series of multiple commands in an alias. The switch enters ALIAS mode when you create an alias. You can enter a series of commands to execute using the `line` command. The `no` version of this command deletes an alias.

### Example

```

OS10(config)# alias mTest
OS10(config-alias-mTest)# line 1 "interface $1 $2"
OS10(config-alias-mTest)# line 2 "no shutdown"
OS10(config-alias-mTest)# line 3 "show configuration"

```

**Supported Releases** 10.4.0E(R1) or later

## default (alias)

Configures default values for input parameters in a multi-line alias.

|                           |                                                                                                                                                                                  |
|---------------------------|----------------------------------------------------------------------------------------------------------------------------------------------------------------------------------|
| <b>Syntax</b>             | <code>default n value</code>                                                                                                                                                     |
| <b>Parameters</b>         | <ul style="list-style-type: none"><li>• <i>n</i> — Enter the number of the argument, from 1 to 9.</li><li>• <i>value</i> — Enter the value for the input parameter.</li></ul>    |
| <b>Default</b>            | Not configured                                                                                                                                                                   |
| <b>Command Mode</b>       | ALIAS                                                                                                                                                                            |
| <b>Usage Information</b>  | To use special characters in the input parameter value, enclose the string in double quotation marks ("). The <code>no</code> version of this command removes the default value. |
| <b>Example</b>            | <pre>OS10(config)# alias mTest OS10(config-alias-mTest)# default 1 "ethernet 1/1/1"</pre>                                                                                        |
| <b>Supported Releases</b> | 10.4.0E(R1) or later                                                                                                                                                             |

## description (alias)

Configures a textual description for a multi-line alias.

|                           |                                                                                                                                                                                                                                                                                                                                                                                                                                                                                                                                                                                                                                                                                                       |
|---------------------------|-------------------------------------------------------------------------------------------------------------------------------------------------------------------------------------------------------------------------------------------------------------------------------------------------------------------------------------------------------------------------------------------------------------------------------------------------------------------------------------------------------------------------------------------------------------------------------------------------------------------------------------------------------------------------------------------------------|
| <b>Syntax</b>             | <code>description string</code>                                                                                                                                                                                                                                                                                                                                                                                                                                                                                                                                                                                                                                                                       |
| <b>Parameters</b>         | <i>string</i> — Enter a text string for a multi-line alias description.                                                                                                                                                                                                                                                                                                                                                                                                                                                                                                                                                                                                                               |
| <b>Default</b>            | Not configured                                                                                                                                                                                                                                                                                                                                                                                                                                                                                                                                                                                                                                                                                        |
| <b>Command Mode</b>       | ALIAS                                                                                                                                                                                                                                                                                                                                                                                                                                                                                                                                                                                                                                                                                                 |
| <b>Usage Information</b>  | <ul style="list-style-type: none"><li>• To use special characters as a part of the description string, enclose the string in double quotation marks (").</li><li>• To use comma as a part of the description string add double back slash before the comma.</li><li>• Spaces between characters are not preserved after entering this command unless you enclose the entire description in quotation marks, for example, "<i>text description</i>."</li><li>• To overwrite any previous text strings that you configured as the description, enter a text string after the <code>description</code> command.</li><li>• The <code>no</code> version of this command removes the description.</li></ul> |
| <b>Example</b>            | <pre>OS10(config)# alias mTest OS10(config-alias-mTest)# description "This alias configures interfaces"</pre>                                                                                                                                                                                                                                                                                                                                                                                                                                                                                                                                                                                         |
| <b>Supported Releases</b> | 10.4.0E(R1) or later                                                                                                                                                                                                                                                                                                                                                                                                                                                                                                                                                                                                                                                                                  |

## line (alias)

Configures the commands to execute in a multi-line alias.

|                     |                                                                                                                                                                                                                                                                |
|---------------------|----------------------------------------------------------------------------------------------------------------------------------------------------------------------------------------------------------------------------------------------------------------|
| <b>Syntax</b>       | <code>line nn command</code>                                                                                                                                                                                                                                   |
| <b>Parameters</b>   | <ul style="list-style-type: none"><li>• <i>nn</i> — Enter the line number, from 1 to 99. The commands are executed in the order of the line numbers.</li><li>• <i>command</i> — Enter the command to execute enclosed in double quotation marks (").</li></ul> |
| <b>Default</b>      | Not configured                                                                                                                                                                                                                                                 |
| <b>Command Mode</b> | ALIAS                                                                                                                                                                                                                                                          |

**Usage Information**

The no version of this command removes the line number and the corresponding command from the multi-line alias.

**Example**

```
OS10(config)# alias mTest
OS10(config-alias-mTest)# line 1 "interface $1 $2"
OS10(config-alias-mTest)# line 2 "no shutdown"
OS10(config-alias-mTest)# line 3 "show configuration"
```

**Supported Releases**

10.4.0E(R1) or later

## show alias

Displays configured alias commands available in both Persistent and Non-Persistent modes.

**Syntax** show alias [brief | detail]

**Parameters**

- brief — Displays brief information of the aliases.
- detail — Displays detailed information of the aliases.

**Default** None

**Command Mode** EXEC

**Usage Information** None

**Example**

```
OS10# show alias
Name Type
---- -
govlt Config
goint Config
mTest Config
shconfig Local
showint Local
shver Local
Number of config aliases : 3
Number of local aliases : 3
```

**Example (brief — displays the first 10 characters of the alias value)**

```
OS10# show alias brief
Name Type Value
---- -
govlt Config "vlt-domain..."
goint Config "interface ..."
mTest Config line 1 "interface ..."
 line 2 "no shutdow..."
 line 3 "show confi..."
 default 1 "ethernet"
 default 2 "1/1/1"
shconfig Local "show runni..."
showint Local "show inter..."
shver Local "show versi..."

Number of config aliases : 3
Number of local aliases : 3
```

**Example (detail — displays the entire alias value)**

```
OS10# show alias detail
Name Type Value
---- -
govlt Config "vlt-domain $1"
goint Config "interface ethernet $1"
mTest Config line 1 "interface $1 $2"
 line 2 "no shutdown"
 line 3 "show configuration"
 default 1 "ethernet"
```

```

shconfig Local default 2 "1/1/1"
showint Local "show running-configuration"
shver Local "show interface $*"
 Local "show version"

Number of config aliases : 3
Number of local aliases : 3

```

**Supported Releases** 10.3.0E or later

## Batch mode

To execute a sequence of multiple commands, create and run a batch file. A batch file is an unformatted text file that contains two or more commands. Store the batch file in the home directory.

Use the vi editor or any other editor to create the batch file, then use the `batch` command to run the file. To run a series of commands in batch mode (non-interactive processing), use the `batch` command. OS10 automatically commits all commands in a batch file — you do not have to enter the `commit` command.

If a command in the batch file fails, batch operation stops at that command. The remaining commands are not executed.

- Create a batch file — for example, `b.cmd` — on a remote device by entering a series of commands.

```

interface ethernet 1/1/1
no shutdown
no switchport
ip address 172.17.4.1/24

```

- Copy the command file to the home directory on the switch.

```

OS10# copy scp://os10user:os10passwd@10.11.222.1/home/os10/b.cmd home://b.cmd

OS10# dir home

Directory contents for folder: home
Date (modified) Size (bytes) Name

2017-02-15T19:25:35Z 77
b.cmd
...

```

- Execute the batch file using the `batch /home/username/filename` command in EXEC mode.

```

OS10# batch /home/admin/b.cmd
Jun 26 18:29:12 OS10 dn_13_core_services[723]: Node.1-Unit.1:PRI:notice [os10:trap],
%Dell EMC (OS10) %log-notice:IP_ADDRESS_ADD: IP Address add is successful.
IP 172.17.4.1/24 in VRF:default added successfully

```

- (Optional) Verify the new commands in the running configuration.

```

OS10# show running-configuration interface ethernet 1/1/1
!
interface ethernet1/1/1
no shutdown
no switchport
ip address 172.17.4.1/24

```

## batch

Executes a series of commands in a batch file using non-interactive processing.

**Syntax** `batch {string | /home/filepath | config://filepath}`

**Parameters**

- `string` — Enter the batch file name.

- `/home/filepath` — Enter the username and the filepath as follows: `batch /home/username/filename`.
- `config://filepath` — Enter the filepath.

**Default** Not configured

**Command Mode** EXEC

**Usage Information** Use this command to create a batch command file on a remote machine. Copy the command file to the home directory on your switch. This command executes commands in batch mode. OS10 automatically commits all commands in a batch file; you do not have to enter the `commit` command. To display the files stored in the home directory, enter `dir home`. To view the files stored in the home directory, use the `dir home` command.

**Example**

```
batch /home/admin/b.cmd
Jun 26 18:29:12 OS10 dn_13_core_services[723]: Node.1-Unit.1:PRI:notice
[os10:trap],
%Dell EMC (OS10) %log-notice:IP_ADDRESS_ADD: IP Address add is
successful.
IP 172.17.4.1/24 in VRF:default added successfully
```

**Supported Releases** 10.2.0E or later

## Linux shell commands

From the Linux shell, you can run a single command or a series of commands in a batch file.

**Linux command examples**

- Use the `-c` option to run a single command.

```
admin@OS10:/opt/dell/os10/bin$ clish -c "show version"

New user admin logged in at session 10
Network Operating System
OS Version: 10.5.1.0
Build Version: 10.5.1.0.123
Build Time: 2020-02-12T02:34:02+0000
System Type: Z9100-ON
Architecture: x86_64
Up Time: 05:40:23

User admin logged out at session 10
admin@OS10:/opt/dell/os10/bin$
```

- Use the `-B` option to run a batch file with a series of commands.
  - Create a batch file — for example, `batch_cfg.txt` — with a series of executable commands.

```
configure terminal
router bgp 100
neighbor 100.1.1.1
remote-as 104
no shutdown
```

- Execute the batch file.

```
admin@OS10:/opt/dell/os10/bin$ clish -B ~/batch_cfg.txt

New user admin logged in at session 15
```

- Verify the BGP settings configured by the batch file.

```
admin@OS10:/opt/dell/os10/bin$ clish -c "show running-configuration bgp"
```

```

New user admin logged in at session 16
!
router bgp 100
!
 neighbor 100.1.1.1
 remote-as 104
 no shutdown
admin@OS10:/opt/dell/os10/bin$

User admin logged out at session 16

```

- Use the `ifconfig -a` command to display the interface configuration. The Linux kernel port numbers that correspond to front-panel port, port-channel, and VLAN interfaces are displayed. Port-channel interfaces are in `boportchannel-number` format. VLAN interfaces are in `brvlan-id` format. In this example, `e101-001-0` identifies port 1/1/1.

```

admin@OS10:~# ifconfig -a
e101-001-0: flags=4163<UP,BROADCAST,RUNNING,MULTICAST> mtu 1500
 inet6 fe80::20c:29ff:feed:9ea9 prefixlen 64 scopeid 0x20<link>
 ether 00:0c:29:ed:9e:a9 txqueuelen 1000 (Ethernet)
 RX packets 266262 bytes 18763391 (17.8 MiB)
 RX errors 0 dropped 8293 overruns 0 frame 0
 TX packets 18754 bytes 3963136 (3.7 MiB)
 TX errors 0 dropped 0 overruns 0 carrier 0 collisions 0

bo1: flags=5123<UP,BROADCAST,MASTER,MULTICAST> mtu 1500 >>> port-channel
 inet6 fe80::20c:29ff:feed:9f11 prefixlen 64 scopeid 0x20<link>
 ether 00:0c:29:ed:9f:11 txqueuelen 1000 (Ethernet)
 RX packets 0 bytes 0 (0.0 B)
 RX errors 0 dropped 0 overruns 0 frame 0
 TX packets 0 bytes 0 (0.0 B)
 TX errors 0 dropped 1 overruns 0 carrier 0 collisions 0

br1: flags=4419<UP,BROADCAST,RUNNING,PROMISC,MULTICAST> mtu 1500 >>> vlan1
 inet6 fe80::20c:29ff:feed:9f12 prefixlen 64 scopeid 0x20<link>
 ether 00:0c:29:ed:9f:12 txqueuelen 1000 (Ethernet)
 RX packets 257964 bytes 12155776 (11.5 MiB)
 RX errors 0 dropped 0 overruns 0 frame 0
 TX packets 10287 bytes 900262 (879.1 KiB)
 TX errors 0 dropped 0 overruns 0 carrier 0 collisions 0

```

- Use the `tcpdump -i kernel-port-number` command to capture all packets received on a specified port interface. Press **Ctrl+C** to stop the packet output display. For example, to capture the packets received on the Ethernet 1/1/1 interface, enter:

```

admin@OS10:~# tcpdump -i e101-001-0
tcpdump: verbose output suppressed, use -v or -vv for full protocol decode
listening on e101-001-0, link-type EN10MB (Ethernet), capture size 262144 bytes
11:35:07.538133 STP 802.1w, Rapid STP, Flags [Learn, Forward, Agreement], bridge-id
8001.00:0c:29:74:3b:7e.8204, length 43
11:35:07.538467 STP 802.1w, Rapid STP, Flags [Learn, Forward, Agreement], bridge-id
8001.00:0c:29:74:3b:7e.8204, length 43
11:35:08.416291 LLDP, length 343: OS10
11:35:09.067621 IP6 fe80::20c:29ff:feed:9f12 > ff02::1:ffed:9ea9: ICMP6, neighbor
solicitation, who has fe80::20c:29ff:feed:9ea9, length 32
^C
4 packets captured
4 packets received by filter
0 packets dropped by kernel
1 packet dropped by interface
root@OS10:~#

```

- Run `show` commands remotely using an SSH session. Only `show` commands are supported. Enter the `$ ssh admin@ip-address "show-command"` command, where `ip-address` is the IP address of the switch.

```

$ ssh admin@10.11.98.39 "show version"
admin@10.11.98.39's password:
Network Operating System
OS Version: 10.5.1.0
Build Version: 10.5.1.0.123
Build Time: 2020-02-12T02:34:02+0000

```

```
System Type: Z9100-ON
Architecture: x86_64
Up Time: 05:40:23
```

## Using OS9 commands

To enter configuration commands using an OS9 command syntax, use the `feature config-os9-style` command in CONFIGURATION mode and log out of the session. If you do not log out of the OS10 session, configuration changes made with OS9 command syntaxes do not take effect. After you log in again, you can enter OS9 commands, but only in the new session.

For example, to use OS9 commands to configure VLAN 11 on Ethernet port 1/1/15:

```
OS10(config)# feature config-os9-style
OS10(config)# interface vlan 11
OS10(conf-if-vl-11)# tagged ethernet 1/1/15

OS10(conf-if-vl-11)# show configuration
!
interface vlan11
 no shutdown
 tagged ethernet 1/1/15
```

To disable OS9 configuration-style mode, use the `no feature config-os9-style` command.

## feature config-os9-style

Enables the command-line interface to accept OS9 command syntaxes.

**Syntax** `feature config-os9-style`

**Parameters** None

**Default** Not configured

**Command Mode** CONFIGURATION

**Usage Information** After you enter the `feature config-os9-style` command, log out of the session and log back in. In the next session, you can enter configuration commands in OS9 syntax. The `no` version of the command disables the feature.

### Example

```
OS10(config)# feature config-os9-style
OS10(config)# interface vlan 11
OS10(conf-if-vl-11)# tagged ethernet 1/1/15
```

**Supported Releases** 10.3.0E or later

# Dell EMC SmartFabric OS10 zero-touch deployment

Zero-touch deployment (ZTD) allows OS10 users to automate switch deployment:

- Upgrade an existing OS10 image.
- Execute a CLI batch file to configure the switch.
- Execute a post-ZTD script to perform additional functions.

ZTD is enabled by default when you boot up a switch with a factory-installed OS10 for the first time or when you perform an `ONIE: OS Install` from the ONIE boot menu. When a switch boots up with OS10 in ZTD mode, it starts the DHCP client on all interfaces — management and front-panel ports. ZTD configures all interfaces for untagged VLAN traffic. The switch obtains an IP address and a ZTD provisioning script URL from a DHCP server running on the network, and downloads and executes the ZTD script.

**NOTE:** Zero-touch deployment refers to an OS10 feature, and not the ONIE automated provisioning.

- ZTD is supported only in an IPv4 network. ZTD is not supported by DHCPv6.
- ZTD is not supported if PowerEdge MX Ethernet switches operate in SmartFabric mode.
- If the switch accesses the DHCP server using a front-panel port, the port interface must be in non-breakout mode.
- At least one of the front-panel ports connected to the network on which the DHCP server is running must be in non-breakout mode.
- After booting up in ZTD mode, if a switch receives no DHCP server response with option 240 within five minutes, it automatically exits ZTD mode. During this time, you can abort ZTD by entering the `ztd cancel` command. The command unlocks the switch configuration so that you can enter OS10 CLI commands.
- When ZTD is enabled, the CLI is locked so you cannot enter OS10 configuration commands. Only the `show` commands are available.

According to the contents of the provisioning script, ZTD performs these tasks in the following sequence. Although Steps 2, 3 and 4 are optional, you must enter a valid URL path for at least one of the `IMG_FILE`, `CLI_CONFIG_FILE`, and `POST_SCRIPT_FILE` variables. For example, if you only want to configure the switch, enter only a `CLI_CONFIG_FILE` URL value. In this case, ZTD does not upgrade the OS10 image and does not execute a post-ZTD script.

1. ZTD downloads the files specified in the ZTD provisioning script — OS10 image, CLI configuration batch file, and post-ZTD script.
  - In the provisioning script, enter the file names for the `IMG_FILE`, `CLI_CONFIG_FILE`, and `POST_SCRIPT_FILE` variables as shown in [ZTD provisioning script](#).
  - If no file names are specified, OS10 immediately exits ZTD and returns to CLI Configuration mode.
  - If the download of any of the specified files fails, ZTD stops. OS10 exits ZTD and unlocks CLI Configuration mode.
2. If you specify an OS10 image for `IMG_FILE`, ZTD installs the standby image. If you do not specify a configuration file for `CLI_CONFIG_FILE`, ZTD reloads the switch with the new OS10 image.
3. If you specify an OS10 CLI batch file with configuration commands for `CLI_CONFIG_FILE`, ZTD executes the commands in the `PRE-CONFIG` and `POST-CONFIG` sections. After executing the `PRE-CONFIG` commands, the switch reloads with the new OS10 image and then executes the `POST-CONFIG` commands. For more information, see [ZTD CLI batch file](#).
4. If you specify a post-ZTD script file for `POST_SCRIPT_FILE`, ZTD executes the script. For more information, see [Post-ZTD script](#).

**NOTE:** The ZTD process performs a single switch reboot. The switch reboot occurs only if either a new OS10 image is installed or if the `PRE-CONFIG` section of the CLI batch file has configuration commands that are executed.

## ZTD prerequisites

- Store the ZTD provisioning script on a server that supports HTTP connections.
- Store the OS10 image, CLI batch file, and post-ZTD script on a file server that supports either HTTP, FTP, SFTP, or TFTP connections.
- Configure the DHCP server to provide option 240 that returns the URL of the ZTD provisioning script.



- In the ZTD provisioning script, enter the URL locations of an OS10 image, CLI batch file, and/or post-ZTD script. Enter at least one URL, otherwise the ZTD fails and exits to CLI Configuration mode.

### ZTD guidelines

- You can store the ZTD provisioning script, OS10 image, CLI batch file, and post-ZTD script on the same server, including the DHCP server.
- Write the ZTD provisioning script in bash.
- Write the post-ZTD script in bash or Python. Enter `#!/bin/bash` or `#!/usr/bin/python` as the first line in the script. The default python interpreter in OS10 is 2.7.

Use only common Linux commands, such as `curl`, and common Python language constructs. OS10 only provides a limited set of Linux packages and Python libraries.

- ZTD is disabled by default on automatically provisioned switch fabrics, such as Isilon backend, PowerEdge MX, and VxRail.

### Cancel ZTD in progress

To exit ZTD mode and manually configure a switch by entering CLI commands, stop the ZTD process by entering the `ztd cancel` command. You can enter `ztd cancel` only when ZTD is in a waiting state; that is, before it receives an answer from the DHCP server. Otherwise, the command returns an error message; for example:

```
OS10# ztd cancel
% Error: ZTD cancel failed. ZTD process already started and cannot be cancelled at this stage.
```

### Disable ZTD

To disable ZTD, enter the `reload` command. The switch reboots in ZTD disabled mode.

### Re-enable ZTD

To automatically upgrade OS10 and/or activate new configuration settings, re-enable ZTD by rebooting the switch using the `reload ztd` command. You are prompted to confirm the deletion of the startup configuration.

**NOTE:** To upgrade OS10 without losing the startup configuration, back up the startup configuration before ZTD runs the provisioning script. Then use the backup startup configuration to restore the previous system configuration.

```
OS10# reload ztd
This action will remove startup-config [confirm yes/no]:
```

### View ZTD status

```
OS10# show ztd-status

ZTD Status : disabled
ZTD State : completed
Protocol State : idle
Reason : ZTD process completed successfully at Mon Jul 16 19:31:57 2018

```

### ZTD logs

ZTD generates log messages about its current status.

```
[os10:notify], %Dell EMC (OS10) %ZTD-IN-PROGRESS: Zero Touch Deployment
applying post configurations.
```

ZTD also generates failure messages.

```
[os10:notify], %Dell EMC (OS10) %ZTD-FAILED: Zero Touch Deployment failed to
download the image.
```

### Troubleshoot configuration locked

When ZTD is enabled, the CLI configuration is locked. If you enter a CLI command, the error message configuration is locked displays. To configure the switch, disable ZTD by entering the `ztd cancel` command.

```
OS10# configure terminal
% Error: ZTD is in progress(configuration is locked).
OS10# ztd cancel
```

## ZTD DHCP server configuration

For ZTD operation, configure a DHCP server in the network by adding the required ZTD options; for example:

```
option domain-name "example.org";
option domain-name-servers ns1.example.org, ns2.example.org;
option ztd-provision-url code 240 = text;

default-lease-time 600;
max-lease-time 7200;

subnet 50.0.0.0 netmask 255.255.0.0 {
 range 50.0.0.10 50.0.0.254;
 option routers rtr-239-0-1.example.org, rtr-239-0-2.example.org;
}

host ztd-leaf1 {
 hardware ethernet 90:b1:1c:f4:a9:b1;
 fixed-address 50.0.0.8;
 option ztd-provision-url "http://50.0.0.1/ztd.sh";
}
```

## ZTD provisioning script

Create a ZTD script file that you store on an HTTP server. Configure the URL of the script using DHCP option 240 (`ztd-provision-url`) on the DHCP server.

ZTD downloads and runs the script to upgrade the OS10 image, configure the switch, and run a post-ZTD script to perform other functions.

- Write the ZTD provisioning script in bash. Enter `#!/bin/bash` as the first line in the script. You can use the sample script in this section as a basis.
- For `IMG_FILE`, enter the URL path of the OS10 image to download and upgrade the switch. This image becomes the standby image.
- For `CLI_CONFIG_FILE`, enter the URL path of the CLI batch file to download and run.
- For `POST_SCRIPT_FILE`, enter the URL path of the script to run.
- ZTD requires all the ZTD scripts (provisioning, CLI batch file, and post-ZTD script) to be Unix-style line formatted.
- ZTD fails and exits to CLI Configuration mode if:
  - You do not specify at least one valid URL for the `IMG_FILE`, `CLI_CONFIG_FILE`, and `POST_SCRIPT_FILE` variables.
  - Any of the `IMG_FILE`, `CLI_CONFIG_FILE`, and `POST_SCRIPT_FILE` entries are invalid or if specified, the files cannot be downloaded.

For the `IMG_FILE`, `CLI_CONFIG_FILE`, and `POST_SCRIPT_FILE` files, you can specify HTTP, SCP, SFTP, or TFTP URLs. For example:

```
scp://userid:passwd@hostip/filepath
sftp://userid:passwd@hostip/filepath
```

### Example

```
#!/bin/bash

#####
#
#
```

```

Example OS10 ZTD Provisioning Script
#
#
#####

UPDATE THE BELOW CONFIG VARIABLES ACCORDINGLY
ATLEAST ONE OF THEM SHOULD BE FILLED

IMG_FILE="http://50.0.0.1/OS10.bin"
CLI_CONFIG_FILE="http://50.0.0.1/cli_config"
POST_SCRIPT_FILE="http://50.0.0.1/no_post_script.py"

DO NOT MODIFY THE LINES BELOW

sudo os10_ztd_start.sh "$IMG_FILE" "$CLI_CONFIG_FILE" "$POST_SCRIPT_FILE"

END

```

## ZTD CLI batch file

Create a CLI batch file that ZTD downloads and executes to configure a switch. The ZTD CLI batch file consists of two sections: PRE-CONFIG and POST-CONFIG.

When you enter the PRE-CONFIG and POST-CONFIG lines, you must enter a hash tag (#), followed by a space before the text PRE-CONFIG or POST-CONFIG. If the PRE-CONFIG section has no commands, do not leave a blank line between # PRE-CONFIG and # POST-CONFIG; for example:

```

PRE-CONFIG
POST-CONFIG
Hostname VxRail-fabric-LEAF-1
!
lldp enable
!
spanning-tree mode rstp
spanning-tree rstp priority 0
...

```

ZTD executes the PRE-CONFIG commands first using the currently running OS10 image, not the OS10 image specified in the provisioning script. ZTD saves the PRE-CONFIG settings to the startup configuration.

If PRE-CONFIG commands are present, ZTD reloads the switch before executing the commands in the POST-CONFIG section. Enter OS10 configuration commands that require a switch reload, such as `switch-port-profile`, in the PRE-CONFIG section. If ZTD installs a new OS10 image (`IMG_FILE`), the new image is activated after the reload.

ZTD then executes the POST-CONFIG commands and saves the new settings in the startup configuration. No additional switch reload is performed. Enter POST\_CONFIG commands with the exact syntax displayed in `show running-configuration` output.

### Example

```

PRE-CONFIG
switch-port-profile 1/1 profile-2

POST-CONFIG
snmp-server community public ro
snmp-server contact NOC@dell.com
snmp-server location delltechworld
!
clock timezone GMT 0 0
!
hostname LEAF-1
!
ip domain-list networks.dell.com
ip name-server 8.8.8.8 1.1.1.1
!
ntp server 132.163.96.5 key 1 prefer
ntp server 129.6.15.32
!

```

```
!
logging server 10.22.0.99
```

## Post-ZTD script

As a general guideline, use a post-ZTD script to perform any additional functions required to configure and operate the switch. In the ZTD provisioning script, specify the post-ZTD script path for the `POST_SCRIPT_FILE` variable. You can use a script to notify an orchestration server that the ZTD configuration is complete. The server can then configure additional settings on the switch.

For example, during the ZTD phase, you can configure only a management VLAN and IP address, then allow an Ansible orchestration server to perform complete switch configuration. Here is a sample curl script that is included in the post-ZTD script to contact an Ansible server:

```
/usr/bin/curl -H "Content-Type:application/json" -k -X POST
--data '{"host_config_key":"'7d07e79ebdc8f7c292e495daac0fe16b'"}'
-u admin:admin_https://10.16.134.116/api/v2/job_templates/9/callback/
```

## ZTD commands

### reload ztd

Reboots the switch and enables ZTD after the reload.

|                           |                                                                                                                                                                                                               |
|---------------------------|---------------------------------------------------------------------------------------------------------------------------------------------------------------------------------------------------------------|
| <b>Syntax</b>             | reload ztd                                                                                                                                                                                                    |
| <b>Parameters</b>         | None                                                                                                                                                                                                          |
| <b>Default</b>            | ZTD is enabled.                                                                                                                                                                                               |
| <b>Command Mode</b>       | EXEC                                                                                                                                                                                                          |
| <b>Usage Information</b>  | Use the <code>reload ztd</code> command to automatically upgrade OS10 and/or activate new configuration settings. When you reload ZTD, you are prompted to confirm the deletion of the startup configuration. |
| <b>Example</b>            | <pre>OS10# reload ztd</pre>                                                                                                                                                                                   |
| <b>Supported Releases</b> | 10.4.1.0 or later                                                                                                                                                                                             |

### show ztd-status

Displays the current ZTD status: enabled, disabled, or canceled.

|                          |                                                                                                                       |
|--------------------------|-----------------------------------------------------------------------------------------------------------------------|
| <b>Syntax</b>            | show ztd-status                                                                                                       |
| <b>Parameters</b>        | None                                                                                                                  |
| <b>Default</b>           | None                                                                                                                  |
| <b>Command Mode</b>      | EXEC                                                                                                                  |
| <b>Usage Information</b> | None                                                                                                                  |
| <b>Examples</b>          | <pre>OS10# show ztd-status  ----- ZTD Status      : disabled ZTD State       : completed Protocol State  : idle</pre> |

```
Reason : ZTD process completed successfully at Mon Jul 16
19:31:57 2018

```

```
OS10# show ztd-status
```

```

ZTD Status : disabled
ZTD State : failed
Protocol State : idle
Reason : ZTD process failed to download post script file

```

- **ZTD Status** — Current operational status: enabled or disabled.
- **ZTD State** — Current ZTD state: initialized, in-progress, successfully completed, failed, or canceled while in progress.
- **Protocol State** — Current state of ZTD protocol: initialized, idle while waiting to enable or complete ZTD process, waiting for DHCP post-hook callback, downloading files, installing image, executing pre-config or post-config CLI commands, or executing post-ZTD script file.
- **Reason** — Description of a successful or failed ZTD process.

### Supported Releases

10.4.1.0 or later

## ztd cancel

Stops ZTD while in progress.

**Syntax**            `ztd cancel`

**Parameters**        None

**Default**            ZTD is enabled.

**Command Mode**      EXEC

**Usage Information**    After you cancel ZTD, you can enter CLI commands to configure the switch.

When ZTD is enabled, the command-line interface is locked. You cannot enter OS10 configuration commands. Use the `ztd cancel` command to cancel the ZTD process and return to CLI Configuration mode. You can enter this command only when ZTD is in a waiting state; that is, before it receives an answer from the DHCP server. Otherwise, the command returns an error message.

### Example

```
OS10# ztd cancel
```

### Supported Releases

10.4.1.0 or later

# Dell EMC SmartFabric OS10 provisioning

OS10 supports automated switch provisioning — configuration and monitoring — using:

- RESTCONF API — REST-like protocol that uses HTTPS connections. Use the OS10 RESTCONF API to set up the configuration parameters on OS10 switches with JavaScript Object Notation (JSON)-structured messages. You can use any programming language to create and send JSON messages; see [RESTCONF API](#).
- Linux DevOps ecosystem — OS10 provides access to an unmodified Linux (Debian) operating system that allows you to benefit from the Linux DevOps ecosystem. Programmers can write applications in Python or C/C++ to execute on an OS10 switch.
- Ansible — Third-party DevOps tool. Ansible is a powerful, open-source IT automation engine that provides a simple way to automate application software and IT infrastructure. Ansible allows you to remove complexity from these environments and accelerate DevOps initiatives; see [Using Ansible](#) and [Example: Configure OS10 switch using Ansible](#).

## Using Ansible

Ansible works by connecting to your nodes using SSH and pushing out small programs, called *Ansible modules*, to them. Ansible includes hundreds of network modules to support a wide variety of network device vendors. Ansible uses a simple, powerful and agentless automation framework. For more information, go to [Network Automation with Ansible](#).

### Dell EMC Networking Ansible solutions

Dell EMC Networking Ansible solutions are based on an open ecosystem that allows organizations to choose from industry-standard network applications, network operating systems, and network hardware. Use Ansible to provision and manage Dell EMC switches for rapid new device deployment and network configuration changes. Ansible also allows you to track running network device configurations against a known baseline for both Dell EMC and third-party operating systems.

The Ansible modules for Dell EMC Networking solutions allow organizations to reduce the time and effort required to design, provision, and manage networks by providing these benefits:

- Agentless — No new software is required to install on switches.
- Powerful — End-to-end automation of the configuration of bare metal switches using the Dell EMC Open Automation framework.
- Easy-to-use — Dell EMC Networking modules ship with the Ansible distribution. There is nothing extra to install.
- Best practice — Uses CLI user authentication to centralize and monitor session management.

### Dell EMC Networking Ansible modules

Ansible ships with a number of modules that can be executed directly on remote hosts or through playbooks. The collection of modules is called the *module library*. Modules are discrete units of code that are used from the command line or in a playbook task. You can also write your own modules.

Starting with Ansible 2.2, the Ansible core supports Dell EMC Networking modules. Use these modules to manage and automate Dell EMC switches running OS6, OS9, and OS10. Dell EMC Networking modules are executed in local connection mode using CLI and SSH transport. The following OS10 modules are integrated into the Ansible core:

- `delloos10_command`: Runs show commands or EXEC mode commands through Ansible. For example, `show version` command output displays the current OS version running on a switch.
- `delloos10_config`: Runs OS10 configuration commands through Ansible.
- `delloos10_facts`: Retrieves the running configuration from an OS10 switch.

### Dell EMC Networking Ansible roles

Ansible roles allow you to automatically load variable files (`vars_files`) and tasks based on a known file structure. Grouping content by roles allows the roles to be easily shared with other users. These roles are abstracted for OS6, OS9 and OS10. Download Dell EMC Ansible Networking roles from <https://galaxy.ansible.com/>.

For information and examples about how to use the Ansible roles, see [Dell EMC Networking Repositories](#).

### Ansible inventory file

The inventory file contains the list of hosts on which you want to run commands. Ansible can run tasks on multiple hosts at the same time.

Ansible playbooks use `/etc/ansible/hosts` as the default inventory file. To specify a different inventory file, use the `-i filepath` command as an option when you run an Ansible playbook.

### Ansible playbook file

Using playbooks, Ansible can configure multiple devices. Playbooks are human-readable scripts that are expressed in YAML format. An Ansible playbook takes inventory and playbook files as arguments and maps the group of hosts in the inventory files to the tasks listed in the playbook file.

### Ansible variables

In Ansible, variables define switch configurations. Many Dell EMC switches have common configurations. Common configuration variables are stored in the `vars/main.yaml` file; for example, `dns_server` and `ntp_server`. All host-specific configurations are stored in the `host_vars/host_name.yaml` configuration file; for example, the hostname of a switch. Variables are also used as part of playbook definitions, command-line arguments, and inventory definitions.

## Example: Configure an OS10 switch using Ansible

OS10 supports Ansible integration to automate switch configuration. For detailed information about how to use Ansible scripts and create Ansible playbooks, go to:

- [Dell EMC Ansible Documentation](#)
- [Dell EMC Networking Guides](#) and search for `Ansible`

You can download auto-generated Ansible configuration files for the network design you provide from the [Dell EMC Fabric Design Center](#).

### Before you start

Before you configure an OS10 switch using Ansible, configure basic network settings on your switch, such as assigning an IP address and default gateway to the management interface:

1. Connect a terminal emulator to the console serial port on the switch using a serial cable. The serial port settings are 115200, 8 data bits, and no parity.
2. Configure the management interface; for example:

```
OS10(config)# interface mgmt 1/1/1
OS10(conf-if-ma-1/1/1)# no ip address dhcp
OS10(conf-if-ma-1/1/1)# ip address 10.1.1.10/24
OS10(conf-if-ma-1/1/1)# no shutdown
OS10(conf-if-ma-1/1/1)# exit
OS10(config)# management route 10.10.20.0/24 10.1.1.1
OS10(config)# end
```

### Ansible configuration example

In this example, the configuration uses Ansible roles to configure an OS10 switch from an Ansible controller node with:

- User name and password
  - NTP server
  - Syslog server
1. Install Ansible on a controller node. You can find the latest version of Ansible on the [Ansible Installation Guide](#) page.

You can run Ansible from any device with Python 2 (version 2.7) or Python 3 (version 3.5 or higher) installed, including Red Hat, Debian, Ubuntu, CentOS, OS X, any of the BSDs and so on.

In this example, Ansible 2.7.12 is installed on an Ubuntu 16.04 virtual machine. To configure the Personal Package Archives (PPA) repository on the controller node and install Ansible, run these commands:

```
sudo apt-get update
sudo apt-get install software-properties-common
sudo apt-add-repository --yes --update ppa:ansible/ansible
sudo apt-get install ansible
```

After you install Ansible, verify the version by entering:

```
$ ansible --version
```

2. Download and install Dell EMC Networking Ansible roles from the [Ansible Galaxy](#) web page; for example:

```
$ ansible-galaxy install dell-networking.dellos-users
$ ansible-galaxy install dell-networking.dellos-logging
$ ansible-galaxy install dell-networking.dellos-ntp
```

3. Create a directory to store inventory and playbook files; for example:

```
$ mkdir AnsibleOS10
```

4. Navigate to the directory and create an inventory file.

```
$ cd AnsibleOS10/
$ vim inventory.yaml
```

5. Add the IP address and OS for each switch in the `inventory.yaml` file. Enter the command for each switch on one command line.

```
OS10switch-1 ansible_host=192.168.1.203 ansible_network_os=dellos10
OS10switch-2 ansible_host=192.168.1.204 ansible_network_os=dellos10
```

6. Create a `host_vars` directory to use for switch-specific variable files.

```
$ mkdir host_vars
```

7. Create a host variable file; for example, `host_vars/OS10switch-1.yaml`. Then define the host name and login credentials:

```
$ vim host_vars/OS10switch-1.yaml
```

```
hostname: OS10switch-1

dellos_cfg_generate: True
build_dir: /home/user/config
ansible_ssh_user: admin
ansible_ssh_pass: admin

dellos_logging:
 logging:
 - ip: 1.1.1.1
 state: present

dellos_users:
 - username: ul
 password: test@2468
 role: sysadmin
 privilege: 0
 state: present

dellos_ntp:
 server:
 - ip: 3.3.3.3
```

```
$ vim host_vars/OS10switch-2.yaml
```

```
hostname: OS10switch-2

dellos_cfg_generate: True
build_dir: /home/user/config
ansible_ssh_user: admin
ansible_ssh_pass: admin

dellos_logging:
 logging:
 - ip: 1.1.1.1
```



```

 state: present

dellos_users:
 - username: u1
 password: Test@1347
 role: sysadmin
 privilege: 0
 state: present

dellos_ntp:
 server:
 - ip: 3.3.3.3

```

The `dellos_cfg_generate` parameter creates a local copy of the configuration commands applied to the remote switch on the Ansible controller node, and saves the commands in the directory defined in the `build_dir` path.

**8.** Create a playbook file.

```

$ vim playbook.yaml

- hosts: OS10switch-1 OS10switch-2
 connection: network_cli
 roles:
 - dell-networking.dellos-logging
 - dell-networking.dellos-users
 - dell-networking.dellos-ntp

```

To check the syntax of a playbook, use the `ansible-playbook` command with the `--syntax-check` flag. This command runs the playbook file through the parser to ensure that its included files, roles, and other parameters have no syntax problems.

**9.** Run the playbook file. In the `ansible-playbook` command, the inventory and playbook files are mandatory entries. The play recap displays the results of the provisioning session; for example:

```

$ ansible-playbook -i inventory.yaml playbook.yaml
...
...
...
PLAY RECAP

OS10switch-1: ok=7 changed=6 unreachable=0 failed=0
OS10switch-2: ok=7 changed=6 unreachable=0 failed=0

```

# System management

|                                            |                                                                                                                                                                                                                                                                                      |
|--------------------------------------------|--------------------------------------------------------------------------------------------------------------------------------------------------------------------------------------------------------------------------------------------------------------------------------------|
| <b>System banners</b>                      | Provides information to configure a system login and message of the day (MOTD) text banners, see <a href="#">System banners</a> .                                                                                                                                                    |
| <b>User session management</b>             | Provides information to manage the active user sessions, see <a href="#">User session management</a> .                                                                                                                                                                               |
| <b>Telnet server</b>                       | Provides information to set up Telnet TCP/IP connections on the switch, see <a href="#">Telnet server</a> . To set up secure, encrypted the secure shell (SSH) connections to the switch, see <a href="#">SSH server</a> .                                                           |
| <b>Simple Network Management Protocol</b>  | Provides a message format for communication between Simple Network Management Protocol (SNMP) managers and agents. SNMP provides a standardized framework and common language for network monitoring and device management, see <a href="#">Simple Network Management Protocol</a> . |
| <b>System clock</b>                        | Provides information to set the system time, see <a href="#">System clock</a> .                                                                                                                                                                                                      |
| <b>Network Time Protocol</b>               | Provides information to synchronize timekeeping between time servers and clients, see <a href="#">NetworkTime Protocol</a> .                                                                                                                                                         |
| <b>Dynamic Host Configuration Protocol</b> | Provides information to dynamically assign IP addresses and other configuration parameters to network hosts based on policies, see <a href="#">Dynamic Host Configuration Protocol</a> .                                                                                             |

For information about how to set up a management network that is separate from your production network, see [Management Networks for Dell EMC Networking](#).

## System banners

You can configure a system login and message of the day (MOTD) text banners. The system login banner displays before you log in. The MOTD banner displays immediately after a successful login. You can also reset the banner text to the Dell EMC default banner or disable the banner display.

### Login banner

Configure a login banner that displays before you log in to the switch. Enter any single delimiter character to specify the start and end of the text banner.

Enable a login banner in CONFIGURATION mode using the following steps:

1. Enter the `banner login` command with a single delimiter character and press **Enter**.

```
banner login delimiter Enter
```

2. Enter each line of text and press **Enter**.

You can enter a maximum of 4096 characters and there is no limit to the number of lines.

```
banner-text <Enter>
banner-text <Enter>
banner-text <Enter>
```

3. Complete the login banner configuration by entering a line that contains only the delimiter character.

```
delimiter
```

#### Configure the login banner

```
OS10# configure terminal
OS10(config)# banner login %
```

```
DellEMC S4148U-ON login
Enter your username and password
%
```

To delete a login banner and reset it to the Dell EMC default banner, use the `no banner login` command. To disable the configured login banner, use the `banner login disable` command.

## Message of the day banner

Configure a message of the day (MOTD) banner that displays after you log in. Enter any single delimiter character to start and end the MOTD banner.

Enable the MOTD banner using the following steps:

- Enter the `banner motd` command with a single delimiter character and press **Enter**.

```
banner motd delimiter <Enter>
```

- Enter each line of text and press **Enter**.

You can enter a maximum of 4096 characters and there is no limit to the number of lines.

```
banner-text <Enter>
banner-text <Enter>
banner-text <Enter>
```

- Complete the banner configuration by entering a line that contains only the delimiter character.

```
delimiter
```

### Configure a MOTD banner

```
OS10# configure terminal
OS10(config)# banner motd %
DellEMC S4148U-ON
Today's tip: Press tab or spacebar for command completion.
Have a nice day!
%
```

To delete a MOTD banner and reset it to the Dell EMC default MOTD banner, use the `no banner motd` command. To disable the configured MOTD banner, use the `banner motd disable` command.

## System banner commands

### banner login

Configures a login banner that displays before you log in to the system.

#### Syntax

```
banner login delimiter <Enter>
banner-text <Enter>
banner-text <Enter>
... <Enter>
delimiter
```

#### Parameters

- *delimiter* — Enter any single delimiter character to specify the start and end of the text banner.
- *banner-text* — Enter the banner text, which is a maximum of 4096 characters. There is no limit to the number of lines.

#### Default

Dell EMC default banner is displayed before you log in.

#### Command Mode

CONFIGURATION

### Usage Information

- To enter a multiline banner text, use the interactive mode. Enter the command with the delimiter character and press **Enter**. Then enter each line and press **Enter**. Complete the banner configuration by entering a line that contains only the delimiter character.
- To delete a login banner and reset it to the Dell EMC default banner, use the `no banner login` command. To disable the configured login banner, use the `banner login disable` command.

### Example

```
OS10(config)# banner login %
Welcome to DellEMC Z9100-ON
Enter your username and password
%
```

### Supported Releases

10.4.1.0 or later

## banner motd

Configures a multiline MOTD banner that displays after you log in.

### Syntax

```
banner motd delimiter <Enter>
banner-text <Enter>
banner-text <Enter>
... <Enter>
delimiter
```

### Parameters

- *delimiter* — Enter any single delimiter character to specify the start and end of the text banner.
- *banner-text* — Enter the banner text, which is a maximum of 4096 characters. There is no limit on the number of lines.

### Default

Dell EMC default MOTD banner is displayed after you log in.

### Command Mode

CONFIGURATION

### Usage Information

- Enter the command with the delimiter character and press **Enter**. Then enter each line and press **Enter**. Complete the banner configuration by entering a line that contains only the delimiter character.
- To delete a login banner and reset it to the Dell EMC default banner, use the `no banner motd` command. To disable the configured MOTD banner, use the `banner motd disable` command.

### Example

```
OS10(config)# banner motd %
DellEMC S4148U-ON
Today's tip: Press tab or spacebar for command completion.
Have a nice day!
%
```

### Supported releases

10.4.1.0 or later

## User session management

You can manage the active user sessions using the following commands:

- Configure the timeout for all the active user sessions using the `exec-timeout timeout-value` command in the CONFIGURATION mode.
- Clear any user session using the `kill-session session-ID` command in the EXEC mode. You cannot clear your currently logged-in session.
- View the active user sessions using the `show sessions` command in the EXEC mode.

### Configure timeout for user sessions

```
OS10(config)# exec-timeout 300
OS10(config)#
```

### Clear user session

```
OS10# kill-session 3
```

### View active user sessions

```
OS10# show sessions

Current session's operation mode: Non-transaction

Session-ID User In-rpcs In-bad-rpcs Out-rpc-err Out-notify Login-time
Lock

--
 3 snmp_user 114 0 0 0 2017-07-10T23:58:39Z
 4 snmp_user 57 0 0 0 2017-07-10T23:58:40Z
 6 admin 17 0 0 4 2017-07-12T03:55:18Z
 *7 admin 10 0 0 0 2017-07-12T04:42:55Z
OS10#
```

The asterisk (\*) in the `Session-ID` column indicates the current OS10 session.

## User session management commands

### exec-timeout

Configures a timeout value for all the user sessions.

**Syntax** `exec-timeout timeout-value`

**Parameters** `timeout-value` — Enter the timeout value in seconds, from 0 to 3600.

**Default** Not configured

**Command Mode** CONFIGURATION

**Usage Information** The `no` version of this command disables the timeout.

**Example**

```
OS10(config)# exec-timeout 300
OS10(config)#
```

**Supported Releases** 10.3.1E or later

### kill-session

Terminates a user session.

**Syntax** `kill-session session-ID`

**Parameters** `session-ID` — Enter the user session ID.

**Default** Not configured

**Command Mode** EXEC

**Usage Information** None

**Example**

```
OS10# kill-session 3
```

**Supported Releases**

10.3.1E or later

## show sessions

Displays the active management sessions.

**Syntax**

```
show sessions
```

**Parameters**

None

**Default**

Not configured

**Command Mode**

EXEC

**Usage Information**

Use this command to view information about the active user management sessions.

**Example**

```
OS10# show sessions

Current session's operation mode: Non-transaction

Session-ID User In-rpcs In-bad-rpcs Out-rpc-err Out-notify Login-time Lock

3 snmp_user 114 0 0 0 2017-07-10T23:58:39Z
4 snmp_user 57 0 0 0 2017-07-10T23:58:40Z
6 admin 17 0 0 4 2017-07-12T03:55:18Z
*7 admin 10 0 0 0 2017-07-12T04:42:55Z
OS10#
```

**Supported Releases**

10.3.1E or later

## Telnet server

To allow Telnet TCP/IP connections to an OS10 switch, enable the Telnet server. The OS10 Telnet server uses the Debian `telnetd` package. By default, the Telnet server is disabled.

When you enable the Telnet server, connect to the switch using the IP address configured on the management or any front-panel port. The Telnet server configuration is persistent and is maintained after you reload the switch. To verify the Telnet server configuration, enter the `show running-configuration` command.

 **NOTE:** Dell Technologies recommends using SSH for secure, encrypted connections to the switch. SSH is enabled by default. To set up SSH connections, see [SSH server](#).

**Enable the Telnet server**

```
OS10(config)# ip telnet server enable
```

**Disable the Telnet server**

```
OS10(config)# no ip telnet server enable
```

By default, the Telnet server is reachable on the default virtual routing and forwarding (VRF) instance if the Telnet server is enabled. To configure the Telnet server to be reachable on the management VRF, use the `ip telnet server vrf management` command. To configure the Telnet server to be reachable on a non-default VRF instance, use the `ip telnet server vrf vrf-name` command.

**Configure a Telnet server on the management VRF**

```
OS10(config)# ip telnet server vrf management
```

## Telnet commands

### ip telnet server enable

Enables Telnet TCP/IP connections to an OS10 switch.

**Syntax** `ip telnet server enable`

**Parameters** None

**Default** Disabled

**Command Mode** CONFIGURATION

**Usage Information** By default, the Telnet server is disabled. When you enable the Telnet server, use the IP address configured on the management or any front-panel port to connect to an OS10 switch. After you reload the switch, the Telnet server configuration is maintained. To verify the Telnet server configuration, use the `show running-configuration` command.

Supported on the MX9116n and MX5108n switches in Full Switch mode starting in release 10.4.0(R3S). Also supported in SmartFabric mode starting in release 10.5.0.

**Example**

```
OS10(config)# ip telnet server enable
```

**Example (disable)**

```
OS10(config)# no ip telnet server enable
```

**Supported Releases** 10.4.0E(R1) or later

### ip telnet server vrf

Configures the Telnet server for the management or non-default VRF instance.

**Syntax** `ip telnet server vrf {management | vrf vrf-name}`

**Parameters**

- `management` — Configures the management VRF used to reach the Telnet server.
- `vrf vrf-name` — Enter the keyword `vrf` followed by the name of the VRF to configure the non-default VRF instance used to reach the Telnet server.

**Default** If the Telnet server is enabled, the Telnet server is reachable on the default VRF.

**Command Mode** CONFIGURATION

**Usage Information** By default, the Telnet server is disabled. To enable the Telnet server, use the `telnet enable` command.

**Example**

```
OS10(config)# ip telnet server vrf management
OS10(config)# ip telnet server vrf vrf-blue
```

**Supported Releases** 10.4.0E(R1) or later

## Simple Network Management Protocol

Network management stations use simple network management protocol (SNMP) to retrieve and modify software configurations for managed objects on an agent in network devices. A *managed object* is a datum of management information.

The SNMP agent in a managed device maintains the data for managed objects in management information bases (MIBs). Managed objects are identified by their object identifiers (OIDs). A remote SNMP agent performs an SNMP walk on the OIDs stored in MIBs on the local switch to view and retrieve information.

OS10 supports standard and private SNMP MIBs, including all `get` requests. MIBs are hierarchically structured and use object identifiers to access managed objects. For a list of MIBs supported in the OS10 version running on a switch, see the *OS10 Release Notes* for the release.

OS10 supports different security models and levels in SNMP communication between SNMP managers and agents. Each security model refers to an SNMP version used in SNMP messages. SNMP versions provide different levels of security, such as user authentication and message encryption.

**NOTE:** OS10 does not support SNMP SET operations.

### Configuration notes

All Dell EMC PowerSwitches except MX-Series, S4200-Series, S5200 Series, and Z9332F-ON:

- SNMP server is supported in non-default (data) VRFs.

Dell EMC PowerSwitch S4200-ON Series:

- SNMP server is supported in non-default (data) VRFs.

## SNMP security models and levels

OS10 supports SNMP security models v1, v2c, and v3. The supported security levels are no authentication, authentication, and privacy.

You specify the SNMP security model and level when you configure SNMP groups and users. Each security model corresponds to an SNMP version that provides different security levels:

- SNMPv1 provides no user authentication or privacy protection (encryption). SNMP messages are sent in plain text.
- SNMPv2c provides no user authentication or encryption. SNMP messages are sent in plain text.
- SNMPv3 provides user-configured security levels for user authentication and encryption of SNMP messages:
  - No user password or message encryption
  - User authentication only
  - User authentication and message encryption

The supported characters for SNMP user password are

- A-Z
- a-z
- 0-9
- +/
- \_-
- =

## MIBs

OS10 supports the following standard and Dell EMC enterprise MIBs.

MIBs are stored in the `/opt/dell/os10/snmp/mibs/` directory.

**Table 4. Standards MIBs**

| Module             | Standard      |
|--------------------|---------------|
| BRIDGE-MIB         | IEEE 802.1D   |
| ENTITY-MIB         | RFC 6933      |
| EtherLike-MIB      | RFC 3635      |
| HOST-RESOURCES-MIB | RFC 2790      |
| IEEE8021-PFC-MIB   | IEEE 802.1Qbb |
| IEEE8023-LAG-MIB   | IEEE 802.3ad  |
| IF-MIB             | RFC 2863      |



**Table 4. Standards MIBs (continued)**

| Module                  | Standard     |
|-------------------------|--------------|
| IP-FORWARD-MIB          | RFC 4292     |
| IP-MIB                  | RFC 4293     |
| LLDP-EXT-DOT1-MIB       | IEEE 802.1AB |
| LLDP-EXT-DOT3-MIB       | IEEE 802.1AB |
| LLDP-MIB                | IEEE 802.1AB |
| OSPF-MIB                | RFC 4750     |
| OSPFV3-MIB              | RFC 5643     |
| Q-BRIDGE-MIB            | IEEE 802.1Q  |
| RFC1213-MIB             | RFC 1213     |
| SFLOW-MIB               | RFC 3176     |
| SNMP-FRAMEWORK-MIB      | RFC 3411     |
| SNMP-MPD-MIB            | RFC 3412     |
| SNMP-NOTIFICATION-MIB   | RFC 3413     |
| SNMP-TARGET-MIB         | RFC 3413     |
| SNMP-USER-BASED-SM-MIB  | RFC 3414     |
| SNMP-VIEW-BASED-ACM-MIB | RFC 3415     |
| SNMPv2-MIB              | RFC 3418     |
| TCP-MIB                 | RFC 4022     |
| UDP-MIB                 | RFC 4113     |

**Table 5. Dell EMC Enterprise MIBs**

| Module                         | Description                                  |
|--------------------------------|----------------------------------------------|
| DELLEMC-OS10-BGP4V2-MIB        | OS10 BGPv2 implementations                   |
| DELLEMC-OS10-CHASSIS-MIB       | OS10 chassis implementations                 |
| DELLEMC-OS10-PRODUCTS-MIB      | OS10 platform product definitions            |
| DELLEMC-OS10-SMI-MIB           | OS10 SMI implementations                     |
| DELLEMC-OS10-TC-MIB            | OS10 networking equipment textual convention |
| DELLEMC-OS10-PORT-SECURITY-MIB | OS10 port security feature MIB               |

**i NOTE:**

- To monitor BGP, OS10 supports the Dell EMC proprietary MIB, DELLEMC-OS10-BGP4V2-MIB.mib. OS10 returns a No such object message when you use the standard BGP4-MIB with OID 1.3.6.1.2.1.15. Use OID 1.3.6.1.4.1.674.11000.5000.200.1.1 for BGP-related MIB objects.
- Dell EMC Enterprise MIBs are not supported in the SNMPv1 standard.

## SNMPv3

SNMP version 3 (SNMPv3) provides an enhanced security model for user authentication and SNMP message encryption. User authentication requires that SNMP packets come from an authorized source. Message encryption ensures that packet contents cannot be viewed by an unauthorized source.

To configure SNMPv3-specific security settings — user authentication and message encryption — use the `snmp-server user` command. You can generate localized keys with enhanced security for authentication and privacy (encryption) passwords.

## SNMP engine ID

An engine ID identifies the SNMP entity that serves as the local agent on the switch. The engine ID is an octet colon-separated number; for example, `00:00:17:8B:02:00:00:01`.

When you configure an SNMPv3 user, you can specify that a localized authentication and/or privacy key be generated. The localized password keys are generated using the engine ID of the switch. A localized key is more complex and provides greater privacy protection.

The engine ID used to generate the password keys is unique to the switch. For this reason, you cannot copy and use localized SNMP security passwords on another switch.

## SNMP groups and users

A member of an SNMP group that accesses the local SNMP agent is known as an *SNMP user*. An SNMP user on a remote device is identified by an IP address and UDP port from which the user accesses the local agent.

In OS10, users are assigned SNMP access privileges according to the group they belong to. You configure each group for access to SNMP MIB tree views.

## SNMP views

In OS10, you configure views for each security model and level in an SNMP user group. Each type of view specifies the object ID (OID) in the MIB tree hierarchy at which the view starts. You can also specify whether the rest of the MIB tree structure is included or excluded from the view.

- A *read* view provides read-only access to the specified OID tree.
- A *write* view provides read-write access to the specified OID tree.
- A *notify* view allows SNMP notifications (traps and informs) from the specified OID tree to be sent to other members of the group.

## Configure SNMP

To set up communication with SNMP agents in your network:

- Configure the read-only, read-write, and notify access for SNMP groups.
- Configure groups with SNMP views for specified SNMP versions (security models).
- Assign users to groups and configure SNMPv3-specific authentication and encryption settings, and optionally, localized security keys and ACL-based access.

Configuring SNMP consists of these tasks in any order:

- [Configure SNMP engine ID](#)
- [Configure SNMP views](#)
- [Configure SNMP groups](#)
- [Configure SNMP users](#)

## Configure SNMP engine ID

The engine ID identifies the SNMP local agent on a switch. The engine ID is an octet colon-separated number; for example, `80:00:02:b8:04:61:62:63`.

The local engine ID is used to create a localized authentication and/or privacy key for greater security in SNMPv3 messages. You generate a localized authentication and/or privacy key when you configure an SNMPv3 user.

Configure a remote device and its engine ID to allow a remote user to query the local SNMP agent. The remote engine ID is included in the query and used to generate the authentication and privacy password keys to access the local agent. If you do not configure the remote engine ID, remote users' attempts to access the local agent fail.

**NOTE:** Create a remote engine ID with the `snmp-server engineID` command before you configure a remote user with the `snmp-server user` command. If you change the configured engine ID for a remote device, you must reconfigure the authentication and privacy passwords for all remote users associated with the remote engine ID.

```
snmp-server engineID [local engineID] [remote ip-address [{udp-port port-number} remote-engineID]]
```

To display the localized authentication and privacy keys in an SNMPv3 user configuration, use the `show snmp engineID local` command.

### Configure SNMP engineID

```
OS10(config)# snmp-server engineID local 80:00:02:b8:04:61:62:63
```

### Display SNMP engineID

```
OS10# show snmp engineID local
Local default SNMP engineID: 0x800002a2036c2b59fbd8a0
```

## Configure SNMP views

Configure a read-only, read-write, or notify view of the MIB tree structure in the SNMP agent on the switch.

The `oid-tree` value specifies the OID in the MIB tree hierarchy at which a view starts. Enter `included` or `excluded` to include or exclude the rest of the sub-tree MIB contents in the view. If necessary, re-enter the command to exclude tree entries in the included content.

```
snmp-server view view-name oid-tree [included | excluded]
```

### Configure read-only view

```
OS10(config)# snmp-server view readonly 1.3.6.1.2.1.31.1.1.1.6 included
```

### Configure read-write view

```
OS10(config)# snmp-server view rwView 1.3.6.1.2.1.31.1.1.1.6 included
OS10(config)# snmp-server view rwView 1.3.6.1.2.1.31.0.0.0.0 excluded
```

### Display SNMP views

```
OS10# show snmp view
view name : readview
OID : 1.3.6.5
excluded : True
```

## Configure SNMP groups

Configure an SNMP group with the views allowed for the members of the group. Specify the read-only, read-write, and/or notification access to the SNMP agent.

The security model corresponds to the SNMP version that users use to send and receive SNMP messages. The security level configures SNMPv3 user authentication and privacy settings:

- `auth` — Authenticate users in SNMP messages.
- `noauth` — Do not authenticate users or encrypt SNMP messages; send messages in plain text.
- `priv` — Authenticate users and encrypt/decrypt SNMP messages.

Enter an ACL to limit user access so that only messages from and to ACL-allowed users are received and sent from the SNMP agent on the switch.

```
snmp-server group group-name {v1 | v2c | v3 security-level} [access acl-name]
[read view-name] [write view-name] [notify view-name]
```

To configure a view of the MIB tree on the SNMP agent, use the `snmp-server view` command.

To configure an SNMPv3 user's authentication and privacy settings, use the `snmp-server user` command.

To display the configured SNMP groups, use the `show snmp group` command.

### Configure SNMPv1 or v2c group

```
OS10(config)# snmp-server group v2group 2c read readview notify GetsSets
```

### Configure SNMPv3 group

```
OS10(config)# snmp-server group v3group 3 priv read readview write writeview notify alltraps
```

### Display SNMP groups

```
OS10# show snmp group
groupname : v2group
version : 2c
notifyview : GetsSets
readview : readview

groupname : v3group
version : 3
security level : priv
notifyview : alltraps
readview : readview
writeview : writeview
```

## Configure SNMP users

Configure user access to the SNMP agent on the switch using group membership. Assign each user to a group and configure SNMPv3-specific authentication and encryption settings, and optionally, localized security keys and ACL-based access. Re-enter the command multiple times to configure SNMP security settings for all users.

```
snmp-server user user-name group-name security-model [[noauth | auth {md5 | sha} auth-
password]
[priv {des | aes}]] [localized] [access acl-name] [remote ip-address udp-port port-
number]
```

The group to which a user is assigned determines the user's access privilege. To configure a group's access privilege — read, write, and notify — to the switch, use the `snmp-server group` command. The security model for SNMPv3 provides the strongest security with user authentication and packet encryption.

No default values exist for SNMPv3 authentication and privacy algorithms and passwords. If you forget a password, you cannot recover it — you must reconfigure the user. You can specify either a plain-text password or an encrypted cypher-text password. In either case, the password stores in the configuration in encrypted form and displays as encrypted in the `show running-config snmp` output.

A localized authentication or privacy key is more complex and provides greater privacy protection. Localized keys are generated using the engine ID of the switch. For this reason, you cannot use the localized SNMP security passwords in the configuration file on another switch. For more information, see [Configure SNMP engine ID](#). To display the localized authentication and privacy keys in an SNMPv3 user configuration, use the `show running-configuration snmp` command.

To limit user access to the SNMP agent on the switch, enter an `access acl-name` value. In IPv6 ACLs, SNMP supports only IPv6 and UDP types. TCP, ICMP, and port rules are not supported.

To display the configured SNMP users, use the `show snmp user` command.

### Configure SNMPv1 or v2c users

```
OS10(config)# snmp-server user admin1 netadmingroup 2c acl acl_AdminOnly
```

### Configure SNMPv3 users

```
OS10(config)# snmp-server user privuser v3group 3 encrypted auth
md59fc53d9d908118b2804fe80e3ba8763d priv des56 d0452401a8c3ce42804fe80e3ba8763d
```

```
OS10(config)# snmp-server user n3user ngroup remote 172.31.1.3 udp-port 5009 3 auth md5
authpasswd
```

## Display SNMP users

```
OS10# show snmp user
User name : privuser
Group : v3group
Version : 3
Authentication Protocol : MD5
Privacy Protocol : AES
```

## Generate SNMPv3 localized keys

The user-based security model in SNMP v3 offers strong authentication and encryption using the following algorithms:

- Authentication algorithms—MD5 and SHA
- Encryption algorithms—DES and AES-128

While configuring SNMP users, instead of using plain text passwords, you can use localized keys that are encrypted using authentication and encryption algorithms. To generate the localized keys, use the `Snmpkey` utility in Linux. Ensure that you have the following packages installed in the Linux server to generate the localized keys:

- `libnet-snmp-perl`
- `libcrypt-des-perl`
- `libdigest-hmac-perl`
- `libcrypt-rijndael-perl`

Use the following command to generate the localized keys that you can use when configuring a user:

```
snmpkey {md5 | sha} authpassword engineID [des | 3des | aes] privpassword
```

where `authpassword` is the password that you specify for the authentication protocol, `engineID` is the local engineID, and `privpassword` is the password that you specify for the privacy protocol.

Use the `show snmp engineID local` command to view the local engineID.

```
OS10# show snmp engineID local
Local default SNMP engineID: 0x800002a2036c2b59fbd8a0
```

Enter the following command on the Linux server where you have the `Snmpkey` utility installed:

```
snmpkey md5 testauthpasswd 0x800002a2036c2b59fbd8a0 des testprivpasswd
authKey: 0xaa5bb0eb6e6a9f036dc548e4ad9405f8
privKey: 0xaa5bb0eb6e6a9f036dc548e4ad9405f8
```

The system generates the authentication and privacy keys.

Use the localized keys while configuring the SNMP user.

```
OS10(config)# snmp-server user user3 Group3 3 localized auth md5
0xaa5bb0eb6e6a9f036dc548e4ad9405f8 priv des 0xaa5bb0eb6e6a9f036dc548e4ad9405f8
```

## Configure SNMP traps

The SNMP agent sends notification of events to the management station using unsolicited SNMP messages called SNMP traps. SNMP traps optimize the use of network resources.

SNMP version 1 and version 2C traps can coexist with version 3 traps. SNMP versions 1 and 2C use the trap category for access control. SNMP version 3 traps are associated to SNMP users with a given authentication level.

Configure SNMP traps on the OS10 switch for it to send notifications to the management station.

```
snmp-server host {ipv4-address | ipv6-address} {informs version version-number | traps
version version-number | version version-number} [snmpv3-security-level] [community-name]
[udp-port port-number] [dom | entity | envmon | lldp | snmp]
```

### Configure SNMP v1 or v2C traps

```
OS10(config)# snmp-server host 10.11.73.110 traps version 2c comm2c lldp snmp
```

### Configure SNMP v3 traps

```
OS10(config)# snmp-server group Group3 3 priv notify NOTIFY
OS10(config)# snmp-server user User3 Group3 3 auth md5 testpasswd priv aes testprivpasswd
OS10(config)# snmp-server host 10.11.56.46 version 3 priv User3
```

## Configure SNMP informs

The SNMP agent sends notification of events to and receives an acknowledgment from the network management station (NMS), also called as the remote SNMP server. Such notifications that receive an SNMP response from the NMS are called informs. Informs are more reliable than traps. If an SNMP agent does not receive an acknowledgment, it resends the inform, up to a maximum of three retries.

Configure the engine ID of the remote SNMP server to receive an acknowledgment.

```
snmp-server host {ipv4-address | ipv6-address} {informs version version-number | traps
version version-number | version version-number} [snmpv3-security-level] [community-name]
[udp-port port-number] [dom | entity | envmon | lldp | snmp]
```

### Configure SNMP v3 informs

```
OS10(config)# snmp-server group Group3 3 priv notify NOTIFY
OS10(config)# snmp-server engineID remote 10.1.1.1 0x80000232334abc34d
OS10(config)# snmp-server user rem-user Group3 remote 10.1.1.1 udp-port 162 3 auth md5
testpasswd priv des testprivpasswd
OS10(config)# snmp-server host 10.11.5.1 informs version 3 priv rem-user
```

## SNMP commands

### show snmp community

Displays the SNMP communities configured on the switch.

**Syntax** show snmp community

**Parameters** None

**Defaults** None

**Command Mode** EXEC

**Usage Information** To configure an SNMP community, use the `snmp-server community` command.

#### Example

```
OS10# show snmp community
Community : public
Access : read-only

Community : dellOS10
Access : read-write
ACL : dellacl
```

**Supported Releases** 10.4.2.0 or later

## show snmp engineID

Displays the SNMP engine ID on the switch or on remote devices that access the SNMP agent on the switch.

**Syntax** `show snmp engineID {local | remote}`

- Parameters**
- `local` — Display the local engine ID.
  - `remote` — Display the SNMP engine ID of remote devices configured on the switch.

**Defaults** None

**Command Mode** EXEC

**Usage Information** To configure the local engine ID or the engine ID for a remote device, use the `snmp-server engineID` command.

**Example**

```
OS10# show snmp engineID remote
Remote Engine ID IP-addr Port
0x0712 1.1.1.1 23

OS10# show snmp engineID local
Local default SNMP engineID: 0x80001f880390b11cf4abe7
```

**Supported Releases** 10.4.2.0 or later

## show snmp group

Displays the SNMP groups configured on the switch, including SNMP views and security models.

**Syntax** `show snmp group`

**Parameters** None

**Defaults** None

**Command Mode** EXEC

**Usage Information** To configure an SNMP group, use the `snmp-server group` command.

**Example**

```
OS10# show snmp group
groupname : v2group
version : 2c
notifyview : GetsSets
readview : readview

groupname : v3group
version : 3
security level : priv
notifyview : alltraps
readview : readview
writeview : writeview
```

**Supported Releases** 10.4.2.0 or later

## show snmp user

Displays the users configured to access the SNMP agent on the switch, including the SNMP group and security model.

**Syntax** `show snmp user`

**Parameters** None

**Defaults** None

**Command Mode** EXEC

**Usage Information** To configure an SNMP user, use the `snmp-server user` command.

**Example**

```
OS10# show snmp user
User name : privuser
Group : v3group
Version : 3
Authentication Protocol : MD5
Privacy Protocol : AES
```

**Supported Releases** 10.4.2.0 or later

## show snmp view

Displays the SNMP views configured on the switch, including the SNMP object ID at which the view starts.

**Syntax** `show snmp view`

**Parameters** None

**Defaults** None

**Command Mode** EXEC

**Usage Information** Use the `show snmp view` command to verify the OID starting point for SNMP views in MIB trees. To configure an SNMP view, use the `snmp-server view` command.

**Example**

```
OS10# show snmp view
view name : readview
OID : 1.3.6.5
excluded : True
```

**Supported Releases** 10.4.2.0 or later

## snmp-server community

Configures an SNMP user community.

**Syntax** `snmp-server community name {ro | rw} [acl acl-name]`

**Parameters**

- `community name` — Set the community name string to act as a password for SNMPv1 and SNMPv2c access. A maximum of 20 alphanumeric characters.
- `ro` — Set read-only access for the SNMP community.
- `rw` — Set read-write access for the SNMP community.
- `acl acl-name` — Enter an existing IPv4 ACL name to limit SNMP access in the SNMP community.

**Defaults** An SNMP community has read-only access.

**Command Mode** CONFIGURATION

**Usage Information** The SNMPv1 and SNMPv2c security models use a community-based form of security. Use this command to configure read-only or read-write access for an SNMP community name. The configured community text string is used for SNMPv1 and SNMPv2c user authentication.

To display the SNMP communities on the switch, use the `show snmp community` command.

Supported on the MX9116n and MX5108n switches in Full Switch mode starting in release 10.4.0E(R3S). Also supported in SmartFabric mode starting in release 10.5.0.1.

These points are applicable when you assign an ACL to an SNMP community:

- By default, SNMP requests from all hosts are allowed.



- You can only apply `permit` ACL rules to an SNMP community. `deny` ACL rules do not take effect if you apply them.
- To permit SNMP requests for multiple hosts, apply individual `permit` ACL rules for hosts or prefixes.

The `no` version of the command removes the configured community text string.

**Example**

```
OS10(config)# snmp-server community admin rw
OS10(config)# snmp-server community public ro acl snmp-read-only-acl
```

**Supported Releases** 10.2.0E or later

## snmp-server contact

Configures contact information for troubleshooting the local SNMP switch.

**Syntax** `snmp-server contact text`

**Parameters** `text` — Enter an alphanumeric text string. A maximum of 55 characters.

**Default** The SNMP server contact is `support`.

**Command Mode** CONFIGURATION

**Usage Information** Supported on the MX9116n and MX5108n switches in Full Switch mode starting in release 10.4.0E(R3S). Also supported in SmartFabric mode starting in release 10.5.0.1.

The `no` version of this command resets the SNMP server contact to the default value.

**Example**

```
OS10(config)# snmp-server contact administrator
```

**Supported Releases** 10.2.0E or later

## snmp-server enable traps

Enables SNMP traps on a switch.

**Syntax** `snmp-server enable traps [notification-type] [notification-option]`

**Parameters**

- `notification-type notification-option` — Enter an SNMP notification type, and optionally, a notification option for the type.

**Table 6. Notification types and options**

| Notification type                                              | Notification option                                                                                                                                                                                                                                                                               |
|----------------------------------------------------------------|---------------------------------------------------------------------------------------------------------------------------------------------------------------------------------------------------------------------------------------------------------------------------------------------------|
| <code>entity</code> — Enable entity change traps.              | None                                                                                                                                                                                                                                                                                              |
| <code>envmon</code> — Enable SNMP environmental monitor traps. | <ul style="list-style-type: none"> <li>o <code>fan</code> — Enable fan traps.</li> <li>o <code>power-supply</code> — Enable power-supply traps.</li> <li>o <code>temperature</code> — Enable temperature traps.</li> </ul>                                                                        |
| <code>lldp</code> — Enable LLDP state change traps.            | <ul style="list-style-type: none"> <li>o <code>rem-tables-change</code> — Enable the <code>lldpRemTablesChange</code> trap.</li> </ul>                                                                                                                                                            |
| <code>snmp</code> — Enable SNMP traps.                         | <ul style="list-style-type: none"> <li>o <code>authentication</code> — Enable authentication traps.</li> <li>o <code>coldstart</code> — Enable coldstart traps when you power on the switch and the SNMP agent initializes.</li> <li>o <code>linkdown</code> — Enable link-down traps.</li> </ul> |

**Table 6. Notification types and options (continued)**

| Notification type | Notification option                                                                                                                                                                        |
|-------------------|--------------------------------------------------------------------------------------------------------------------------------------------------------------------------------------------|
|                   | <ul style="list-style-type: none"> <li>o linkup — Enable link-up traps.</li> <li>o warmstart — Enable warmstart traps when the switch reloads and the SNMP agent reinitializes.</li> </ul> |

**Defaults** Not configured

**Command Mode** CONFIGURATION

**Usage Information** If you do not enter a `notification-type` or `notification-option` parameter with command, all traps are enabled. If you enter only a `notification-type`, all `notification-option` traps associated with the type are enabled.

To enable specific SNMP trap types, re-enter the command multiple times with different notification types and options.

To configure a host to receive SNMP notifications, use the `snmp-server host` command.

Supported on the MX9116n and MX5108n switches in Full Switch mode starting in release 10.4.1.0. Also supported in SmartFabric mode starting in release 10.5.0.1.

The `no` version of the command disables SNMP traps on the switch.

**Example**

```
OS10(config)# snmp-server enable traps envmon fan
OS10(config)# snmp-server enable traps envmon power-supply
OS10(config)# snmp-server enable traps snmp

OS10(config)# no snmp-server enable traps snmp
```

**Supported Releases** 10.4.1.0 or later

## snmp-server engineID

Configures the local and remote SNMP engine IDs.

**Syntax** `snmp-server engineID [local engineID] [remote ip-address {[udp-port port-number] remote-engineID}]`

- Parameters**
- `local engineID` — Enter the engine ID that identifies the local SNMP agent on the switch as an octet colon-separated number. A maximum of 27 characters.
  - `remote ip-address` — Enter the IPv4 or IPv6 address of a remote SNMP device that accesses the local SNMP agent.
  - `udp-port port-number` — Enter the UDP port number on the remote device, from 0 to 65535.
  - `remote-engineID` — Enter the engine ID that identifies the SNMP agent on a remote device, 0x then by a hexadecimal string).

**Defaults** The local engine ID is generated using the MAC address of the management Ethernet interface.

**Command Mode** CONFIGURATION

**Usage Information** The local engine ID generates the localized keys for the authentication and privilege passwords. These passwords authenticate SNMP users and encrypt SNMP messages. If you reconfigure the local Engine ID, the localized keys also change. The existing values are no longer valid, and a warning message displays. As a result, you must reconfigure SNMP users with new localized password keys.

In addition, if you change the configured engine ID for a remote device, you must reconfigure the authentication and privacy passwords for the remote user.

To display the current local engine ID, use the `show snmp engineID local` command.

Supported on the MX9116n and MX5108n switches in Full Switch mode starting in release 10.4.2.0. Also supported in SmartFabric mode starting in release 10.5.0.1.

The no version of this command resets the default engine ID values.

### Example

```
OS10(config)# snmp-server engineID local 80:00:02:b8:04:61:62:63
OS10(config)# snmp-server engineID local 80:00:02:b8:04:61:62:63
% Warning: Localized passwords need to be regenerated for local user.
OS10(config)# snmp-server engineID remote 1.1.1.1 0xaaffcc
OS10(config)# snmp-server engineID remote 1.1.1.2 udp-port 432 0xabeecc
```

### Supported Releases

10.4.2.0 or later

## snmp-server group

Configures the views allowed for the users in an SNMP group.

### Syntax

```
snmp-server group group-name {v1 | v2c | v3 security-level} [access acl-name] [read view-name] [write view-name] [notify view-name]
```

### Parameters

- *group-name* — Enter the name of the group. A maximum of 32 alphanumeric characters.
- *v1* — SNMPv1 provides no user authentication or privacy protection. SNMP messages are sent in plain text.
- *v2c* — SNMPv2c provides no user authentication or privacy protection. SNMP messages are sent in plain text.
- *v3 security-level* — SNMPv3 provides optional user authentication and encryption for SNMP messages, configured with the `snmp-server user` command.
- *security-level* — (SNMPv3 only) Configure the security level for SNMPv3 users:
  - *auth* — Authenticate users in SNMP messages.
  - *noauth* — Do not authenticate users or encrypt SNMP messages; send messages in plain text.
  - *priv* — Authenticate users and encrypt/decrypt SNMP messages.
- *access acl-name* — (Optional) Enter the name of an IPv4 or IPv6 access list to filter SNMP requests received on the switch. A maximum of 16 characters.
- *read view-name* — (Optional) Enter the name of a read-only view. A maximum of 32 characters maximum.
- *write view-name* — (Optional) Enter the name of a read-write view. A maximum of 32 characters maximum.
- *notify view-name* — (Optional) Enter the name of a notification view. A maximum of 32 characters maximum.

### Defaults

Not configured

### Command Mode

CONFIGURATION

### Usage Information

Use this command to set up the access privileges for a group of SNMP users. Configure the security level for receiving SNMP messages. Specify read-only, read-write, and/or notification access to the SNMP agent. To configure an SNMPv3 user's authentication and privacy settings, use the `snmp-server user` command.

Enter an `access acl-name` value to limit access to the SNMP agent to only ACL-allowed users.

A read-view provides read-only access to the SNMP agent. A read-write view allows read-write access. A notify-view allows SNMP notifications to be sent to group members.

Supported on the MX9116n and MX5108n switches in both Full Switch mode starting in release 10.4.2.0. Also supported in SmartFabric mode starting in release 10.5.0.1.

The no version of the command deletes an SNMP group.

### Example

```
OS10(config)# snmp-server group os10admin p3 priv read readonlyview
```

**Supported Releases** 10.4.2.0 or later

## snmp-server host

Configures a host to receive SNMP notifications.

**Syntax** `snmp-server host {ipv4-address | ipv6-address} {informs version version-number | traps version version-number | version version-number} [snmpv3-security-level] [community-name] [udp-port port-number] [dom | entity | envmon | lldp | snmp]`

- Parameters**
- *ipv4-address* | *ipv6-address* — Enter the IPv4 or IPv6 address of the SNMP host.
  - *informs* — Send inform messages to the SNMP host.
  - *traps* — Send trap messages to the SNMP host.
  - *version* *version-number* — Enter the SNMP security model used to send traps or informs to the SNMP host — 1, 2c, or 3. All security models support traps; only 2c and 3 support informs. To send only SNMP notifications, enter only a *version-number*; do not enter *informs* or *traps*. For SNMPv3 traps and informs, enter the security level:
    - *noauth* — (SNMPv3 only) Send SNMPv3 traps without user authentication and privacy encryption.
    - *auth* — (SNMPv3 only) Include a user authentication key for SNMPv3 messages sent to the host:
      - *md5* — Generate an authentication key using the Message Digest Algorithm (MD5) algorithm.
      - *sha* — Generate an authentication key using the Secure Hash Algorithm (SHA) algorithm.
      - *auth-password* — Enter a text string used to generate the authentication key that identifies the user. A maximum of 32 alphanumeric characters. For an encrypted password, enter the encrypted string instead of plain text.
    - *priv* — (SNMPv3 only) Configure encryption for SNMPv3 messages sent to the host:
      - *aes* — Encrypt messages using an AES 128-bit algorithm.
      - *des* — Encrypt messages using a DES 56-bit algorithm.
      - *priv-password* — Enter a text string used to generate the privacy key used in encrypted messages. A maximum of 32 alphanumeric characters. For an encrypted password, you can enter the encrypted string instead of plain text.
  - *community-name* — (Optional) Enter an SNMPv1 or SNMPv2c community string name or an SNMPv3 user name.
  - *udp-port* *port-number* — (Optional) Enter the UDP port number on the SNMP host, from 0 to 65535.
  - *dom* | *entity* | *envmon* | *lldp* | *snmp* — Enter one or more types of traps and notifications to send to the SNMP host — digital optical monitor, entity change, environment monitor, or LLDP state change traps, or SNMP-type notifications.

**Defaults** Not configured

**Command Mode** CONFIGURATION

**Usage Information** The local SNMP agent sends SNMP notifications, traps, and informs to SNMP managers configured as host receivers. You can configure multiple host receivers.

An SNMP host does not acknowledge the trap messages and notifications received from the SNMP agent. SNMP hosts send an acknowledgement when receiving informs.

Supported on the MX9116n and MX5108n switches in Full Switch mode starting in release 10.4.0E(R3S). Also supported in SmartFabric mode starting in release 10.5.0.1.

The *no* version of the command disables the local agent from sending SNMP traps, informs, or notifications to a host receiver.

### Example — Send SNMP traps to host

```
OS10(config)# snmp-server host 1.1.1.1 traps version 3 priv user01 udp-
port 32 entity lldp
```

**Example — Send SNMP informs to host**

```
OS10(config)# snmp-server host 1.1.1.1 informs version 2c public envmon snmp
```

**Example — Send SNMP notifications to host**

```
OS10(config)# snmp-server host 1.1.1.1 version 3 noauth u1 snmp lldp
```

**Supported Releases** 10.2.0E or later

## snmp-server location

Configures the location of the SNMP server.

**Syntax** `snmp-server location text`**Parameters** `text` — Enter an alphanumeric string. A maximum of 55 characters.**Default** None**Command Mode** CONFIGURATION**Usage Information** Supported on the MX9116n and MX5108n switches in Full Switch mode starting in release 10.4.0E(R3S). Also supported in SmartFabric mode starting in release 10.5.0.1.

The `no` version of this command removes the SNMP location.

**Example**

```
OS10(config)# snmp-server location datacenter10
```

**Supported Releases** 10.2.0E or later

## snmp-server user

Authorizes a user to access the SNMP agent and receive SNMP messages.

**Syntax** `snmp-server user user-name group-name security-model [[noauth | auth {md5 | sha} auth-password] [priv {des | aes} priv-password]] [localized] [access acl-name] [remote ip-address udp-port port-number]]`**Parameters**

- `user-name` — Enter the name of the user. A maximum of 32 alphanumeric characters.
- `group-name` — Enter the name of the group to which the user belongs. A maximum of 32 alphanumeric characters.
- `security-model` — Enter an SNMP version that sets the security level for SNMP messages:
  - `1` — SNMPv1 provides no user authentication or privacy protection. SNMP messages are sent in plain text.
  - `2c` — SNMPv2c provides no user authentication or privacy protection. SNMP messages are sent in plain text.
  - `3` — SNMPv3 provides optional user authentication and encryption for SNMP messages.
- `noauth` — (SNMPv3 only) Configure SNMPv3 messages to send without user authentication and privacy encryption.
- `auth` — (SNMPv3 only) Include a user authentication key for SNMPv3 messages sent to the user:
  - `md5` — Generate an authentication key using the MD5 algorithm.
  - `sha` — Generate an authentication key using the SHA algorithm.
  - `auth-password` — Enter a text string used to generate the authentication key that identifies the user; a maximum of 32 alphanumeric characters maximum. For an encrypted password, you can enter the encrypted string instead of plain text.
- `priv` — (SNMPv3 only) Configure encryption for SNMPv3 messages sent to the user:

- o `aes` — Encrypt messages using AES 128-bit algorithm.
- o `des` — Encrypt messages using DES 56-bit algorithm.
- o `priv-password` — Enter a text string used to generate the privacy key used in encrypted messages. A maximum of 32 alphanumeric characters. For an encrypted password, enter the encrypted string instead of plain text.
- `localized` — (SNMPv3 only) Generate an SNMPv3 authentication and/or privacy key in localized key format.
- `access acl-name` — (Optional) Enter the name of an IPv4 or IPv6 access list to filter SNMP requests on the switch. A maximum of 16 characters.
- `remote ip-address/prefix-length udp-port port-number` — (Optional) Enter the IPv4 or IPv6 address of the user's remote device and the UDP port number used to connect to the SNMP agent on the switch, from 0 to 65535. The default is 162.

**Defaults** Not configured

**Command Mode** CONFIGURATION

**Usage Information** Use the `snmp-server user` command to set up the desired security level for SNMP access. For SNMPv3 users, configure user authorization and message encryption. Re-enter this command multiple times to configure SNMP security settings for all users.

The group to which a user is assigned determines the user's SNMP access. To configure a group's SNMP access to the switch — read, write, and notify, use the `snmp-server user` command.

No default values exist for SNMPv3 authentication and privacy algorithms and passwords. If you forget a password, you cannot recover it — you must reconfigure the user. You can specify either a plain-text password or an encrypted cypher-text password. In either case, the password stores in the configuration in an encrypted form and displays as encrypted in the `show running-config snmp` output.

A localized authentication or privacy key is more complex and provides greater privacy protection. To display the localized authentication and privacy keys in an SNMPv3 user configuration, use the `show running-configuration snmp` command.

To limit user access to the SNMP agent on the switch, enter an `access acl-name` value. In IPv6 ACLs, SNMP supports only IPv6 and UDP types. TCP, ICMP, and port rules are not supported.

Supported on the MX9116n and MX5108n switches in Full Switch mode starting in release 10.4.2.0. Also supported in SmartFabric mode starting in release 10.5.0.1.

The `no` version of this command removes a user from the SNMP group.

**Example (Encrypted passwords)**

```
OS10(config)# snmp-server user privuser v3group v3 auth md5
9fc53d9d908118b2804fe80e3ba8763d priv des
d0452401a8c3ce42804fe80e3ba8763d
```

**Example (Plain-text passwords)**

```
OS10(config)# snmp-server user authuser v3group v3 auth md5 authpasswd
```

**Example (Remote user)**

```
OS10(config)# snmp-server user n3user ngroup remote 172.31.1.3 udp-port
5009 3
auth md5 authpasswd
```

**Supported Releases** 10.4.2.0 or later

## snmp-server view

Configures an SNMPv3 view.

**Syntax** `snmp-server view view-name oid-tree [included | excluded]`

**Parameters**

- `view-name` — Enter the name of a read-only, read-write, or notify view. A maximum of 32 characters.

- *oid-tree* — Enter the SNMP object ID at which the view starts in 12-octet dotted-decimal format.
- *included* — (Optional) Include the MIB family in the view.
- *excluded* — (Optional) Exclude the MIB family from the view.

**Defaults** Not configured

**Command Mode** CONFIGURATION

**Usage Information** The *oid-tree* value specifies the OID in the MIB tree hierarchy at which a view starts. Enter *included* or *excluded* to include or exclude the remaining part of the MIB sub-tree contents in the view.

Supported on the MX9116n and MX5108n switches in Full Switch mode starting in release 10.4.2.0. Also supported in SmartFabric mode starting in release 10.5.0.1.

The *no* version of the command removes an SNMPv3 view.

**Example**

```
OS10(config)# snmp-server view readview 1.3.6.5 excluded
```

**Supported Releases** 10.4.2.0 or later

## snmp-server vrf

Configures an SNMP agent to receive SNMP traps for the management VRF instance.

**Syntax** `snmp-server vrf management`

**Parameters** None

**Defaults** Not configured

**Command Mode** CONFIGURATION

**Usage Information** The *no* version of this command disables the SNMP agent from receiving the SNMP traps.

**Example**

```
OS10(config)# snmp-server vrf management
```

**Supported Releases** 10.4.1.0 or later

## Example: Configure SNMP

This example shows how to configure SNMP on the switch, including SNMP engine ID, views, groups, and users.

```
OS10(config)# snmp-server contact "Contact Support"
OS10(config)# snmp-server engineID remote 192.168.1.2 udp-port 502 0xdefa
OS10(config)# snmp-server engineID local test
OS10(config)# snmp-server group sngroup 2c notify notofy_view
OS10(config)# snmp-server group snv3group 3 noauth read_read_view
OS10(config)# snmp-server user snuser sngroup 3 auth sha a2FubmFuX3Rlc3Q=
OS10(config)# snmp-server view readview 1.3.6.1.2.1.2.2 included
OS10(config)# snmp-server view snview .1 excluded
OS10(config)# do show snmp engineID local
Local default SNMP engineID: 0x800002a20474657374

OS10(config)# do show snmp engineID remote
Remote Engine ID IP-addr Port
0xdefa 192.168.1.2 502
OS10(config)# do show snmp group
groupname : sngroup
version : 2c
notifyview : notofy_view
groupname : snv3group
```

```

version : 3
security level : noauth
readview : read_view

OS10(config)# do show snmp user
User name : snuser
Group : sngroup
Version : 3
Authentication Protocol : SHA

OS10(config)# do show snmp view
view name : readview
OID : 1.3.6.1.2.1.2.2
included : True

view name : snview
OID : .1
excluded : True

```

## System clock

OS10 uses the Network Time Protocol (NTP) to synchronize the system clock with a time-serving host. When you enable NTP, it overwrites the system time.

If you do not use NTP, set the system time and time zone after you disable NTP. Use the `clock set` command to set the current system time and date. The hardware-based real-clock time (RTC) resets to the new system time.

Some geographical locations in the world observe the daylight savings time (DST) during summer months. To configure DST, use the `clock timezone {standard-timezone standard-timezone-name | {timezone-string Hours Minutes}}` command. OS10 supports the DST feature only for standard time zones.

OS10 offers the user-defined time zone configuration only for backward compatibility. If you choose to configure a user-defined time zone, you must configure the hour and minute offset from UTC. User-defined time zones do not support DST.

**NOTE:** Dell Technologies recommends configuring a standard time zone supported in Linux. Use the `?` character for command completion to view a list of supported standard time zones.

## Configuration notes

If you configure a time zone for which DST is applicable and you want to downgrade OS10 to an earlier release that does not support DST changes, do one of the following:

- Before you downgrade, disable the DST configuration or update the setting using the `clock timezone` command to specify only the local time zone.
- After the downgrade is complete, ignore the CLI error and reconfigure the setting using the `clock timezone` command to specify only the local time zone.

## Configure system time and date

- Enter the time and date in EXEC mode.

```
clock set time year-month-day
```

- `time` — Enter the time in the format `hour:minute:second`, where `hour` is 1 to 24; `minute` is 1 to 60; `second` is 1 to 60. For example, enter 5:15 PM as `17:15:00`.
  - `year-month-day` — Enter the date in the format `YYYY-MM-DD`, where `YYYY` is a four-digit year, such as 2016; `MM` is a month from 1 to 12; `DD` is a day from 1 to 31.
- Enter the time zone in CONFIGURATION mode.

```
clock timezone {standard-timezone standard-timezone-name | {timezone-string Hours Minutes}}
```



- o *standard-timezone-name* — Enter a standard time zone name that is supported in Linux. To view a list of supported standard time zone names, see the [Time zones and UTC offset reference](#) section.
- o *timezone-string* — Enter the name of the time zone.
- o *hours* — Enter the hour offset from UTC, ranging from -23 to 23.
- o *minutes* - Enter the minute offset from UTC, ranging from 0 to 59.

### Set time and date

```
OS10# clock set 13:00:00 2018-08-30
```

### View system time and date

```
OS10# show clock
2018-08-30T13:01:01.45+00:00
```

### Set time zone

```
OS10(config)# clock timezone standard-timezone Brazil/West
```

### View time zone configured

```
OS10# show clock timezone
Brazil/West (-04, -0400)
```

In this example, -04:00 is the negative offset from UTC for Brazil/West.

## Time zones and UTC offset reference

This section lists the different time zones and corresponding UTC offset.

**Table 7. Time zones and UTC offset**

| Continent/Country | City        | UTC offset |
|-------------------|-------------|------------|
| Africa            | Abidjan     | +00:00     |
|                   | Accra       | +00:00     |
|                   | Addis_Ababa | +03:00     |
|                   | Algiers     | +01:00     |
|                   | Asmara      | +03:00     |
|                   | Bamako      | +00:00     |
|                   | Bangui      | +01:00     |
|                   | Banjul      | +00:00     |
|                   | Bissau      | +00:00     |
|                   | Blantyre    | +02:00     |
|                   | Brazzaville | +01:00     |
|                   | Bujumbura   | +02:00     |
|                   | Cairo       | +02:00     |
|                   | Casablanca  | +01:00     |
|                   | Ceuta       | +01:00     |
|                   | Conakry     | +00:00     |
|                   | Dakar       | +00:00     |
| Dar_es_Salaam     | +03:00      |            |

**Table 7. Time zones and UTC offset (continued)**

| Continent/Country | City         | UTC offset |
|-------------------|--------------|------------|
|                   | Djibouti     | +03:00     |
|                   | Douala       | +01:00     |
|                   | El_Aaiun     | +00:00     |
|                   | Freetown     | +00:00     |
|                   | Gaborone     | +02:00     |
|                   | Harare       | +02:00     |
|                   | Johannesburg | +02:00     |
|                   | Juba         | +03:00     |
|                   | Kampala      | +03:00     |
|                   | Khartoum     | +02:00     |
|                   | Kigali       | +02:00     |
|                   | Kinshasa     | +01:00     |
|                   | Lagos        | +01:00     |
|                   | Libreville   | +01:00     |
|                   | Lome         | +00:00     |
|                   | Luanda       | +01:00     |
|                   | Lubumbashi   | +02:00     |
|                   | Lusaka       | +02:00     |
|                   | Malabo       | +01:00     |
|                   | Maputo       | +02:00     |
|                   | Maseru       | +02:00     |
|                   | Mbabane      | +02:00     |
|                   | Mogadishu    | +03:00     |
|                   | Monrovia     | +00:00     |
|                   | Nairobi      | +03:00     |
|                   | Ndjamena     | +01:00     |
|                   | Niamey       | +01:00     |
|                   | Nouakchott   | +00:00     |
|                   | Ouagadougou  | +00:00     |
|                   | Porto-Novo   | +01:00     |
|                   | Sao_Tome     | +00:00     |
|                   | Timbuktu     | +00:00     |
|                   | Tripoli      | +02:00     |
|                   | Tunis        | +01:00     |
|                   | Windhoek     | +02:00     |
| America           | Adak         | -10:00     |
|                   | Anchorage    | -09:00     |

**Table 7. Time zones and UTC offset (continued)**

| <b>Continent/Country</b> | <b>City</b>              | <b>UTC offset</b> |
|--------------------------|--------------------------|-------------------|
|                          | Anguilla                 | -04:00            |
|                          | Antigua                  | -04:00            |
|                          | Araguaina                | -03:00            |
|                          | Argentina/Buenos_Aires   | -03:00            |
|                          | Argentina/Catamarca      | -03:00            |
|                          | Argentina/ComodRivadavia | -03:00            |
|                          | Argentina/Cordoba        | -03:00            |
|                          | Argentina/Jujuy          | -03:00            |
|                          | Argentina/La_Rioja       | -03:00            |
|                          | Argentina/Mendoza        | -03:00            |
|                          | Argentina/Rio_Gallegos   | -03:00            |
|                          | Argentina/Salta          | -03:00            |
|                          | Argentina/San_Juan       | -03:00            |
|                          | Argentina/San_Luis       | -03:00            |
|                          | Argentina/Tucuman        | -03:00            |
|                          | Argentina/Ushuaia        | -03:00            |
|                          | Aruba                    | -04:00            |
|                          | Asuncion                 | -04:00            |
|                          | Atikokan                 | -05:00            |
|                          | Atka                     | -10:00            |
|                          | Bahia                    | -03:00            |
|                          | Bahia_Banderas           | -06:00            |
|                          | Barbados                 | -04:00            |
|                          | Belem                    | -03:00            |
|                          | Belize                   | -06:00            |
|                          | Blanc-Sablon             | -04:00            |
|                          | Boa_Vista                | -04:00            |
|                          | Bogota                   | -05:00            |
|                          | Boise                    | -07:00            |
|                          | Buenos_Aires             | -03:00            |
|                          | Cambridge_Bay            | -07:00            |
|                          | Campo_Grande             | -04:00            |
|                          | Cancun                   | -05:00            |
|                          | Caracas                  | -04:00            |
|                          | Catamarca                | -03:00            |
|                          | Cayenne                  | -03:00            |
|                          | Cayman                   | -05:00            |

**Table 7. Time zones and UTC offset (continued)**

| Continent/Country | City                 | UTC offset |
|-------------------|----------------------|------------|
|                   | Chicago              | -06:00     |
|                   | Chihuahua            | -07:00     |
|                   | Coral_Harbour        | -05:00     |
|                   | Cordoba              | -03:00     |
|                   | Costa_Rica           | -06:00     |
|                   | Creston              | -07:00     |
|                   | Cuiaba               | -04:00     |
|                   | Curacao              | -04:00     |
|                   | Danmarkshavn         | +00:00     |
|                   | Dawson               | -08:00     |
|                   | Dawson_Creek         | -07:00     |
|                   | Denver               | -07:00     |
|                   | Detroit              | -05:00     |
|                   | Dominica             | -04:00     |
|                   | Edmonton             | -07:00     |
|                   | Eirunepe             | -05:00     |
|                   | El_Salvador          | -06:00     |
|                   | Ensenada             | -08:00     |
|                   | Fort_Nelson          | -07:00     |
|                   | Fort_Wayne           | -05:00     |
|                   | Fortaleza            | -03:00     |
|                   | Glace_Bay            | -04:00     |
|                   | Godthab              | -03:00     |
|                   | Goose_Bay            | -04:00     |
|                   | Grand_Turk           | -05:00     |
|                   | Grenada              | -04:00     |
|                   | Guadeloupe           | -04:00     |
|                   | Guatemala            | -06:00     |
|                   | Guayaquil            | -05:00     |
|                   | Guyana               | -04:00     |
|                   | Halifax              | -04:00     |
|                   | Havana               | -05:00     |
|                   | Hermosillo           | -07:00     |
|                   | Indiana/Indianapolis | -05:00     |
|                   | Indiana/Knox         | -06:00     |
|                   | Indiana/Marengo      | -05:00     |
|                   | Indiana/Petersburg   | -05:00     |

**Table 7. Time zones and UTC offset (continued)**

| <b>Continent/Country</b> | <b>City</b>         | <b>UTC offset</b> |
|--------------------------|---------------------|-------------------|
|                          | Indiana/Tell_City   | -06:00            |
|                          | Indiana/Vevay       | -05:00            |
|                          | Indiana/Vincennes   | -05:00            |
|                          | Indiana/Winamac     | -05:00            |
|                          | Indianapolis        | -05:00            |
|                          | Inuvik              | -07:00            |
|                          | Iqaluit             | -05:00            |
|                          | Jamaica             | -05:00            |
|                          | Jujuy               | -03:00            |
|                          | Juneau              | -09:00            |
|                          | Kentucky/Louisville | -05:00            |
|                          | Kentucky/Monticello | -05:00            |
|                          | Knox_IN             | -06:00            |
|                          | Kralendijk          | -04:00            |
|                          | La_Paz              | -04:00            |
|                          | Lima                | -05:00            |
|                          | Los_Angeles         | -08:00            |
|                          | Louisville          | -05:00            |
|                          | Lower_Princes       | -04:00            |
|                          | Maceio              | -03:00            |
|                          | Managua             | -06:00            |
|                          | Manaus              | -04:00            |
|                          | Marigot             | -04:00            |
|                          | Martinique          | -04:00            |
|                          | Matamoros           | -06:00            |
|                          | Mazatlan            | -07:00            |
|                          | Mendoza             | -03:00            |
|                          | Menominee           | -06:00            |
|                          | Merida              | -06:00            |
|                          | Metlakatla          | -09:00            |
|                          | Mexico_City         | -06:00            |
|                          | Miquelon            | -03:00            |
|                          | Moncton             | -04:00            |
|                          | Monterrey           | -06:00            |
|                          | Montevideo          | -03:00            |
|                          | Montreal            | -05:00            |
|                          | Montserrat          | -04:00            |

**Table 7. Time zones and UTC offset (continued)**

| <b>Continent/Country</b> | <b>City</b>            | <b>UTC offset</b> |
|--------------------------|------------------------|-------------------|
|                          | Nassau                 | -05:00            |
|                          | New_York               | -05:00            |
|                          | Nipigon                | -05:00            |
|                          | Nome                   | -09:00            |
|                          | Noronha                | -02:00            |
|                          | North_Dakota/Beulah    | -06:00            |
|                          | North_Dakota/Center    | -06:00            |
|                          | North_Dakota/New_Salem | -06:00            |
|                          | Ojinaga                | -07:00            |
|                          | Panama                 | -05:00            |
|                          | Pangnirtung            | -05:00            |
|                          | Paramaribo             | -03:00            |
|                          | Phoenix                | -07:00            |
|                          | Port_of_Spain          | -04:00            |
|                          | Port-au-Prince         | -05:00            |
|                          | Porto_Acre             | -05:00            |
|                          | Porto_Velho            | -04:00            |
|                          | Puerto_Rico            | -04:00            |
|                          | Punta_Arenas           | -03:00            |
|                          | Rainy_River            | -06:00            |
|                          | Rankin_Inlet           | -06:00            |
|                          | Recife                 | -03:00            |
|                          | Regina                 | -06:00            |
|                          | Resolute               | -06:00            |
|                          | Rio_Branco             | -05:00            |
|                          | Rosario                | -03:00            |
|                          | Santa_Isabel           | -08:00            |
|                          | Santarem               | -03:00            |
|                          | Santiago               | -04:00            |
|                          | Santo_Domingo          | -04:00            |
|                          | Sao_Paulo              | -03:00            |
|                          | Scoresbysund           | -01:00            |
|                          | Shiprock               | -07:00            |
|                          | Sitka                  | -09:00            |
|                          | St_Barthelemy          | -04:00            |
|                          | St_Johns               | -03:30            |
|                          | St_Kitts               | -04:00            |

**Table 7. Time zones and UTC offset (continued)**

| Continent/Country | City           | UTC offset |
|-------------------|----------------|------------|
|                   | St_Lucia       | -04:00     |
|                   | St_Thomas      | -04:00     |
|                   | St_Vincent     | -04:00     |
|                   | Swift_Current  | -06:00     |
|                   | Tegucigalpa    | -06:00     |
|                   | Thule          | -04:00     |
|                   | Thunder_Bay    | -05:00     |
|                   | Tijuana        | -08:00     |
|                   | Toronto        | -05:00     |
|                   | Tortola        | -04:00     |
|                   | Vancouver      | -08:00     |
|                   | Virgin         | -04:00     |
|                   | Whitehorse     | -08:00     |
|                   | Winnipeg       | -06:00     |
|                   | Yakutat        | -09:00     |
| Yellowknife       | -07:00         |            |
| Antarctica        | Casey          | +11:00     |
|                   | Davis          | +07:00     |
|                   | DumontDURville | +10:00     |
|                   | Macquarie      | +11:00     |
|                   | Mawson         | +05:00     |
|                   | McMurdo        | +12:00     |
|                   | Palmer         | -03:00     |
|                   | Rothera        | -03:00     |
|                   | South_Pole     | +12:00     |
|                   | Syowa          | +03:00     |
|                   | Troll          | +00:00     |
| Vostok            | +06:00         |            |
| Arctic            | Longyearbyen   | +01:00     |
| Asia              | Aden           | +03:00     |
|                   | Almaty         | +06:00     |
|                   | Amman          | +02:00     |
|                   | Anadyr         | +12:00     |
|                   | Aqtau          | +05:00     |
|                   | Aqtobe         | +05:00     |
|                   | Ashgabat       | +05:00     |
|                   | Ashkhabad      | +05:00     |

**Table 7. Time zones and UTC offset (continued)**

| Continent/Country | City        | UTC offset |
|-------------------|-------------|------------|
|                   | Atyrau      | +05:00     |
|                   | Baghdad     | +03:00     |
|                   | Bahrain     | +03:00     |
|                   | Baku        | +04:00     |
|                   | Bangkok     | +07:00     |
|                   | Barnaul     | +07:00     |
|                   | Beirut      | +02:00     |
|                   | Bishkek     | +06:00     |
|                   | Brunei      | +08:00     |
|                   | Calcutta    | +05:30     |
|                   | Chita       | +09:00     |
|                   | Choibalsan  | +08:00     |
|                   | Chongqing   | +08:00     |
|                   | Chungking   | +08:00     |
|                   | Colombo     | +05:30     |
|                   | Dacca       | +06:00     |
|                   | Damascus    | +02:00     |
|                   | Dhaka       | +06:00     |
|                   | Dili        | +09:00     |
|                   | Dubai       | +04:00     |
|                   | Dushanbe    | +05:00     |
|                   | Famagusta   | +02:00     |
|                   | Gaza        | +02:00     |
|                   | Harbin      | +08:00     |
|                   | Hebron      | +02:00     |
|                   | Ho_Chi_Minh | +07:00     |
|                   | Hong_Kong   | +08:00     |
|                   | Hovd        | +07:00     |
|                   | Irkutsk     | +08:00     |
|                   | Istanbul    | +03:00     |
|                   | Jakarta     | +07:00     |
|                   | Jayapura    | +09:00     |
|                   | Jerusalem   | +02:00     |
|                   | Kabul       | +04:30     |
|                   | Kamchatka   | +12:00     |
|                   | Karachi     | +05:00     |
|                   | Kashgar     | +06:00     |



**Table 7. Time zones and UTC offset (continued)**

| <b>Continent/Country</b> | <b>City</b>   | <b>UTC offset</b> |
|--------------------------|---------------|-------------------|
|                          | Kathmandu     | +05:45            |
|                          | Katmandu      | +05:45            |
|                          | Khandyga      | +09:00            |
|                          | Kolkata       | +05:30            |
|                          | Krasnoyarsk   | +07:00            |
|                          | Kuala_Lumpur  | +08:00            |
|                          | Kuching       | +08:00            |
|                          | Kuwait        | +03:00            |
|                          | Macao         | +08:00            |
|                          | Macau         | +08:00            |
|                          | Magadan       | +11:00            |
|                          | Makassar      | +08:00            |
|                          | Manila        | +08:00            |
|                          | Muscat        | +04:00            |
|                          | Novokuznetsk  | +07:00            |
|                          | Novosibirsk   | +07:00            |
|                          | Omsk          | +06:00            |
|                          | Oral          | +05:00            |
|                          | Phnom_Penh    | +07:00            |
|                          | Pontianak     | +07:00            |
|                          | Pyongyang     | +09:00            |
|                          | Qatar         | +03:00            |
|                          | Qyzylorda     | +05:00            |
|                          | Rangoon       | +06:30            |
|                          | Riyadh        | +03:00            |
|                          | Saigon        | +07:00            |
|                          | Sakhalin      | +11:00            |
|                          | Samarkand     | +05:00            |
|                          | Seoul         | +09:00            |
|                          | Shanghai      | +08:00            |
|                          | Singapore     | +08:00            |
|                          | Srednekolymsk | +11:00            |
|                          | Taipei        | +08:00            |
|                          | Tashkent      | +05:00            |
|                          | Tbilisi       | +04:00            |
|                          | Tehran        | +03:30            |
|                          | Tel_Aviv      | +02:00            |

**Table 7. Time zones and UTC offset (continued)**

| Continent/Country | City          | UTC offset |
|-------------------|---------------|------------|
|                   | Thimbu        | +06:00     |
|                   | Thimphu       | +06:00     |
|                   | Tokyo         | +09:00     |
|                   | Tomsk         | +07:00     |
|                   | Ujung_Pandang | +08:00     |
|                   | Ulaanbaatar   | +08:00     |
|                   | Ulan_Bator    | +08:00     |
|                   | Urumqi        | +06:00     |
|                   | Ust-Nera      | +10:00     |
|                   | Vientiane     | +07:00     |
|                   | Vladivostok   | +10:00     |
|                   | Yakutsk       | +09:00     |
|                   | Yangon        | +06:30     |
|                   | Yekaterinburg | +05:00     |
|                   | Yerevan       | +04:00     |
| Atlantic          | Azores        | -01:00     |
|                   | Bermuda       | -04:00     |
|                   | Canary        | +00:00     |
|                   | Cape_Verde    | -01:00     |
|                   | Faeroe        | +00:00     |
|                   | Faroe         | +00:00     |
|                   | Jan_Mayen     | +01:00     |
|                   | Madeira       | +00:00     |
|                   | Reykjavik     | +00:00     |
|                   | South_Georgia | -02:00     |
|                   | St_Helena     | +00:00     |
|                   | Stanley       | -03:00     |
| Australia         | ACT           | +10:00     |
|                   | Adelaide      | +09:30     |
|                   | Brisbane      | +10:00     |
|                   | Broken_Hill   | +09:30     |
|                   | Canberra      | +10:00     |
|                   | Currie        | +10:00     |
|                   | Darwin        | +09:30     |
|                   | Eucla         | +08:45     |
|                   | Hobart        | +10:00     |
|                   | LHI           | +10:30     |

**Table 7. Time zones and UTC offset (continued)**

| Continent/Country | City         | UTC offset |
|-------------------|--------------|------------|
|                   | Lindeman     | +10:00     |
|                   | Lord_Howe    | +10:30     |
|                   | Melbourne    | +10:00     |
|                   | North        | +09:30     |
|                   | NSW          | +10:00     |
|                   | Perth        | +08:00     |
|                   | Queensland   | +10:00     |
|                   | South        | +09:30     |
|                   | Sydney       | +10:00     |
|                   | Tasmania     | +10:00     |
|                   | Victoria     | +10:00     |
|                   | West         | +08:00     |
| Yancowinna        | +09:30       |            |
| Brazil            | Acre         | -05:00     |
|                   | DeNoronha    | -02:00     |
|                   | East         | -03:00     |
|                   | West         | -04:00     |
| Canada            | Atlantic     | -04:00     |
|                   | Central      | -06:00     |
|                   | Eastern      | -05:00     |
|                   | Mountain     | -07:00     |
|                   | Newfoundland | -03:30     |
|                   | Pacific      | -08:00     |
|                   | Saskatchewan | -06:00     |
|                   | Yukon        | -08:00     |
| CET               |              | +01:00     |
| Chile             | Continental  | -04:00     |
|                   | EasterIsland | -06:00     |
| CST6CDT           |              | -05:00     |
| Cuba              |              | -06:00     |
| EET               |              | -05:00     |
| Egypt             |              | +02:00     |
| Eire              |              | +02:00     |
| EST               |              | +00:00     |
| EST5EDT           |              | -05:00     |
| Etc/GMT           |              | -05:00     |
| Etc/GMT+0         |              | +00:00     |

**Table 7. Time zones and UTC offset (continued)**

| Continent/Country | City      | UTC offset |
|-------------------|-----------|------------|
| Etc/GMT+1         |           | +00:00     |
| Etc/GMT+10        |           | -01:00     |
| Etc/GMT+11        |           | -10:00     |
| Etc/GMT+12        |           | -11:00     |
| Etc/GMT+2         |           | -12:00     |
| Etc/GMT+3         |           | -02:00     |
| Etc/GMT+4         |           | -03:00     |
| Etc/GMT+5         |           | -04:00     |
| Etc/GMT+6         |           | -05:00     |
| Etc/GMT+7         |           | -06:00     |
| Etc/GMT+8         |           | -07:00     |
| Etc/GMT+9         |           | -08:00     |
| Etc/GMT0          |           | -09:00     |
| Etc/GMT-0         |           | +00:00     |
| Etc/GMT-1         |           | +00:00     |
| Etc/GMT-10        |           | +01:00     |
| Etc/GMT-11        |           | +10:00     |
| Etc/GMT-12        |           | +11:00     |
| Etc/GMT-13        |           | +12:00     |
| Etc/GMT-14        |           | +13:00     |
| Etc/GMT-2         |           | +14:00     |
| Etc/GMT-3         |           | +02:00     |
| Etc/GMT-4         |           | +03:00     |
| Etc/GMT-5         |           | +04:00     |
| Etc/GMT-6         |           | +05:00     |
| Etc/GMT-7         |           | +06:00     |
| Etc/GMT-8         |           | +07:00     |
| Etc/GMT-9         |           | +08:00     |
| Etc/Greenwich     |           | +09:00     |
| Etc/UCT           |           | +00:00     |
| Etc/Universal     |           | +00:00     |
| Etc/UTC           |           | +00:00     |
| Etc/Zulu          |           | +00:00     |
| Europe            | Amsterdam | +00:00     |
|                   | Andorra   | +01:00     |
|                   | Astrakhan | +01:00     |
|                   | Athens    | +04:00     |

**Table 7. Time zones and UTC offset (continued)**

| <b>Continent/Country</b> | <b>City</b> | <b>UTC offset</b> |
|--------------------------|-------------|-------------------|
|                          | Belfast     | +02:00            |
|                          | Belgrade    | +00:00            |
|                          | Berlin      | +01:00            |
|                          | Bratislava  | +01:00            |
|                          | Brussels    | +01:00            |
|                          | Bucharest   | +01:00            |
|                          | Budapest    | +02:00            |
|                          | Busingen    | +01:00            |
|                          | Chisinau    | +01:00            |
|                          | Copenhagen  | +02:00            |
|                          | Dublin      | +01:00            |
|                          | Gibraltar   | +00:00            |
|                          | Guernsey    | +01:00            |
|                          | Helsinki    | +00:00            |
|                          | Isle_of_Man | +02:00            |
|                          | Istanbul    | +00:00            |
|                          | Jersey      | +03:00            |
|                          | Kaliningrad | +00:00            |
|                          | Kiev        | +02:00            |
|                          | Kirov       | +02:00            |
|                          | Lisbon      | +03:00            |
|                          | Ljubljana   | +00:00            |
|                          | London      | +01:00            |
|                          | Luxembourg  | +00:00            |
|                          | Madrid      | +01:00            |
|                          | Malta       | +01:00            |
|                          | Mariehamn   | +01:00            |
|                          | Minsk       | +02:00            |
|                          | Monaco      | +03:00            |
|                          | Moscow      | +01:00            |
|                          | Nicosia     | +03:00            |
|                          | Oslo        | +02:00            |
|                          | Paris       | +01:00            |
|                          | Podgorica   | +01:00            |
|                          | Prague      | +01:00            |
|                          | Riga        | +02:00            |
|                          | Rome        | +01:00            |

**Table 7. Time zones and UTC offset (continued)**

| Continent/Country | City         | UTC offset |
|-------------------|--------------|------------|
|                   | Samara       | +04:00     |
|                   | San_Marino   | +01:00     |
|                   | Sarajevo     | +01:00     |
|                   | Saratov      | +04:00     |
|                   | Simferopol   | +03:00     |
|                   | Skopje       | +01:00     |
|                   | Sofia        | +02:00     |
|                   | Stockholm    | +01:00     |
|                   | Tallinn      | +02:00     |
|                   | Tirane       | +01:00     |
|                   | Tiraspol     | +02:00     |
|                   | Ulyanovsk    | +04:00     |
|                   | Uzhgorod     | +02:00     |
|                   | Vaduz        | +01:00     |
|                   | Vatican      | +01:00     |
|                   | Vienna       | +01:00     |
|                   | Vilnius      | +02:00     |
|                   | Volgograd    | +04:00     |
|                   | Warsaw       | +01:00     |
|                   | Zagreb       | +01:00     |
|                   | Zaporozhye   | +02:00     |
|                   | Zurich       | +01:00     |
| GB                |              | +00:00     |
| GB-Eire           |              | +00:00     |
| GMT               |              | +00:00     |
| GMT+0             |              | +00:00     |
| GMT0              |              | +00:00     |
| GMT-0             |              | +00:00     |
| Greenwich         |              | +00:00     |
| Hongkong          |              | +08:00     |
| HST               |              | -10:00     |
| Iceland           |              | +00:00     |
| Indian            | Antananarivo | +03:00     |
|                   | Chagos       | +06:00     |
|                   | Christmas    | +07:00     |
|                   | Cocos        | +06:30     |
|                   | Comoro       | +03:00     |

**Table 7. Time zones and UTC offset (continued)**

| Continent/Country | City         | UTC offset |
|-------------------|--------------|------------|
|                   | Kerguelen    | +05:00     |
|                   | Mahe         | +04:00     |
|                   | Maldives     | +05:00     |
|                   | Mauritius    | +04:00     |
|                   | Mayotte      | +03:00     |
|                   | Reunion      | +04:00     |
| Iran              |              | +03:30     |
| Israel            |              | +02:00     |
| Jamaica           |              | -05:00     |
| Japan             |              | +09:00     |
| Kwajalein         |              | +12:00     |
| Libya             |              | +02:00     |
| MET               |              | +01:00     |
| Mexico            | BajaNorte    | -08:00     |
|                   | BajaSur      | -07:00     |
|                   | General      | -06:00     |
| MST               |              | -07:00     |
| MST7MDT           |              | -07:00     |
| Navajo            |              | -07:00     |
| NZ                |              | +12:00     |
| NZ-CHAT           |              | +12:45     |
| Pacific           | Apia         | +13:00     |
|                   | Auckland     | +12:00     |
|                   | Bougainville | +11:00     |
|                   | Chatham      | +12:45     |
|                   | Chuuk        | +10:00     |
|                   | Easter       | -06:00     |
|                   | Efate        | +11:00     |
|                   | Enderbury    | +13:00     |
|                   | Fakaofu      | +13:00     |
|                   | Fiji         | +12:00     |
|                   | Funafuti     | +12:00     |
|                   | Galapagos    | -06:00     |
|                   | Gambier      | -09:00     |
|                   | Guadalcanal  | +11:00     |
|                   | Guam         | +10:00     |
| Honolulu          | -10:00       |            |

**Table 7. Time zones and UTC offset (continued)**

| Continent/Country | City         | UTC offset |
|-------------------|--------------|------------|
|                   | Johnston     | -10:00     |
|                   | Kiritimati   | +14:00     |
|                   | Kosrae       | +11:00     |
|                   | Kwajalein    | +12:00     |
|                   | Majuro       | +12:00     |
|                   | Marquesas    | -09:30     |
|                   | Midway       | -11:00     |
|                   | Nauru        | +12:00     |
|                   | Niue         | -11:00     |
|                   | Norfolk      | +11:00     |
|                   | Noumea       | +11:00     |
|                   | Pago_Pago    | -11:00     |
|                   | Palau        | +09:00     |
|                   | Pitcairn     | -08:00     |
|                   | Pohnpei      | +11:00     |
|                   | Ponape       | +11:00     |
|                   | Port_Moresby | +10:00     |
|                   | Rarotonga    | -10:00     |
|                   | Saipan       | +10:00     |
|                   | Samoa        | -11:00     |
|                   | Tahiti       | -10:00     |
|                   | Tarawa       | +12:00     |
|                   | Tongatapu    | +13:00     |
|                   | Truk         | +10:00     |
|                   | Wake         | +12:00     |
|                   | Wallis       | +12:00     |
|                   | Yap          | +10:00     |
| Poland            |              | +01:00     |
| Portugal          |              | +00:00     |
| PRC               |              | +08:00     |
| PST8PDT           |              | -08:00     |
| ROC               |              | +08:00     |
| ROK               |              | +09:00     |
| Singapore         |              | +08:00     |
| Turkey            |              | +03:00     |
| UCT               |              | +00:00     |
| Universal         |              | +00:00     |



**Table 7. Time zones and UTC offset (continued)**

| Continent/Country | City           | UTC offset |
|-------------------|----------------|------------|
| US                | Alaska         | -09:00     |
|                   | Aleutian       | -10:00     |
|                   | Arizona        | -07:00     |
|                   | Central        | -06:00     |
|                   | Eastern        | -05:00     |
|                   | East-Indiana   | -05:00     |
|                   | Hawaii         | -10:00     |
|                   | Indiana-Starke | -06:00     |
|                   | Michigan       | -05:00     |
|                   | Mountain       | -07:00     |
|                   | Pacific        | -08:00     |
|                   | Pacific-New    | -08:00     |
| Samoa             | -11:00         |            |
| UTC               |                | +00:00     |
| WET               |                | +00:00     |
| W-SU              |                | +03:00     |
| Zulu              |                | +00:00     |

## System Clock commands

### clock set

Sets the system time.

**Syntax** `clock set time year-month-day`

**Parameters**

***time*** Enter *time* in the format *hour:minute:second*, where *hour* is 1 to 24; *minute* is 1 to 60; *second* is 1 to 60. For example, enter 5:15 PM as 17:15:00.

***year-month-day*** Enter *year-month-day* in the format YYYY-MM-DD, where YYYY is a four-digit year, such as 2016; MM is a month from 1 to 12; DD is a day from 1 to 31.

**Default** Not configured

**Command Mode** EXEC

**Usage Information** Use this command to reset the system time if the system clock is out of synch with the NTP time. The hardware-based real-clock time (RTC) resets to the new time. The new system clock setting applies immediately.

Supported on the MX9116n and MX5108n switches in Full Switch mode starting in release 10.4.0E(R3S). Also supported in SmartFabric mode starting in release 10.5.0.1.

**Example**

```
OS10# clock set 18:30:10 2017-01-25
```

**Supported Releases** 10.2.1E or later

## clock timezone

Configures the standard or user-defined time zone that OS10 applies on top of the system clock.

|                          |                                                                                                                                                                                                                                                                                                                                                                                                                                                                                                                                                                                                                                                                                                                                                                                                                                                                                                                                                                                       |
|--------------------------|---------------------------------------------------------------------------------------------------------------------------------------------------------------------------------------------------------------------------------------------------------------------------------------------------------------------------------------------------------------------------------------------------------------------------------------------------------------------------------------------------------------------------------------------------------------------------------------------------------------------------------------------------------------------------------------------------------------------------------------------------------------------------------------------------------------------------------------------------------------------------------------------------------------------------------------------------------------------------------------|
| <b>Syntax</b>            | <code>clock timezone {standard-timezone <i>standard-timezone-name</i>   {<i>timezone-string</i> <i>hours</i> <i>minutes</i>}}</code>                                                                                                                                                                                                                                                                                                                                                                                                                                                                                                                                                                                                                                                                                                                                                                                                                                                  |
| <b>Parameters</b>        | <ul style="list-style-type: none"><li>• <i>standard-timezone-name</i> — Enter the standard time zone name that is supported in Linux. To view a list of supported standard time zone names, see the <a href="#">Time zones and UTC offset reference</a> section.</li><li>• <i>timezone-string</i> — Enter the name of the time zone.</li><li>• <i>hours</i> — Enter the hour offset from UTC, ranging from -23 to 23.</li><li>• <i>minutes</i> — Enter the minute offset from UTC, ranging from 0 to 59.</li></ul>                                                                                                                                                                                                                                                                                                                                                                                                                                                                    |
| <b>Default</b>           | Not configured                                                                                                                                                                                                                                                                                                                                                                                                                                                                                                                                                                                                                                                                                                                                                                                                                                                                                                                                                                        |
| <b>Command Mode</b>      | CONFIGURATION                                                                                                                                                                                                                                                                                                                                                                                                                                                                                                                                                                                                                                                                                                                                                                                                                                                                                                                                                                         |
| <b>Usage Information</b> | <p>The standard time zone option applies the predefined offset for the selected standard time zone, including DST changes that apply to the local time. After you configure this command, OS10 uses the updated local time in all logs and timestamps. You can use the <code>?</code> character or press the <code>tab</code> key for command completion and view a list of supported standard time zones. To view a list of supported standard time zone names, see the <a href="#">Time zones and UTC offset reference</a> section. Define region names with a <code>/</code> at the end of the string. The <code>/</code> character indicates that a time zone string follows the region name. For example, "Asia/Calcutta." The <code>no</code> form of the command resets the local time to UTC.</p> <p>Supported on the MX9116n and MX5108n switches in Full Switch mode starting in release 10.4.0E(R3S). Also supported in SmartFabric mode starting in release 10.5.0.1.</p> |

### Example

```
OS10(config)# clock timezone standard-timezone Brazil/West
```

### Supported Releases

10.3.0E or later

## show clock

Displays the current system clock settings.

|                          |                                                                                                                                                                                                                                                                                                                            |
|--------------------------|----------------------------------------------------------------------------------------------------------------------------------------------------------------------------------------------------------------------------------------------------------------------------------------------------------------------------|
| <b>Syntax</b>            | <code>show clock</code>                                                                                                                                                                                                                                                                                                    |
| <b>Parameters</b>        | None                                                                                                                                                                                                                                                                                                                       |
| <b>Default</b>           | Not configured                                                                                                                                                                                                                                                                                                             |
| <b>Command Mode</b>      | EXEC                                                                                                                                                                                                                                                                                                                       |
| <b>Usage Information</b> | <p>The universal time coordinated (UTC) value is the number of hours that your time zone is later or earlier than UTC/Greenwich mean time.</p> <p>Supported on the MX9116n and MX5108n switches in Full Switch mode starting in release 10.4.0E(R3S). Also supported in SmartFabric mode starting in release 10.5.0.1.</p> |

### Example

```
OS10# show clock
2017-01-25T11:00:31.68-08:00
```

### Supported Releases

10.2.1E or later

## show clock timezone

Displays the time zone that is configured in the system.

**Syntax** `show clock timezone`

|                           |                                                                                                                                                                  |
|---------------------------|------------------------------------------------------------------------------------------------------------------------------------------------------------------|
| <b>Parameters</b>         | None                                                                                                                                                             |
| <b>Default</b>            | Etc/UTC                                                                                                                                                          |
| <b>Command Mode</b>       | EXEC                                                                                                                                                             |
| <b>Usage Information</b>  | Supported on the MX9116n and MX5108n switches in Full Switch mode starting in release 10.5.0.0. Also supported in SmartFabric mode starting in release 10.5.0.1. |
| <b>Example</b>            | <pre>OS10# show clock timezone Brazil/West (-04, -0400)</pre>                                                                                                    |
| <b>Supported Releases</b> | 10.5.0 or later                                                                                                                                                  |

## Network Time Protocol

Network Time Protocol (NTP) synchronizes timekeeping among a set of distributed time servers and clients. The protocol coordinates time distribution in a large, diverse network. NTP clients synchronize with NTP servers that provide accurate time measurement. NTP clients choose from several NTP servers to determine which offers the best available source of time and the most reliable transmission of information.

To get the correct time, OS10 synchronizes with a time-serving host. For the current time, you can set the system to poll specific NTP time-serving hosts. From those time-serving hosts, the system chooses one NTP host to synchronize with and acts as a client to the NTP host. After the host-client relationship establishes, the networking device propagates the time information throughout its local network.

The NTP client sends messages to one or more servers and processes the replies as received. Information in the NTP message allows each client/server peer to determine the timekeeping characteristics of its other peers, including the expected accuracies of their clocks. Using this information, each peer selects the best time from several other clocks, updates the local clock, and estimates its accuracy.

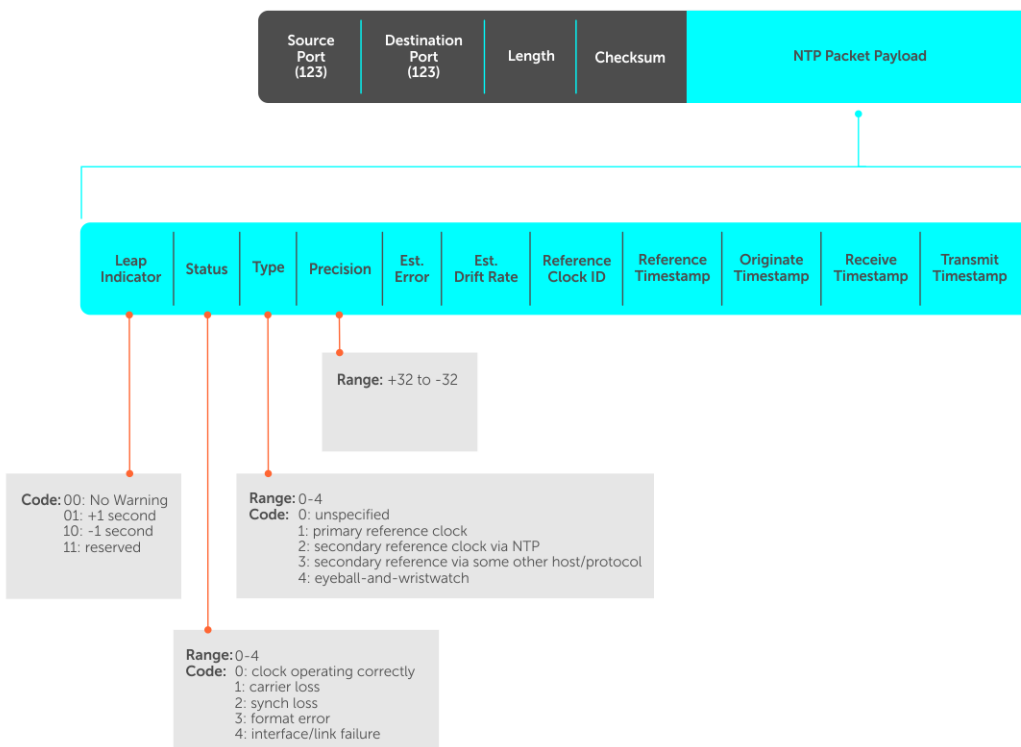

**NOTE:** OS10 supports both NTP server and client roles.

## Enable NTP

NTP is disabled by default. To enable NTP, configure an NTP server where the system synchronizes. To configure multiple servers, enter the command multiple times. Multiple servers may impact CPU resources.

- Enter the IP address of the NTP server where the system synchronizes in CONFIGURATION mode.

```
ntp server ip-address
```

### View system clock state

```
OS10(config)# do show ntp status
system peer: 0.0.0.0
system peer mode: unspec
leap indicator: 11
stratum: 16
precision: -22
root distance: 0.00000 s
root dispersion: 1.28647 s
reference ID: [73.78.73.84]
reference time: 00000000.00000000 Mon, Jan 1 1900 0:00:00.000
system flags: monitor ntp kernel stats
jitter: 0.000000 s
stability: 0.000 ppm
broadcastdelay: 0.000000 s
authdelay: 0.000000 s
```

### View calculated NTP synchronization variables

```
OS10(config)# do show ntp associations
=====
remote local st poll reach delay offset disp
=====
10.16.150.185 10.16.151.123 16 1024 0 0.00000 0.000000 3.99217
OS10# show ntp associations
remote local st poll reach delay offset disp
=====
10.16.150.185 10.16.151.123 16 1024 0 0.00000 0.000000 3.99217
```

## Broadcasts

Receive broadcasts of time information and set interfaces within the system to receive NTP information through broadcast. NTP is enabled on all active interfaces by default. If you disable NTP on an interface, the system drops any NTP packets sent to that interface.

1. Set the interface to receive NTP packets in INTERFACE mode.

```
ntp broadcast client
```

2. Disable NTP on the interface in INTERFACE mode.

```
ntp disable
```

### Configure NTP broadcasts

```
OS10(config)# interface ethernet 1/1/10
OS10(conf-if-eth1/1/10)# ntp broadcast client
```

### Disable NTP broadcasts

```
OS10(config)# interface ethernet 1/1/10
OS10(conf-if-eth1/1/10)# ntp disable
```

## Source IP address

Configure one interface IP address to include in all NTP packets. The source address of NTP packets is the interface IP address the system uses to reach the network by default.

- Configure a source IP address for NTP packets in CONFIGURATION mode.

```
ntp source interface
```

- `ethernet node/slot/port[:subport]`—Enter the Ethernet interface information.
- `port-channel channel-id`—Enter the port-channel ID, from 1 to 128.
- `vlan vlan-id`—Enter the VLAN ID number, from 1 to 4093.
- `loopback id`—Enter the Loopback interface ID number, from 0 to 16383.
- `mgmt node/slot/port`—Enter the physical port interface for the Management interface. The default is 1/1/1.

### Configure the source IP address

```
OS10(config)# ntp source ethernet 1/1/10
```

### View the source IP configuration

```
OS10(config)# do show running-configuration | grep source
ntp source ethernet1/1/1
```

## Authentication

NTP authentication and the corresponding trusted key provide a reliable exchange of NTP packets with trusted time sources. NTP authentication begins with creating the first NTP packet after the key configuration. NTP authentication uses the message digest 5 (MD5), SHA-1, and SHA2-256 algorithms. The key is embedded in the synchronization packet that is sent to an NTP time source.

1. Enable NTP authentication in CONFIGURATION mode.

```
ntp authenticate
```

2. Set an authentication key number and key in CONFIGURATION mode, from 1 to 65535.

```
ntp authentication-key number hash-algorithm {0|9} key
```

- The *number* must match in the `ntp trusted-key` command.
  - The supported *hash-algorithms* include `md5`, `sha1`, and `sha2-256`.
  - The `0` specifies an unencrypted authentication key and `1` specifies an encrypted authentication key.
  - The *key* is an encrypted string.
3. Define a trusted key in CONFIGURATION mode, from 1 to 65535. This *number* must match the configured NTP authentication key.

```
ntp trusted-key number
```

4. Configure an NTP server in CONFIGURATION mode.

```
ntp server {hostname | ipv4-address | ipv6-address} [key keyid] [prefer]
```

- *hostname*—Enter the keyword to see the IP address or hostname of the remote device.
  - *ipv4-address*—Enter an IPv4 address in `A.B.C.D` format.
  - *ipv6-address*—Enter an IPv6 address in `nnnn:nnnn:nnnn:nnnn:nnnn:nnnn:nnnn:nnnn` format. Elision of zeros is supported.
  - *key keyid*—Enter a text string as the key exchanged between the NTP server and the client.
  - *prefer*—Enter the keyword to set this NTP server as the preferred server.
5. Configure the NTP master and enter the stratum number that identifies the NTP server hierarchy in CONFIGURATION mode, from 2 to 10. The default is 8.

The `ntp master` command enables the local switch to serve time to other client devices when the configured real-time sources are not reachable.

```
ntp master {2-10}
```

### Configure NTP

```
OS10(config)# ntp authenticate
OS10(config)# ntp trusted-key 345
OS10(config)# ntp authentication-key 345 md5 0 5A60910FED211F02
OS10(config)# ntp server 1.1.1.1 key 345
OS10(config)# ntp master 7
```

### View NTP configuration

```
OS10(config)# do show running-configuration
!
ntp authenticate
ntp authentication-key 345 md5 0 5A60910FED211F02
ntp server 1.1.1.1 key 345
ntp trusted-key 345
ntp master 7
...
```

## Sample NTP configuration

The following example shows an NTP master (11.0.0.2), server (10.0.0.1), and client (10.0.0.2) connected through a nondefault VRF instance (VRF Red). OS10 acts as an NTP server to synchronize its clock with the NTP master available in the nondefault VRF instance red and provides time to NTP clients in the VRF.

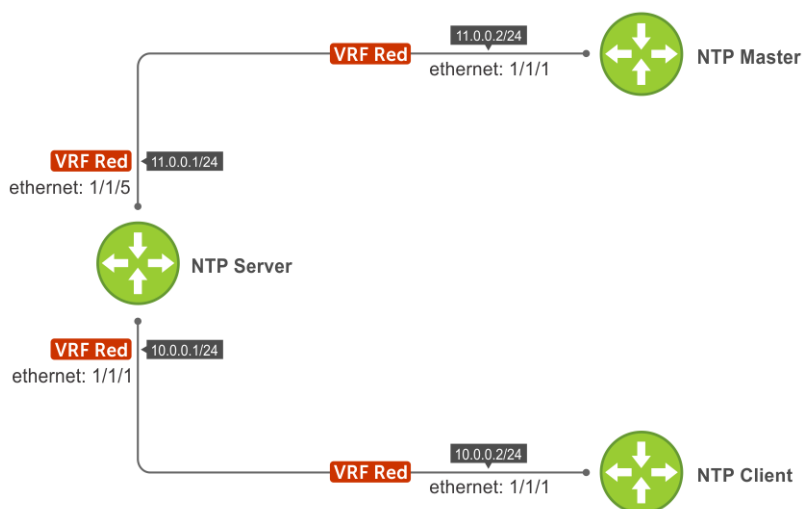

To create this sample NTP configuration:

#### 1. Configure the NTP server:

- a. Create a nondefault VRF instance and assign an interface to the VRF.

```
OS10(conf-vrf)# exit
OS10(config)# interface ethernet 1/1/1
OS10(conf-if-eth1/1/1)# no switchport
OS10(conf-if-eth1/1/1)# ip vrf forwarding red
OS10(conf-if-eth1/1/1)# ip address 10.0.0.1/24
OS10(conf-if-eth1/1/1)# exit
OS10(config)# interface ethernet 1/1/5
OS10(conf-if-eth1/1/5)# no switchport
OS10(conf-if-eth1/1/5)# ip vrf forwarding red
```

```
OS10(config-if-eth1/1/5)# ip address 11.0.0.1/24
OS10(config-if-eth1/1/5)# exit
OS10(config)#
```

- b. Configure the NTP master IP address on the NTP server. (In the example, NTP master 11.0.0.2, is reachable only through VRF Red.)

```
OS10(config)# ntp server 11.0.0.2
OS10(config)# do show running-configuration ntp
ntp server 11.0.0.2
OS10(config)#
```

- c. Configure NTP in the VRF Red instance.

```
OS10(config)# ntp enable vrf red

"% Warning: NTP server/client will be disabled in default VRF and enabled on a red
VRF"
Do you wish to continue? (y/n): y

OS10(config)#
OS10(config)# do show running-configuration ntp
ntp server 11.0.0.2
ntp enable vrf red
OS10(config)#
```

## 2. Configure an NTP client:

- a. Create a nondefault VRF instance and assign an interface to the VRF.

```
OS10(config)# ip vrf red
OS10(config-vrf)# exit
OS10(config)# interface ethernet 1/1/1
OS10(config-if-eth1/1/1)# no switchport
OS10(config-if-eth1/1/1)# ip vrf forwarding red
OS10(config-if-eth1/1/1)# ip address 10.0.0.2/24
OS10(config-if-eth1/1/1)# exit
OS10(config)#
```

- b. Configure the NTP server IP address on the NTP client.

```
OS10(config)# ntp server 10.0.0.1
OS10(config)# do show running-configuration ntp
ntp server 10.0.0.1
OS10(config)#
```

- c. Configure NTP in the VRF Red instance.

```
OS10(config)# ntp enable vrf red

"% Warning: NTP server/client will be disabled in default VRF and enabled on a red
VRF"
Do you wish to continue? (y/n): y

OS10(config)# do show running-configuration ntp
ntp server 10.0.0.1
ntp enable vrf red
OS10(config)#
```

## 3. Configure an NTP master:

- a. Create a nondefault VRF instance and assign an interface to the VRF.

```
OS10(config)# ip vrf red
OS10(config-vrf)# exit
OS10(config)# interface ethernet 1/1/1
OS10(config-if-eth1/1/1)# no switchport
OS10(config-if-eth1/1/1)# ip vrf forwarding red
OS10(config-if-eth1/1/1)# ip address 11.0.0.2/24
OS10(config-if-eth1/1/1)# exit
OS10(config)#
```

- b. Configure NTP as master.

```
OS10(config)# ntp master
OS10(config)# do show running-configuration ntp
ntp master 8
OS10(config)#
```

- c. Configure NTP in the VRF Red instance.

```
OS10(config)# ntp enable vrf red

"% Warning: NTP server/client will be disabled in default VRF and enabled on a red
VRF"
Do you wish to continue? (y/n): y

OS10(config)# do show running-configuration ntp
ntp master 8
ntp enable vrf red
OS10(config)#
```

4. Verify that the NTP client (10.0.0.2) is connected to the NTP server (10.0.0.1) running in VRF Red.

```
OS10# show ntp associations vrf red

 remote refid st t when poll reach delay offset jitter
=====
*10.0.0.1 11.0.0.2 10 u 2 64 1 0.578 -1.060 0.008

OS10# show ntp status vrf red
associd=0 status=0615 leap_none, sync_ntp, 1 event, clock_sync,
system peer: 10.0.0.1:123
system peer mode: client
leap indicator: 00
stratum: 11
log2 precision: -24
root delay: 0.991
root dispersion: 1015.099
reference ID: 10.0.0.1
reference time: dbc7b087.5d47aaa6 Sat, Nov 5 2016 1:12:39.364
system jitter: 0.000000
clock jitter: 0.462
clock wander: 0.003
broadcast delay: -50.000
symm. auth. delay: 0.000
OS10#
```

5. Verify that the NTP server (10.0.0.1) is connected to the NTP master (11.0.0.2) running in VRF Red.

```
OS10(config)# do show ntp associations vrf red

 remote refid st t when poll reach delay offset jitter
=====
LOCAL(0) .LOCL. 8 l 111 64 2 0.000 0.000 0.000
*11.0.0.2 LOCAL(0) 9 u 43 64 3 0.441 0.026 0.047

OS10(config)# do show ntp status vrf red
associd=0 status=0615 leap_none, sync_ntp, 1 event, clock_sync,
system peer: 11.0.0.2:123
system peer mode: client
leap indicator: 00
stratum: 10
log2 precision: -24
root delay: 0.441
root dispersion: 950.580
reference ID: 11.0.0.2
reference time: dbc7b03e.733f51d7 Sat, Nov 5 2016 1:11:26.450
system jitter: 0.000000
clock jitter: 0.009
```



```
clock wander: 0.000
broadcast delay: -50.000
symm. auth. delay: 0.000
OS10(config)#
```

## NTP commands

### ntp authenticate

Enables authentication of NTP traffic between the device and the NTP time serving hosts.

|                          |                                                                                                                                                                                                                                                                                                                                                            |
|--------------------------|------------------------------------------------------------------------------------------------------------------------------------------------------------------------------------------------------------------------------------------------------------------------------------------------------------------------------------------------------------|
| <b>Syntax</b>            | <code>ntp authenticate</code>                                                                                                                                                                                                                                                                                                                              |
| <b>Parameters</b>        | None                                                                                                                                                                                                                                                                                                                                                       |
| <b>Default</b>           | Not configured                                                                                                                                                                                                                                                                                                                                             |
| <b>Command Mode</b>      | CONFIGURATION                                                                                                                                                                                                                                                                                                                                              |
| <b>Usage Information</b> | Configure an authentication key for NTP traffic using the <code>ntp authentication-key</code> command.<br>Supported on the MX9116n and MX5108n switches in Full Switch mode starting in release 10.4.0E(R3S). Also supported in SmartFabric mode starting in release 10.5.0.1.<br>The <code>no</code> version of this command disables NTP authentication. |

#### Example

```
OS10(config)# ntp authenticate
```

**Supported Releases** 10.2.0E or later

### ntp authentication-key

Configures the authentication key for trusted time sources.

|                          |                                                                                                                                                                                                                                                                                                                                                                                                                                                                                              |
|--------------------------|----------------------------------------------------------------------------------------------------------------------------------------------------------------------------------------------------------------------------------------------------------------------------------------------------------------------------------------------------------------------------------------------------------------------------------------------------------------------------------------------|
| <b>Syntax</b>            | <code>ntp authentication-key <i>number</i> {md5   sha1   sha2-256} {0   9} <i>key</i></code>                                                                                                                                                                                                                                                                                                                                                                                                 |
| <b>Parameters</b>        | <ul style="list-style-type: none"><li>• <i>number</i>—Enter the authentication key number, from 1 to 65535.</li><li>• <code>md5</code>—Set to MD5 encryption.</li><li>• <code>sha1</code>—Set to SHA-1 encryption.</li><li>• <code>sha2-256</code>—Set to SHA2-256 encryption.</li><li>• <code>0</code>—Set to unencrypted format, the default.</li><li>• <code>9</code>—Set to hidden encryption.</li><li>• <i>key</i>—Enter the authentication key.</li></ul>                              |
| <b>Default</b>           | 0                                                                                                                                                                                                                                                                                                                                                                                                                                                                                            |
| <b>Command Mode</b>      | CONFIGURATION                                                                                                                                                                                                                                                                                                                                                                                                                                                                                |
| <b>Usage Information</b> | The authentication number must be the same as the <i>number</i> parameter configured in the <code>ntp trusted-key</code> command. Use the <code>ntp authenticate</code> command to enable NTP authentication. The supported values for <code>md5</code> , <code>sha1</code> , and <code>sha2-256</code> are 0 and 9.<br>Supported on the MX9116n and MX5108n switches in Full Switch mode starting in release 10.4.0E(R3S). Also supported in SmartFabric mode starting in release 10.5.0.1. |

#### Example

```
OS10(config)# ntp authentication-key 1200 md5 0 dell
```

**Supported Releases** 10.2.0E or later

## ntp broadcast client

Configures all active interfaces to receive NTP broadcasts from an NTP server.

|                          |                                                                      |
|--------------------------|----------------------------------------------------------------------|
| <b>Syntax</b>            | <code>ntp broadcast client</code>                                    |
| <b>Parameters</b>        | None                                                                 |
| <b>Default</b>           | Not configured                                                       |
| <b>Command Mode</b>      | GLOBAL CONFIGURATION                                                 |
| <b>Usage Information</b> | The <code>no</code> version of this command disables NTP broadcasts. |

**Example**

```
OS10(config)# ntp broadcast client
```

**Supported Releases** 10.2.0E or later

## ntp disable

By default, NTP is enabled on all interfaces. Disable NTP to prevent an interface from receiving NTP packets.

|                          |                                                                                                                                                                                                          |
|--------------------------|----------------------------------------------------------------------------------------------------------------------------------------------------------------------------------------------------------|
| <b>Syntax</b>            | <code>ntp disable</code>                                                                                                                                                                                 |
| <b>Parameters</b>        | None                                                                                                                                                                                                     |
| <b>Default</b>           | Enabled                                                                                                                                                                                                  |
| <b>Command Mode</b>      | INTERFACE                                                                                                                                                                                                |
| <b>Usage Information</b> | Use this command to configure OS10 to not listen to a particular server and prevent the interface from receiving NTP packets. The <code>no</code> version of this command reenables NTP on an interface. |

**Example**

```
OS10(conf-if-eth1/1/7)# ntp disable
```

**Supported Releases** 10.2.0E or later

## ntp enable vrf

Enables NTP for the management or nondefault VRF instance.

|                          |                                                                                                                                                                                                                                                                       |
|--------------------------|-----------------------------------------------------------------------------------------------------------------------------------------------------------------------------------------------------------------------------------------------------------------------|
| <b>Syntax</b>            | <code>ntp enable vrf {management   vrf-name}</code>                                                                                                                                                                                                                   |
| <b>Parameters</b>        | <ul style="list-style-type: none"><li>• <code>management</code>—Enter the keyword to enable NTP for the management VRF instance.</li><li>• <code>vrf-name</code>—Enter the keyword then the name of the VRF to enable NTP for that nondefault VRF instance.</li></ul> |
| <b>Defaults</b>          | Disabled                                                                                                                                                                                                                                                              |
| <b>Command Mode</b>      | CONFIGURATION                                                                                                                                                                                                                                                         |
| <b>Usage Information</b> | The <code>no</code> version of this command disables NTP for the management VRF instance.                                                                                                                                                                             |

**Example**

```
OS10(config)# ntp enable vrf management
OS10(config)# ntp enable vrf vrf-blue
```

**Supported Releases** 10.4.0E(R1) or later

## ntp master

Configures an NTP Master Server.

|                           |                                                                                                                                                                                                                                                     |
|---------------------------|-----------------------------------------------------------------------------------------------------------------------------------------------------------------------------------------------------------------------------------------------------|
| <b>Syntax</b>             | <code>ntp master <i>stratum</i></code>                                                                                                                                                                                                              |
| <b>Parameters</b>         | <i>stratum</i> —Enter the stratum number to identify the NTP server hierarchy, from 2 to 10.                                                                                                                                                        |
| <b>Default</b>            | 8                                                                                                                                                                                                                                                   |
| <b>Command Mode</b>       | CONFIGURATION                                                                                                                                                                                                                                       |
| <b>Usage Information</b>  | Supported on the MX9116n and MX5108n switches in Full Switch mode starting in release 10.4.0E(R3S). Also supported in SmartFabric mode starting in release 10.5.0.1<br>The <code>no</code> version of this command resets the value to the default. |
| <b>Example</b>            | <pre>OS10(config)# ntp master 6</pre>                                                                                                                                                                                                               |
| <b>Supported Releases</b> | 10.2.0E or later                                                                                                                                                                                                                                    |

## ntp server

Configures an NTP time-serving host.

|                           |                                                                                                                                                                                                                                                                                                                                                                                                                                                                                                                                            |
|---------------------------|--------------------------------------------------------------------------------------------------------------------------------------------------------------------------------------------------------------------------------------------------------------------------------------------------------------------------------------------------------------------------------------------------------------------------------------------------------------------------------------------------------------------------------------------|
| <b>Syntax</b>             | <code>ntp server {<i>hostname</i>   <i>ipv4-address</i>   <i>ipv6-address</i>} [<i>key keyid</i>] [<i>prefer</i>]</code>                                                                                                                                                                                                                                                                                                                                                                                                                   |
| <b>Parameters</b>         | <ul style="list-style-type: none"><li>• <i>hostname</i>—Enter the hostname of the server.</li><li>• <i>ipv4-address</i>   <i>ipv6-address</i>—Enter the IPv4 address in A.B.C.D format or IPv6 address in A::B format of the NTP server.</li><li>• <i>key keyid</i>—(Optional) Enter the NTP peer key ID, from 1 to 4294967295.</li><li>• <i>prefer</i>—(Optional) Configures this peer to have priority over other servers.</li></ul>                                                                                                     |
| <b>Default</b>            | Not configured                                                                                                                                                                                                                                                                                                                                                                                                                                                                                                                             |
| <b>Command Mode</b>       | CONFIGURATION                                                                                                                                                                                                                                                                                                                                                                                                                                                                                                                              |
| <b>Usage Information</b>  | You can configure multiple time-serving hosts. From these time-serving hosts, the system chooses one NTP host to synchronize with. To determine which server to select, use the <code>show ntp associations</code> command. Dell Technologies recommends limiting the number of hosts you configure, as many polls to the NTP hosts can impact network performance.<br>Supported on the MX9116n and MX5108n switches in Full Switch mode starting in release 10.4.0E(R3S). Also supported in SmartFabric mode starting in release 10.5.0.1 |
| <b>Example</b>            | <pre>OS10(config)# ntp server eureka.com</pre>                                                                                                                                                                                                                                                                                                                                                                                                                                                                                             |
| <b>Supported Releases</b> | 10.2.0E or later                                                                                                                                                                                                                                                                                                                                                                                                                                                                                                                           |

## ntp source

Configures an interface IP address to include in NTP packets.

|                   |                                                                                                                                                                                                                                                                                                                                                                                                                                       |
|-------------------|---------------------------------------------------------------------------------------------------------------------------------------------------------------------------------------------------------------------------------------------------------------------------------------------------------------------------------------------------------------------------------------------------------------------------------------|
| <b>Syntax</b>     | <code>ntp source <i>interface</i></code>                                                                                                                                                                                                                                                                                                                                                                                              |
| <b>Parameters</b> | <i>interface</i> —Set the interface type: <ul style="list-style-type: none"><li>• <i>ethernet node/slot/port[:subport]</i>—Enter the Ethernet interface information.</li><li>• <i>port-channel id-number</i>—Enter the port-channel number, from 1 to 128.</li><li>• <i>vlan vlan-id</i>—Enter the VLAN number, from 1 to 4093.</li><li>• <i>loopback loopback-id</i>—Enter the Loopback interface number, from 0 to 16383.</li></ul> |

- `mgmt node/slot/port`—Enter the Management port interface information.

|                           |                                                                        |
|---------------------------|------------------------------------------------------------------------|
| <b>Default</b>            | Not configured                                                         |
| <b>Command Mode</b>       | CONFIGURATION                                                          |
| <b>Usage Information</b>  | The <code>no</code> version of this command removes the configuration. |
| <b>Example</b>            | <pre>OS10(config)# ntp source ethernet 1/1/24</pre>                    |
| <b>Supported Releases</b> | 10.2.0E or later                                                       |

## ntp trusted-key

Sets a key to authenticate the system to which NTP synchronizes with.

|                           |                                                                                                                                                                                                                                                                                                                                                                                                                                                                                                            |
|---------------------------|------------------------------------------------------------------------------------------------------------------------------------------------------------------------------------------------------------------------------------------------------------------------------------------------------------------------------------------------------------------------------------------------------------------------------------------------------------------------------------------------------------|
| <b>Syntax</b>             | <code>ntp trusted-key number</code>                                                                                                                                                                                                                                                                                                                                                                                                                                                                        |
| <b>Parameters</b>         | <code>number</code> —Enter the trusted key ID, from 1 to 4294967295.                                                                                                                                                                                                                                                                                                                                                                                                                                       |
| <b>Default</b>            | Not configured                                                                                                                                                                                                                                                                                                                                                                                                                                                                                             |
| <b>Command Mode</b>       | CONFIGURATION                                                                                                                                                                                                                                                                                                                                                                                                                                                                                              |
| <b>Usage Information</b>  | <p>The <code>number</code> parameter must be the same number as the <code>number</code> parameter in the <code>ntp authentication-key</code> command. If you change the <code>ntp authentication-key</code> command, you must also change this command.</p> <p>Supported on the MX9116n and MX5108n switches in Full Switch mode starting in release 10.4.0E(R3S). Also supported in SmartFabric mode starting in release 10.5.0.1</p> <p>The <code>no</code> version of this command removes the key.</p> |
| <b>Example</b>            | <pre>OS10(config)# ntp trusted-key 234567</pre>                                                                                                                                                                                                                                                                                                                                                                                                                                                            |
| <b>Supported Releases</b> | 10.2.0E or later                                                                                                                                                                                                                                                                                                                                                                                                                                                                                           |

## show ntp associations

Displays the NTP master and peers.

|                          |                                                                                                                                                                                                                                                                                                                                                                                                                                                                                                                                                                                                                                      |
|--------------------------|--------------------------------------------------------------------------------------------------------------------------------------------------------------------------------------------------------------------------------------------------------------------------------------------------------------------------------------------------------------------------------------------------------------------------------------------------------------------------------------------------------------------------------------------------------------------------------------------------------------------------------------|
| <b>Syntax</b>            | <code>show ntp associations [vrf {management   vrf-name}]</code>                                                                                                                                                                                                                                                                                                                                                                                                                                                                                                                                                                     |
| <b>Parameters</b>        | <ul style="list-style-type: none"> <li>• <code>management</code>—Enter the keyword to display NTP information corresponding to the management VRF instance.</li> <li>• <code>vrf-name</code>—Enter the keyword then the name of the VRF to display NTP information corresponding to that nondefault VRF instance.</li> </ul>                                                                                                                                                                                                                                                                                                         |
| <b>Default</b>           | Not configured                                                                                                                                                                                                                                                                                                                                                                                                                                                                                                                                                                                                                       |
| <b>Command Mode</b>      | EXEC                                                                                                                                                                                                                                                                                                                                                                                                                                                                                                                                                                                                                                 |
| <b>Usage Information</b> | <ul style="list-style-type: none"> <li>• <code>(none)</code>—One or more of the following symbols displays: <ul style="list-style-type: none"> <li>○ <code>*</code>—Synchronized to this peer.</li> <li>○ <code>#</code>—Almost synchronized to this peer.</li> <li>○ <code>+</code>—Peer was selected for possible synchronization.</li> <li>○ <code>-</code>—Peer is a candidate for selection.</li> <li>○ <code>~</code>—Peer is statically configured.</li> </ul> </li> <li>• <code>remote</code>—Remote IP address of the NTP peer.</li> <li>• <code>ref clock</code>—IP address of the remote peer reference clock.</li> </ul> |

- *st*—Peer stratum, the number of hops away from the external time source. 16 means that the NTP peer cannot reach the time source.
- *when*—Last time the device received an NTP packet.
- *poll*—Polling interval in seconds.
- *reach*—Reachability to the peer in octal bitstream.
- *delay*—Time interval or delay for a packet to complete a round-trip to the NTP time source in milliseconds.
- *offset*—Relative time of the NTP peer clock to the network device clock in milliseconds.
- *disp*—Dispersion.

Supported on the MX9116n and MX5108n switches in Full Switch mode starting in release 10.4.0E(R3S). Also supported in SmartFabric mode starting in release 10.5.0.1

### Example

```
OS10# show ntp associations
remote ref clock st when poll reach delay offset disp
=====
 10.10.120.5 0.0.0.0 16 - 256 0 0.00 0.000 16000.0
*172.16.1.33 127.127.1.0 11 6 16 377 -0.08 -1499.9 104.16
 172.31.1.33 0.0.0.0 16 - 256 0 0.00 0.000 16000.0
 192.200.0.2 0.0.0.0 16 - 256 0 0.00 0.000 16000.0
```

```
OS10# show ntp associations vrf management
remote local st poll reach delay offset disp
=====
*1.1.1.2 1.1.1.1 3 64 1 0.00027 0.000056 0.43309
```

### Supported Releases

10.2.0E or later

## show ntp status

Displays NTP configuration information.

### Syntax

```
show ntp status [vrf {management | vrf-name}]
```

### Parameters

- *status*—(Optional) View the NTP status.
- *management*—(Optional) Enter the keywords to display NTP information corresponding to the management VRF.
- *vrf-name*—(Optional) Enter the keyword then the name of the VRF to display NTP information corresponding to that nondefault VRF.

### Default

Not configured

### Command Mode

EXEC

### Usage

#### Information

Supported on the MX9116n and MX5108n switches in Full Switch mode starting in release 10.4.0E(R3S). Also supported in SmartFabric mode starting in release 10.5.0.1

### Example (Status)

```
OS10# show ntp status
system peer: 0.0.0.0
system peer mode: unspec
leap indicator: 11
stratum: 16
precision: -22
root distance: 0.00000 s
root dispersion: 1.28647 s
reference ID: [73.78.73.84]
reference time: 00000000.00000000 Mon, Jan 1 1900 0:00:00.000
system flags: monitor ntp kernel stats
jitter: 0.000000 s
stability: 0.000 ppm
```

```
broadcastdelay: 0.000000 s
authdelay: 0.000000 s
```

```
OS10# show ntp status vrf management
system peer: 1.1.1.2
system peer mode: client
leap indicator: 00
stratum: 4
precision: -23
root distance: 0.00027 s
root dispersion: 0.94948 s
reference ID: [1.1.1.2]
reference time: ddc78084.f17ea38b Tue, Nov 28 2017 6:28:20.943
system flags: ntp kernel stats
jitter: 0.000000 s
stability: 0.000 ppm
broadcastdelay: 0.000000 s
authdelay: 0.000000 s
OS10#
```

```
OS10# show ntp status vrf red
associd=0 status=0618 leap_none, sync_ntp, 1 event, no_sys_peer,
system peer: 11.0.0.2:123
system peer mode: client
leap indicator: 00
stratum: 10
log2 precision: -24
root delay: 0.338
root dispersion: 1136.790
reference ID: 11.0.0.2
reference time: dbc7a951.f7978096 Sat, Nov 5 2016 0:41:53.967
system jitter: 0.000000
clock jitter: 0.003
clock wander: 0.001
broadcast delay: -50.000
symm. auth. delay: 0.000
```

**Supported Releases** 10.2.0E or later

## Precision Time Protocol

Precision Time Protocol (PTP), defined in the IEEE1588-2008 standard, is a protocol that uses a master-slave hierarchy to synchronize clocks on network devices. PTP uses hardware time stamping to achieve submicrosecond synchronization. PTP defines how real-time clocks in a network synchronize with each other. A network where PTP operates is called a PTP domain. This protocol operates by organizing clocks within a PTP domain into a master-slave hierarchy. The reference time for the entire system comes from the root clock, also known as the grandmaster clock.

PTP is more accurate than NTP because it uses hardware timestamping. PTP also accounts for device latency while synchronizing time. NTP synchronizes clocks with millisecond accuracy; PTP achieves submicrosecond accuracy.

OS10 supports PTP on all platforms that support hardware time stamping.

PTP-enabled devices consist of the following clock types:

**Ordinary clock** A device with a single physical port is called an ordinary clock. This device could take on a master or slave clock role.

 **NOTE:** OS10 switch cannot function as the grandmaster clock and hence OS10 does not support the ordinary clock configuration.

**Boundary clock** A device with multiple physical ports that synchronizes time from one network segment to another is called a boundary clock. One port is a slave that synchronizes time from upstream PTP device. The other ports are masters that distribute time to downstream devices. The best master clock algorithm (BMCA) decides the individual state of a port, master or slave.

**End-to-end transparent clock** Calculates the residence time of the PTP event message and updates the correction field (CF) of the event message before forwarding the message. The ports are not in any specific state.

## Best master clock algorithm

PTP uses the best master clock algorithm (BMCA) to compare clocks in a network. BMCA determines the status of ports in the network:

- Master—A clock that provides time to other clocks in the network.
- Slave—A clock that receives time from other clocks in the network.
- Passive—A port that is not a master or slave.

This algorithm determines if the newly discovered foreign clock is better than the local clock. The grandmaster field in the `Announce` message contains information about the foreign master clock. Information about the local clock is present in the default data set of the clock. The foreign and local clocks are compared based on the following attributes:

1. Priority1—(Applicable only for the system-default profile) Configurable attribute that determines the master from an ordered set of clocks. Priority1 is the most significant of the six attributes that devices use to select a master clock. The lower the value of priority1, the higher its priority.
2. ClockClass—Defines the traceability of a clock.
3. ClockAccuracy—Defines the accuracy of a clock.
4. OffsetScaledLogVariance—Defines the stability of a clock.
5. Priority2—Configurable attribute that determines a master among equivalent clocks. Priority2 is the fifth-most significant attribute out of the six attributes that devices use to select a master clock. The lower the value of priority2, the higher its priority.
6. ClockIdentity—Unique identifier that determines a master when two clocks are exactly the same. The clock with the lower clock identity has the highest preference.

When a PTP node receives two `Announce` messages from the same foreign master, PTP selects the best master based on the `StepsRemoved` field of the `Announce` message. This field indicates the number of boundary clocks between the local clock and the grandmaster clock.

## Message types

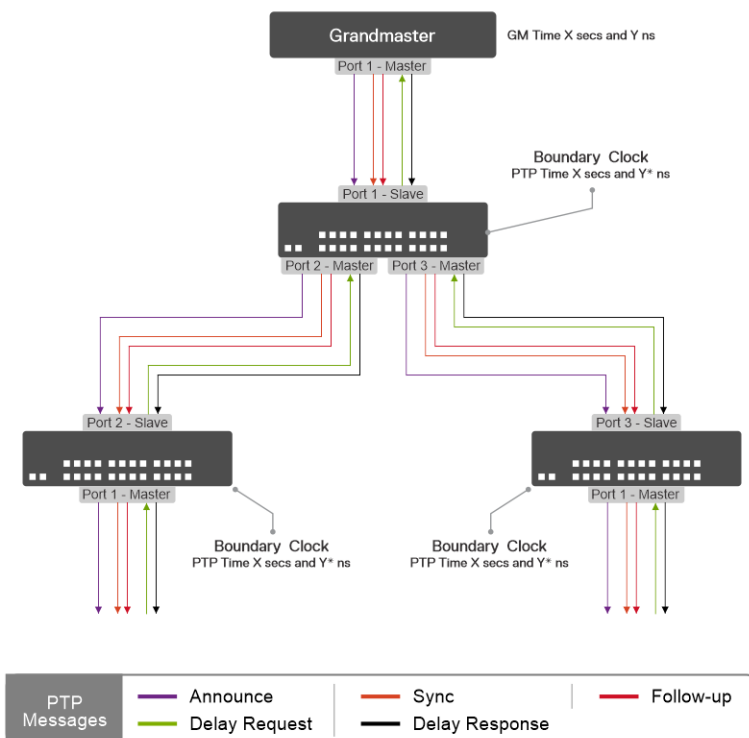

- Event messages: Timed messages with an accurate timestamp that is generated at both the transmit time and receive time.

- Sync—Master sends a Sync message to distribute the time of the day.
- Delay\_Req—Slave sends a Delay\_Req message to the master for end-to-end delay measurement, the request-response delay mechanism.
- Pdelay\_Req—Link node A sends a Pdelay\_Req message to measure peer-to-peer delay.
- Pdelay\_Resp—Link node B sends a Pdelay\_Resp message to measure peer-to-peer delay.
- General messages: Do not require accurate timestamps.
  - Follow\_Up—In a two-step clock, the master sends a Follow\_Up message after sending the Sync message.
  - Delay\_Resp—Master sends a Delay\_Resp message to measure the end-to-end delay.
  - Pdelay\_Resp\_FollowUp—Link node B sends a Pdelay\_Resp\_FollowUp message to measure peer-to-peer delay.
  - Announce—Master sends an Announce message to establish a synchronization hierarchy. The BMCA uses the Announce message to define a clock hierarchy and to select the grandmaster clock.
  - Signaling—Clock A sends a Signaling message to clock B for unicast negotiation and so on.

## Time synchronization

Master and slave clock devices exchange PTP timing messages to achieve time synchronization. Slave clock devices adjust their time to synchronize with their master clock devices.

For time synchronization and to determine the slave offset with the master, PTP accounts for the following:

- Communication delay between two PTP nodes
- End-to-end delay measured using the delay request message from the slave and delay response message from the master

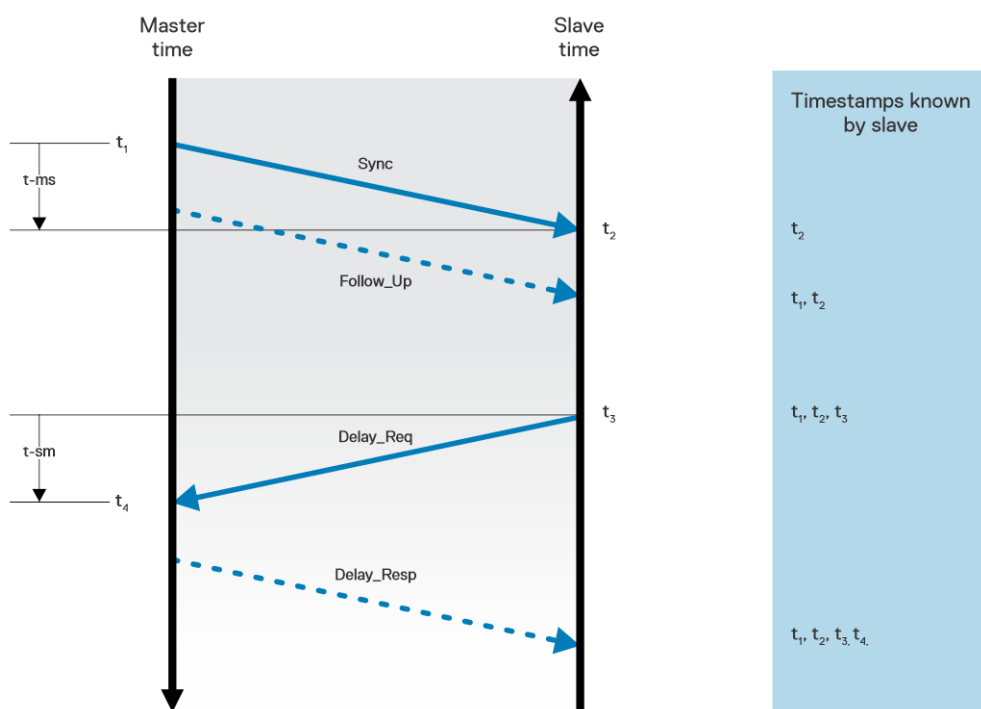

The following is the sequence of PTP messages during time synchronization:

1. Master sends a Sync message and makes note of the time  $t_1$  when the message was sent.
2. Slave receives the Sync message and makes note of the time  $t_2$  when the message was sent.
3. Master embeds the timestamp  $t_1$  in the Sync message.
4. Slave sends a Delay\_request message to the master and makes note of the time  $t_3$  when the message was sent.
5. Master receives the Delay\_request message and makes note of the time  $t_4$  when the message was sent.
6. Master conveys the timestamp  $t_4$  in a Delay\_response message.
7. Slave uses these timestamps to adjust its local clock to synchronize with the master:
  - Offset =  $[(t_2 - t_1) - (t_4 - t_3)] / 2$
  - Delay =  $[(t_2 - t_1) + (t_4 - t_3)] / 2$



## Supported profiles

OS10 supports the following PTP profiles:

- System default profile
- G.8275.1 profile

## Supported transport methods

OS10 supports the following PTP transport methods:

- Layer2 (Ethernet)
- IPv4 (Unicast and multicast)
- IPv6 (Unicast and multicast)

For the multicast transport method, as defined in the IEEE 1588 standard, PTP uses 224.0.1.129 as the multicast destination IPv4 address. PTP uses FF0X:0:0:0:0:0:0:181 as the multicast destination IPv6 address.

 **NOTE:** OS10 supports IPv6 multicast only between two directly-connected IPv6 PTP nodes.

## Configurable PTP attributes

The following are configurable PTP attributes that BMCA uses to determine the master and slave clock devices:

- Priority1—Has the highest preference in the list of attributes used for master clock device selection.
- Priority2—Has the fifth preference in the list of attributes used for master clock device selection.
- LocalPriority—(Applicable only for the G.8275.1 profile) Determines the master clock device when two clocks are similar to each other.

## Supported platforms

OS10 supports PTP only on the following platforms:

- S4100-ON series: S4148F-ON, S4148T-ON, S4148FE-ON, S4148U-ON
- S5200-ON series: S5232F-ON, S5248F-ON, S5296F-ON, S5224F-ON
- Z9264F-ON

## PTP installation scale and limits

The following table lists the verified scalability limits for PTP nodes with message rate (sync and delay request) of 16 pps.

**Table 8. PTP scale and limits**

| Platform                                                                               | PTP peer slave sessions | PTP peer master sessions | Total number of sessions |
|----------------------------------------------------------------------------------------|-------------------------|--------------------------|--------------------------|
| S4100-ON series                                                                        | 36                      | 4                        | 40                       |
| <ul style="list-style-type: none"><li>• S5200F-ON series</li><li>• Z9264F-ON</li></ul> | 120                     | 8                        | 128                      |

## Configuration notes

- The maximum number of supported PTP ports is 40.
- Maximum number of supported PTP unicast masters is eight.
- In a topology where a PTP device is connected to VLT primary and secondary nodes, configure PTP as an independent boundary clock on both the VLT nodes.

**NOTE:**

- Dell EMC recommends enabling PTP on the VLT port-channel member interfaces and not on the VLT port-channel interface.
- Tagged PTP messages using the `ptp vlan` command are not supported on VLT port-channel member interfaces.
- The unicast transport method is not supported on the VLT port-channel member interfaces.

● System time settings:

When you enable PTP as the system time source, PTP sets the system time. When you enable PTP on a system, the system cannot act as an NTP client, but can act as an NTP server.

The following table describes the system clock behavior depending on whether you choose PTP or NTP as the system time source:

**Table 9. System clock behavior**

| System time settings/time source    | System clock behavior                                                                                                                                                                                                                                                                                            |
|-------------------------------------|------------------------------------------------------------------------------------------------------------------------------------------------------------------------------------------------------------------------------------------------------------------------------------------------------------------|
| When PTP is the system time source: | <ul style="list-style-type: none"><li>○ You cannot configure the system as an NTP client.</li><li>○ If you configure the PTP clock and it is phase locked, PTP sets the time.</li><li>○ If you do not configure the PTP clock and it is not phase locked, the free-running system clock sets the time.</li></ul> |
| When NTP is the system time source: | NTP client sets the system time. Even if the PTP clock runs on the system, PTP does not set the system time.                                                                                                                                                                                                     |
| When you configure NTP as a server: | NTP provides the system clock. PTP or NTP can set the system clock.                                                                                                                                                                                                                                              |

● You can configure PTP on the port-channel interface and the port-channel member interfaces.

○ Port-channel interface: If the link aggregation is between two peer nodes, configure PTP on the port-channel interface. The forward and reverse paths must be symmetrical for PTP. In this case, the links of the port channel need not be the same for both forward and reverse paths.

**NOTE:** Dell EMC recommends that you configure PTP on port-channel member interfaces.

○ Port-channel member interfaces: If the link aggregation spans across multiple nodes, configure PTP on the port-channel member interfaces. PTP requires symmetrical forward and reverse paths. Therefore, configure PTP on the respective port-channel member interfaces.

● If you have configured PTP on an interface and use the `interface breakout` command, it removes the PTP configuration.

On boundary clocks, the `interface breakout` command removes the PTP port and changes the clock hierarchy.

**Precision Time Protocol Limitations**

10.5.1 does not support the following features:

- Multiple PTP timing domains
- Non-default VRF
- OS10 does not send PTP messages in the two-step mode. However, OS10 does support PTP port nodes that use the two-step mode.

## Configure Precision Time Protocol

You can configure global and interface-level settings to set up the OS10 switch to function as a PTP device. Some of these configurations have default values assigned. For a minimum configuration to set up different use cases, see:

- [Configure boundary clock with L2 transport method](#)
- [Configure boundary clock with IPv4 multicast transport method](#)
- [Configure boundary clock with IPv4 unicast transport method](#)
- [Configure end-to-end transparent clock](#)
- [Configure boundary clock with IPv4 unicast transport method and L3 VLAN](#)

## Global configurations

You can configure the following settings globally.

### Configure the PTP clock

Configure the PTP clock type on the switch and optionally specify a profile for the clock. OS10 supports the following clock types: boundary and end-to-end transparent. OS10 supports the system default profile and ITU G.8275.1 profile. The profile defines the set of parameters, allowed values of parameters, and default value of parameters. To configure PTP clock:

```
OS10(config)# ptp clock boundary
```

### Configure the PTP domain

A PTP domain is a logical group of clock devices where all the clocks have the same time synchronized from the grandmaster clock. To configure a domain for PTP clock:

```
OS10(config)# ptp domain 1
```

### Configure the source IP address for multicast transport

To configure source IP address for PTP multicast packets:

```
OS10(config)# ptp source ipv4 10.10.10.1
```

 **NOTE:** The IPv4 or IPv6 address that you configure must correspond to a configured L3 interface (physical, Loopback, VLAN, or port channel) and the interface must be operationally up.

### Configure the priority1 attribute

Priority1 has the highest priority in master clock device selection. Lower values have higher priority.

```
OS10(config)# ptp priority1 125
```

### Configure the priority2 attribute

Priority2 has the fifth precedence in master clock device selection. Lower values have higher priority.

```
OS10(config)# ptp priority2 120
```

### Configure the local priority attribute for the PTP clock

(Applicable only for the G.8275.1 profile) PTP uses the local priority attribute to compare a potential GM data set.

```
OS10(config)# ptp local-priority 120
```

### Configure the PTP clock to set the system time

To configure the PTP clock to set the system time:

```
OS10(config)# ptp system-time enable
```

## Interface-level configurations

### Enable PTP on an interface

To enable PTP on an interface:

```
OS10(config)# interface ethernet 1/1/1
OS10(conf-if-eth1/1/1)# ptp enable
```

### Configure the PTP role

A PTP interface can operate in master or slave role. To configure PTP role:

```
OS10(config)# interface ethernet 1/1/1
OS10(conf-if-eth1/1/1)# ptp role master
```

**NOTE:** The PTP role is set to dynamic by default. If the role is set to dynamic, PTP uses the BMCA to select the master or slave role.

### Configure the PTP delay mechanism

While measuring the time delay between the master and slave nodes, PTP takes into account the communication delay. This delay is measured using a delay request message from the slave and a delay response message from the master. To configure PTP delay mechanism:

```
OS10(config)# interface ethernet 1/1/1
OS10(conf-if-eth1/1/1)# ptp delay-mechanism end-to-end
```

### Configure the PTP transport

Supported PTP transport methods include Layer2 (ethernet), IPv4 (unicast and multicast), and IPv6 (unicast and multicast). Unicast transport method avoids flooding multicast messages in the network.

```
OS10(config)# interface ethernet 1/1/1
OS10(conf-if-eth1/1/1)# ptp transport ipv4 unicast master
```

### Configure slave devices for a master clock device

You can configure the IP addresses of multiple slave devices. To configure slave devices for the master clock device:

```
OS10(config)# interface ethernet 1/1/1
OS10(conf-if-eth1/1/1)# ptp transport ipv4 unicast master
OS10(conf-ethernet1/1/1-ptp-ipv4-master)# slave 10.10.10.1
OS10(conf-ethernet1/1/1-ptp-ipv4-master)# slave 10.10.10.2
```

### Configure a source for unicast transport from a master clock device to a slave clock device

You must configure a source IP address for unicast transport from a master clock device to a slave clock device.

```
OS10(config)# interface ethernet 1/1/1
OS10(conf-if-eth1/1/1)# ptp transport ipv4 unicast master
OS10(conf-ethernet1/1/1-ptp-ipv4-master)# source 10.10.10.2
```

**NOTE:** If you are configuring PTP on an OS10 switch that functions as a virtual router, configure the local IP address as the source IP address for UNICAST TRANSPORT mode. Do not configure the virtual IP address as the source IP address.

### Configure master clock devices for a slave clock device

You can configure the IP addresses of multiple master clock devices. OS10 supports configuring a maximum of eight master clock devices.

```
OS10(config)# interface ethernet 1/1/1
OS10(conf-if-eth1/1/1)# ptp transport ipv4 unicast slave
OS10(conf-ethernet1/1/1-ptp-ipv4-slave)# master 10.10.10.1
OS10(conf-ethernet1/1/1-ptp-ipv4-slave)# master 10.10.10.2
```

### Configure a source for unicast transport from a slave clock device to a master clock device

You must configure a source IP address for unicast transport from a slave clock device to a master clock device.

```
OS10(config)# interface ethernet 1/1/1
OS10(conf-if-eth1/1/1)# ptp transport ipv4 unicast slave
OS10(conf-ethernet1/1/1-ptp-ipv4-slave)# source 10.10.10.2
```

**NOTE:** If you are configuring PTP on an OS10 switch that functions as a virtual router, configure the local IP address as the source IP address for UNICAST TRANSPORT mode. Do not configure the virtual IP address as the source IP address.

### Configure a PTP VLAN

You can configure a VLAN on a PTP-enabled interface. If you configure a VLAN on the grandmaster clock, the grandmaster clock can drop untagged packets. If the VLAN tagged in a packet is the same as the PTP VLAN, the VLAN tagged packets are received on the PTP interface. Untagged packets are accepted on the PTP interface.

```
OS10(config)# interface ethernet 1/1/1
OS10(conf-if-eth1/1/1)# ptp vlan 10
```

### Configure the PTP announce message interval

You can configure the time interval in units of  $\log_2$  seconds between two successive announce messages.

```
OS10(config)# interface ethernet 1/1/1
OS10(conf-if-eth1/1/1)# ptp announce interval 1
```

### Configure the PTP synchronization message interval

You can configure the time interval in units of  $\log_2$  seconds between two successive synchronization messages.

```
OS10(config)# interface ethernet 1/1/1
OS10(conf-if-eth1/1/1)# ptp sync-interval -1
```

### Configure the delay request message interval

You can configure the time interval in units of  $\log_2$  seconds between two successive delay request messages.

```
OS10(config)# interface ethernet 1/1/1
OS10(conf-if-eth1/1/1)# ptp delay-req-min-interval 1
```

## View PTP information

Use the show commands to view the PTP information, status, and settings.

### View the PTP clock and port information

```
OS10# show ptp
PTP Clock : Boundary
Clock Identity : 68:4f:64:ff:ff:01:db:ec
Grandmaster Clock Identity : 00:16:00:ff:fe:00:02:00
Clock Mode : One-step
Clock Quality
 Class : 248
 Accuracy : <=100ns
 Offset Log Scaled Variance : 0
Domain : 0
Priority1 : 128
Priority2 : 128
Profile : System-default
Steps Removed : 1
Mean Path Delay(ns) : 72
Offset From Master(ns) : -14
Number of Ports : 2
```

```

Interface State Port Identity

Ethernet1/1/22 Slave 68:4f:64:ff:ff:01:db:ec:1
Ethernet1/1/23 Master 68:4f:64:ff:ff:01:db:ec:2

```

```
Number of slave ports :1
Number of master ports :1
```

### View the PTP clock and synchronization

```
OS10# show ptp clock
PTP Clock : Boundary
Clock Identity : 68:4f:64:ff:ff:01:db:ec
Grandmaster Clock Identity : 00:16:00:ff:fe:00:02:00
Clock Mode : One-step
Clock Quality
 Class : 248
 Accuracy : <=100ns
 Offset Log Scaled Variance : 0
Domain : 0
Priority1 : 128
Priority2 : 128
Profile : System-default
Steps Removed : 1
```

```
Mean Path Delay(ns) : 68
Offset From Master(ns) : 6
Number of Ports : 2
```

### View the PTP local parent and grandmaster clock

```
OS10# show ptp parent
Parent Clock Identity : 00:16:00:ff:fe:00:02:00
Parent Port Number : 1
Grandmaster Clock Identity : 00:16:00:ff:fe:00:02:00
Grandmaster Clock Quality
 Class : 6
 Accuracy : <=100ns
 OffsetLogScaledVariance : 0
Grandmaster Clock Priority1 : 100
Grandmaster Clock Priority2 : 128
```

### View time scale information

```
OS10# show ptp time-properties
Current UTC Offset Valid : False
Current UTC Offset : 0
Leap 59 : False
Leap 61 : False
Time Traceable : False
Frequency Traceable : False
PTP Timescale : False
Time source : Gps
```

### View PTP interface details

```
OS10# show ptp interface
Interface : Ethernet1/1/22
 PTP : Enabled
 Port Identity : 68:4f:64:ff:ff:01:db:ec:1
 Port State : Slave
 Vlan :
 Transport : Ipv4-multicast
 Log Delay Request Minimum interval : -4
 Log Announce Interval : 1
 Announce Receipt Timeout Multiplier : 3
 Log Sync Interval : -4
 Delay Mechanism : End-to-end
Interface : Ethernet1/1/23
 PTP : Enabled
 Port Identity : 68:4f:64:ff:ff:01:db:ec:2
 Port State : Master
 Vlan :
 Transport : Ipv4-multicast
 Log Delay Request Minimum interval : -4
 Log Announce Interval : 1
 Announce Receipt Timeout Multiplier : 3
 Log Sync Interval : -4
 Delay Mechanism : End-to-end
```

### View the count of PTP packets sent to or received on an interface

```
OS10# show ptp peer
Interface : Ethernet1/1/22
Total number of peers : 1
Peer index : 0
 Peer Clock Identity : 00:16:00:ff:fe:00:02:00
 Peer Port number : 1
 Peer Port Address : 22.0.0.2
 Receiving Interface : ethernet1/1/22
 Announce messages transmitted : 4061
 Announce messages received : 2372855
 Sync messages transmitted : 259876
 Sync messages received : 2372854
 Follow up messages transmitted : 0
 Follow up messages received : 0
```

```

Delay request messages transmitted : 74292
Delay request messages received : 0
Delay response messages transmitted : 0
Delay response messages received : 74286
Management messages transmitted : 0
Management messages received : 0
Signaling messages transmitted : 0
Signaling messages received : 0
Interface : Ethernet1/1/23
Total number of peers : 1
Peer index : 0
Peer Clock Identity : 00:17:00:ff:fe:00:02:00
Peer Port number : 1
Peer Port Address : 23.0.0.2
Receiving Interface : ethernet1/1/23
Announce messages transmitted : 41207
Announce messages received : 0
Sync messages transmitted : 2637200
Sync messages received : 0
Follow up messages transmitted : 0
Follow up messages received : 0
Delay request messages transmitted : 0
Delay request messages received : 2389638
Delay response messages transmitted : 2389638
Delay response messages received : 0
Management messages transmitted : 0
Management messages received : 0
Signaling messages transmitted : 0
Signaling messages received : 0

```

#### View the PTP state and lock status

```

OS10# show ptp servo
Servo State : Locked
Lock Status : Phase-locked

```

## Example: Configure boundary clock with L2 transport method

You must connect the grandmaster clock to one of the interfaces. In this example, interface 1 is connected to the grandmaster clock.

Configure a boundary clock with two PTP interfaces using L2 transport method. The interface that is connected to the grandmaster clock or the best master clock becomes the slave device. The other interface becomes the master clock.

### 1. Configure the PTP boundary clock.

The delay mechanism of the boundary clock is end-to-end by default.

```
OS10(config)# ptp clock boundary
```

### 2. Enable PTP on interface 1 with L2 multicast transport mode.

PTP role is dynamic by default.

```

OS10(config)# interface ethernet 1/1/1
OS10(conf-if-eth1/1/1)# ptp transport layer2
OS10(conf-if-eth1/1/1)# ptp enable

```

### 3. Enable PTP on interface 2 with L2 multicast transport mode.

PTP role is dynamic by default.

```

OS10(config)# interface ethernet 1/1/2
OS10(conf-if-eth1/1/2)# ptp transport layer2
OS10(conf-if-eth1/1/2)# ptp enable

```

Interface 1 becomes the slave device and interface 2 becomes the master clock device for other devices.

## Example: Configure boundary clock with IPv4 multicast transport method

You must connect the grandmaster clock to one of the interfaces. In this example, interface 1 is connected to the grandmaster clock.

Configure a boundary clock with two PTP interfaces using IPv4 multicast transport. The interface that is connected to the grandmaster clock or the best master clock becomes the slave device. The other interface becomes the master device.

**i** **NOTE:** For L3 interface, the interface IP address is used as the PTP multicast source IP address. If there is no interface IP address, then the multicast source IP address (GLOBAL CONFIGURATION mode) is used as the PTP source IP address.

1. Configure the PTP boundary clock.

The delay mechanism of the boundary clock is end-to-end by default.

```
OS10(config)# ptp clock boundary
```

2. Configure the multicast source IP address.

```
OS10(config)# ptp source ipv4 10.10.10.1
```

3. Enable PTP on interface 1 with IPv4 multicast transport mode.

PTP role is dynamic by default. For multicast transport mode, when you enable PTP, the system sends a join message.

```
OS10(config)# interface ethernet 1/1/1
OS10(conf-if-eth1/1/1)# ptp transport ipv4 multicast
OS10(conf-if-eth1/1/1)# ptp enable
```

4. Enable PTP on interface 2 with IPv4 multicast transport mode.

PTP role is dynamic by default. For IPv4, multicast is the default transport mode.

```
OS10(config)# interface ethernet 1/1/2
OS10(conf-if-eth1/1/2)# ptp transport ipv4 multicast
OS10(conf-if-eth1/1/2)# ptp enable
```

Interface 1 becomes the slave device and interface 2 becomes the master clock for other devices.

## Example: Configure boundary clock with IPv4 unicast transport method

Ensure that you configure the interface connected to the grandmaster clock as a slave device with a list of master device IP addresses. Configure the other interface as the master device with a list of slave device IP addresses. In this example, the grandmaster clock is connected to interface 1.

Configure a boundary clock with two PTP interfaces using IPv4 unicast transport. Use unicast transport mode when you have clearly defined the role of each node in your deployment.

1. Configure the PTP boundary clock.

The delay mechanism of the boundary clock is end-to-end by default.

```
OS10(config)# ptp clock boundary
```

2. Enable PTP on interface 1 with IPv4 unicast transport mode.

For L3 interface, if you have not configured the source IP address, the interface IP address is used as the source IP address for unicast transport from the slave device to the master device.

```
OS10(config)# interface ethernet 1/1/1
OS10(conf-if-eth1/1/1)# ip address 10.10.10.1/24
OS10(conf-if-eth1/1/1)# ptp transport ipv4 unicast slave
```



```
OS10(conf-ethernet1/1/1-ptp-ipv4-slave)# master 10.10.10.2
OS10(conf-ethernet1/1/1-ptp-ipv4-slave)# exit
OS10(conf-if-eth1/1/1)# ptp enable
```

3. Enable PTP on interface 2 with IPv4 unicast transport mode.

For both L2 and L3 interfaces, the configured source IP address is used as the source IP address for unicast transport from the master device to the slave device.

```
OS10(config)# interface ethernet 1/1/2
OS10(conf-if-eth1/1/1)# ip address 30.30.30.1/24
OS10(conf-if-eth1/1/2)# ptp transport ipv4 unicast master
OS10(conf-ethernet1/1/2-ptp-ipv4-master)# source 20.20.20.1
OS10(conf-ethernet1/1/2-ptp-ipv4-master)# slave 20.20.20.2
OS10(conf-ethernet1/1/2-ptp-ipv4-master)# exit
OS10(conf-if-eth1/1/2)# ptp enable
```

In this example, a source address different from the interface IP address is configured because the slave device is reachable in a different subnet of the source IP address.

Interface 1 becomes the slave device and interface 2 becomes the master clock for the other devices.

## Example: Configure end-to-end transparent clock

Ensure that you configure the following on the OS10 switch:

- Enable IP multicast routing.
- Configure the IP address on the PTP-enabled interfaces.
- Enable PIM sparse mode on the PTP-enabled interfaces.
- Configure a rendezvous point (RP) or a bootstrap router (BSR).
- The OS10 switch sends all PTP packets to the multicast group address, 224.0.1.129. Ensure that the PTP-enabled interfaces are part of this multicast group. Use IGMP and PIM for multicast routing.

You can enable the end-to-end transparent clock globally on the OS10 switch. The system applies this configuration on all the PTP-enabled interfaces. In the following example, port 1 is connected to the grandmaster clock and port 2 is connected to a slave device. Ports 1 and 2 are members of the multicast group, 224.0.1.129.

**NOTE:** OS10 does not support PTP multicast IPv6 negotiation in transparent clock mode.

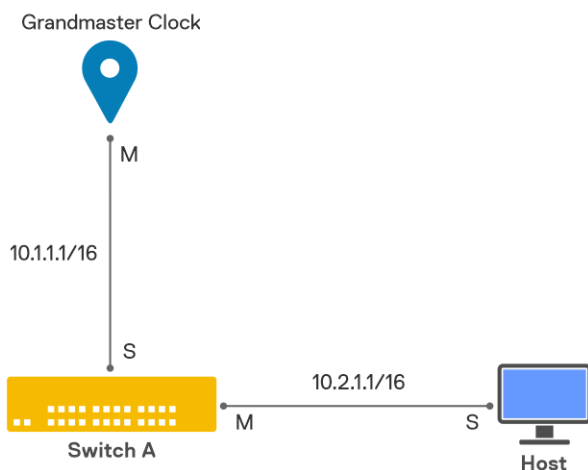

To configure an end-to-end transparent clock, use the following command:

```
OS10(config)# ptp clock end-to-end-transparent
```

The system updates the residence time in the correction field of the message and forwards the PTP messages.

## Example: Configure boundary clock with IPv4 unicast transport method and L3 VLAN

Ensure that the interface connected to the grandmaster clock is configured as a slave device with a list of master clock IP addresses. Configure the other interface as a master clock with a list of slave device IP addresses. Both the interfaces are only reachable through the L3 VLAN.

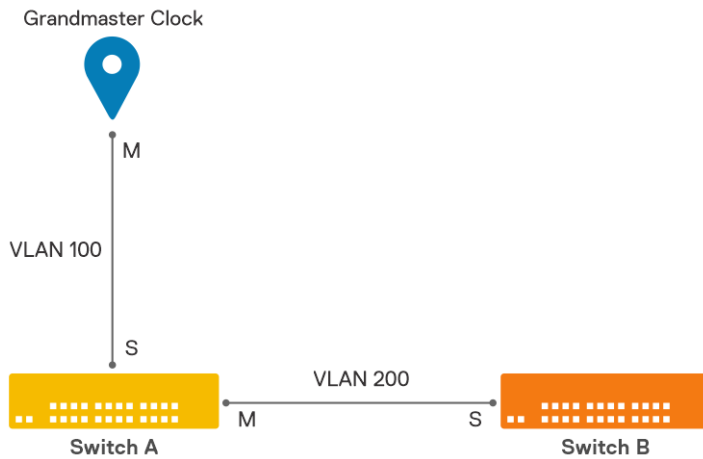

In this example:

- Interface 1 that is part of VLAN 100 is connected to the grandmaster clock.
- The grandmaster clock is reachable only through VLAN 100.
- Interface 2 that is part of VLAN 200 is connected to the slave device.
- The slave device is reachable only through VLAN 200.

Use unicast transport mode when you have clearly defined the role of each node in your deployment. To configure a boundary clock with two PTP interfaces using IPv4 unicast transport method:

1. Configure the PTP boundary clock.

The delay mechanism of the boundary clock is end-to-end by default.

```
OS10(config)# ptp clock boundary
```

2. Enable PTP on interface 1 with IPv4 unicast transport mode.

- The interface is a trunk port.
- A source address is configured for unicast transport from the slave device to the master clock device.
- The unicast IP traffic flows through the PTP-enabled interface and reaches the destination. The system applies hardware time stamps on PTP packets.

```
OS10(config)# interface vlan 100
OS10(conf-if-vl-100)# ip address 10.10.10.1/24

OS10(config)# interface ethernet 1/1/1
OS10(conf-if-eth1/1/1)# switchport mode trunk
OS10(conf-if-eth1/1/1)# switchport trunk allowed vlan 100
OS10(conf-if-eth1/1/1)# ptp vlan 100
OS10(conf-if-eth1/1/1)# ptp transport ipv4 unicast slave
OS10(conf-ethernet1/1/1-ptp-ipv4-slave)# source 10.10.10.1
OS10(conf-ethernet1/1/1-ptp-ipv4-slave)# master 10.10.10.2

OS10(conf-if-eth1/1/1)# ptp enable
```

3. Enable PTP on interface 2 with IPv4 unicast transport mode.

- The interface is an access port.
- Configure a source IP address for unicast transport from the master device to the slave device.

- The unicast IP traffic flows through PTP-enabled interface, interface 2. The system applies hardware time stamps on PTP packets.

```
OS10(config)# interface vlan 200
OS10(conf-if-vl-200)# ip address 20.20.20.1/24

OS10(config)# interface ethernet 1/1/2

OS10(conf-if-eth1/1/2)# switchport access vlan 200
OS10(conf-if-eth1/1/2)# ptp transport ipv4 unicast master
OS10(conf-ethernet1/1/2-ptp-ipv4-master)# source 20.20.20.1
OS10(conf-ethernet1/1/2-ptp-ipv4-master)# slave 20.20.20.2

OS10(conf-if-eth1/1/2)# ptp enable
```

Interface 1 becomes the slave device and interface 2 becomes the master clock for other devices.

## Example: Configure PTP in a multinode setup

The following example describes how to configure PTP in a multinode setup.

Ensure that you configure [VLT multicast routing](#). In this topology:

- CR1, CR2, AG1, AG2, AG3, and AG4 are multicast routers.
- CR1 and CR2 are the BSR and RP nodes.
- TR1 and TR2 are IGMP-enabled L2 nodes.
- OSPFv2 is the unicast routing protocol.

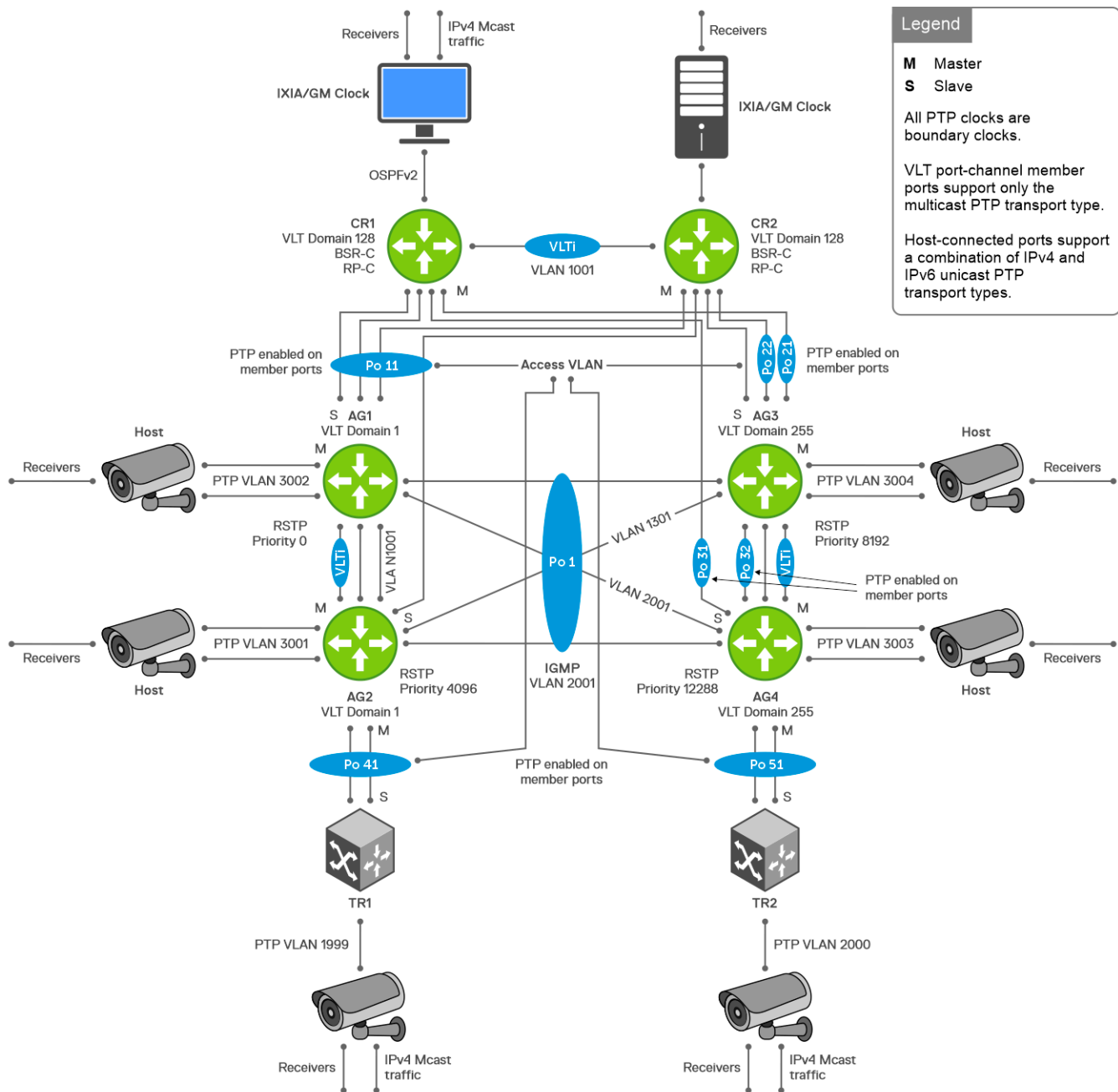

## CR1 switch

1. Configure PTP globally.

```
CR1(config)# ptp clock boundary
CR1(config)# ptp local-priority 127
CR1(config)# ptp source ipv4 10.0.0.5
CR1(config)# ptp source ipv6 10:0:0::6
CR1(config)# ptp system-time enable
```

2. Configure PTP on the interfaces.

```
CR1(config)# interface ethernet 1/1/1:1
CR1(conf-if-eth1/1/1:1)# ptp enable
CR1(conf-if-eth1/1/1:1)# ptp transport ipv4 multicast

CR1(config)# interface ethernet 1/1/3:1
CR1(conf-if-eth1/1/3:1)# ptp enable
```

```

CR1(conf-if-eth1/1/3:1)# ptp transport ipv4 multicast

CR1(config)# interface ethernet 1/1/9:1
CR1(conf-if-eth1/1/9:1)# ptp enable
CR1(conf-if-eth1/1/9:1)# ptp transport ipv4 multicast

CR1(config)# interface ethernet 1/1/16:1
CR1(conf-if-eth1/1/16:1)# ptp enable
CR1(conf-if-eth1/1/16:1)# ptp transport ipv4 multicast

CR1(config)# interface ethernet 1/1/17:1
CR1(conf-if-eth1/1/17:1)# ptp enable
CR1(conf-if-eth1/1/17:1)# ptp transport ipv4 multicast

CR1(config)# interface ethernet 1/1/25:1
CR1(conf-if-eth1/1/25:1)# ptp enable
CR1(conf-if-eth1/1/25:1)# ptp transport ipv4 multicast

CR1(config)# interface ethernet 1/1/28:1
CR1(conf-if-eth1/1/28:1)# ptp enable
CR1(conf-if-eth1/1/28:1)# ptp vlan 1
CR1(conf-if-eth1/1/28:1)# ptp transport ipv4 unicast slave
CR1(conf-ethernet1/1/28:1-ptp-ipv4-slave)# master 172.16.10.11
CR1(conf-ethernet1/1/28:1-ptp-ipv4-slave)# source 172.16.10.5

```

## CR2 switch

1. Configure PTP globally.

```

CR2(config)# ptp clock boundary
CR2(config)# ptp local-priority 2
CR2(config)# ptp source ipv4 10.0.0.6
CR2(config)# ptp source ipv6 10:0:0::6
CR2(config)# ptp system-time enable

```

2. Configure PTP on the interfaces.

```

CR2(config)# interface ethernet 1/1/3:1
CR2(conf-if-eth1/1/3:1)# ptp enable
CR2(conf-if-eth1/1/3:1)# ptp transport ipv4 multicast

CR2(config)# interface ethernet 1/1/3:1
CR2(conf-if-eth1/1/3:1)# ptp enable
CR2(conf-if-eth1/1/3:1)# ptp transport ipv4 multicast

CR2(config)# interface ethernet 1/1/8:1
CR2(conf-if-eth1/1/8:1)# ptp enable
CR2(conf-if-eth1/1/8:1)# ptp transport ipv4 multicast

CR2(config)# interface ethernet 1/1/12:1
CR2(conf-if-eth1/1/12:1)# ptp enable
CR2(conf-if-eth1/1/12:1)# ptp transport ipv4 multicast

CR2(config)# interface ethernet 1/1/13:1
CR2(conf-if-eth1/1/13:1)# ptp enable
CR2(conf-if-eth1/1/13:1)# ptp transport ipv4 multicast

CR2(config)# interface ethernet 1/1/17:1
CR2(conf-if-eth1/1/17:1)# ptp enable
CR2(conf-if-eth1/1/17:1)# ptp transport ipv4 multicast

CR2(config)# interface ethernet 1/1/25:1
CR2(conf-if-eth1/1/25:1)# ptp enable
CR2(conf-if-eth1/1/25:1)# ptp transport ipv4 multicast

CR2(config)# interface ethernet 1/1/28:2
CR2(conf-if-eth1/1/28:2)# ptp enable
CR2(conf-if-eth1/1/28:2)# ptp vlan 1
CR2(conf-if-eth1/1/28:2)# ptp transport ipv6 unicast slave

```

```
CR2 (conf-ethernet1/1/28:2-ptp-ipv4-slave) # master 2001:200:1:1::99
CR2 (conf-ethernet1/1/28:2-ptp-ipv4-slave) # source 2001:200:1:1::5
```

## AG1 switch

### 1. Configure PTP globally.

```
AG1 (config) # ptp clock boundary
AG1 (config) # ptp source ipv4 10.0.0.1
AG1 (config) # ptp source ipv6 10:0:0::1
AG1 (config) # ptp system-time enable
```

### 2. Configure PTP on the interfaces.

```
AG1 (config) # interface ethernet 1/1/1:1
AG1 (conf-if-eth1/1/1:1) # ptp enable
AG1 (conf-if-eth1/1/1:1) # ptp transport ipv4 multicast

AG1 (config) # interface ethernet 1/1/1:3
AG1 (conf-if-eth1/1/1:3) # ptp enable
AG1 (conf-if-eth1/1/1:3) # ptp transport ipv4 multicast

AG1 (config) # interface ethernet 1/1/5:3
AG1 (conf-if-eth1/1/5:3) # ptp enable
AG1 (conf-if-eth1/1/5:3) # ptp transport ipv4 multicast

AG1 (config) # interface ethernet 1/1/7:4
AG1 (conf-if-eth1/1/7:4) # ptp enable
AG1 (conf-if-eth1/1/7:4) # ptp transport ipv4 multicast

AG1 (config) # interface ethernet 1/1/9:1
AG1 (conf-if-eth1/1/9:1) # ptp enable
AG1 (conf-if-eth1/1/9:1) # ptp vlan 3002
AG1 (conf-if-eth1/1/9:1) # ptp transport ipv6 unicast master
AG1 (conf-ethernet1/1/9:1-ptp-ipv6-master) # slave 2001:101:2::200a
AG1 (conf-ethernet1/1/9:1-ptp-ipv6-master) # slave 2001:101:2::200b
AG1 (conf-ethernet1/1/9:1-ptp-ipv6-master) # slave 2001:101:2::200c
AG1 (conf-ethernet1/1/9:1-ptp-ipv6-master) # slave 2001:101:2::200d
AG1 (conf-ethernet1/1/9:1-ptp-ipv6-master) # slave 2001:101:2::200e
AG1 (conf-ethernet1/1/9:1-ptp-ipv6-master) # slave 2001:101:2::200f
AG1 (conf-ethernet1/1/9:1-ptp-ipv6-master) # slave 2001:101:2::201a
AG1 (conf-ethernet1/1/9:1-ptp-ipv6-master) # slave 2001:101:2::201b
AG1 (conf-ethernet1/1/9:1-ptp-ipv6-master) # slave 2001:101:2::201c
AG1 (conf-ethernet1/1/9:1-ptp-ipv6-master) # slave 2001:101:2::201d
AG1 (conf-ethernet1/1/9:1-ptp-ipv6-master) # slave 2001:101:2::201e
AG1 (conf-ethernet1/1/9:1-ptp-ipv6-master) # slave 2001:101:2::201f
AG1 (conf-ethernet1/1/9:1-ptp-ipv6-master) # slave 2001:101:2::2000
AG1 (conf-ethernet1/1/9:1-ptp-ipv6-master) # slave 2001:101:2::2001
AG1 (conf-ethernet1/1/9:1-ptp-ipv6-master) # slave 2001:101:2::2002
AG1 (conf-ethernet1/1/9:1-ptp-ipv6-master) # slave 2001:101:2::2003
AG1 (conf-ethernet1/1/9:1-ptp-ipv6-master) # slave 2001:101:2::2004
AG1 (conf-ethernet1/1/9:1-ptp-ipv6-master) # slave 2001:101:2::2005
AG1 (conf-ethernet1/1/9:1-ptp-ipv6-master) # slave 2001:101:2::2006
AG1 (conf-ethernet1/1/9:1-ptp-ipv6-master) # slave 2001:101:2::2007
AG1 (conf-ethernet1/1/9:1-ptp-ipv6-master) # slave 2001:101:2::2008
AG1 (conf-ethernet1/1/9:1-ptp-ipv6-master) # slave 2001:101:2::2009
AG1 (conf-ethernet1/1/9:1-ptp-ipv6-master) # slave 2001:101:2::2010
AG1 (conf-ethernet1/1/9:1-ptp-ipv6-master) # slave 2001:101:2::2011
AG1 (conf-ethernet1/1/9:1-ptp-ipv6-master) # slave 2001:101:2::2012
AG1 (conf-ethernet1/1/9:1-ptp-ipv6-master) # slave 2001:101:2::2013
AG1 (conf-ethernet1/1/9:1-ptp-ipv6-master) # slave 2001:101:2::2014
AG1 (conf-ethernet1/1/9:1-ptp-ipv6-master) # slave 2001:101:2::2015
AG1 (conf-ethernet1/1/9:1-ptp-ipv6-master) # slave 2001:101:2::2016
AG1 (conf-ethernet1/1/9:1-ptp-ipv6-master) # slave 2001:101:2::2017
AG1 (conf-ethernet1/1/9:1-ptp-ipv6-master) # slave 2001:101:2::2018
AG1 (conf-ethernet1/1/9:1-ptp-ipv6-master) # slave 2001:101:2::2019
AG1 (conf-ethernet1/1/9:1-ptp-ipv6-master) # slave 2001:101:2::2020
AG1 (conf-ethernet1/1/9:1-ptp-ipv6-master) # slave 2001:101:2::2021
AG1 (conf-ethernet1/1/9:1-ptp-ipv6-master) # slave 2001:101:2::2022
AG1 (conf-ethernet1/1/9:1-ptp-ipv6-master) # slave 2001:101:2::2023
```

```

AG1(conf-ethernet1/1/9:1-ptp-ipv6-master)# slave 2001:101:2::2024
AG1(conf-ethernet1/1/9:1-ptp-ipv6-master)# slave 2001:101:2::2025
AG1(conf-ethernet1/1/9:1-ptp-ipv6-master)# slave 2001:101:2::2026
AG1(conf-ethernet1/1/9:1-ptp-ipv6-master)# slave 2001:101:2::2027
AG1(conf-ethernet1/1/9:1-ptp-ipv6-master)# source 2001:101:2::1

AG1(config)# interface ethernet 1/1/17:1
AG1(conf-if-eth1/1/17:1)# ptp enable
AG1(conf-if-eth1/1/17:1)# ptp transport ipv4 multicast

AG1(config)# interface ethernet 1/1/19:4
AG1(conf-if-eth1/1/19:4)# ptp enable
AG1(conf-if-eth1/1/19:4)# ptp transport ipv4 multicast

```

## AG2 switch

### 1. Configure PTP globally.

```

AG2(config)# ptp clock boundary
AG2(config)# ptp source ipv4 10.0.0.2
AG2(config)# ptp source ipv6 10:0:0::2
AG2(config)# ptp system-time enable

```

### 2. Configure PTP on the interfaces.

```

AG2(config)# interface ethernet 1/1/1:1
AG2(conf-if-eth1/1/1:1)# ptp enable
AG2(conf-if-eth1/1/1:1)# ptp transport ipv4 multicast

AG2(config)# interface ethernet 1/1/3:4
AG2(conf-if-eth1/1/3:4)# ptp enable
AG2(conf-if-eth1/1/3:4)# ptp transport ipv4 multicast

AG2(config)# interface ethernet 1/1/5:4
AG2(conf-if-eth1/1/5:4)# ptp enable
AG2(conf-if-eth1/1/5:4)# ptp transport ipv6 multicast

AG2(config)# interface ethernet 1/1/7:3
AG2(conf-if-eth1/1/7:3)# ptp enable
AG2(conf-if-eth1/1/7:3)# ptp transport ipv6 multicast

AG2(config)# interface ethernet 1/1/9:1
AG2(conf-if-eth1/1/9:1)# ptp enable
AG2(conf-if-eth1/1/9:1)# ptp vlan 3001
AG2(conf-if-eth1/1/9:1)# ptp transport ipv4 unicast master
AG2(conf-ethernet1/1/9:1-ptp-ipv4-master)# slave 172.16.0.0
AG2(conf-ethernet1/1/9:1-ptp-ipv4-master)# slave 172.16.0.1
AG2(conf-ethernet1/1/9:1-ptp-ipv4-master)# slave 172.16.0.2
AG2(conf-ethernet1/1/9:1-ptp-ipv4-master)# slave 172.16.0.3
AG2(conf-ethernet1/1/9:1-ptp-ipv4-master)# slave 172.16.0.4
AG2(conf-ethernet1/1/9:1-ptp-ipv4-master)# slave 172.16.0.5
AG2(conf-ethernet1/1/9:1-ptp-ipv4-master)# slave 172.16.0.6
AG2(conf-ethernet1/1/9:1-ptp-ipv4-master)# slave 172.16.0.7
AG2(conf-ethernet1/1/9:1-ptp-ipv4-master)# slave 172.16.0.8
AG2(conf-ethernet1/1/9:1-ptp-ipv4-master)# slave 172.16.0.9
AG2(conf-ethernet1/1/9:1-ptp-ipv4-master)# slave 172.16.0.10
AG2(conf-ethernet1/1/9:1-ptp-ipv4-master)# slave 172.16.0.11
AG2(conf-ethernet1/1/9:1-ptp-ipv4-master)# slave 172.16.0.12
AG2(conf-ethernet1/1/9:1-ptp-ipv4-master)# slave 172.16.0.13
AG2(conf-ethernet1/1/9:1-ptp-ipv4-master)# slave 172.16.0.14
AG2(conf-ethernet1/1/9:1-ptp-ipv4-master)# slave 172.16.0.15
AG2(conf-ethernet1/1/9:1-ptp-ipv4-master)# slave 172.16.0.16
AG2(conf-ethernet1/1/9:1-ptp-ipv4-master)# slave 172.16.0.17
AG2(conf-ethernet1/1/9:1-ptp-ipv4-master)# slave 172.16.0.18
AG2(conf-ethernet1/1/9:1-ptp-ipv4-master)# slave 172.16.0.19
AG2(conf-ethernet1/1/9:1-ptp-ipv4-master)# slave 172.16.0.20
AG2(conf-ethernet1/1/9:1-ptp-ipv4-master)# slave 172.16.0.21
AG2(conf-ethernet1/1/9:1-ptp-ipv4-master)# slave 172.16.0.22
AG2(conf-ethernet1/1/9:1-ptp-ipv4-master)# slave 172.16.0.23

```

```

AG2 (conf-ethernet1/1/9:1-ptp-ipv4-master) # slave 172.16.0.24
AG2 (conf-ethernet1/1/9:1-ptp-ipv4-master) # slave 172.16.0.25
AG2 (conf-ethernet1/1/9:1-ptp-ipv4-master) # slave 172.16.0.26
AG2 (conf-ethernet1/1/9:1-ptp-ipv4-master) # slave 172.16.0.27
AG2 (conf-ethernet1/1/9:1-ptp-ipv4-master) # slave 172.16.0.28
AG2 (conf-ethernet1/1/9:1-ptp-ipv4-master) # slave 172.16.0.29
AG2 (conf-ethernet1/1/9:1-ptp-ipv4-master) # slave 172.16.0.30
AG2 (conf-ethernet1/1/9:1-ptp-ipv4-master) # slave 172.16.0.31
AG2 (conf-ethernet1/1/9:1-ptp-ipv4-master) # slave 172.16.0.32
AG2 (conf-ethernet1/1/9:1-ptp-ipv4-master) # slave 172.16.0.33
AG2 (conf-ethernet1/1/9:1-ptp-ipv4-master) # slave 172.16.0.34
AG2 (conf-ethernet1/1/9:1-ptp-ipv4-master) # slave 172.16.0.35
AG2 (conf-ethernet1/1/9:1-ptp-ipv4-master) # slave 172.16.0.36
AG2 (conf-ethernet1/1/9:1-ptp-ipv4-master) # slave 172.16.0.37
AG2 (conf-ethernet1/1/9:1-ptp-ipv4-master) # slave 172.16.0.38
AG2 (conf-ethernet1/1/9:1-ptp-ipv4-master) # slave 172.16.0.39
AG2 (conf-ethernet1/1/9:1-ptp-ipv4-master) # source 172.16.0.2

```

```

AG2 (config) # interface ethernet 1/1/17:4
AG2 (conf-if-eth1/1/17:4) # ptp enable
AG2 (conf-if-eth1/1/17:4) # ptp transport ipv6 multicast

```

```

AG2 (config) # interface ethernet 1/1/19:3
AG2 (conf-if-eth1/1/19:3) # ptp enable
AG2 (conf-if-eth1/1/19:3) # ptp transport ipv4 multicast

```

## TR1 switch

1. Configure PTP globally.

```

TR1 (config) # ptp clock boundary
TR1 (config) # ptp source ipv4 10.0.0.10
TR1 (config) # ptp source ipv6 10:0:0::a
TR1 (config) # ptp system-time enable

```

2. Configure PTP on the interfaces.

```

TR1 (config) # interface ethernet 1/1/27:4
TR1 (conf-if-eth1/1/27:4) # ptp enable
TR1 (conf-if-eth1/1/27:4) # ptp transport ipv6 multicast

```

```

TR1 (config) # interface ethernet 1/1/28:3
TR1 (conf-if-eth1/1/28:3) # ptp enable
TR1 (conf-if-eth1/1/28:3) # ptp transport ipv4 multicast

```

```

TR1 (config) # interface ethernet 1/1/33
TR1 (conf-if-eth1/1/33) # ptp enable
TR1 (conf-if-eth1/1/33) # ptp vlan 1999
TR1 (conf-if-eth1/1/33) # ptp transport ipv6 unicast master
TR1 (conf-ethernet1/1/33-ptp-ipv6-master) # slave 2091:101:1::111a
TR1 (conf-ethernet1/1/33-ptp-ipv6-master) # slave 2091:101:1::111b
TR1 (conf-ethernet1/1/33-ptp-ipv6-master) # slave 2091:101:1::111c
TR1 (conf-ethernet1/1/33-ptp-ipv6-master) # slave 2091:101:1::111d
TR1 (conf-ethernet1/1/33-ptp-ipv6-master) # slave 2091:101:1::111e
TR1 (conf-ethernet1/1/33-ptp-ipv6-master) # slave 2091:101:1::111f
TR1 (conf-ethernet1/1/33-ptp-ipv6-master) # slave 2091:101:1::1110
TR1 (conf-ethernet1/1/33-ptp-ipv6-master) # slave 2091:101:1::1111
TR1 (conf-ethernet1/1/33-ptp-ipv6-master) # slave 2091:101:1::1112
TR1 (conf-ethernet1/1/33-ptp-ipv6-master) # slave 2091:101:1::1113
TR1 (conf-ethernet1/1/33-ptp-ipv6-master) # slave 2091:101:1::1114
TR1 (conf-ethernet1/1/33-ptp-ipv6-master) # slave 2091:101:1::1115
TR1 (conf-ethernet1/1/33-ptp-ipv6-master) # slave 2091:101:1::1116
TR1 (conf-ethernet1/1/33-ptp-ipv6-master) # slave 2091:101:1::1117
TR1 (conf-ethernet1/1/33-ptp-ipv6-master) # slave 2091:101:1::1118
TR1 (conf-ethernet1/1/33-ptp-ipv6-master) # slave 2091:101:1::1119
TR1 (conf-ethernet1/1/33-ptp-ipv6-master) # source 2091:101:1::1

```

```

TR1 (config) # interface ethernet 1/1/39
TR1 (conf-if-eth1/1/39) # ptp enable

```



```
TR1(conf-if-eth1/1/39)# ptp transport ipv4 multicast

TR1(config)# interface ethernet 1/1/46
TR1(conf-if-eth1/1/46)# ptp enable
TR1(conf-if-eth1/1/46)# ptp transport ipv4 multicast
```

## AG3 switch

1. Configure PTP globally.

```
AG3(config)# ptp clock boundary
AG3(config)# ptp source ipv4 10.0.0.3
AG3(config)# ptp source ipv6 10:0:0::3
AG3(config)# ptp system-time enable
```

2. Configure PTP on the interfaces.

```
AG3(config)# interface ethernet 1/1/1:1
AG3(conf-if-eth1/1/1:1)# ptp enable
AG3(conf-if-eth1/1/1:1)# ptp transport ipv4 multicast

AG3(config)# interface ethernet 1/1/25:1
AG3(conf-if-eth1/1/25:1)# ptp enable
AG3(conf-if-eth1/1/25:1)# ptp transport ipv4 multicast

AG3(config)# interface ethernet 1/1/17:1
AG3(conf-if-eth1/1/17:1)# ptp enable
AG3(conf-if-eth1/1/17:1)# ptp transport ipv4 multicast
```

## AG4 switch

1. Configure PTP globally.

```
AG4(config)# ptp clock boundary
AG4(config)# ptp source ipv4 10.0.0.4
AG4(config)# ptp source ipv6 10:0:0::4
AG4(config)# ptp system-time enable
```

2. Configure PTP on the interfaces.

```
AG4(config)# interface ethernet 1/1/1:1
AG4(conf-if-eth1/1/1:1)# ptp enable
AG4(conf-if-eth1/1/1:1)# ptp transport ipv4 multicast

AG4(config)# interface ethernet 1/1/17:1
AG4(conf-if-eth1/1/17:1)# ptp enable
AG4(conf-if-eth1/1/17:1)# ptp transport ipv4 multicast

AG4(config)# interface ethernet 1/1/19:1
AG4(conf-if-eth1/1/19:1)# ptp enable
AG4(conf-if-eth1/1/19:1)# ptp transport ipv4 multicast
```

## TR2 switch

1. Configure PTP globally.

```
TR2(config)# ptp clock boundary
TR2(config)# ptp source ipv4 10.0.0.11
TR2(config)# ptp source ipv6 10:0:0::b
TR2(config)# ptp system-time enable
```

2. Configure PTP on the interfaces.

```
TR2(config)# interface ethernet 1/1/1:1
TR2(conf-if-eth1/1/1:1)# ptp enable
```

```

TR2(conf-if-eth1/1/1:1)# ptp transport ipv4 multicast

TR2(config)# interface ethernet 1/1/25:1
TR2(conf-if-eth1/1/25:1)# ptp enable
TR2(conf-if-eth1/1/25:1)# ptp transport ipv4 multicast

```

## PTP commands

### clear ptp counters

Resets the statistics of the PTP packets that are received at or transmitted from an interface.

**Syntax** `clear ptp counters [{ethernet node/slot/port[:subport]} | {port-channel port-channel-id}]`

**Parameters**

- `ethernet node/slot/port[:subport]`—Enter the Ethernet interface information.
- `port-channel port-channel-id`—Enter the port channel interface number.

**Defaults** None

**Command Mode** EXEC

**Security and Access** Netadmin and sysadmin

**Usage Information** None

**Example**

```
OS10# clear ptp counters ethernet 1/1/14
```

**Supported Releases** 10.5.1.0 or later

### debug ptp

Enables debug logs for the PTP stack.

**Syntax** `debug ptp {all | bmca | protocol | servo | system | timestamps} {level level}`

**Parameters**

- `all`—All debug logs of system, stack, and servo
- `bmca`—Best Master Clock Algorithm (BMCA) logs
- `protocol`—PTP protocol engine and transport layer logs
- `servo`—Servo and PLL logs
- `system`—System and task logs
- `timestamps`—Logs related to timestamps
- `level`—Specify the debug log level. Enter a value from 1 to 5. Level 1 is critical and level 5 is informational.

**Defaults**

- Debug: Not enabled
- Debug level: 1

**Command Mode** EXEC

**Security and Access** Netadmin and sysadmin

**Usage Information** Debug log messages are stored in the following file: `/var/log/ptp.log`. The `debug ptp system` command logs all information about internal data structures and is useful for debugging issues.

**Example**

```
OS10# debug ptp servo level 2
```

**Supported Releases**

10.5.1.0 or later

## master

Configures master clocks for the PTP slave devices.

**Syntax**

```
master ip-address
```

**Parameters**

*ip-address*—Specifies the IP addresses of the master clock devices.

**Defaults**

None for IP address; unicast negotiation disabled

**Command Mode**

INTERFACE CONFIGURATION - SLAVE submode

**Security and Access**

Netadmin and sysadmin

**Usage Information**

You can configure a maximum of eight master clock devices. The system reports an error when you configure more than eight master clock devices. The `no` form of this command removes the configuration.

**Example**

```
OS10(config)# interface ethernet 1/1/1
OS10(conf-if-eth1/1/1)# ptp transport ipv4 unicast slave
OS10(conf-ethernet1/1/1-ptp-ipv4-slave)# master 10.10.10.1
OS10(conf-ethernet1/1/1-ptp-ipv4-slave)# master 10.10.10.2
```

**Supported Releases**

10.5.1.0 or later

## ptp announce

Configures the interval between successive announce messages and the timeout for the message.

**Syntax**

```
ptp announce {[interval log2-seconds] | [timeout multiplier]}
```

**Parameters**

- *log2-seconds*—Configures the logarithmic time interval in seconds between successive announce messages. For the system default profile, enter a value from -2 to 4 (1/4 s to 16 s). For the ITU G.8275.1 profile, enter a value from -3 to 4 (1/8 s to 16 s).
- *multiplier*—Configures the count of announce message intervals that have to pass without receipt of an announce message to declare a timeout. Enter a value from 2 to 10.

**Defaults**

- Interval:
  - System default profile: 1
  - ITU G.8275.1 profile: -3
- Timeout: 3

**Command Mode**

INTERFACE CONFIGURATION

**Security and Access**

Netadmin and sysadmin

**Usage Information**

When a timeout event occurs, the system selects a port with dynamic role to be the master. The `no` form of this command removes the configuration.

**Example**

```
OS10(config)# interface ethernet 1/1/1
OS10(conf-if-eth1/1/1)# ptp announce interval 1
OS10(conf-if-eth1/1/1)# ptp announce timeout 5
```

**Supported Releases** 10.5.1.0 or later

## ptp clock

Configures the PTP clock type on the switch and specifies the profile for the clock.

**Syntax** `ptp clock {boundary | end-to-end-transparent} [profile {g8275.1 | system-default}]`

- Parameters**
- `boundary`—Enables boundary clock.
  - `end-to-end-transparent`—Enables end-to-end transparent clock.
  - `g8275.1`—Configures the clock to adhere to the ITU G.8275.1 profile.
  - `system-default`—Configures the clock to adhere to the system default profile.

**Defaults** System default profile, when PTP clock is configured.

**Command Mode** CONFIGURATION

**Security and Access** Netadmin and sysadmin

**Usage Information** Enables the PTP clock and configures the clock type and profile on the switch. The clock identity is an array of 8 bytes. The system determines the clock identity from the system MAC address. The most significant 3 bytes (OUI portion) of the MAC address is assigned to the most significant 3 bytes of clock identity. The least significant 3 bytes of the MAC address is assigned to the least significant 3 bytes of the clock identity. Fourth and fifth bytes of clock identity can take on the one of the following values: 0xFF or 0xFE. The G8275.1 profile is applicable only for boundary clock. When you configure an attribute, the new configuration overrides the attribute configuration that is defined in the profile. The `no` form of this command removes the configuration.

### Example

```
OS10(config)# ptp clock boundary
OS10(config)# ptp clock boundary profile g8275.1
```

**Supported Releases** 10.5.1.0 or later

## ptp delay-mechanism

Configures the delay mechanism of the PTP boundary clock.

**Syntax** `ptp delay-mechanism {end-to-end}`

**Parameters** `end-to-end`—Enables delay request-response mechanism for the boundary clock.

**Defaults** End-to-end

**Command Mode** INTERFACE CONFIGURATION

**Security and Access** Netadmin and sysadmin

**Usage Information** This configuration is only applicable for the boundary clock. The `no` form of this command removes the configuration.

### Example

```
OS10(config)# interface ethernet 1/1/1
OS10(conf-if-eth1/1/1)# ptp delay-mechanism end-to-end
```

**Supported Releases** 10.5.1.0 or later

## ptp delay-req-min-interval

Configures the minimum interval between delay request messages.

|                            |                                                                                                                                                                                                                                                                               |
|----------------------------|-------------------------------------------------------------------------------------------------------------------------------------------------------------------------------------------------------------------------------------------------------------------------------|
| <b>Syntax</b>              | <code>ptp delay-req-min-interval log2-seconds</code>                                                                                                                                                                                                                          |
| <b>Parameters</b>          | <i>log2-seconds</i> —Configures the logarithmic time interval in seconds between successive delay request messages. For the system default profile, enter a value from -7 to 5 (1/128 s to 32 s). For the ITU G.8275.1 profile, enter a value from -7 to 4 (1/128 s to 16 s). |
| <b>Defaults</b>            | -4                                                                                                                                                                                                                                                                            |
| <b>Command Mode</b>        | INTERFACE CONFIGURATION                                                                                                                                                                                                                                                       |
| <b>Security and Access</b> | Netadmin and sysadmin                                                                                                                                                                                                                                                         |
| <b>Usage Information</b>   | This configuration is applicable only with end-to-end delay mechanism. The <code>no</code> form of this command removes the configuration.                                                                                                                                    |
| <b>Example</b>             | <pre>OS10(config)# interface ethernet 1/1/1 OS10(conf-if-eth1/1/1)# ptp delay-req-min-interval 1</pre>                                                                                                                                                                        |
| <b>Supported Releases</b>  | 10.5.1.0 or later                                                                                                                                                                                                                                                             |

## ptp domain

Configures the domain for the PTP clock.

|                            |                                                                                                                                                                                                                                                                                                                                                                                                    |
|----------------------------|----------------------------------------------------------------------------------------------------------------------------------------------------------------------------------------------------------------------------------------------------------------------------------------------------------------------------------------------------------------------------------------------------|
| <b>Syntax</b>              | <code>ptp domain domain-number</code>                                                                                                                                                                                                                                                                                                                                                              |
| <b>Parameters</b>          | <i>domain-number</i> —Enter a value from the following ranges: <ul style="list-style-type: none"><li>• System default profile: 0 to 127</li><li>• ITU G.8275.1 profile: 24 to 43</li></ul> <p> <b>NOTE:</b> Domain numbers 128 to 255 are reserved and cannot be configured for the system default profile.</p> |
| <b>Defaults</b>            | <ul style="list-style-type: none"><li>• System default profile: 0</li><li>• ITU G.8275.1 profile: 24</li></ul>                                                                                                                                                                                                                                                                                     |
| <b>Command Mode</b>        | CONFIGURATION                                                                                                                                                                                                                                                                                                                                                                                      |
| <b>Security and Access</b> | Netadmin and sysadmin                                                                                                                                                                                                                                                                                                                                                                              |
| <b>Usage Information</b>   | The <code>no</code> form of this command removes the configuration.                                                                                                                                                                                                                                                                                                                                |
| <b>Example</b>             | <pre>OS10(config)# ptp domain 1</pre>                                                                                                                                                                                                                                                                                                                                                              |
| <b>Supported Releases</b>  | 10.5.1.0 or later                                                                                                                                                                                                                                                                                                                                                                                  |

## ptp enable

Enables PTP on a physical or port channel interface.

|                   |                         |
|-------------------|-------------------------|
| <b>Syntax</b>     | <code>ptp enable</code> |
| <b>Parameters</b> | None                    |
| <b>Defaults</b>   | Disabled                |

|                            |                                                                                                                                                                                                                                                                                                                                                                                |
|----------------------------|--------------------------------------------------------------------------------------------------------------------------------------------------------------------------------------------------------------------------------------------------------------------------------------------------------------------------------------------------------------------------------|
| <b>Command Mode</b>        | INTERFACE CONFIGURATION                                                                                                                                                                                                                                                                                                                                                        |
| <b>Security and Access</b> | Netadmin and sysadmin                                                                                                                                                                                                                                                                                                                                                          |
| <b>Usage Information</b>   | The PTP protocol operates only on interfaces with a network address. Ensure that you have configured the PTP transport method for the interface using the <code>ptp transport</code> command. You can enable PTP on either the port channel interface or the port channel member interfaces, but not both. The <code>no</code> form of this command removes the configuration. |
| <b>Example</b>             | <pre>OS10(config)# interface ethernet 1/1/1 OS10(conf-if-eth1/1/1)# ptp enable</pre>                                                                                                                                                                                                                                                                                           |
| <b>Supported Releases</b>  | 10.5.1.0 or later                                                                                                                                                                                                                                                                                                                                                              |

## ptp local-priority

Configures the local priority for the PTP clock.

|                            |                                                                                                                                                                                                                                                                             |
|----------------------------|-----------------------------------------------------------------------------------------------------------------------------------------------------------------------------------------------------------------------------------------------------------------------------|
| <b>Syntax</b>              | <code>ptp local-priority <i>priority-number</i></code>                                                                                                                                                                                                                      |
| <b>Parameters</b>          | <i>priority-number</i> —Enter a value from 1 to 255.                                                                                                                                                                                                                        |
| <b>Defaults</b>            | 128                                                                                                                                                                                                                                                                         |
| <b>Command Mode</b>        | <ul style="list-style-type: none"> <li>• CONFIGURATION</li> <li>• INTERFACE CONFIGURATION</li> </ul>                                                                                                                                                                        |
| <b>Security and Access</b> | Netadmin and sysadmin                                                                                                                                                                                                                                                       |
| <b>Usage Information</b>   | This command is applicable only for boundary clocks and for the ITU G.8275.1 profile. Use the local-priority attribute to compare the local clock with the data on another potential grandmaster clock. The <code>no</code> form of this command removes the configuration. |
| <b>Example</b>             | <pre>OS10(config)# ptp local-priority 120</pre>                                                                                                                                                                                                                             |
| <b>Supported Releases</b>  | 10.5.1.0 or later                                                                                                                                                                                                                                                           |

## ptp priority1

Configures the priority1 attribute for advertising the PTP clock.

|                            |                                                                                                                                                                                                                                                                              |
|----------------------------|------------------------------------------------------------------------------------------------------------------------------------------------------------------------------------------------------------------------------------------------------------------------------|
| <b>Syntax</b>              | <code>ptp priority1 <i>priority-number</i></code>                                                                                                                                                                                                                            |
| <b>Parameters</b>          | <i>priority-number</i> —Priority1 has the highest precedence among the six attributes that are used in the selection of the master clock. Enter a value from 0 to 255 for the system default profile. The G.8275.1 profile assigns a static value of 128 for this attribute. |
| <b>Defaults</b>            | 128                                                                                                                                                                                                                                                                          |
| <b>Command Mode</b>        | CONFIGURATION                                                                                                                                                                                                                                                                |
| <b>Security and Access</b> | Netadmin and sysadmin                                                                                                                                                                                                                                                        |
| <b>Usage Information</b>   | The clock with the lowest priority1 value becomes the master clock. The lower the value of this attribute, the higher is the priority. The <code>no</code> form of this command removes the configuration.                                                                   |
| <b>Example</b>             | <pre>OS10(config)# ptp priority1 125</pre>                                                                                                                                                                                                                                   |

**Supported Releases** 10.5.1.0 or later

## ptp priority2

Configures the priority2 attribute for advertising PTP clock.

**Syntax** `ptp priority2 priority-number`

**Parameters** *priority-number*—Priority2 has the fifth precedence among the six attributes that are used in the selection of the master clock. Enter a value from 0 to 255.

**Defaults** 128

**Command Mode** CONFIGURATION

**Security and Access** Netadmin and sysadmin

**Usage Information** The lower the value of this attribute, the higher is the priority. The `no` form of this command removes the configuration.

**Example**

```
OS10(config)# ptp priority2 120
```

**Supported Releases** 10.5.1.0 or later

## ptp role

Configures the interface to operate in master, slave, or dynamic role.

**Syntax** `ptp role {dynamic | master | slave}`

**Parameters**

- `master`—Enables master role only on the interface
- `slave`—Enables slave role only on the interface
- `dynamic`—Enables dynamic role on the interface. The interface can be a master or slave based on the best master clock algorithm (BMCA).

**Defaults** Dynamic

**Command Mode** INTERFACE CONFIGURATION

**Security and Access** Netadmin and sysadmin

**Usage Information** If the configuration conflicts with unicast transport mode, this command returns an error. The `no` form of this command removes the configuration.

**Example**

```
OS10(config)# interface ethernet 1/1/1
OS10(conf-if-eth1/1/1)# ptp role master
```

**Supported Releases** 10.5.1.0 or later

## ptp source

Configures the source IP address for the PTP multicast packets.

**Syntax** `ptp source {ipv4 ipv4-address | ipv6 ipv6-address}`

**Parameters**

- *ipv4-address*—Source IPv4 address for the PTP multicast packets
- *ipv6-address*—Source IPv6 address for the PTP multicast packets

|                            |                                                                                                                                                                                                                                                                                                                                                                                                                                               |
|----------------------------|-----------------------------------------------------------------------------------------------------------------------------------------------------------------------------------------------------------------------------------------------------------------------------------------------------------------------------------------------------------------------------------------------------------------------------------------------|
| <b>Defaults</b>            | None                                                                                                                                                                                                                                                                                                                                                                                                                                          |
| <b>Command Mode</b>        | CONFIGURATION                                                                                                                                                                                                                                                                                                                                                                                                                                 |
| <b>Security and Access</b> | Netadmin and sysadmin                                                                                                                                                                                                                                                                                                                                                                                                                         |
| <b>Usage Information</b>   | Supports both IPv4 and IPv6 addresses. The version of the source IP address (IPv4 or IPv6) depends on the transport mode that you configured using the <code>ptp transport</code> command. The IPv4 or IPv6 address that you specify must correspond to a configured L3 interface (physical, Loopback, VLAN, or port channel) and the interface must be operationally up. The <code>no</code> form of this command removes the configuration. |
| <b>Example</b>             | <pre>OS10(config)# ptp source ipv4 10.10.10.1</pre> <pre>OS10(config)# ptp source ipv6 2018:1105::1</pre>                                                                                                                                                                                                                                                                                                                                     |
| <b>Supported Releases</b>  | 10.5.1.0 or later                                                                                                                                                                                                                                                                                                                                                                                                                             |

## ptp sync-interval

Configures the interval between synchronization messages.

|                            |                                                                                                                                                                                                                                                                                |
|----------------------------|--------------------------------------------------------------------------------------------------------------------------------------------------------------------------------------------------------------------------------------------------------------------------------|
| <b>Syntax</b>              | <code>ptp sync-interval log2-seconds</code>                                                                                                                                                                                                                                    |
| <b>Parameters</b>          | <i>log2-seconds</i> —Configures the logarithmic time interval in seconds between successive synchronization messages. For the system default profile, enter a value from -7 to 1 (1/128 s to 2 s). For the ITU G.8275.1 profile, enter a value from -7 to 4 (1/128 s to 16 s). |
| <b>Defaults</b>            | -4                                                                                                                                                                                                                                                                             |
| <b>Command Mode</b>        | INTERFACE CONFIGURATION                                                                                                                                                                                                                                                        |
| <b>Security and Access</b> | Netadmin and sysadmin                                                                                                                                                                                                                                                          |
| <b>Usage Information</b>   | The <code>no</code> form of this command removes the configuration.                                                                                                                                                                                                            |
| <b>Example</b>             | <pre>OS10(config)# interface ethernet 1/1/1</pre> <pre>OS10(conf-if-eth1/1/1)# ptp sync-interval -1</pre>                                                                                                                                                                      |
| <b>Supported Releases</b>  | 10.5.1.0 or later                                                                                                                                                                                                                                                              |

## ptp system-time enable

Configures the PTP clock to set the system time on the switch.

|                            |                                                                                                                                                                                                                                                                                                                                                                       |
|----------------------------|-----------------------------------------------------------------------------------------------------------------------------------------------------------------------------------------------------------------------------------------------------------------------------------------------------------------------------------------------------------------------|
| <b>Syntax</b>              | <code>ptp system-time enable</code>                                                                                                                                                                                                                                                                                                                                   |
| <b>Parameters</b>          | <i>enable</i> —Enables the PTP clock and sets the system time from the PTP clock.                                                                                                                                                                                                                                                                                     |
| <b>Defaults</b>            | Disabled                                                                                                                                                                                                                                                                                                                                                              |
| <b>Command Mode</b>        | CONFIGURATION                                                                                                                                                                                                                                                                                                                                                         |
| <b>Security and Access</b> | Netadmin and sysadmin                                                                                                                                                                                                                                                                                                                                                 |
| <b>Usage Information</b>   | When you enable this configuration, PTP sets the system time on the switch only if the servo clock is phase locked. You cannot enable the PTP system time if the system is configured as an NTP client. However, you can enable the PTP system time if the system is configured as an NTP server. The <code>no</code> form of this command removes the configuration. |



## Example

```
OS10(config)# ptp system-time enable
```

## Supported Releases

10.5.1.0 or later

## ptp transport

Configures the PTP transport method for an interface.

### Syntax

```
ptp transport {ipv4 {multicast | unicast {master [negotiation-enable] | slave [negotiation-enable]}} | ipv6 {multicast | unicast {master [negotiation-enable] | slave [negotiation-enable]}} | layer2 [address {forwardable | non-forwardable}]}
```

### Parameters

- `ipv4 multicast`—Enables IPv4 multicast as the transport method.
- `ipv4 unicast master`—Enables IPv4 unicast master mode.
- `ipv4 unicast master negotiation-enable`—Enables unicast negotiation (signaling support) on master to grant unicast transmission requests from slave.
- `ipv4 unicast slave`—Enables IPv4 unicast slave mode.
- `ipv4 unicast slave negotiation-enable`—Enables unicast negotiation (signaling support) on slave to request for unicast transmission to master.
- `ipv6 multicast`—Enables IPv6 multicast as the transport method.
- `ipv6 unicast master`—Enables IPv6 unicast master mode.
- `ipv6 unicast master negotiation-enable`—Enables unicast negotiation (signaling support) on master to grant unicast transmission requests from slave.
- `ipv6 unicast slave`—Enables IPv6 unicast slave mode.
- `ipv6 unicast slave negotiation-enable`—Enables unicast negotiation (signaling support) on slave to request for unicast transmission to master.
- `layer2`—Enables Layer2 protocol (untagged or 802.1Q tagged Ethernet packet) as the transport method.
- `layer2 address forwardable`—Enables the forwardable destination address (01:1B:19:00:00:00) for the layer2 transport method.
- `layer2 address non-forwardable`—Enables the non-forwardable destination address (01:80:C2:00:00:0E) for the layer2 transport method.

### Defaults

- None for the transport method.
- Unicast negotiation is disabled for the unicast transport method.
- Forwardable destination address is enabled for the Layer 2 transport method.

### Command Mode

INTERFACE CONFIGURATION

### Security and Access

Netadmin and sysadmin

### Usage Information

- For unicast transport, you must configure an IP address in INTERFACE mode or a source IP address (in UNICAST IP CONFIGURATION mode) to represent the interface.
  - **NOTE:** If you are configuring PTP on an OS10 switch that functions as a virtual router, configure the local IP address as the source IP address for unicast transport mode. Do not configure the virtual IP address as the source IP address.
  - If you enable the unicast master mode, it leads to a sub mode where you can configure the slave IP addresses.
  - If you enable the unicast slave mode, it leads to a sub mode where you can configure the master IP addresses.
  - If the unicast transport mode configuration conflicts with role configuration, the system returns an error.
- For multicast transport, you must configure an IP address in INTERFACE mode or a source IP address (in GLOBAL CONFIGURATION mode) to represent the interface.
- You can configure Layer2 transport method when the interface is in L2 or L3 mode. The layer 2 address options are applicable only for the ITU G.8275.1 profile.

The no form of this command removes the configuration.

### Example

```
OS10(config)# interface ethernet 1/1/1
OS10(conf-if-eth1/1/1)# ptp transport ipv4 unicast master
```

**Supported Releases** 10.5.1.0 or later

## ptp vlan

Configures a VLAN for the PTP-enabled interface.

**Syntax** `ptp vlan vlan-id`

**Parameters** *vlan-id*—Specifies VLAN for the PTP interface.

**Defaults** None

**Command Mode** INTERFACE CONFIGURATION

**Security and Access** Netadmin and sysadmin

**Usage Information** You can configure only one PTP VLAN per interface. If the PTP interface is in trunk mode, the VLAN tag is added to PTP packets transmitted out of the PTP interface. The system accepts tagged ingress packets, only if the configured PTP VLAN is present in the VLAN tag. The system accepts all untagged packets. The no form of this command removes the configuration.

### Example

```
OS10(config)# interface ethernet 1/1/1
OS10(conf-if-eth1/1/1)# ptp vlan 10
```

**Supported Releases** 10.5.1.0 or later

## show ptp

Displays the PTP clock and port information.

**Syntax** `show ptp`

**Parameters** None

**Defaults** None

**Command Mode** EXEC

**Security and Access** Netadmin and sysadmin

**Usage Information** None

### Example - Boundary clock

```
OS10# show ptp
PTP Clock : Boundary
Clock Identity : 68:4f:64:ff:ff:01:db:ec
Grandmaster Clock Identity : 00:16:00:ff:fe:00:02:00
Clock Mode : One-step
Clock Quality
 Class : 248
 Accuracy : <=100ns
 Offset Log Scaled Variance : 0
Domain : 0
Priority1 : 128
Priority2 : 128
Profile : System-default
```

```
Steps Removed : 1
Mean Path Delay(ns) : 72
Offset From Master(ns) : -14
Number of Ports : 2
```

```

Interface State Port Identity

Ethernet1/1/22 Slave 68:4f:64:ff:ff:01:db:ec:1
Ethernet1/1/23 Master 68:4f:64:ff:ff:01:db:ec:2

```

```
Number of slave ports :1
Number of master ports :1
```

**Example - End-to-end transparent clock**

```
OS10# show ptp
PTP Clock : End-to-end-transparent
Delay Mechanism : End-to-end
```

**Supported Releases** 10.5.1.0 or later

## show ptp clock

Displays information about the local PTP clock and synchronization.

**Syntax** show ptp clock

**Parameters** None

**Defaults** None

**Command Mode** EXEC

**Security and Access** Netadmin and sysadmin

**Usage Information** None

**Example - Boundary clock**

```
OS10# show ptp clock
PTP Clock : Boundary
Clock Identity : 68:4f:64:ff:ff:01:db:ec
Grandmaster Clock Identity : 00:16:00:ff:fe:00:02:00
Clock Mode : One-step
Clock Quality
 Class : 248
 Accuracy : <=100ns
 Offset Log Scaled Variance : 0
Domain : 0
Priority1 : 128
Priority2 : 128
Profile : System-default
Steps Removed : 1
Mean Path Delay(ns) : 68
Offset From Master(ns) : 6
Number of Ports : 2
```

**Example - End-to-end transparent clock**

```
OS10# show ptp clock
PTP Clock : End-to-end-transparent
Delay Mechanism : End-to-end
```

**Supported Releases** 10.5.1.0 or later

## show ptp counters

Displays the count of the PTP packets received at or transmitted from an interface.

**Syntax** `show ptp counters [{ethernet node/slot/port[:subport]} | {port-channel port-channel-id}]`

- Parameters**
- `ethernet node/slot/port`—Enter the Ethernet interface information.
  - `port-channel port-channel-id`—Enter the port channel interface number.

**Defaults** None

**Command Mode** EXEC

**Security and Access** Netadmin and sysadmin

**Usage Information** This command displays the count of packets that are received or transmitted from the logical PTP port corresponding to the interface network address. This count does not correlate with the interface packet count. This command is not applicable for transparent clocks.

### Example

```
OS10# show ptp counters
Interface : ethernet1/1/22
Port No : 1
Total Announce messages Sent : 4061
Total Announce messages Received : 2375569
Total Sync messages Sent : 259876
Total Sync messages Received : 2375568
Total Follow Up messages Sent : 0
Total Follow Up messages Received : 0
Total Delay Request messages Sent : 74377
Total Delay Request messages Received : 0
Total Delay Response messages Sent : 0
Total Delay Response messages Received : 74371
Total Management messages Sent : 0
Total Management messages Received : 0
Total Signaling messages Sent : 0
Total Signaling messages Received : 0
Summary:
Tx messages : 338314
Rx messages : 4825508
Lost messages : 8217
Interface : ethernet1/1/23
Port No : 2
Total Announce messages Sent : 41249
Total Announce messages Received : 0
Total Sync messages Sent : 2639919
Total Sync messages Received : 0
Total Follow Up messages Sent : 0
Total Follow Up messages Received : 0
Total Delay Request messages Sent : 0
Total Delay Request messages Received : 2392374
Total Delay Response messages Sent : 2392374
Total Delay Response messages Received : 0
Total Management messages Sent : 0
Total Management messages Received : 0
Total Signaling messages Sent : 0
Total Signaling messages Received : 0
Summary:
Tx messages : 5073542
Rx messages : 2392374
Lost messages : 0
```

**Supported Releases** 10.5.1.0 or later

## show ptp foreign-masters

Displays PTP information about foreign masters.

**Syntax** `show ptp foreign-masters [{ethernet node/slot/port[:subport]} | {port-channel port-channel-id}]`

**Parameters**

- `ethernet node/slot/port`—Enter the Ethernet interface information.
- `port-channel port-channel-id`—Enter the port channel interface number.

**Defaults** None

**Command Mode** EXEC

**Security and Access** Netadmin and sysadmin

**Usage Information** The maximum number of foreign master data set entries is 10. This command is not applicable for transparent clocks.

### Example

```
OS10# show ptp foreign-masters
Interface : Ethernet1/1/22

Index Port-Identity Clock Class Clock Accuracy Offset Variance GM Pri1 GM Pri2 Announce Msgs # Receiver Interface

0(Best) 00:16::1 6 <=100ns 0 100 128 437 eth1/1/22

```

**Supported Releases** 10.5.1.0 or later

## show ptp interface

Displays PTP information about the interface.

**Syntax** `show ptp interface [{ethernet node/slot/port[:subport]} | {port-channel port-channel-id}]`

**Parameters**

- `ethernet node/slot/port[:subport]`—Enter the Ethernet interface information.
- `port-channel port-channel-id`—Enter the port channel interface number.

**Defaults** None

**Command Mode** EXEC

**Security and Access** Netadmin and sysadmin

**Usage Information** For boundary clocks, this command indicates if the port is enabled or disabled. This command is not applicable for transparent clocks.

### Example

```
OS10# show ptp interface
Interface : Ethernet1/1/22
 PTP : Enabled
 Port Identity : 68:4f:64:ff:ff:01:db:ec:1
 Port State : Slave
 Vlan :
 Transport : Ipv4-multicast
 Log Delay Request Minimum interval : -4
 Log Announce Interval : 1
 Announce Receipt Timeout Multiplier : 3
 Log Sync Interval : -4
 Delay Mechanism : End-to-end
Interface : Ethernet1/1/23
 PTP : Enabled
```

```

Port Identity : 68:4f:64:ff:ff:01:db:ec:2
Port State : Master
Vlan :
Transport : Ipv4-multicast
Log Delay Request Minimum interval : -4
Log Announce Interval : 1
Announce Receipt Timeout Multiplier : 3
Log Sync Interval : -4
Delay Mechanism : End-to-end

```

**Supported Releases** 10.5.1.0 or later

## show ptp parent

Displays information about the local PTP parent and grandmaster clock.

**Syntax** `show ptp parent`

**Parameters** None

**Defaults** None

**Command Mode** EXEC

**Security and Access** Netadmin and sysadmin

**Usage Information** This command is not applicable for transparent clocks.

### Example

```

OS10# show ptp parent
Parent Clock Identity : 00:16:00:ff:fe:00:02:00
Parent Port Number : 1
Grandmaster Clock Identity : 00:16:00:ff:fe:00:02:00
Grandmaster Clock Quality
 Class : 6
 Accuracy : <=100ns
 OffsetLogScaledVariance : 0
Grandmaster Clock Priority1 : 100
Grandmaster Clock Priority2 : 128

```

**Supported Releases** 10.5.1.0 or later

## show ptp peer

Displays the count of PTP messages received from a peer at an interface or transmitted to a peer from an interface.

**Syntax** `show ptp peer [{ethernet node/slot/port[:subport]} | {port-channel port-channel-id}]`

**Parameters**

- *ethernet node/slot/port[:subport]*—Enter the Ethernet interface information.
- *port-channel port-channel-id*—Enter the port channel interface number.

**Defaults** None

**Command Mode** EXEC

**Security and Access** Netadmin and sysadmin

**Usage Information** This command is not applicable for transparent clocks.

## Example

```
OS10# show ptp peer
Interface : Ethernet1/1/22
Total number of peers : 1
 Peer index : 0
 Peer Clock Identity : 00:16:00:ff:fe:00:02:00
 Peer Port number : 1
 Peer Port Address : 22.0.0.2
 Receiving Interface : ethernet1/1/22
 Announce messages transmitted : 4061
 Announce messages received : 2372855
 Sync messages transmitted : 259876
 Sync messages received : 2372854
 Follow up messages transmitted : 0
 Follow up messages received : 0
 Delay request messages transmitted : 74292
 Delay request messages received : 0
 Delay response messages transmitted : 0
 Delay response messages received : 74286
 Management messages transmitted : 0
 Management messages received : 0
 Signaling messages transmitted : 0
 Signaling messages received : 0
Interface : Ethernet1/1/23
Total number of peers : 1
 Peer index : 0
 Peer Clock Identity : 00:17:00:ff:fe:00:02:00
 Peer Port number : 1
 Peer Port Address : 23.0.0.2
 Receiving Interface : ethernet1/1/23
 Announce messages transmitted : 41207
 Announce messages received : 0
 Sync messages transmitted : 2637200
 Sync messages received : 0
 Follow up messages transmitted : 0
 Follow up messages received : 0
 Delay request messages transmitted : 0
 Delay request messages received : 2389638
 Delay response messages transmitted : 2389638
 Delay response messages received : 0
 Management messages transmitted : 0
 Management messages received : 0
 Signaling messages transmitted : 0
 Signaling messages received : 0
```

**Supported Releases** 10.5.1.0 or later

## show ptp servo

Displays PTP servo information such as servo state and lock status.

|                            |                       |
|----------------------------|-----------------------|
| <b>Syntax</b>              | show ptp servo        |
| <b>Parameters</b>          | None                  |
| <b>Defaults</b>            | None                  |
| <b>Command Mode</b>        | EXEC                  |
| <b>Security and Access</b> | Netadmin and sysadmin |
| <b>Usage Information</b>   | None                  |

### Example

```
OS10# show ptp servo
Servo State : Locked
Lock Status : Phase-locked
```

**Supported Releases** 10.5.1.0 or later

## show ptp time-properties

Displays information about the time scale.

**Syntax** `show ptp time-properties`

**Parameters** None

**Defaults** None

**Command Mode** EXEC

**Security and Access** Netadmin and sysadmin

**Usage Information** This command is not applicable for transparent clocks.

### Example

```
OS10# show ptp time-properties
Current UTC Offset Valid : False
Current UTC Offset : 0
Leap 59 : False
Leap 61 : False
Time Traceable : False
Frequency Traceable : False
PTP Timescale : False
Time source : Gps
```

**Supported Releases** 10.5.1.0 or later

## slave

Configures the IP address of PTP slave devices for the master clock.

**Syntax** `slave ip-address`

**Parameters** `ip-address`—IP address of the slave clock device

**Defaults** No default IP address; unicast negotiation disabled

**Command Mode** INTERFACE CONFIGURATION - MASTER submode

**Security and Access** Netadmin and sysadmin

**Usage Information** You can configure the IP addresses of multiple slaves. The format of the slave IP address depends on the configured unicast mode. The system reports an error when you configure more than the maximum number of slaves. The `no` form of this command removes the configuration.

### Example

```
OS10(config)# interface ethernet 1/1/1
OS10(conf-if-eth1/1/1)# ptp transport ipv4 unicast master
OS10(conf-ethernet1/1/1-ptp-ipv4-master)# slave 10.10.10.1
OS10(conf-ethernet1/1/1-ptp-ipv4-master)# slave 10.10.10.2
```

**Supported Releases** 10.5.1.0 or later



## source

Configures the source IP address for unicast transport from master to slave and slave to master.

**Syntax** `source ip-address`

**Parameters** `ip-address`—Specifies the source IP address for the PTP packets.

**Defaults** None

**Command Mode**

- INTERFACE CONFIGURATION - MASTER submode
- INTERFACE CONFIGURATION - SLAVE submode

**Security and Access** Netadmin and sysadmin

**Usage Information** This command is applicable for unicast transport mode. This configuration is required for an L2 interface. For an L3 interface, if you do not configure the source IP address, the system uses the interface IP address as the source IP address for the PTP packets. The `no` form of this command removes the configuration.

**NOTE:** If you are configuring PTP on an OS10 switch that functions as a virtual router, configure the local IP address as the source IP address for unicast transport mode. Do not configure the virtual IP address as the source IP address.

### Example - MASTER submode

```
OS10(config)# interface ethernet 1/1/1
OS10(conf-if-eth1/1/1)# ptp transport ipv4 unicast master
OS10(conf-ethernet1/1/1-ptp-ipv4-master)# source 10.10.10.2
```

### Example - SLAVE submode

```
OS10(config)# interface ethernet 1/1/1
OS10(conf-if-eth1/1/1)# ptp transport ipv4 unicast slave
OS10(conf-ethernet1/1/1-ptp-ipv4-slave)# source 10.10.10.2
```

**Supported Releases** 10.5.1.0 or later

## Dynamic Host Configuration Protocol

Dynamic Host Configuration Protocol (DHCP) is an application layer protocol that dynamically assigns IP addresses and other configuration parameters to network end-stations, also known as hosts, based on configuration policies network administrators determine.

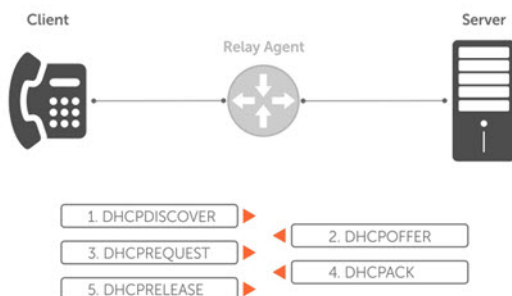

**DHCP server** Network device offering configuration parameters to the client.

**DHCP client** Network device requesting configuration parameters from the server.

**Relay agent** Intermediary network device that passes DHCP messages between the client and the server when the server is not on the same subnet as the host.

### Configuration notes

All Dell EMC PowerSwitches except MX-Series, S4200-Series, S5200 Series, and Z9332F-ON:

- DHCP automatic address allocation-before you configure a DHCP address pool, you must configure a DHCP server interface with an IP address in the range that is used in the DHCP address pool. If you configure the DHCP address pool first, and then configure a DHCP server interface, to enable automatic DHCP address allocation, you must restart the DHCP service using the disable and no disable commands. Select one of the choices for successfully configuring a DHCP address pool:
  - Configure manual binding for a host/hardware MAC address in the IP address range that is used for the DHCP pool.
  - Configure a network statement with a valid IP address range.
- DHCP client on management interface-DHCP client is enabled by default on the management interface. The management interface automatically tries to obtain an IP address from a DHCP server. To manually configure an IP address on the management port, disable the DHCP client using the no ip address dhcp command in Interface mode
- The DHCP server does not start unless at least one interface matches one of the configured network pools. An interface matches a network pool when you include the IP address in the subnet that is defined for that network pool. For example, an interface with IP address 10.1.1.1/24 matches a pool that is configured with network 10.1.1.0/24..

If you attempt to enable (start) the DHCP server with an incorrect configuration, you must re-enable the DHCP server after you enter the correct configuration.

Consider the following example, and assume that no interface matches either one of the network pools, netdhcp1 and netdhcp2:

```
OS10# show running-configuration ip dhcp
!
ip dhcp server
no disable
!
pool netdhcp1
lease infinite
network 35.1.1.0/24
!
pool netdhcp2
network 40.1.1.0/24
OS10# show ip interface brief
Interface Name IP-Address OK Method Status
Protocol
=====
===
Ethernet 1/1/1 unassigned YES unset up
up
Ethernet 1/1/2 unassigned YES unset up
up
...
Ethernet 1/1/32 unassigned NO unset up down
...
```

To resolve this issue, you must:

1. Configure a matching interface for pool netdhcp2-40.1.1.1/24 matches 40.1.1.0/24.

```
OS10(config)# interface ethernet 1/1/2
OS10(config-if-eth1/1/2)# no shutdown
OS10(config-if-eth1/1/2)# no switchport
OS10(config-if-eth1/1/2)# ip address 40.1.1.1/24
```

2. Run the show ip interface brief command to verify if an IP address is assigned to ethernet 1/1/2 port.

```
OS10# show ip interface brief
Interface Name IP-Address OK Method Status
Protocol
=====
=====
Ethernet 1/1/1 unassigned YES unset up
up
Ethernet 1/1/2 40.1.1.1/24 YES manual up
up
...
```

3. Re-enable the DHCP server because it failed to start initially.

```
OS10# configure terminal
OS10(config)# ip dhcp server
OS10(config-dhcp)# disable
```

```
OS10(config-dhcp)# no disable
OS10(config-dhcp)#
```

## Packet format and options

The DHCP server listens on port 67 and transmits to port 68. The DHCP client listens on port 68 and transmits to port 67.

In the DHCP packet format, configuration parameters are options in the DHCP packet in type, length, value (TLV) format. To limit the number of parameters that servers provide, hosts enter the parameters that they require and the server sends only those parameters. DHCP uses the User Datagram Protocol (UDP) as its transport protocol.



The following options are commonly used in DHCP packets.

### DHCP Option Description

|                                            |                                                                                                                                                                                                                                                             |
|--------------------------------------------|-------------------------------------------------------------------------------------------------------------------------------------------------------------------------------------------------------------------------------------------------------------|
| <b>Subnet mask</b>                         | 1 — Subnet mask of the client                                                                                                                                                                                                                               |
| <b>Router</b>                              | 3 — Router IP addresses that serve as the default gateway for the client                                                                                                                                                                                    |
| <b>Domain name server</b>                  | 6 — Domain name servers (DNS) that are available to the client                                                                                                                                                                                              |
| <b>Domain name</b>                         | 15 — Domain name that clients use to resolve hostnames via DNS                                                                                                                                                                                              |
| <b>IP address lease time</b>               | 51 — Amount of time that the client uses an assigned IP address                                                                                                                                                                                             |
| <b>DHCP message type</b>                   | 53: <ul style="list-style-type: none"> <li>• 1 — DHCPDISCOVER</li> <li>• 2 — DHCPOFFER</li> <li>• 3 — DHCPREQUEST</li> <li>• 4 — DHCPDECLINE</li> <li>• 5 — DHCPACK</li> <li>• 6 — DHCPNACK</li> <li>• 7 — DHCPRELEASE</li> <li>• 8 — DHCPINFORM</li> </ul> |
| <b>Parameter request list</b>              | 55 — A list of parameters that a DHCP client requires from the DHCP server. This is a series of octets where each octet is a DHCP option code                                                                                                               |
| <b>Renewal time</b>                        | 58 — Amount of time, after the IP address is granted, that the client attempts to renew its lease with the <i>original</i> server                                                                                                                           |
| <b>Rebinding time</b>                      | 59 — Amount of time, after the IP address is granted, that the client attempts to renew its lease with <i>any</i> server, if the original server does not respond                                                                                           |
| <b>Vendor class identifier</b>             | 60 — User-defined string the Relay Agent uses to forward DHCP client packets to a specific DHCP server                                                                                                                                                      |
| <b>DHCP relay agent information option</b> | 82 — Helps secure DHCP traffic that goes through a DHCP relay agent, and ensures that communication between the DHCP relay agent and the DHCP server is not compromised.                                                                                    |

## DHCP Option    Description

|                           |                                                                                                            |
|---------------------------|------------------------------------------------------------------------------------------------------------|
| <b>User port stacking</b> | 230 — Stacking option variable that provides the DHCP server stack-port details when the DHCP offer is set |
| <b>End</b>                | 255 — Signal of the last option in the DHCP packet                                                         |

## DHCP server

The Dynamic Host Configuration Protocol (DHCP) server provides network configuration parameters to DHCP clients on request. A DHCP server dynamically allocates four required IP parameters to each system on the virtual local area network (VLAN)—the IP address, network mask, default gateway, and name server address. DHCP IP address allocation works on a client/server model where the server assigns the client reusable IP information from an address pool.

DHCP automates network-parameter assignment to network devices. Even in small networks, DHCP makes it easier to add new devices to the network. The DHCP access service provides a centralized, server-based setup to add clients to the network. This setup means you do not have to create and maintain IP address assignments to clients manually.

When you use DHCP to manage a pool of IP addresses among hosts, you reduce the number of IP addresses you need. DHCP manages the IP address pool by leasing an IP address to a host for a limited period, allowing the DHCP server to share a limited number of IP addresses. DHCP also provides a central database of devices that connects to the network and eliminates duplicate resource assignments.

 **NOTE:** The implementation of DHCP server supports IPv4 and IPv6 addresses.

## DHCPv6 server

A Dynamic Host Configuration Protocol version 6 (DHCPv6) server is the IPv6 equivalent of the DHCP server for IPv4. It is used to automatically allocate IPv6 addresses and distribute network configuration information to IPv6 hosts in a network. You can configure IPv6 pools with various configurations such as lease time, DNS server, and other user-defined options using DHCPv6.

## Automatic address allocation

Automatic address allocation is an address assignment method that the DHCP server uses to lease an IP address to a client from a pool of available addresses. You cannot configure an empty DHCP pool under a DHCP pool configuration. For a successful commit, you must have either a network statement or host/hardware-address (manual binding) configuration. An IP address pool is a range of addresses that the DHCP server assigns. Both IPv4 and IPv6 DHCP pool configuration is supported. The subnet number indexes the address pools.

1. Enable the DHCP server in CONFIGURATION mode.

```
ip dhcp server
```

2. Create an IP address pool and provide a name in DHCP mode.

```
pool name
```

3. Enter the subnet from which the DHCP server may assign addresses in DHCP *POOL* mode. The *network* option specifies the subnet address. The *prefix-length* option specifies the number of bits used for the network portion of the address; for IPv4 addresses, the valid values are from 17 to 30.

```
network network/prefix-length
```

4. Enter a range of IP addresses from the subnet specified above, which the DHCP server uses to assign addresses in DHCP *<POOL>* mode.

```
range {ip-address1 [ip-address2]}
```

 **NOTE:** Configure at least one interface to match one of the configured network pools. An interface matches a network pool when its IP address is included in the subnet defined for that network pool. For example, an interface with IP address 10.1.1.1/24 matches a pool configured with network 10.1.1.0/24.

## DHCP server automatic address allocation

```
OS10(config)# ip dhcp server
OS10(config-dhcp)# pool Dell
OS10(config-dhcp-Dell)# default-router 20.1.1.1
OS10(config-dhcp-Dell)# network 20.1.1.0/24
OS10(config-dhcp-Dell)# range 20.1.1.2 20.1.1.8
```

## Show running configuration

```
OS10(conf-dhcp-Dell)# do show running-configuration
...
!
ip dhcp server
!
pool Dell
network 20.1.1.0/24
default-router 20.1.1.1
range 20.1.1.2 20.1.1.8
```

## Address lease time

Use the `lease {days [hours] [minutes] | infinite}` command to configure an address lease time. The default is 24 hours.

```
OS10(config)# ip dhcp server
OS10(conf-dhcp)# pool Dell
OS10(conf-dhcp-Dell)# lease 36
```

## Default gateway

Ensure the IP address of the default router is on the same subnet as the client.

1. Enable DHCP server-assigned dynamic addresses on an interface in CONFIGURATION mode.

```
ip dhcp server
```

2. Create an IP address pool and provide a name in DHCP mode.

```
pool name
```

3. Enter the default gateway(s) for the clients on the subnet in order of preference in DHCP<POOL> mode.

```
default-router address
```

## Change default gateway name

```
OS10(config)# ip dhcp server
OS10(conf-dhcp)# pool Dell
OS10(conf-dhcp-Dell)# default-router 20.1.1.1
```

## Enable the DHCP server

Use the `ip dhcp server` command to enable DHCP server-assigned dynamic addresses on an interface in CONFIGURATION mode. The DHCP server is disabled by default.

```
OS10(config)# ip dhcp server
OS10(conf-dhcp)# no disable
```

## Hostname resolution

You have two choices for hostname resolution — domain name server (DNS) or NetBIOS Windows internet naming service (WINS). Both DHCP and WINS clients query IP servers to compare hostnames to IP addresses.

1. Enable DHCP server-assigned dynamic addresses on an interface in CONFIGURATION mode.

```
ip dhcp server
```

2. Create an IP address pool and enter the name in DHCP mode.

```
pool name
```

3. Create a domain and enter the domain name in DHCP <POOL> mode.

```
domain-name name
```

4. Enter the DNS servers in order of preference that is available to a DHCP client in DHCP <POOL> mode.

```
dns-server address
```

### DNS address resolution

```
OS10(config)# ip dhcp server
OS10(conf-dhcp)# pool Dell
OS10(conf-dhcp-Dell)# domain-name dell.com
OS10(conf-dhcp-Dell)# dns-server 192.168.1.1
```

## NetBIOS WINS address resolution

DHCP clients can be one of four types of NetBIOS nodes — broadcast, peer-to-peer, mixed, or hybrid. Dell Technologies recommends using hybrid as the NetBIOS node type.

1. Enable DHCP server-assigned dynamic addresses on an interface in CONFIGURATION mode.

```
ip dhcp server
```

2. Create an IP address pool and enter the pool name in DHCP mode.

```
pool name
```

3. Enter the NetBIOS WINS name servers in the order of preference that they are available to DHCP clients in DHCP <POOL> mode.

```
netbios-name-server ip-address
```

4. Enter the keyword Hybrid as the NetBIOS node type in DHCP <POOL> mode.

```
netbios-node-type type
```

### Configure NetBIOS WINS address resolution

```
OS10(config)# ip dhcp server
OS10(conf-dhcp)# pool Dell
OS10(conf-dhcp-Dell)# netbios-name-server 192.168.10.5
OS10(conf-dhcp-Dell)# netbios-node-type Hybrid
```

## Manual binding entries

Address binding is a mapping between the IP address and the media access control (MAC) address of a client. The DHCP server assigns the client an available IP address automatically and then creates an entry in the binding table. You can also manually create an entry for a client. Manual bindings help to guarantee that a particular network device receives a particular IP address.

Consider manual bindings as single-host address pools. There is no limit to the number of manual bindings, but you can only configure one manual binding per host. Manual binding entries do not display in the `show ip dhcp binding` output.

1. Create an address pool in DHCP mode.

```
pool name
```

2. Enter the client IP address in DHCP `<POOL>` mode.

```
host address
```

3. Enter the client hardware address in DHCP `<POOL>` mode.

```
hardware-address hardware-address
```

### Configure manual binding

```
OS10(config)# ip dhcp server
OS10(conf-dhcp)# pool static
OS10(conf-dhcp-static)# host 20.1.1.2
OS10(conf-dhcp-static)# hardware-address 00:01:e8:8c:4d:0a
```

### View the DHCP binding table

```
OS10# show ip dhcp binding
 IP Address Hardware address Lease expiration Hostname
+-----+-----+-----+-----+
11.1.1.254 00:00:12:12:12:12 Jan 27 2016 06:23:45
Total Number of Entries in the Table = 1
```

With a fixed host configuration, also known as manual binding, you must configure a network pool with a matching subnet. The static host-to-MAC address mapping pool inherits the network mask from the network pool with subnet configuration, which includes the host's address range.

In the following example, the pool `host1`, which is the fixed host mapping pool, inherits the subnet and other attributes from the pool `hostnetwork`, which is the DHCP client IP address pool. There is no matching network pool for `host2`. Therefore, the DHCP client with the MAC address `00:0c:29:aa:22:f4` does not obtain the correct parameters.

```
OS10# show running-configuration interface ethernet 1/1/2
!
interface ethernet1/1/2
no shutdown
no switchport
ip address 100.1.1.1/24
flowcontrol receive off

OS10# show running-configuration ip dhcp
!
ip dhcp server
no disable
!
pool host1
host 100.1.1.34
hardware-address 00:0c:29:ee:4c:f4
!
pool hostnetwork
lease infinite
network 100.1.1.0/24
!
pool host2
host 20.1.1.34
hardware-address 00:0c:29:aa:22:f4
```

## View DHCP Information

Use the `show ip dhcp binding` command to view the DHCP binding table entries.

```
OS10# show ip dhcp binding
 IP Address Hardware address Lease expiration Hostname

11.1.1.254 00:00:12:12:12:12 Jan 27 2016 06:23:45
Total Number of Entries in the Table = 1
```

## DHCP relay agent

A DHCP relay agent relays DHCP messages to and from a remote DHCP server, even if the client and server are on different IP networks. You can configure the IP address of the remote DHCP server.

You can configure a device either as a DHCP server or a DHCP relay agent — but not both.

If routes are not leaked between VRFs, the DHCP relay agent supports multi-virtual routing and forwarding (VRF) instances. The client-facing and server-facing interfaces must be in the same VRF.

 **NOTE:** DHCP relay implementation supports IPv4 and IPv6 addresses.

## Option 82 for security

DHCP, as defined by RFC 2131, provides no authentication or security mechanisms. To ensure security, the DHCP relay agent supports Option-82 with the Circuit ID sub-option, which is the printable name of the interface where the client request was received.

This option secures all DHCP traffic that goes through a DHCP relay agent, and ensures that communication between the DHCP relay agent and the DHCP server is not compromised.

The DHCP relay agent inserts Option 82 before forwarding DHCP packets to the DHCP server. The DHCP server includes Option 82 back in its response to the relay agent. The relay agent uses this information to forward a reply out the interface on which the request was received rather than flooding it on the entire VLAN. However, the relay agent removes Option 82 from its DHCP responses before forwarding the responses to the client.

 **NOTE:** Option 82 is supported, but not configurable.

## DHCP snooping

DHCP snooping is a layer 2 security feature that helps networking devices to monitor DHCP messages and block untrusted or rogue DHCP servers.

When you enable DHCP snooping on a switch, it begins monitoring transactions between trusted DHCP servers and DHCP clients and uses the information to build the DHCP snooping binding table. You configure interfaces that connect to DHCP servers as trusted interfaces. All other interfaces are untrusted by default.

The DHCP snooping binding table contains the following information:

- Client IP addresses
- Client MAC addresses
- Interface facing the clients
- Client VLAN
- Lease time
- DHCP binding type – static or dynamic

The switch considers DHCP servers connected to trusted interfaces on the switch as legitimate servers. When a switch receives DHCP server-initiated packets (UDP destination port 67) on an untrusted interface, it drops the packet.



When a switch receives DHCP renew, release, or decline messages from a client, it checks the DHCP snooping binding table for a match. If the information in the DHCP message matches the table, the switch forwards the message to the DHCP server. If the information does not match, the switch interprets the client as an unauthorized client and drops the packet.

The DHCP snooping switch removes a dynamically-learned DHCP snooping binding entry when one of the following occurs:

- Lease expiry
- DHCP RELEASE packet received from the client
- DHCP DECLINE packet received from the client
- User actions, such as DHCP clear or disabling DHCP snooping

You can add a static DHCP snooping binding entry using the CLI. If you add a static entry for a client, any dynamic entry that is present for the same client is overwritten. The switch does not remove static entries if it receives DHCP RELEASE or DHCP DECLINE packets.

By default, DHCP snooping is disabled globally and enabled on VLANs. For the DHCP snooping feature to work, enable it globally.

**NOTE:** If you move a DHCP client from an untrusted interface to another untrusted interface within the VLAN, the DHCP snooping binding database is not updated. The switch drops subsequent packets from the client. However, if you move a DHCP client from an untrusted interface to a trusted interface, there is no impact to the traffic from the client.

### Restrictions for DHCP snooping

- The management VLAN does not support DHCP snooping.
- VxLAN bridges do not support DHCP snooping.
- The maximum number of supported DHCP snooping binding entries is 4000.
- OS10 does not support multi-hop DHCP snooping.
- For the DHCP snooping functionality to work correctly, ensure that the DHCP server supports option 82 (RFC 3046).
- Enable option 82 (RFC 3046) on the DHCP server for the DHCP Snooping functionality to work correctly.

### Rogue DHCP server detection

In the following topology, a trusted DHCP server, a DHCP client, and a rogue DHCP server are connected to the DHCP snooping switch. The DHCP client and DHCP server are on the same VLAN. The physical interface eth 1/1/2 is a trusted interface. When the rogue DHCP server sends a DHCP packet to the client, the switch analyzes the packet. As the rogue server is connected to the switch to an untrusted eth 1/1/3 interface the switch deems the server as a rogue DHCP server and drops the packet.

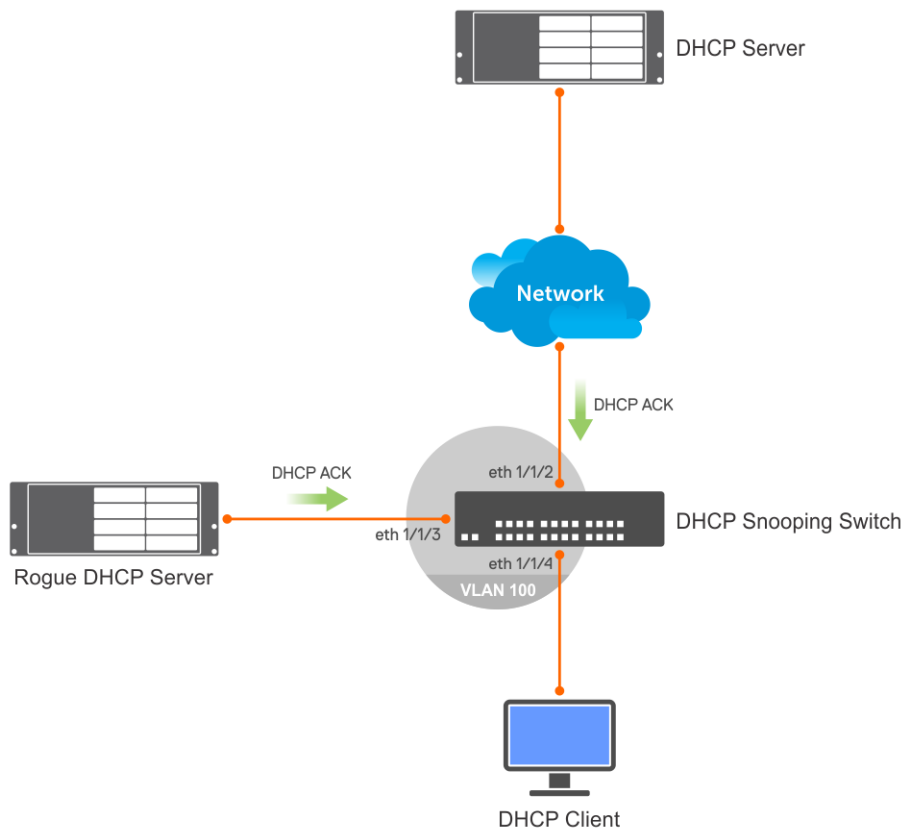

### DHCP snooping with DHCP relay

In the following topology, the DHCP snooping switch is the DHCP relay agent for DHCP clients on VLAN 100. The DHCP server is reachable on VLAN 200 through eth 1/1/2. The switch forwards the client DHCP messages to the trusted DHCP server. The switch processes DHCP packets from the DHCP server before forwarding them to DHCP clients. As the rogue server is connected to the switch to the eth 1/1/3 interface which is untrusted, the switch drops DHCP packets from that interface.

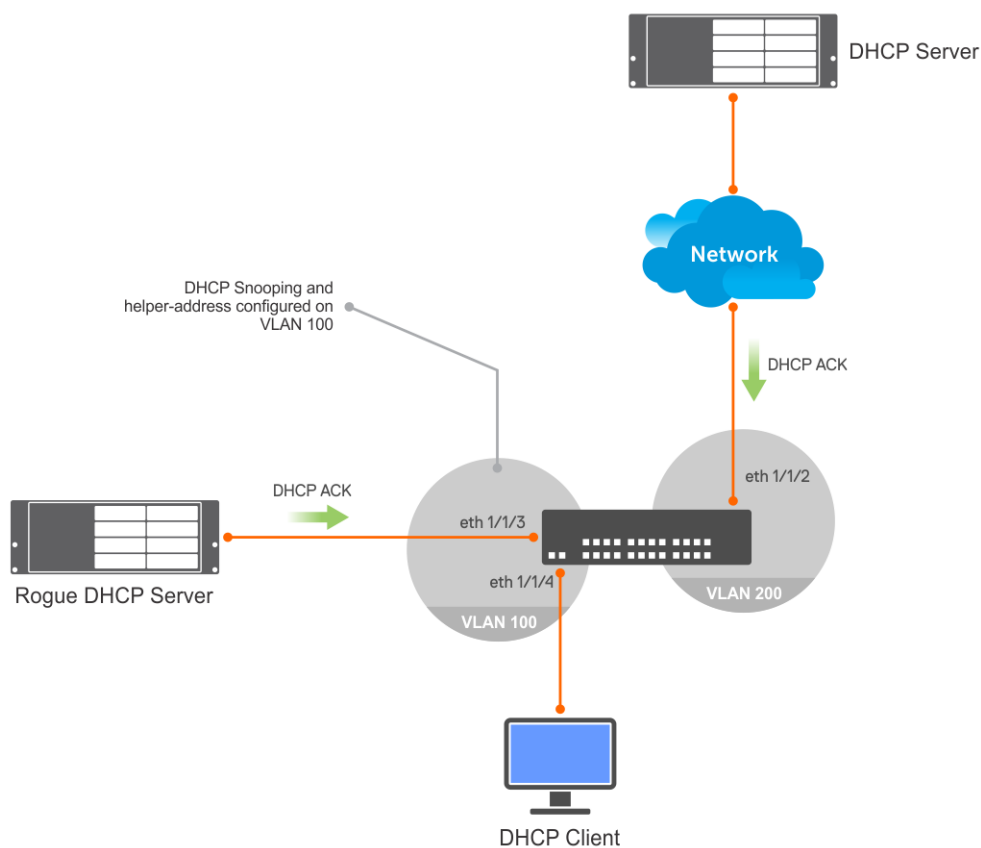

### DHCP snooping in a VLT environment

OS10 supports DHCP snooping in a VLT environment. DHCP snooping switches in a VLT topology synchronize DHCP snooping binding information between them. The system interprets the VLTi link between VLT peers as trusted interfaces. To configure DHCP snooping in a VLT environment:

- Enable DHCP snooping on both VLT peers.
- Configure the VLT port-channel interfaces facing the DHCP server as trusted interfaces.

In the following VLT topology, AGG1 and AGG2 are VLT peers and have VLT port-channel interfaces connected to the VM server and Core switch. The DHCP server is reachable through the CORE switch. The following describes the functioning of DHCP snooping in a VLT environment:

- One of the VLT peers receives a DHCP client packet from a DHCP client on the VM server through the VLT port-channel interface. The switch processes this packet.
- The VLT peer forwards the DHCP client packet to the Core switch through the VLT port-channel interface.
- The Core switch forwards the DHCP reply packet from the DHCP server to one of the VLT peers, which processes the packet.
- If the DHCP reply packet is from a trusted DHCP server, the VLT peer forwards the reply packet to the DHCP client on the VM server.
- The VLT peers synchronize the DHCP snooping binding table.

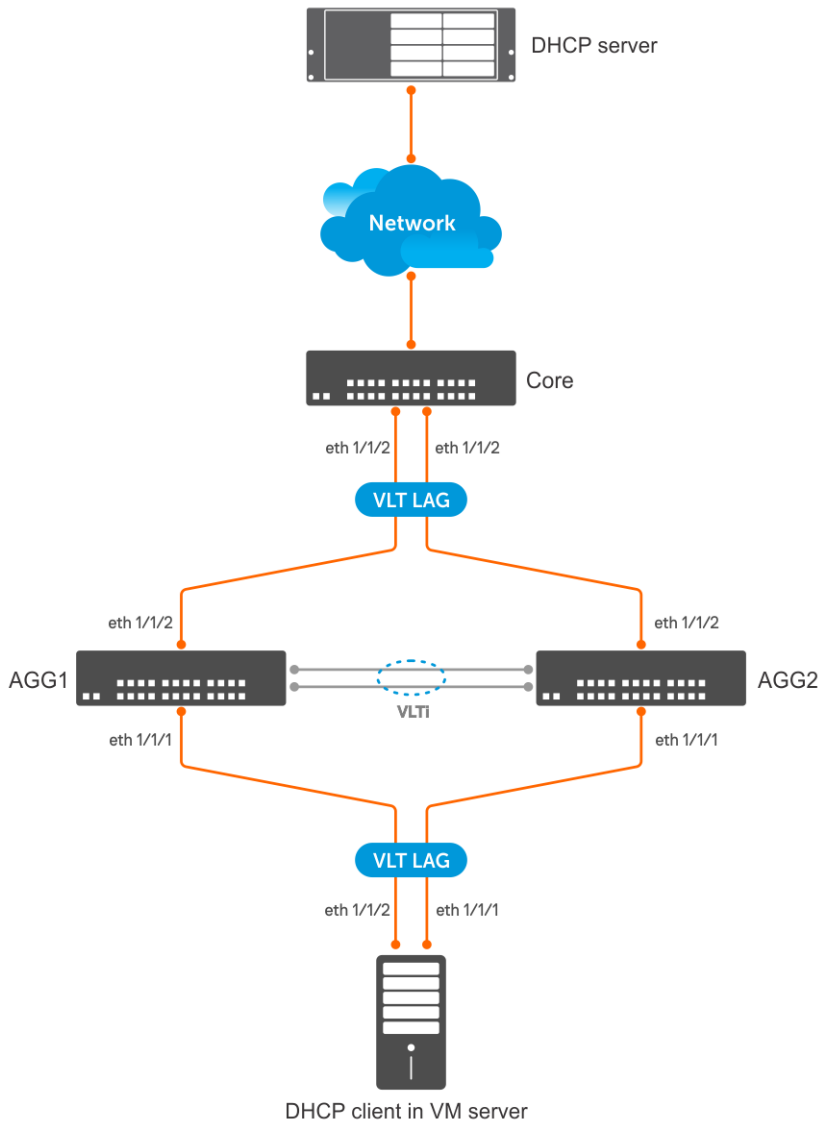

### Enable and configure DHCP snooping globally

1. Enable DHCP snooping globally in CONFIGURATION mode.

```
ip dhcp snooping
```

2. Specify physical or port-channel interfaces that have connections towards DHCP servers as trusted in INTERFACE mode.

```
ip dhcp snooping trust
```

### Add static DHCP snooping entry in the binding table

- Add a static DHCP snooping entry in the binding table in CONFIGURATION mode.

```
ip dhcp snooping binding mac mac-address vlan vlan-id ip ip-address interface
[ethernet slot/port/sub-port | port-channel port-channel-id | VLTi]
```

### Example of adding static DHCP snooping entry

```
OS10(config)# ip dhcp snooping binding mac 00:04:96:70:8a:12 vlan 100 ip 100.1.1.2
interface ethernet 1/1/4
```

### Remove static DHCP snooping entry from the binding table

- Remove a static DHCP snooping entry from the binding table in CONFIGURATION mode.

```
no ip dhcp snooping binding mac mac-address vlan vlan-id interface [ethernet slot/
port/sub-port | port-channel port-channel-id]
```

**Example for removing static DHCP snooping entry in the binding table**

```
OS10(config)# no ip dhcp snooping binding mac 00:04:96:70:8a:12 vlan 100 ip 100.1.1.2
interface ethernet 1/1/4
```

**Clear dynamically-learned entries from DHCP snooping binding table**

- Use the following command in EXEC mode:

```
clear ip dhcp snooping binding [mac mac-address] [vlan vlan-id] [interface {ethernet
slot/port/sub-port | port-channel port-channel-id}]
```

**CAUTION:** Clearing the DHCP snooping binding table using the `clear ip dhcp snooping binding` command also clears the Source Address Validation (SAV) and Dynamic ARP Inspection (DAI) entries on the system. This affects the traffic from clients that are connected to the DHCP snooping-enabled VLANs.

**Example for clearing dynamically-learned entries from DHCP snooping binding table**

The following example clears all dynamic DHCP snooping binding entries that are associated with the MAC address 04:56:79:86:73:fe

```
OS10# clear ip dhcp snooping binding mac 04:56:79:86:73:fe
```

The following example clears all dynamic DHCP snooping binding entries that are associated with VLAN 100:

```
OS10# clear ip dhcp snooping binding vlan 100
```

The following example clears all the dynamic DHCP snooping binding entries that are associated with VLAN 100 with MAC address 04:56:79:86:73:fe on port-channel 10:

```
OS10# clear ip dhcp snooping binding mac 04:56:79:86:73:fe vlan 100 port-channel 10
```

**View contents of DHCP binding table**

- Use the following command in EXEC mode:

```
show ip dhcp snooping binding [vlan vlan-name]
```

**Example for viewing contents of DHCP binding table**

```
OS10# show ip dhcp snooping binding
Codes : S - Static D - Dynamic
IPv4 Address MAC Address Expires (Sec) Type VLAN Interface
=====
10.1.1.22 11:22:11:22:11:22 120331 S 100 ethernet1/1/4
33.1.1.44 11:22:11:22:11:23 120331 S 200 port-channel100
103.1.1.5 11:22:11:22:11:24 120331 D 300 ethernet1/1/5:4
```

## DHCP snooping examples

### DHCP snooping in a simple layer 2 network

This example uses a simple topology with a DHCP snooping switch and a DHCP server. A DHCP client is connected to the snooping switch and a rogue DHCP server attempts to pose as a legitimate DHCP server. With a configuration similar to the following, the DHCP snooping switch drops packets from the rogue DHCP server which is connected to an untrusted interface.

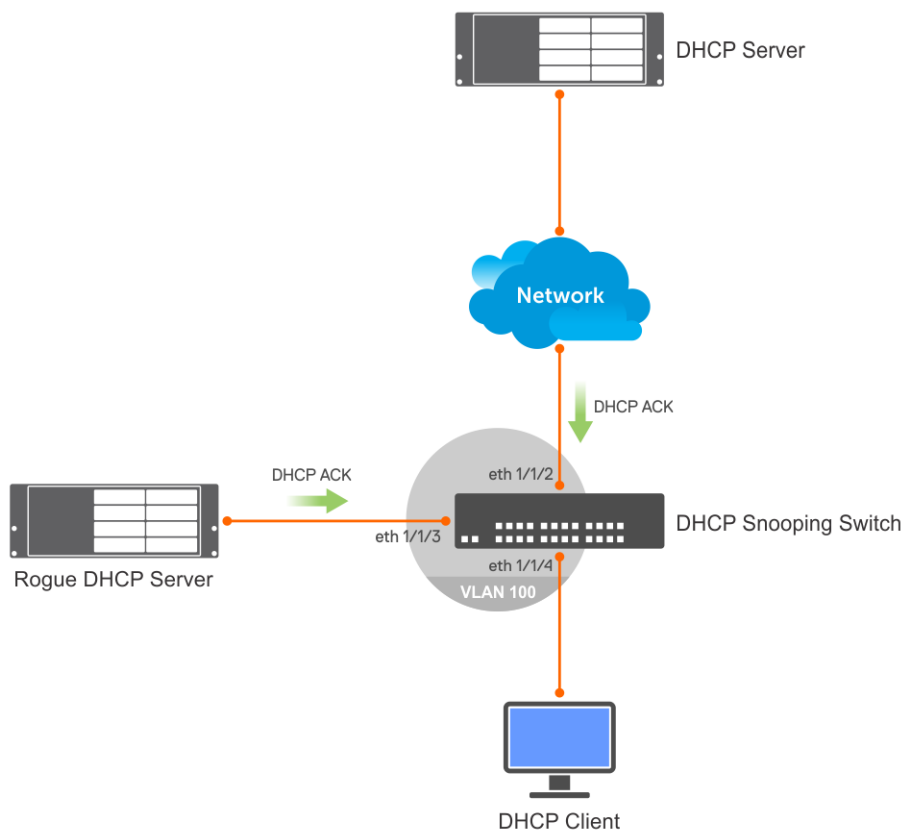

### DHCP server

```
OS10(config)# interface ethernet 1/1/1
S10(conf-if-eth1/1/1)# no shutdown
OS10(conf-if-eth1/1/1)# no switchport
OS10(conf-if-eth1/1/1)# ip address 10.1.1.1/24
OS10(conf-if-eth1/1/1)# exit
OS10(config)# ip dhcp server
OS10(config-dhcp)# no disable
OS10(config-dhcp)# pool dell_server1
OS10(config-dhcp-dell_server1)# lease 0 1 0
OS10(config-dhcp-dell_server1)# network 10.1.1.0/24
OS10(config-dhcp-dell_server1)# range 10.1.1.2 10.1.1.100
```

### DHCP snooping switch

```
OS10# configure terminal
OS10(config)# ip dhcp snooping
OS10(config)# interface vlan 100
OS10(config-if-vl-100)# exit
OS10(config)# interface ethernet 1/1/2
OS10(conf-if-eth1/1/2)# switchport access vlan 100
OS10(conf-if-eth1/1/2)# ip dhcp snooping trust
OS10(conf-if-eth1/1/2)# interface ethernet 1/1/3
OS10(conf-if-eth1/1/3)# switchport access vlan 100
OS10(conf-if-eth1/1/3)# interface ethernet 1/1/4
OS10(conf-if-eth1/1/4)# switchport access vlan 100
```

### DHCP client

```
OS10(config)# interface ethernet 1/1/4
OS10(conf-if-eth1/1/4)# no switchport
OS10(conf-if-eth1/1/4)# no ip address
OS10(conf-if-eth1/1/4)# ip address dhcp
OS10(conf-if-eth1/1/4)# end
```

## DHCP snooping switch as a relay agent

This example uses a simple topology with a DHCP snooping switch configured as a DHCP relay agent. A DHCP server and a DHCP client are connected to the snooping switch through different VLANs. A rogue DHCP server attempts to pose as a legitimate DHCP server. With a configuration similar to the following, the DHCP snooping switch drops packets from the rogue DHCP server which is connected to an untrusted interface.

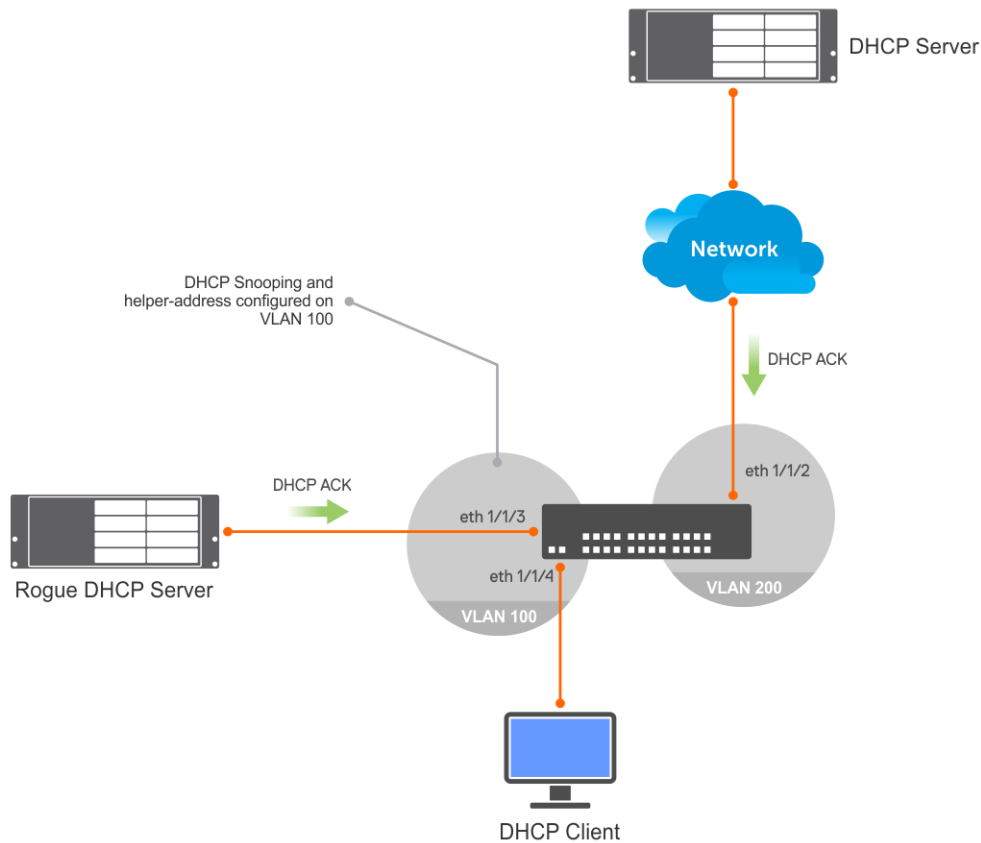

### DHCP snooping switch

```
OS10# configure terminal
OS10(config)# ip dhcp snooping
OS10(config)# end
OS10# configure terminal
OS10(config)# interface vlan 100
OS10(conf-if-vl-100)# no shutdown
OS10(conf-if-vl-100)# ip address 10.1.1.1/24
OS10(conf-if-vl-100)# ip helper-address 10.2.1.2
OS10(conf-if-vl-100)# exit
OS10(config)# interface vlan 200
OS10(conf-if-vl-200)# no shutdown
OS10(conf-if-vl-200)# ip address 10.2.1.1/24
OS10(conf-if-vl-200)# exit
OS10(config)# interface ethernet 1/1/2
OS10(conf-if-eth1/1/2)# no shutdown
OS10(conf-if-eth1/1/2)# switchport access vlan 200
OS10(conf-if-eth1/1/2)# ip dhcp snooping trust
OS10(conf-if-eth1/1/2)# exit
OS10(config)# interface ethernet 1/1/4
OS10(conf-if-eth1/1/4)# no shutdown
OS10(conf-if-eth1/1/4)# switchport access vlan 100
OS10(conf-if-eth1/1/4)# exit
OS10(config)# interface ethernet 1/1/3
OS10(conf-if-eth1/1/3)# no shutdown
OS10(conf-if-eth1/1/3)# switchport access vlan 100
OS10(conf-if-eth1/1/3)# end
```

## DHCP server

```
OS10# configure terminal
OS10(config)# ip dhcp server
OS10(config-dhcp)# no disable
OS10(config-dhcp)# pool dell_1
OS10(config-dhcp-dell_1)# network 10.1.1.0/24
OS10(config-dhcp-dell_1)# range 10.1.1.2 10.1.1.250
OS10(config-dhcp-dell_1)# exit
OS10(config-dhcp)# pool dell_2
OS10(config-dhcp-dell_2)# network 10.2.1.0/24
OS10(config-dhcp-dell_2)# exit
OS10(config-dhcp)# exit
OS10(config)# interface ethernet 1/1/1
OS10(conf-if-eth1/1/1)# no shutdown
OS10(conf-if-eth1/1/1)# no switchport
OS10(conf-if-eth1/1/1)# ip address 10.2.1.2/24
```

## DHCP client

```
OS10(config)# interface ethernet 1/1/4
OS10(conf-if-eth1/1/4)# no switchport
OS10(conf-if-eth1/1/4)# no ip address
OS10(conf-if-eth1/1/4)# ip address dhcp
OS10(conf-if-eth1/1/4)# end
```

## DHCP snooping in a Layer 2 VLT setup

In this layer 2 VLT setup, DHCP clients on the virtual machine are connected to SW1 and SW2 and acquire IP addresses from the DHCP server.

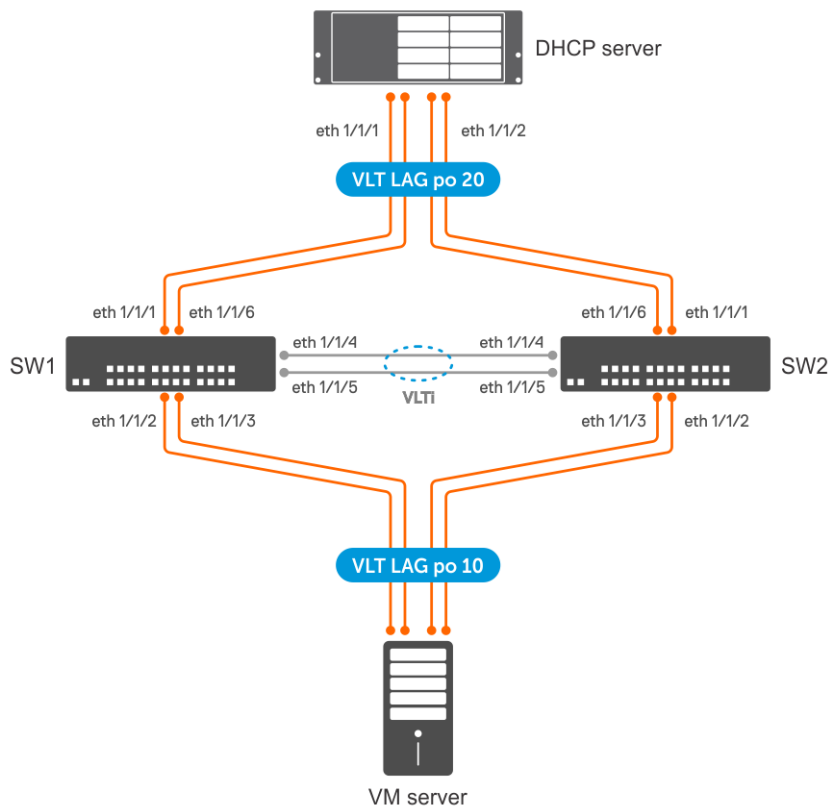

## SW 1

### DHCP snooping configuration



- Enable DHCP snooping globally.

```
OS10(config)# ip dhcp snooping
```

### VLAN configuration

- Create a VLAN.

```
OS10# configure terminal
OS10(config)# interface vlan 100
OS10(config-if-vl-100)# no shutdown
```

### VLT configuration

1. Create a VLT domain and configure VLTi.

```
OS10(config)# interface range ethernet 1/1/4-1/1/5
OS10(config-range-eth1/1/4-1/1/5)# no switchport
OS10(config-range-eth1/1/4-1/1/5)# exit
OS10(config)# vlt-domain 1
OS10(config-vlt-1)# discovery-interface ethernet 1/1/4-1/1/5
```

2. Configure a VLT MAC address.

```
OS10(config-vlt-1)# vlt-mac 12:5e:23:2d:76:3e
```

3. Specify the management IP address of the VLT peer as a backup link.

```
OS10(config-vlt-1)# backup destination 10.10.10.2
```

4. Configure VLT port channels.

#### VLT port channel to VM

```
OS10(config)# interface port-channel 10
OS10(config-if-po-10)# description SW1ToVM
OS10(config-if-po-10)# vlt-port-channel 10
OS10(config-if-po-10)# switchport mode access
OS10(config-if-po-10)# switchport access vlan 100
OS10(config-if-po-10)# exit
OS10(config)# interface ethernet 1/1/2-1/1/3
OS10(config-if-eth1/1/2-1/1/3)# no shutdown
OS10(config-if-eth1/1/2-1/1/3)# channel-group 10
```

#### VLT port channel to DHCP server

```
OS10(config)# interface port-channel 20
OS10(config-if-po-20)# description SW1ToDHCP-Server
OS10(config-if-po-20)# vlt-port-channel 20
OS10(config-if-po-20)# switchport mode access
OS10(config-if-po-20)# switchport access vlan 100
OS10(config-if-po-20)# ip dhcp snooping trust
OS10(config-if-po-20)# exit
OS10(config)# interface ethernet 1/1/1,1/1/6
OS10(config-if-eth1/1/1,1/1/6)# no shutdown
OS10(config-if-eth1/1/1,1/1/6)# channel-group 20
```

## SW 2

### DHCP snooping configuration

- Enable DHCP snooping globally.

```
OS10(config)# ip dhcp snooping
```

### VLAN configuration

- Create a VLAN.

```
OS10# configure terminal
OS10(config)# interface vlan 100
OS10(config-if-vl-100)# no shutdown
```

## VLT configuration

1. Create a VLT domain and configure VLTi.

```
OS10(config)# interface range ethernet 1/1/4-1/1/5
OS10(config-range-eth1/1/4-1/1/5)# no switchport
OS10(config-range-eth1/1/4-1/1/5)# exit
OS10(config)# vlt-domain 1
OS10(config-vlt-1)# discovery-interface ethernet 1/1/4-1/1/5
```

2. Configure a VLT MAC address.

```
OS10(config-vlt-1)# vlt-mac 12:5e:23:f4:23:54
```

3. Specify the management IP address of the VLT peer as a backup link.

```
OS10(config-vlt-1)# backup destination 10.10.10.1
```

4. Configure VLT port channels.

### VLT port channel to VM

```
OS10(config)# interface port-channel 10
OS10(config-if-po-10)# description SW2ToVM
OS10(config-if-po-10)# vlt-port-channel 10
OS10(config-if-po-10)# switchport mode access
OS10(config-if-po-10)# switchport access vlan 100
OS10(config-if-po-10)# exit
OS10(config)# interface ethernet 1/1/2-1/1/3
OS10(config-if-eth1/1/2-1/1/3)# no shutdown
OS10(config-if-eth1/1/2-1/1/3)# channel-group 10
```

### VLT port channel to DHCP server

```
OS10(config)# interface port-channel 20
OS10(config-if-po-20)# description SW2ToDHCP-Server
OS10(config-if-po-20)# vlt-port-channel 20
OS10(config-if-po-20)# switchport mode access
OS10(config-if-po-20)# switchport access vlan 100
OS10(config-if-po-20)# ip dhcp snooping trust
OS10(config-if-po-20)# exit
OS10(config)# interface ethernet 1/1/1,1/1/6
OS10(config-if-eth1/1/1,1/1/6)# no shutdown
OS10(config-if-eth1/1/1,1/1/6)# channel-group 20
```

## DHCP server

### DHCP server configuration

```
OS10(config)# interface vlan 100
OS10(config-if-vl-100)# ip address 10.1.1.1/24
OS10(config-if-vl-100)# exit
OS10(config)# ip dhcp server
OS10(config-dhcp)# no disable
OS10(config-dhcp)# pool dell_server1
OS10(config-dhcp-dell_server1)# lease 0 1 0
OS10(config-dhcp-dell_server1)# network 10.1.1.0/24
OS10(config-dhcp-dell_server1)# range 10.1.1.2 10.1.1.100
```

### Verify DHCP snooping on both VLT peers

The following output shows that the DHCP snooping switches (VLT peers) snooped DHCP messages. The interface column displays the local VLT port channel number.

```
OS10# show ip dhcp snooping binding

Number of entries : 1

Codes : S - Static D - Dynamic

IPv4 Address MAC Address Expires (Sec) Type Interface VLAN

10.1.1.2 14:18:77:0d:05:e9 3600 D port-channel10 vlan100
```

## DHCP snooping with DHCP relay agent in a VLT setup

In this VLT setup, DHCP clients on the virtual machine are connected to SW1 and SW2 and acquire IP addresses from the DHCP server. The VLAN of both the client and the DHCP server is in the default VRF on SW 1 and SW 2.

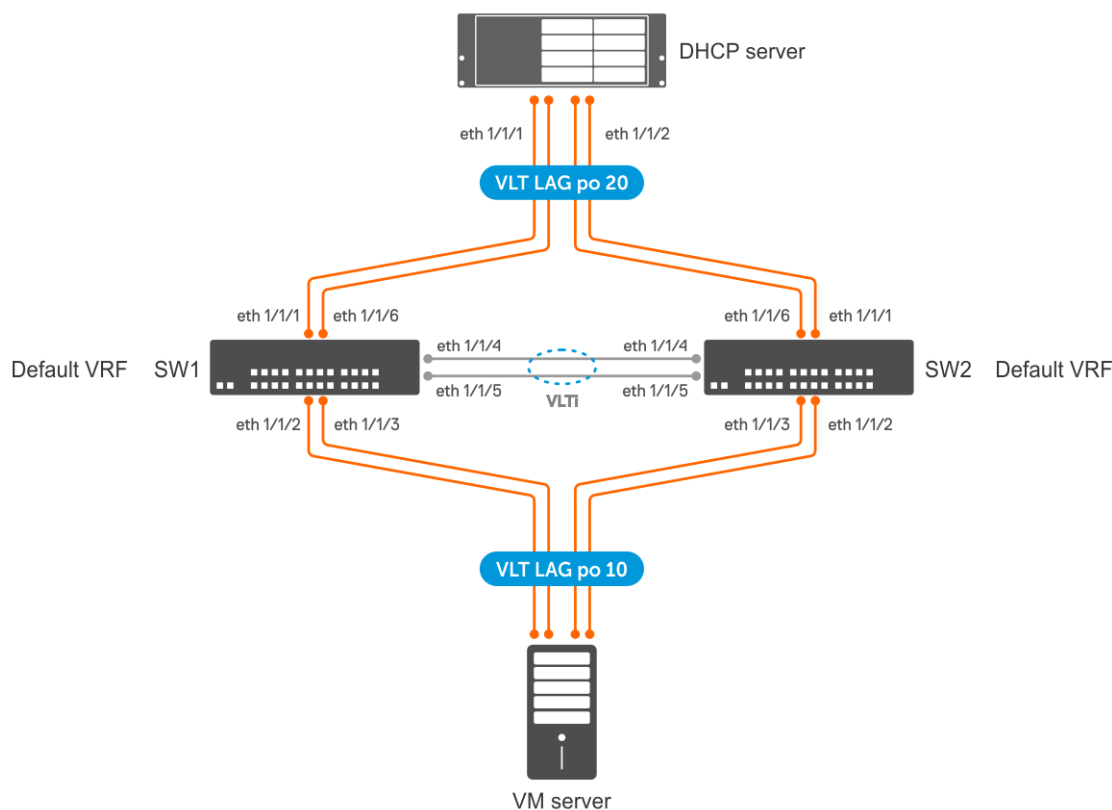

### SW 1

#### DHCP snooping configuration

- Enable DHCP snooping globally.

```
OS10(config)# ip dhcp snooping
```

#### VLAN configuration

- Create a VLAN and assign an IP address to it which acts as the gateway for the VMs.

```
OS10# configure terminal
OS10(config)# interface vlan 100
OS10(conf-if-vl-100)# no shutdown
OS10(conf-if-vl-100)# ip address 10.1.1.1/24
OS10(conf-if-vl-100)# exit
```

- Create another VLAN and assign an IP address to it which can communicate with the DHCP server.

```
OS10# configure terminal
OS10(config)# interface vlan 200
OS10(config-if-vl-200)# no shutdown
OS10(config-if-vl-200)# ip address 10.2.1.1/24
OS10(config-if-vl-200)# exit
```

- Configure SW 1 as the DHCP relay agent for the clients in the VM. The IP address that you specify here is the IP address of the DHCP server

```
OS10# configure terminal
OS10(config)# interface vlan 100
OS10(config-if-vl-100)# ip helper-address 10.2.1.2
```

## VLT configuration

1. Create a VLT domain and configure VLTi.

```
OS10(config)# interface range ethernet 1/1/4-1/1/5
OS10(config-range-eth1/1/4-1/1/5)# no switchport
OS10(config-range-eth1/1/4-1/1/5)# exit
OS10(config)# vlt-domain 1
OS10(config-vlt-1)# discovery-interface ethernet 1/1/4-1/1/5
```

2. Configure a VLT MAC address.

```
OS10(config-vlt-1)# vlt-mac 12:5e:23:2d:76:3e
```

3. Specify the management IP address of the VLT peer as a backup link.

```
OS10(config-vlt-1)# backup destination 10.10.10.2
```

4. Configure VLT port channels.

### SW1 to VM VLT port channel configuration

```
OS10(config)# interface port-channel 10
OS10(config-if-po-10)# description SW1ToVM
OS10(config-if-po-10)# vlt-port-channel 10
OS10(config-if-po-10)# switchport mode access
OS10(config-if-po-10)# switchport access vlan 100
OS10(config-if-po-10)# exit
OS10(config)# interface ethernet 1/1/2-1/1/3
OS10(config-if-eth1/1/2-1/1/3)# no shutdown
OS10(config-if-eth1/1/2-1/1/3)# channel-group 10
```

## SW 1 to DHCP server configuration

```
OS10(config)# interface port-channel 20
OS10(config-if-po-20)# description SW1ToDHCP-Server
OS10(config-if-po-20)# vlt-port-channel 20
OS10(config-if-po-20)# switchport mode trunk
OS10(config-if-po-20)# switchport trunk allowed vlan 100,200
OS10(config-if-po-20)# ip dhcp snooping trust
OS10(config-if-po-20)# exit
OS10(config)# interface ethernet 1/1/1,1/1/6
OS10(config-if-eth1/1/1,1/1/6)# no shutdown
OS10(config-if-eth1/1/1,1/1/6)# channel-group 20
```

### (Optional) Peer routing configuration

- Configure peer routing.

```
OS10(config)# vlt-domain 1
OS10(config-vlt-1)# peer-routing
```

## SW 2

### DHCP snooping configuration

- Enable DHCP snooping globally.

```
OS10(config)# ip dhcp snooping
```

### VLAN configuration

- Create a VLAN and assign an IP address to it which acts as the gateway for the VMs.

```
OS10# configure terminal
OS10(config)# interface vlan 100
OS10(conf-if-vl-100)# no shutdown
OS10(conf-if-vl-100)# ip address
OS10(conf-if-vl-100)# ip address 10.1.1.2/24
OS10(conf-if-vl-100)# exit
```

- Create another VLAN and assign an IP address to it which can communicate with the DHCP server.

```
OS10# configure terminal
OS10(config)# interface vlan 200
OS10(conf-if-vl-200)# no shutdown
OS10(conf-if-vl-200)# ip address
OS10(conf-if-vl-200)# ip address 10.2.1.3/24
OS10(conf-if-vl-200)# exit
```

- Configure SW 1 as the DHCP relay agent for the clients in the VM. The IP address that you specify here is the IP address of the DHCP server

```
OS10# configure terminal
OS10(config)# interface vlan 100
OS10(conf-if-vl-100)# ip helper-address 10.2.1.2
```

### VLT configuration

1. Create a VLT domain and configure VLTi.

```
OS10(config)# interface range ethernet 1/1/4-1/1/5
OS10(conf-range-eth1/1/4-1/1/5)# no switchport
OS10(conf-range-eth1/1/4-1/1/5)# exit
OS10(config)# vlt-domain 1
OS10(conf-vlt-1)# discovery-interface ethernet 1/1/4-1/1/5
```

2. Configure a VLT MAC address.

```
OS10(conf-vlt-1)# vlt-mac 12:5e:23:f4:23:54
```

3. Specify the management IP address of the VLT peer as a backup link.

```
OS10(conf-vlt-1)# backup destination 10.10.10.1
```

4. Configure VLT port channels.

#### SW2 to VM VLT port channel configuration

```
OS10(config)# interface port-channel 10
OS10(conf-if-po-10)# description SW2ToVM
OS10(conf-if-po-10)# vlt-port-channel 10
OS10(conf-if-po-10)# switchport mode access
OS10(conf-if-po-10)# switchport access vlan 100
OS10(conf-if-po-10)# exit
OS10(config)# interface ethernet 1/1/2-1/1/3
OS10(conf-if-eth1/1/2-1/1/3)# no shutdown
OS10(conf-if-eth1/1/2-1/1/3)# channel-group 10
```

#### SW 2 to DHCP server configuration

```
OS10(config)# interface port-channel 20
OS10(conf-if-po-20)# description SW2ToDHCP-Server
OS10(conf-if-po-20)# vlt-port-channel 20
OS10(conf-if-po-20)# switchport mode trunk
OS10(conf-if-po-20)# switchport trunk allowed vlan 100,200
OS10(conf-if-po-20)# ip dhcp snooping trust
OS10(conf-if-po-20)# exit
```

```
OS10(config)# interface ethernet 1/1/1,1/1/6
OS10(conf-if-eth1/1/1,1/1/6)# no shutdown
OS10(conf-if-eth1/1/1,1/1/6)# channel-group 20
```

### ( Optional) Peer routing configuration

- Configure peer routing.

```
OS10(config)# vlt-domain 1
OS10(conf-vlt-1)# peer-routing
```

### DHCP server

#### VLAN configuration

```
OS10(config)# interface vlan 100
OS10(conf-if-vl-100)# exit
OS10(config)# interface vlan 200
OS10(conf-if-vl-200)# ip address 10.2.1.2/24
OS10(conf-if-vl-200)# exit
OS10(config)# interface port-channel 20
OS10(conf-if-po-20)# switchport mode trunk
OS10(conf-if-po-20)# switchport trunk allowed vlan 100,200
```

#### DHCP server configuration

```
OS10(config)# ip dhcp server
OS10(config-dhcp)# no disable
OS10(config-dhcp)# pool dell_server1
OS10(config-dhcp-dell_server1)# network 10.1.1.0/24
OS10(config-dhcp-dell_server1)# range 10.1.1.3 10.1.1.250
OS10(config-dhcp-dell_server1)# lease 0 1 0
OS10(config-dhcp-dell_server1)# default-router 10.1.1.1
OS10(config-dhcp)# pool dell_2
OS10(config-dhcp-dell_2)# network 10.2.1.0/24
OS10(config-dhcp-dell_2)# range 10.2.1.4 10.2.1.100
OS10(config-dhcp-dell_2)# lease 0 1 0
```

#### Route to reach VLAN 100

```
OS10(config)#ip route 10.1.1.0/24 10.2.1.1
```

### Verify DHCP snooping on both VLT peers

The following output shows that the DHCP snooping switches (VLT peers) snooped DHCP messages.

```
OS10# show ip dhcp snooping binding
```

```
Number of entries : 1
```

```
Codes : S - Static D - Dynamic
```

| IPv4 Address | MAC Address       | Expires (Sec) | Type | Interface      | VLAN |
|--------------|-------------------|---------------|------|----------------|------|
| 10.1.1.3     | 14:18:77:0d:05:e9 | 3600          | D    | port-channel10 | 100  |

## Dynamic ARP inspection

Dynamic Address Resolution Protocol (ARP) Inspection (DAI) is a security feature that protects local area networks from man-in-the-middle ARP spoofing attacks.

When you enable DAI, the switch intercepts ARP packets on DAI-enabled VLANs. The switch then compares the source IP and source MAC addresses, VLAN, and the interface (physical or port channel) of the received packet with the DHCP snooping binding table. If the information in the packet does not match any entry in the DHCP snooping binding table, the switch drops the packet.

 **NOTE:** Dell EMC Networking recommends enabling DAI before enabling DHCP snooping on the system.

### DAI violation logging

You can configure the system to log DAI validation failures corresponding to ARP packets. DAI violations are logged at the console if it is enabled. DAI violation logging is disabled by default.

If you configure an interface as trusted, the switch interprets ARP packets that ingress the interface from hosts as legitimate packets. By default, all interfaces are in DAI untrusted state.

For DAI to work, enable the DHCP snooping feature on the switch. DAI is disabled by default.

### DAI statistics

The system maintains DAI statistics that contain the following details:

- Valid ARP requests
- Invalid ARP requests
- Valid ARP replies
- Invalid ARP replies

You can clear the DAI statistics using the `clear ip arp inspection statistics` command.

### DAI trusted interfaces

By default, all ports are untrusted and all packets go through the DAI validation process on all DAI-enabled VLANs. You can configure an interface to bypass ARP inspection by configuring the interface as trusted.

**NOTE:** Dell EMC Networking recommends configuring the `arp inspection-trust` command on the DHCP snooping trusted interfaces when DAI is enabled for a VLAN.

### Restrictions for Dynamic ARP Inspection

- Dynamic ARP Inspection with VxLAN bridges is not supported.
- Maximum number of recommended Dynamic ARP Inspection entries is 2000.

### Enable Dynamic ARP Inspection

- Enable DHCP snooping. For more information about configuring DHCP snooping, see [DHCP snooping](#).
- Enable Dynamic ARP Inspection on a VLAN in INTERFACE VLAN mode.

```
arp inspection
```

### Enable Dynamic ARP Inspection violation logging

- Use the following command in CONFIGURATION mode:

```
arp inspection violation logging
```

### Bypass Dynamic ARP Inspection on an interface

- Use the following command in INTERFACE mode:

```
arp inspection-trust
```

### Clear DAI statistics

- Clear DAI statistics in EXEC mode.

```
clear ip arp inspection statistics [vlan vlan-name]
```

### View DAI database

- View DAI database in EXEC mode

```
show ip arp inspection database [vlan vlan-name]
```

Use the `vlan` option to view DAI database for a specific VLAN.

### Example for viewing DAI database

```
OS10# show ip arp inspection database
Number of entries : 828
```

```
Address Hardware Address Interface VLAN

```

|           |                   |                 |          |
|-----------|-------------------|-----------------|----------|
| 10.2.1.1  | 00:40:50:00:00:00 | port-channel100 | vlan3001 |
| 10.1.1.13 | 00:2a:10:01:00:00 | port-channel100 | vlan3001 |
| 10.1.1.62 | 00:2a:10:01:00:01 | port-channel100 | vlan3001 |

### View DAI statistics

You can view valid and invalid ARP requests that the switch has received and replies that the switch has sent.

- Use the following command in EXEC mode:

```
show ip arp inspection statistics vlan vlan-name
```

#### Example for viewing DAI statistics

```
OS10# show ip arp inspection statistics
Dynamic ARP Inspection (DAI) Statistics

Valid ARP Requests : 0
Valid ARP Replies : 1000
Invalid ARP Requests : 1000
Invalid ARP Replies : 0
```

- **View DAI violation information**

```
show ip arp inspection logging
```

Example for viewing DAI violation information

```
OS10# show ip arp inspection logging
Total Number of Clients : 1
New Clients learnt in current Interval : 0
Invalid ARP packets in current interval :
0
Address Hw-Address Port VLAN First-detected-time Packet-
count

10.1.1.1 12:d3:43:a1:2e:23 ethernet1/1/1 10 00:23:14 2
```

## Source Address Validation

Source Address Validation (SAV) is a security feature that instructs switches to permit IP traffic only from clients present in the DHCP snooping binding table.

When you enable SAV, the switch compares the source IP and MAC addresses in the packet with the DHCP snooping binding table. If there is a match, the device forwards the packet. If there is no match, it drops the packet.

SAV is disabled by default.

**NOTE:** Dell EMC Networking recommends enabling SAV before enabling DHCP snooping on the system.

OS10 supports three types of Source Address Validation:

1. Source IP address validation
2. Source IP and MAC address validation
3. DHCP source MAC address validation

#### Source IP address validation

This feature filters IP traffic, based on the source IP address and permits traffic only from clients present in the DHCP snooping binding table. The switch compares the following in the packet to the DHCP snooping binding table:

- Source IP address
- The VLAN to which the client is connected
- The interface (physical or port channel) to which the client is connected

If there is a match, the switch forwards the packet.

#### Source IP and MAC address validation



This feature filters IP traffic, based on both source IP and source MAC addresses and permits traffic only from clients found in the DHCP snooping binding table. The switch compares the following in the packet to the DHCP snooping binding table:

- Source MAC address
- Source IP address
- The VLAN to which the client is connected
- The interface (physical or port channel) to which the client is connected

If there is a match, the switch forwards the packet.

#### DHCP source MAC address validation

The switch compares the source MAC address of the DHCP packet to the Client Hardware Address (CHADDR) field in the DHCP packet and drops the DHCP packet if there is a mismatch.

#### Restrictions for Source Address Validation

- As the SAV feature shares TCAM memory with user ACLs, the maximum number of SAV rules that the system can support depends on how much TCAM memory is allocated to user ACLs.

#### Enable source IP address validation

- Enable source IP address validation in INTERFACE mode.

```
ip dhcp snooping source-address-validation ip [vlan vlan-name]
```

Use the `vlan` option to optionally specify SAV for one or more VLANs. The range is from 1 to 4093. If you do not specify the `vlan` option, SAV is enabled on all VLANs of an interface.

#### Enable source IP and MAC address validation

- Enable source IP and MAC address validation in INTERFACE mode.

```
ip dhcp snooping source-address-validation ipmac [vlan vlan-name]
```

Use the `VLAN` option to optionally specify SAV for one or more VLANs. The range is from 1 to 4093. If you do not specify the `vlan` option, SAV is enabled on all VLANs of an interface.

#### Enable DHCP source MAC address validation

- Enable DHCP source MAC address validation in CONFIGURATION mode.

```
ip dhcp snooping verify mac-address
```

#### Configuration notes

All Dell EMC PowerSwitches except MX-Series, S4200-Series, S5200 Series, and Z9332F-ON:

Learning of source MAC address from received LLDP and LACP packets is disabled.

## System domain name and list

If you enter a partial domain, the system searches different domains to finish or fully qualify that partial domain. A fully qualified domain name (FQDN) is any name that terminates with a period or dot.

OS10 searches the host table first to resolve the partial domain. The host table contains both statically configured and dynamically learned host and IP addresses. If OS10 cannot resolve the domain, it tries the domain name assigned to the local system. If that does not resolve the partial domain, the system searches the list of domains configured.

You can configure the `ip domain-list` command up to five times to enter a list of possible domain names. The system searches the domain names in the order they were configured until a match is found or the list is exhausted.

1. Enter a domain name in CONFIGURATION mode with a maximum of 64 alphanumeric characters.

```
ip domain-name name
```

2. Add names to complete unqualified hostnames in CONFIGURATION mode.

```
ip domain-list name
```

You can configure a domain name and list corresponding to a non-default VRF instance.

1. Enter a domain name corresponding to a non-default VRF instance in the CONFIGURATION mode.

```
ip domain-name vrf vrf-name server-name
```

2. Add names to complete unqualified hostnames corresponding to a non-default VRF instance.

```
ip domain-list vrf vrf-name name
```

### Configure the local system domain name and list

```
OS10(config)# ip domain-name ntengg.com
OS10(config)# ip domain-list dns1
OS10(config)# ip domain-list dns2
OS10(config)# ip domain-list dns3
OS10(config)# ip domain-list dns4
OS10(config)# ip domain-list dns5
```

```
OS10(config)# ip domain-name vrf vrf-blue ntengg.com
OS10(config)# ip domain-list vrf vrf-blue dns1
OS10(config)# ip domain-list vrf vrf-blue dns2
OS10(config)# ip domain-list vrf-vrfblue dns3
OS10(config)# ip domain-list vrf vrf-blue dns4
OS10(config)# ip domain-list vrf vrf-blue dns5
```

### View local system domain name information

```
OS10# show running-configuration

! Version 10.2.9999E
! Last configuration change at Feb 20 04:50:33 2017
!
username admin password 6q9QBeYjZ$jfxzVqGhkxX3smxJSH9DDz7/30Jc6m5wjF8nnLD7/
VKx8SloIhp4NoGZsOI/UNwh8WVuxwfd9q4pWIgNs5BKH.
aaa authentication system:local
ip domain-name dell.com
ip domain-list f10.com
ip name-server 1.1.1.1 2::2
ip host dell-f10.com 10.10.10.10
snmp-server community public read-only
snmp-server contact http://www.dell.com/support/
snmp-server location United States
debug radius false
```

## DHCP commands

### DHCP relay commands

#### ip helper-address

Configures the DHCP server address.

**Syntax** `ip helper-address address [vrf vrf-name]`

- Parameters**
- *address* — Enter the IPv4 address to forward UDP broadcasts to the DHCP server in A.B.C.D format.
  - *vrf vrf-name* — (Optional) Enter *vrf* and then the name of the VRF through which the host address is reached.

**Default** Disabled

**Command Mode** INTERFACE

**Usage Information** The DHCP server is supported only on L3 interfaces. After you configure an IP helper address, the address forwards UDP broadcasts to the DHCP server. You can configure multiple helper addresses on an interface by repeating the same command for each DHCP server address. The `no` version of this command returns the value to the default. The client-facing and server-facing interfaces must be in the same VRF.

**Example (IPv4)**

```
OS10(config)# interface eth 1/1/22
OS10(conf-if-eth1/1/22)# ip helper-address 20.1.1.1 vrf blue
```

**Supported Releases** 10.2.0E or later

## ipv6 helper-address

Configures a DHCPv6 server address.

**Syntax** `ipv6 helper-address ipv6-address [vrf vrf-name]`

- Parameters**
- `vrf vrf-name` — (Optional) Enter the keyword `vrf` and then the name of the VRF through which the host address can be reached.
  - `ipv6-address` — Specify the DHCPv6 server address in the A::B format.

**Defaults** Disabled

**Command Mode** INTERFACE

**Usage Information** Use this command on interfaces to which DHCPv6 clients connect, to forward the packets between IPv6 clients and a DHCPv6 server. After you configure an IPv6 helper address, the address forwards UDP broadcasts from IPv6 clients to the DHCPv6 server. You can configure multiple helper addresses on an interface by repeating the same command for each DHCPv6 server address. The `no` version of this command deletes the IPv6 helper address.

**Example**

```
OS10(config)# interface ethernet 1/1/22
OS10(conf-if-eth1/1/22)# ipv6 helper-address 2001:db8:0:1:1:1:1:1 vrf blue
```

**Supported Releases** 10.4.1.0 or later

## ip dhcp-relay information-option

Configures the system to enable the remote-id string in Option 82.

**Syntax** `ip dhcp-relay information-option`

**Parameters** None.

**Default** Not configured

**Command Mode** CONFIGURATION, INTERFACE CONFIGURATION

**Usage Information** By default, option 82 is enabled globally. When option 82 is enabled globally, the relay agent adds the client information to the packet and sends it to the server. When option 82 is disabled globally, the client packets are sent to the server without option 82 information. When both global as well as interface level option 82 configurations are present, the configuration to disable option 82 takes precedence. The following table shows the option 82 status depending on the global and interface level configurations:

**Table 10. Option 82 status**

| Global Level | Interface Level | Option 82 status                          |
|--------------|-----------------|-------------------------------------------|
| Enable       | Enable          | Adds option 82 information to the packet. |

**Table 10. Option 82 status (continued)**

|         |         |                                                   |
|---------|---------|---------------------------------------------------|
| Enable  | Disable | Does not add option 82 information to the packet. |
| Disable | Enable  | Does not add option 82 information to the packet. |
| Disable | Disable | Does not add option 82 information to the packet. |

**Example**

```
OS10(config)# ip dhcp relay information-option trust-downstream
```

**Supported Releases**

10.2.0E or later

**show vlt mismatch**

Displays mismatches in a VLT domain configuration.

**Syntax**

```
show vlt id mismatch [dhcp-snooping | peer-routing | vlan | vlt-vlan vlt-port-id | relay]
```

**Parameters**

- *id* — Enter the VLT domain ID, from 1 to 255.
- *dhcp-snooping* — Display mismatches in a DHCP snooping configuration in a VLT domain.
- *peer-routing* — Display mismatches in the peer-routing configuration.
- *vlan* — Display mismatches in a VLAN configuration in the VLT domain.
- *vlt-vlan vlt-port-id* — Display mismatches in the VLT port configuration, from 1 to 4095.
- *virtual-network* — Display mismatches in virtual network configurations between VLT peers.
- *dhcp-relay* — Displays the mismatch (if any) between the VLT peers for DHCP relay options configuration across the VLT peers.

**Default**

Not configured

**Command Mode**

EXEC

**Usage Information**

The \* in the mismatch output indicates a local node entry.  
 The show vlt mismatch dhcp-relay command displays the mismatch in the global ip dhcp-relay information-option configuration.  
 The show vlt mismatch dhcp-relay command displays the presence or absence of interface level ip dhcp-relay information-option configuration.

**Example (no mismatch)**

```
OS10# show vlt 1 mismatch
Peer-routing mismatch:
No mismatch

VLAN mismatch:
No mismatch

VLT VLAN mismatch:
No mismatch
```

**Example (mismatch)**

```
OS10# show vlt 1 mismatch
Peer-routing mismatch:
VLT Unit ID Peer-routing

* 1 Enabled
 2 Disabled

VLAN mismatch:
No mismatch

VLT VLAN mismatch:
```

```

VLT ID : 1
VLT Unit ID Mismatch VLAN List

* 1 1
 2 2
VLT ID : 2
VLT Unit ID Mismatch VLAN List

* 1 1
 2 2

```

**Example  
(mismatch peer  
routing)**

```

OS10# show vlt 1 mismatch peer-routing
Peer-routing mismatch:
VLT Unit ID Peer-routing

* 1 Enabled
 2 Disabled

```

**Example  
(mismatch  
VLAN)**

```

OS10# show vlt 1 mismatch vlan
VLT Unit ID Mismatch VLAN List

* 1 -
 2 4

```

**Example  
(mismatch VLT  
VLAN)**

```

OS10# show vlt 1 mismatch vlt-vlan
VLT ID : 1
VLT Unit ID Mismatch VLAN List

* 1 1
 2 2
VLT ID : 2
VLT Unit ID Mismatch VLAN List

* 1 1
 2 2

```

**Example  
(mismatch —  
Virtual Network  
(VN) name not  
available in the  
peer)**

```

OS10# show vlt all mismatch virtual-network
Virtual Network Name Mismatch:
VLT Unit ID Mismatch Virtual Network List

 1 10,104
* 2 -

```

**Example  
(mismatch of  
VLTi and VLAN)**

```

OS10# show vlt all mismatch virtual-network
Virtual Network: 100
VLT Unit ID Configured VLTi-Vlans

 1 101
* 2 100

```

**Example  
(mismatch of VN  
mode)**

```

OS10# show vlt all mismatch virtual-network
Virtual Network: 102
VLT Unit ID Configured Virtual Network Mode

 1 PV
* 2 Attached

```

**Example  
(mismatch of  
port and VLAN  
list)**

```

OS10# show vlt all mismatch virtual-network
Virtual Network: 102
VLT Unit ID Mismatch (VLT Port,Vlan) List

```

```

1 -
* 2 (vlt-port-channel10,vlan99)

Virtual Network: 103
VLT Unit ID Mismatch (VLT Port,Vlan) List

1 (vlt-port-channel10,vlan103)
* 2 (vlt-port-channel10,vlan104)

```

**Example  
(mismatch of  
untagged  
interfaces)**

```

OS10# show vlt all mismatch virtual-network
Virtual Network: 104
VLT Unit ID Mismatch Untagged VLT Port-channel List

1 10
* 2 -

```

**Example  
(Anycast MAC  
address)**

```

show vlt 1 mismatch virtual-network

Interface virtual-network Anycast-mac mismatch:
VLT Unit ID Anycast-MAC

1 00:01:02:03:04:051
* 2 00:01:02:03:04:055

```

**Example  
(Anycast MAC  
address not  
available on one  
of the peers)**

```

show vlt 1 mismatch virtual-network

Interface virtual-network Anycast-mac mismatch:
VLT Unit ID Anycast-MAC

1 00:01:02:03:04:051
* 2 -

```

**Example (Virtual  
network  
interface anycast  
IP address)**

```

show vlt 1 mismatch virtual-network

Interface virtual-network Anycast-IP mismatch:

Virtual-network: 10

VLT Unit ID Anycast-IP

1 10.16.128.25
* 2 10.16.128.20

Virtual-network: 20

VLT Unit ID Anycast-IP

1 10.16.128.26
* 2 10.16.128.30

```

**Example  
(Anycast IP  
addresses not  
configured on  
one of the virtual  
networks on both  
peers)**

```

show vlt 1 mismatch virtual-network
Interface virtual-network Anycast-IP mismatch:

Virtual-network: 10

VLT Unit ID Anycast-IP

1 10.16.128.25
* 2 ABSENT

Virtual-network: 20

VLT Unit ID Anycast-IP

```

```

1 ABSENT
* 2 10.16.128.30

```

**Example (Virtual network mismatch and Anycast IP addresses mismatch)**

```

Interface virtual-network Anycast-IP mismatch:

Virtual-network: 10

VLT Unit ID Anycast-IP

 1 10.16.128.25
* 2 10.16.128.20

Virtual-network: 20

VLT Unit ID Anycast-IP

 1 10.16.128.26
* 2 ABSENT

Virtual-network: 30

VLT Unit ID Anycast-IP

 1 ABSENT
* 2 10.16.128.30

```

**Example (Displays multicast routing mismatches)**

```

OS10# show vlt mismatch
Multicast routing mismatches:

PIM spanned status

Vlan status V4 V6
VlanId Local Peer Local Peer
Vlan 5 Inactive Active Inactive Inactive
Vlan 25 Active Inactive Inactive Active

```

**Example (mismatch dhcp-relay)**

```

OS10# show vlt 1 mismatch dhcp-relay
DHCP Relay Mismatch:
Global Relay Configuration Mismatch

VLT Unit ID Option-82 Link-Selection Server-Override VSS

* 1 Enabled - - -
- 2 Disabled - -
Interface Relay Configuration Mismatch

Interface: virtual-network10000
VLT Unit ID Option-82 Server-Override VSS Source

* 1 Disabled - - -
- 2 Enabled - -
-
OS10#

```

**Supported Releases**

10.2.0E or later

## DHCP server commands

### default-router address

Assigns a default gateway to clients based on the IP address pool.

|                           |                                                                                                                                                                                                                                                                                                          |
|---------------------------|----------------------------------------------------------------------------------------------------------------------------------------------------------------------------------------------------------------------------------------------------------------------------------------------------------|
| <b>Syntax</b>             | <code>default-router address [address2...address8]</code>                                                                                                                                                                                                                                                |
| <b>Parameters</b>         | <ul style="list-style-type: none"><li>• <code>address</code> — Enter an IPv4 or IPv6 address to use as the default gateway for clients on the subnet in A.B.C.D or A:B format.</li><li>• <code>address2...address8</code> — (Optional) Enter up to eight IP addresses, in order of preference.</li></ul> |
| <b>Default</b>            | Not configured                                                                                                                                                                                                                                                                                           |
| <b>Command Mode</b>       | DHCP-POOL                                                                                                                                                                                                                                                                                                |
| <b>Usage Information</b>  | Configure up to eight IP addresses, in order of preference. Use the <code>no</code> version of this command to remove the configuration.                                                                                                                                                                 |
| <b>Example</b>            | <pre>OS10(conf-dhcp-pool2)# default-router 20.1.1.100</pre>                                                                                                                                                                                                                                              |
| <b>Supported Releases</b> | 10.2.0E or later                                                                                                                                                                                                                                                                                         |

### disable

Disables the DHCP server.

|                           |                                                                      |
|---------------------------|----------------------------------------------------------------------|
| <b>Syntax</b>             | <code>disable</code>                                                 |
| <b>Parameters</b>         | None                                                                 |
| <b>Default</b>            | Disabled                                                             |
| <b>Command Mode</b>       | DHCP                                                                 |
| <b>Usage Information</b>  | The <code>no</code> version of this command enables the DHCP server. |
| <b>Example</b>            | <pre>OS10(conf-dhcp)# no disable</pre>                               |
| <b>Supported Releases</b> | 10.2.0E or later                                                     |

### domain-name

Configures the name of the domain where the device is located.

|                           |                                                                                                                                                                |
|---------------------------|----------------------------------------------------------------------------------------------------------------------------------------------------------------|
| <b>Syntax</b>             | <code>domain-name domain-name</code>                                                                                                                           |
| <b>Parameters</b>         | <code>domain-name</code> — Enter the name of the domain with a maximum of 32 characters.                                                                       |
| <b>Default</b>            | Not configured                                                                                                                                                 |
| <b>Command Mode</b>       | DHCP-POOL                                                                                                                                                      |
| <b>Usage Information</b>  | This is the default domain name that appends to hostnames that are not fully qualified. The <code>no</code> version of this command removes the configuration. |
| <b>Example</b>            | <pre>OS10(conf-dhcp-Dell)# domain-name dell.com</pre>                                                                                                          |
| <b>Supported Releases</b> | 10.2.0E or later                                                                                                                                               |



## dns-server address

Assigns a DNS server to clients based on the address pool.

|                           |                                                                                                                                                                                                                                                                                                 |
|---------------------------|-------------------------------------------------------------------------------------------------------------------------------------------------------------------------------------------------------------------------------------------------------------------------------------------------|
| <b>Syntax</b>             | <code>dns-server address [address2...address8]</code>                                                                                                                                                                                                                                           |
| <b>Parameters</b>         | <ul style="list-style-type: none"><li>• <code>address</code> — Enter the DNS server IP address that services clients on the subnet in A.B.C.D or A::B format.</li><li>• <code>address2...address8</code> — (Optional) Enter up to eight DNS server addresses, in order of preference.</li></ul> |
| <b>Default</b>            | Not configured                                                                                                                                                                                                                                                                                  |
| <b>Command Mode</b>       | DHCP-POOL                                                                                                                                                                                                                                                                                       |
| <b>Usage Information</b>  | None                                                                                                                                                                                                                                                                                            |
| <b>Example</b>            | <pre>OS10(conf-dhcp-Dell)# dns-server 192.168.1.1</pre>                                                                                                                                                                                                                                         |
| <b>Supported Releases</b> | 10.2.0E or later                                                                                                                                                                                                                                                                                |

## hardware-address

Configures the client's hardware address for manual configurations.

|                           |                                                                                                       |
|---------------------------|-------------------------------------------------------------------------------------------------------|
| <b>Syntax</b>             | <code>hardware-address nn:nn:nn:nn:nn:nn</code>                                                       |
| <b>Parameters</b>         | <code>nn:nn:nn:nn:nn:nn</code> — Enter the 48-bit hardware address.                                   |
| <b>Default</b>            | Not configured                                                                                        |
| <b>Command Mode</b>       | DHCP-POOL                                                                                             |
| <b>Usage Information</b>  | The client hardware address is the MAC address of the client machine used for manual address binding. |
| <b>Example</b>            | <pre>OS10(conf-dhcp-static)# hardware-address 00:01:e8:8c:4d:0a</pre>                                 |
| <b>Supported Releases</b> | 10.2.0E or later                                                                                      |

## host

Assigns a host to a single IPv4 or IPv6 address pool for manual configurations.

|                           |                                                                                  |
|---------------------------|----------------------------------------------------------------------------------|
| <b>Syntax</b>             | <code>host A.B.C.D/A::B</code>                                                   |
| <b>Parameters</b>         | <code>A.B.C.D/A::B</code> — Enter the host IP address in A.B.C.D or A::B format. |
| <b>Default</b>            | Not configured                                                                   |
| <b>Command Mode</b>       | DHCP-POOL                                                                        |
| <b>Usage Information</b>  | The host address is the IP address that a client machine uses for DHCP.          |
| <b>Example</b>            | <pre>OS10(conf-dhcp-Dell)# host 20.1.1.100</pre>                                 |
| <b>Supported Releases</b> | 10.2.0E or later                                                                 |

## ip dhcp server

Enters DHCP configuration mode.

|                           |                                                                                                                                               |
|---------------------------|-----------------------------------------------------------------------------------------------------------------------------------------------|
| <b>Syntax</b>             | <code>ip dhcp server</code>                                                                                                                   |
| <b>Parameters</b>         | None                                                                                                                                          |
| <b>Default</b>            | Not configured                                                                                                                                |
| <b>Command Mode</b>       | CONFIGURATION                                                                                                                                 |
| <b>Usage Information</b>  | Use the <code>ip dhcp server</code> command to enter the DHCP mode required to enable DHCP server-assigned dynamic addresses on an interface. |
| <b>Example</b>            | <pre>OS10(config)# ip dhcp server OS10(config-dhcp)#</pre>                                                                                    |
| <b>Supported Releases</b> | 10.2.0E or later                                                                                                                              |

## lease

Configures a lease time for the IP addresses in a pool.

|                           |                                                                                                                                                                                                                                                                                                                                                                                  |
|---------------------------|----------------------------------------------------------------------------------------------------------------------------------------------------------------------------------------------------------------------------------------------------------------------------------------------------------------------------------------------------------------------------------|
| <b>Syntax</b>             | <code>lease {infinite   days [hours] [minutes]}</code>                                                                                                                                                                                                                                                                                                                           |
| <b>Parameters</b>         | <ul style="list-style-type: none"><li>• <code>infinite</code> — Enter the keyword to configure a lease that never expires.</li><li>• <code>days</code> — Enter the number of lease days, from 0 to 31.</li><li>• <code>hours</code> — Enter the number of lease hours, from 0 to 23.</li><li>• <code>minutes</code> — Enter the number of lease minutes, from 0 to 59.</li></ul> |
| <b>Default</b>            | 24 hours                                                                                                                                                                                                                                                                                                                                                                         |
| <b>Command Mode</b>       | DHCP-POOL                                                                                                                                                                                                                                                                                                                                                                        |
| <b>Usage Information</b>  | The <code>no</code> version of this command removes the lease configuration.                                                                                                                                                                                                                                                                                                     |
| <b>Example</b>            | <pre>OS10(config-dhcp-Dell)# lease 2 5 10</pre>                                                                                                                                                                                                                                                                                                                                  |
| <b>Example (Infinite)</b> | <pre>OS10(config-dhcp-Dell)# lease infinite</pre>                                                                                                                                                                                                                                                                                                                                |
| <b>Supported Releases</b> | 10.2.0E or later                                                                                                                                                                                                                                                                                                                                                                 |

## netbios-name-server address

Configures a NetBIOS WINS server that is available to DHCP clients.

|                          |                                                                                                                                                                                        |
|--------------------------|----------------------------------------------------------------------------------------------------------------------------------------------------------------------------------------|
| <b>Syntax</b>            | <code>netbios-name-server ip-address [address2...address8]</code>                                                                                                                      |
| <b>Parameters</b>        | <p><code>ip-address</code> — Enter the address of the NetBIOS WINS server.</p> <p><code>address2...address8</code> — (Optional) Enter additional server addresses.</p>                 |
| <b>Default</b>           | Not configured                                                                                                                                                                         |
| <b>Command Mode</b>      | DHCP-POOL                                                                                                                                                                              |
| <b>Usage Information</b> | Configure up to eight NetBIOS WINS servers available to a Microsoft DHCP client, in order of preference. The <code>no</code> version of this command returns the value to the default. |

**Example**

```
OS10 (conf-dhcp-Dell) # netbios-name-server 192.168.10.5
```

**Supported Releases**

10.2.0E or later

## netbios-node-type

Configures the NetBIOS node type for the DHCP client.

**Syntax** `netbios-node-type type`

**Parameters** `type` — Enter the NetBIOS node type:

- Broadcast — Enter b-node.
- Hybrid — Enter h-node.
- Mixed — Enter m-node.
- Peer-to-peer — Enter p-node.

**Default** Hybrid

**Command Mode** DHCP-POOL

**Usage Information** The no version of this command resets the value to the default.

**Example**

```
OS10 (conf-dhcp-Dell) # netbios-node-type h-node
```

**Supported Releases**

10.2.0E or later

## network

Configures a range of IPv4 or IPv6 addresses in the address pool.

**Syntax** `network address/mask`

**Parameters** `address/mask` — Enter a range of IP addresses and subnet mask in A.B.C.D/x or A::B/x format.

**Default** Not configured

**Command Mode** DHCP-POOL

**Usage Information** Use the `network` command to configure the IPv4 or IPv6 subnet address from which the DHCP server may assign addresses. For IPv4 address, the prefix length (`mask`) is 17 to 30 bits.

**Example**

```
OS10 (config-dhcp-Dell) # network 20.1.1.1/24
```

**Supported Releases**

10.2.0E or later

## pool

Configures an IP address pool name.

**Syntax** `pool pool-name`

**Parameters** `pool-name` — Enter the DHCP server pool name.

**Default** Not configured

**Command Mode** CONFIGURATION

**Usage Information** Use the `pool` command to name the pool of available IP addresses used by a DHCP server to assign an IP address to a client and enter DHCP POOL mode. In this mode, use the `network` command to configure the IPv4 or IPv6 subnet from which the DHCP server assigns addresses.

**Example**

```
OS10(config-dhcp)# pool Dell
OS10(config-dhcp-Dell)#
```

**Supported Releases** 10.2.0E or later

## range

Configures a range of IP addresses.

**Syntax** `range {ip-address1 [ip-address2]}`

**Parameters**

- `ip-address1` — First IP address of the IP address range.
- `ip-address2` — Last IP address of the IP address range.

**Default** Not configured

**Command Mode** DHCP-POOL

**Usage Information** Use the `range` command to configure a range of IP addresses that the OS10 switch, acting as the DHCP server, can assign to DHCP clients. The `no` version of this command requires only the first IP address to remove the range configuration.

**Example**

```
OS10(config)# OS10(config)# ip dhcp server
OS10(config-dhcp)# pool pool1
OS10(config-dhcp-pool1)# network 192.168.10.0/24
OS10(config-dhcp-pool1)# range 192.168.10.2 192.168.10.8
```

**Supported Releases** 10.4.1 or later

## show ip dhcp binding

Displays the DHCP binding table with IPv4 addresses.

**Syntax** `show ip dhcp binding`

**Parameters** None

**Default** Not configured

**Command Mode** EXEC

**Usage Information** After configuring a static IP-to-MAC address mapping with the `host` and `hardware-address` commands in DHCP POOL mode, use this command to verify the single manual binding for a host in the DHCP binding table.

**Example**

```
OS10# show ip dhcp binding
 IP Address Hardware address Lease expiration Hostname
+-----+-----+-----+-----+
11.1.1.254 00:00:12:12:12:12 Jan 27 2016 06:23:45

Total Number of Entries in the Table = 1
```

**Supported Releases** 10.2.0E or later

## DHCP snooping commands

### arp inspection

Enables Dynamic ARP Inspection (DAI) on a VLAN.

|                           |                                                                            |
|---------------------------|----------------------------------------------------------------------------|
| <b>Syntax</b>             | <code>arp inspection</code>                                                |
| <b>Parameters</b>         | None                                                                       |
| <b>Defaults</b>           | Disabled                                                                   |
| <b>Command Mode</b>       | INTERFACE VLAN                                                             |
| <b>Usage Information</b>  | Dell EMC Networking recommends enabling DAI before enabling DHCP snooping. |
| <b>Example</b>            | <pre>OS10(conf-if-vl-230)# arp inspection</pre>                            |
| <b>Supported Releases</b> | 10.5.0 or later                                                            |

### arp inspection-trust

Configures a port as trusted so that ARP frames are not validated against the DAI database.

|                          |                                                                                                                                                                                                                                                                                                                                                                      |
|--------------------------|----------------------------------------------------------------------------------------------------------------------------------------------------------------------------------------------------------------------------------------------------------------------------------------------------------------------------------------------------------------------|
| <b>Syntax</b>            | <code>arp inspection-trust</code>                                                                                                                                                                                                                                                                                                                                    |
| <b>Parameters</b>        | None                                                                                                                                                                                                                                                                                                                                                                 |
| <b>Defaults</b>          | All interfaces are untrusted                                                                                                                                                                                                                                                                                                                                         |
| <b>Command Mode</b>      | INTERFACE                                                                                                                                                                                                                                                                                                                                                            |
| <b>Usage Information</b> |  <b>NOTE:</b> Dell EMC Networking recommends configuring the <code>arp inspection-trust</code> command on the DHCP snooping trusted interfaces when DAI is enabled for a VLAN.<br>This command is accessible to users with <code>sysadmin</code> and <code>secadmin</code> roles. |
| <b>Example</b>           | <pre>OS10(conf-if-eth1/1/33)# arp inspection-trust</pre>                                                                                                                                                                                                                                                                                                             |
| <b>Supported Release</b> | 10.5.0 or later                                                                                                                                                                                                                                                                                                                                                      |

### arp inspection violation logging

Enables Dynamic ARP Inspection (DAI) on a VLAN.

|                           |                                                                                                                                                                       |
|---------------------------|-----------------------------------------------------------------------------------------------------------------------------------------------------------------------|
| <b>Syntax</b>             | <code>arp inspection violation logging</code>                                                                                                                         |
| <b>Parameters</b>         | <ul style="list-style-type: none"><li><code>violation logging</code>—Enter <code>violation logging</code> to enable DAI violation logging.</li></ul>                  |
| <b>Defaults</b>           | Disabled                                                                                                                                                              |
| <b>Command Mode</b>       | CONFIGURATION                                                                                                                                                         |
| <b>Usage Information</b>  | When you enable the <code>violation logging</code> option, each violated ARP request is logged with the source IP address, source MAC address, and interface details. |
| <b>Example</b>            | <pre>OS10(config)# arp inspection violation logging</pre>                                                                                                             |
| <b>Supported Releases</b> | 10.5.0 or later                                                                                                                                                       |

## clear ip arp inspection statistics

Clear the Dynamic ARP Inspection statistics.

|                          |                                                                                                                                    |
|--------------------------|------------------------------------------------------------------------------------------------------------------------------------|
| <b>Syntax</b>            | <code>clear ip arp inspection statistics [vlan <b>vlan-id</b>]</code>                                                              |
| <b>Parameters</b>        | <ul style="list-style-type: none"><li>• <code>vlan <b>vlan-id</b></code>—Enter the VLAN ID. The range is from 1 to 4093.</li></ul> |
| <b>Defaults</b>          | None                                                                                                                               |
| <b>Command Mode</b>      | EXEC                                                                                                                               |
| <b>Usage Information</b> | This command is accessible to users with <code>sysadmin</code> and <code>secadmin</code> roles.                                    |
| <b>Example (Global)</b>  | <pre>OS10# clear ip dhcp snooping binding</pre>                                                                                    |
| <b>Supported Release</b> | 10.5.0 or later or later                                                                                                           |

## clear ip dhcp snooping binding

Clears the dynamic entries in the DHCP snooping binding table.

|                               |                                                                                                                                                                                                                                                                                                                                                                                                                                           |
|-------------------------------|-------------------------------------------------------------------------------------------------------------------------------------------------------------------------------------------------------------------------------------------------------------------------------------------------------------------------------------------------------------------------------------------------------------------------------------------|
| <b>Syntax</b>                 | <code>clear ip dhcp snooping binding [mac <b>mac-address</b>] [vlan <b>vlan-id</b>] [interface {ethernet<code>slot/port/sub-port</code>&gt;   port-channel <b>port-channel-id</b>}]</code>                                                                                                                                                                                                                                                |
| <b>Parameters</b>             | <ul style="list-style-type: none"><li>• <code>mac <b>mac-address</b></code>—Enter the MAC address of the host to which the server is leasing the IP address.</li><li>• <code>vlan <b>vlan-id</b></code>—Enter the VLAN ID. The range is from 1 to 4093.</li><li>• <code>interface <i>type</i></code>—Enter the interface type information. You can enter a physical, a VLAN, or a port-channel interface.</li></ul>                       |
| <b>Defaults</b>               | None                                                                                                                                                                                                                                                                                                                                                                                                                                      |
| <b>Command Mode</b>           | EXEC                                                                                                                                                                                                                                                                                                                                                                                                                                      |
| <b>Usage Information</b>      | This command clears the dynamic entries in the DHCP snooping binding table.<br> <b>CAUTION: Clearing the DHCP snooping binding table using the <code>clear ip dhcp snooping binding</code> command also clears the SAV and DAI entries on the system. This affects the traffic from clients that are connected to the DHCP snooping-enabled VLANs.</b> |
| <b>Example (Global)</b>       | <pre>OS10# clear ip dhcp snooping binding</pre>                                                                                                                                                                                                                                                                                                                                                                                           |
| <b>Example (MAC)</b>          | <pre>OS10# clear ip dhcp snooping binding mac 04:56:79:86:73:fe</pre>                                                                                                                                                                                                                                                                                                                                                                     |
| <b>Example (Port Channel)</b> | <pre>OS10# clear ip dhcp snooping binding mac 04:56:79:86:73:fe vlan 100 port-channel 10</pre>                                                                                                                                                                                                                                                                                                                                            |
| <b>Supported Release</b>      | 10.5.0 or later or later                                                                                                                                                                                                                                                                                                                                                                                                                  |

## ip dhcp snooping (global)

Enables DHCP snooping globally.

|                   |                               |
|-------------------|-------------------------------|
| <b>Syntax</b>     | <code>ip dhcp snooping</code> |
| <b>Parameters</b> | None                          |
| <b>Defaults</b>   | Disabled                      |

|                           |                                                                                                                                                                                                                                                                                                                                                                                                                                                                                                                                                               |
|---------------------------|---------------------------------------------------------------------------------------------------------------------------------------------------------------------------------------------------------------------------------------------------------------------------------------------------------------------------------------------------------------------------------------------------------------------------------------------------------------------------------------------------------------------------------------------------------------|
| <b>Command Mode</b>       | CONFIGURATION                                                                                                                                                                                                                                                                                                                                                                                                                                                                                                                                                 |
| <b>Usage Information</b>  | <p>When you enable this feature, the switch begins to monitor all transactions between DHCP servers and DHCP clients and use the information to build the DHCP snooping binding table.</p> <p>If you disable DHCP snooping, the system removes the DHCP snooping binding table. Source Address Validation and Dynamic ARP Inspection entries are also removed.</p> <p>This command is accessible to users with <code>sysadmin</code> and <code>secadmin</code> roles.</p> <p>The <code>no</code> version of this command disables DHCP snooping globally.</p> |
| <b>Example</b>            | <pre>OS10(config)# ip dhcp snooping</pre>                                                                                                                                                                                                                                                                                                                                                                                                                                                                                                                     |
| <b>Supported Releases</b> | 10.5.0 or later or later                                                                                                                                                                                                                                                                                                                                                                                                                                                                                                                                      |

## ip dhcp snooping (interface)

Enables DHCP snooping on a VLAN.

|                           |                                                                                                                                                                                                                                                                                                                                                                                                                                                                                                                                                                                                                                                                                                                                                                                                                                             |
|---------------------------|---------------------------------------------------------------------------------------------------------------------------------------------------------------------------------------------------------------------------------------------------------------------------------------------------------------------------------------------------------------------------------------------------------------------------------------------------------------------------------------------------------------------------------------------------------------------------------------------------------------------------------------------------------------------------------------------------------------------------------------------------------------------------------------------------------------------------------------------|
| <b>Syntax</b>             | <code>ip dhcp snooping</code>                                                                                                                                                                                                                                                                                                                                                                                                                                                                                                                                                                                                                                                                                                                                                                                                               |
| <b>Parameters</b>         | None                                                                                                                                                                                                                                                                                                                                                                                                                                                                                                                                                                                                                                                                                                                                                                                                                                        |
| <b>Defaults</b>           | Enabled if enabled globally                                                                                                                                                                                                                                                                                                                                                                                                                                                                                                                                                                                                                                                                                                                                                                                                                 |
| <b>Command Mode</b>       | INTERFACE VLAN                                                                                                                                                                                                                                                                                                                                                                                                                                                                                                                                                                                                                                                                                                                                                                                                                              |
| <b>Usage Information</b>  | <p>When you enable this feature, the switch begins to monitor all transactions between DHCP servers and DHCP clients and use the information to build the DHCP snooping binding table.</p> <p>The system snoops packets from DHCP clients on the DHCP snooping-enabled VLAN and forwards the packets to all physical and port-channel interfaces of the VLAN.</p> <p>The system processes DHCP server packets that are received through trusted physical interfaces and port-channel interfaces and forwards the packets to all VLAN member interfaces.</p> <p>You can enable DHCP snooping globally and disable it on an interface.</p> <p>This command is accessible to users with <code>sysadmin</code> and <code>secadmin</code> roles.</p> <p>The <code>no</code> version of this command disables DHCP snooping on the interface.</p> |
| <b>Example</b>            | <pre>OS10(conf-if-vl-4)# ip dhcp snooping</pre>                                                                                                                                                                                                                                                                                                                                                                                                                                                                                                                                                                                                                                                                                                                                                                                             |
| <b>Supported Releases</b> | 10.5.0 or later or later                                                                                                                                                                                                                                                                                                                                                                                                                                                                                                                                                                                                                                                                                                                                                                                                                    |

## ip dhcp snooping binding

Create a static DHCP snooping binding entry in the DHCP binding table.

|                          |                                                                                                                                                                                                                                                                                                                                                                                                                                                   |
|--------------------------|---------------------------------------------------------------------------------------------------------------------------------------------------------------------------------------------------------------------------------------------------------------------------------------------------------------------------------------------------------------------------------------------------------------------------------------------------|
| <b>Syntax</b>            | <code>ip dhcp snooping binding mac address vlan vlan-id ip ip-address interface [ethernet slot/port/sub-port   port-channel port-channel-id   VLTi]</code>                                                                                                                                                                                                                                                                                        |
| <b>Parameters</b>        | <ul style="list-style-type: none"> <li>• <code>mac address</code>—Enter the MAC address of the host to which the server is leasing the IP address.</li> <li>• <code>vlan vlan-id</code>—Enter the VLAN ID of the VLAN the host belongs to. The range is from 1 to 4093.</li> <li>• <code>ip ip-address</code>—Enter the IP address of the host.</li> <li>• <code>interface interface-type</code>—Enter the interface type information.</li> </ul> |
| <b>Defaults</b>          | None                                                                                                                                                                                                                                                                                                                                                                                                                                              |
| <b>Command Mode</b>      | CONFIGURATION                                                                                                                                                                                                                                                                                                                                                                                                                                     |
| <b>Usage Information</b> | When you create a static DHCP snooping entry, it does not time out.                                                                                                                                                                                                                                                                                                                                                                               |

Before creating a static entry for a VLAN, create the VLAN. If you do not create a VLAN before creating a static entry, the system displays an error message.

Before deleting a port-channel or VLAN, remove any associated DHCP snooping entries.

This command is accessible to users with `sysadmin` and `secadmin` roles.

The `no` version of this command deletes the static entry from the DHCP snooping binding table.

### Example

```
OS10(config)# ip dhcp snooping binding mac 00:04:96:70:8a:12 vlan 100 ip
100.1.1.2 interface ethernet 1/1/4
```

**Supported Releases** 10.5.0 or later

## ip dhcp snooping trust

Configures an interface as trusted in a DHCP snooping enabled VLAN.

**Syntax** `ip dhcp snooping trust`

**Parameters** None

**Defaults** Untrusted

**Command Mode** INTERFACE

**Usage Information** This command configures a physical or port channel interface as trusted. By default all physical and port channel interfaces in the DHCP snooping enabled VLAN are untrusted. You can configure a DHCP server-facing physical or port channel interface as trusted. The system permits DHCP server packets only if they ingress through a trusted interface. If the system receives DHCP packets on an untrusted interface, it interprets the device that is connected to the untrusted interface as rogue DHCP server and drops the packet.

The `no` version of this command resets the interface to untrusted.

### Example

```
OS10(conf-if-eth1/1/33)# ip dhcp snooping trust
```

**Supported Releases** 10.5.0 or later

## ip dhcp snooping verify mac-address

Enables DHCPv4 source MAC address validation

**Syntax** `ip dhcp snooping verify mac-address`

**Parameters** None

**Defaults** Disabled

**Command Mode** CONFIGURATION

**Usage Information** This command enables DHCPv4 source MAC address validation to validate the source hardware address of a DHCP packet against the client hardware address field (CHADDR) in the DHCP payload.

### Example

```
OS10(config)# ip dhcp snooping verify mac-address
```

**Supported Releases** 10.5.0 or later



## show ip arp inspection database

Displays the contents of the DAI database.

**Syntax** show ip arp inspection database

**Parameters** None

**Defaults** None

**Command Mode** EXEC

**Usage Information** This command displays the list of snooped hosts from which ARP packets were processed.

### Example

```
OS10# show ip arp inspection database
Number of entries : 3

Address Hardware Address Interface VLAN

55.2.1.1 00:40:50:00:00:00 port-channel100 vlan3001
200.1.1.134 00:2a:10:01:00:00 port-channel100 vlan3001
200.1.1.62 00:2a:10:01:00:01 port-channel100 vlan3001
```

**Supported Releases** 10.5.0 or later

## show ip arp inspection statistics

Displays valid and invalid ARP requests and reply statistics.

**Syntax** show ip arp inspection statistics [vlan **vlan-id**]

**Parameters** • vlan **vlan-id**—Enter the VLAN ID. The range is from 1 to 4093.

**Defaults** None

**Command Mode** EXEC

**Usage Information** This command displays how many valid and invalid ARP requests and replies are processed.

### Example

```
OS10# show ip arp inspection statistics
Dynamic ARP Inspection (DAI) Statistics

Valid ARP Requests : 1118
Valid ARP Replies : 18649
Invalid ARP Requests : 577
Invalid ARP Replies : 470
```

**Supported Releases** 10.5.0 or later

## show ip arp inspection logging

Displays violated ARP packet information about DAI-enabled VLANs.

**Syntax** show ip arp inspection logging

**Defaults** None

**Command Mode** EXEC

### Example

```
OS10# show ip arp inspection logging
Total Number of Clients : 1
New Clients learnt in current Interval : 0
```

```

Invalid ARP packets in current interval :
0
Address Hw-Address Port VLAN First-detected-time Packet-
count

10.1.1.1 12:d3:43:a1:2e:23 ethernet1/1/1 10 00:23:14 2

```

**Supported Releases** 10.5.0 or later

## show ip dhcp snooping binding

Displays the contents of the DHCP snooping binding table.

**Syntax** `show ip dhcp snooping binding [vlan vlan-id]`

**Parameters**

- `vlan vlan-id`—Enter the VLAN ID. The range is from 1 to 4093.

**Defaults** None

**Command Mode** EXEC

**Usage Information** The dynamically learned entries are displayed as D and statically configured entries are displayed as S.

### Example

```

OS10# show ip dhcp snooping binding
Codes : S - Static D - Dynamic
IPv4 Address MAC Address Expires (Sec) Type Interface VLAN
=====
10.1.1.22 11:22:11:22:11:22 120331 S ethernet1/1/4 100
10.1.1.44 11:22:11:22:11:23 120331 S port-channel100 200
10.1.1.5 11:22:11:22:11:24 120331 D ethernet1/1/5:4 300

```

**Supported Releases** 10.5.0 or later

## DNS commands

OS10 supports the configuration of a DNS host and domain parameters.

### ip domain-list

Adds a domain name to the DNS list.

**Syntax** `ip domain-list [vrf vrf-name] [server-name] name`

**Parameters**

- `vrf vrf-name` — (Optional) Enter `vrf` and then the name of the VRF to add a domain name to the DNS list corresponding to that VRF.
- `server-name` — (Optional) Enter the server name to add a domain name to the DNS list.
- `name` — Enter the name of the domain to append to the DNS list.

**Default** Not configured

**Command Mode** CONFIGURATION

**Usage Information** There is a maximum of six domain names in the DNS list. Use the `ip domain-list` command to configure a domain name to complete unqualified hostnames. The domain name appends to incomplete host names in DNS requests. The `no` version of this command removes a domain name from the DNS list.

**Example**

```
OS10(config)# ip domain-list jay dell.com
```

**Supported Releases**

10.2.0E or later

## ip domain-name

Configures the default domain and appends to incomplete DNS requests.

**Syntax**

```
ip domain-name [vrf vrf-name] server-name
```

**Parameters**

- *vrf vrf-name* — (Optional) Enter *vrf* and then the name of the VRF to configure the domain corresponding to that VRF.
- *server-name* — (Optional) Enter the server name the default domain uses.

**Default**

Not configured

**Command Mode**

CONFIGURATION

**Usage Information**

This domain appends to incomplete DNS requests. The `no` version of this command returns the value to the default.

**Example**

```
OS10(config)# ip domain-name vrf jay dell.com
```

**Supported Releases**

10.2.0E or later

## ip host

Configures mapping between the hostname server and the IP address.

**Syntax**

```
ip host [vrf vrf-name] [host-name] address
```

**Parameters**

- *vrf vrf-name* — (Optional) Enter *vrf* and then the name of the VRF to configure the name server to IP address mapping for that VRF.
- *host-name* — (Optional) Enter the name of the host.
- *address* — Enter an IPv4 or IPv6 address of the name server in A.B.C.D or A::B format.

**Default**

Not configured

**Command Mode**

CONFIGURATION

**Usage Information**

The name-to-IP address table uses this mapping information to resolve host names. The `no` version of this command disables the mapping.

**Example**

```
OS10(config)# ip host dell 1.1.1.1
```

**Supported Releases**

10.2.0E or later

## ip name-server

Configures up to three IPv4 or IPv6 addresses used for network name servers.

**Syntax**

```
ip name-server ip-address [ip-address2 ip-address3]
```

**Parameters**

- *ip-address* — Enter the IPv4 or IPv6 address of a domain name server to use for completing unqualified names, such as incomplete domain names that cannot be resolved.
- *ip-address2 ip-address3* — (Optional) Enter up to two additional IPv4 or IPv6 name servers, separated with a space.

|                           |                                                                                                                                                                                                                                                                                                                                                                                                                                                                           |
|---------------------------|---------------------------------------------------------------------------------------------------------------------------------------------------------------------------------------------------------------------------------------------------------------------------------------------------------------------------------------------------------------------------------------------------------------------------------------------------------------------------|
| <b>Default</b>            | Not configured                                                                                                                                                                                                                                                                                                                                                                                                                                                            |
| <b>Command Mode</b>       | CONFIGURATION                                                                                                                                                                                                                                                                                                                                                                                                                                                             |
| <b>Usage Information</b>  | OS10 does not support sending DNS queries over a VLAN. DNS queries are sent out on all other interfaces, including the Management port. You can separately configure both IPv4 and IPv6 domain name servers. In a dual stack setup, the system sends both A (request for IPv4) and AAAA (request for IPv6) record requests to a DNS server even if you only configure this command. The <code>no</code> version of this command removes the IP name-server configuration. |
| <b>Example</b>            | <pre>OS10(config)# ip name-server 10.1.1.5</pre>                                                                                                                                                                                                                                                                                                                                                                                                                          |
| <b>Supported Releases</b> | 10.2.0E or later                                                                                                                                                                                                                                                                                                                                                                                                                                                          |

## show hosts

Displays the host table and DNS configuration.

|                           |                                                                                                                                                                                                                                                                                       |
|---------------------------|---------------------------------------------------------------------------------------------------------------------------------------------------------------------------------------------------------------------------------------------------------------------------------------|
| <b>Syntax</b>             | <code>show hosts [vrf vrf-name]</code>                                                                                                                                                                                                                                                |
| <b>Parameters</b>         | <code>vrf vrf-name</code> — Enter <code>vrf</code> then the name of the VRF to display DNS host information corresponding to that VRF.                                                                                                                                                |
| <b>Default</b>            | Not configured                                                                                                                                                                                                                                                                        |
| <b>Command Mode</b>       | EXEC                                                                                                                                                                                                                                                                                  |
| <b>Usage Information</b>  | None                                                                                                                                                                                                                                                                                  |
| <b>Example</b>            | <pre>OS10# show hosts Default Domain Name : dell.com Domain List : abc.com Name Servers : 1.1.1.1 20::2 =====                 Static Host to IP mapping Table ===== Host                                     IP-Address ----- dell-pc1                                 20.1.1.1</pre> |
| <b>Supported Releases</b> | 10.2.0E or later                                                                                                                                                                                                                                                                      |

## Containers

Docker-CE allows you to download and install external packages and run them within OS10.

When you start a container, use the `--net=` option to connect it to a network. This network can access the Management and front-end interfaces. If you do not want networking for your Docker containers, use `none`.

If you are in the `sysadmin` group, you can run Docker commands from the OS10 Linux Shell.

### Docker-CE restrictions

- Docker-CE is supported on platforms with at least 16 GB of flash memory.
- Docker-CE is disabled by default on the system.
- By default, the dockers that you create have no visibility to the Layer 2 traffic arriving on the data ports.
- Dell EMC Networking recommends creating containers only with the network type as **host** or **none**.
- Do not create bridge networks using the `docker network create` command as this configuration can conflict with the OS10 networking capability.
- Interfaces that are part of nondefault VRFs are not available for Docker-CE containers.
- Do not use multiple containers simultaneously as this may affect system performance.

- Do not run CPU intensive Docker containers.

### Enable Docker-CE

- Use the following commands in the OS10 Linux Shell:

```
sudo systemctl enable docker
sudo systemctl start docker
```

**i** **NOTE:** When you run the `docker run` command to create a container, you must use the `--net=host` parameter.

### Install a Docker image

- To pull the latest Docker image from a Docker hub:

```
docker pull nginx
```

Or

```
docker pull nginx:latest
```

**i** **NOTE:** Docker downloads the latest image if you do not specify the image file name.

- To pull a Docker image from a private repository:

```
docker pull private-repository-URL
```

### View installed local images

- Use one of the following commands:

```
docker images
```

Or

```
docker image ls
```

Or

```
docker image inspect node:latest
```

### Remove installed local images

- Remove the Puppet Agent image:

```
docker image rm puppet-agent
```

- Remove the nginx image with the latest tag:

```
docker image rm nginx:latest
```

### Install and start images

- Create a container with the latest image in the host network namespace:

```
docker run -d --net=host --name mynode node
```

- Create a container with the stretch image in the host network namespace:

```
docker run -d --net=host --name strnode node:stretch
```

- Create a container with the Puppet Agent image in the host network namespace:

```
docker run -d --net=host --name mypuppet puppet-agent
```

- Start an existing container:

```
docker start --name container-name
```

- Stop a running existing container:

```
docker stop --name container-name
```

- Open an interactive terminal inside a container:

```
docker exec -it --name container-name
```

### Manage volumes

- Create a Docker volume:

```
docker volume create volume-name
```

- Run a Docker in a particular volume mapped to `"/work"` inside the container:

```
docker run -d -it -v workvoll1:/work puppet-agent /bin/bash
```

- Display details of a volume:

```
docker volume inspect volume-name
```

- List all the volumes in the system:

```
docker volume ls
```

- Remove a volume:

```
docker volume rm volume-name
```

### Docker Management

- List all running Docker containers:

```
docker ps
```

- List all running and stopped Docker containers:

```
docker ps -a
```

- Remove a Docker container:

```
docker rm container-name
```

- Remove a Docker image:

```
docker rmi image-name
```

- Remove unused Docker images:

```
docker image prune
```

- Remove unused Docker volumes:

```
docker volume prune
```

- Remove all unused containers, images, and networks:

```
docker system prune
```

- Run a Docker container with a certain amount of memory:

```
docker run -d --memory="size" container-name
```

- Run a Docker container, and restrict its CPU usage:

```
docker run -d --cpus="processor-allocation-percentage" container-name
```

For more information about Docker-CE commands, see the Docker-CE documentation.

# Interfaces

You can configure and monitor physical interfaces (Ethernet), port-channels, and virtual local area networks (VLANs) in Layer 2 (L2) or Layer 3 (L3) modes.

**Table 11. Interface types**

| Interface type | Supported | Default mode | Requires creation   | Default status      |
|----------------|-----------|--------------|---------------------|---------------------|
| Ethernet (PHY) | L2, L3    | unset        | No                  | no shutdown enabled |
| Management     | N/A       | N/A          | No                  | no shutdown enabled |
| Loopback       | L3        | L3           | Yes                 | no shutdown enabled |
| Port-channel   | L2, L3    | unset        | Yes                 | no shutdown enabled |
| VLAN           | L2, L3    | L3           | Yes, except default | no shutdown enabled |

## Configuration notes

All Dell EMC PowerSwitches except MX-Series, S4200-Series, S5200 Series, and Z9332F-ON:

- To avoid loops in an L2 network with statically configured port channels, keep the `no switchport` configuration on an interface after you remove its port-channel configuration using the `no interface port-channel` command.
- On a S4148-ON switch, 10GBASE-T transceiver cannot operate at 100M or 1G speed.

## Ethernet interfaces

Ethernet port interfaces are enabled by default. To disable an Ethernet interface, use the `shutdown` command. Use the `show interface status` command to view the status of the interfaces.

**NOTE:** Linux operation or commands such as `shutdown` or `no-shutdown` and `ip-address` that are run against the interface is not reflected in the CLI.

To reenable a disabled interface, use the `no shutdown` command.

1. Configure an Ethernet port interface from Global CONFIGURATION mode.

```
interface ethernet node/slot/port[:subport]
```

2. Disable and reenable the Ethernet port interface in INTERFACE mode.

```
shutdown
```

```
no shutdown
```

### Disable Ethernet port interface

```
OS10(config)# interface ethernet 1/1/1
OS10(conf-if-eth1/1/1)# shutdown
```

### Enable Ethernet port interface

```
OS10(config)# interface ethernet 1/1/1
OS10(conf-if-eth1/1/1)# no shutdown
```

# Unified port groups

In an OS10 unified port group, all ports operate in either Ethernet or Fibre Channel (FC) mode. You cannot mix modes for ports in the same unified port group. To activate Ethernet interfaces, configure a port group to operate in Ethernet mode and specify the port speed. To activate Fibre Channel interfaces, see [Fibre Channel interfaces](#).

## S4148U-ON

On the S4148U-ON switch, the available Ethernet and Fibre Channel interfaces in a port group depend on the currently configured port profile. For more information, see [S4148U-ON port profiles](#).

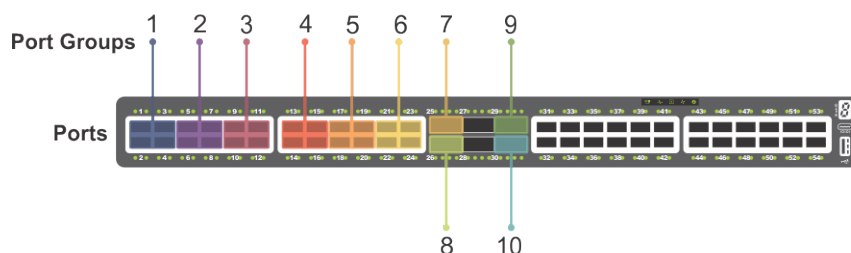

Figure 1. S4148U-ON unified port groups

## MX9116n Fabric Switching Engine

On the MX9116n Fabric Switching Engine module:

- QSFP28-DD port groups 1 to 12 operate only in Ethernet mode. For more information, see [Double-density QSFP28 interfaces](#) on page 317.
- QSFP28 port groups 13 and 14 operate in Ethernet 1x100GE mode by default.
- Unified port groups 15 and 16 operate in Ethernet 1x100GE mode by default, and support Fibre Channel and other Ethernet modes. In Ethernet mode, unified port groups 15 and 16 contain different breakout options than QSFP28-DD and QSFP28 port groups 1 to 14.
- If an MX9116n module is in SmartFabric mode, use the OpenManage Enterprise - Modular interface to configure breakout interfaces and speed for a unified port group.

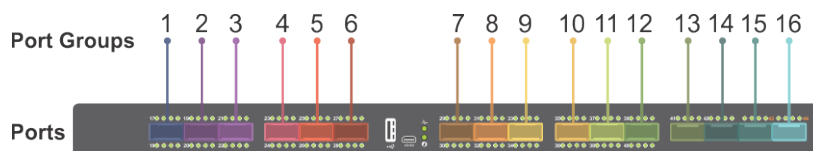

Figure 2. MX9116n Fabric Switching Engine unified port groups

To enable Ethernet interfaces in a unified port group:

1. Configure a unified port group in CONFIGURATION mode. Enter 1/1 for *node/slot*. The port-group range depends on the switch.

```
port-group node/slot/port-group
```

2. Activate the unified port group for Ethernet operation in PORT-GROUP mode. To activate a unified port group in Fibre Channel mode, see [Fibre Channel interfaces](#). The available options depend on the switch.

```
mode Eth {100g-1x | 50g-2x | 40g-1x | 25g-4x | 10g-4x}
```

- 100g-1x — Reset a port group to 100GE mode.
- 50g-2x — Split a port group into two 50GE interfaces.
- 40g-1x — Set a port group to 40GE mode for use with a QSFP+ 40GE transceiver.
- 25g-4x — Split a port group into four 25GE interfaces.
- 10g-4x — Split a port group into four 10GE interfaces.



3. Return to CONFIGURATION mode.

```
exit
```

4. Enter Ethernet Interface mode to configure other settings. Enter a single interface, a hyphen-separated range, or multiple interfaces separated by commas.

```
interface ethernet node/slot/port[:subport]
```

### Configure Ethernet unified port interface

```
OS10(config)# port-group 1/1/13
OS10(conf-pg-1/1/13)# mode Eth 25g-4x
OS10(conf-pg-1/1/13)# exit
OS10(config)# interface ethernet 1/1/41:1
OS10(conf-if-eth1/1/41:1)#
```

### View Ethernet unified port interface

```
OS10(config)# interface ethernet 1/1/41
OS10(conf-if-eth1/1/41:1)# show configuration
!
interface ethernet1/1/41:1
no shutdown
```

## Z9264F-ON port-group profiles

On the Z9264F-ON switch, the port-group profiles determine the available front-panel Ethernet ports and supported breakout interfaces. QSFP28 ports operate only in Ethernet mode. Use the port-group profile to configure breakout interfaces and specify the port speed.

**NOTE:** The configuration steps to enable Ethernet interfaces on a Z9264F-ON port group are different than that of the S4100-ON series. Follow the procedure described in this section to configure breakout interfaces on a Z9264F-ON switch.

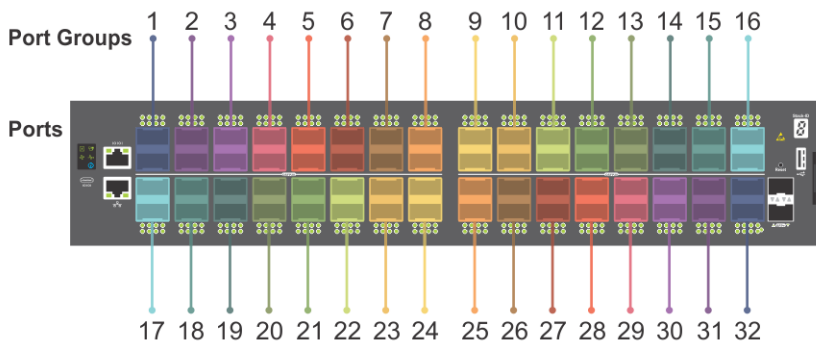

Each pair of odd and even numbered ports is configured as a port group. For example:

| hybrid-group     | profile      | Ports  | Mode         |
|------------------|--------------|--------|--------------|
| port-group1/1/1  | restricted   | 1/1/1  | Eth 10g-4x   |
|                  |              | 1/1/2  | Eth Disabled |
| port-group1/1/2  | restricted   | 1/1/3  | Eth 10g-4x   |
|                  |              | 1/1/4  | Eth Disabled |
| port-group1/1/3  | restricted   | 1/1/5  | Eth 10g-4x   |
|                  |              | 1/1/6  | Eth Disabled |
| .                |              |        |              |
| .                |              |        |              |
| .                |              |        |              |
| port-group1/1/31 | unrestricted | 1/1/61 | Eth 100g-1x  |
|                  |              | 1/1/62 | Eth 100g-1x  |
| port-group1/1/32 | unrestricted | 1/1/63 | Eth 100g-1x  |
|                  |              | 1/1/64 | Eth 100g-1x  |

On the Z9264F-ON switch, the available Ethernet interfaces in a port group depends on the currently configured port-group profile. For details about the supported breakout modes in port-group profiles, see the *profile* CLI command.

To enable Ethernet interfaces:

1. Configure a Z9264F-ON port group in CONFIGURATION mode. Enter 1/1 for *node/slot*. The port-group range is from 1 to 32.

```
port-group node/slot/port-group
```

2. Configure the restricted profile in PORT-GROUP mode. This command applies only to the odd-numbered port within the port group, and disables the even-numbered port in the port group.

```
profile restricted
```

3. Configure the port mode for the odd numbered port within the port group.

```
port node/slot/port mode Eth port-mode
```

- 100g-1x — Reset a port to 100GE mode.
- 40g-1x — Set a port to 40GE mode for use with a QSFP+ 40GE transceiver.
- 25g-4x — Split a port into four 25GE interfaces.
- 10g-4x — Split a port into four 10GE interfaces.

4. Return to CONFIGURATION mode.

```
exit
```

5. Enter Ethernet Interface mode to configure other settings. Enter a single interface, a hyphen-separated range, or multiple interfaces separated by commas.

```
interface ethernet node/slot/port[:subport]
```

### Configure restricted port-group profile

```
OS10(config)# port-group 1/1/2
OS10(conf-pg-1/1/2)# profile restricted
OS10(conf-pg-1/1/2)# port 1/1/3 mode Eth 25g-4x
OS10(conf-pg-1/1/2)# exit
OS10(config)# interface ethernet 1/1/3:2
OS10(conf-if-eth1/1/3:2)#
```

### View the interface

```
OS10(config)# interface ethernet 1/1/3:2
OS10(conf-if-eth1/1/3:2)# show configuration
!
interface ethernet1/1/3:2
no shutdown
```

## Port-groups on S5200F-ON switches

On the S5200F-ON series switches, port-groups determine the available front-panel Ethernet ports and supported breakout interfaces.

When you convert a port to a particular mode, all ports that belong to the port group also operate at the same mode. For example, if you convert the Ethernet 1/1/1 interface to 10g-4x, all other interfaces that belong to port-group 1/1/1 namely, 1/1/2, 1/1/3, and 1/1/4 also operate at 10g-4x mode.

**NOTE:** The S5232F-ON platform does not use port groups. On this platform, use the *interface breakout* command instead.

The following shows the supported port groups and breakout modes on the S5212F-ON switch:

```
OS10# show port-group
```

| Port-group | Mode | Ports | FEM |
|------------|------|-------|-----|
|------------|------|-------|-----|

```

port-group1/1/1 Eth 10g-4x 1 2 3 4 -
port-group1/1/2 Eth 10g-4x 5 6 7 8 -
port-group1/1/3 Eth 10g-4x 9 10 11 12 -
port-group1/1/4 Eth 100g-1x 13 -
port-group1/1/5 Eth 100g-1x 14 -
port-group1/1/6 Eth 100g-1x 15 -

```

**Table 12. Port groups and breakout modes on the S5212F-ON switch**

| Port Group       | Ports         | Supported breakout modes                                                                                                            |
|------------------|---------------|-------------------------------------------------------------------------------------------------------------------------------------|
| Port-group1/1/1  | 1, 2, 3, 4    | <ul style="list-style-type: none"> <li>• 25g-4x</li> <li>• 10g-4x</li> </ul>                                                        |
| Port-group1/1/2  | 5, 6, 7, 8    | <ul style="list-style-type: none"> <li>• 25g-4x</li> <li>• 10g-4x</li> </ul>                                                        |
| Port-group1/1/3  | 9, 10, 11, 12 | <ul style="list-style-type: none"> <li>• 25g-4x</li> <li>• 10g-4x</li> </ul>                                                        |
| Port-group1/1/4  | 13            | <ul style="list-style-type: none"> <li>• 100g-1x</li> <li>• 50g-2x</li> <li>• 40g-1x</li> <li>• 25g-4x</li> <li>• 10g-4x</li> </ul> |
| Port-group1/1/14 | 14            | <ul style="list-style-type: none"> <li>• 100g-1x</li> <li>• 50g-2x</li> <li>• 40g-1x</li> <li>• 25g-4x</li> <li>• 10g-4x</li> </ul> |
| Port-group1/1/6  | 15            | <ul style="list-style-type: none"> <li>• 100g-1x</li> <li>• 50g-2x</li> <li>• 40g-1x</li> <li>• 25g-4x</li> <li>• 10g-4x</li> </ul> |

The following shows the supported port groups and breakout modes on the S5224F-ON switch:

```

OS10# show port-group
Port-group Mode Ports FEM
port-group1/1/1 Eth 10g-4x 1 2 3 4 -
port-group1/1/2 Eth 10g-4x 5 6 7 8 -
port-group1/1/3 Eth 10g-4x 9 10 11 12 -
port-group1/1/4 Eth 10g-4x 13 14 15 16 -
port-group1/1/5 Eth 10g-4x 17 18 19 20 -
port-group1/1/6 Eth 10g-4x 21 22 23 24 -
port-group1/1/7 Eth 100g-1x 25 -
port-group1/1/8 Eth 100g-1x 26 -
port-group1/1/9 Eth 100g-1x 27 -
port-group1/1/10 Eth 100g-1x 28 -

```

**Table 13. Port groups and breakout modes on the S5224F-ON switch**

| Port Group      | Ports      | Supported breakout modes                                                     |
|-----------------|------------|------------------------------------------------------------------------------|
| Port-group1/1/1 | 1, 2, 3, 4 | <ul style="list-style-type: none"> <li>• 25g-4x</li> <li>• 10g-4x</li> </ul> |
| Port-group1/1/2 | 5, 6, 7, 8 | <ul style="list-style-type: none"> <li>• 25g-4x</li> </ul>                   |

**Table 13. Port groups and breakout modes on the S5224F-ON switch (continued)**

| Port Group       | Ports          | Supported breakout modes                                                                                                            |
|------------------|----------------|-------------------------------------------------------------------------------------------------------------------------------------|
|                  |                | <ul style="list-style-type: none"> <li>• 10g-4x</li> </ul>                                                                          |
| Port-group1/1/3  | 9, 10, 11, 12  | <ul style="list-style-type: none"> <li>• 25g-4x</li> <li>• 10g-4x</li> </ul>                                                        |
| Port-group1/1/4  | 13, 14, 15, 16 | <ul style="list-style-type: none"> <li>• 25g-4x</li> <li>• 10g-4x</li> </ul>                                                        |
| Port-group1/1/5  | 17, 18, 19, 20 | <ul style="list-style-type: none"> <li>• 25g-4x</li> <li>• 10g-4x</li> </ul>                                                        |
| Port-group1/1/6  | 21, 22, 23, 24 | <ul style="list-style-type: none"> <li>• 25g-4x</li> <li>• 10g-4x</li> </ul>                                                        |
| Port-group1/1/7  | 25             | <ul style="list-style-type: none"> <li>• 100g-1x</li> <li>• 50g-2x</li> <li>• 40g-1x</li> <li>• 25g-4x</li> <li>• 10g-4x</li> </ul> |
| Port-group1/1/8  | 26             | <ul style="list-style-type: none"> <li>• 100g-1x</li> <li>• 50g-2x</li> <li>• 40g-1x</li> <li>• 25g-4x</li> <li>• 10g-4x</li> </ul> |
| Port-group1/1/9  | 27             | <ul style="list-style-type: none"> <li>• 100g-1x</li> <li>• 50g-2x</li> <li>• 40g-1x</li> <li>• 25g-4x</li> <li>• 10g-4x</li> </ul> |
| Port-group1/1/10 | 28             | <ul style="list-style-type: none"> <li>• 100g-1x</li> <li>• 50g-2x</li> <li>• 40g-1x</li> <li>• 25g-4x</li> <li>• 10g-4x</li> </ul> |

The following shows the supported port groups and breakout modes on the S5248F-ON switch:

```
OS10# show port-group
Port-group Mode Ports FEM
port-group1/1/1 Eth 25g-4x 1 2 3 4 -
port-group1/1/2 Eth 25g-4x 5 6 7 8 -
port-group1/1/3 Eth 25g-4x 9 10 11 12 -
port-group1/1/4 Eth 25g-4x 13 14 15 16 -
port-group1/1/5 Eth 25g-4x 17 18 19 20 -
port-group1/1/6 Eth 25g-4x 21 22 23 24 -
port-group1/1/7 Eth 25g-4x 25 26 27 28 -
port-group1/1/8 Eth 25g-4x 29 30 31 32 -
port-group1/1/9 Eth 25g-4x 33 34 35 36 -
port-group1/1/10 Eth 25g-4x 37 38 39 40 -
port-group1/1/11 Eth 25g-4x 41 42 43 44 -
port-group1/1/12 Eth 25g-4x 45 46 47 48 -
port-group1/1/13 Eth 100g-2x 49 50 -
port-group1/1/14 Eth 100g-2x 51 52 -
port-group1/1/15 Eth 100g-1x 53 -
port-group1/1/16 Eth 100g-1x 54 -
```

```
port-group1/1/17 Eth 100g-1x 55 -
port-group1/1/18 Eth 100g-1x 56 -
```

**Table 14. Port groups and breakout modes on the S5248F-ON switch**

| Port Group       | Ports          | Supported breakout modes                                                                                                            |
|------------------|----------------|-------------------------------------------------------------------------------------------------------------------------------------|
| Port-group1/1/1  | 1, 2, 3, 4     | <ul style="list-style-type: none"> <li>• 25g-4x</li> <li>• 10g-4x</li> </ul>                                                        |
| Port-group1/1/2  | 5, 6, 7, 8     | <ul style="list-style-type: none"> <li>• 25g-4x</li> <li>• 10g-4x</li> </ul>                                                        |
| Port-group1/1/3  | 9, 10, 11, 12  | <ul style="list-style-type: none"> <li>• 25g-4x</li> <li>• 10g-4x</li> </ul>                                                        |
| Port-group1/1/4  | 13, 14, 15, 16 | <ul style="list-style-type: none"> <li>• 25g-4x</li> <li>• 10g-4x</li> </ul>                                                        |
| Port-group1/1/5  | 17, 18, 19, 20 | <ul style="list-style-type: none"> <li>• 25g-4x</li> <li>• 10g-4x</li> </ul>                                                        |
| Port-group1/1/6  | 21, 22, 23, 24 | <ul style="list-style-type: none"> <li>• 25g-4x</li> <li>• 10g-4x</li> </ul>                                                        |
| Port-group1/1/7  | 25, 26, 27, 28 | <ul style="list-style-type: none"> <li>• 25g-4x</li> <li>• 10g-4x</li> </ul>                                                        |
| Port-group1/1/8  | 29, 30, 31, 32 | <ul style="list-style-type: none"> <li>• 25g-4x</li> <li>• 10g-4x</li> </ul>                                                        |
| Port-group1/1/9  | 33, 34, 35, 36 | <ul style="list-style-type: none"> <li>• 25g-4x</li> <li>• 10g-4x</li> </ul>                                                        |
| Port-group1/1/10 | 37, 38, 39, 40 | <ul style="list-style-type: none"> <li>• 25g-4x</li> <li>• 10g-4x</li> </ul>                                                        |
| Port-group1/1/11 | 41, 42, 43, 44 | <ul style="list-style-type: none"> <li>• 25g-4x</li> <li>• 10g-4x</li> </ul>                                                        |
| Port-group1/1/12 | 45, 46, 47, 48 | <ul style="list-style-type: none"> <li>• 25g-4x</li> <li>• 10g-4x</li> </ul>                                                        |
| Port-group1/1/13 | 49, 50         | <ul style="list-style-type: none"> <li>• 100g-2x</li> <li>• 50g-4x</li> <li>• 40g-2x</li> <li>• 25g-8x</li> <li>• 10g-8x</li> </ul> |
| Port-group1/1/14 | 51, 52         | <ul style="list-style-type: none"> <li>• 100g-2x</li> <li>• 50g-4x</li> <li>• 40g-2x</li> <li>• 25g-8x</li> <li>• 10g-8x</li> </ul> |
| Port-group1/1/15 | 53             | <ul style="list-style-type: none"> <li>• 100g-1x</li> <li>• 50g-2x</li> <li>• 40g-1x</li> <li>• 25g-4x</li> <li>• 10g-4x</li> </ul> |

**Table 14. Port groups and breakout modes on the S5248F-ON switch (continued)**

| Port Group       | Ports | Supported breakout modes                                                                                                            |
|------------------|-------|-------------------------------------------------------------------------------------------------------------------------------------|
| Port-group1/1/16 | 54    | <ul style="list-style-type: none"> <li>• 100g-1x</li> <li>• 50g-2x</li> <li>• 40g-1x</li> <li>• 25g-4x</li> <li>• 10g-4x</li> </ul> |
| Port-group1/1/17 | 55    | <ul style="list-style-type: none"> <li>• 100g-1x</li> <li>• 50g-2x</li> <li>• 40g-1x</li> <li>• 25g-4x</li> <li>• 10g-4x</li> </ul> |
| Port-group1/1/18 | 56    | <ul style="list-style-type: none"> <li>• 100g-1x</li> <li>• 50g-2x</li> <li>• 40g-1x</li> <li>• 25g-4x</li> <li>• 10g-4x</li> </ul> |

The following shows the supported port groups and breakout modes on the S5296F-ON switch:

```

OS10# show port-group

Port-group Mode Ports FEM
port-group1/1/1 Eth 25g-4x 1 2 3 4 -
port-group1/1/2 Eth 25g-4x 5 6 7 8 -
port-group1/1/3 Eth 25g-4x 9 10 11 12 -
port-group1/1/4 Eth 25g-4x 13 14 15 16 -
port-group1/1/5 Eth 25g-4x 17 18 19 20 -
port-group1/1/6 Eth 25g-4x 21 22 23 24 -
port-group1/1/7 Eth 25g-4x 25 26 27 28 -
port-group1/1/8 Eth 25g-4x 29 30 31 32 -
port-group1/1/9 Eth 25g-4x 33 34 35 36 -
port-group1/1/10 Eth 25g-4x 37 38 39 40 -
port-group1/1/11 Eth 10g-4x 41 42 43 44 -
port-group1/1/12 Eth 25g-4x 45 46 47 48 -
port-group1/1/13 Eth 25g-4x 49 50 51 52 -
port-group1/1/14 Eth 25g-4x 53 54 55 56 -
port-group1/1/15 Eth 25g-4x 57 58 59 60 -
port-group1/1/16 Eth 25g-4x 61 62 63 64 -
port-group1/1/17 Eth 25g-4x 65 66 67 68 -
port-group1/1/18 Eth 25g-4x 69 70 71 72 -
port-group1/1/19 Eth 25g-4x 73 74 75 76 -
port-group1/1/20 Eth 25g-4x 77 78 79 80 -
port-group1/1/21 Eth 25g-4x 81 82 83 84 -
port-group1/1/22 Eth 25g-4x 85 86 87 88 -
port-group1/1/23 Eth 25g-4x 89 90 91 92 -
port-group1/1/24 Eth 25g-4x 93 94 95 96 -
port-group1/1/25 Eth 100g-1x 97 -
port-group1/1/26 Eth 100g-1x 98 -
port-group1/1/27 Eth 100g-1x 99 -
port-group1/1/28 Eth 100g-1x 100 -
port-group1/1/29 Eth 100g-1x 101 -
port-group1/1/30 Eth 100g-1x 102 -
port-group1/1/31 Eth 100g-1x 103 -
port-group1/1/32 Eth 100g-1x 104 -

```

**Table 15. Port groups and breakout modes on the S5296F-ON switch**

| Port Group      | Ports      | Supported breakout modes                                                     |
|-----------------|------------|------------------------------------------------------------------------------|
| Port-group1/1/1 | 1, 2, 3, 4 | <ul style="list-style-type: none"> <li>• 25g-4x</li> <li>• 10g-4x</li> </ul> |

**Table 15. Port groups and breakout modes on the S5296F-ON switch (continued)**

| Port Group       | Ports          | Supported breakout modes                                                     |
|------------------|----------------|------------------------------------------------------------------------------|
| Port-group1/1/2  | 5, 6, 7, 8     | <ul style="list-style-type: none"> <li>● 25g-4x</li> <li>● 10g-4x</li> </ul> |
| Port-group1/1/3  | 9, 10, 11, 12  | <ul style="list-style-type: none"> <li>● 25g-4x</li> <li>● 10g-4x</li> </ul> |
| Port-group1/1/4  | 13, 14, 15, 16 | <ul style="list-style-type: none"> <li>● 25g-4x</li> <li>● 10g-4x</li> </ul> |
| Port-group1/1/5  | 17, 18, 19, 20 | <ul style="list-style-type: none"> <li>● 25g-4x</li> <li>● 10g-4x</li> </ul> |
| Port-group1/1/6  | 21, 22, 23, 24 | <ul style="list-style-type: none"> <li>● 25g-4x</li> <li>● 10g-4x</li> </ul> |
| Port-group1/1/7  | 25, 26, 27, 28 | <ul style="list-style-type: none"> <li>● 25g-4x</li> <li>● 10g-4x</li> </ul> |
| Port-group1/1/8  | 29, 30, 31, 32 | <ul style="list-style-type: none"> <li>● 25g-4x</li> <li>● 10g-4x</li> </ul> |
| Port-group1/1/9  | 33, 34, 35, 36 | <ul style="list-style-type: none"> <li>● 25g-4x</li> <li>● 10g-4x</li> </ul> |
| Port-group1/1/10 | 37, 38, 39, 40 | <ul style="list-style-type: none"> <li>● 25g-4x</li> <li>● 10g-4x</li> </ul> |
| Port-group1/1/11 | 41, 42, 43, 44 | <ul style="list-style-type: none"> <li>● 25g-4x</li> <li>● 10g-4x</li> </ul> |
| Port-group1/1/12 | 45, 46, 47, 48 | <ul style="list-style-type: none"> <li>● 25g-4x</li> <li>● 10g-4x</li> </ul> |
| Port-group1/1/13 | 49, 50, 51, 52 | <ul style="list-style-type: none"> <li>● 25g-4x</li> <li>● 10g-4x</li> </ul> |
| Port-group1/1/14 | 53, 54, 55, 56 | <ul style="list-style-type: none"> <li>● 25g-4x</li> <li>● 10g-4x</li> </ul> |
| Port-group1/1/15 | 57, 58, 59, 60 | <ul style="list-style-type: none"> <li>● 25g-4x</li> <li>● 10g-4x</li> </ul> |
| Port-group1/1/16 | 61, 62, 63, 64 | <ul style="list-style-type: none"> <li>● 25g-4x</li> <li>● 10g-4x</li> </ul> |
| Port-group1/1/17 | 65, 66, 67, 68 | <ul style="list-style-type: none"> <li>● 25g-4x</li> <li>● 10g-4x</li> </ul> |
| Port-group1/1/18 | 69, 70, 71, 72 | <ul style="list-style-type: none"> <li>● 25g-4x</li> <li>● 10g-4x</li> </ul> |
| Port-group1/1/19 | 73, 74, 75, 76 | <ul style="list-style-type: none"> <li>● 25g-4x</li> <li>● 10g-4x</li> </ul> |
| Port-group1/1/20 | 77, 78, 79, 80 | <ul style="list-style-type: none"> <li>● 25g-4x</li> <li>● 10g-4x</li> </ul> |

**Table 15. Port groups and breakout modes on the S5296F-ON switch (continued)**

| Port Group       | Ports          | Supported breakout modes                                                                                                            |
|------------------|----------------|-------------------------------------------------------------------------------------------------------------------------------------|
| Port-group1/1/21 | 81, 82, 83, 84 | <ul style="list-style-type: none"> <li>● 25g-4x</li> <li>● 10g-4x</li> </ul>                                                        |
| Port-group1/1/22 | 85, 86, 87, 88 | <ul style="list-style-type: none"> <li>● 25g-4x</li> <li>● 10g-4x</li> </ul>                                                        |
| Port-group1/1/23 | 89, 90, 91, 92 | <ul style="list-style-type: none"> <li>● 25g-4x</li> <li>● 10g-4x</li> </ul>                                                        |
| Port-group1/1/24 | 93, 94, 95, 96 | <ul style="list-style-type: none"> <li>● 25g-4x</li> <li>● 10g-4x</li> </ul>                                                        |
| Port-group1/1/25 | 97             | <ul style="list-style-type: none"> <li>● 100g-1x</li> <li>● 50g-2x</li> <li>● 40g-1x</li> <li>● 25g-4x</li> <li>● 10g-4x</li> </ul> |
| Port-group1/1/26 | 98             | <ul style="list-style-type: none"> <li>● 100g-1x</li> <li>● 50g-2x</li> <li>● 40g-1x</li> <li>● 25g-4x</li> <li>● 10g-4x</li> </ul> |
| Port-group1/1/27 | 99             | <ul style="list-style-type: none"> <li>● 100g-1x</li> <li>● 50g-2x</li> <li>● 40g-1x</li> <li>● 25g-4x</li> <li>● 10g-4x</li> </ul> |
| Port-group1/1/28 | 100            | <ul style="list-style-type: none"> <li>● 100g-1x</li> <li>● 50g-2x</li> <li>● 40g-1x</li> <li>● 25g-4x</li> <li>● 10g-4x</li> </ul> |
| Port-group1/1/29 | 101            | <ul style="list-style-type: none"> <li>● 100g-1x</li> <li>● 50g-2x</li> <li>● 40g-1x</li> <li>● 25g-4x</li> <li>● 10g-4x</li> </ul> |
| Port-group1/1/30 | 102            | <ul style="list-style-type: none"> <li>● 100g-1x</li> <li>● 50g-2x</li> <li>● 40g-1x</li> <li>● 25g-4x</li> <li>● 10g-4x</li> </ul> |
| Port-group1/1/31 | 103            | <ul style="list-style-type: none"> <li>● 100g-1x</li> <li>● 50g-2x</li> <li>● 40g-1x</li> <li>● 25g-4x</li> <li>● 10g-4x</li> </ul> |
| Port-group1/1/32 | 104            | <ul style="list-style-type: none"> <li>● 100g-1x</li> </ul>                                                                         |



**Table 15. Port groups and breakout modes on the S5296F-ON switch (continued)**

| Port Group | Ports | Supported breakout modes                                                                                         |
|------------|-------|------------------------------------------------------------------------------------------------------------------|
|            |       | <ul style="list-style-type: none"> <li>• 50g-2x</li> <li>• 40g-1x</li> <li>• 25g-4x</li> <li>• 10g-4x</li> </ul> |

To configure breakout modes:

1. Configure a port group in CONFIGURATION mode. Enter 1/1 for *node/slot* and the port group number.

```
port-group node/slot/port-group
```

2. Configure the breakout mode in PORT-GROUP mode.

```
mode Eth breakout-mode
```

- 100g-2x — Split a port group into two 100GE interface.
- 100g-1x — Set a port group to 100GE mode.
- 50g-4x — Split a port group into four 50GE interfaces.
- 50g-2x — Split a port group into two 50GE interfaces.
- 40g-2x — Split a port group into two 40GE interfaces for use with a QSFP+ 40GE transceiver.
- 40g-1x — Set a port group to 40GE mode for use with a QSFP+ 40GE transceiver.
- 25g-8x — Split a port group into eight 25GE interfaces.
- 25g-4x — Split a port group into four 25GE interfaces.
- 10g-8x — Split a port group into eight 10GE interfaces.
- 10g-4x — Split a port group into four 10GE interfaces.

3. Return to CONFIGURATION mode.

```
exit
```

4. Enter Interface breakout mode to configure other settings, such as, speed.

```
interface ethernet node/slot/port[:subport]
```

The following shows converting a port group from 25g-4x mode to 10g-4x mode:

```
OS10# configure terminal
OS10(config)# port-group 1/1/1
OS10(conf-pg-1/1/1)# mode Eth 10g-4x
OS10(conf-pg-1/1/1)# exit
OS10(config)# interface ethernet 1/1/1:1
OS10(conf-if-eth1/1/1:1)# speed
1000 Set speed to 1000 Mbps
10000 Set speed to 10000 Mbps
auto Automatic Settings (default)
OS10(conf-if-eth1/1/1:1)# speed 1000
```

## L2 mode configuration

Each physical Ethernet interface uses a unique MAC address. Port-channels and VLANs use a single MAC address. By default, all the interfaces operate in L2 mode. From L2 mode you can configure switching and L2 protocols, such as VLANs and Spanning-Tree Protocol (STP) on an interface.

Enable L2 switching on a port interface in Access or Trunk mode. By default, an interface is configured in Access mode. Access mode allows L2 switching of untagged traffic on a single VLAN (VLAN 1 is the default). Trunk mode enables L2 switching of untagged traffic on the Access VLAN, and tagged traffic on one or more VLANs.

By default, native VLAN of a port is the default VLAN ID of the switch. You can change the native VLAN using the `switchport access vlan vlan-id` command.

A Trunk interface carries VLAN traffic that is tagged using 802.1q encapsulation. If an Access interface receives a packet with an 802.1q tag in the header that is different from the Access VLAN ID, it drops the packet.

By default, a trunk interface carries only untagged traffic on the Access VLAN. You must manually configure other VLANs for tagged traffic.

1. Select one of the two available options:

- Configure L2 trunking in INTERFACE mode and the tagged VLAN traffic that the port can transmit. By default, a trunk port is not added to any tagged VLAN. You must create a VLAN before you can assign the interface to it.

```
switchport mode trunk
switchport trunk allowed vlan vlan-id-list
```

- Reconfigure the access VLAN assigned to a L2 access or trunk port in INTERFACE mode.

```
switchport access vlan vlan-id
```

2. Enable the interface for L2 traffic transmission in INTERFACE mode.

```
no shutdown
```

### L2 interface configuration

```
OS10(config)# interface ethernet 1/1/7
OS10(conf-if-eth1/1/7)# switchport mode trunk
OS10(conf-if-eth1/1/7)# switchport trunk allowed vlan 5,10
OS10(conf-if-eth1/1/7)# no shutdown
```

## L3 mode configuration

Ethernet and port-channel interfaces are in L2 access mode by default. When you disable the L2 mode and then assign an IP address to an Ethernet port interface, you place the port in L3 mode.

Configure one primary IP address in L3 mode. You can configure up to 255 secondary IP addresses on an interface. At least one interface in the system must be in L3 mode before you configure or enter a L3-protocol mode, such as OSPF.

1. Remove a port from L2 switching in INTERFACE mode.

```
no switchport
```

2. Configure L3 routing in INTERFACE mode. Add secondary to configure backup IP addresses.

```
ip address address [secondary]
```

3. Enable the interface for L3 traffic transmission in INTERFACE mode.

```
no shutdown
```

### L3 interface configuration

```
OS10(config)# interface ethernet 1/1/9
OS10(conf-if-eth1/1/9)# no switchport
OS10(conf-if-eth1/1/9)# ip address 10.10.1.92/24
OS10(conf-if-eth1/1/9)# no shutdown
```

### View L3 configuration error

```
OS10(config)# interface ethernet 1/1/14
OS10(conf-if-eth1/1/14)# ip address 10.1.1.2/24
% Error: Interface ethernet1/1/14, IP address cannot exist with L2 modes.
```

# Fibre Channel interfaces

OS10 unified port groups support FC interfaces. A unified port group operates in Fibre Channel or Ethernet mode. To activate FC interfaces, configure a port group to operate in Fibre Channel mode and specify the port speed. By default, FC interfaces are disabled.

## S4148U-ON

On a S4148U-ON switch, FC interfaces are available in all port groups. The activated FC interfaces depend on the currently configured port profile. For more information, see [S4148U-ON port profiles](#).

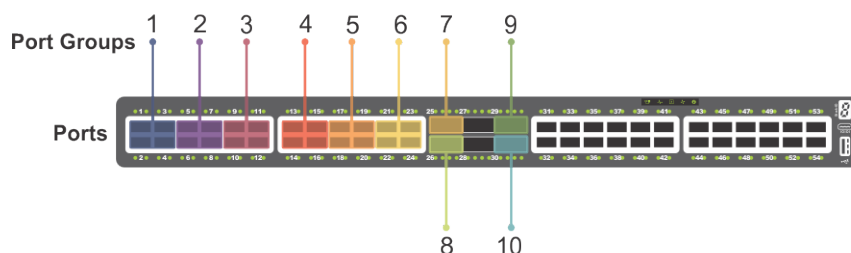

Figure 3. S4148U-ON unified port groups

## MX9116n Fabric Switching Engine

On an MX9116n Fabric Switching Engine module, FC interfaces are available only in unified port groups 15 and 16, ports 43 and 44.

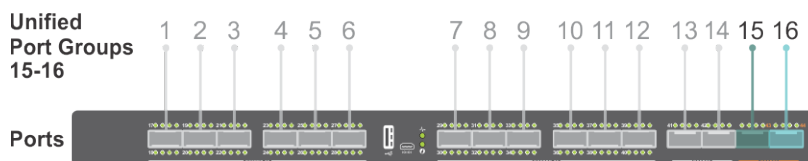

Figure 4. MX9116n Fabric Switching Engine — Unified port groups

1. Configure a unified port group in CONFIGURATION mode. Enter 1/1 for *node/slot*. The port-group range depends on the switch.

```
port-group node/slot/port-group
```

2. Activate the unified port group for FC operation in PORT-GROUP mode. The available FC modes depend on the switch.

```
mode fc {32g-4x | 32g-2x | 32g-1x | 16g-4x}
```

- 16g-4x — Split a unified port group into four 16 GFC interfaces.
- 32g-1x — Split a unified port group into one 32 GFC interface. A 1x-32G interface has a rate limit of 28G.
- 32g-2x — Split a unified port group into two 32 GFC interfaces.
- 32g-4x — Split a unified port group into four 32 GFC interfaces. Each 4x-32GE breakout interface has a rate limit of 25G.

3. Return to CONFIGURATION mode.

```
exit
```

4. Enter FC Interface mode to enable data transmission. Enter a single interface, a hyphen-separated range, or multiple interfaces separated by commas.

```
interface fibrechannel node/slot/port[:subport]
```

5. (Optional) Reconfigure the interface speed in INTERFACE mode.

```
speed {8 | 16 | 32 | auto}
```

6. Apply vfabric configuration on the interface. For more information about vfabric configuration, see [Virtual fabric](#).

```
vfabric fabric-ID
```

7. Enable the FC interface in INTERFACE mode.

```
no shutdown
```

### Configure FC interface

```
OS10(config)# port-group 1/1/15
OS10(conf-pg-1/1/15)# mode FC 16g-4x
OS10(conf-pg-1/1/15)# exit
OS10(config)# interface fibrechannel 1/1/43:1
OS10(conf-if-fc-1/1/43:1)# speed 32
OS10(conf-if-fc-1/1/43:1)# no shutdown
```

### View FC interface

```
OS10(config)# interface fibrechannel 1/1/43:1
OS10(conf-if-fc-1/1/43:1)# show configuration
!
interface fibrechannel1/1/43:1
 no shutdown
 speed 32
 vfabric 100
```

```
OS10# show interface fibrechannel 1/1/43:1
Fibrechannel 1/1/43:1 is up, FC link is up
Address is 14:18:77:20:8d:fc, Current address is 14:18:77:20:8d:fc
Pluggable media present, QSFP+ type is QSFP+ 4x(16GBASE FC SW)
 Wavelength is 850
 Receive power reading is 0.0
FC MTU 2188 bytes
LineSpeed 8G
Port type is F, Max BB credit is 1
WWN is 20:78:14:18:77:20:8d:cf
Last clearing of "show interface" counters: 00:02:32
Input statistics:
 33 frames, 3508 bytes
 0 class 2 good frames, 33 class 3 good frames
 0 frame too long, 0 frame truncated, 0 CRC
 1 link fail, 0 sync loss
 0 primitive seq err, 0 LIP count
 0 BB credit 0, 0 BB credit 0 packet drops
Output statistics:
 33 frames, 2344 bytes
 0 class 2 frames, 33 class 3 frames
 0 BB credit 0, 0 oversize frames
6356027325 total errors
Rate Info:
 Input 116 bytes/sec, 1 frames/sec, 0% of line rate
 Output 78 bytes/sec, 1 frames/sec, 0% of line rate
Time since last interface status change: 00:00:24
```

## Configuring wavelength

You can configure optical transmission wavelength values for SPF+ optics. This configuration enables you to fine tune the laser wavelengths and frequencies up to two decimal places in the nanometer scale.

To configure and view optical transmission wavelength when SPF+ optics are plugged into an interface:

1. In interface configuration mode, enter the following command:

```
wavelength wavelength-value
```

**NOTE:** The supported wavelength range is from 1528.38 nm to 1568.77 nm.

```
OS10(conf-if-eth1/1/14)# wavelength 1530.00
```

2. View the optical transmission values that you configured using the following command:

```
show interface phy-eth interface transceiver | grep "Tunable wavelength"
```

```
OS10# show interface phy-eth 1/1/14 transceiver | grep "Tunable wavelength"
SFP1/1/14 Tunable wavelength= 1530.000nm
```

**NOTE:** To specify the wavelength value, you must enter exactly six digits - four before and two after the decimal point. The value must conform to the following format: ABCD.EF; for example, 1545.23. Any number that does not conform to this format is rejected including whole numbers such as 1568. However, the following type of values are accepted: 1568.00.

## Management interface

The Management interface provides OOB management access to the network device. You can configure the Management interface, but the configuration options on this interface are limited. You cannot configure gateway addresses and IP addresses if it appears in the main routing table. Proxy ARP is not supported on this interface.

1. Configure the Management interface in CONFIGURATION mode.

```
interface mgmt 1/1/1
```

2. By default, DHCP client is enabled on the Management interface. Disable the DHCP client operations in INTERFACE mode.

```
no ip address dhcp
```

3. Configure an IP address and mask on the Management interface in INTERFACE mode.

```
ip address A.B.C.D/prefix-length
```

4. Enable the Management interface in INTERFACE mode.

```
no shutdown
```

### Configure management interface

```
OS10(config)# interface mgmt 1/1/1
OS10(conf-if-ma-1/1/1)# no ip address dhcp
OS10(conf-if-ma-1/1/1)# ip address 10.1.1.10/24
OS10(conf-if-ma-1/1/1)# no shutdown
```

## Management interface

For management connectivity, use the management VLAN. VLAN 4020 is the default management VLAN and is enabled by default. The mgmt1/1/1 port is part of VLAN 4020.

You cannot configure gateway addresses, IP addresses, and proxy ARPs on the management interface.

## VLAN interfaces

VLANs are logical interfaces and are, by default, in L2 mode. Physical interfaces and port-channels can be members of VLANs.

OS10 supports inter-VLAN routing. You can add IP addresses to VLANs and use them in routing protocols in the same manner that physical interfaces are used.

When using VLANs in a routing protocol, you must configure the `no shutdown` command to enable the VLAN for routing traffic. In VLANs, the `shutdown` command prevents L3 traffic from passing through the interface. L2 traffic is unaffected by this command.

- Configure an IP address in A.B.C.D/x format on the interface in INTERFACE mode. The secondary IP address is the interface's backup IP address.

```
ip address ip-address/mask [secondary]
```

### Configure VLAN

```
OS10(config)# interface vlan 10
OS10(conf-if-vl-10)# ip address 1.1.1.2/24
```

You cannot simultaneously use egress rate shaping and ingress rate policing on the same VLAN.

## User-configured default VLAN

By default, VLAN1 serves as the default VLAN for switching untagged L2 traffic on OS10 ports in Trunk or Access mode. The default VLAN is used for untagged protocol traffic sent and received between switches, such as STPs. If you use VLAN1 for data traffic for network-specific needs, reconfigure the VLAN ID of the default VLAN.

- Assign a new VLAN ID to the default VLAN in CONFIGURATION mode, from 1 to 4093.

```
default vlan-id vlan-id
```

In the `show vlan` output, an asterisk (\*) indicates the default VLAN.

### Reconfigure default VLAN

```
OS10# show vlan
Q: A - Access (Untagged), T - Tagged
 NUM Status Description Q Ports
* 1 up
Eth1/1/1-1/1/25,1/1/29,1/1/31-1/1/54

OS10(config)# interface vlan 10
Sep 19 17:28:10 OS10 dn_ifm[932]: Node.1-Unit.1:PRI:notice [os10:notify],
%Dell EMC (OS10) %IFM_ASTATE_UP: Interface admin state up :vlan10
OS10(conf-if-vl-10)# exit

OS10(config)# default vlan-id 10
Sep 19 17:28:15 OS10 dn_ifm[932]: Node.1-Unit.1:PRI:notice [os10:trap], %Dell EMC (OS10)
%IFM_OSTATE_DN: Interface operational state is down :vlan1
Sep 19 17:28:16 OS10 dn_ifm[932]: Node.1-Unit.1:PRI:notice [os10:trap], %Dell EMC (OS10)
%IFM_OSTATE_UP: Interface operational state is up :vlan10

OS10(config)# do show vlan
Codes: * - Default VLAN, M - Management VLAN, R - Remote Port Mirroring VLANs
Q: A - Access (Untagged), T - Tagged
 NUM Status Description Q Ports
 1 down
* 10 up
Eth1/1/1-1/1/25,1/1/29,1/1/31-1/1/54
```

## VLAN scale profile

When you scale the number of VLANs on a switch, use the VLAN scale profile. VLAN scale profile consumes less memory. Enable the scale profile before you configure VLANs on the switch. The scale profile globally applies L2 mode on all VLANs you create and disables L3 transmission. To enable L3 routing traffic on a VLAN, use the `mode L3` command.

 **NOTE:** With VLAN scale profile configuration, Layer 3 VLANs, and FCoE VLANs require `mode L3` configuration.

1. Configure the L2 VLAN scale profile in CONFIGURATION mode.

```
scale-profile vlan
```

2. (Optional) Enable L3 routing on a VLAN in INTERFACE VLAN mode.

```
mode L3
```

After you configure the VLAN scale profile and enable L3 routing on the respective VLANs, save the configuration and reload the switch for the scale profile settings to take effect. To reload the switch, use `reload` command.

### Apply VLAN scale profile

```
OS10(config)# scale-profile vlan
OS10(config)# interface vlan 10
OS10(conf-if-vl-10)# mode L3
OS10(conf-if-vl-10)# end
OS10# write memory
OS10(config)# reload
```

Dell EMC recommends the following sequence when configuring scale profile VLANs:

1. Enable the scale profile VLANs using `scale-profile vlan` command.
2. Disable IGMP and MLDP.

For more information about disabling IGMP and MLD, see [Internet Group Management Protocol](#) and [Multicast Listener Discovery Protocol](#).

3. Configure the Spanning-Tree mode to RSTP.
4. Configure the VLANs.
5. Enter Ethernet Interface mode and add the VLANs to the interface.

**NOTE:** Do not use `interface range` command to enter Ethernet Interface mode.

## Loopback interfaces

A Loopback interface is a virtual interface where the software emulates an interface. Because a Loopback interface is not associated to physical hardware entities, the Loopback interface status is not affected by hardware status changes.

Packets routed to a Loopback interface process locally to the OS10 device. Because this interface is not a physical interface, to provide protocol stability you can configure routing protocols on this interface. You can place Loopback interfaces in default L3 mode.

- Enter the Loopback interface number in CONFIGURATION mode, from 0 to 16383.

```
interface loopback number
```

- Enter the Loopback interface number to view the configuration in EXEC mode.

```
show interface loopback number
```

- Enter the Loopback interface number to delete a Loopback interface in CONFIGURATION mode.

```
no interface loopback number
```

### View Loopback interface

```
OS10# show interface loopback 4
Loopback 4 is up, line protocol is up
Hardware is unknown.
Interface index is 102863300
Internet address is 120.120.120.120/24
Mode of IPv4 Address Assignment : MANUAL
MTU 1532 bytes
Flowcontrol rx false tx false
ARP type: ARPA, ARP Timeout: 240
Last clearing of "show interface" counters : 00:00:11
Queuing strategy : fifo
```

```
Input 0 packets, 0 bytes, 0 multicast
Received 0 errors, 0 discarded
Output 0 packets, 0 bytes, 0 multicast
Output 0 errors, Output 0 invalid protocol
Time since last interface status change : 00:00:11
```

## Port-channel interfaces

Port-channels are not configured by default. Link aggregation (LA) is a method of grouping multiple physical interfaces into a single logical interface — a link aggregation group (LAG) or port-channel. A port-channel aggregates the bandwidth of member links, provides redundancy, and load balances traffic. If a member port fails, the OS10 device redirects traffic to the remaining ports.

A physical interface can belong to only one port-channel at a time. A port-channel must contain interfaces of the same interface type and speed. OS10 supports a maximum of 128 port-channels, with up to thirty-two ports per channel.

To configure a port-channel, use the same configuration commands as the Ethernet port interfaces. Port-channels are transparent to network configurations and manage as a single interface. For example, configure one IP address for the group, and use the IP address for all routed traffic on the port-channel.

By configuring port channels, you can create larger capacity interfaces by aggregating a group of lower-speed links. For example, you can build a 40G interface by aggregating four 10G Ethernet interfaces together. If one of the four interfaces fails, traffic redistributes across the three remaining interfaces.

**Static** Port-channels are statically configured.

**Dynamic** Port-channels are dynamically configured using Link Aggregation Control Protocol (LACP).

Member ports of a LAG are added and programmed into the hardware based on the port ID, instead of the order the ports come up. Load balancing yields predictable results across resets and reloads.

## Create port-channel

You can create a maximum of 128 port-channels, with up to 32 port members per group. Configure a port-channel similarly to a physical interface, enable or configure protocols, or ACLs to a port channel. After you enable the port-channel, place it in L2 or L3 mode.

To place the port-channel in L2 mode or configure an IP address to place the port-channel in L3 mode, use the `switchport` command.

- Create a port-channel in CONFIGURATION mode.

```
interface port-channel id-number
```

### Create port-channel

```
OS10(config)# interface port-channel 10
```

## Add port member

When you add an interface to a port-channel:

- The administrative status applies to the port-channel.
- The port-channel configuration is applied to the member interfaces.
- A port-channel operates in either L2 (default) or L3 mode. To place a port-channel in L2 mode, use the `switchport mode` command. To place a port-channel in L3 mode and remove L2 configuration before you configure an IP address, use the `no switchport` command.
- All interfaces must have the same speed.
- An interface must not contain non-default L2/L3 configuration settings. Only the `description` and `shutdown` or `no shutdown` commands are supported. You cannot add an IP address or static MAC address to a member interface.
- You cannot enable flow control on a port-channel interface. Flow control is supported on physical interfaces that are port-channel members.



- Port-channels support 802.3ad LACP. LACP identifies similarly configured links and dynamically groups ports into a logical channel. LACP activates the maximum number of compatible ports that the switch supports in a port-channel.
- If you globally disable a spanning-tree operation, L2 interfaces that are LACP-enabled port-channel members may flap due to packet loops.

### Add port member — static LAG

A static port-channel LAG contains member interfaces that you manually assign using the `channel-group mode on` command.

```
OS10(config)# interface port-channel 10
Aug 24 4:5:38: %Node.1-Unit.1:PRI:OS10 %dn_ifm
%log-notice:IFM_ASTATE_UP: Interface admin state up.:port-channel10
Aug 24 4:5:38: %Node.1-Unit.1:PRI:OS10 %dn_ifm
%log-notice:IFM_OSTATE_DN: Interface operational state is down.:port-channel10
OS10(conf-if-po-10)# exit

OS10(config)# interface ethernet 1/1/2
OS10(conf-if-eth1/1/2)# channel-group 10 mode on
Aug 24 4:5:56: %Node.1-Unit.1:PRI:OS10 %dn_ifm
%log-notice:IFM_OSTATE_UP: Interface operational state is up.:port-channel10
```

### Add port member — dynamic LACP

LACP enables ports to dynamically bundle as members of a port-channel. To configure a port for LACP operation, use the `channel-group mode {active|passive}` command. Active and Passive modes allow LACP to negotiate between ports to determine if they can form a port channel based on their configuration settings.

```
OS10(config)# interface port-channel 100
OS10(conf-if-po-100)# exit

OS10(config)# interface ethernet 1/1/2
OS10(conf-if-eth1/1/2)# channel-group 100 mode active
```

## Minimum links

Configure minimum links in a port-channel LAG that must be in *oper up* status to consider the port-channel to be in *oper up* status.

### NOTE:

If the minimum links criteria that you have configured is not met, the port channel operationally goes down only in the device in which you have configured the minimum links and not on the device at the other side of the port channel.

For the port channel to go down operationally on both sides when the minimum links criteria is not met, you must configure minimum links on both sides of the port channel.

Enter the number of links in a LAG that must be in *oper up* status in PORT-CHANNEL mode, from 1 to 32, default 1.

```
minimum-links number
```

### Configure minimum operationally up links

```
OS10(config)# interface port-channel 1
OS10(conf-if-po-1)# minimum-links 5
```

## Assign Port Channel IP Address

You can assign an IP address to a port channel and use port channels in L3 routing protocols.

- Configure an IP address and mask on the interface in INTERFACE PORT-CHANNEL mode.
  - `ip address ip-address/mask [secondary-ip-address]`
    - `ip-address/mask` — Specify an IP address in dotted-decimal A.B.C.D format and the mask.

- *secondary-ip-address* — Specify a secondary IP address in dotted-decimal A.B.C.D format, which acts as the interface's backup IP address.

### Assign Port Channel IP Address

```
OS10# configure terminal
OS10(config)# interface port-channel 1
OS10(config-if-po-1)# ip address 1.1.1.1/24
OS10(config-if-po-1)#
```

## Remove or disable port-channel

You can delete or disable a port-channel.

1. Delete a port-channel in CONFIGURATION mode.

```
no interface port-channel channel-number
```

2. Disable a port-channel to place all interfaces within the port-channel operationally down in CONFIGURATION mode.

```
shutdown
```

### Delete port-channel

```
OS10(config)# interface port-channel 10
OS10(config-if-po-10)# no interface port-channel 10
```

## Load balance traffic

Use hashing to load balance traffic across member interfaces of a port-channel. Load balancing uses source and destination packet information to distribute traffic over multiple interfaces when transferring data to a destination.

For packets without an L3 header, OS10 automatically uses the `load-balancing mac-selection destination-mac` command for hash algorithms by default.

When you configure an IP and MAC hashing scheme at the same time, the MAC hashing scheme takes precedence over the IP hashing scheme.

- Select one or more methods of load balancing and replace the default IP 4-tuple method of balancing traffic over a port-channel in CONFIGURATION mode.

```
OS10(config)# load-balancing
 ingress-port Ingress port configurations
 tcp-udp-selection TCP-UDP port for load-balancing configurations
 ip-selection IPV4 load-balancing configurations
 ipv6-selection IPV6 load-balancing configurations
 mac-selection MAC load-balancing configurations
```

- `ingress-port [enable]` — Enables the ingress port configuration.
- `tcp-udp-selection [l4-destination-port | l4-source-port]` — Uses the Layer 4 destination port or Layer 4 source port in the hash calculation.
- `ip-selection [destination-ip | source-ip | protocol | vlan-id | l4-destination-port | l4-source-port]` — Uses the destination IP address, source IP address, protocol, VLAN ID, Layer 4 destination port or Layer 4 source port in the hash calculation.
- `ipv6-selection [destination-ip | source-ip | protocol | vlan-id | l4-destination-port | l4-source-port]` — Uses the destination IPv6 address, source IPv6 address, protocol, VLAN ID, Layer 4 port or Layer 4 source port in the hash calculation.
- `mac-selection [destination-mac | source-mac] [ethertype | vlan-id]` — Uses the destination MAC address or source MAC address, and ethertype, or VLAN ID in the hash calculation.

### Configure load balancing

```
OS10(config)# load-balancing ip-selection destination-ip source-ip
```

## Change hash algorithm

The `load-balancing` command selects the hash criteria applied to traffic load balancing on port-channels. If you do not obtain even traffic distribution, use the `hash-algorithm` command to select the hash scheme for LAG. Rotate or shift the L2-bit LAG hash until you achieve the desired traffic distribution.

- Change the default (0) to another algorithm and apply it to LAG hashing in CONFIGURATION mode.

```
hash-algorithm lag {crc | xor | random}
```

### Change hash algorithm

```
OS10(config)# hash-algorithm lag crc
```

## Configure interface ranges

Bulk interface configuration allows you to apply the same configuration to multiple physical or logical interfaces, or to display their current configuration. An interface range is a set of interfaces that you apply the same command to.

You can use interface ranges for:

- Ethernet physical interfaces
- Port channels
- VLAN interfaces

A bulk configuration includes any non-existing interfaces in an interface range from the configuration.

You can configure a default VLAN only if the interface range being configured consists of only VLAN ports. When a configuration in one of the VLAN ports fails, all the VLAN ports in the interface range are affected.

Create an interface range allowing other commands to be applied to that interface range using the `interface range` command.

### Configure range of Ethernet addresses and enable them

```
OS10(config)# interface range ethernet 1/1/1-1/1/5
OS10(conf-range-eth1/1/1-1/1/5)# no shutdown
```

### View the configuration

```
OS10(conf-range-eth1/1/1-1/1/5)# show configuration
!
interface ethernet1/1/1
 no shutdown
 switchport access vlan 1
!
interface ethernet1/1/2
 no shutdown
 switchport access vlan 1
!
interface ethernet1/1/3
 no shutdown
 switchport access vlan 1
!
interface ethernet1/1/4
 no shutdown
 switchport access vlan 1
!
interface ethernet1/1/5
 no shutdown
 switchport access vlan 1
```

### Configure range of VLANs

```
OS10(config)# interface range vlan 1-100
OS10(conf-range-vl-1-100)#
```

## Configure range of port channels

```
OS10(config)# interface range port-channel 1-25
OS10(conf-range-po-1-25)#
```

# Switch-port profiles

A port profile determines the enabled front-panel ports and supported breakout modes on Ethernet and unified ports. Change the port profile on a switch to customize uplink and unified port operation, and the availability of front-panel data ports.

To change the port profile at the next reboot, use the `switch-port-profile` command with the desired profile, save it to the startup configuration, and use the `reload` command to apply the changes.

1. Configure a platform-specific port profile in CONFIGURATION mode. For a standalone switch, enter 1/1 for node/unit.

```
switch-port-profile node/unit profile
```

2. Save the port profile change to the startup configuration in EXEC mode.

```
write memory
```

3. Reload the switch in EXEC mode.

```
reload
```

The switch reboots with the new port configuration and resets the system defaults, except for the switch-port profile and these configured settings:

- Management interface 1/1/1 configuration
- Management IPv4/IPv6 static routes
- System hostname
- Unified Forwarding Table (UFT) mode
- ECMP maximum paths

You must manually reconfigure other settings on a switch after you apply a new port profile and reload the switch.

**NOTE:** After you change the switch-port profile, do not immediately back up and restore the startup file without using the `write memory` command and reloading the switch using the `reload` command. Otherwise, the new profile does not take effect.

## Configure port profile

```
OS10(config)# switch-port-profile 1/1 profile-6
OS10(config)# exit
OS10# write memory
OS10# reload
```

## Verify port profile

```
OS10(config)# show switch-port-profile 1/1

| Node/Unit | Current | Next-boot | Default |
|-----+-----+-----+-----|
| 1/1 | profile-2 | profile-2 | profile-1 |

Supported Profiles:
profile-1
profile-2
profile-3
profile-4
profile-5
profile-6
```

## S4148-ON Series port profiles

On the S4148-ON Series of switches, port profiles determine the available front-panel Ethernet ports and supported breakout interfaces on uplink ports. In the port profile illustration, blue boxes indicate the supported ports and breakout interfaces. Blank spaces indicate ports and speeds that are not available.

- 10GE mode is an SFP+ 10GE port or a 4x10G breakout of a QSFP+ or QSFP28 port.
- 25GE is a 4x25G breakout of a QSFP28 port.
- 40GE mode is a QSFP+ port or a QSFP28 port that supports QSFP+ 40GE transceivers.
- 50GE is a 2x50G breakout of a QSFP28 port.
- 100GE mode is a QSFP28 port.

**NOTE:** For S4148U-ON port profiles with both unified and Ethernet ports, see [S4148U-ON port profiles](#). An S4148U-ON unified port supports Fibre Channel and Ethernet modes.

For example, `profile-1` enables 10G speed on forty-eight ports (1-24 and 31-54), and 4x10G breakouts on QSFP28 ports 25-26 and 29-30; QSFP+ ports 27 and 28 are deactivated. `profile-3` enables 10G speed on forty ports, and 4x10G breakouts on all QSFP28 and QSFP+ ports. Similarly, `profile-1` disables 40G speed on ports 25-30; `profile-3` enables 40G on these ports. For more information, see [switch-port-profile](#).

| Profile             | Port Modes | SFP+   |   |   |   | SFP+ |   |   |   | SFP+ |    |    |    | SFP+ |    |    |    | SFP+ |    |    |    | QSFP28 |    |    |    | QSFP28 |    |    |    | QSFP+ |    |    |    | QSFP+ |    |    |    | QSFP28 |    |    |    | QSFP28 |    |    |    | SFP+ |    |    |    | SFP+ |    |    |    | SFP+ |    |  |  | SFP+ |  |  |  |
|---------------------|------------|--------|---|---|---|------|---|---|---|------|----|----|----|------|----|----|----|------|----|----|----|--------|----|----|----|--------|----|----|----|-------|----|----|----|-------|----|----|----|--------|----|----|----|--------|----|----|----|------|----|----|----|------|----|----|----|------|----|--|--|------|--|--|--|
|                     |            | 1      | 2 | 3 | 4 | 5    | 6 | 7 | 8 | 9    | 10 | 11 | 12 | 13   | 14 | 15 | 16 | 17   | 18 | 19 | 20 | 21     | 22 | 23 | 24 | 25     | 26 | 27 | 28 | 29    | 30 | 31 | 32 | 33    | 34 | 35 | 36 | 37     | 38 | 39 | 40 | 41     | 42 | 43 | 44 | 45   | 46 | 47 | 48 | 49   | 50 | 51 | 52 | 53   | 54 |  |  |      |  |  |  |
| Profile-1 (default) | 1GE/10GE   | [Blue] |   |   |   |      |   |   |   |      |    |    |    |      |    |    |    |      |    |    |    |        |    |    |    |        |    |    |    |       |    |    |    |       |    |    |    |        |    |    |    |        |    |    |    |      |    |    |    |      |    |    |    |      |    |  |  |      |  |  |  |
|                     | 25GE       | [Blue] |   |   |   |      |   |   |   |      |    |    |    |      |    |    |    |      |    |    |    |        |    |    |    |        |    |    |    |       |    |    |    |       |    |    |    |        |    |    |    |        |    |    |    |      |    |    |    |      |    |    |    |      |    |  |  |      |  |  |  |
|                     | 40GE       | [Blue] |   |   |   |      |   |   |   |      |    |    |    |      |    |    |    |      |    |    |    |        |    |    |    |        |    |    |    |       |    |    |    |       |    |    |    |        |    |    |    |        |    |    |    |      |    |    |    |      |    |    |    |      |    |  |  |      |  |  |  |
|                     | 100GE      | [Blue] |   |   |   |      |   |   |   |      |    |    |    |      |    |    |    |      |    |    |    |        |    |    |    |        |    |    |    |       |    |    |    |       |    |    |    |        |    |    |    |        |    |    |    |      |    |    |    |      |    |    |    |      |    |  |  |      |  |  |  |
| Profile-2           | 1GE/10GE   | [Blue] |   |   |   |      |   |   |   |      |    |    |    |      |    |    |    |      |    |    |    |        |    |    |    |        |    |    |    |       |    |    |    |       |    |    |    |        |    |    |    |        |    |    |    |      |    |    |    |      |    |    |    |      |    |  |  |      |  |  |  |
|                     | 25GE       | [Blue] |   |   |   |      |   |   |   |      |    |    |    |      |    |    |    |      |    |    |    |        |    |    |    |        |    |    |    |       |    |    |    |       |    |    |    |        |    |    |    |        |    |    |    |      |    |    |    |      |    |    |    |      |    |  |  |      |  |  |  |
|                     | 40GE       | [Blue] |   |   |   |      |   |   |   |      |    |    |    |      |    |    |    |      |    |    |    |        |    |    |    |        |    |    |    |       |    |    |    |       |    |    |    |        |    |    |    |        |    |    |    |      |    |    |    |      |    |    |    |      |    |  |  |      |  |  |  |
|                     | 100GE      | [Blue] |   |   |   |      |   |   |   |      |    |    |    |      |    |    |    |      |    |    |    |        |    |    |    |        |    |    |    |       |    |    |    |       |    |    |    |        |    |    |    |        |    |    |    |      |    |    |    |      |    |    |    |      |    |  |  |      |  |  |  |
| Profile-3           | 1GE/10GE   | [Blue] |   |   |   |      |   |   |   |      |    |    |    |      |    |    |    |      |    |    |    |        |    |    |    |        |    |    |    |       |    |    |    |       |    |    |    |        |    |    |    |        |    |    |    |      |    |    |    |      |    |    |    |      |    |  |  |      |  |  |  |
|                     | 25GE       | [Blue] |   |   |   |      |   |   |   |      |    |    |    |      |    |    |    |      |    |    |    |        |    |    |    |        |    |    |    |       |    |    |    |       |    |    |    |        |    |    |    |        |    |    |    |      |    |    |    |      |    |    |    |      |    |  |  |      |  |  |  |
|                     | 40GE       | [Blue] |   |   |   |      |   |   |   |      |    |    |    |      |    |    |    |      |    |    |    |        |    |    |    |        |    |    |    |       |    |    |    |       |    |    |    |        |    |    |    |        |    |    |    |      |    |    |    |      |    |    |    |      |    |  |  |      |  |  |  |
|                     | 100GE      | [Blue] |   |   |   |      |   |   |   |      |    |    |    |      |    |    |    |      |    |    |    |        |    |    |    |        |    |    |    |       |    |    |    |       |    |    |    |        |    |    |    |        |    |    |    |      |    |    |    |      |    |    |    |      |    |  |  |      |  |  |  |
| Profile-4           | 1GE/10GE   | [Blue] |   |   |   |      |   |   |   |      |    |    |    |      |    |    |    |      |    |    |    |        |    |    |    |        |    |    |    |       |    |    |    |       |    |    |    |        |    |    |    |        |    |    |    |      |    |    |    |      |    |    |    |      |    |  |  |      |  |  |  |
|                     | 25GE       | [Blue] |   |   |   |      |   |   |   |      |    |    |    |      |    |    |    |      |    |    |    |        |    |    |    |        |    |    |    |       |    |    |    |       |    |    |    |        |    |    |    |        |    |    |    |      |    |    |    |      |    |    |    |      |    |  |  |      |  |  |  |
|                     | 40GE       | [Blue] |   |   |   |      |   |   |   |      |    |    |    |      |    |    |    |      |    |    |    |        |    |    |    |        |    |    |    |       |    |    |    |       |    |    |    |        |    |    |    |        |    |    |    |      |    |    |    |      |    |    |    |      |    |  |  |      |  |  |  |
|                     | 100GE      | [Blue] |   |   |   |      |   |   |   |      |    |    |    |      |    |    |    |      |    |    |    |        |    |    |    |        |    |    |    |       |    |    |    |       |    |    |    |        |    |    |    |        |    |    |    |      |    |    |    |      |    |    |    |      |    |  |  |      |  |  |  |
| Profile-5           | 1GE/10GE   | [Blue] |   |   |   |      |   |   |   |      |    |    |    |      |    |    |    |      |    |    |    |        |    |    |    |        |    |    |    |       |    |    |    |       |    |    |    |        |    |    |    |        |    |    |    |      |    |    |    |      |    |    |    |      |    |  |  |      |  |  |  |
|                     | 25GE       | [Blue] |   |   |   |      |   |   |   |      |    |    |    |      |    |    |    |      |    |    |    |        |    |    |    |        |    |    |    |       |    |    |    |       |    |    |    |        |    |    |    |        |    |    |    |      |    |    |    |      |    |    |    |      |    |  |  |      |  |  |  |
|                     | 40GE       | [Blue] |   |   |   |      |   |   |   |      |    |    |    |      |    |    |    |      |    |    |    |        |    |    |    |        |    |    |    |       |    |    |    |       |    |    |    |        |    |    |    |        |    |    |    |      |    |    |    |      |    |    |    |      |    |  |  |      |  |  |  |
|                     | 100GE      | [Blue] |   |   |   |      |   |   |   |      |    |    |    |      |    |    |    |      |    |    |    |        |    |    |    |        |    |    |    |       |    |    |    |       |    |    |    |        |    |    |    |        |    |    |    |      |    |    |    |      |    |    |    |      |    |  |  |      |  |  |  |
| Profile-6           | 1GE/10GE   | [Blue] |   |   |   |      |   |   |   |      |    |    |    |      |    |    |    |      |    |    |    |        |    |    |    |        |    |    |    |       |    |    |    |       |    |    |    |        |    |    |    |        |    |    |    |      |    |    |    |      |    |    |    |      |    |  |  |      |  |  |  |
|                     | 25GE       | [Blue] |   |   |   |      |   |   |   |      |    |    |    |      |    |    |    |      |    |    |    |        |    |    |    |        |    |    |    |       |    |    |    |       |    |    |    |        |    |    |    |        |    |    |    |      |    |    |    |      |    |    |    |      |    |  |  |      |  |  |  |
|                     | 40GE       | [Blue] |   |   |   |      |   |   |   |      |    |    |    |      |    |    |    |      |    |    |    |        |    |    |    |        |    |    |    |       |    |    |    |       |    |    |    |        |    |    |    |        |    |    |    |      |    |    |    |      |    |    |    |      |    |  |  |      |  |  |  |
|                     | 100GE      | [Blue] |   |   |   |      |   |   |   |      |    |    |    |      |    |    |    |      |    |    |    |        |    |    |    |        |    |    |    |       |    |    |    |       |    |    |    |        |    |    |    |        |    |    |    |      |    |    |    |      |    |    |    |      |    |  |  |      |  |  |  |

**1GE mode:** 1GE is supported only on SFP+ ports; 1GE is not supported on QSFP+ and QSFP28 ports 25-26.

**Breakout interfaces:** Use the `interface breakout` command in Configuration mode to configure 4x10G, 4x25G, and 2x50G breakout interfaces.

To view the ports that belong to each port group, use the `show port-group` command.

## S4148U-ON port profiles

S4148U-ON port profiles determine the available front-panel unified and Ethernet ports and supported breakout interfaces. In the port profile illustration, blue boxes indicate the supported Ethernet port modes and breakout interfaces. Brown boxes indicate the supported Fibre Channel port modes and breakout interfaces. Blank spaces indicate ports and speeds that are not available. Unified port groups are numbered 1 to 10.

S4148U-ON unified port modes—SFP+ ports 1-24 and QSFP28 ports 25-26 and 29-30:

- 10GE is an SFP+ port in Ethernet mode or a 4x10G breakout of a QSFP+ or QSFP28 port in Ethernet mode.
- 25GE is a 4x25G breakout of a QSFP28 Ethernet port.
- 40GE is a QSFP+ or QSFP28 Ethernet port that uses QSFP+ 40GE transceivers.
- 50GE is a 2x50G breakout of a QSFP28 Ethernet port.
- 100GE is a QSFP28 Ethernet port.
- 4x8GFC are breakout interfaces in an SFP+ or QSFP28 FC port group.
- 2x16GFC are breakout interfaces (subports 1 and 3) in an SFP+ or QSFP28 FC port group.
- 4x16GFC are breakout interfaces in a QSFP28 FC port group.
- 1x32GFC (subport 1) are breakout interfaces in a QSFP28 FC port group.

S4148U-ON Ethernet modes—QSFP+ ports 27-28 and SFP+ ports 31-54:

- 10GE mode is an SFP+ 10GE port or a 4x10G breakout of a QSFP+ port.
- 40GE mode is a QSFP+ port.

For example, all S4148U-ON activate support 10G speed on unified ports 1-24 and Ethernet ports 31-54, but only `profile-1` and `profile-2` activate QSFP+ ports 27-28 in 40GE mode with 4x10G breakouts. Similarly, all S4148U-ON profiles activate 8GFC speed on unified ports 1-24, but only `profile-1`, `profile-2`, and `profile-3` activate 2x16GFC in port groups 1-6. In QSFP28 port groups, `profile-1` and `profile-2` support 1x32GFC; `profile-3` and `profile-4` support 4x16GFC.

| Unified Port Group →       | SFP+              | SFP+     | SFP+ | SFP+ | SFP+ | SFP+ | QSFP28 | QSFP28 | QSFP+ | QSFP+ | QSFP28 | QSFP28 | SFP+ | SFP+ | SFP+ | SFP+ | SFP+ | SFP+ |    |    |    |    |    |    |    |          |    |    |    |    |    |    |    |          |  |  |  |  |  |  |  |
|----------------------------|-------------------|----------|------|------|------|------|--------|--------|-------|-------|--------|--------|------|------|------|------|------|------|----|----|----|----|----|----|----|----------|----|----|----|----|----|----|----|----------|--|--|--|--|--|--|--|
|                            | 1                 | 2        | 3    | 4    | 5    | 6    | 7      | 8      | 9     | 10    |        |        |      |      |      |      |      |      |    |    |    |    |    |    |    |          |    |    |    |    |    |    |    |          |  |  |  |  |  |  |  |
| Port Number →              | 1                 | 2        | 3    | 4    | 5    | 6    | 7      | 8      | 9     | 10    | 31     | 32     | 33   | 34   | 35   | 36   | 37   | 38   | 39 | 40 | 41 | 42 | 43 | 44 | 45 | 46       | 47 | 48 | 49 | 50 | 51 | 52 | 53 | 54       |  |  |  |  |  |  |  |
| Uplink Port Breakouts →    |                   |          |      |      |      |      |        |        | 1     | 2     | 3      | 4      | 1    | 2    | 3    | 4    | 1    | 2    | 3  | 4  | 1  | 2  | 3  | 4  | 1  | 2        | 3  | 4  | 1  | 2  | 3  | 4  |    |          |  |  |  |  |  |  |  |
| <b>Profile</b>             | <b>Port Modes</b> |          |      |      |      |      |        |        |       |       |        |        |      |      |      |      |      |      |    |    |    |    |    |    |    |          |    |    |    |    |    |    |    |          |  |  |  |  |  |  |  |
| <b>Profile-1 (default)</b> | 1GE/10GE          | [Active] |      |      |      |      |        |        |       |       |        |        |      |      |      |      |      |      |    |    |    |    |    |    |    |          |    |    |    |    |    |    |    |          |  |  |  |  |  |  |  |
|                            | 25GE              | [Active] |      |      |      |      |        |        |       |       |        |        |      |      |      |      |      |      |    |    |    |    |    |    |    |          |    |    |    |    |    |    |    |          |  |  |  |  |  |  |  |
|                            | 40GE              | [Active] |      |      |      |      |        |        |       |       |        |        |      |      |      |      |      |      |    |    |    |    |    |    |    |          |    |    |    |    |    |    |    |          |  |  |  |  |  |  |  |
|                            | 50GE              | [Active] |      |      |      |      |        |        |       |       |        |        |      |      |      |      |      |      |    |    |    |    |    |    |    |          |    |    |    |    |    |    |    |          |  |  |  |  |  |  |  |
|                            | 100GE             | [Active] |      |      |      |      |        |        |       |       |        |        |      |      |      |      |      |      |    |    |    |    |    |    |    |          |    |    |    |    |    |    |    |          |  |  |  |  |  |  |  |
|                            | 4x8GFC**          | [Active] |      |      |      |      |        |        |       |       |        |        |      |      |      |      |      |      |    |    |    |    |    |    |    | [Active] |    |    |    |    |    |    |    | [Active] |  |  |  |  |  |  |  |
| <b>Profile-2*</b>          | 4x8GFC**          | [Active] |      |      |      |      |        |        |       |       |        |        |      |      |      |      |      |      |    |    |    |    |    |    |    | [Active] |    |    |    |    |    |    |    | [Active] |  |  |  |  |  |  |  |
|                            | 2x16GFC**         | [Active] |      |      |      |      |        |        |       |       |        |        |      |      |      |      |      |      |    |    |    |    |    |    |    | [Active] |    |    |    |    |    |    |    | [Active] |  |  |  |  |  |  |  |
|                            | 4x16GFC**         | [Active] |      |      |      |      |        |        |       |       |        |        |      |      |      |      |      |      |    |    |    |    |    |    |    | [Active] |    |    |    |    |    |    |    | [Active] |  |  |  |  |  |  |  |
|                            | 1x32GFC           | [Active] |      |      |      |      |        |        |       |       |        |        |      |      |      |      |      |      |    |    |    |    |    |    |    | [Active] |    |    |    |    |    |    |    | [Active] |  |  |  |  |  |  |  |
|                            | 2x32GFC           | [Active] |      |      |      |      |        |        |       |       |        |        |      |      |      |      |      |      |    |    |    |    |    |    |    | [Active] |    |    |    |    |    |    |    | [Active] |  |  |  |  |  |  |  |
|                            | 1GE/10GE          | [Active] |      |      |      |      |        |        |       |       |        |        |      |      |      |      |      |      |    |    |    |    |    |    |    |          |    |    |    |    |    |    |    |          |  |  |  |  |  |  |  |
| <b>Profile-3</b>           | 25GE              | [Active] |      |      |      |      |        |        |       |       |        |        |      |      |      |      |      |      |    |    |    |    |    |    |    |          |    |    |    |    |    |    |    |          |  |  |  |  |  |  |  |
|                            | 40GE              | [Active] |      |      |      |      |        |        |       |       |        |        |      |      |      |      |      |      |    |    |    |    |    |    |    |          |    |    |    |    |    |    |    |          |  |  |  |  |  |  |  |
|                            | 50GE              | [Active] |      |      |      |      |        |        |       |       |        |        |      |      |      |      |      |      |    |    |    |    |    |    |    |          |    |    |    |    |    |    |    |          |  |  |  |  |  |  |  |
|                            | 100GE             | [Active] |      |      |      |      |        |        |       |       |        |        |      |      |      |      |      |      |    |    |    |    |    |    |    |          |    |    |    |    |    |    |    |          |  |  |  |  |  |  |  |
|                            | 4x8GFC**          | [Active] |      |      |      |      |        |        |       |       |        |        |      |      |      |      |      |      |    |    |    |    |    |    |    | [Active] |    |    |    |    |    |    |    | [Active] |  |  |  |  |  |  |  |
|                            | 2x16GFC**         | [Active] |      |      |      |      |        |        |       |       |        |        |      |      |      |      |      |      |    |    |    |    |    |    |    | [Active] |    |    |    |    |    |    |    | [Active] |  |  |  |  |  |  |  |
| <b>Profile-4</b>           | 4x16GFC**         | [Active] |      |      |      |      |        |        |       |       |        |        |      |      |      |      |      |      |    |    |    |    |    |    |    | [Active] |    |    |    |    |    |    |    | [Active] |  |  |  |  |  |  |  |
|                            | 1x32GFC           | [Active] |      |      |      |      |        |        |       |       |        |        |      |      |      |      |      |      |    |    |    |    |    |    |    | [Active] |    |    |    |    |    |    |    | [Active] |  |  |  |  |  |  |  |
|                            | 1GE/10GE          | [Active] |      |      |      |      |        |        |       |       |        |        |      |      |      |      |      |      |    |    |    |    |    |    |    |          |    |    |    |    |    |    |    |          |  |  |  |  |  |  |  |
|                            | 25GE              | [Active] |      |      |      |      |        |        |       |       |        |        |      |      |      |      |      |      |    |    |    |    |    |    |    |          |    |    |    |    |    |    |    |          |  |  |  |  |  |  |  |
|                            | 40GE              | [Active] |      |      |      |      |        |        |       |       |        |        |      |      |      |      |      |      |    |    |    |    |    |    |    |          |    |    |    |    |    |    |    |          |  |  |  |  |  |  |  |
|                            | 50GE              | [Active] |      |      |      |      |        |        |       |       |        |        |      |      |      |      |      |      |    |    |    |    |    |    |    |          |    |    |    |    |    |    |    |          |  |  |  |  |  |  |  |

\*`profile-1` and `profile-2` activate the same port mode capability on unified and Ethernet ports. The difference is that in `profile-1`, by default SFP+ unified ports 1-24 come up in Fibre Channel mode with 2x16GFC breakouts per port group. In `profile-2`, by default SFP+ unified ports 1-24 come up in Ethernet 10GE mode. `profile-1` allows you to connect FC devices for plug-and-play; `profile-2` is designed for a standard Ethernet-based data network.

\*\***Oversubscription:** Configure oversubscription to support bursty storage traffic on a Fibre Channel interface. Oversubscription allows a port to operate faster, but may result in traffic loss. To support oversubscription, use the `speed` command in Interface Configuration mode. This command is not supported on an Ethernet interface. In S4148U-ON port profiles:

- SFP+ and QSFP28 port groups in 4x8GFC mode support 16GFC oversubscription on member interfaces.
- QSFP28 ports in 2x16GFC mode support 32GFC oversubscription. SFP+ port groups in 2x16GFC mode do not support 32GFC oversubscription. 2x16GFC mode activates subports 1 and 3.
- QSFP28 ports in 4x16GFC mode support 32GFC oversubscription.

### Breakout interfaces:

- To configure breakout interfaces on a unified port, use the `mode {FC | Eth}` command in Port-Group Configuration mode. The `mode {FC | Eth}` command configures a unified port to operate at line rate and guarantees no traffic loss.
- To configure breakout interfaces on a QSFP+ Ethernet port, use the `interface breakout` command in global Configuration mode.

**1GE mode:** Only SFP+ ports support 1GE; QSFP+ and QSFP28 ports 25 to 30 do not support 1GE.

To view the ports that belong to each port group, use the `show port-group` command.

## Configure negotiation modes on interfaces

On OS10, the `auto` negotiation mode is enabled by default.

To force negotiation, use the following command:

```
negotiation on
```

To disable negotiation, use the following command:

```
negotiation off
```

To reset the negotiation mode to the default setting of the media you use, use one of the following commands:

```
negotiation auto
```

```
no negotiation
```

The following examples show that the nondefault configuration is added to the running configuration:

```
OS10(conf-if-eth1/1/50)# negotiation off
OS10(conf-if-eth1/1/50)# show configuration
!
interface ethernet1/1/50
 no shutdown
 switchport access vlan 1
 negotiation off
 flowcontrol receive on
OS10(conf-if-eth1/1/50)# negotiation on
OS10(conf-if-eth1/1/50)# show configuration
!
interface ethernet1/1/50
 no shutdown
 switchport access vlan 1
 negotiation on
 flowcontrol receive on
```

The following examples show that the default configuration is not added to the running configuration:

```
OS10(conf-if-eth1/1/50)# negotiation auto
OS10(conf-if-eth1/1/50)# show configuration
!
interface ethernet1/1/50
 no shutdown
 switchport access vlan 1
 flowcontrol receive on
```

The following example shows that the `no negotiation` command resets the interface to the default setting of the media used.

```
OS10(conf-if-eth1/1/50)# no negotiation
OS10(conf-if-eth1/1/50)# show configuration
!
interface ethernet1/1/50
 no shutdown
 switchport access vlan 1
 flowcontrol receive on
OS10(conf-if-eth1/1/50)# do show interface ethernet 1/1/50
Ethernet 1/1/50 is up, line protocol is up
Hardware is Eth, address is e4:f0:04:3e:2d:86
 Current address is e4:f0:04:3e:2d:86
Pluggable media present, QSFP28 type is QSFP28 100GBASE-CR4-2.0M
 Wavelength is 64
 Receive power reading is not available

Interface index is 112
Internet address is not set
Mode of IPv4 Address Assignment: not set
Interface IPv6 oper status: Disabled
MTU 1532 bytes, IP MTU 1500 bytes
LineSpeed 100G, Auto-Negotiation on
```

### Configuration notes

1G auto negotiation is not supported on platforms such as Z9100, Z9264F, S52xx, Z9332F, S41xx, MX series, and S42xx that supports native 100G (QSFP28) ports.

# Configure breakout mode

Using a supported breakout cable, you can split a 40GE QSFP+ or 100GE QSFP28 Ethernet port into separate breakout interfaces. All breakout interfaces have the same speed. You can set a QSFP28 port to operate in 40GE mode with a QSFP+ transceiver.

```
interface breakout node/slot/port map {10g-4x | 25g-4x | 40g-1x | 50g-2x | 100g-1x}
```

- *node/slot/port* — Enter the physical port information.
- 10g-4x — Split a QSFP28 or QSFP+ port into four 10G interfaces.
- 25g-4x — Split a QSFP28 port into four 25G interfaces.
- 40g-1x — Set a QSFP28 port to use with a QSFP+ 40G transceiver.
- 50g-2x — Split a QSFP28 port into two 50G interfaces.
- 100g-1x — Reset a QSFP28 port to 100G speed.

To configure an Ethernet breakout interface, use the `interface ethernet node/slot/port:subport` command in CONFIGURATION mode.

Each breakout interface operates at the configured speed. Use the `no` version of the `interface breakout` command to reset a port to its default speed: 40G or 100G.

To configure breakout interfaces on a unified port, use the `mode {Eth | FC}` command in Port-Group Configuration mode.

 **NOTE:** You cannot configure the 40G ports 13, 14, 15, 16, 29, 30, 31, and 32 to split into four 10G interfaces on the S6010 platform.

## Configure interface breakout

```
OS10(config)# interface breakout 1/1/7 map 10g-4x
```

## Display interface breakout

```
OS10# show interface status
```

| Port        | Description | Status | Speed | Duplex | Mode | Vlan | Tagged-Vlans |
|-------------|-------------|--------|-------|--------|------|------|--------------|
| Eth 1/1/1   |             | down   | 0     | auto   | -    |      |              |
| Eth 1/1/2   |             | down   | 0     | auto   | A    | 1    | -            |
| Eth 1/1/7:1 |             | down   | 0     | auto   | A    | 1    | -            |
| Eth 1/1/7:2 |             | down   | 0     | auto   | A    | 1    | -            |
| Eth 1/1/7:3 |             | down   | 0     | auto   | A    | 1    | -            |
| Eth 1/1/7:4 |             | down   | 0     | auto   | A    | 1    | -            |
| Eth 1/1/25  |             | down   | 0     | auto   | A    | 1    | -            |

## Breakout Mode Restrictions

On the S5232F-ON switch, port 32 alone cannot be split into 10x4 or 25x4. Supported breakout modes for port 32 are:

- 100G-1x Breakout to 1 100G interface
- 50G-2x Breakout to 2 50G interfaces
- 40G-1x Breakout to 1 40G interface

# Breakout auto-configuration

You can globally enable front-panel Ethernet ports to automatically detect SFP pluggable media in a QSFP+ or QSFP28 port. The port autoconfigures breakout interfaces for media type and speed. For example, if you plug a 40G direct attach cable (DAC) with 4x10G far-side transceivers into a QSFP28 port, the port autoconfigures in 10g-4x Interface-breakout mode.

RJ-45 ports and ports that are members of a port group do not support breakout auto-configuration. Breakout auto-configuration is disabled by default.



## Enable breakout auto-configuration

```
OS10(config)# feature auto-breakout
```

## Display breakout auto-configuration

Before you plug a cable in Ethernet port 1/1/25:

```
OS10# show interface status
```

```

Port Description Status Speed Duplex Mode Vlan Tagged-Vlans

Eth 1/1/1 down 0 auto - - -
Eth 1/1/2 down 0 auto A 1 -
Eth 1/1/25 down 0 auto A 1 -
Eth 1/1/29 down 0 auto A 1 -
```

After you enter `feature auto-breakout` and plug a breakout cable in Ethernet port 1/1/25:

```
OS10# show interface status
```

```

Port Description Status Speed Duplex Mode Vlan Tagged-Vlans

Eth 1/1/1 down 0 auto - - -
Eth 1/1/2 down 0 auto A 1 -
Eth 1/1/25:1 down 0 auto A 1 -
Eth 1/1/25:2 down 0 auto A 1 -
Eth 1/1/25:3 down 0 auto A 1 -
Eth 1/1/25:4 down 0 auto A 1 -
Eth 1/1/29 down 0 auto A 1 -
```

# Reset default configuration

You can clear all configured settings on an Ethernet or Fibre Channel interface and reset the interface to its default settings. By default:

- An Ethernet interface is enabled, using the `no shutdown` command, and assigned to the default VLAN.
- A Fibre Channel interface is disabled, using the `shutdown` command.

## Restrictions

The `default interface` command removes all software settings and all L3, VLAN, and port-channel configurations on a port interface. However, the command does not remove configurations to the interface from other software features, such as VLT. If you do not remove these configured settings, the command does not execute. For example, if you configure an Ethernet interface as a discovery interface in a VLT domain and you do not delete this setting, resetting the interface to its default configuration fails:

```
OS10(config)# vlt-domain 10
OS10(conf-vlt-10)# discovery-interface ethernet 1/1/1
OS10(conf-vlt-10)# exit
OS10(config)# default interface ethernet 1/1/1
Proceed to cleanup the interface config? [confirm yes/no]:y
% Error: Discovery Interface mode must not be in switchport mode
```

## Configuration

1. From CONFIGURATION mode, enter INTERFACE mode and view the currently configured settings.

```
interface {ethernet | fibrechannel} node/slot/port[:subport]
show config
```

2. Return to CONFIGURATION mode.

```
exit
```

3. Reset an interface to its default configuration in CONFIGURATION mode. Enter multiple interfaces in a comma-separated string or a port range using the default interface range command.

```
default interface {ethernet | fibrechannel} node/slot/port[:subport]
```

4. Enter INTERFACE mode and verify the factory-default configuration.

```
interface {ethernet | fibrechannel} node/slot/port[:subport]
show config
```

### Reset default Ethernet configuration

```
OS10(conf-if-eth1/1/2)# show configuration
!
interface ethernet 1/1/2
no shutdown
no switchport
negotiation on
ip address 1.2.3.4/24
ip address 2.2.2.2/24 secondary
ip address 3.3.3.3/24 secondary
ipv6 address 10::1/64
ip access-group test in
lldp med network-policy add 10
ip ospf priority 10
flowcontrol transmit on

OS10(conf-if-eth1/1/2)# exit
S10(config)# default interface ethernet 1/1/2
Proceed to cleanup the interface config? [confirm yes/no]:y
Sep 9 01:06:28 OS10 dn_13_core_services[968]: Node.1-Unit.1:PRI:notice [os10:trap],
%Dell EMC (OS10) %IP_ADDRESS_DEL: IP Address delete is successful. IP 2.2.2.2/24 deleted
successfully
Sep 9 01:06:28 OS10 dn_13_core_services[968]: Node.1-Unit.1:PRI:notice [os10:trap],
%Dell EMC (OS10) %IP_ADDRESS_DEL: IP Address delete is successful. IP 3.3.3.3/24 deleted
successfully
Sep 9 01:06:28 OS10 dn_13_core_services[968]: Node.1-Unit.1:PRI:notice [os10:trap],
%Dell EMC (OS10) %IP_ADDRESS_DEL: IP Address delete is successful. IP 1.2.3.4/24 deleted
successfully
Sep 9 01:06:28 OS10 dn_13_core_services[968]: Node.1-Unit.1:PRI:notice [os10:trap],
%Dell EMC (OS10) %IP_ADDRESS_DEL: IP Address delete is successful. IP 10::1/64 deleted
successfully

OS10(config)# do show running-configuration interface ethernet 1/1/2
!
interface ethernet1/1/2
no shutdown
switchport access vlan 1
```

### Reset default Fibre Channel configuration

```
OS10# show running-configuration interface fibrechannel 1/1/1
!
interface fibrechannel1/1/1
no shutdown
description fc-port

OS10(conf-if-fc1/1/1)# exit
OS10(config)# default interface fc1/1/1
Proceed to cleanup the interface config? [confirm yes/no]:y
!
OS10(config)# do show running-configuration interface fibrechannel 1/1/1
interface fibrechannel1/1/1
shutdown
```

## Forward error correction

Forward error correction (FEC) enhances data reliability.

### FEC modes supported in OS10:

- CL74-FC — Supports 25G and 50G
- CL91-RS — Supports 100G
- CL108-RS — Supports 25G and 50G
- off — Disables FEC

 **NOTE:** OS10 does not support FEC on 10G and 40G.

### Configure FEC

```
OS10(config)# interface ethernet 1/1/41
OS10(conf-if-eth1/1/41)# fec CL91-RS
```

### View FEC configuration

```
OS10# show interface ethernet 1/1/41
Ethernet 1/1/41 is up, line protocol is up
Hardware is Dell EMC Eth, address is e4:f0:04:3e:1a:06
 Current address is e4:f0:04:3e:1a:06
Pluggable media present, QSFP28 type is QSFP28_100GBASE_CR4_2M
 Wavelength is 64
 Receive power reading is
Interface index is 17306108
Internet address is not set
Mode of IPv4 Address Assignment: not set
Interface IPv6 oper status: Disabled
MTU 1532 bytes, IP MTU 1500 bytes
LineSpeed 100G, Auto-Negotiation on
FEC is cl91-rs, Current FEC is cl91-rs
Flowcontrol rx off tx off
ARP type: ARPA, ARP Timeout: 60
Last clearing of "show interface" counters: 00:00:17
Queuing strategy: fifo
Input statistics:
 7 packets, 818 octets
 2 64-byte pkts, 0 over 64-byte pkts, 5 over 127-byte pkts
 0 over 255-byte pkts, 0 over 511-byte pkts, 0 over 1023-byte pkts
 7 Multicasts, 0 Broadcasts, 0 Unicasts
 0 runts, 0 giants, 0 throttles
 0 CRC, 0 overrun, 0 discarded
Output statistics:
 15 packets, 1330 octets
 10 64-byte pkts, 0 over 64-byte pkts, 5 over 127-byte pkts
 0 over 255-byte pkts, 0 over 511-byte pkts, 0 over 1023-byte pkts
 15 Multicasts, 0 Broadcasts, 0 Unicasts
 0 throttles, 0 discarded, 0 Collisions, 0 wred drops
Rate Info(interval 30 seconds):
 Input 0 Mbits/sec, 0 packets/sec, 0% of line rate
 Output 0 Mbits/sec, 0 packets/sec, 0% of line rate
Time since last interface status change: 00:00:13
--more--
```

## Energy-efficient Ethernet

Energy-efficient Ethernet (EEE) reduces power consumption of physical layer devices (PHYs) during idle periods. EEE allows Dell EMC Networking devices to conform to green computing standards.

An Ethernet link consumes power when a link is idle. EEE allows Ethernet links to use Regular Power mode only during data transmission. EEE is enabled on devices that support LOW POWER IDLE (LPI) mode. Such devices save power by entering LPI mode during periods when no data is transmitting.

In LPI mode, systems on both ends of the link saves power by shutting down certain services. EEE transitions into and out of LPI mode transparently to upper-layer protocols and applications.

EEE advertises during the auto-negotiation stage. Auto-negotiation detects abilities supported by the device at the other end of the link, determines common abilities, and configures joint operation.

Auto-negotiation performs at power-up, on command from the LAN controller, on detection of a PHY error, or following Ethernet cable re-connection. During the link establishment process, both link partners indicate their EEE capabilities. If EEE is supported by both link partners for the negotiated PHY type, EEE functions independently in either direction.

Changing the EEE configuration resets the interface because the device restarts Layer 1 auto-negotiation. You may want to enable Link Layer Discovery Protocol (LLDP) for devices that require longer wake-up times before they are able to accept data on their receive paths. Doing so enables the device to negotiate extended system wake-up times from the transmitting link partner.

 **NOTE:** The EEE feature is applicable only for Base-T switches.

## Enable energy-efficient Ethernet

EEE is disabled by default. To reduce power consumption, enable EEE.

1. Enter the physical Ethernet interface information in CONFIGURATION mode.

```
interface ethernet node/slot/port[:subport]
```

2. Enable EEE in INTERFACE mode.

```
eee
```

### Enable EEE

```
OS10(config)# interface ethernet 1/1/1
OS10(conf-if-eth1/1/1)# eee
```

### Disable EEE

```
OS10(config)# interface ethernet 1/1/1
OS10(conf-if-eth1/1/1)# no eee
```

## Clear EEE counters

You can clear EEE counters on physical Ethernet interfaces globally or per interface.

### Clear all EEE counters

```
OS10# clear counters interface eee
Clear all eee counters [confirm yes/no]:yes
```

### Clear counters for specific interface

```
OS10# clear counters interface 1/1/48 eee
Clear eee counters on ethernet1/1/48 [confirm yes/no]:yes
```

## View EEE status/statistics

You can view the EEE status or statistics for a specified interface, or all interfaces, using the `show` commands.

### View EEE status for a specified interface

```
OS10# show interface ethernet 1/1/48 eee

Port EEE Status Speed Duplex

Eth 1/1/48 on up 1000M
```

### View EEE status on all interfaces

```
OS10# show interface eee
```

| Port       | EEE | Status | Speed | Duplex |
|------------|-----|--------|-------|--------|
| Eth 1/1/1  | off | up     | 1000M |        |
| ...        |     |        |       |        |
| Eth 1/1/47 | on  | up     | 1000M |        |
| Eth 1/1/48 | on  | up     | 1000M |        |
| Eth 1/1/49 | n/a |        |       |        |
| Eth 1/1/50 | n/a |        |       |        |
| Eth 1/1/51 | n/a |        |       |        |
| Eth 1/1/52 | n/a |        |       |        |

### View EEE statistics for a specified interface

```
OS10# show interface ethernet 1/1/48 eee statistics
Eth 1/1/48
 EEE : on
 TxIdleTime(us) : 2560
 TxWakeTime(us) : 5
 Last Clearing : 18:45:53
 TxEventCount : 0
 TxDuration(us) : 0
 RxEventCount : 0
 RxDuration(us) : 0
```

### View EEE statistics on all interfaces

```
OS10# show interface eee statistics
```

| Port       | EEE | TxEventCount | TxDuration(us) | RxEventCount | RxDuration(us) |
|------------|-----|--------------|----------------|--------------|----------------|
| Eth 1/1/1  | off | 0            | 0              | 0            | 0              |
| ...        |     |              |                |              |                |
| Eth 1/1/47 | on  | 0            | 0              | 0            | 0              |
| Eth 1/1/48 | on  | 0            | 0              | 0            | 0              |
| Eth 1/1/49 | n/a |              |                |              |                |
| ...        |     |              |                |              |                |
| Eth 1/1/52 | n/a |              |                |              |                |

## EEE commands

### clear counters interface eee

Clears all EEE counters.

**Syntax** clear counters interface eee

**Parameters** None

**Default** Not configured

**Command Mode** EXEC

**Usage** None

**Information**

**Example**

```
OS10# clear counters interface eee
Clear all eee counters [confirm yes/no]:yes
```

**Supported Releases** 10.3.0E or later

## clear counters interface ethernet eee

Clears EEE counters on a specified Ethernet interface.

**Syntax** `clear counters interface ethernet node/slot/port[:subport] eee`

**Parameters** `node/slot/port[:subport]`—Enter the interface information.

**Default** Not configured

**Command Mode** EXEC

**Usage Information** None

### Example

```
OS10# clear counters interface 1/1/48 eee
Clear eee counters on ethernet1/1/48 [confirm yes/no]:yes
```

**Supported Releases** 10.3.0E or later

## eee

Enables or disables energy-efficient Ethernet (EEE) on physical ports.

**Syntax** `eee`

**Parameters** None

**Default** Enabled on Base-T devices and disabled on S3048-ON and S4048T-ON switches.

**Command Mode** Interface

**Usage Information** To disable EEE, use the `no` version of this command.

### Example (Enable EEE)

```
OS10(config)# interface ethernet 1/1/1
OS10(config-if-eth1/1/1)# eee
```

### Example (Disable EEE)

```
OS10(config)# interface ethernet 1/1/2
OS10(config-if-eth1/1/2)# no eee
```

**Supported Releases** 10.3.0E or later

## show interface eee

Displays the EEE status for all interfaces.

**Syntax** `show interface eee`

**Parameters** None

**Default** Not configured

**Command Mode** EXEC

### Example

```
OS10# show interface eee

Port EEE Status Speed Duplex

Eth 1/1/1 off up 1000M
...
Eth 1/1/47 on up 1000M
Eth 1/1/48 on up 1000M
```

```
Eth 1/1/49 n/a
Eth 1/1/50 n/a
Eth 1/1/51 n/a
Eth 1/1/52 n/a
```

**Supported Releases** 10.3.0E or later

## show interface eee statistics

Displays EEE statistics for all interfaces.

**Syntax** `show interface eee statistics`

**Parameters** None

**Default** Not configured

**Command Mode** EXEC

**Example**

```
OS10# show interface eee statistics

Port EEE TxEventCount TxDuration(us) RxEventCount RxDuration(us)

Eth 1/1/1 off 0 0 0 0
...
Eth 1/1/47 on 0 0 0 0
Eth 1/1/48 on 0 0 0 0
Eth 1/1/49 n/a
...
Eth 1/1/52 n/a
```

**Supported Releases** 10.3.0E or later

## show interface ethernet eee

Displays the EEE status for a specified interface.

**Syntax** `show interface ethernet node/slot/port[:subport] eee`

**Parameters** `node/slot/port[:subport]`—Enter the interface information.

**Default** Not configured

**Command Mode** EXEC

**Example**

```
OS10# show interface ethernet 1/1/48 eee

Port EEE Status Speed Duplex

Eth 1/1/48 on up 1000M
```

**Supported Releases** 10.3.0E or later

## show interface ethernet eee statistics

Displays EEE statistics for a specified interface.

**Syntax** `show interface ethernet node/slot/port[:subport] eee statistics`

**Parameters** `node/slot/port[:subport]`—Enter the interface information.

**Default** Not configured

**Command Mode** EXEC

**Example**

```
OS10# show interface ethernet 1/1/48 eee statistics
Eth 1/1/48
 EEE : on
 TxIdleTime(us) : 2560
 TxWakeTime(us) : 5
 Last Clearing : 18:45:53
 TxEventCount : 0
 TxDuration(us) : 0
 RxEventCount : 0
 RxDuration(us) : 0
```

**Supported Releases** 10.3.0E or later

## View interface configuration

To view basic interface information, use the `show interface`, `show running-configuration`, and `show interface status` commands. Stop scrolling output from a `show` command by entering CTRL+C. Display information about a physical or virtual interface in EXEC mode, including up/down status, MAC and IP addresses, and input/output traffic counters.

```
show interface [type]
```

- `phy-eth node/slot/port[:subport]` — Display information about physical media connected to the interface.
- `status` — Display interface status.
- `ethernet node/slot/port[:subport]` — Display Ethernet interface information.
- `loopback id` — Display Loopback interface information, from 0 to 16383.
- `mgmt node/slot/port` — Display Management interface information.
- `port-channel id-number` — Display port-channel interface information, from 1 to 128.
- `vlan vlan-id` — Display the VLAN interface information, from 1 to 4093.

### View interface information

```
OS10# show interface
Ethernet 1/1/1 is up, line protocol is down
Hardware is Eth, address is 00:0c:29:66:6b:90
 Current address is 00:0c:29:66:6b:90
Pluggable media present, QSFP+ type is QSFP+ 40GBASE CR4
 Wavelength is 64
 Receive power reading is 0.000000 dBm
Interface index is 15
Internet address is not set
Mode of IPv4 Address Assignment: not set
Interface IPv6 oper status: Enabled
MTU 1532 bytes, IP MTU 1500 bytes
LineSpeed 0, Auto-Negotiation on
Configured FEC is off, Negotiated FEC is off
Flowcontrol rx off tx off
ARP type: ARPA, ARP Timeout: 60
Last clearing of "show interface" counters: 02:46:35
Queuing strategy: fifo
Input statistics:
 0 packets, 0 octets
 0 64-byte pkts, 0 over 64-byte pkts, 0 over 127-byte pkts
 0 over 255-byte pkts, 0 over 511-byte pkts, 0 over 1023-byte pkts
 0 Multicasts, 0 Broadcasts, 0 Unicasts
 0 runts, 0 giants, 0 throttles
 0 CRC, 0 overrun, 0 discarded
Output statistics:
 0 packets, 0 octets
 0 64-byte pkts, 0 over 64-byte pkts, 0 over 127-byte pkts
 0 over 255-byte pkts, 0 over 511-byte pkts, 0 over 1023-byte pkts
 0 Multicasts, 0 Broadcasts, 0 Unicasts
```



```

 0 throttles, 0 discarded, 0 Collisions, 0 wred drops
Rate Info(interval 30 seconds):
 Input 0 Mbits/sec, 0 packets/sec, 0% of line rate
 Output 0 Mbits/sec, 0 packets/sec, 0% of line rate
Time since last interface status change: 02:46:36

Ethernet 1/1/2 is up, line protocol is up
Hardware is Eth, address is 00:0c:29:66:6b:94
 Current address is 00:0c:29:66:6b:94
Pluggable media present, QSFP+ type is QSFP+ 40GBASE CR4
 Wavelength is 64
 Receive power reading is 0.000000 dBm
Interface index is 17
Internet address is not set
Mode of IPv4 Address Assignment: not set
Interface IPv6 oper status: Enabled
Link local IPv6 address: fe80::20c:29ff:fe66:6b94/64
MTU 1532 bytes, IP MTU 1500 bytes
LineSpeed 40G, Auto-Negotiation on
Configured FEC is off, Negotiated FEC is off
Flowcontrol rx off tx off
ARP type: ARPA, ARP Timeout: 60
Last clearing of "show interface" counters: 02:46:35
Queuing strategy: fifo
Input statistics:
 0 packets, 0 octets
 0 64-byte pkts, 0 over 64-byte pkts, 0 over 127-byte pkts
 0 over 255-byte pkts, 0 over 511-byte pkts, 0 over 1023-byte pkts
 0 Multicasts, 0 Broadcasts, 0 Unicasts
 0 runts, 0 giants, 0 throttles
 0 CRC, 0 overrun, 0 discarded
Output statistics:
 0 packets, 0 octets
 0 64-byte pkts, 0 over 64-byte pkts, 0 over 127-byte pkts
 0 over 255-byte pkts, 0 over 511-byte pkts, 0 over 1023-byte pkts
 0 Multicasts, 0 Broadcasts, 0 Unicasts
 0 throttles, 0 discarded, 0 Collisions, 0 wred drops
Rate Info(interval 30 seconds):
 Input 0 Mbits/sec, 0 packets/sec, 0% of line rate
 Output 0 Mbits/sec, 0 packets/sec, 0% of line rate
Time since last interface status change: 02:46:35
--more--

```

### View specific interface information

```

OS10(config)# interface ethernet 1/1/1
OS10(conf-if-eth1/1/1)# show configuration
!
interface ethernet1/1/1
 ip address 1.1.1.1/24
 no switchport
 no shutdown

```

### View candidate configuration

```

OS10(conf-if-eth1/1/1)# show configuration candidate
!
interface ethernet1/1/1
 ip address 1.1.1.1/24
 no switchport
 no shutdown

```

### View running configuration

```

OS10# show running-configuration
Current Configuration ...
!
interface ethernet1/1/1
 no ip address
 shutdown
!

```

```

interface ethernet1/1/2
 no ip address
 shutdown
!
interface ethernet1/1/3
 no ip address
 shutdown
!
interface ethernet1/1/4
 no ip address
 shutdown
...

```

### View L3 interfaces

```
OS10# show ip interface brief
```

| Interface Name   | IP-Address       | OK  | Method | Status | Protocol |
|------------------|------------------|-----|--------|--------|----------|
| Ethernet 1/1/1   | unassigned       | NO  | unset  | up     | down     |
| Ethernet 1/1/2   | unassigned       | YES | unset  | up     | up       |
| Ethernet 1/1/3   | 3.1.1.1/24       | YES | manual | up     | up       |
| Ethernet 1/1/4   | 4.1.1.1/24       | YES | manual | up     | up       |
| Ethernet 1/1/5   | unassigned       | NO  | unset  | up     | down     |
| Ethernet 1/1/6   | unassigned       | NO  | unset  | up     | down     |
| Ethernet 1/1/7   | unassigned       | NO  | unset  | up     | down     |
| Ethernet 1/1/8   | unassigned       | NO  | unset  | up     | down     |
| Ethernet 1/1/9   | unassigned       | NO  | unset  | up     | down     |
| Ethernet 1/1/10  | unassigned       | NO  | unset  | up     | down     |
| Ethernet 1/1/11  | unassigned       | NO  | unset  | up     | down     |
| Ethernet 1/1/12  | unassigned       | NO  | unset  | up     | down     |
| Ethernet 1/1/13  | unassigned       | NO  | unset  | up     | down     |
| Ethernet 1/1/14  | unassigned       | NO  | unset  | up     | down     |
| Ethernet 1/1/15  | unassigned       | NO  | unset  | up     | down     |
| Ethernet 1/1/16  | unassigned       | NO  | unset  | up     | down     |
| Ethernet 1/1/17  | unassigned       | NO  | unset  | up     | down     |
| Ethernet 1/1/18  | unassigned       | NO  | unset  | up     | down     |
| Ethernet 1/1/19  | unassigned       | NO  | unset  | up     | down     |
| Ethernet 1/1/20  | unassigned       | NO  | unset  | up     | down     |
| Ethernet 1/1/21  | unassigned       | NO  | unset  | up     | down     |
| Ethernet 1/1/22  | unassigned       | NO  | unset  | up     | down     |
| Ethernet 1/1/23  | unassigned       | NO  | unset  | up     | down     |
| Ethernet 1/1/24  | unassigned       | NO  | unset  | up     | down     |
| Ethernet 1/1/25  | unassigned       | NO  | unset  | up     | down     |
| Ethernet 1/1/26  | unassigned       | NO  | unset  | up     | down     |
| Ethernet 1/1/27  | unassigned       | NO  | unset  | up     | down     |
| Ethernet 1/1/28  | unassigned       | NO  | unset  | up     | down     |
| Ethernet 1/1/29  | unassigned       | NO  | unset  | up     | down     |
| Ethernet 1/1/30  | unassigned       | NO  | unset  | up     | down     |
| Ethernet 1/1/31  | unassigned       | NO  | unset  | up     | down     |
| Ethernet 1/1/32  | unassigned       | NO  | unset  | up     | down     |
| Management 1/1/1 | 10.16.153.226/24 | YES | manual | up     | up       |
| Vlan 1           | unassigned       | NO  | unset  | up     | down     |
| Vlan 10          | unassigned       | NO  | unset  | up     | down     |
| Vlan 20          | unassigned       | NO  | unset  | up     | down     |
| Vlan 30          | unassigned       | NO  | unset  | up     | down     |

### View VLAN configuration

```
OS10# show vlan
Codes: * - Default VLAN, M - Management VLAN, R - Remote Port Mirroring VLANs,
 @ - Attached to Virtual Network
Q: A - Access (Untagged), T - Tagged
```

| NUM | Status   | Description | Q Ports                 |
|-----|----------|-------------|-------------------------|
| 1   | Inactive |             | A Eth1/1/1,1/1/6-1/1/32 |
| 10  | Inactive |             |                         |
| 20  | Inactive |             |                         |
| 22  | Inactive |             |                         |
| 23  | Active   |             | A Eth1/1/2              |
| 24  | Inactive |             |                         |
| 25  | Inactive |             |                         |
| 26  | Inactive |             |                         |
| 27  | Inactive |             |                         |

```

28 Inactive
29 Inactive
30 Inactive

```

### Configuration notes

All Dell EMC PowerSwitches except MX-Series:

OS 10.5.1.0 allows you to configure Interface names with upper case characters, but the Interface is not programmed correctly. To ensure proper configuration, always use lower case to configure Interface names.

```

Examples:
OS10(Config)# interface vlan20
OS10(Config)# interface port-channel20

```

## Digital optical monitoring

The digital optical monitoring (DOM) feature monitors the digital optical media for temperature, voltage, bias, transmission power (Tx), and reception power (Rx). This feature also generates event logs, alarms, and traps for any fluctuations, when configured thresholds are reached.

There are four threshold levels for each of the DOM categories—temperature, voltage, bias, transmission power, and reception power as summarized in the following table:

- High
- High warning
- Low
- Low warning

The OS10 DOM subsystem periodically monitors the optical transceivers for temperature, voltage, bias, transmission power and reception power changes and generate event logs, alarms, and traps when their respective values cross the predefined thresholds.

**Table 16. DOM Alarms**

| Alarm Category          | Alarm Name               | Traps Generated? | Severity Level |
|-------------------------|--------------------------|------------------|----------------|
| Temperature             | Temperature high         | Y                | Major          |
|                         | Temperature high warning | N                | Minor          |
|                         | Temperature low          | Y                | Major          |
|                         | Temperature low warning  | N                | Minor          |
| Voltage                 | Voltage high             | Y                | Major          |
|                         | Voltage high warning     | N                | Minor          |
|                         | Voltage low              | Y                | Major          |
|                         | Voltage low warning      | N                | Minor          |
| Bias                    | Bias high                | Y                | Major          |
|                         | Bias high warning        | N                | Minor          |
|                         | Bias low                 | Y                | Major          |
|                         | Bias low warning         | N                | Minor          |
| Power transmission (Tx) | Tx high                  | Y                | Major          |
|                         | Tx high warning          | N                | Minor          |
|                         | Tx low                   | Y                | Major          |
|                         | Tx low warning           | N                | Minor          |

**Table 16. DOM Alarms (continued)**

| Alarm Category       | Alarm Name      | Traps Generated? | Severity Level |
|----------------------|-----------------|------------------|----------------|
| Power reception (Rx) | Rx high         | Y                | Major          |
|                      | Rx high warning | N                | Minor          |
|                      | Rx low          | Y                | Major          |
|                      | Rx low warning  | N                | Minor          |

You can enable or disable the DOM feature, configure traps, and view the DOM status.

## Enable DOM and DOM traps

To generate DOM alarms, do the following.

1. Enable DOM.

```
OS10(config)# dom enable
```

2. Enable DOM traps.

```
OS10(config)# snmp-server enable traps dom
```

You can run the `show alarms` command in EXEC mode to view any alarms that are generated.

### View DOM alarms

```
OS10# show alarms
```

| Index | Severity | Name                | Raise-time              | Source        |
|-------|----------|---------------------|-------------------------|---------------|
| 0     | major    | EQM_MEDIA_TEMP_HIGH | Tue 06-04-2019 12:32:07 | Node.1-Unit.1 |

### View DOM event log message

The following are examples of event logs:

- High temperature warning:

```
Aug 03 06:35:47 OS10 dn_eqm[9135]: [os10:alarm], %Dell EMC (OS10)
%EQM_MEDIA_TEMP_HIGH: Media high temperature threshold crossed major warning
SET media 1/1/21 high threshold crossed, 82.00:78.00 Aug 03 06:35:47 OS10
dn_eqm[9135]: [os10:alarm], %Dell EMC (OS10) %EQM_MEDIA_VOLTAGE_HIGH: Media high
voltage threshold crossed major warning SET media 1/1/21 high threshold crossed,
6.00:3.63
```

In this example, the threshold for high temperature is 78.00, but the current temperature is 82.00.

- High reception power warning:

```
Aug 03 06:35:47 OS10 dn_eqm[9135]: [os10:alarm], %Dell EMC (OS10)
%EQM_MEDIA_RX_POWER_HIGH: Media high rx_power threshold crossed major warning
SET media 1/1/21 high threshold crossed, 7.00:3.30 Aug 03 06:35:47 OS10
dn_eqm[9135]: [os10:alarm], %Dell EMC (OS10) %EQM_MEDIA_BIAS_HIGH: Media high
bias threshold crossed major warning SET media 1/1/21 high threshold crossed,
120.00:105.00
```

In this example, the threshold for high reception power is 3.30, but the current reception power is 7.00.

### View DOM traps

The following are examples of DOM traps.

```
2018-08-21 17:38:18 <UNKNOWN> [UDP: [10.11.56.49]:51635->[10.11.86.108]:162]:
iso.3.6.1.2.1.1.3.0 = Timeticks: (0) 0:00:00.00 iso.3.6.1.6.3.1.1.4.1.0 = OID:
iso.3.6.1.4.1.674.11000.5000.100.4.1.3.1.15 iso.3.6.1.4.1.674.11000.5000.100.4.1.3.2.4 = INTEGER: 1
iso.3.6.1.4.1.674.11000.5000.100.4.1.3.2.5 = INTEGER: 21 iso.3.6.1.4.1.674.11000.5000.100.4.1.3.2.1 =
```

```
INTEGER: 1081393 iso.3.6.1.4.1.674.11000.5000.100.4.1.3.2.3 = INTEGER: 1
iso.3.6.1.4.1.674.11000.5000.100.4.1.3.2.2 = STRING: "SET media 1/1/21 high threshold crossed, 82.00:78.00"
```

```
2018-08-21 17:38:18 <UNKNOWN> [UDP: [10.11.56.49]:48521->[10.11.86.108]:162]:
iso.3.6.1.2.1.1.3.0 = Timeticks: (1) 0:00:00.01 iso.3.6.1.6.3.1.1.4.1.0 = OID:
iso.3.6.1.4.1.674.11000.5000.100.4.1.3.1.19
iso.3.6.1.4.1.674.11000.5000.100.4.1.3.2.3 = INTEGER: 1
iso.3.6.1.4.1.674.11000.5000.100.4.1.3.2.1 = INTEGER: 1081397
iso.3.6.1.4.1.674.11000.5000.100.4.1.3.2.4 = INTEGER: 1
iso.3.6.1.4.1.674.11000.5000.100.4.1.3.2.2 = STRING: "SET media 1/1/21 high threshold
crossed, 6.00:3.63" iso.3.6.1.4.1.674.11000.5000.100.4.1.3.2.5 = INTEGER: 21
```

## Default MTU Configuration

Maximum transmission unit (MTU) defines the largest packet size that an interface can transmit without fragmentation. The MTU of an interface determines whether to accept the packet ingress and egress in the switch. The interface drops any packet with size exceeding the MTU.

If you have not configured the MTU value for an interface, a default value of 1532 bytes is set automatically. Any packet exceeding this value is dropped. To build an MTU with higher value, configure the default MTU of the system to the required value.

You can use the following commands for MTU configuration:

- `default mtu <val>` - configure a custom MTU value to all the interfaces that do not have a user configured MTU.
- `no default mtu` - assign the system default value to interfaces with no custom MTU value.
- `show default mtu` - verify the default MTU value at the system level.
- `show interface` - view the current MTU set on the interface at the interface level. Configurations that are made at the interface level override the system default for that specific interface.

 **NOTE:** Configure the default MTU on the physical ports before configuring it on the VLAN interface.

The following examples show how to display and modify the default MTU using CLIs:

### Display the default MTU

```
OS10# show default mtu
Default MTU 1532 bytes
```

### System default with no user configuration

```
OS10# show interface ethernet 1/1/1
Ethernet 1/1/1 is up, line protocol is down
Hardware is Eth, address is 90:b1:1c:f4:ef:a0
 Current address is 90:b1:1c:f4:ef:a0
Pluggable media present, QSFP+ type is QSFP+ 40GBASE-LR4
 Wavelength is 1311
 Receive power reading is no power
Interface index is 11
Internet address is not set
Mode of IPv4 Address Assignment: not set
Interface IPv6 oper status: Disabled
MTU 1532 bytes, IP MTU 1500 bytes
LineSpeed 0, Auto-Negotiation off
Flowcontrol rx off tx off
ARP type: ARPA, ARP Timeout: 60
Last clearing of "show interface" counters: 20:45:24
Queuing strategy: fifo
Input statistics:
 0 packets, 0 octets
 0 64-byte pkts, 0 over 64-byte pkts, 0 over 127-byte pkts
 0 over 255-byte pkts, 0 over 511-byte pkts, 0 over 1023-byte pkts
 0 Multicasts, 0 Broadcasts, 0 Unicasts
 0 runts, 0 giants, 0 throttles
 0 CRC, 0 overrun, 0 discarded
Output statistics:
 0 packets, 0 octets
 0 64-byte pkts, 0 over 64-byte pkts, 0 over 127-byte pkts
```

```

0 over 255-byte pkts, 0 over 511-byte pkts, 0 over 1023-byte pkts
0 Multicasts, 0 Broadcasts, 0 Unicasts
0 throttles, 0 discarded, 0 Collisions, wred drops
Rate Info(interval seconds):
Input 0 Mbits/sec, 0 packets/sec, 0% of line rate
Output 0 Mbits/sec, 0 packets/sec, 0% of line rate
Time since last interface status change: 20:45:25

OS10# configure terminal
OS10(config)# default mtu 9000
OS10(config)#

```

## Interface commands

### channel-group

Assigns an interface to a port-channel group.

**Syntax** `channel-group channel-number mode {active | on | passive}`

- Parameters**
- *channel-number* — Enter a port-channel number, from 1 to 128.
  - *mode* — Sets LACP Actor mode.
  - *active* — Sets Channeling mode to Active.
  - *on* — Sets Channeling mode to static.
  - *passive* — Sets Channeling mode to passive.

**Default** Not configured

**Command Mode** INTERFACE

**Usage Information** The `no` version of this command resets the value to the default, and unassigns the interface from the port-channel group.

**Example**

```

OS10(config)# interface ethernet 1/1/2:1
OS10(conf-if-eth1/1/2:1)# channel-group 20 mode active

```

**Supported Releases** 10.3.0E or later

### default interface

Resets an Ethernet or Fibre Channel interface to its default settings.

**Syntax** `default interface interface-type`

**Parameters** *interface-type* — Enter the interface type:

- `ethernet node/slot/port[:subport]` — Resets an Ethernet interface to its default settings.
- `fibrechannel node/slot/port[:subport]` — Resets a Fibre Channel interface to its default settings.
- `range ethernet node/slot/port[:subport]-node/slot/port[:subport]` — Resets a range of Ethernet interfaces to their default settings.

**Default** Not configured

**Command mode** CONFIGURATION

**Usage information** To remove the configuration from an Ethernet or Fibre Channel interface and reset the interface to its default settings, use the `default interface` command. By default:

- An Ethernet interface is enabled using the `no shutdown` command; a Fibre Channel interface is disabled using the `shutdown` command.
- An Ethernet interface is assigned to the default VLAN.

The `default interface` command removes all software settings and all L3, VLAN, and port-channel configurations on a physical interface. You must manually remove configured links to the interface from other software features; for example, if you configure an Ethernet interface as a discovery interface in a VLT domain. Enter multiple interfaces in a comma-separated string or a port range using the `default interface range` command.

There is no undo for this command. The `no` version of the command has no effect.

### Example (Ethernet)

```
OS10# show running-configuration interface ethernet 1/1/15
!
interface ethernet1/1/15
no shutdown
no switchport
ip address 101.1.2.2/30
ipv6 address 2101:100:2:1::2/64
ipv6 ospf 65535 area 0.0.0.0
ipv6 ospf cost 10
ip ospf 65535 area 0.0.0.0
ip ospf cost 10

OS10# configure terminal

OS10(config)# default interface ethernet 1/1/15
Proceed to cleanup the interface config? [confirm yes/no]:yes
Mar 5 22:00:48 OS10 dn_l3_core_services[590]: Node.1-Unit.1:PRI:notice
[os10:trap], %Dell EMC (OS10) %log-notice:IP_ADDRESS_DEL: IP Address
delete is successful. IP 101.1.2.2/30 deleted successfully
Mar 5 22:00:48 OS10 dn_l3_core_services[590]: Node.1-Unit.1:PRI:notice
[os10:trap], %Dell EMC (OS10) %log-notice:IP_ADDRESS_DEL: IP Address
delete is successful. IP 2101:100:2:1::2/64 deleted successfully

OS10(config)# end

OS10# show running-configuration interface ethernet 1/1/15
!
interface ethernet1/1/15
no shutdown
switchport access vlan 1
```

### Example (Fibre channel)

```
OS10# show running-configuration interface fibrechannel 1/1/1
!
interface fibrechannel1/1/1
no shutdown
description fc-port

OS10(config)# default interface fibrechannel 1/1/1
Proceed to cleanup the interface config? [confirm yes/no]:y
!
OS10 # show running-configuration interface fibrechannel 1/1/1
interface fibrechannel1/1/1
shutdown
```

### Example (Range of interfaces)

```
OS10(config)# interface range ethernet 1/1/1-1/1/4
OS10(conf-range-eth1/1/1-1/1/4)# show configuration
!
interface ethernet1/1/1
no shutdown
no switchport
ip address 192.21.43.1/31
ipv6 address 2000:21:43::21:43:1/127
!
interface ethernet1/1/2
no shutdown
```

```

no switchport
!
interface ethernet1/1/3
no shutdown
no switchport
ip address 192.28.43.1/31
ipv6 address 2000:28:43::28:43:1/127
!
interface ethernet1/1/4
no shutdown
no switchport
ip address 192.41.43.1/31
ipv6 address 2000:41:43::41:43:1/127

OS10(conf-range-eth1/1/1-1/1/4)# exit

OS10(config)# default interface range ethernet 1/1/1,1/1/2-1/1/4

Proceed to cleanup interface range config? [confirm yes/no]:yes
Mar 5 22:21:12 OS10 dn_l3_core_services[590]: Node.1-Unit.1:PRI:notice
[os10:trap], %Dell EMC (OS10) %log-notice:IP_ADDRESS_DEL: IP Address
delete is successful. IP 192.21.43.1/31 deleted successfully
Mar 5 22:21:12 OS10 dn_l3_core_services[590]: Node.1-Unit.1:PRI:notice
[os10:trap], %Dell EMC (OS10) %log-notice:IP_ADDRESS_DEL: IP Address
delete is successful. IP 2000:21:43::21:43:1/127 deleted successfully
Mar 5 22:21:12 OS10 dn_l3_core_services[590]: Node.1-Unit.1:PRI:notice
[os10:trap], %Dell EMC (OS10) %log-notice:IP_ADDRESS_DEL: IP Address
delete is successful. IP 192.28.43.1/31 deleted successfully
Mar 5 22:21:12 OS10 dn_l3_core_services[590]: Node.1-Unit.1:PRI:notice
[os10:trap], %Dell EMC (OS10) %log-notice:IP_ADDRESS_DEL: IP Address
delete is successful. IP 2000:28:43::28:43:1/127 deleted successfully
Mar 5 22:21:12 OS10 dn_l3_core_services[590]: Node.1-Unit.1:PRI:notice
[os10:trap], %Dell EMC (OS10) %log-notice:IP_ADDRESS_DEL: IP Address
delete is successful. IP 192.41.43.1/31 deleted successfully
Mar 5 22:21:12 OS10 dn_l3_core_services[590]: Node.1-Unit.1:PRI:notice
[os10:trap], %Dell EMC (OS10) %log-notice:IP_ADDRESS_DEL: IP Address
delete is successful. IP 2000:41:43::41:43:1/127 deleted successfully
Mar 5 22:21:12 OS10 dn_ifm[602]: Node.1-Unit.1:PRI:notice [os10:trap],
%Dell EMC (OS10) %log-notice:IFM_OSTATE_UP: Interface operational state
is up :vlan1

OS10(config)# interface range ethernet 1/1/1-1/1/4
OS10(conf-range-eth1/1/1-1/1/4)# show configuration
!
interface ethernet1/1/1
no shutdown
switchport access vlan 1
!
interface ethernet1/1/2
no shutdown
switchport access vlan 1
!
interface ethernet1/1/3
no shutdown
switchport access vlan 1
!
interface ethernet1/1/4
no shutdown
switchport access vlan 1

OS10(conf-range-eth1/1/1-1/1/4)#

```

**Supported releases**

10.4.0E(R1) or later



## default vlan-id

Reconfigures the VLAN ID of the default VLAN.

|                          |                                                                                                                                                                                                                                                                                                                                                                                                         |
|--------------------------|---------------------------------------------------------------------------------------------------------------------------------------------------------------------------------------------------------------------------------------------------------------------------------------------------------------------------------------------------------------------------------------------------------|
| <b>Syntax</b>            | <code>default vlan-id <i>vlan-id</i></code>                                                                                                                                                                                                                                                                                                                                                             |
| <b>Parameters</b>        | <i>vlan-id</i> — Enter the default VLAN ID number, from 1 to 4093.                                                                                                                                                                                                                                                                                                                                      |
| <b>Default</b>           | VLAN1                                                                                                                                                                                                                                                                                                                                                                                                   |
| <b>Command Mode</b>      | CONFIGURATION                                                                                                                                                                                                                                                                                                                                                                                           |
| <b>Usage Information</b> | By default, VLAN1 serves as the default VLAN for switching untagged L2 traffic on OS10 ports in Trunk or Access mode. If you use VLAN1 for network-specific data traffic, reconfigure the VLAN ID of the default VLAN. The command reconfigures the access VLAN ID, the default VLAN, of all ports in Switchport Access mode. Ensure that the VLAN ID exists before configuring it as the default VLAN. |

### Example

```
OS10(config)# default vlan-id 10

OS10(config)# do show running-configuration
...
!
interface vlan1
no shutdown
!
interface vlan10
no shutdown
!
interface ethernet1/1/1
no shutdown
switchport access vlan 10
!
interface ethernet1/1/2
no shutdown
switchport access vlan 10
!
interface ethernet1/1/3
no shutdown
switchport access vlan 10
!
interface ethernet1/1/4
no shutdown
switchport access vlan 10
```

|                           |                      |
|---------------------------|----------------------|
| <b>Supported Releases</b> | 10.4.0E(R1) or later |
|---------------------------|----------------------|

## description (Interface)

Configures a textual description of an interface.

|                          |                                                                                                                                                                                                                                                                                                                                                                                                                                                                                                                                                                                                                                                                                                               |
|--------------------------|---------------------------------------------------------------------------------------------------------------------------------------------------------------------------------------------------------------------------------------------------------------------------------------------------------------------------------------------------------------------------------------------------------------------------------------------------------------------------------------------------------------------------------------------------------------------------------------------------------------------------------------------------------------------------------------------------------------|
| <b>Syntax</b>            | <code>description <i>string</i></code>                                                                                                                                                                                                                                                                                                                                                                                                                                                                                                                                                                                                                                                                        |
| <b>Parameters</b>        | <i>string</i> — Enter a text string for the interface description. A maximum of 240 characters.                                                                                                                                                                                                                                                                                                                                                                                                                                                                                                                                                                                                               |
| <b>Default</b>           | Not configured                                                                                                                                                                                                                                                                                                                                                                                                                                                                                                                                                                                                                                                                                                |
| <b>Command Mode</b>      | INTERFACE                                                                                                                                                                                                                                                                                                                                                                                                                                                                                                                                                                                                                                                                                                     |
| <b>Usage Information</b> | <ul style="list-style-type: none"><li>• To use special characters as a part of the description string, enclose the string in double quotes.</li><li>• To use comma as a part of the description string add double back slash before the comma.</li><li>• Spaces between characters are not preserved after entering this command unless you enclose the entire description in quotation marks; for example, "<i>text description</i>".</li><li>• Enter a text string after the <code>description</code> command to overwrite any previously configured text string.</li><li>• Use the <code>show running-configuration interface</code> command to view descriptions configured for each interface.</li></ul> |

- The `no` version of this command deletes the description.

### Example

```
OS10(conf-if-eth1/1/7)# description eth1/1/7
```

### Supported Releases

10.2.0E or later

## duplex

Configures Duplex mode on the Management port.

**Syntax** `duplex {full | half | auto}`

**Parameters**

- `full` — Set the physical interface to transmit in both directions.
- `half` — Set the physical interface to transmit in only one direction.
- `auto` — Set the port to auto-negotiate speed with a connected device.

**Defaults** Not configured

**Command Mode** CONFIGURATION

**Usage Information** You can only use this command on the Management port. The `no` version of this command removes the duplex mode configuration from the management port.

### Example

```
OS10(conf-if-ma-1/1/1)# duplex auto
```

### Supported Releases

10.3.0E or later

## enable dom

Enables or disables the DOM feature.

**Syntax** `dom enable`

**Parameters** None

**Default** Disabled

**Command Mode** CONFIGURATION

**Usage Information** The `no` version of this command disables digital optical monitoring.

### Example

```
OS10# configure terminal
OS10(config)# dom enable
```

```
OS10# configure terminal
OS10(config)# no dom enable
```

### Supported Releases

10.4.3.0 or later

## enable dom traps

Enables DOM traps if the specified parameter crosses the defined threshold three times.

**Syntax** `snmp-server enable traps dom {temperature | voltage | rx-power | tx-power | bias}`

|                           |                                                                                                                                                                                          |
|---------------------------|------------------------------------------------------------------------------------------------------------------------------------------------------------------------------------------|
| <b>Parameters</b>         | temperature   voltage   rx-power   tx-power   bias — Enter the keyword to enable DOM traps for the specified category.                                                                   |
| <b>Default</b>            | Not configured                                                                                                                                                                           |
| <b>Command Mode</b>       | CONFIGURATION                                                                                                                                                                            |
| <b>Usage Information</b>  | The no version of this command disables the DOM traps.                                                                                                                                   |
| <b>Example</b>            | <pre>OS10# configure terminal OS10(config)# snmp-server enable traps dom temperature</pre> <pre>OS10# configure terminal OS10(config)# no snmp-server enable traps dom temperature</pre> |
| <b>Supported Releases</b> | 10.4.3.0 or later                                                                                                                                                                        |

## feature auto-breakout

Enables front-panel Ethernet ports to automatically detect SFP media and autoconfigure breakout interfaces.

|                           |                                                                                                                                                                                                                                                                                                                                                                                                                                                                     |
|---------------------------|---------------------------------------------------------------------------------------------------------------------------------------------------------------------------------------------------------------------------------------------------------------------------------------------------------------------------------------------------------------------------------------------------------------------------------------------------------------------|
| <b>Syntax</b>             | feature auto-breakout                                                                                                                                                                                                                                                                                                                                                                                                                                               |
| <b>Parameters</b>         | None                                                                                                                                                                                                                                                                                                                                                                                                                                                                |
| <b>Default</b>            | Not configured                                                                                                                                                                                                                                                                                                                                                                                                                                                      |
| <b>Command mode</b>       | CONFIGURATION                                                                                                                                                                                                                                                                                                                                                                                                                                                       |
| <b>Usage information</b>  | <p>After you enter the <code>feature auto-breakout</code> command and plug a supported breakout cable in a QSFP+ or QSFP28 port, the port autoconfigures breakout interfaces for media type and speed.</p> <p>Use the <code>interface breakout</code> command to manually configure breakout interfaces. The media type plugged into a port is no longer automatically learned. The <code>no</code> version of this command disables the auto-breakout feature.</p> |
| <b>Example</b>            | <pre>OS10(config)# feature auto-breakout</pre>                                                                                                                                                                                                                                                                                                                                                                                                                      |
| <b>Supported releases</b> | 10.4.0E(R1) or later                                                                                                                                                                                                                                                                                                                                                                                                                                                |

## fec

Configures Forward Error Correction on 25G, 50G, and 100G interfaces.

|                          |                                                                                                                                                                                                                                                                                                                                                      |
|--------------------------|------------------------------------------------------------------------------------------------------------------------------------------------------------------------------------------------------------------------------------------------------------------------------------------------------------------------------------------------------|
| <b>Syntax</b>            | fec {CL74-FC   CL91-RS   CL108-RS   off}                                                                                                                                                                                                                                                                                                             |
| <b>Parameters</b>        | <ul style="list-style-type: none"> <li>CL74-FC — Supports 25G and 50G</li> <li>CL91-RS — Supports 100G</li> <li>CL108-RS — Supports 25G and 50G</li> <li>off — Disables FEC</li> </ul>                                                                                                                                                               |
| <b>Defaults</b>          | <p> <b>NOTE:</b> Default FEC settings are determined by the inserted media type.</p> <ul style="list-style-type: none"> <li>For 25G and 50G interfaces: off, CL108-RS, or auto-negotiate</li> <li>For 100G interfaces: off, CL91-RS, or auto-negotiate</li> </ul> |
| <b>Command Mode</b>      | CONFIGURATION                                                                                                                                                                                                                                                                                                                                        |
| <b>Usage Information</b> | The no version of this command resets the value to the default.                                                                                                                                                                                                                                                                                      |

## Example

```
OS10(config)# interface ethernet 1/1/41
OS10(conf-if-eth1/1/41)# fec CL91-RS
```

**Supported Releases** 10.3.0E or later

## interface breakout

Splits a front-panel Ethernet port into multiple breakout interfaces.

**Syntax** `interface breakout node/slot/port map {100g-1x | 50g-2x | 40g-1x | 25g-4x | 10g-4x | 25g-4x}`

- Parameters**
- *node/slot/port* — Enter the physical port information.
  - 100g-1x — Reset a QSFP28 port to 100G speed.
  - 50g-2x — Split a QSFP28 port into two 50GE interfaces.
  - 40g-1x — Set a QSFP28 port to use with a QSFP+ 40GE transceiver.
  - 25g-4x — Split a QSFP28 port into four 25GE interfaces.
  - 10g-4x — Split a QSFP28 or QSFP+ port into four 10GE interfaces

**Default** Not configured

**Command Mode** CONFIGURATION

- Usage Information**
- Each breakout interface operates at the configured speed; for example, 10G, 25G, or 50G.
  - The `no interface breakout node/slot/port` command resets a port to its default speed: 40G or 100G.
  - To configure breakout interfaces on a unified port, use the `mode {Eth | FC}` command in Port-Group Configuration mode.
  - On the MX9116n Fabric Engine and MX5108n Ethernet switch, the backplane server-facing ports do not support the `interface breakout` command. In `show inventory media` output, the status category of the backplane ports is displayed as `FIXED`.
  - On the S4148U-ON platform, ensure that you use the same breakout mode as you have configured on the peer interface. For example, if you have explicitly configured the interface on the peer device as 10g-4x, use the same configuration on your switch.

## Example

```
OS10(config)# interface breakout 1/1/41 map 10g-4x
```

**Supported Releases** 10.2.2E or later

## interface ethernet

Configures a physical Ethernet interface.

**Syntax** `interface ethernet node/slot/port:subport`

**Parameters** *node/slot/port:subport* — Enter the Ethernet interface information.

**Default** Not configured

**Command Mode** CONFIGURATION

**Usage Information** The `no` version of this command deletes the interface.

## Example

```
OS10(config)# interface ethernet 1/1/10:1
OS10(conf-if-eth1/1/10:1)#
```

**Supported Releases** 10.2.0E or later

## interface loopback

Configures a Loopback interface.

**Syntax** `interface loopback id`  
**Parameters** *id* — Enter the Loopback interface ID number, from 0 to 16383.  
**Default** Not configured  
**Command Mode** CONFIGURATION  
**Usage Information** The `no` version of this command deletes the Loopback interface.

**Example**

```
OS10(config)# interface loopback 100
OS10(conf-if-lo-100)#
```

**Supported Releases** 10.2.0E or later

## interface mgmt

Configures the Management port.

**Syntax** `interface mgmt node/slot/port`  
**Parameters** *node/slot/port* — Enter the physical port interface information for the Management interface.  
**Default** Enabled  
**Command Mode** CONFIGURATION  
**Usage Information** You cannot delete a Management port. To assign an IP address to the Management port, use the `ip address` command.

**Example**

```
OS10(config)# interface mgmt 1/1/1
OS10(conf-if-ma-1/1/1)#
```

**Supported Releases** 10.2.0E or later

## interface null

Configures a null interface on the switch.

**Syntax** `interface null number`  
**Parameters** *number* — Enter the interface number to set as null (0).  
**Default** 0  
**Command Mode** CONFIGURATION  
**Usage Information** You cannot delete the Null interface. The only configuration command possible in a Null interface is `ip unreachable`.

**Example**

```
OS10(config)# interface null 0
OS10(conf-if-nu-0)#
```

**Supported Releases** 10.3.0E or later

## interface port-channel

Creates a port-channel interface.

**Syntax** `interface port-channel channel-id`

**Parameters** *channel-id* — Enter the port-channel ID number, from 1 to 128.

**Default** Not configured

**Command Mode** CONFIGURATION

**Usage Information** The `no` version of this command deletes the interface.

### Example

```
OS10(config)# interface port-channel 10
OS10(conf-if-po-10)#
```

**Supported Releases** 10.2.0E or later

## interface range

Configures a range of Ethernet, port-channel, or VLAN interfaces for bulk configuration.

**Syntax** `interface range {ethernet node/slot/port[:subport]-node/slot/port[:subport], [...] | {port-channel IDnumber-IDnumber, [...] | vlan vlanID-vlanID, [...]}`

**Parameters**

- *node/slot/port[:subport]-node/slot/port[:subport]* — Enter a range of Ethernet interfaces.
- *IDnumber-IDnumber* — Enter a range of port-channel numbers, from 1 to 128.
- *vlanID-vlanID* — Enter a range VLAN ID numbers, from 1 to 4093.

**Default** Not configured

**Command Mode** CONFIGURATION

**Usage Information** Enter up to six comma-separated interface ranges without spaces between commas. When creating an interface range, interfaces are not sorted and appear in the order entered. You cannot mix interface configuration such as Ethernet ports with VLANs.

- A bulk configuration is created if at least one interface is valid.
- Non-existing interfaces are excluded from the bulk configuration with a warning message.
- This command has multiple port ranges, the prompt excludes the smaller port range.
- If you enter overlapping port ranges, the port range extends to the smallest port and the largest end port.
- You can only use VLAN and port-channel interfaces created using the `interface vlan` and `interface port-channel` commands.
- You cannot create virtual VLAN or port-channel interfaces using the `interface range` command.
- The `no` version of this command deletes the interface range.

### Example

```
OS10(config)# interface range ethernet 1/1/7-1/1/24
OS10(conf-range-eth1/1/7-1/1/24)#
```

**Supported Releases** 10.2.0E or later

## interface vlan

Creates a VLAN interface.

|                           |                                                                                                                                                                     |
|---------------------------|---------------------------------------------------------------------------------------------------------------------------------------------------------------------|
| <b>Syntax</b>             | <code>interface vlan <i>vlan-id</i></code>                                                                                                                          |
| <b>Parameters</b>         | <i>vlan-id</i> — Enter the VLAN ID number, from 1 to 4093.                                                                                                          |
| <b>Default</b>            | VLAN 1                                                                                                                                                              |
| <b>Command Mode</b>       | CONFIGURATION                                                                                                                                                       |
| <b>Usage Information</b>  | FTP, TFTP, MAC ACLs, and SNMP operations are not supported. IP ACLs are supported on VLANs only. The <code>no</code> version of this command deletes the interface. |
| <b>Example</b>            | <pre>OS10(config)# interface vlan 10 OS10(conf-if-vl-10)#</pre>                                                                                                     |
| <b>Supported Releases</b> | 10.2.0E or later                                                                                                                                                    |

## link-bundle-utilization

Configures link-bundle utilization.

|                           |                                                                                                                                        |
|---------------------------|----------------------------------------------------------------------------------------------------------------------------------------|
| <b>Syntax</b>             | <code>link-bundle-utilization trigger-threshold <i>value</i></code>                                                                    |
| <b>Parameters</b>         | <i>value</i> — Enter the percentage of port-channel bandwidth that triggers traffic monitoring on port-channel members, from 0 to 100. |
| <b>Default</b>            | Disabled                                                                                                                               |
| <b>Command Mode</b>       | CONFIGURATION                                                                                                                          |
| <b>Usage Information</b>  | None                                                                                                                                   |
| <b>Example</b>            | <pre>OS10(config)# link-bundle-utilization trigger-threshold 10</pre>                                                                  |
| <b>Supported Releases</b> | 10.2.0E or later                                                                                                                       |

## mode

Configures a front-panel unified port group to operate in Fibre Channel or Ethernet mode, or a QSFP28-DD or QSFP28 port group to operate in Ethernet mode, with the specified speed on activated interfaces.

|                   |                                                                                                                                                                                                                                                                                                                                                                                                                                                                                                                                                                                                                                                                                                                                                                                                                                       |
|-------------------|---------------------------------------------------------------------------------------------------------------------------------------------------------------------------------------------------------------------------------------------------------------------------------------------------------------------------------------------------------------------------------------------------------------------------------------------------------------------------------------------------------------------------------------------------------------------------------------------------------------------------------------------------------------------------------------------------------------------------------------------------------------------------------------------------------------------------------------|
| <b>Syntax</b>     | <code>mode {Eth {100g-2x   100g-1x   50g-2x   40g-2x   40g-1x   25g-8x [fabric-expander-mode]   25g-4x   10g-8x   10g-4x}   FC {32g-4x   32g-2x   32g-1x   16g-4x}}</code>                                                                                                                                                                                                                                                                                                                                                                                                                                                                                                                                                                                                                                                            |
| <b>Parameters</b> | <ul style="list-style-type: none"><li>• <code>mode Eth</code> — Configure a port group in Ethernet mode and set the speed to:<ul style="list-style-type: none"><li>○ <code>100g-2x</code> — Split a QSFP28-DD port into two 100GE interfaces.</li><li>○ <code>100g-1x</code> — Reset a QSFP28 port group to 100GE mode.</li><li>○ <code>50g-2x</code> — Split a QSFP28 port into two 50GE interfaces.</li><li>○ <code>40g-2x</code> — Split a port group into two 40GE interfaces.</li><li>○ <code>40g-1x</code> — Set a port group to 40G mode for use with a QSFP+ 40GE transceiver.</li><li>○ <code>25g-8x fabric-expander-mode</code> — Split a QSFP28-DD port into eight 25GE interfaces for connection to a Fabric Expander.</li><li>○ <code>25g-8x</code> — Split a port group into eight 25GE interfaces.</li></ul></li></ul> |

- 25g-4x — Split a port group into four 25GE interfaces.
- 10g-8x — Split a port group into eight 10GE interfaces.
- 10g-4x — Split a port group into four 10GE interfaces.
- mode FC — Configure a port group in Fibre Channel mode and set the speed to:
  - 32g-4x — Split a port group into four 32GFC interfaces.
  - 32g-2x — Split a port group into two 32GFC interfaces, subports 1 and 3.
  - 32g-1x — Split a port group into one 32GFC interface, subport 1.
  - 16g-4x — Split a port group into four 16GFC interfaces; supports 4x32GFC oversubscription.

**Default** S4148U-ON: Depends on the port profile activated.

MX9116n Fabric Switching Engine:

- QSFP28-DD port groups 1 to 9 operate in 8x25GE fabric-expander mode (FEM).
- QSFP28-DD port groups 10 to 12 operate in 2x100GE mode.
- QSFP28 port groups 13 and 14 operate in 1x100GE mode.
- Unified port groups 15 and 16 operate in ethernet 1x100GE mode.

**Command Mode** PORT-GROUP

**Usage Information**

- The mode {FC | Eth} command configures a port group to operate at line rate and guarantees no traffic loss.
- To configure oversubscription on a FC interface, use the speed command.
- To view the currently active ports and subports, use the show interfaces status command.
- The no version of the command resets port-group interfaces to the default Ethernet port mode/speed. Use the no mode command before you reset the mode on an interface.

**Example**

```
OS10(conf-pg-1/1/2)# mode FC 16g-4x
OS10(conf-pg-1/1/8)# mode Eth 10g-4x
```

**Example: Reset mode**

```
OS10(conf-pg-1/1/2)# mode FC 16g-4x
OS10(conf-pg-1/1/2)# no mode
OS10(conf-pg-1/1/2)# mode Eth 10g-4x
```

**Supported Releases** 10.3.1E or later

## mode l3

Enables L3 routing on a VLAN after you configure the VLAN scale profile.

**Syntax** mode l3

**Parameters** None

**Defaults** Not configured

**Command Mode** INTERFACE VLAN

**Usage Information** To configure the VLAN scale profile, use the scale-profile vlan command. The scale profile globally applies L2 mode on all VLANs you create and disables L3 transmission. To enable L3 routing traffic on a VLAN, use the mode l3 command.

**Example**

```
OS10(config)# interface vlan 10
OS10(conf-if-vl-10)# mode l3
```

**Supported Releases** 10.4.0E(X2) or later



## mtu

Sets the link maximum transmission unit (MTU) frame size for an Ethernet L2 or L3 interface.

|                          |                                                                                                                                                                                                                                                                                                                                                                                                                                                                                                                                                                                                                                                                                                                                                                                                                                                                                                                                                                                                                                                                                                                                                                                                                                                                                                                                                                                                        |
|--------------------------|--------------------------------------------------------------------------------------------------------------------------------------------------------------------------------------------------------------------------------------------------------------------------------------------------------------------------------------------------------------------------------------------------------------------------------------------------------------------------------------------------------------------------------------------------------------------------------------------------------------------------------------------------------------------------------------------------------------------------------------------------------------------------------------------------------------------------------------------------------------------------------------------------------------------------------------------------------------------------------------------------------------------------------------------------------------------------------------------------------------------------------------------------------------------------------------------------------------------------------------------------------------------------------------------------------------------------------------------------------------------------------------------------------|
| <b>Syntax</b>            | <code>mtu value</code>                                                                                                                                                                                                                                                                                                                                                                                                                                                                                                                                                                                                                                                                                                                                                                                                                                                                                                                                                                                                                                                                                                                                                                                                                                                                                                                                                                                 |
| <b>Parameters</b>        | <i>value</i> — Enter the maximum frame size in bytes, from 1280 to 65535. Maximum frame size for an S3000-ON is 12000, and S4000-ON is 9216.                                                                                                                                                                                                                                                                                                                                                                                                                                                                                                                                                                                                                                                                                                                                                                                                                                                                                                                                                                                                                                                                                                                                                                                                                                                           |
| <b>Default</b>           | 1532 bytes                                                                                                                                                                                                                                                                                                                                                                                                                                                                                                                                                                                                                                                                                                                                                                                                                                                                                                                                                                                                                                                                                                                                                                                                                                                                                                                                                                                             |
| <b>Command Mode</b>      | INTERFACE                                                                                                                                                                                                                                                                                                                                                                                                                                                                                                                                                                                                                                                                                                                                                                                                                                                                                                                                                                                                                                                                                                                                                                                                                                                                                                                                                                                              |
| <b>Usage Information</b> | <p>To return to the default MTU value, use the <code>no mtu</code> command. If an IP packet includes a L2 header, the IP MTU must be at least 32 bytes smaller than the L2 MTU.</p> <ul style="list-style-type: none"><li>• Port-channels<ul style="list-style-type: none"><li>◦ All members must have the same link MTU value and the same IP MTU value.</li><li>◦ The port channel link MTU and IP MTU must be less than or equal to the link MTU and IP MTU values you configure on the channel members. For example, if the members have a link MTU of 2100 and an IP MTU 2000, the port channel's MTU values cannot be higher than 2100 for link MTU or 2000 bytes for IP MTU.</li></ul></li><li>• VLANS<ul style="list-style-type: none"><li>◦ All members of a VLAN must have the same MTU value.</li><li>◦ Tagged members must have a link MTU 4 bytes higher than untagged members to account for the packet tag.</li><li>◦ Ensure that the MTU of VLAN members is greater than or equal to the VLAN MTU. OS10 selects the lowest MTU value configured on the VLAN or VLAN members to be the VLAN MTU.</li></ul></li></ul> <p>For example, the VLAN contains tagged members with Link MTU of 1522 and IP MTU of 1500 and untagged members with Link MTU of 1518 and IP MTU of 1500. The VLAN's Link MTU cannot be higher than 1518 bytes and its IP MTU cannot be higher than 1500 bytes.</p> |

### Example

```
OS10(conf-if-eth1/1/7)# mtu 3000
```

### Supported Releases

10.2.0E or later

## negotiation

Configures a negotiation mode on an interface.

|                          |                                                                                                                                                                                                                                                                                                                                                                  |
|--------------------------|------------------------------------------------------------------------------------------------------------------------------------------------------------------------------------------------------------------------------------------------------------------------------------------------------------------------------------------------------------------|
| <b>Syntax</b>            | <code>negotiation {auto   on   off}</code>                                                                                                                                                                                                                                                                                                                       |
| <b>Parameters</b>        | <p><code>auto</code> — Sets the negotiation mode to the default setting. The default setting depends on the media that you use.</p> <p><code>on</code> — Forces interface negotiation.</p> <p><code>off</code> — Disables interface negotiation.</p>                                                                                                             |
| <b>Defaults</b>          | Auto                                                                                                                                                                                                                                                                                                                                                             |
| <b>Command Mode</b>      | INTERFACE CONFIGURATION                                                                                                                                                                                                                                                                                                                                          |
| <b>Usage Information</b> | <p>Use the <code>show interfaces</code> command to view the interface negotiation status.</p> <p>Both sides of the link must have auto-negotiation enabled or disabled for the link to come up.</p> <p>Use either the <code>negotiation auto</code> command or the <code>no negotiation</code> command to reset the negotiation mode to its default setting.</p> |

### Example

```
OS10(conf-if-eth1/1/50)# negotiation off
OS10(conf-if-eth1/1/50)# show configuration
```

```

!
interface ethernet1/1/50
 no shutdown
 switchport access vlan 1
 negotiation off
 flowcontrol receive on
OS10(conf-if-eth1/1/50)# negotiation on
OS10(conf-if-eth1/1/50)# show configuration
!
interface ethernet1/1/50
 no shutdown
 switchport access vlan 1
 negotiation on
 flowcontrol receive on
OS10(conf-if-eth1/1/50)# negotiation auto
OS10(conf-if-eth1/1/50)# show configuration
!
interface ethernet1/1/50
 no shutdown
 switchport access vlan 1
 flowcontrol receive on
OS10(conf-if-eth1/1/50)#
OS10(conf-if-eth1/1/50)# negotiation on
OS10(conf-if-eth1/1/50)# show configuration
!
interface ethernet1/1/50
 no shutdown
 switchport access vlan 1
 negotiation on
 flowcontrol receive on
OS10(conf-if-eth1/1/50)# no negotiation
OS10(conf-if-eth1/1/50)# show configuration
!
interface ethernet1/1/50
 no shutdown
 switchport access vlan 1
 flowcontrol receive on
OS10(conf-if-eth1/1/50)# do show interface ethernet 1/1/50
Ethernet 1/1/50 is up, line protocol is up
Hardware is Eth, address is e4:f0:04:3e:2d:86
 Current address is e4:f0:04:3e:2d:86
Pluggable media present, QSFP28 type is QSFP28 100GBASE-CR4-2.0M
 Wavelength is 64
 Receive power reading is not available

Interface index is 112
Internet address is not set
Mode of IPv4 Address Assignment: not set
Interface IPv6 oper status: Disabled
MTU 1532 bytes, IP MTU 1500 bytes
LineSpeed 100G, Auto-Negotiation on

```

**Supported Releases** 10.2.0E or later

## port mode Eth

Configures a Z9264F-ON QSFP28 port group to operate in Ethernet mode, with the specified speed on activated interfaces.

### Syntax

```
port node/slot/port mode Eth port-mode
```

### Parameters

- *node/slot/port* — Enter the interface type details.
- *mode Eth* — Configure a port group in Ethernet mode and set the speed to:
  - *100g-1x* — Reset a port to 100GE mode.
  - *50g-2x* — Split a port into two 50GE interfaces.

- 40g-1x — Set a port to 40GE mode for use with a QSFP+ 40GE transceiver.
- 25g-4x — Split a port into four 25GE interfaces.
- 10g-4x — Split a port into four 10GE interfaces.

**Default** 100g-1x  
**Command mode** PORT-GROUP

**Usage information**

- To view the currently active ports and subports, use the `show port-group` command. The `no` version of the command resets port-group interfaces to the default Ethernet port mode/speed.
- On the S4148U-ON platform, ensure that you use the same breakout mode as you have configured on the peer interface. For example, if you have explicitly configured the interface on the peer device as 10g-4x, use the same configuration on your switch.

**Example**

```
OS10(config)# port-group 1/1/2
OS10(conf-pg-1/1/2)# profile restricted
OS10(conf-pg-1/1/2)# port 1/1/3 mode Eth 25g-4x
OS10(conf-pg-1/1/2)# exit
OS10(config)# interface ethernet 1/1/3:2
OS10(conf-if-eth1/1/3:2)#
```

**Supported releases** 10.4.3.0 or later

## port-group

Configures a group of front-panel unified ports, or a double-density QSFP28 (QSFP28-DD) or single-density QSFP28 port group.

**Syntax** `port-group node/slot/port-group`

**Parameters**

- `node/slot` — Enter 1/1 for `node/slot` when you configure a port group.
- `port-group` — Enter the port-group number, from 1 to 16. The available port-group range depends on the switch.

**Default** Not configured

**Command mode** CONFIGURATION

**Usage information** Enter PORT-GROUP mode to:

- Configure unified ports in Fibre Channel or Ethernet mode and break out interfaces with a specified speed.
- Break out an MX9116n QSFP28-DD or QSFP28 port group into multiple interfaces with a specified speed.
- Break out a Z9264F-ON QSFP28 port group into multiple interfaces with a specified speed.

To view the ports that belong to a port group, use the `show port-group` command.

**Example**

```
OS10(config)# port-group 1/1/8
OS10(conf-pg-1/1/8)#
```

**Supported releases** 10.3.1E or later

## profile

Configures breakout interfaces on a Z9264F-ON switch.

**Syntax** `profile {restricted | unrestricted}`

|                           |                                                                                                                                                                                                                                                                                                                                                                                                                                                                                                                                                                                         |
|---------------------------|-----------------------------------------------------------------------------------------------------------------------------------------------------------------------------------------------------------------------------------------------------------------------------------------------------------------------------------------------------------------------------------------------------------------------------------------------------------------------------------------------------------------------------------------------------------------------------------------|
| <b>Parameters</b>         | <ul style="list-style-type: none"> <li>• <code>restricted</code> — Applies only to the odd-numbered port within the port group. The even-numbered port in the port group is disabled. Supported speeds are: <ul style="list-style-type: none"> <li>○ 100g-1x</li> <li>○ 40g-1x</li> <li>○ 25g-4x</li> <li>○ 10g-4x</li> </ul> </li> <li>• <code>unrestricted</code> — Applies to both the odd-numbered and even-numbered ports within the port group. Supported speeds are: <ul style="list-style-type: none"> <li>○ 100g-1x</li> <li>○ 50g-2x</li> <li>○ 40g-1x</li> </ul> </li> </ul> |
| <b>Default</b>            | Unrestricted                                                                                                                                                                                                                                                                                                                                                                                                                                                                                                                                                                            |
| <b>Command mode</b>       | PORT-GROUP                                                                                                                                                                                                                                                                                                                                                                                                                                                                                                                                                                              |
| <b>Usage information</b>  | Enter the <code>profile</code> command to configure breakout interfaces. Use the <code>port</code> command to specify the speed. The Z9264F-ON switch has a total of 64 physical ports and can support a maximum of 128 logical ports. To view the ports that belong to a port group, use the <code>show port-group</code> command.                                                                                                                                                                                                                                                     |
| <b>Example</b>            | <pre>OS10(config)# port-group 1/1/2 OS10(conf-pg-1/1/2)# profile restricted</pre>                                                                                                                                                                                                                                                                                                                                                                                                                                                                                                       |
| <b>Supported releases</b> | 10.4.3.0 or later                                                                                                                                                                                                                                                                                                                                                                                                                                                                                                                                                                       |

## scale-profile vlan

Configures the L2 VLAN scale profile on a switch.

|                           |                                                                                                                                                                                                                                                                                                                                                                                                                               |
|---------------------------|-------------------------------------------------------------------------------------------------------------------------------------------------------------------------------------------------------------------------------------------------------------------------------------------------------------------------------------------------------------------------------------------------------------------------------|
| <b>Syntax</b>             | <code>scale-profile vlan</code>                                                                                                                                                                                                                                                                                                                                                                                               |
| <b>Parameters</b>         | None                                                                                                                                                                                                                                                                                                                                                                                                                          |
| <b>Defaults</b>           | Not configured                                                                                                                                                                                                                                                                                                                                                                                                                |
| <b>Command Mode</b>       | CONFIGURATION                                                                                                                                                                                                                                                                                                                                                                                                                 |
| <b>Usage Information</b>  | Use the VLAN scale profile when you scale the number of VLANs so that the switch consumes less memory. Enable the scale profile before you configure VLANs on the switch. The scale profile globally applies L2 mode on all VLANs you create and disables L3 transmission. The <code>no</code> version of the command disables L2 VLAN scaling. To enable L3 routing traffic on a VLAN, use the <code>mode L3</code> command. |
| <b>Example</b>            | <pre>OS10(config)# scale-profile vlan</pre>                                                                                                                                                                                                                                                                                                                                                                                   |
| <b>Supported Releases</b> | 10.4.0E(X2) or later                                                                                                                                                                                                                                                                                                                                                                                                          |

## show discovered-expanders

Displays the Fabric Expanders attached to an MX9116n Fabric Switching Engine.

|                          |                                                                                                        |
|--------------------------|--------------------------------------------------------------------------------------------------------|
| <b>Syntax</b>            | <code>show discovered-expanders</code>                                                                 |
| <b>Syntax</b>            | <code>show discovered-expanders</code>                                                                 |
| <b>Parameters</b>        | None                                                                                                   |
| <b>Command Mode</b>      | EXEC                                                                                                   |
| <b>Usage Information</b> | Use the <code>show discovered-expanders</code> command to verify the auto-discovered Fabric Expanders. |

If a Fabric Switching Engine is in SmartFabric mode, it automatically discovers and configures an attached Fabric Expander:

- Virtual ports on the Fabric Expander and a virtual slot ID are created and mapped to 8x25GE breakout interfaces in FEM mode on the Fabric Engine.
- The unit ID is automatically discovered.
- Server traffic is transmitted through the QSFP28-DD uplink on the Fabric Expander to the Fabric Engine.

If the Fabric Switching Engine is in Full Switch mode, configure the switch using the CLI. You must manually configure the unit ID of the Fabric Expander, for more information see [Virtual ports](#). The unit ID is also called the *virtual slot ID*.

### Example

```
OS10# show discovered-expanders
Service- Model Type Chassis- Chassis-slot Port-group
Virtual-
tag service-tag Slot-
Id

403RPK2 MX7116n Fabric 1 SKY003Q A2 1/1/2 71
 Expander Module
```

### Supported Releases

10.4.0E(R3S) or later

## show interface

Displays interface information.

**Syntax** `show interface [type]`

**Parameters** `interface type` — Enter the interface type:

- `phy-eth node/slot/port[:subport]` — Display information about physical ports connected to the interface.
- `status` — Display interface status.
- `ethernet node/slot/port[:subport]` — Display Ethernet interface information.
- `loopback id` — Display Loopback IDs, from 0 to 16383.
- `mgmt node/slot/port` — Display Management interface information.
- `null` — Display null interface information.
- `port-channel id-number` — Display port channel interface IDs, from 1 to 128.
- `vlan vlan-id` — Display the VLAN interface number, from 1 to 4093.

**Default** Not configured

**Command Mode** EXEC

**Usage Information** Use the `do show interface` command to view interface information from other command modes.

### Example

```
OS10# show interface
Ethernet 1/1/2 is up, line protocol is up
Hardware is Dell EMC Eth, address is 00:0c:29:54:c8:57
Current address is 00:0c:29:54:c8:57
Pluggable media present, QSFP+ type is QSFP+ 40GBASE CR 1.0M
Wavelength is 64
Receive power reading is 0.0
Interface index is 17305094
Internet address is not set
Mode of IPv4 Address Assignment: not set
Interface IPv6 oper status: Enabled
Link local IPv6 address: fe80::20c:29ff:fe54:c857/64
Global IPv6 address: 2::1/64
MTU 1532 bytes, IP MTU 1500 bytes
LineSpeed 40G, Auto-Negotiation on
```

```

FEC is auto, Current FEC is off
Flowcontrol rx off tx off
ARP type: ARPA, ARP Timeout: 60
Last clearing of "show interface" counters: 00:40:14
Queuing strategy: fifo
Input statistics:
 0 packets, 0 octets
 0 64-byte pkts, 0 over 64-byte pkts, 0 over 127-byte pkts
 0 over 255-byte pkts, 0 over 511-byte pkts, 0 over 1023-byte pkts
 0 Multicasts, 0 Broadcasts, 0 Unicasts
 0 runts, 0 giants, 0 throttles
 0 CRC, 0 overrun, 0 discarded
Output statistics:
 0 packets, 0 octets
 0 64-byte pkts, 0 over 64-byte pkts, 0 over 127-byte pkts
 0 over 255-byte pkts, 0 over 511-byte pkts, 0 over 1023-byte pkts
 0 Multicasts, 0 Broadcasts, 0 Unicasts
 0 throttles, 0 discarded, 0 Collisions, 0 wredrops
Rate Info(interval 299 seconds):
 Input 0 Mbits/sec, 0 packets/sec, 0% of line rate
 Output 0 Mbits/sec, 0 packets/sec, 0% of line rate
Time since last interface status change: 3 weeks 1 day 20:30:38

--more--

```

### Example (port channel)

```

OS10# show interface port-channel 1
Port-channel 1 is up, line protocol is down
Address is 90:b1:1c:f4:a5:8c, Current address is 90:b1:1c:f4:a5:8c
Interface index is 85886081
Internet address is not set
Mode of IPv4 Address Assignment: not set
MTU 1532 bytes
LineSpeed 0
Minimum number of links to bring Port-channel up is 1
Maximum active members that are allowed in the portchannel is 5
Members in this channel:
ARP type: ARPA, ARP Timeout: 60

```

```

OS10# show interface port-channel summary
LAG Mode Status Uptime Ports
22 L2 up 20:38:08 Eth 1/1/10 (Up)
 Eth 1/1/11 (Down)
 Eth 1/1/12 (Inact)
23 L2 up 20:34:32 Eth 1/1/20 (Up)
 Eth 1/1/21 (Up)
 Eth 1/1/22 (Up)

```

### Example (VLAN)

```

OS10# show interface vlan 20
Vlan 20 is up, line protocol is down
vlan name: vlanname20
Address is 0c:9b:1d:68:89:6a, Current address is 0c:9b:1d:68:89:6a
Interface index is 60
Internet address is not set
Mode of IPv4 Address Assignment: not set
Interface IPv6 oper status: Enabled
MTU 1532 bytes, IP MTU 1500 bytes
LineSpeed 0
ARP type: ARPA, ARP Timeout: 60
Last clearing of "show interface" counters: 00:05:14
Queuing strategy: fifo
Input statistics:
 0 packets, 0 octets
Output statistics:
 0 packets, 0 octets
Time since last interface status change: 00:05:15

```

### Supported Releases

10.2.0E or later

## show interface transceiver “Tunable wavelength”

Display the configured wavelength value of the optical interface.

|                          |                                                                                                                  |
|--------------------------|------------------------------------------------------------------------------------------------------------------|
| <b>Syntax</b>            | <code>show interface phy-eth <i>interface</i> transceiver   grep "Tunable wavelength"</code>                     |
| <b>Parameters</b>        | <i>interface</i> — Specify the interface corresponding to which you want to view the optical wavelength details. |
| <b>Defaults</b>          | None.                                                                                                            |
| <b>Command Mode</b>      | EXEC PRIVILEGE                                                                                                   |
| <b>Usage Information</b> | None.                                                                                                            |

### Example

```
OS10# show interface phy-eth 1/1/14 transceiver | grep "Tunable wavelength"
SFP1/1/14 Tunable wavelength= 1530.000nm
```

**Supported Releases** 10.4.2E or later

## show inventory media

Displays installed media in switch ports.

|                          |                                                                                                |
|--------------------------|------------------------------------------------------------------------------------------------|
| <b>Syntax</b>            | <code>show inventory media</code>                                                              |
| <b>Parameters</b>        | None                                                                                           |
| <b>Command Mode</b>      | EXEC                                                                                           |
| <b>Usage Information</b> | Use the <code>show inventory media</code> command to verify the media type inserted in a port. |

On the MX9116n Fabric Switching Engine and MX5108n Ethernet Switch, server-facing interfaces are on the backplane and are enabled by default. To view the backplane port connections to servers, use the `show inventory media` command. In the output, a FIXED port does not use external transceivers and always displays as Dell EMC Qualified.

### Example

```
OS10# show inventory media

 System Inventory Media

Node/Slot/Port Category Media Serial Dell EMC
Number Qualified

1/1/1 Not Present
1/1/2 SFP+ SFP+ 10GBASE SR AM70843 true
1/1/3 Not Present
1/1/4 SFP+ SFP+ 10GBASE SR AKN0LC7 false
1/1/5 SFP+ SFP+ 10GBASE SR AM718GQ true
1/1/6 SFP+ SFP+ 10GBASE SR AM708XM true
1/1/7 SFP+ SFP+ 10GBASE SR AQ2237K true
1/1/8 SFP+ SFP+ 10GBASE SR AGT047N true
1/1/9 Not Present
1/1/10 Not Present
1/1/11 Not Present
1/1/12 Not Present
1/1/13 Not Present
1/1/14 Not Present
1/1/15 SFP+ SFP+ 10GBASE SR AK60QJN false
1/1/16 SFP+ SFP+ 10GBASE SR AL30KWM true
1/1/17 SFP+ SFP+ 10GBASE SR AQ22DMB true
1/1/18 SFP+ SFP+ 10GBASE SR AQM146U true
...
```

**Example:  
MX9116n Fabric  
Engine**

```
OS10# show inventory media

 System Inventory Media

Node/Slot/Port Category Media Serial Dell EMC
Number Qualified

1/1/1 FIXED INTERNAL Serial true
1/1/2 FIXED INTERNAL Number true
1/1/3 FIXED INTERNAL true
1/1/4 FIXED INTERNAL true
1/1/5 FIXED INTERNAL true
1/1/6 FIXED INTERNAL true
1/1/7 FIXED INTERNAL true
1/1/8 FIXED INTERNAL true
1/1/9 FIXED INTERNAL true
1/1/10 FIXED INTERNAL true
1/1/11 FIXED INTERNAL true
1/1/12 FIXED INTERNAL true
1/1/13 FIXED INTERNAL true
1/1/14 FIXED INTERNAL true
1/1/15 FIXED INTERNAL true
1/1/16 FIXED INTERNAL true
```

**Example:  
MX5108n  
Ethernet switch**

```
OS10# show inventory media

 System Inventory Media

Node/Slot/Port Category Media Serial Dell EMC
Number Qualified

1/1/1 FIXED INTERNAL Serial true
1/1/2 FIXED INTERNAL Number true
1/1/3 FIXED INTERNAL true
1/1/4 FIXED INTERNAL true
1/1/5 FIXED INTERNAL true
1/1/6 FIXED INTERNAL true
1/1/7 FIXED INTERNAL true
1/1/8 FIXED INTERNAL true
...

```

**Supported  
Releases**

10.2.0E or later

## show link-bundle-utilization

Displays information about the link-bundle utilization.

**Syntax** show link-bundle-utilization

**Parameters** None

**Default** Not configured

**Command Mode** EXEC

**Usage** None

**Information**

**Example**

```
OS10# show link-bundle-utilization
Link-bundle trigger threshold - 60
```

**Supported  
Releases**

10.2.0E or later



## show port-channel summary

Displays port-channel summary information.

**Syntax** show port-channel summary

**Parameters** None

**Default** Not configured

**Command Mode** EXEC

**Usage Information** None

### Example

```
OS10(conf-if-eth1/1/4)# do show port-channel summary
Flags: D - Down I - member up but inactive P - member up and active
U - Up (port-channel)
```

```
Group Port-Channel Type Protocol Member Ports
22 port-channel22 (U) Eth STATIC 1/1/2(D) 1/1/3(P)
23 port-channel23 (D) Eth DYNAMIC 1/1/4(I)
```

### Example (Interface)

```
OS10(conf-range-eth1/1/10-1/1/11,1/1/13,1/1/14)# do show port-channel
summary
Flags: D - Down U - member up but inactive P - member up and active
U - Up (port-channel)
```

```
Group Port-Channel Type Protocol Member Ports
22 port-channel22 (U) Eth STATIC 1/1/10(P) 1/1/11(P) 1/1/12(P) 1/1/13(P)
1/1/14(P) 1/1/15(P) 1/1/16(P) 1/1/17(P) 1/1/18(P) 1/1/19(P)
23 port-channel23 (D) Eth STATIC
OS10(config)# interface range e1/1/12-1/1/13,1/1/15,1/1/17-1/1/18
OS10(conf-range-eth1/1/12-1/1/13,1/1/15,1/1/17-1/1/18)# no channel-group
OS10(conf-range-eth1/1/12-1/1/13,1/1/15,1/1/17-1/1/18)# do show port-
channel summary
Flags: D - Down U - member up but inactive P - member up and active
U - Up (port-channel)
```

```
Group Port-Channel Type Protocol Member Ports
22 port-channel22 (U) Eth STATIC 1/1/10(P) 1/1/11(P) 1/1/14(P) 1/1/16(P)
1/1/19(P)
23 port-channel23 (D) Eth STATIC
```

**Supported Releases** 10.2.0E or later

## show port-group

Displays the current port-group configuration on a switch.

**Syntax** show port-group

**Parameters** None

**Default** None

**Command Mode** EXEC

**Usage Information** To view the ports that belong to each port-group, use the show port-group command. To configure a port-group, use the port-group command.

### Example: S4148U-ON

```
OS10(config)# show port-group
port-group mode ports
```

```

1/1/1 Eth 10g-4x 1 2 3 4
1/1/2 FC 16g-2x 5 6 7 8
1/1/3 FC 16g-2x 9 10 11 12
1/1/4 FC 16g-2x 13 14 15 16
1/1/5 FC 16g-2x 17 18 19 20
1/1/6 FC 16g-2x 21 22 23 24
1/1/7 Eth 100g-1x 25
1/1/8 Eth 40g-1x 26
1/1/9 Eth 100g-1x 29
1/1/10 Eth 40g-1x 30

```

**Example:  
MX9116n Fabric  
Engine**

```

OS10(config)# show port-group
Port-group Mode Ports FEM
port-group1/1/1 Eth 25g-8x 17 18 FEM
port-group1/1/2 Eth 25g-8x 19 20 FEM
port-group1/1/3 Eth 25g-8x 21 22 FEM
port-group1/1/4 Eth 25g-8x 23 24 FEM
port-group1/1/5 Eth 25g-8x 25 26 FEM
port-group1/1/6 Eth 25g-8x 27 28 FEM
port-group1/1/7 Eth 25g-8x 29 30 FEM
port-group1/1/8 Eth 25g-8x 31 32 FEM
port-group1/1/9 Eth 25g-8x 33 34 FEM
port-group1/1/10 Eth 100g-2x 35 36 -
port-group1/1/11 Eth 100g-2x 37 38 -
port-group1/1/12 Eth 100g-2x 39 40 -
port-group1/1/13 Eth 100g-1x 41 -
port-group1/1/14 Eth 100g-1x 42 -
port-group1/1/15 Eth 100g-1x 43 -
port-group1/1/16 Eth 100g-1x 44 -

```

**Example:  
Z9264F-ON**

```

OS10(config)# show port-group
hybrid-group profile Ports Mode
port-group1/1/1 restricted 1/1/1 Eth 10g-4x
port-group1/1/2 restricted 1/1/2 Eth Disabled
port-group1/1/3 restricted 1/1/3 Eth 10g-4x
port-group1/1/4 restricted 1/1/4 Eth Disabled
port-group1/1/5 restricted 1/1/5 Eth 10g-4x
port-group1/1/6 restricted 1/1/6 Eth Disabled
port-group1/1/7 restricted 1/1/7 Eth 10g-4x
port-group1/1/8 restricted 1/1/8 Eth Disabled
port-group1/1/9 restricted 1/1/9 Eth 10g-4x
port-group1/1/10 restricted 1/1/10 Eth Disabled
port-group1/1/11 restricted 1/1/11 Eth 10g-4x
port-group1/1/12 restricted 1/1/12 Eth Disabled
port-group1/1/13 restricted 1/1/13 Eth 10g-4x
port-group1/1/14 restricted 1/1/14 Eth Disabled
port-group1/1/15 restricted 1/1/15 Eth 10g-4x

```

**Supported  
Releases**

- 10.3.1E or later
- 10.4.3.0 or later—Z9264F-ON platform support added

## show switch-port-profile

Displays the current and default port profile on a switch.

**Syntax** `show switch-port-profile node/slot`

**Parameters**

- *node/slot* — Enter the switch information. For a standalone switch, enter 1/1.

**Default** `profile-1`

**Command Mode** EXEC

**Usage Information** A switch-port profile determines the available front-panel ports and breakout modes on Ethernet and unified ports. To display the current port profile, use the `show switch-port-profile` command. To

reset the switch to the default port profile, use the `no switch-port-profile node/slot` command.

### Example

```
OS10(config)# show switch-port-profile 1/1

| Node/Unit | Current | Next-boot | Default |
|-----+-----+-----+-----|
| 1/1 | profile-2 | profile-2 | profile-1 |

Supported Profiles:
profile-1
profile-2
profile-3
profile-4
profile-5
profile-6
```

**Supported Releases** 10.3.1E or later

## show system

Displays the status of the DOM feature, whether it is enabled or disabled.

**Syntax** `show system`

**Parameters** None

**Defaults** DOM disabled

**Command Mode** EXEC

**Usage Information** None

### Example

```
OS10# show system
Node Id : 1
MAC : 14:18:77:15:c3:e8
Number of MACs : 256
Up Time : 1 day 00:48:58

-- Unit 1 --
Status : up
System Identifier : 1
Down Reason : unknown
Digital Optical Monitoring : disable
System Location LED : off
Required Type : S4148F
Current Type : S4148F
Hardware Revision : X01
Software Version : 10.5.1.0
Physical Ports : 48x10GbE, 2x40GbE, 4x100GbE
BIOS : 3.33.0.0-3
System CPLD : 0.4
Master CPLD : 0.10
Slave CPLD : 0.7
```

**Supported Releases** 10.4.3.0 or later

## show unit-provision

Displays the unit ID and service tag of the Fabric Expanders attached to a Fabric Switching Engine.

**Syntax** `show unit-provision`

**Parameters** None

**Command Mode** EXEC

**Usage Information** If the Fabric Switching Engine is in Full Switch mode, you must manually configure the unit ID of an attached Fabric Expander. For more information, see [Virtual ports](#). Use the `show unit-provision` command to display the assigned and unassigned unit IDs, and service tag provision name values. Use the `unit-provision` command to configure the Fabric Expander with an unassigned unit ID and provision name.

**Example**

```
OS10# show unit-provision

Node ID | Unit ID | Provision Name | Discovered Name | State |
-----+-----+-----+-----+-----+
1 | 71 | | | |
1 | 72 | | | |
1 | 73 | | | |
1 | 74 | | | |
1 | 75 | | | |
1 | 76 | | | |
1 | 77 | | | |
1 | 78 | 403RPK2 | 403RPK2 | up |
1 | 79 | | | |
1 | 80 | | | |
1 | 81 | | | |
1 | 82 | | | |
```

**Supported Releases** 10.4.0E(R3S) or later

## show vlan

Displays the current VLAN configuration.

**Syntax** `show vlan [vlan-id]`

**Parameters** `vlan-id` — (Optional) Enter a VLAN ID, from 1 to 4093.

**Default** Not configured

**Command Mode** EXEC

**Usage Information** None

**Example**

```
OS10# show vlan
Codes: * - Default VLAN, M - Management VLAN, R - Remote Port Mirroring
VLANs
Q: A - Access (Untagged), T - Tagged
NUM Status Description Q Ports
1 down
```

**Supported Releases** 10.2.0E or later

## shutdown

Disables an interface.

**Syntax** `shutdown`

**Parameters** None

**Default** Disabled

**Command Mode** INTERFACE

**Usage Information** This command marks a physical interface as unavailable for traffic. Disabling a VLAN or a port-channel causes different behavior. When you disable a VLAN, the L3 functions within that VLAN are disabled, and L2 traffic continues to flow. Use the `shutdown` command on a port-channel to disable all traffic on the port-channel, and the individual interfaces. Use the `no shutdown` command to enable a port-channel on the interface. The `shutdown` and `description` commands are the only commands that you can configure on an interface that is a port-channel member.

**Example**

```
OS10(config)# interface ethernet 1/1/7
OS10(conf-if-eth1/1/7)# no shutdown
```

**Supported Releases** 10.2.0E or later

## speed (Fibre Channel)

Configures the transmission speed of a Fibre Channel interface.

**Syntax** `speed {8 | 16 | 32 | auto}`

**Parameters** Set the speed of a Fibre Channel interface to:

- 8 — 8GFC
- 16 — 16GFC
- 32 — 32GFC
- `auto` — Set the port speed to the speed of the installed media.

**Defaults** Auto

**Command Mode** INTERFACE

**Usage Information**

- To configure oversubscription for bursty storage traffic on a FC interface, use the `speed` command. Oversubscription allows a port to operate faster, but may result in traffic loss. QSFP28 breakout interfaces in 4x16GFC mode support 32GFC oversubscription.
- The `no` version of this command resets the port speed to the default value `auto`.

**Example**

```
OS10(conf-if-fc-1/1/2)# speed 16
```

**Supported Releases** 10.3.1E or later

## speed (Management)

Configures the transmission speed of the Management interface.

**Syntax** `speed {10 | 100 | 1000 | auto}`

**Parameters** Set the Management port speed to:

- 10 — 10M
- 100 — 100M
- 1000 — 1000M
- `auto` — Set the port to auto-negotiate speed with a connected device.

**Defaults** Auto

**Command Mode** INTERFACE

**Usage Information**

- When you manually configure the Management port speed, match the speed of the remote device. Dell EMC highly recommends using auto-negotiation for the Management port.
- The `no` version of this command resets the port speed to the default value `auto`.

## Example

```
OS10 (conf-if-ma-1/1/1) # speed auto
```

## Supported Releases

10.3.0E or later

# switch-port-profile

Configures a port profile on the switch. The port profile determines the available front-panel ports and breakout modes.

**Syntax** `switch-port-profile node/unit profile`

- Parameters**
- `node/unit` — Enter switch information. For a standalone switch, enter 1/1.
  - `profile` — Enter the name of a platform-specific profile.

**Default** `profile-1`

**Command Mode** CONFIGURATION

## Usage Information

- S4148-ON Series port profiles:
  - `profile-1` — SFP+ 10G ports (1-24 and 31-54) and QSFP28 100G ports (25-26 and 29-30) are enabled.  
QSFP28 ports support 100GE and 4x10G, 4x25G, and 2x50G breakouts.
  - `profile-2` — SFP+ 10G ports (1-24 and 31-50), QSFP+ 40G ports (27-28), and QSFP28 ports in 40G mode (25-26 and 29-30) are enabled.  
QSFP+ and QSFP28 ports support 40GE and 4x10G breakouts.
  - `profile-3` — SFP+ 10G ports (5-24 and 31-50), QSFP+ 40G ports (27-28), and QSFP28 ports with 40G and 100G capability (25-26 and 29-30) are enabled.  
QSFP+ ports support 40GE and 4x10G breakouts. QSFP28 ports support 100GE and 4x25G breakouts with QSFP28 transceivers, and 40GE and 4x10G breakouts with QSFP+ transceivers.
  - `profile-4` — SFP+ 10G ports (5-24 and 31-50), QSFP+ 40G ports (27-28), and QSFP28 ports with 40G and 100G capability (25-26 and 29-30) are enabled.  
QSFP+ ports support 40GE and 4x10G breakouts. QSFP28 ports support 100GE and 2x50G breakouts with QSFP28 transceivers, and 40GE and 4x10G breakouts with QSFP+ transceivers.
  - `profile-5` — SFP+ 10G ports (1-24 and 31-54), QSFP+ 40G ports (27-28), QSFP28 ports with 40G capability (26 and 30), and QSFP28 ports with 40G and 100G capability (25 and 29) are enabled.  
QSFP+ ports support 40GE and 4x10G breakouts. QSFP28 ports 26 and 30 support 40GE and 4x10G breakouts with QSFP+ transceivers. QSFP28 ports 25 and 29 support 100GE and 4x25G breakouts with QSFP28 transceivers, and 40GE and 4x10G breakouts with QSFP+ transceivers.
  - `profile-6` — SFP+ 10G ports (1-24 and 31-54), QSFP+ 40G ports (27-28), QSFP28 ports with 40G capability (26 and 30), and QSFP28 ports with 40G and 100G capability (25 and 29) are enabled.  
QSFP+ ports support 40GE and 4x10G breakouts. QSFP28 ports 26 and 30 support 40GE and 4x10G breakouts with QSFP+ transceivers. QSFP28 ports 25 and 29 support 100GE and 2x50G breakouts with QSFP28 transceivers, and 40GE and 4x10G breakouts with QSFP+ transceivers.
- S4148U-ON Port profiles:
  - `profile-1` — SFP+ unified ports (1-24), QSFP28 unified ports (25-26 and 29-30), QSFP+ Ethernet ports (27-28), and SFP+ Ethernet ports (31-54) are enabled.
    - SFP+ unified port groups operate in FC mode with 2x16GFC breakouts (ports 1 and 3) by default and support 4x8GFC. SFP+ unified ports support Ethernet 10GE mode.

- QSFP28 unified ports 25 and 29 operate in Ethernet 100GE mode by default, and support 40GE with QSFP+ transceivers and 4x10G breakouts. QSFP28 ports 25 and 29 support 1x32GFC, 2x16GFC, and 4x8GFC in FC mode.
- QSFP28 unified ports 26 and 30 operate in Ethernet 40GE mode by default and support 4x10G breakouts. QSFP28 ports 26 and 30 support 1x32GFC, 2x16GFC, and 4x8GFC in FC mode.
- QSFP+ Ethernet ports operate at 40GE by default and support 4x10G breakouts.
- SFP+ Ethernet ports operate at 10GE.
- `profile-2` — SFP+ unified ports (1-24), QSFP28 unified ports (25-26 and 29-30), QSFP+ Ethernet ports (27-28), and SFP+ Ethernet ports (31-54) are enabled.
  - SFP+ unified ports operate in Ethernet 10GE mode by default. SFP+ unified port groups support 4x8GFC and 2x16GFC breakouts (ports 1 and 3) in FC mode.
  - QSFP28 unified ports 25 and 29 operate in Ethernet 100GE mode by default, and support 40GE with QSFP+ transceivers and 4x10G breakouts. QSFP28 ports 25 and 29 support 1x32GFC, 2x16GFC, and 4x8GFC in FC mode.
  - QSFP28 unified ports 26 and 30 operate in Ethernet 40GE mode by default and support 4x10G breakouts. QSFP28 ports 26 and 30 support 1x32GFC, 2x16GFC, and 4x8GFC in FC mode.
  - QSFP+ Ethernet ports operate at 40GE by default and support 4x10G breakouts.
  - SFP+ Ethernet ports operate at 10GE.
- `profile-3` — SFP+ unified ports (1-24), QSFP28 unified ports (25-26 and 29-30), and SFP+ Ethernet ports (31-54) are enabled. QSFP+ Ethernet ports (27-28) are not available.
  - SFP+ unified ports operate in Ethernet 10GE mode by default. SFP+ unified port groups support 4x8GFC and 2x16GFC breakouts (ports 1 and 3) in FC mode.
  - QSFP28 unified ports operate in Ethernet 100GE mode by default and support 4x25G and 4x10G breakouts. QSFP28 ports support 2x16GFC and 4x16GFC breakouts in FC mode.
  - SFP+ Ethernet ports operate at 10GE.
- `profile-4` — SFP+ unified ports (1-24), QSFP28 unified ports (25-26 and 29-30), and SFP+ Ethernet ports (31-54) are enabled. QSFP+ Ethernet ports (27-28) are not available.
  - SFP+ unified ports operate in Ethernet 10GE mode by default. SFP+ unified ports support 4x8FC in FC mode.
  - QSFP28 unified ports operate in Ethernet 100GE mode by default, and support 2x50G, 4x25G, and 4x10G breakouts. QSFP28 ports support 4x16GFC breakouts in FC mode.
  - SFP+ Ethernet ports operate at 10GE.

## Usage Information

- Setting a port group in 2x16GFC mode activates odd-numbered interfaces 1 and 3. A port group in 1x32GFC mode activates only interface 1.
- To display the current port profile on a switch, use the `show switch-port-profile` command.
- To change the port profile on a switch, use the `switch-port-profile` command with the desired profile, save it to the startup configuration and use the `reload` command to apply the change. The switch reboots with new port configuration. The `no` version of the command resets to the default profile. When a switch reloads with a new port profile, the startup configuration resets to system defaults, except for the switch-port profile and these configured settings:
  - Management interface 1/1/1 configuration
  - Management IPv4/IPv6 static routes
  - System hostname
  - Unified Forwarding Table (UFT) mode
  - ECMP maximum paths

You must manually reconfigure other settings on a switch after you apply a new port profile and use the `reload` command to apply the change.

## Example

```
OS10(config)# switch-port-profile 1/1 profile-1
Warning: Switch port profile will be applied only after a save and
reload. All management port
configurations will be retained but all other configurations will be
wiped out after the reload.
OS10(config)# do write memory
OS10(config)# do reload
```

**Supported Releases** 10.3.0E or later

## switchport access vlan

Assigns access VLAN membership to a port in L2 Access or Trunk mode.

**Syntax** `switchport access vlan vlan-id`

**Parameters** `vlan vlan-id` — Enter the VLAN ID number, from 1 to 4093.

**Default** VLAN 1

**Command Mode** INTERFACE

**Usage Information** This command enables L2 switching for untagged traffic and assigns a port interface to default VLAN1. Use this command to change the assignment of the access VLAN that carries untagged traffic. You must create the VLAN before you can assign an access interface to it. The `no` version of this command resets access VLAN membership on a L2 access or trunk port to VLAN 1.

### Example

```
OS10(conf-if-eth1/1/3)# switchport mode access
OS10(conf-if-eth1/1/3)# switchport access vlan 100
```

**Supported Releases** 10.2.0E or later

## switchport mode

Places an interface in L2 Access or Trunk mode.

**Syntax** `switchport mode {access | trunk}`

**Parameters**

- `access` — Enables L2 switching of untagged frames on a single VLAN.
- `trunk` — Enables L2 switching of untagged frames on the access VLAN, and of tagged frames on the VLANs specified with the `switchport trunk allowed vlan` command.

**Default** `access`

**Command Mode** INTERFACE

**Usage Information**

- If you assign an IP address to an interface, you cannot use this command to enable L2 switching — you must first remove the IP address.
- The `access` parameter automatically adds an interface to default VLAN1 to transmit untagged traffic. Use the `switchport access vlan` command to change the access VLAN assignment.
- The `trunk` parameter configures an interface to transmit tagged VLAN traffic. You must manually configure VLAN membership for a trunk port with the `switchport trunk allowed vlan` command.
- Use the `no switchport` command to remove all L2 configurations when you configure an L3 mode interface.
- Use the `no switchport mode` command to restore a trunk port on an interface to L2 Access mode on VLAN1.

### Example

```
OS10(conf-if-eth1/1/7)# switchport mode access
```

**Supported Releases** 10.2.0E or later



## switchport trunk allowed vlan

Configures the tagged VLAN traffic that a L2 trunk interface can carry. An L2 trunk port has no tagged VLAN membership and does not transmit tagged traffic.

|                          |                                                                                                                                                                       |
|--------------------------|-----------------------------------------------------------------------------------------------------------------------------------------------------------------------|
| <b>Syntax</b>            | <code>switchport trunk allowed vlan <i>vlan-id-list</i></code>                                                                                                        |
| <b>Parameters</b>        | <i>vlan-id-list</i> — Enter the VLAN numbers of the tagged traffic that the L2 trunk port can carry. Comma-separated and hyphenated VLAN number ranges are supported. |
| <b>Default</b>           | None                                                                                                                                                                  |
| <b>Command Mode</b>      | INTERFACE                                                                                                                                                             |
| <b>Usage Information</b> | Use the <code>no</code> version of this command to remove the configuration.                                                                                          |

### Example

```
OS10(conf-if-eth1/1/2)# switchport trunk allowed vlan 1000
```

```
OS10(conf-if-eth1/1/2)# no switchport trunk allowed vlan 1000
```

|                           |                  |
|---------------------------|------------------|
| <b>Supported Releases</b> | 10.2.0E or later |
|---------------------------|------------------|

## unit-provision

Provisions the unit ID of a Fabric Expander attached to an MX9116n Fabric Switching Engine in Full Switch mode.

|                          |                                                                                                                                                                                                                                                                                                                                                                                                                                                                                                                                                                                                                                                                                                             |
|--------------------------|-------------------------------------------------------------------------------------------------------------------------------------------------------------------------------------------------------------------------------------------------------------------------------------------------------------------------------------------------------------------------------------------------------------------------------------------------------------------------------------------------------------------------------------------------------------------------------------------------------------------------------------------------------------------------------------------------------------|
| <b>Syntax</b>            | <code>unit-provision <i>node/unit-id</i> <i>provision_name</i></code>                                                                                                                                                                                                                                                                                                                                                                                                                                                                                                                                                                                                                                       |
| <b>Parameters</b>        | <ul style="list-style-type: none"><li>• <i>node/unit-id</i> — Enter 1 for <i>node</i> with an unassigned unit ID displayed in the <code>show unit-provision</code> output.</li><li>• <i>provision_name</i> — Enter the service tag of the Fabric Expander displayed in the <code>show discovered-expanders</code> output.</li></ul>                                                                                                                                                                                                                                                                                                                                                                         |
| <b>Default</b>           | None                                                                                                                                                                                                                                                                                                                                                                                                                                                                                                                                                                                                                                                                                                        |
| <b>Command Mode</b>      | CONFIGURATION                                                                                                                                                                                                                                                                                                                                                                                                                                                                                                                                                                                                                                                                                               |
| <b>Usage Information</b> | <ul style="list-style-type: none"><li>• To verify the currently configured mode on a Fabric Engine, use the <code>show switch-operating-mode</code> command. If a Fabric Engine is in Full Switch mode, you must manually provision a Fabric Expander using the <code>unit-provision</code> command. This command assigns a unit ID to a service tag or provision name. To transmit server traffic, you must configure the virtual port on the Fabric Expander by entering the unit ID as the virtual-slot number using the <code>interface ethernet <i>node/virtual-slot/port</i></code> command.</li><li>• The <code>no</code> version of the command removes the Fabric Expander provisioning.</li></ul> |

### Example

```
OS10(config)# unit-provision 1/78 403RPK2
```

|                           |                       |
|---------------------------|-----------------------|
| <b>Supported Releases</b> | 10.4.0E(R3S) or later |
|---------------------------|-----------------------|

## wavelength

Configures wavelength for tunable 10-GB SFP+ optical transceiver.

|                   |                                                                                                                        |
|-------------------|------------------------------------------------------------------------------------------------------------------------|
| <b>Syntax</b>     | <code>wavelength <i>wavelength-value</i></code>                                                                        |
| <b>Parameters</b> | <i>wavelength-value</i> — Enter a value to set a wavelength for the SFP+ optics. The range is from 1528.38 to 1568.77. |
| <b>Defaults</b>   | None.                                                                                                                  |

|                           |                                                                                                                                                                                                                                                                                                                                                                 |
|---------------------------|-----------------------------------------------------------------------------------------------------------------------------------------------------------------------------------------------------------------------------------------------------------------------------------------------------------------------------------------------------------------|
| <b>Command Mode</b>       | INTERFACE CONFIGURATION                                                                                                                                                                                                                                                                                                                                         |
| <b>Usage Information</b>  | To specify the wavelength value, you must enter exactly six digits - four before and two after the decimal point. The value must conform to the following format: ABCD.EF; for example, 1545.23. Any number that does not conform to this format is rejected including whole numbers such as 1568. However, the following type of values are accepted: 1568.00. |
| <b>Example</b>            | <pre>OS10# configure terminal OS10(config)# interface ethernet 1/1/14 OS10(conf-if-eth1/1/14)# wavelength 1530.00</pre>                                                                                                                                                                                                                                         |
| <b>Supported Releases</b> | 10.4.2E or later                                                                                                                                                                                                                                                                                                                                                |

## default mtu

Configures the default MTU at system level.

|                           |                                                                                                                                               |
|---------------------------|-----------------------------------------------------------------------------------------------------------------------------------------------|
| <b>Syntax</b>             | default mtu <mtu-value>                                                                                                                       |
| <b>Parameters</b>         | None                                                                                                                                          |
| <b>Defaults</b>           | 1532                                                                                                                                          |
| <b>Command Mode</b>       | CONFIGURATION                                                                                                                                 |
| <b>Usage Information</b>  | The interface-level MTU may be different from the system-level MTU. The no version of this command resets the MTU value to the default value. |
| <b>Example</b>            | <pre>OS10# default mtu 9216</pre> <pre>OS10# no default mtu</pre>                                                                             |
| <b>Supported Releases</b> | 10.3.1E or later                                                                                                                              |

## show default mtu

Display the default MTU at system level.

|                           |                                                                     |
|---------------------------|---------------------------------------------------------------------|
| <b>Syntax</b>             | show default mtu                                                    |
| <b>Parameters</b>         | None                                                                |
| <b>Defaults</b>           | None                                                                |
| <b>Command Mode</b>       | EXEC                                                                |
| <b>Usage Information</b>  | The interface-level MTU may be different from the system-level MTU. |
| <b>Example</b>            | <pre>OS10# show default mtu Default MTU 9216 bytes</pre>            |
| <b>Supported Releases</b> | 10.3.1E or later                                                    |

## PowerEdge MX Ethernet I/O modules

The Dell EMC PowerEdge MX7000 supports the following Ethernet modules: MX9116n Fabric Switching Engine, MX7116n Fabric Expander Module, and MX5108n Ethernet Switch. For detailed information, see the Dell EMC PowerEdge MX7000 documentation.

- The MX9116n Fabric Switching Engine is a scalable L2/L3 switch designed that provides high-bandwidth, low-latency 25GE networking; for example, in private cloud and software-defined storage (SDS) networks. This high-end switch offers:
  - Sixteen 25GE server-facing ports
  - Twelve double-density QSFP (QSFP28-DD) ports that you can use to connect to Fabric Expanders or break out to: 8x10GE, 8x25GE, or 4x50GE ports for connection to rack servers or other Ethernet devices, or 2x40GE/2x100GE ports for uplinks, connection to SAN storage, and switch interconnects.
  - Two single-density QSFP28 ports that operate in 1x100GE, 2x50GE, 1x40GE, 4x25GE, or 4x10GE mode.
  - Two QSFP28 unified ports that operate in Ethernet or Fibre Channel 1x100GE, 1x40GE, 4x25GE, 4x10GE, 2x50GE, or 4x32GFC, 2x32GFC, 1x32GFC, or 4x16GFC mode.
- The MX7116n Fabric Expander Module operates as an unmanaged Ethernet repeater to connect servers to the Fabric Switching Engine using QSFP28-DD connections. The Expander Module offers:
  - Sixteen 25GE server-facing ports
  - Two QSFP28-DD ports for connection to a Fabric Switching Engine
- The MX5108n Ethernet Switch is a basic Ethernet switch designed to provide high-performance, low-latency networking for single MX7000 chassis installations. It provides FCoE transit, but no native Fibre Channel functionality, and offers:
  - Eight 25GE server-facing ports
  - Two 100GE QSFP28 uplink ports
  - One 40GE QSFP+ uplink port
  - Four 10GBase-T uplink ports

For more information, see:

- [Unified port groups](#) on page 248 — Ethernet and Fibre Channel interfaces
- [Double-density QSFP28 interfaces](#) on page 317
- [Single-density QSFP28 interfaces](#)
- [Server-facing interfaces](#)
- [Virtual ports](#)

## Operating modes

The MX9116n Fabric Switching Engine and the MX5108n Ethernet Switch operate in Full Switch and SmartFabric modes. A SmartFabric switch is automatically placed in SmartFabric mode. A switch that is not part of a SmartFabric is automatically placed in Full Switch mode. To verify the currently configured mode, use the `show switch-operating-mode` command.

```
OS10# show switch-operating-mode
Switch-Operating-Mode : Smart Fabric Mode
```

To change the mode, use the OpenManage Enterprise - Modular (OME-Modular) user interface. You cannot change the mode using the OS10 CLI. For more information, see the *Dell EMC OpenManage Enterprise - Modular User's Guide — Ethernet IO Modules chapter*.

### Full Switch mode

PowerEdge MX Ethernet switches operate in Full Switch mode by default. In Full Switch mode, all supported OS10 CLI commands and features that the hardware supports are available.

You can also perform certain tasks using the OpenManage Enterprise - Modular interface, including:

- Configure hostname and IP management protocols, such as SNMP and NTP.
- Set the port status up or down.

- Monitor system logs, alerts, and events.
- Update and manage the firmware.
- View the physical topology.
- Use power control.

### SmartFabric mode

In SmartFabric mode, the PowerEdge MX switches operate as Layer 2 I/O aggregation devices. The OpenManage Enterprise - Modular interface supports most switch configuration settings. Use SmartFabric mode to configure your switch.

SmartFabric mode supports all OS10 `show` commands and the following subset of CLI configuration commands: Other CLI configuration commands are not available.

- `clock` — Configure clock parameters.
- `end` — Exit to EXEC mode.
- `exit` — Exit from the current mode
- `help` — Display available commands.
- `hostname` — Set the system hostname.
- `interface` — Configure the management interface, a VLAN interface, or a range of interfaces.
- `ip name-server` — Configure the IP address of a name server; up to three name servers are supported.
- `logging` — Configure system logging.
- `management route` — Configure the IPv4 or IPv6 management route.
- `no` — Delete or disable commands in Configuration mode.
- `ntp` — Configure the network time protocol.
- `snmp-server` — Configure the SNMP server.
- `spanning-tree`
  - `disable` — Disable spanning tree globally.
  - `mac-flush-timer` — Set the time used to flush MAC address entries.
  - `mode` — Enable a spanning-tree mode, such as RSTP or MST.
  - `mst` — Configure multiple spanning-tree (MST) mode.
  - `rstp` — Configure rapid spanning-tree protocol (RSTP) mode.
  - `vlan` — Configure spanning-tree on a VLAN range.
- `username` — Create or modify user credentials.
- `SupportAssist` — Configure SupportAssist related settings.
- `Security` — Configure features corresponding to network security.
- `Fibre Channel` — Configure features corresponding to fibre channel interfaces.

**Table 17. Differences between operating modes**

| Full Switch mode                                                                               | SmartFabric mode                                                                                                                                                                                                                                                                                                                                                                                     |
|------------------------------------------------------------------------------------------------|------------------------------------------------------------------------------------------------------------------------------------------------------------------------------------------------------------------------------------------------------------------------------------------------------------------------------------------------------------------------------------------------------|
| All configuration changes you save are retained after you reload the switch.                   | <p>Only the configuration changes that you make using these OS10 administrative commands (supported in both modes) are saved and retained. All other CLI configuration commands are disabled.</p> <pre> clock hostname ip name-server logging management route ntp snmp-server spanning-tree username </pre> <p>The OpenManage Enterprise - Modular console manages the dataplane configuration.</p> |
| All switch interfaces are assigned to VLAN 1 by default, and are in the same L2 bridge domain. | Although front-panel port interfaces operate in L2 mode by default, L2 bridging is disabled.                                                                                                                                                                                                                                                                                                         |

**Table 17. Differences between operating modes (continued)**

| Full Switch mode                                                                                                                                                            | SmartFabric mode                                                                                                                                                                                      |
|-----------------------------------------------------------------------------------------------------------------------------------------------------------------------------|-------------------------------------------------------------------------------------------------------------------------------------------------------------------------------------------------------|
| All configuration changes are saved in the running configuration by default. To display the current configuration, use the <code>show running-configuration</code> command. | Verify configuration changes using feature-specific <code>show</code> commands, such as <code>show interface</code> and <code>show vlan</code> , instead of <code>show running-configuration</code> . |

## Changing operating modes

To switch an MX9116n Fabric Switching Engine or MX5108n Ethernet Switch between Full Switch and SmartFabric modes, use the OpenManage Enterprise - Modular interface to create a new fabric.

### Full Switch to SmartFabric mode

All Full Switch CLI configuration changes are deleted except for the subset of supported configuration commands that you can also enter and save in SmartFabric mode (see [Operating modes](#)).

### SmartFabric to Full Switch mode

When you change to Full Switch mode, only the configuration changes you make using the subset of configuration commands supported in both modes that are saved are retained.

In addition, the changes you make to port interfaces are deleted, except for admin state (shutdown/no shutdown), MTU, speed, and auto-negotiation mode. These changes are reapplied when the IOM moves to Full Switch mode.

## Restrictions

- VLANs 4001 to 4020 are reserved for internal switch communication and cannot be assigned to an interface.
- In SmartFabric mode, although you can use the CLI to create VLANs 1 to 4000 and 4021 to 4094, you cannot assign interfaces to them. For this reason, do not use the CLI to create VLANs in SmartFabric mode.
- On an MX7116n Fabric Expander, the two QSFP28-DD uplink interfaces operate only in Ethernet mode. Use the leftmost QSFP28-DD port 1 on the Fabric Expander to connect to servers with dual-port network interface cards (NICs). Do not use the rightmost QSFP28-DD port 2; it is reserved for future use to connect to servers with quad-port NICs.

 **NOTE:** Dell EMC Networking recommends disabling LLDP in the virtual distributed switch on VMware ESXi.

## Port groups on I/O modules

A port group is a logical port that consists of either a single or multiple hardware ports, and provides a single cable interface. On PowerEdge MX IO modules, only the MX9116n Fabric Switching Engine supports port groups:

- [Unified port groups](#)
- [Double-density QSFP interfaces](#)
- [Single-density QSFP interfaces](#)

The MX7116n Fabric Expander Module and MX5108n Ethernet Switch do not support port groups.

## Double-density QSFP28 interfaces

On the MX9116n Fabric Switching Engine module, configure a double-density QSFP28 (QSFP28-DD) port in PORT-GROUP mode. A QSFP28-DD port group consists of two Ethernet 100G ports. The ports do not function as a single 200GE port. Use a QSFP28-DD port to:

- Connect to a Fabric Expander to extend the fabric.
- Connect to an Ethernet rack server or storage device.
- Connect to another switch or router.

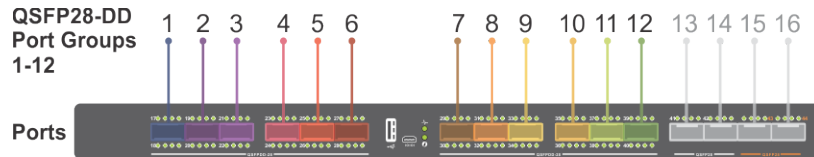

**Figure 5. MX9116n Fabric Switching Engine — QSFP28-DD port groups**

QSFP28-DD port groups are 1 to 12 and contain physical ports 1/1/17 to 1/1/40. Server-facing ports are 1/1/1 to 1/1/16.

**NOTE:** By default, the port group 10 is not in the fabric expander mode; so, to use port group 10 as FEM, breakout the port group in FabricExpander mode.

QSFP28-DD Ethernet interfaces support Fabric Expander mode (FEM) and native Ethernet mode.

- In FEM mode, an 8x25GE interface connects only to an attached Fabric Expander using supported cables.
- In native Ethernet mode, an interface connects to an upstream switch, rack server, or other Ethernet device.

By default, QSFP28-DD port groups 1 to 9 are configured in FEM mode with 8x25GE breakout interfaces enabled. QSFP28-DD port groups 10 to 12 are configured in native mode with 2x100GE breakout interfaces enabled.

- For information about how to configure single-density QSFP28 Ethernet port groups 13 and 14, see [Single-density QSFP28 interfaces](#).
- For information about how to configure unified port groups 15 and 16 to operate in Ethernet or Fibre Channel mode, see [Unified port groups](#) on page 248.
- If an MX9116n module is in SmartFabric mode, use the OpenManage Enterprise - Modular interface to configure breakout interfaces and speed on a QSFP28-DD port.

1. To configure a QSFP28-DD port interface, enter PORT-GROUP mode from CONFIGURATION mode. Enter 1/1 for *node/slot*. The QSFP28-DD port-group range is 1 to 12.

```
port-group node/slot/port-group
```

2. (Optional) To verify the current QSFP28-DD port-group configuration, enter the `show port-group` command.

```
OS10# show port-group
Port-group Mode Ports FEM
port-group1/1/1 Eth 25g-8x 17 18 FEM
port-group1/1/2 Eth 25g-8x 19 20 FEM
port-group1/1/3 Eth 25g-8x 21 22 FEM
port-group1/1/4 Eth 25g-8x 23 24 FEM
port-group1/1/5 Eth 25g-8x 25 26 FEM
port-group1/1/6 Eth 25g-8x 27 28 FEM
port-group1/1/7 Eth 25g-8x 29 30 FEM
port-group1/1/8 Eth 25g-8x 31 32 FEM
port-group1/1/9 Eth 25g-8x 33 34 FEM
port-group1/1/10 Eth 100g-2x 35 36 -
port-group1/1/11 Eth 100g-2x 37 38 -
port-group1/1/12 Eth 100g-2x 39 40 -
...
```

To reset a QSFP28-DD port group to its default setting, enter the `no mode` command in PORT-GROUP mode. This command sets QSFP-DD port groups 1 to 9 to 8x25GE FEM mode and QSFP-DD port groups 10 to 12 to 2x100GE mode.

```
no mode
```

3. To activate a QSFP28-DD interface for Ethernet operation, enter the `mode Eth` command in PORT-GROUP mode.

```
mode Eth {100g-2x | 50g-4x | 40g-2x | 25g-8x fabric-expander-mode | 25g-8x | 10g-8x}
```

- 100g-2x — Split a QSFP28-DD port into two 100GE interfaces.
- 50g-4x — Split a QSFP28-DD port into four 50GE interfaces.
- 40g-2x — Split a QSFP28-DD port into two 40GE interfaces.
- 25g-8x `fabric-expander-mode` — Split a QSFP28-DD port into eight 25GE interfaces for connection only to an MX7116n Fabric Expander.
- 25g-8x — Split a QSFP28-DD port into eight 25GE interfaces.

- 10g-8x — Split a QSFP28-DD port into eight 10GE interfaces.

4. Return to CONFIGURATION mode.

```
exit
```

5. Enter Ethernet Interface mode to configure other settings. Enter a single interface, a hyphen-separated range, or multiple interfaces separated by commas.

```
interface ethernet node/slot/port[:subport]
```

To display the Ethernet 100GE port configuration in a QSFP28-DD port group, enter the `show port-group` command. To display the Ethernet 25GE subport configuration, enter the `show interfaces status` command.

### Configure QSFP28-DD interface

```
OS10(config)# port-group 1/1/7
OS10(conf-pg-1/1/7)# mode Eth 25g-8x
OS10(conf-pg-1/1/7)# exit
OS10(config)# interface ethernet 1/1/29:4
OS10(conf-if-eth-1/1/29:4)#
```

### View QSFP28-DD interface

```
OS10(config)# interface ethernet 1/1/29:4
OS10(conf-if-eth1/1/29:4)# show configuration
!
interface ethernet1/1/29:4
no shutdown
```

### View QSFP28-DD port groups and default modes

```
OS10# show port-group
Port-group Mode Ports FEM
port-group1/1/1 Eth 25g-8x 17 18 FEM
port-group1/1/2 Eth 25g-8x 19 20 FEM
port-group1/1/3 Eth 25g-8x 21 22 FEM
port-group1/1/4 Eth 25g-8x 23 24 FEM
port-group1/1/5 Eth 25g-8x 25 26 FEM
port-group1/1/6 Eth 25g-8x 27 28 FEM
port-group1/1/7 Eth 25g-8x 29 30 FEM
port-group1/1/8 Eth 25g-8x 31 32 FEM
port-group1/1/9 Eth 25g-8x 33 34 FEM
port-group1/1/10 Eth 100g-2x 35 36 -
port-group1/1/11 Eth 100g-2x 37 38 -
port-group1/1/12 Eth 100g-2x 39 40 -
...
```

### View QSFP28-DD default 8x25G breakout interfaces

```
OS10# show interface status

Port Description Status Speed Duplex Mode Vlan Tagged-Vlans

...
Eth 1/1/17:1 down 0 auto A 1 -
Eth 1/1/17:2 down 0 auto A 1 -
Eth 1/1/17:3 down 0 auto A 1 -
Eth 1/1/17:4 down 0 auto A 1 -
Eth 1/1/18:1 down 0 auto A 1 -
Eth 1/1/18:2 down 0 auto A 1 -
Eth 1/1/18:3 down 0 auto A 1 -
Eth 1/1/18:4 down 0 auto A 1 -
Eth 1/1/19:1 down 0 auto A 1 -
Eth 1/1/19:2 down 0 auto A 1 -
Eth 1/1/19:3 down 0 auto A 1 -
Eth 1/1/19:4 down 0 auto A 1 -
Eth 1/1/20:1 down 0 auto A 1 -
Eth 1/1/20:2 down 0 auto A 1 -
Eth 1/1/20:3 down 0 auto A 1 -
Eth 1/1/20:4 down 0 auto A 1 -
```

```

Eth 1/1/21:1 down 0 auto A 1 -
Eth 1/1/21:2 down 0 auto A 1 -
Eth 1/1/21:3 down 0 auto A 1 -
Eth 1/1/21:4 down 0 auto A 1 -
Eth 1/1/22:1 down 0 auto A 1 -
Eth 1/1/22:2 down 0 auto A 1 -
Eth 1/1/22:3 down 0 auto A 1 -
Eth 1/1/22:4 down 0 auto A 1 -
...

```

## Virtual ports

A virtual port is a logical OS10 port that connects to a downstream server and has no physical hardware location on the switch. Virtual ports are created when an MX9116n Fabric Switching Engine onboard an MX7116n Fabric Expander Module. The onboarding process consists of discovery and configuration.

### Fabric Expander discovery

A Fabric Expander functions as an unmanaged Ethernet repeater with sixteen 25GE server-facing ports and two QSFP28-DD uplink ports. An attached Fabric Switching Engine in Full Switch mode automatically discovers the Fabric Expander when these conditions are met:

- The Fabric Expander is connected to the Fabric Engine by attaching a cable between a QSFP28-DD port on each device.
- On the Fabric Engine, the QSFP28-DD port-group connected to the Fabric Expander is in `25g-8x fabric-expander-mode` mode.
- At least one compute sled is installed in the MX7000 chassis containing the Fabric Expander.

**NOTE:** If you move a Fabric Expander by cabling it to a different QSFP28-DD port on the Fabric Engine, all software configurations on virtual ports are maintained. Only the QSFP28-DD breakout interfaces that map to the virtual ports change.

**NOTE:** If the servers in the MX7000 chassis have dual-port NICs, connect the Fabric Engine only to QSFP28-DD port 1 on the Fabric Expander. Do not connect to QSFP28-DD port 2.

To verify the auto-discovered Fabric Expanders, enter the `show discovered-expanders` command.

```

OS10# show discovered-expanders
Service-tag Model Type Chassis-service-tag Chassis-slot Port-group Virtual-Slot-
Id

-
403RPK2 MX7116n Fabric 1 SKY003Q A2 port-
group1/1/2
 Expander Module

```

### Fabric Expander virtual slot configuration

If the Fabric Switching Engine is in SmartFabric mode, an attached Fabric Expander is automatically configured:

- Virtual ports on the Fabric Expander and a virtual slot ID are created and mapped to 8x25GE breakout interfaces in FEM mode on the Fabric Engine.
- The unit ID is automatically discovered.
- Server traffic is transmitted through the QSFP28-DD uplink on the Fabric Expander to the Fabric Engine.

If the Fabric Switching Engine is in Full Switch mode, you can perform the same switch configuration using the CLI as in SmartFabric mode using the graphical user interface, except that you must manually configure the unit ID of the Fabric Expander. The unit ID is also called the *virtual slot ID*.

1. Locate the service tag of the Fabric Expander in the `show discovered-expanders` output.
2. Display the unassigned unit IDs reserved for Fabric Expanders in EXEC mode. The service tags of provisioned Fabric Expanders are displayed in the `Provision Name` column of the `show unit-provision` output.

```

OS10# show unit-provision

Node ID | Unit ID | Provision Name | Discovered Name | State |
-----+-----+-----+-----+-----+
1 | 71 | | | |
1 | 72 | | | |

```



```

1 | 73 | | | | |
1 | 74 | | | | |
1 | 75 | | | | |
1 | 76 | | | | |
1 | 77 | | | | |
1 | 78 | SP0012 | SP0012 | up |
1 | 79 | | | | |
1 | 80 | | | | |
1 | 81 | | | | |
1 | 82 | | | | |

```

3. Configure the unit ID for the service tag (provision name) of the Fabric Expander in CONFIGURATION mode.

```
OS10(config)# unit-provision node/unit-id provision_name
```

- *node/unit-id* — Enter 1 for *node* with an unassigned unit ID from the `show unit-provision` output.
- *provision\_name* — Enter the service tag of the Fabric Expander from the Service-tag field in the `show discovered-expanders` output.

4. Verify the discovered Fabric Expander and its virtual slot ID in EXEC mode.

```
OS10# show discovered-expanders

Service-tag Model Type Chassis-service-tag Chassis-slot Port-group Virtual-
Slot-Id

403RPK2 MX71116n Fabric 1 SKY003Q A2 port-group1/1/2
71
 Expander Module
```

When the Fabric Switching Engine discovers the Fabric Expander, it creates virtual ports by mapping each 8x25GE FEM breakout interface in port groups 1 to 9 to a Fabric Expander virtual port.

**Table 18. Example: Fabric Expander virtual port mapping**

| Fabric Expander service tag | Fabric Engine QSFP28-DD port group | Fabric Engine QSFP28-DD 8x25GE interfaces | Fabric Expander assigned unit ID (virtual slot) | Fabric Expander virtual ports |
|-----------------------------|------------------------------------|-------------------------------------------|-------------------------------------------------|-------------------------------|
| 403RPK2                     | 1/1/1                              | 1/1/17:1                                  | 71                                              | 1/71/1                        |
|                             |                                    | 1/1/17:2                                  |                                                 | 1/71/2                        |
|                             |                                    | 1/1/17:3                                  |                                                 | 1/71/3                        |
|                             |                                    | 1/1/17:4                                  |                                                 | 1/71/4                        |
|                             |                                    | 1/1/18:1                                  |                                                 | 1/71/5                        |
|                             |                                    | 1/1/18:2                                  |                                                 | 1/71/6                        |
|                             |                                    | 1/1/18:3                                  |                                                 | 1/71/7                        |
|                             |                                    | 1/1/18:4                                  |                                                 | 1/71/8                        |

**NOTE:** In the `show interface status` output, the Fabric Switching Engine 8x25GE interfaces that map to Fabric Expander virtual ports display as dormant.

```
OS10# show interface status

Port Description Status Speed Duplex Mode Vlan Tagged-Vlans

...
Eth 1/1/17:1 dormant
Eth 1/1/17:2 dormant
Eth 1/1/17:3 dormant
Eth 1/1/17:4 dormant
Eth 1/1/18:1 dormant
Eth 1/1/18:2 dormant
Eth 1/1/18:3 dormant

```

```
Eth 1/1/18:4 dormant
...
```

You can also use the `show interface` command to display the Fabric Engine physical port-to-Fabric Expander virtual port mapping, and the operational status of the line.

```
OS10# show interface ethernet 1/1/30:3
Ethernet 1/1/30:3 is up, line protocol is dormant
Interface is mapped to ethernet1/77/7
```

5. Verify the virtual ports on the Fabric Expander that are up and connected to servers in CONFIGURATION mode. Unit IDs 71 to 82 are used as virtual slot numbers 1/71 to 1/82 on the Fabric Expander.

```
OS10# show interface status
```

6. Configure a Fabric Expander virtual port to transmit server traffic in CONFIGURATION mode.

```
OS10# interface ethernet node/virtual-slot/port
```

- *node* is 1 for a Fabric Expander.
- *virtual-slot* is the unit ID number assigned to the Fabric Expander, from 71 to 82.
- *port* is the virtual port number 1 to 8.

### View Fabric Expander virtual ports

```
OS10# show interface status
```

| Port       | Description | Status | Speed | Duplex | Mode | Vlan | Tagged-Vlans |
|------------|-------------|--------|-------|--------|------|------|--------------|
| ...        |             |        |       |        |      |      |              |
| Eth 1/71/1 |             | up     | 25G   | auto   | A    | 1    | -            |
| Eth 1/71/2 |             | up     | 25G   | auto   | A    | 1    | -            |
| Eth 1/71/3 |             | down   | 0     | auto   | A    | 1    | -            |
| Eth 1/71/4 |             | down   | 0     | auto   | A    | 1    | -            |
| Eth 1/71/5 |             | down   | 0     | auto   | A    | 1    | -            |
| Eth 1/71/6 |             | up     | 25G   | auto   | A    | 1    | -            |
| Eth 1/71/7 |             | down   | 0     | auto   | A    | 1    | -            |
| Eth 1/71/8 |             | down   | 0     | auto   | A    | 1    | -            |
| Eth 1/72/1 |             | up     | 25G   | auto   | A    | 1    | -            |
| Eth 1/72/2 |             | up     | 25G   | auto   | A    | 1    | -            |
| Eth 1/72/3 |             | down   | 0     | auto   | A    | 1    | -            |
| Eth 1/72/4 |             | down   | 0     | auto   | A    | 1    | -            |
| Eth 1/72/5 |             | down   | 0     | auto   | A    | 1    | -            |
| Eth 1/72/6 |             | down   | 0     | auto   | A    | 1    | -            |
| Eth 1/72/7 |             | down   | 0     | auto   | A    | 1    | -            |
| Eth 1/72/8 |             | down   | 0     | auto   | A    | 1    | -            |
| Eth 1/73/1 |             | down   | 0     | auto   | A    | 1    | -            |
| Eth 1/73/2 |             | down   | 0     | auto   | A    | 1    | -            |
| Eth 1/73/3 |             | down   | 0     | auto   | A    | 1    | -            |
| Eth 1/73/4 |             | down   | 0     | auto   | A    | 1    | -            |
| Eth 1/73/5 |             | down   | 0     | auto   | A    | 1    | -            |
| Eth 1/73/6 |             | down   | 0     | auto   | A    | 1    | -            |
| Eth 1/73/7 |             | down   | 0     | auto   | A    | 1    | -            |
| Eth 1/73/8 |             | down   | 0     | auto   | A    | 1    | -            |
| ...        |             |        |       |        |      |      |              |
| Eth 1/81/1 |             | down   | 0     | auto   | A    | 1    | -            |
| Eth 1/81/2 |             | down   | 0     | auto   | A    | 1    | -            |
| Eth 1/81/3 |             | down   | 0     | auto   | A    | 1    | -            |
| Eth 1/81/4 |             | down   | 0     | auto   | A    | 1    | -            |
| Eth 1/81/5 |             | down   | 0     | auto   | A    | 1    | -            |
| Eth 1/81/6 |             | down   | 0     | auto   | A    | 1    | -            |
| Eth 1/81/7 |             | down   | 0     | auto   | A    | 1    | -            |
| Eth 1/81/8 |             | down   | 0     | auto   | A    | 1    | -            |
| Eth 1/82/1 |             | down   | 0     | auto   | A    | 1    | -            |
| Eth 1/82/2 |             | down   | 0     | auto   | A    | 1    | -            |
| Eth 1/82/3 |             | down   | 0     | auto   | A    | 1    | -            |
| Eth 1/82/4 |             | down   | 0     | auto   | A    | 1    | -            |
| Eth 1/82/5 |             | down   | 0     | auto   | A    | 1    | -            |
| Eth 1/82/6 |             | down   | 0     | auto   | A    | 1    | -            |

|            |      |   |      |   |   |   |
|------------|------|---|------|---|---|---|
| Eth 1/82/7 | down | 0 | auto | A | 1 | - |
| Eth 1/82/8 | down | 0 | auto | A | 1 | - |

## Single-density QSFP28 interfaces

On the MX9116n Fabric Switching Engine module, a QSFP28 port group consists of one Ethernet 100G port. By default, QSFP28 port groups 13 and 14 (physical ports 41 and 42) operate in 1x100GE mode.

For information about how to configure QSFP28-DD port groups 1 to 12 to operate in Ethernet mode, see [Double-density QSFP28 interfaces](#).

For information about how to configure unified port groups 15 and 16 to operate in Ethernet or Fibre Channel mode, see [Unified port groups](#).

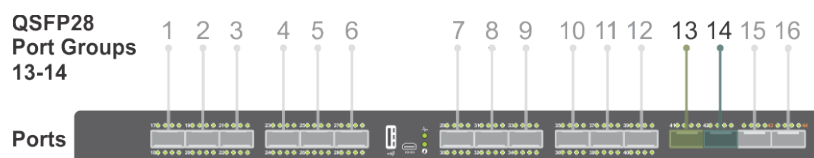

**Figure 6. MX9116n Fabric Switching Engine — QSFP28 port groups**

1. To configure a QSFP28 port-group interface, enter PORT-GROUP mode from CONFIGURATION mode. Enter 1/1 for *node/slot*. The QSFP28 port-group range is 13 to 14.

```
port-group node/slot/port-group
```

2. Activate the QSFP28 port-group interface for Ethernet operation in PORT-GROUP mode.

```
mode Eth {100g-1x | 50g-2x | 40g-1x | 25g-4x | 10g-4x}
```

- 100g-1x — Reset a port group to 100GE mode.
- 50g-2x — Split a QSFP28 port into two 50GE interfaces.
- 40g-1x — Split a QSFP28 port into one 40GE interface.
- 25g-4x — Split a QSFP28 port into four 25GE interfaces.
- 10g-4x — Split a QSFP28D port into four 10GE interfaces.

3. Return to CONFIGURATION mode.

```
exit
```

4. Enter Ethernet Interface mode to configure other settings. Enter a single interface, a hyphen-separated range, or multiple interfaces separated by commas.

```
interface ethernet node/slot/port[:subport]
```

To display the Ethernet ports in a QSFP28 port group, enter the `show port-group` command. To display the Ethernet 25GE subports, enter the `show interfaces status` command.

### Configure QSFP28 port-group interface

```
OS10(config)# port-group 1/1/13
OS10(conf-pg-1/1/13)# mode Eth 25g-4x
OS10(conf-pg-1/1/13)# exit
OS10(config)# interface ethernet 1/1/41:4
OS10(conf-if-eth-1/1/41:4)#
```

### View QSFP28 port-group interface

```
OS10(config)# interface ethernet 1/1/41:4
OS10(conf-if-eth1/1/41:4)# show configuration
!
interface ethernet1/1/41:4
no shutdown
```

## View QSFP28 port groups and default modes

```
OS10# show port-group
Port-group Mode Ports FEM
...
port-group1/1/13 Eth 100g-1x 41 -
port-group1/1/14 Eth 100g-1x 42 -
...
```

## View QSFP28 breakout interfaces

```
OS10# show interface status

Port Description Status Speed Duplex Mode Vlan Tagged-Vlans

...
Eth 1/1/41:1 down 0 auto A 1 -
Eth 1/1/41:2 down 0 auto A 1 -
Eth 1/1/41:3 down 0 auto A 1 -
Eth 1/1/41:4 down 0 auto A 1 -
Eth 1/1/42:1 down 0 auto A 1 -
Eth 1/1/42:2 down 0 auto A 1 -
Eth 1/1/42:3 down 0 auto A 1 -
Eth 1/1/42:4 down 0 auto A 1 -
...
```

# Server-facing interfaces

On the MX9116n Fabric Switching Engine and MX5108n Ethernet Switch, server-facing interfaces are internal and are enabled by default. To view the internal port connections to servers, use the `show inventory media` command.

In the output, a server-facing interface displays `INTERNAL` as its media. A `FIXED` port does not use external transceivers and always displays as `Dell EMC Qualified true`. To view the server-facing backplane port status, use the `show interface status` command.

**NOTE:** On the MX9116n Fabric Switching Engine, servers that have a dual-port NIC connect only to odd-numbered internal Ethernet interfaces; for example, 1/1/1, 1/1/3, 1/1/5, and so on.

## View internal Ethernet port-server connections — MX9116n Fabric Switching Engine

```
OS10# show inventory media

System Inventory Media

Node/Slot/Port Category Media Serial Dell EMC
Number Qualified

1/1/1 FIXED INTERNAL true
1/1/2 FIXED INTERNAL true
1/1/3 FIXED INTERNAL true
1/1/4 FIXED INTERNAL true
1/1/5 FIXED INTERNAL true
1/1/6 FIXED INTERNAL true
1/1/7 FIXED INTERNAL true
1/1/8 FIXED INTERNAL true
1/1/9 FIXED INTERNAL true
1/1/10 FIXED INTERNAL true
1/1/11 FIXED INTERNAL true
1/1/12 FIXED INTERNAL true
1/1/13 FIXED INTERNAL true
1/1/14 FIXED INTERNAL true
1/1/15 FIXED INTERNAL true
1/1/16 FIXED INTERNAL true
...
```

## View internal Ethernet port-server connections — MX5108n Ethernet Switch

```
OS10# show inventory media

System Inventory Media

Node/Slot/Port Category Media Serial Dell EMC
Number Qualified

1/1/1 FIXED INTERNAL true
1/1/2 FIXED INTERNAL true
1/1/3 FIXED INTERNAL true
1/1/4 FIXED INTERNAL true
1/1/5 FIXED INTERNAL true
1/1/6 FIXED INTERNAL true
1/1/7 FIXED INTERNAL true
1/1/8 FIXED INTERNAL true
...
```

## View internal Ethernet port status

```
OS10# show interface status

Port Description Status Speed Duplex Mode Vlan Tagged-Vlans

Eth 1/1/1 down 0 auto A 1 -
Eth 1/1/2 down 0 auto A 1 -
Eth 1/1/3 down 0 auto A 1 -
Eth 1/1/4 down 0 auto A 1 -
Eth 1/1/5 down 0 auto A 1 -
Eth 1/1/6 down 0 auto A 1 -
Eth 1/1/7 down 0 auto A 1 -
Eth 1/1/8 down 0 auto A 1 -
Eth 1/1/9 down 0 auto A 1 -
Eth 1/1/10 down 0 auto A 1 -
Eth 1/1/11 up 25G auto A 1 -
Eth 1/1/12 down 0 auto A 1 -
Eth 1/1/13 down 0 auto A 1 -
Eth 1/1/14 down 0 auto A 1 -
Eth 1/1/15 down 0 auto A 1 -
Eth 1/1/16 down 0 auto A 1 -
...
```

# Replace MX Ethernet I/O modules

OS10 enables you to replace an Ethernet I/O module (IOM) that is part of a SmartFabric or Full-Switch VLT, when an error occurs. The replacement mechanism is available for the following IOMs:

- MX9116n Fabric Switching Engine (FSE)
- MX5108n Ethernet Switch

For information about the MX modules and fabrics, see the Dell EMC PowerEdge MX7000 documentation. For more information about the operating modes and chassis, see Dell EMC OpenManage Enterprise - Modular documentation. The documents are available at the Dell EMC Networking website at [www.dell.com/support](http://www.dell.com/support).

## Deployment instructions

Dell EMC recommends:

- The replacement IOM must be a new device in the chassis deployment.
  - **NOTE:** New device means an IOM that is not deployed previously within the OME-Modular multi-chassis group.
- If the faulty IOM is in SmartFabric mode, the other IOM in the SmartFabric must be up and running.
- The new IOM must be the same model as the faulty IOM. For example: If the faulty IOM model is MX9116n FSE, you must use a new MX9116n FSE as a replacement IOM.

- Ensure that the new IOM has the same OS10 version as the faulty IOM. You can check the OS10 version by logging into the OME-Modular Graphical User Interface (GUI).

**NOTE:** OS10 is factory-installed in the MX9116n FSE or MX5108n Ethernet Switch. If the faulty IOM has an upgraded version of OS10, you must upgrade the new IOM to the same version. To upgrade an OS10 image, see [Download OS10 image for upgrade](#).

## Replace an IOM in Full-Switch VLT

To replace an IOM in Full-Switch mode and part of a VLT domain:

1. Physically remove the faulty IOM and insert the new IOM, see [Remove and replace the IOM](#).
2. Verify the firmware version and configure the IOM settings, see [Verify and configure IOM settings](#).
3. Connect the cables to the new IOM, see [Connect the cables to the new IOM](#).

## Replace an IOM in SmartFabric

To replace an IOM that is part of a SmartFabric:

1. Physically remove the faulty IOM and insert the new IOM, see [Remove and replace the IOM](#).
2. Verify the firmware version and configure the IOM settings, see [Verify and configure IOM settings](#).
3. Identify the master IOM connected in the PowerEdge MX chassis, see [Identify the master IOM](#).
4. Initiate the replacement workflow from the master IOM using the module replacement command, see [Initiate the module replacement workflow](#). The module replacement command is a Linux command that must be run from the Linux shell.
5. Connect the cables to the new IOM, see [Connect the cables to the new IOM](#).

**Master and member IOMs:** A single MX chassis supports four Ethernet IOMs, where one IOM is the master and the remaining three are members. In a multiple chassis environment, of all the IOMs connected in a scalable fabric, one IOM is the master and the remaining are members.

When an IOM is replaced, run the `sfs_node_replace.py` script to push the existing IOM configurations that are done through the smart fabric mode GUI to the new IOM.

**NOTE:** The configurations, `fcoe deny unicast-solicit` and `fcoe delay adv-timer` are not available even after running the `sfs_node_replace.py` script. The configurations are optional and, you have to reconfigure each time when a node is replaced.

## Remove and replace the faulty IOM

1. Identify the faulty IOM to replace.
2. Save the CLI configurations present in the faulty IOM.
3. Label each of the cables with the port numbers.
4. Remove the faulty IOM from the slot and disconnect the cables from the IOM.
5. Insert the new IOM into the empty slot.

**NOTE:** Do not reconnect the cables.

6. Confirm that the new IOM is recognized by OME-Modular.

**NOTE:** To confirm that the new IOM is listed in the correct Chassis and slot, log in to the OME-Modular GUI.

## Verify and configure IOM settings

- Verify the firmware version on the new IOM. If required, upgrade the firmware on the new IOM. To view the pending firmware upgrade, use the `show image firmware` command. For more information, see [Install firmware upgrade](#).
- Configure the hostname and IP management protocols, such as SNMP and NTP on the new IOM. For more information, see [System management](#).

**NOTE:** In SmartFabric Services mode, the OME-Modular GUI configurations specific to the faulty IOM apply to the new IOM. When you remove the faulty IOM, the CLI configurations are lost. Reapply the configurations in the new IOM using the OS10 CLI. SmartFabric Services mode supports all OS10 `show` commands and a subset of CLI configuration commands. For more information about supported commands, see [Operating modes](#).



**NOTE:** When you remove the faulty IOM in Full-Switch mode, the CLI configurations are lost. Reapply the configurations in the new IOM using OS10 CLI.

## Identify the master IOM

To initiate the module replacement process, identify the master IOM connected to the SmartFabric.

To identify the master IOM in the SmartFabric, use the `show smartfabric cluster member` command. Run the command from any of the IOMs connected in the SmartFabric. The content displayed varies depending on the switch role.

If the command is run on a member, the system displays only the details of the master IOM. The system displays information such as service tag and IPv6 address of the master. If the command is run in a master, the system displays the details of all the IOMs in the chassis deployment. Log in to the master IOM using the displayed IPv6 address before using the module replacement command.

Also you can view the IPv4 address of the master IOM using the `show smartfabric cluster` command.

To identify the master IOM:

- View the details of the master IOM using the `show smartfabric cluster member` command in the EXEC mode.

```
MX9116N-A1# show smartfabric cluster member
```

If you use the `show smartfabric cluster member` command on the master IOM, the system displays the following output:

```
MX9116N-A1# show smartfabric cluster member
Service-tag IP Address Status Role Type Chassis- Chassis
 -tag -Slot

HRA0024 fde1:53ba:e9a0:de14:2204:fff:fe13:143 ONLINE MASTER MX9116n ARH0006 B2
```

If you use the `show smartfabric cluster member` command on the member IOM, the system displays the following output:

```
MX9116N-B2# show smartfabric cluster member
Service IP Address Status Role Type Chassis- Chassis
-tag -tag -Slot

-
HRA0015 fde1:53ba:e9a0:de14:2204:fff:fe0c:d637 ONLINE BACKUP MX9116n ARH0004
B1
HRA0039 fde1:53ba:e9a0:de14:2204:fff:fe20:5249 ONLINE BACKUP MX9116n ARH0010
B1
HRA0016 fde1:53ba:e9a0:de14:2204:fff:fe0c:e637 ONLINE BACKUP MX9116n ARH0004
B2
HRA0035 fde1:53ba:e9a0:de14:2204:fff:fe21:7fc9 ONLINE BACKUP MX9116n ARH0009
B1
HRA0008 fde1:53ba:e9a0:de14:2204:fff:fe20:7f49 ONLINE BACKUP MX9116n ARH0002
B2
HRA0023 fde1:53ba:e9a0:de14:2204:fff:fe0c:f1b7 ONLINE BACKUP MX9116n ARH0006
B1
HRA0031 fde1:53ba:e9a0:de14:2204:fff:fe16:d553 ONLINE BACKUP MX9116n ARH0008
B1
HRA0036 fde1:53ba:e9a0:de14:2204:fff:fe20:56c9 ONLINE BACKUP MX9116n ARH0009
B2
HRA0019 fde1:53ba:e9a0:de14:2204:fff:fe21:1c9 ONLINE BACKUP MX9116n ARH0005
B1
HRA0017 fde1:53ba:e9a0:de14:2204:fff:fe21:9f49 ONLINE BACKUP MX9116n ARH0005
A1
HRA0032 fde1:53ba:e9a0:de14:2204:fff:fe17:3bd3 ONLINE BACKUP MX9116n ARH0008
B2
HRA0024 fde1:53ba:e9a0:de14:2204:fff:fe13:143 ONLINE MASTER MX9116n ARH0006 B2
...
```

## Log in to the master IOM from the member

To use the module replacement command, access the master IOM from the member.

Use the IPv6 address of the master IOM to log in to the master IOM. After logging in to the master IOM, use the module replacement command to initiate the replacement workflow.

1. Log in to the Linux shell from EXEC mode in the connected IOM.

```
OS10# system bash
admin@MX9116N-A2:~$
```

2. Log in to the master IOM using the IPv6 address displayed in the IOM.

```
admin@MX9116N-A1:~$ ssh admin@<ipv6-address>
```

Output example when you log in to the master IOM from the member IOM:

```
admin@OS10:~$ ssh admin@fdel:53ba:e9a0:cccc:3417:ebff:fe2c:ca84
Debian GNU/Linux 9

Dell EMC Networking Operating System (OS10)
admin@fdel:53ba:e9a0:cccc:3417:ebff:fe2c:ca84's password:
Linux OS10 4.9.110 #1 SMP Debian 4.9.110-3+deb9u4 x86_64

The programs included with the Debian GNU/Linux system are free software;
the exact distribution terms for each program are described in the
individual files in /usr/share/doc/*/copyright.

Debian GNU/Linux comes with ABSOLUTELY NO WARRANTY, to the extent
permitted by applicable law.

--*
-* Dell EMC Network Operating System (OS10) *-
-* *-
-* Copyright (c) 1999-2019 by Dell Inc. All Rights Reserved. *-
-* *-
--*

This product is protected by U.S. and international copyright and
intellectual property laws. Dell EMC and the Dell EMC logo are
trademarks of Dell Inc. in the United States and/or other
jurisdictions. All other marks and names mentioned herein may be
trademarks of their respective companies.

%Warning : Default password for admin account should be changed to secure the system
WARNING: Cluster manager is still using default credentials
```

## Initiate the module replacement workflow

To initiate the module replacement workflow, use the module replacement `sfs_node_replace.py` command from the master IOM. Enter the service tag information as the parameters in the module replacement command. You can find the service tag information in the Express Service Tag on the IOMs. To view the information, pull out the information tag in front of the system.

Before initiating the workflow, the system prompts for the `admin` credentials.

- Run the module replacement command from the Linux prompt. To display the service tag of an MX Ethernet I/O module, use the `show smartfabric cluster member` command in SmartFabric or Full Switch mode.

```
admin@MX9116N-A2:~$ sfs_node_replace.py NewServiceTag oldServiceTag
```

- `NewServiceTag` - Service tag of the new IOM
- `OldServiceTag` - Service tag of the faulty IOM



If the IOM is not part of the SmartFabric, the system displays the following error:

```
Enter the Username for the Admin: admin
Password:
No Fabric found for specified nodes. Please recheck and issue this command again.
```

Output example when you use the module replacement command in the master IOM:

```
admin@MX9116N-A2:~$ sfs_node_replace.py JDB1XC2 68RRNK2
Enter the Username for the Admin: admin
Password:
% Total % Received % Xferd Average Speed Time Time Time Current
 100 142 100 89 100 53 646 384 --:--:-- --:--:-- --:--:-- 649
Node replacement work-flow is initiated, the node JDB1XC2 will reboot into Fabric mode.
```

After successful authentication, the system initiates the module replacement workflow and the new IOM reboots and is placed in the SmartFabric Services mode.

## Connect the new IOM

After the switch reboots to the SmartFabric Services mode, connect all the cables as originally connected to the failed IOM.

# MX-IOM Hardware Replacement

### Pre-requisites

 **NOTE:** Prior to any IOM replacement activity, contact Dell technical support.

The firmware image should be uploaded to SCP server which is reachable across the network.

It is mandatory to have console access to connect to the IOM.

Before inserting the IOM into the chassis, ensure that you are able to monitor the boot up through console access. The image needs to be uploaded onto SCP Server which is accessible from the IOM.

Console connection to the IOM is mandatory to mitigate any latency issues which could cause the user on remote console to miss the output being shown in the console.

To replace the IOM hardware:

1. After the above prerequisite are met, insert the IOM into the chassis and monitor the GRUB menu to show up on the console.
2. After the GRUB menu is visible, select the ONIE option and then select ONIE uninstall OS option.
3. After ONIE uninstall process is completed, IOM boots into ONIE install OS mode.
4. From the ONIE install OS mode, copy the image file from the file server and perform an ONIE image install.

## View SmartFabric Services configuration

A SmartFabric is a network fabric that consists of physical resources, such as servers and switches and logical resources— networks, templates, and uplinks. SmartFabric Services is an OS10 feature enabled on PowerEdge MX Ethernet I/O modules.

When you create a SmartFabric using the OpenManage Enterprise - Modular (OME-Modular) user interface, the switches assigned to the fabric are automatically placed in SmartFabric mode. In SmartFabric mode, PowerEdge MX switches operate as Layer 2 I/O aggregation devices with complete interoperability with all major network equipment vendors.

Use the OME-Modular interface to configure PowerEdge MX networking in SmartFabric mode. For more information, see:

- *Dell EMC OpenManage Enterprise - Modular User's Guide, Ethernet IO Modules chapter*
- *Dell EMC PowerEdge MX SmartFabric Services Configuration and Troubleshooting Guide*

You can enter SmartFabric Services `show` commands from the OS10 CLI to view SmartFabric configuration information. For more information, see [SmartFabric commands](#).

# Fibre Channel

OS10 switches with Fibre Channel (FC) ports operate in one of the following modes: Direct attach (F\_Port), NPIV Proxy Gateway (NPG). In the FSB mode, you cannot use the FC ports.

## E\_Port

Expansion port (E\_Port) in a switch is used to connect two fiber channel switches to form a multiswitch SAN fabric.

The default port mode in a multiswitch setup is F. You can create a multiswitch fabric by configuring the port mode as E on the interface that connects two switches, which creates an interswitch link (ISL) consecutively. Enable the multiswitch fabric mode using the `feature fc [domain-id domain-id-val | npg | fip-snooping [with-cvl] | multi-switch]` command in CONFIGURATION mode.

```
OS10(config)# feature fc multi-switch
```

## F\_Port

Fibre Channel fabric port (F\_Port) is the switch port that connects the FC fabric to a host. S4148U-ON, MX9116n, and MX7116n switches support F\_Port.

Enable Fibre Channel F\_Port mode globally using the `feature fc domain-ID domain-ID` command in CONFIGURATION mode.

```
OS10(config)# feature fc domain-id 100
```

## NPIV Proxy Gateway

A node port (N\_Port) is a port on a network node that acts as a host or storage device, and is used in FC point-to-point or FC switched fabric topologies.

N\_Port ID Virtualization (NPIV) allows multiple N\_Port IDs to share a single physical N\_Port.

The NPIV Proxy Gateway (NPG) provides Fibre Channel over Ethernet (FCoE) to Fibre Channel (FC) bridging and conversely. Starting from OS 10.4.1, NPG supports FC to FC switching as well.

The S4148U-ON supports both, CNA and HBA, in NPG mode.

MX9116n, and MX7116n switches support NPG mode.

Enable NPG mode globally using the `feature fc npg` command in CONFIGURATION mode.

To change the port mode from default N\_Port, use the `fc port-mode F` command on FC interfaces.

**NOTE:** In a switch that is configured in NPG or F-Port mode, OS10 does not support scale profile VLAN configuration. To use scale profile configuration in NPG or F-Port mode, enable CPU-based VLAN flooding on the vfabric VLAN using the `mode L3` command.

## FIP snooping bridge

FCoE encapsulates FC frames over Ethernet networks. FCoE Initialization protocol (FIP) establishes FC connectivity with Ethernet ports. FSB implements security characteristics to admit valid FCoE traffic in the Ethernet networks. FIP and FCoE provide FC emulation-over-Ethernet links. OS10 switches with Ethernet ports operate in FSB.

MX9116n and MX5108n switches operate in Full Switch and SmartFabric modes. When the switch is in SmartFabric mode, it is recommended to use the untagged VLAN as 1 for FCoE-enabled interfaces.

```
OS10(config)# feature fip-snooping
```

An Ethernet switch operating in FSB mode snoops FIP packets on FCoE-enabled VLANs and discovers the following information:

- End nodes (E-Nodes)
- Fibre Channel Forwarder (FCF)
- Connections between E-Nodes and FCFs
- Sessions between E-Nodes and FCFs

**NOTE:** OS10 supports multiple E-Nodes in F\_Port mode.

**NOTE:** Remove all the NPIV Proxy Gateways (NPG), F-Port and vfabric related configurations from startup configuration before changing the IOM operating modes.

Using the discovered information, the switch installs ACL entries that provide security and point-to-point link emulation.

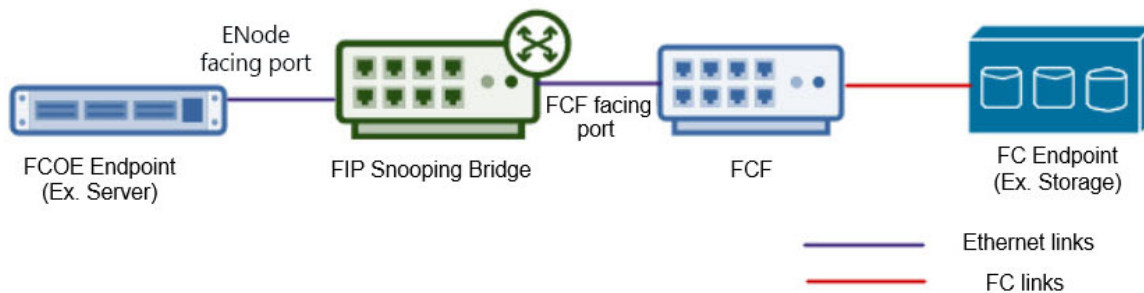

### Configuration notes

All Dell EMC PowerSwitches except MX-Series, S4200-Series, S5200 Series, and Z9332F-ON:

The total errors count in the show interface fibrechannel command output displays incorrect values during FC port flaps, IOM reboot, or port conversion from ETH to FC, followed by bringing up of the FC port.

**NOTE:** This behavior is seen only on the S4148U-ON switch.

## Fibre Channel over Ethernet

Fibre Channel over Ethernet (FCoE) encapsulates Fibre channel frames over Ethernet networks.

FCoE Initialization protocol (FIP) establishes Fibre channel connectivity with Ethernet ports.

FIP snooping bridge (FSB) implements security characteristics to admit valid FCoE traffic in the Ethernet networks.

FIP and FCoE provide FC emulation over Ethernet links.

An Ethernet switch configured to operate in FSB mode snoops FIP packets on FCoE enabled VLANs and discovers the following information:

**NOTE:** In FSB mode IOM supports only one Uplink port to NPG.

- End nodes (ENodes)
- Fibre channel forwarder (FCF)
- Connections between ENodes and FCFs
- Sessions between ENodes and FCFs

**NOTE:** OS10 supports multiple ENodes in F\_Port mode.

Using the discovered information, the switch installs ACL entries that provide security and point-to-point link emulation.

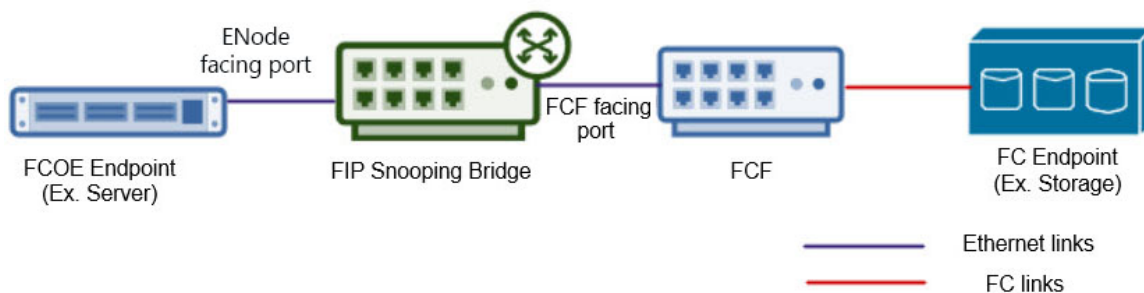

## Configure FIP snooping

1. Enable FIP snooping globally using the feature `fip-snooping` command in CONFIGURATION mode.
2. Before applying FIP snooping to a VLAN, ensure that the VLAN already contains Ethernet or LAG members that are enabled with FCF Port mode. Enable FCF mode on an Ethernet or port-channel using the `fip-snooping port-mode fcf` command in INTERFACE mode.
3. Enable FIP snooping on the VLAN using the `fip-snooping enable` command in VLAN INTERFACE mode. You can apply FIP snooping on a maximum of 12 VLANs.
4. Add an FC map to the VLAN with the `fip-snooping fc-map fc-map` command.
5. Configure the maximum number of ENode sessions to be allowed using the `fcoe max-sessions-per-enodemap max-session-number` command in CONFIGURATION mode, from 1 to 64.

**NOTE:** OS10 switches do not support multi-hop FIP snooping bridge (multi-hop FSB) capability; links to other FIP snooping bridges on a FIP snooping-enabled device (bridge-to-bridge links) are not supported.

### Configure FIP snooping bridge

```
OS10(config)# feature fip-snooping
OS10(config)# interface ethernet 1/1/32
OS10(conf-if-eth1/1/32)# fip-snooping port-mode fcf
OS10(conf-if-eth1/1/32)# exit
OS10(config)# interface vlan 100
OS10(conf-if-vl-100)# fip-snooping enable
OS10(conf-if-vl-100)# fip-snooping fc-map 0xEFC64
OS10(conf-if-vl-100)# exit
OS10(config)# fcoe max-sessions-per-enodemap 64
```

### View FIP snooping configuration details

```
OS10# show fcoe statistics interface vlan 100
Number of Vlan Requests :0
Number of Vlan Notifications :0
Number of Multicast Discovery Solicits :2
Number of Unicast Discovery Solicits :0
Number of FLOGI :2
Number of FDISC :16
Number of FLOGO :0
Number of Enode Keep Alive :9021
Number of VN Port Keep Alive :3349
Number of Multicast Discovery Advertisement :4437
Number of Unicast Discovery Advertisement :2
Number of FLOGI Accepts :2
Number of FLOGI Rejects :0
Number of FDISC Accepts :16
Number of FDISC Rejects :0
Number of FLOGO Accepts :0
Number of FLOGO Rejects :0
Number of CVL :0
Number of FCF Discovery Timeouts :0
Number of VN Port Session Timeouts :0
Number of Session failures due to Hardware Config :0
```

```
OS10# show fcoe vlan
* = Default VLAN
VLAN FC-MAP FCFs Enodes Sessions
---- -
*1 - - - -
100 0X0EFC00 1 2 17
```

```
OS10# show fcoe system
Mode: FIP Snooping Bridge
FCOE VLAN List (Operational) : 1, 100
FCFs : 1
```

```
Enodes : 2
Sessions : 17
```

```
OS10# show fcoe sessions
Enode MAC Enode Interface FCF MAC FCF interface VLAN FCoE
MAC FC-ID PORT WWPN PORT WWNN
aa:bb:cc:00:00:00 ethernet1/1/54 aa:bb:cd:00:00:00 port-channel5 100
0e:fc:00:01:00:01 01:00:01 31:00:0e:fc:00:00:00:00 21:00:0e:fc:00:00:00:00
aa:bb:cc:00:00:00 ethernet1/1/54 aa:bb:cd:00:00:00 port-channel5 100
0e:fc:00:01:00:02 01:00:02 31:00:0e:fc:00:00:00:00 21:00:0e:fc:00:00:00:00
```

```
OS10# show fcoe fcf
FCF MAC FCF Interface VLAN FC-MAP FKA_ADV_PERIOD No. of Enodes

54:7f:ee:37:34:40 port-channel5 100 0e:fc:00 4000 2
```

```
OS10# show fcoe enode
Enode MAC Enode Interface VLAN FCFs Sessions

d4:ae:52:1b:e3:cd ethernet1/1/54 100 1 5
```

## Terminology

|                 |                                                                                                 |
|-----------------|-------------------------------------------------------------------------------------------------|
| <b>ENode</b>    | End Node or FCoE node                                                                           |
| <b>FC</b>       | Fibre Channel                                                                                   |
| <b>FC ID</b>    | A 3-byte address used by FC to identify the end points                                          |
| <b>FC Map</b>   | A 3-byte prefix configured per VLAN, used to frame FCoE MAC address                             |
| <b>FCF</b>      | Fibre Channel Forwarder                                                                         |
| <b>FCoE</b>     | Fibre Channel over Ethernet                                                                     |
| <b>FCoE MAC</b> | Unique MAC address used to identify an FCoE session. This is a combination of FC ID and FC Map. |
| <b>FIP</b>      | FCoE Initialization Protocol                                                                    |
| <b>NPG</b>      | NPIV Proxy Gateway                                                                              |
| <b>NPIV</b>     | N_Port ID Virtualization                                                                        |

## Virtual fabric

Virtual fabrics (vfabric) divide a physical fabric into logical fabrics. Manage each vfabric independently. The fabric ID identifies each vfabric. You can configure only one vfabric in F\_Port mode and multiple vfabric in NPG mode. F\_Port and NPG modes are mutually exclusive.

If you have already configured a vfabric in F\_Port mode, while configuring vfabric in NPG mode, disable F\_Port mode. When you disable F\_Port mode, the existing vfabric is removed and you must configure new vfabric in NPG mode. If you are moving from NPG mode to F\_Port mode, disable NPG mode and create the new vfabric in F\_Port mode.

Zoning allows you to increase network security by partitioning the devices connected to the vfabric into subsets. Partitioning restricts unnecessary interactions between the members of vfabric. For more information, see [Fibre Channel zoning](#) on page 337.

After configuring a vfabric ID, you can create a name, associate a VLAN to carry traffic to the vfabric, configure FCoE parameters, configure the default zone, and activate the zoneset.

 **NOTE:** Do not associate a VLAN that is already in use as a vfabric VLAN.

To configure a vfabric in F\_Port mode:

1. Configure a vfabric using the `vfabric fabric-ID` command in CONFIGURATION mode. The switch enters vfabric CONFIGURATION mode
2. Associate a VLAN ID to the vfabric with the `vlan vlan-ID` command.
3. Add an FC map with the `fcoe fcmap fc-map` command.
4. Activate a zoneset using the `zoneset activate zoneset-name` command.
5. Allow access to all logged-in members in the absence of an active zoneset configuration using the `zone default-zone permit` command. The logged-in members are the FC nodes that are successfully logged into the FC fabric, identified by the vfabric.
6. (Optional) Add a name to the vfabric using the `name vfabric-name` command.
7. Apply the vfabric to FC interfaces using the `vfabric fabric-ID` command in FC INTERFACE mode.

### Example configuration of vfabric in F\_Port mode

```
OS10(config)# vfabric 100
OS10(conf-vfabric-100)# name 100
OS10(conf-vfabric-100)# vlan 1023
OS10(conf-vfabric-100)# fcoe fcmap 0xEFC64
OS10(conf-vfabric-100)# zoneset activate set
OS10(conf-vfabric-100)# zone default-zone permit
OS10(conf-vfabric-100)# exit
OS10(config)# interface fibrechannel 1/1/1
OS10(conf-if-fc1/1/1)# vfabric 100
```

### View vfabric configuration

```
OS10(conf-vfabric-100)# show configuration
!
vfabric 100
 name 100
 vlan 1023
 fcoe fcmap 0xEFC64
 zoneset activate set
 zone default-zone permit
```

```
OS10# show vfabric
Fabric Name 100
Fabric Type FPORT
Fabric Id 100
Vlan Id 1023
FC-MAP 0xEFC64
Config-State ACTIVE
Oper-State UP
=====
Switch Config Parameters
=====
Domain ID 100
=====
Switch Zoning Parameters
=====
Default Zone Mode: Allow
Active ZoneSet: set
=====
Members
fibrechannel1/1/1
fibrechannel1/1/2
fibrechannel1/1/3
fibrechannel1/1/4
fibrechannel1/1/5
fibrechannel1/1/6
fibrechannel1/1/7
fibrechannel1/1/8
fibrechannel1/1/9
fibrechannel1/1/10
fibrechannel1/1/11
fibrechannel1/1/12
fibrechannel1/1/15
fibrechannel1/1/17
fibrechannel1/1/18
fibrechannel1/1/19
```

```

fibrenchannel1/1/20
fibrenchannel1/1/21
fibrenchannel1/1/22
fibrenchannel1/1/23
fibrenchannel1/1/24
fibrenchannel1/1/25:1
fibrenchannel1/1/29:1
fibrenchannel1/1/30:1
fibrenchannel1/1/30:3
=====

```

To configure a vfabric in NPG mode:

1. Configure a vfabric using the `vfabric fabric-ID` command in CONFIGURATION mode. The switch enters vfabric CONFIGURATION mode.
2. Associate a VLAN ID to the vfabric with the `vlan vlan-ID` command.
3. Add FCoE parameters with the `fcoe {fcmmap fc-map | fcf-priority fcf-priority-value | fka-adv-period adv-period | vlan-priority vlan-priority-value | keep-alive}` command.
4. (Optional) Add a name to the vfabric using the `name vfabric-name` command.
5. Apply the vfabric to interfaces using the `vfabric fabric-ID` command in INTERFACE mode.

### Configure vfabric in NPG mode

```

OS10(config)# vfabric 10
OS10(conf-vfabric-10)# name 10
OS10(conf-vfabric-10)# vlan 100
OS10(conf-vfabric-10)# fcoe fcmmap 0x0efc01
OS10(conf-vfabric-10)# fcoe fcf-priority 128
OS10(conf-vfabric-10)# fcoe fka-adv-period 8
OS10(conf-vfabric-10)# fcoe vlan-priority 3
OS10(conf-vfabric-10)# exit
OS10(config)# interface ethernet 1/1/31
OS10(conf-if-eth1/1/31)# vfabric 10

```

### View vfabric configuration

```

OS10(conf-vfabric-10)# show configuration
!
vfabric 10
 name 10
 vlan 100
 fcoe fcmmap 0xEFC01
 fcoe fcf-priority 128
 fcoe fka-adv-period 8
 fcoe vlan-priority 3

```

```

OS10# show vfabric
Fabric Name 10
Fabric Type NPG
Fabric Id 10
Vlan Id 100
FC-MAP 0xEFC01
Vlan priority 3
FCF Priority 128
FKA-Adv-Period Enabled,8
Config-State ACTIVE
Oper-State DOWN
=====
Members
=====

```

```

OS10# show running-configuration vfabric
!
vfabric 10
 name 10
 vlan 100
 fcoe fcmmap 0xEFC01
 fcoe fcf-priority 128

```



```
fcoe fka-adv-period 8
fcoe vlan-priority 3
```

## Fibre Channel zoning

Fibre Channel (FC) zoning partitions a FC fabric into subsets to restrict unnecessary interactions, improve security, and manage the fabric more effectively. Create zones and add members to the zone. Identify a member by an FC alias, world wide name (WWN), or FC ID. A zone can have a maximum of 255 unique members. Create zonesets and add the zones to a zoneset. A switch can have multiple zonesets, but you can activate only one zoneset at a time in a fabric.

1. (Optional) Create an FC alias using the `fc alias alias-name` command in CONFIGURATION mode. The switch enters Alias CONFIGURATION mode.
2. Add members to the alias using the `member {wwn wwn-ID | fc-id fc-id}` command in Alias CONFIGURATION mode. You can add a maximum of 255 unique members.
3. Create a zone using the `fc zone zone-name` command in CONFIGURATION mode. The switch enters Zone CONFIGURATION mode.
4. Add members to the zone with the `member {alias-name alias-name | wwn wwn-ID | fc-id fc-id}` command in Zone CONFIGURATION mode.
5. Create a zoneset using the `fc zoneset zoneset-name` command in CONFIGURATION mode. The switch enters Zoneset CONFIGURATION mode.
6. Add the existing zones to the zoneset with the `member zone-name` command in Zoneset CONFIGURATION mode.
7. Activate the zoneset using the `zoneset activate zoneset-name` command in vfabric CONFIGURATION mode. The members in the zoneset become active.
8. Allow access between all the logged-in FC nodes in the absence of an active zoneset configuration using the `zone default-zone permit` command in vfabric CONFIGURATION mode. A default zone advertises a maximum of 255 members in the registered state change notification (RSCN) message.

**NOTE:** The default-zone allows or denies access to the FC nodes when an active zoneset is not available. When the default-zone action is set to `permit`, the switch allows communication between all the possible pairs of FC nodes. When you do not configure the default-zone action, the switch denies any communication between FC nodes.

To configure the vfabric on FC interfaces, associate a VLAN ID to the vfabric and add an FC map. For more information, see [Virtual fabric](#) on page 334.

### Configure FC zoning

```
OS10(config)# fc zone hba1
OS10(config-fc-zone-hba1)# member wwn 10:00:00:90:fa:b8:22:19
OS10(config-fc-zone-hba1)# member wwn 21:00:00:24:ff:7b:f5:c8
OS10(config-fc-zone-hba1)# exit

OS10(config)# fc zoneset set
OS10(conf-fc-zoneset-set)# member hba1
OS10(conf-fc-zoneset-set)# exit

OS10(config)# vfabric 100
OS10(conf-vfabric-100)# zoneset activate set
OS10(conf-vfabric-100)# zone default-zone permit
```

### View FC zone configuration

```
OS10(config-fc-zone-hba1)# show configuration
!
fc zone hba1
 member wwn 21:00:00:24:ff:7b:f5:c8
 member wwn 10:00:00:90:fa:b8:22:19
```

```
OS10# show fc zone
```

| Zone Name | Zone Member                                        |
|-----------|----------------------------------------------------|
| hba1      | 21:00:00:24:ff:7b:f5:c8<br>10:00:00:90:fa:b8:22:19 |
| hba2      | 20:01:00:0e:1e:e8:e4:99                            |

```
50:00:d3:10:00:ec:f9:1b
50:00:d3:10:00:ec:f9:05
50:00:d3:10:00:ec:f9:1f
20:35:78:2b:cb:6f:65:57
```

## View FC zoneset configuration

```
OS10(conf-fc-zoneset-set)# show configuration
!
fc zoneset set
 member hba1
 member hba2
```

```
OS10# show fc zoneset active

vFabric id: 100
Active Zoneset: set
ZoneName ZoneMember
=====
hba2 *20:01:00:0e:1e:e8:e4:99
 20:35:78:2b:cb:6f:65:57
 50:00:d3:10:00:ec:f9:05
 50:00:d3:10:00:ec:f9:1b
 50:00:d3:10:00:ec:f9:1f

hba1 *10:00:00:90:fa:b8:22:19
 *21:00:00:24:ff:7b:f5:c8
```

```
OS10# show fc zoneset set
ZoneSetName ZoneName ZoneMember
=====
set hba1 21:00:00:24:ff:7b:f5:c8
 10:00:00:90:fa:b8:22:19
 21:00:00:24:ff:7f:ce:ee
 21:00:00:24:ff:7f:ce:ef

 hba2 20:01:00:0e:1e:e8:e4:99
 50:00:d3:10:00:ec:f9:1b
 50:00:d3:10:00:ec:f9:05
 50:00:d3:10:00:ec:f9:1f
 20:35:78:2b:cb:6f:65:57
```

## F\_Port on Ethernet

OS10 supports configuring F\_Port mode on an Ethernet port that connects to converged network adapters (CNA). After enabling F\_Port mode, configure a vfabric and apply the vfabric to Ethernet ports connected to CNA. You can configure only one vfabric in F\_Port mode.

You can apply the configured vfabric to multiple Ethernet interfaces. You can also add Ethernet interfaces to a port-channel and apply the vfabric to the port-channel.

### Example configuration

```
OS10(config)# feature fc domain-id 100
OS10(config)# vfabric 100
OS10(conf-vfabric-100)# name 100
OS10(conf-vfabric-100)# vlan 1023
OS10(conf-vfabric-100)# fcoe fcmap 0xEFC64
OS10(conf-vfabric-100)# zoneset activate set
OS10(conf-vfabric-100)# zone default-zone permit
OS10(conf-vfabric-100)# exit
OS10(config)# interface ethernet 1/1/30
OS10(conf-if-eth1/1/30)# vfabric 100
```

# Pinning FCoE traffic to a specific port of a port-channel

You can isolate FIP and FCoE traffic by configuring a pinned port at the FCoE LAG.

FCoE LAG is the port-channel used for FIP and FCoE traffic in the intermediate switches between server and storage devices.

VLT provides Active/Active LAN connectivity on converged links by forwarding traffic in multiple paths to multiple upstream devices without STP blocking any of the uplinks. This works for Ethernet traffic, but FCoE requires dedicated links for each SAN Fabric. FCoE traffic sent on VLT breaks SAN fabric isolation.

The FC sessions form between FC nodes and FCoE sessions happen between Ethernet nodes.

To form FC or FCoE sessions, the fabric login request and reply must traverse the switch through the same port. The fabric login request initiated from the server through the switch reaches the SAN Fabric. The login accept response is hashed out to any of the ports in the port-channel. If the server receives the response on a different port than where the request was sent, the server keeps retrying the request. Because of this action, the FC or FCoE sessions learnt based on the login accept response change to the unstable state. The sessions keep flapping until the request and response converge in the same port. To avoid this, pin one of the ports in the port-channel.

To support FCoE on multi-level VLT networks, use port pinning in FCoE LAGs. Port pinning is a static configuration that restricts the FIP and FCoE traffic to one port of the port-channel overriding hardware LAG hashing. The system classifies and redirects the packets exchanged during FCoE sessions to the port based on the ACL configuration. The remaining Ethernet traffic flows through both the pinned port and other ports in the port-channel, based on LAG hashing. Dell EMC recommends to use pinned port if there are more than one port in FCoE LAG. In a VLT network, the server has two unique FCoE sessions to SAN fabric and the traffic flows based on pinned port configuration. If there is only one port in the port-channel, there is no need for a pinned port.

**NOTE:** The pinned port configuration is supported on FSB, Ethernet downlink port-channel of NPG, and F\_Port mode.

## Limitations:

- The system uses an ACL table for ENode MAC with a redirect port option similar to FCF. This limits the number of FC or FCoE sessions.
- When the pinned port goes down, you must manually re-configure another active port in the port-channel as pinned port. You can perform this re-configuration only in the intermediate switches, but not in the server.
- If there is a mismatch in the configuration or if the pinned port goes down, the system does not use other ports in port-channel even if there is a valid path to server and storage device.
- When you add or remove a pinned port when FCoE sessions are active, the system clears and re-initiates the FCoE sessions based on the configuration. The system displays warning messages during the configuration.

The following illustrations show VLT and non-VLT networks with FCoE traffic flowing through pinned port.

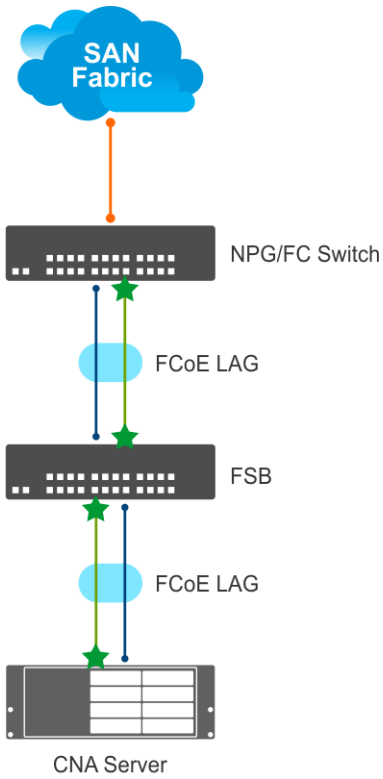
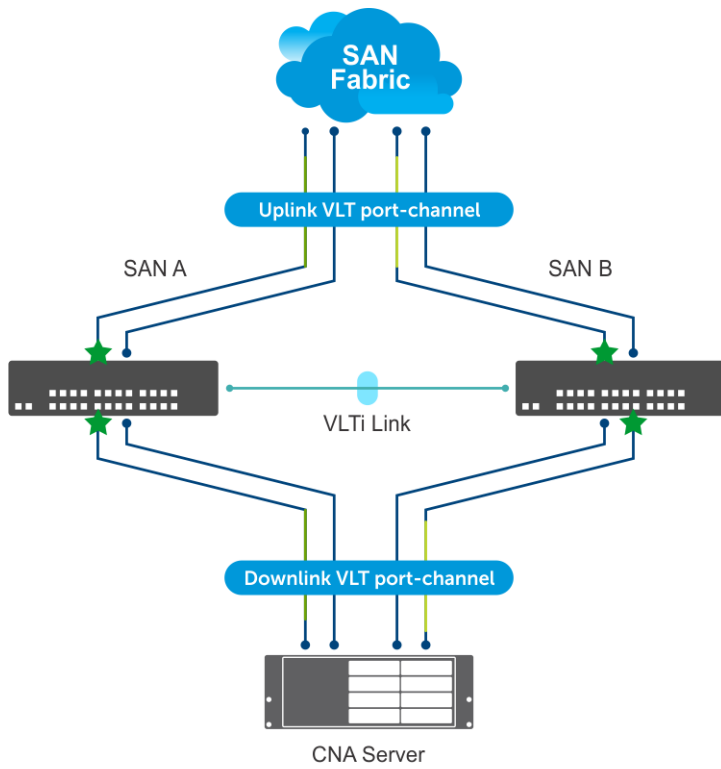

## Sample FSB configuration on VLT network

1. Enable the FIP snooping feature globally.

```
OS10(config)# feature fip-snooping
```

2. Create the FCoE VLAN.

```
OS10(config)#interface vlan 1001
OS10(conf-if-vl-1001)# fip-snooping enable
```

3. Configure the VLTi interface.

```
OS10(config)# interface ethernet 1/1/27
OS10(conf-if-eth1/1/27)# no shutdown
OS10(conf-if-eth1/1/27)# no switchport
```

4. Configure the VLT.

```
OS10(config)# vlt-domain 1
OS10(conf-vlt-1)# backup destination 10.16.151.110 <<Enter the management IP address
of the VLT peer>>
OS10(conf-vlt-1)# discovery-interface ethernet1/1/27
```

5. Enable DCBX.

```
OS10(config)# dcbx enable
```

6. Enable the PFC parameters on the interfaces.

```
OS10(config)# class-map type network-qos fcoematch
OS10(config-cmap-nqos)# match qos-group 3
OS10(config-cmap-nqos)# exit
OS10(config)# policy-map type network-qos PFC
OS10(config-pmap-network-qos)# class fcoematch
OS10(config-pmap-c-nqos)# pause
OS10(config-pmap-c-nqos)# pfc-cos 3
```

7. Create uplink and downlink port-channels, and configure the FCF facing port.

```
OS10(config)# interface port-channel 10
OS10(conf-if-po-10)# description uplink_VLT_LAG
OS10(conf-if-po-10)# no shutdown
OS10(conf-if-po-10)# switchport mode trunk
OS10(conf-if-po-10)# switchport access vlan 1
OS10(conf-if-po-10)# switchport trunk allowed vlan 1001,10
OS10(conf-if-po-10)# vlt-port-channel 1
OS10(conf-if-po-10)# fip-snooping port-mode fcf
```

```
OS10(config)# interface port-channel 20
OS10(conf-if-po-20)# description downlink_VLT_LAG
OS10(conf-if-po-20)# no shutdown
OS10(conf-if-po-20)# switchport mode trunk
OS10(conf-if-po-20)# switchport access vlan 1
OS10(conf-if-po-20)# switchport trunk allowed vlan 1001,10
OS10(conf-if-po-20)# vlt-port-channel 2
```

8. Apply the PFC configuration on downlink and uplink interfaces. In addition, include the interfaces to the port-channel and configure one of the interfaces as pinned-port.

```
OS10(config)# interface ethernet 1/1/1
OS10(conf-if-eth1/1/1)# description uplink_port_channel_member1
OS10(conf-if-eth1/1/1)# no shutdown
OS10(conf-if-eth1/1/1)# channel-group 10 mode active
OS10(conf-if-eth1/1/1)# fcoe-pinned-port
OS10(conf-if-eth1/1/1)# no switchport
```

```
OS10(config-if-eth1/1/1)# service-policy input type network-qos PFC
OS10(config-if-eth1/1/1)# priority-flow-control mode on
```

```
OS10(config)# interface ethernet 1/1/2
OS10(config-if-eth1/1/2)# description uplink_port_channel_member2
OS10(config-if-eth1/1/2)# no shutdown
OS10(config-if-eth1/1/2)# channel-group 10 mode active
OS10(config-if-eth1/1/2)# no switchport
OS10(config-if-eth1/1/2)# service-policy input type network-qos PFC
OS10(config-if-eth1/1/2)# priority-flow-control mode on
```

```
OS10(config)# interface ethernet 1/1/3
OS10(config-if-eth1/1/3)# description downlink_port_channel_member1
OS10(config-if-eth1/1/3)# no shutdown
OS10(config-if-eth1/1/3)# channel-group 20 mode active
OS10(config-if-eth1/1/3)# fcoe-pinned-port
OS10(config-if-eth1/1/3)# no switchport
OS10(config-if-eth1/1/3)# service-policy input type network-qos PFC
OS10(config-if-eth1/1/3)# priority-flow-control mode on
```

```
OS10(config)# interface ethernet 1/1/4
OS10(config-if-eth1/1/4)# description downlink_port_channel_member2
OS10(config-if-eth1/1/4)# no shutdown
OS10(config-if-eth1/1/4)# channel-group 20 mode active
OS10(config-if-eth1/1/4)# no switchport
OS10(config-if-eth1/1/4)# service-policy input type network-qos PFC
OS10(config-if-eth1/1/4)# priority-flow-control mode on
```

## View the configuration

VLT details:

```
OS10# show vlt 1
Domain ID : 1
Unit ID : 2
Role : primary
Version : 2.0
Local System MAC address : 50:9a:4c:d3:cf:70
Primary priority : 32768
VLT MAC address : 50:9a:4c:d3:cf:70
IP address : fda5:74c8:b79e:1::2
Delay-Restore timer : 90 seconds
Peer-Routing : Disabled
Peer-Routing-Timeout timer : 0 seconds
VLTi Link Status
 port-channel1000 : up
```

| VLT | Peer | Unit ID | System MAC Address | Status | IP Address          | Version |
|-----|------|---------|--------------------|--------|---------------------|---------|
| 1   |      |         | 50:9a:4c:d3:e2:f0  | up     | fda5:74c8:b79e:1::1 | 2.0     |

```
OS10# show vlt 1 vlt-port-detail
```

```
vlt-port-channel ID : 1
VLT Unit ID Port-Channel Status Configured ports Active ports

 1 port-channel10 up 2 2
* 2 port-channel10 up 2 2
vlt-port-channel ID : 2
VLT Unit ID Port-Channel Status Configured ports Active ports

 1 port-channel20 up 2 2
* 2 port-channel20 up 2 2
```

Discovered ENodes:

```
OS10# show fcoe enode
Enode MAC Enode Interface VLAN FCFs Sessions

f4:e9:d4:a4:7d:c3 Po 20(Eth 1/1/3) 1001 1 1
```

Discovered FCFs:

```
OS10# show fcoe fcf
FCF MAC FCF Interface VLAN FC-MAP FKA_ADV_PERIOD No. of Enodes

14:18:77:20:78:e0 Po 10(Eth 1/1/1) 1001 0e:fc:00 8000 1
```

FCoE sessions:

```
Enode MAC Enode Interface FCF MAC FCF interface VLAN FCoE
MAC FC-ID PORT WWPN PORT WWNN

f4:e9:d4:a4:7d:c3 Po20(Eth 1/1/3) 14:18:77:20:78:e0 Po 10(Eth 1/1/1)
1001 0e:fc:00:01:00:00 01:34:02 20:01:f4:e9:d4:a4:7d:c3 20:00:f4:e9:d4:a4:7d:c3
```

Pinned port status:

```
OS10# show fcoe pinned-port
Interface pinned-port FCoE Status

Po 10 Eth 1/1/1 Up
Po 20 Eth 1/1/3 Up
```

## Sample FC Switch configuration on VLT network

1. Enable the F\_PORT mode.

```
OS10(config)# feature fc domain-id 1
```

2. Create the FC zones.

```
OS10(config)# fc zone zoneA
OS10(config-fc-zone-zoneA)# member wwn 10:00:00:90:fa:b8:22:19 <<Enter the WWN of Initiator CNA>>
OS10(config-fc-zone-zoneA)# member wwn 21:00:00:24:ff:7b:f5:c8 <<Enter the WWN of Target>>
```

3. Create the FC zoneset.

```
OS10(config)# fc zoneset zonesetA
OS10(conf-fc-zoneset-zonesetA)# member zoneA
```

4. Create the vfabric VLAN.

```
OS10(config)# interface vlan 1001
```

5. Create vfabric and activate the FC zoneset.

```
OS10(config)# vfabric 1
OS10(conf-vfabric-1)# vlan 1001
OS10(conf-vfabric-1)# fcoe fcmap 0xEFC00
OS10(conf-vfabric-1)# zoneset activate zonesetA
```

6. Configure the VLTi interface.

```
OS10(config)# interface ethernet 1/1/27
OS10(conf-if-eth1/1/27)# no shutdown
OS10(conf-if-eth1/1/27)# no switchport
```

7. Configure the VLT.

```
OS10(config)# vlt-domain 10
OS10(conf-vlt-10)# backup destination 10.16.151.110
OS10(conf-vlt-10)# discovery-interface ethernet1/1/27
```

## 8. Enable DCBX.

```
OS10(config)# dcbx enable
```

## 9. Apply the vfabric on the interfaces.

```
OS10(config)# interface port-channel 10
OS10(config-if-po-10)# description downlink_VLT_LAG_to_FSB
OS10(config-if-po-10)# no shutdown
OS10(config-if-po-10)# switchport mode trunk
OS10(config-if-po-10)# switchport access vlan 1
OS10(config-if-po-10)# switchport trunk allowed vlan 10
OS10(config-if-po-10)# vlt-port-channel 1
OS10(config-if-po-10)# vfabric 1
```

```
OS10(config)# interface fibrechannel 1/1/26
OS10(config-if-fc1/1/26)# description target_connected_port
OS10(config-if-fc1/1/26)# no shutdown
OS10(config-if-fc1/1/26)# vfabric 1
```

## 10. Apply the PFC configuration on the downlink interfaces. Include the interfaces to the port-channel and configure one of the interfaces as pinned-port.

```
OS10(config)# interface ethernet 1/1/9
OS10(config-if-eth1/1/9)# description downlink_port_channel_member1
OS10(config-if-eth1/1/9)# no shutdown
OS10(config-if-eth1/1/9)# channel-group 10 mode active
OS10(config-if-eth1/1/9)# fcoe-pinned-por
OS10(config-if-eth1/1/9)# no switchport
OS10(config-if-eth1/1/9)# service-policy input type network-qos PFC
OS10(config-if-eth1/1/9)# priority-flow-control mode on
```

```
OS10(config)# interface ethernet 1/1/10
OS10(config-if-eth1/1/10)# description downlink_port_channel_member2
OS10(config-if-eth1/1/10)# no shutdown
OS10(config-if-eth1/1/10)# channel-group 10 mode active
OS10(config-if-eth1/1/10)# no switchport
OS10(config-if-eth1/1/10)# service-policy input type network-qos PFC
OS10(config-if-eth1/1/10)# priority-flow-control mode on
```

## View configuration

Name server entries:

```
OS10# show fc ns switch brief
Total number of devices = 2
Intf# Domain FC-ID Enode-WWPN Enode-WWNN
port-channel10(Eth 1/1/9) 1 01:00:00 20:01:f4:e9:d4:a4:7d:c3
20:00:f4:e9:d4:a4:7d:c3
fibrechannel1/1/26 1 01:68:00 21:00:00:24:ff:7c:ae:0e
21:00:00:24:ff:7c:ae:0e
```

Zoneset details:

```
vFabric id: 1
Active Zoneset: zonesetA
ZoneName ZoneMember
=====
zoneA *20:01:f4:e9:d4:a4:7d:c3
 *21:00:00:24:ff:7c:ae:0e
```

Pinned port status:

```
OS10# show fcoe pinned-port
Interface pinned-port FCoE Status

Po 10 Eth 1/1/9 Up
```



## Sample FSB configuration on non-VLT network

The following examples illustrate configurations in intermediate switches in non-vlt network, to communicate with server.

1. Enable the FIP snooping feature globally.

```
OS10(config)# feature fip-snooping
```

2. Create the FCoE VLAN.

```
OS10(config)#interface vlan 1001
OS10(conf-if-vl-1001)# fip-snooping enable
```

3. Enable DCBX.

```
OS10(config)# dcbx enable
```

4. Enable the PFC parameters on the interfaces.

```
OS10(config)# class-map type network-qos fcoematch
OS10(config-cmap-nqos)# match qos-group 3
OS10(config-cmap-nqos)# exit
OS10(config)# policy-map type network-qos PFC
OS10(config-pmap-network-qos)# class fcoematch
OS10(config-pmap-c-nqos)# pause
OS10(config-pmap-c-nqos)# pfc-cos 3
```

5. Create uplink and downlink port-channels, and configure the FCF facing port.

```
OS10(config)# interface port-channel 10
OS10(conf-if-po-10)# no shutdown
OS10(conf-if-po-10)# switchport mode trunk
OS10(conf-if-po-10)# switchport access vlan 1
OS10(conf-if-po-10)# switchport trunk allowed vlan 1001,10
OS10(conf-if-po-10)# fip-snooping port-mode fcf
```

```
OS10(config)# interface port-channel 20
OS10(conf-if-po-20)# no shutdown
OS10(conf-if-po-20)# switchport mode trunk
OS10(conf-if-po-20)# switchport access vlan 1
OS10(conf-if-po-20)# switchport trunk allowed vlan 1001,10
```

6. Apply the PFC configuration on downlink and uplink interfaces. In addition, include the interfaces to the port-channel and configure one of the interfaces as pinned-port.

```
OS10(config)# interface ethernet 1/1/1
OS10(conf-if-eth1/1/1)# no shutdown
OS10(conf-if-eth1/1/1)# channel-group 10 mode active
OS10(conf-if-eth1/1/1)# fcoe-pinned-port
OS10(conf-if-eth1/1/1)# no switchport
OS10(conf-if-eth1/1/1)# service-policy input type network-qos PFC
OS10(conf-if-eth1/1/1)# priority-flow-control mode on
```

```
OS10(config)# interface ethernet 1/1/2
OS10(conf-if-eth1/1/2)# no shutdown
OS10(conf-if-eth1/1/2)# channel-group 10 mode active
OS10(conf-if-eth1/1/2)# no switchport
OS10(conf-if-eth1/1/2)# service-policy input type network-qos PFC
OS10(conf-if-eth1/1/2)# priority-flow-control mode on
```

```
OS10(config)# interface ethernet 1/1/3
OS10(conf-if-eth1/1/3)# no shutdown
OS10(conf-if-eth1/1/3)# channel-group 20 mode active
OS10(conf-if-eth1/1/3)# fcoe-pinned-port
OS10(conf-if-eth1/1/3)# no switchport
```

```
OS10(conf-if-eth1/1/3)# service-policy input type network-qos PFC
OS10(conf-if-eth1/1/3)# priority-flow-control mode on
```

```
OS10(config)# interface ethernet 1/1/4
OS10(conf-if-eth1/1/4)# no shutdown
OS10(conf-if-eth1/1/4)# channel-group 20 mode active
OS10(conf-if-eth1/1/4)# no switchport
OS10(conf-if-eth1/1/4)# service-policy input type network-qos PFC
OS10(conf-if-eth1/1/4)# priority-flow-control mode on
```

### View the configuration

Discovered ENodes:

```
OS10# show fcoe enode
Enode MAC Enode Interface VLAN FCFs Sessions

f4:e9:d4:a4:7d:c3 Po 20(Eth 1/1/3) 1001 1 1
```

Discovered FCFs:

```
OS10# show fcoe fcf
FCF MAC FCF Interface VLAN FC-MAP FKA_ADV_PERIOD No. of Enodes

14:18:77:20:78:e0 Po 10(Eth 1/1/1) 1001 0e:fc:00 8000 1
```

FCoE sessions:

```
Enode MAC Enode Interface FCF MAC FCF interface VLAN FCoE
MAC FC-ID PORT WWPN PORT WWNN

f4:e9:d4:a4:7d:c3 Po20(Eth 1/1/3) 14:18:77:20:78:e0 Po 10(Eth 1/1/1)
1001 0e:fc:00:01:00:00 01:34:02 20:01:f4:e9:d4:a4:7d:c3 20:00:f4:e9:d4:a4:7d:c3
```

Pinned port status:

```
OS10# show fcoe pinned-port
Interface pinned-port FCoE Status

Po 10 Eth 1/1/1 Up
Po 20 Eth 1/1/3 Up
```

## Sample FC Switch configuration on non-VLT network

1. Enable the F\_PORT mode.

```
OS10(config)# feature fc domain-id 1
```

2. Create the FC zones.

```
OS10(config)# fc zone zoneA
OS10(config-fc-zone-zoneA)# member wwn 10:00:00:90:fa:b8:22:19 <<Enter the WWN of Initiator CNA>>
OS10(config-fc-zone-zoneA)# member wwn 21:00:00:24:ff:7b:f5:c8 <<Enter the WWN of Target>>
```

3. Create the FC zoneset.

```
OS10(config)# fc zoneset zonesetA
OS10(conf-fc-zoneset-zonesetA)# member zoneA
```

4. Create the vfabric VLAN.

```
OS10(config)# interface vlan 1001
```

5. Create vfabric and activate the FC zoneset.

```
OS10(config)# vfabric 1
OS10(conf-vfabric-1)# vlan 1001
OS10(conf-vfabric-1)# fcoe fcmap 0xEFC00
OS10(conf-vfabric-1)# zoneset activate zonesetA
```

6. Enable DCBX.

```
OS10(config)# dcbx enable
```

7. Apply the vfabric on the interfaces.

```
OS10(config)# interface port-channel 10
OS10(conf-if-po-10)# no shutdown
OS10(conf-if-po-10)# switchport mode trunk
OS10(conf-if-po-10)# switchport access vlan 1
OS10(conf-if-po-10)# switchport trunk allowed vlan 10
OS10(conf-if-po-10)# vfabric 1
```

```
OS10(config)# interface fibrechannel 1/1/26
OS10(conf-if-fc1/1/26)# description target_connected_port
OS10(conf-if-fc1/1/26)# no shutdown
OS10(conf-if-fc1/1/26)# vfabric 1
```

8. Apply the PFC configuration on the downlink interfaces. Include the interfaces to the port-channel and configure one of the interfaces as pinned-port.

```
OS10(config)# interface ethernet 1/1/9
OS10(conf-if-eth1/1/9)# no shutdown
OS10(conf-if-eth1/1/9)# channel-group 10 mode active
OS10(conf-if-eth1/1/9)# fcoe-pinned-por
OS10(conf-if-eth1/1/9)# no switchport
OS10(conf-if-eth1/1/9)# service-policy input type network-qos PFC
OS10(conf-if-eth1/1/9)# priority-flow-control mode on
```

```
OS10(config)# interface ethernet 1/1/10
OS10(conf-if-eth1/1/10)# no shutdown
OS10(conf-if-eth1/1/10)# channel-group 10 mode active
OS10(conf-if-eth1/1/10)# no switchport
OS10(conf-if-eth1/1/10)# service-policy input type network-qos PFC
OS10(conf-if-eth1/1/10)# priority-flow-control mode on
```

**View configuration**

Name server entries:

```
OS10# show fc ns switch brief
Total number of devices = 2
Intf# Domain FC-ID Enode-WWPN Enode-WWNN
port-channel10(Eth 1/1/9) 1 01:00:00 20:01:f4:e9:d4:a4:7d:c3
20:00:f4:e9:d4:a4:7d:c3
fibrechannel1/1/26 1 01:68:00 21:00:00:24:ff:7c:ae:0e
21:00:00:24:ff:7c:ae:0e
```

Zoneset details:

```
vFabric id: 1
Active Zoneset: zonesetA
ZoneName ZoneMember
=====
zoneA *20:01:f4:e9:d4:a4:7d:c3
 *21:00:00:24:ff:7c:ae:0e
```

Pinned port status:

```
OS10# show fcoe pinned-port
Interface pinned-port FCoE Status
```

## Multiswitch fabric (E Port)

E Ports are interfaces that connect the FC switches to form a multiswitch SAN fabric. These ports carry control frames between the switches to configure and maintain the fabric. An Inter-Switch Link (ISL) is created when you connect two E Ports to one another. FC ISL maintains the information in FC frames as the traffic flows between multiple switches.

The multiswitch configuration sets the port mode as E. The switch port initialization for an E Port includes the exchange of Exchange link parameters (ELP) message sequences, on the ISL between two E Ports.

Use the multiswitch option to enable the multiswitch fabric mode. In the multiswitch fabric mode, the default port mode is F. You can enable the E Port mode by configuring the port mode as E. When the E port becomes operationally up, the link initialization starts, which include the exchange of link parameters (ELP) with the peer switch through the ISL. On successful exchange of ELP, the switches are allowed to participate in principal switch election. Delete multiswitch configurations when disabling a feature. You can disable the multiswitch mode only if you delete the related configurations.

### Principal switch selection

A principal switch is a switch that assigns and maintains a unique domain ID across the fabric. During the principal switch selection, the switch with the highest priority becomes the principal switch. If two switches have the same priority, the switch with lower WWN becomes the principal switch. The valid range to set the priority is 1, and from 3 to 255. Priority 1 has the highest priority. A switch with priority 255 cannot become the principal switch. You can modify the switch priority only when the fabric is in inactive state. You can activate the vfabric only by adding VLAN and fcmapi configuration under the vfabric configuration view. Ensure to configure the switch priority before activating the vfabric.

An ISL that points towards the principal switch is called an upstream principal ISL, which is discovered during principal switch election. After completing the fabric reconfiguration, the local switch requests for domain ID allocation through an upstream principal ISL. An ISL that points away from the principal switch is called a downstream principal ISL. Link failure results in rebuilding the fabric. When the principal ISL fails and if no other path exists between the two affected switches, then the build fabric (BF) operation is triggered. If the backup link (nonprincipal ISL) is available, then the link failure recovery is triggered. Whenever the principal switch election is retrIGGERED nondisruptively, the switches check if the previously assigned domain IDs match the newly elected principal switch. The switches remember the previously assigned domain IDs. If you have already configured the preferred domain IDs, during a switch reboot, the switches check for the preferred domain IDs. If you do not configure a preferred domain ID, the previously assigned domain ID is considered throughout the switch reload. When two different fabrics join and when both fabrics have the same domain ID configured, the reconfigure fabric (RCF) operation occurs as the domain ID overlaps. Any duplicate domain IDs assigned during a fabric merge are detected during the EFP exchange.

Fabric reconfigurations occur in two ways. They are nondisruptive reconfiguration (build fabric) and disruptive reconfiguration (reconfigure fabric). BF occurs when two configured fabrics merge and both the fabrics have nonoverlapping domain ID list. Reconfigure fabric occurs when both the fabrics have overlapping domain ID list, which can be detected through EFP exchange. Login request packets from F or VF ports are not served until the domain ID allocation is successfully completed.

The principal switch assigns a requested domain ID based on the availability of the ID. The FLOGI requests, received until the domain ID is assigned are silently dropped.

All the switches in the fabric must have identical E\_D\_TOV ranging between 1000 ms to 10,000 ms and R\_A\_TOV timer values ranging between 5000 ms and 10000 ms respectively. If there is a mismatch in the configuration value, that switch is isolated from the fabric.

### Fabric shortest path first (FSPF)

FSPF is a link state path selection protocol. All the ISL links between FC switches are treated as point to point. FSPF tracks the state of the links on all switches in the fabric, and associates a cost with each link. FSPF computes paths from one switch to all other switches present in the fabric. FSPF computes the best path by adding the cost of the link that is traversed by the paths and by choosing the least path with the least cost to reach a particular domain ID from a switch. It also computes the best path between the switches that is based on the link cost. FSPF computes the shortest path from the local domain to all other domains available in the fabric and updates route details with the next hop to reach the shortest path. Hold-time interval must be elapsed between the two runs of shortest path first (SPF) run. This release of OS10 does not support incremental SPF run. E ports exchange FSPF hello packets periodically on the ISL to form and maintain neighbor adjacency. The FSPF link state updates (LSU) use this link adjacency to exchange the link state information of a switch, across the fabric. Each switch maintains a link state database that is based on this link state information. This link state database is used in the SPF (Dijkstra algorithm) to

compute the shortest path to reach a switch in the fabric. The name server service uses these routes to synchronize the name server database across the fabric. Hence, FSPF helps in building the fabric connectivity. Configure the same hold-time value on all the switches to ensure a consistent route convergence, and to avoid intermittent forwarding loop. When you configure a shorter hold-time, the route update is faster. FSPF detects the link failures in the fabric and recomputes the next available shortest path to reach the destination domain. FSPF also updates the change in route such as addition of new link or removal of existing link and when the link goes up or down.

## Distributed domain name server (DNS)

DNS is responsible for name server registration and management of Nx\_Ports that are attached to the switch. The registered name entries are stored in the local database. Each switch exchanges its name server information with other switches in the fabric to maintain a synchronized and distributed name service.

Each switch in the fabric must distribute switch registered state change notification (SW\_RSCNs) throughout the fabric whenever there is a change in its local database.

Topology changes trigger SW\_RSCN, and NS queries. Each switch forwards the SW\_RSCN packets on the FSPF computed path towards the other switches in the fabric.

## System logs

The system log file contains the system logs for the following events:

- FC port operationally up
- Principal switch selection
- Domain ID assignment
- Port isolation
- Fabric or nondisruptive reconfiguration data
- Disruptive fabric reconstruction
- Error conditions when ELP or EFP exchange fails, and when the port goes into isolated state

## Restrictions and limitations

This section lists the restrictions, and limitations of the multiswitch fabric feature.

- The multiswitch feature does not support Virtual E-ports (VE), BB\_credit configuration, autoport mode, static FC route, zone merging, ESC exchange between switches, and switch port initialization.
- Only one vfabric is supported per switch in the multiswitch mode.
- Interoperability with other vendors, such as non-OS10 switches are not supported.
- Due to hardware limitations, multiswitch fabric feature does not support ECMP at the NPU level.
- Incremental update for shortest path route computation is not supported. The shortest path computation always runs for the entire fabric.
- ACL entries that are installed for control and data traffic use statically reserved CAM entries. Dynamic ACL space allocation is not supported.
- The switch supports zoning configurations like the F port mode. Configure the same zoning configurations on all switches in the fabric to avoid the Logical Unit Numbers (LUNs) being lost, during topology changes.

**NOTE:** When you enable the multiswitch feature, the N port mode is disabled. The default port mode is the F port. During the multiswitch fabric configuration, if you delete the E Port mode, the port mode resets to the default, F port mode.

### Multiswitch Fabric (E Port) Limitations

The following limitations are applicable in 10.5.1:

- The multiswitch feature does not support Virtual E ports (VE), BB\_credit configuration, autoport mode, static FC route, zone merging, ESC exchange between switches, and switch port initialization.
- Only one vfabric is supported per switch in multiswitch mode.
- Interoperability with other vendors, such as non-OS10 switches are not supported.
- Due to hardware limitations, the multiswitch fabric feature does not support ECMP at the NPU level.
- Incremental update for shortest path route computation is not supported. The shortest path computation always runs for the entire fabric.

- ACL entries that are installed for control and data traffic use statically reserved CAM entries. Dynamic ACL space allocation is not supported.
- The switch supports zoning configurations like the F port mode. Configure the same zoning configurations on all switches in the fabric to avoid the Logical Unit Numbers (LUNs) being lost, during topology changes.

## Configure multiswitch fabric (E Port)

This section describes the procedure to configure multiswitch fabric (E Port).

### Configuration notes

- When two different fabrics join and when both fabrics have the same domain ID configured, the reconfigure fabric (RCF) operation occurs as the domain ID overlaps.
- The RCF operation results in traffic disruptions and after the RCF operation, each switch in the fabric gets a unique domain ID from the principal switch.
- During the merge of conflicting domain IDs, the switch may perform an additional RCF to stabilize when the switch name server entries exceed 700.
- It is recommended to not merge fabrics with conflicting preferred domain IDs.
- During a switch reboot, with conflicting preferred domain IDs, the switches first assign itself a configured domain ID.
- When the E Port links of the switch comes up, the RCF operation occurs again as the domain ID overlaps.

The following example shows a simple multiswitch setup that includes switch-1 and switch-2 with default configurations:

To enable the multiswitch mode, you must first disable the current mode. Configure switch-1 and switch-2 to configure the multiswitch fabric.

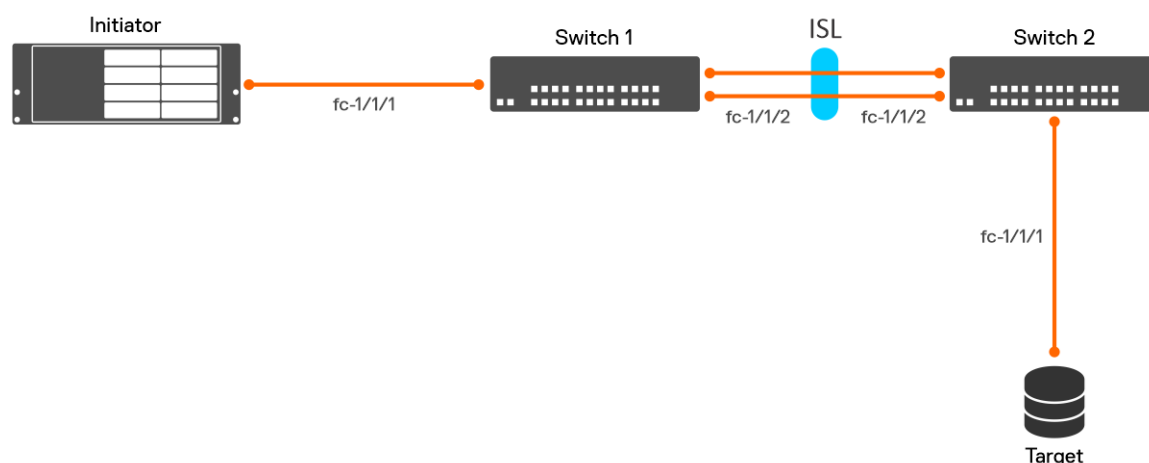

### Switch-1 configuration

1. Enable the multiswitch feature globally.

```
OS10(config)# feature fc multi-switch
```

2. Create a vFabric VLAN.

```
OS10(config)# interface vlan 1001
```

3. Create vFabric.

```
OS10(config)# vfabric 1
OS10(conf-vfabric-1)#
```

**i** **NOTE:** The recommended configuration is to configure the same VLAN and fcmapi values on all the switches. vFabric ID is of local significance, and hence the vFabric can have different values on different switches.

4. Create a port group.

```
OS10(config)# port-group 1/1/1
OS10(conf-pg-1/1/1)# no mode
OS10(conf-pg-1/1/1)# mode FC 8g-4x
```

5. Configure FC interface.

```
OS10(config)# interface fibrechannel 1/1/1
OS10(conf-if-fc1/1/1)# no shutdown
OS10(conf-if-fc1/1/1)# vfabric 1
OS10(conf-if-fc1/1/1)# exit
OS10(config)# interface fibrechannel 1/1/2
OS10(conf-if-fc1/1/2)# no shutdown
OS10(conf-if-fc1/1/2)# vfabric 1
```

6. Configure the FC switch port mode.

```
OS10(conf-if-fc1/1/2)# fc port-mode E
```

7. Add VLAN 1001 and fcmep to switch-1 to activate vFabric.

```
OS10(config)# vfabric 1
OS10(conf-vfabric-1)# vlan 1001
OS10(conf-vfabric-1)# fcoe fcmep 0xefc00
OS10(conf-vfabric-1)# exit
```

8. Create zones.

```
OS10(config)# fc zone zoneA
OS10(config-fc-zone-zoneA)# member wwn 20:01:f4:e9:d4:f9:fc:44
OS10(config-fc-zone-zoneA)# member wwn 20:02:00:11:0d:a5:56:01
```

9. Create and activate a zone set.

```
OS10(config)# fc zoneset zoneset1
OS10(conf-fc-zoneset-zoneset1)# member zoneA
OS10(config)# vfabric 1
OS10(conf-vfabric-1)# zoneset activate zoneset1
```

10. You can deactivate vFabric by removing either the VLAN or fcmep configuration.

```
OS10(conf-vfabric-1)# no vlan 100
Warning: All traffic on this fabric will be lost. Continue? [yes/no]:yes
```

## Switch-2 configuration

1. Enable the multiswitch feature globally.

```
OS10(config)# feature fc multi-switch
```

2. Create a vFabric VLAN.

```
OS10(config)# interface vlan 1001
```

3. Create a vFabric.

```
OS10(config)# vfabric 1
OS10(conf-vfabric-1)#
```

4. Create a port group.

```
OS10(config)# port-group 1/1/1
OS10(conf-pg-1/1/1)# no mode
OS10(conf-pg-1/1/1)# mode FC 8g-4x
```

5. Configure FC interface.

```
OS10(config)# interface fibrechannel 1/1/1
OS10(conf-if-fc1/1/1)# no shutdown
OS10(conf-if-fc1/1/1)# vfabric 1
OS10(conf-if-fc1/1/1)# exit
OS10(config)# interface fibrechannel 1/1/2
OS10(conf-if-fc1/1/2)# no shutdown
OS10(conf-if-fc1/1/2)# vfabric 1
```

6. Configure the FC switch port mode.

```
OS10(config-if-fc1/1/2)# fc port-mode E
```

7. Add VLAN 1001 and fcmmap to switch-2 to activate vFabric.

```
OS10(config)# vfabric 1
OS10(config-vfabric-1)# vlan 1001
OS10(config-vfabric-1)# fcoe fcmmap 0xefc00
OS10(config-vfabric-1)# exit
```

8. Create zones.

```
OS10(config)# fc zone zoneA
OS10(config-fc-zone-zoneA)# member wwn 20:01:f4:e9:d4:f9:fc:44
OS10(config-fc-zone-zoneA)# member wwn 20:02:00:11:0d:a5:56:01
```

9. Create and activate a zone set.

```
OS10(config)# fc zoneset zoneset1
OS10(config-fc-zoneset-zoneset1)# member zoneA
OS10(config)# vfabric 1
OS10(config-vfabric-1)# zoneset activate zoneset1
```

10. You can deactivate the vFabric by removing either the VLAN or fcmmap configuration.

```
OS10(config-vfabric-1)# no vlan 100
Warning: All traffic on this fabric will be lost. Continue? [yes/no]:yes
```

## Verify multiswitch fabric (E Port) configuration

Verify the multiswitch configuration using the following show commands:

- To verify the current configured switch mode, run the `show fc switch` command.

```
OS10# show fc switch
Switch Mode : Disabled
Switch WWN :
```

- To display the multiswitch mode after configuring the multiswitch feature, run the `show fc switch` command.

```
OS10# show fc switch
Switch Mode : Multi-Switch
Switch WWN : 10:00:14:18:77:20:73:cf
```

- To verify the port groups, run the `do show port-group` command.

```
OS10(config)# do show port-group
Port-group Mode Ports FEM
port-group 1/1/1 FC 16g-2x 1 2 3 4 -
port-group 1/1/2 FC 16g-2x 5 6 7 8 -
port-group 1/1/3 FC 16g-2x 9 10 11 12 -
port-group 1/1/4 FC 16g-2x 13 14 15 16 -
port-group 1/1/5 FC 16g-2x 17 18 19 20 -
port-group 1/1/6 FC 16g-2x 21 22 23 24 -
port-group 1/1/7 Eth 100g-1x 25 -
port-group 1/1/8 Eth 40g-1x 26 -
port-group 1/1/9 Eth 100g-1x 29 -
port-group 1/1/10 Eth 40g-1x 30 -
```

```
OS10(config)# do show port-group
Port-group Mode Ports FEM
port-group 1/1/1 FC 8g-4x 1 2 3 4 -
port-group 1/1/2 FC 16g-2x 5 6 7 8 -
port-group 1/1/3 FC 16g-2x 9 10 11 12 -
port-group 1/1/4 FC 16g-2x 13 14 15 16 -
port-group 1/1/5 FC 16g-2x 17 18 19 20 -
port-group 1/1/6 FC 16g-2x 21 22 23 24 -
```



```
port-group 1/1/7 Eth 100g-1x 25 -
port-group 1/1/8 Eth 40g-1x 26 -
port-group 1/1/9 Eth 100g-1x 29 -
port-group 1/1/10 Eth 40g-1x 30 -
```

- To verify the fabric details in switch-1, run the `show fc fabric` command.

```
OS10#show fc fabric
Number of FC Switches = 2
Vfabric-Id Domain ID Switch WWNN

1 0x65(101) >10:00:14:18:77:20:73:cf
1 0x77(119) *20:00:44:18:37:10:73:0a
> Principal
*Local Switch
```

- To verify the fabric details in switch-2, principal switch, run the `show fc fabric` command.

```
OS10#show fc fabric
Number of FC Switches = 2
Vfabric-Id Domain ID Switch WWNN

1 0x65(101) >10:00:14:18:77:20:73:cf
1 0x77(119) *20:00:44:18:37:10:73:0a
> Principal
*Local Switch
```

- To verify the local name server registration on switch-1, run the `show fc ns switch` command.

```
OS10#show fc ns switch
Total number of devices = 1
Switch Name 10:00:14:18:77:20:73:cf
Domain Id 101
Switch Port FC1/1/1
FC-Id 65:00:01
Port Name 20:01:f4:e9:d4:f9:fc:44
Node Name 20:00:f4:e9:d4:f9:fc:43
Class of Service 8
Symbolic Port Name XXX
Symbolic Node Name XXX
Port Type N_Port
Registered with NameServer Yes
Registered for SCN No
FC4-Types:FC4-Features fcp(0x08):0x2
```

- To display the summary of the local switch name server entries, run the `show fc ns switch brief` command.

```
OS10#show fc ns switch brief
Total number of devices = 1
Intf# Domain FC-ID Enode-WWPN Enode-WWNN

fibre-
channel
1/1/1 101 65:00:01 20:00:f4:e9:d4:f9:fc:44 20:00:f4:e9:d4:f9:fc:43
```

- To verify the local name server registration on switch-2, run the `show fc ns switch` command.

```
OS10#show fc ns switch
Total number of devices = 1
Switch Name 20:00:44:18:37:10:73:0a
Domain Id 119
Switch Port FC1/1/1
FC-Id 77:00:02
Port Name 20:02:00:11:0d:a5:56:01
Node Name 20:02:00:11:0d:a5:56:00
Class of Service 8
Symbolic Port Name XXX
Symbolic Node Name XXX
Port Type N_Port
Registered with NameServer Yes
Registered for SCN No
FC4-Types:FC4-Features fcp(0x08):0x1
```

- To verify the fabric name server registration on switch-1, run the `show fc ns fabric` command.

```
OS10#show fc ns fabric
Total number of devices = 2
Switch Name 10:00:14:18:77:20:73:cf
Domain Id 101
Switch Port Fc1/1/1
FC-Id 65:00:01
Port Name 20:00:f4:e9:d4:f9:fc:44
Node Name 20:00:f4:e9:d4:f9:fc:43
Class of Service 8
Symbolic Port Name XXX
Symbolic Node Name XXX
Port Type N_Port
Registered with NameServer Yes
Registered for SCN No
FC4-Types:FC4-Features fcp(0x08):0x2

Switch Name 20:00:44:18:37:10:73:0a
Domain Id 119
FC-Id 77:00:02
Port Name 20:02:00:11:0d:a5:56:01
Node Name 20:02:00:11:0d:a5:56:00
Class of Service 8
Symbolic Port Name XXX
Symbolic Node Name XXX
Port Type N_Port
FC4-Types:FC4-Features fcp(0x08):0x1
```

- To verify the fabric name server registration on switch-2, run the `show fc ns fabric` command.

```
OS10#show fc ns fabric
Total number of devices = 2
Switch Name 20:00:44:18:37:10:73:0a
Domain Id 119
Switch Port FC1/1/1
FC-Id 77:00:02
Port Name 20:02:00:11:0d:a5:56:01
Node Name 20:02:00:11:0d:a5:56:00
Class of Service 8
Symbolic Port Name XXX
Symbolic Node Name XXX
Port Type N_Port
Registered with NameServer Yes
Registered for SCN No
FC4-Types:FC4-Features fcp(0x08):0x1

Switch Name 10:00:14:18:77:20:73:cf
Domain Id 101
Switch Port FC1/1/1
FC-Id 65:00:01
Port Name 20:01:f4:e9:d4:f9:fc:44
Node Name 20:00:f4:e9:d4:f9:fc:43
Class of Service 8
Symbolic Port Name XXX
Symbolic Node Name XXX
Port Type N_Port
FC4-Types:FC4-Features fcp(0x08):0x2
```

- To display the zone set, run the `show fc zoneset` command.

```
OS10#show fc zoneset | no-more
ZoneSetName ZoneName ZoneMember
=====
zoneset1 zoneA 20:01:f4:e9:d4:f9:fc:44
 20:02:00:11:0d:a5:56:01
vFabric id: 1
Active Zoneset: zoneset1

ZoneName ZoneMember
=====
```

```
zoneA 20:01:f4:e9:d4:f9:fc:44
 20:02:00:11:0d:a5:56:01
```

- To verify the vFabric in switch-1, run the `show vfabric` command.

```
OS10# show vfabric
Fabric Name SAN_FABRIC
Fabric Type Multi-Switch
Fabric Id 1
VlanId 1001
FC-MAP 0xEFC00
Config-State ACTIVE
Oper-State UP
=====
Switch Config Parameters
=====
Domain ID 101
Switch Priority 128
E-D-TOV(ms) 1000
R-A-TOV(ms) 5000
=====
Switch Fabric Parameters
=====
Run Time Domain ID 101
Run Time Switch Priority 128
=====
Switch Zoning Parameters
=====
Default Zone Mode: Deny
Active ZoneSet: zoneset1
=====
Members
fibrechannel1/1/1
fibrechannel1/1/2
```

- To verify the vFabric in switch-2, principal switch, run the `show vfabric` command.

```
OS10# show vfabric
Fabric Name SAN_FABRIC
Fabric Type Multi-Switch
Fabric Id 1
VlanId 1001
FC-MAP 0xEFC00
Config-State ACTIVE
Oper-State UP
=====
Switch Config Parameters
=====
Domain ID 119
Switch Priority 128
E-D-TOV(ms) 1000
R-A-TOV(ms) 5000
=====
Switch Fabric Parameters
=====
Run Time Domain ID 119
Run Time Switch Priority 2
=====
Switch Zoning Parameters
=====
Default Zone Mode: Deny
Active ZoneSet: zoneset1
=====
Members
fibrechannel1/1/1
fibrechannel1/1/2
```

- To display the summary of principal switch election states in switch-1, run the `show fc fabric interface` command.

```
OS10#show fc fabric interface
Fabric-State : Stable

Vfabric Intf Link Port Reason Remote Switch Name Remote Port Name
```

```

Id type State code

10 fc1/1/3 UPSTREAM EPORT NONE 10:00:14:18:77:20:7f:cf 20:00:14:18:77:20:7f:d0
10 fc1/1/1 NONPRINPLISL EPORT NONE 10:00:14:18:77:20:7f:cf 20:00:14:18:77:20:7f:d2
OS10#

```

- To display the summary of principal switch election states, in switch-2, run the `show fc fabric interface` command.

```

OS10#show fc fabric interface
Fabric-State : Stable

Vfabric Intf Linktype Port Reason Remote Switch Name Remote Port Name
Id

10 fc1/1/3 NONPRINPLISL EPORT NONE 10:00:14:18:77:20:85:cf 20:00:14:18:77:20:85:d0
10 fc1/1/1 DOWNSTREAM EPORT NONE 10:00:14:18:77:20:85:cf 20:00:14:18:77:20:85:d2
OS10#

```

- To display the principal switch election states and statistics information, run the `show fc fabric statistics interface` command.

```

OS10#show fc fabric statistics interface fc 1/1/2
Number of Request packets received : ELP 8 EFP 12 BF 3 RCF 2 DIA 5
RDI 5 Error packets 0
Number of Accept packets received : ELP ACC 8 EFP ACC 12 BF ACC 3 RCF ACC 2 DIA ACC 5
RDI ACC
5 Error packets 0
Number of Reject packets received : ELP RJT 8 EFP RJT 12 BF RJT 3 RCF RJT 2 DIA RJT 5
RDI RJT
5 Error packets 0
Number of Request packets transmitted : ELP 8 EFP 12 BF 3 RCF 2 DIA 5
RDI 5 Error packets 0
Number of Accept packets transmitted : ELP ACC 8 EFP ACC 12 BF ACC 3 RCF ACC 2 DIA
ACC 5 RDI ACC
5 Error packets 0
Number of Reject packets transmitted : ELP RJT 8 EFP RJT 12 BF RJT 3 RCF RJT 2 DIA
RJT 5 RDI
RJT 5 Error packets 0

```

- To display the link state database information of switch-1, run the `show fc fspf database` command.

```

OS10#show fc fspf database
Total number of Link State Data Base Entries = 2
FSPF Link State Database for Vfabric-Id 1 Domain 0x65(101)
LSR Type = 1
Advertising domain ID = 0x65(101)
LSR Age = 1686
LSR Incarnation number = 0x80000024
LSR Checksum = 0x3caf
Number of links = 1
NbrDomainId IfIndex NbrIfIndex Link Type Cost

0x77(119) 0x00001085 0x00001095 1 125
FSPF Link State Database for Vfabric-Id 1 Domain 0x77(119)
LSR Type = 1
Advertising domain ID = 0x77(119)
LSR Age = 1686
LSR Incarnation number = 0x80000024
LSR Checksum = 0x3caf
Number of links = 1
NbrDomainId IfIndex NbrIfIndex Link Type Cost

0x65(101) 0x00001095 0x00001085 1 125

```

- To display the link state database information of switch-2, run the `show fc fspf database` command.

```

OS10#show fc fspf database
Total number of Link State Data Base Entries = 2
FSPF Link State Database for Vfabric-Id 1 Domain 0x65(101)

```

```

LSR Type = 1
Advertising domain ID = 0x65(101)
LSR Age = 1686
LSR Incarnation number = 0x80000024
LSR Checksum = 0x3caf
Number of links = 1
NbrDomainId IfIndex NbrIfIndex Link Type Cost

0x77(119) 0x00001085 0x00001095 1 125
FSPF Link State Database for Vfabric-Id 1 Domain 0x77(119)
LSR Type = 1
Advertising domain ID = 0x77(119)
LSR Age = 1686
LSR Incarnation number = 0x80000024
LSR Checksum = 0x3caf
Number of links = 1
NbrDomainId IfIndex NbrIfIndex Link Type Cost

0x65(101) 0x00001095 0x00001085 1 125

```

- To view the established shortest routes between the server and the target ports in switch-1, run the `show fc fspf route` command.

```

OS10#show fc fspf route
vfabric-Id Dest-Domain Route-Cost Next-hop

1 0x77(119) 125 fc1/1/2

```

- To view the established shortest routes between the server and the target ports in switch-2, run the `show fc fspf route` command.

```

OS10#show fc fspf route
vfabric-Id Dest-Domain Route-Cost Next-hop

1 0x65(101) 125 fc1/1/2

```

- To view the FSPF neighbor information in switch-1, use the `show fc fspf neighbor` command.

```

OS10#show fc fspf neighbor
Vfabric-Id Interface Neighbor-DomainID State Dead-Time

1 fc1/1/2 0x77(119) Full 00:00:39

```

## Multiswitch fabric (E Port) CLI commands

### show fc fspf interface

Displays the FSPF interface information.

**Syntax** `show fc fspf interface [fibrechannel node/slot/port[:subport]]`

**Parameters** `node/slot/port[:subport]`—Enter the interface information.

**Defaults** Not applicable

**Command Mode** GLOBAL CONFIGURATION

**Usage Information** Use this command to display the FSPF information of an interface.

#### Example

```

OS10#show fc fspf interface fc 1/1/1
FSPF interface fc1/1/1 in vfabric-id 100
Interface cost is 125
Timer intervals, Hello 20s, Dead 80s, Retransmit 5s
FSPF State is FULL
Neighbor Domain Id is 0x0c(12), Neighbor Interface Index is 0x8080E06
Statistics counters:

```

```
Number of packets received: LSU 8 LSA 8 Hello 118 Error packets 0
Number of packets transmitted : LSU 8 LSA 8 Hello 119 Retransmitted LSU 0
```

**Supported Releases** 10.5.1.0 or later

## clear fc fabric statistics

Clears the fabric statistics for all the interfaces.

**Syntax** `clear fc fabric statistics [interface type node/slot/port[:subport] | vfabric vfabric-id]`

**Parameters**

- *node/slot/port[:subport]*—Enter interface information.
- *vfabric-id*—Enter the vfabric ID.

**Defaults** Not applicable

**Command Mode** GLOBAL CONFIGURATION

**Usage Information** Use this command to clear the fabric statistics of either a specific or all the fibre channel interfaces, and a vfabric .

**Example**

```
OS10# clear fc fabric statistics interface fc 1/11
```

**Supported Releases** 10.5.1.0 or later

## clear fc flow-control-statistics

Clears all flow-control counters for all domains.

**Syntax** `clear fc flow-control-statistics`

**Parameters** None

**Default** None

**Command Mode** EXEC

**Usage Information** If multiswitch mode is disabled, this command returns silently.

**Example**

```
OS10# clear fc flow-control-statistics

#show fc flow-control-statistics
SW6(config)# do show fc flow-control-statistics | no-more
S_E2E : Start e2e credit C_E2E : Current e2e credit
REC : Number of times credit was recovered
Z_credit : Number of times credit became zero
W_ACK1 : Frames waiting to get ACK1
W_credit : Transmit Frames waiting on credit

vfabric : 10 Source Domain : 36

D_ID | S_E2E | C_E2E | REC | Z_credit | W_ACK1 | W_credit

34 | 10 | 10 | 0 | 0 | 0 | 0
32 | 10 | 10 | 0 | 0 | 0 | 0
31 | 10 | 10 | 0 | 0 | 0 | 0
33 | 10 | 10 | 0 | 0 | 0 | 0
35 | 10 | 10 | 0 | 0 | 0 | 0

D_ID | NS_SENT | NS_ACK1_RECV | NS_ACK1_SENT

```

|    |   |   |   |
|----|---|---|---|
| 34 | 0 | 0 | 0 |
| 32 | 0 | 0 | 0 |
| 31 | 0 | 0 | 0 |
| 33 | 0 | 0 | 0 |
| 35 | 0 | 0 | 0 |

**Supported Releases** 10.5.1.0 or later

## clear fc fspf statistics

Clears FSPF statistics for all the interfaces.

**Syntax** `clear fc fspf statistics [interface type node/slot/port[:subport] | vfabric vfabric-id`

- Parameters**
- *node/slot/port[:subport]*—Enter interface information.
  - *vfabric-id*—Enter the vfabric ID.

**Defaults** Not applicable

**Command Mode** GLOBAL CONFIGURATION

**Usage Information** Use this command to clear the FSPF statistics for all the fibre channel and vfabric interfaces.

**Example**

```
OS10#clear fc fspf statistics interface fc 1/1/1
```

**Supported Releases** 10.5.1.0 or later

## clear fc ns switch statistics

Clears the Name Server statistics on all interfaces.

**Syntax** `clear fc ns switch statistics [interface type node/slot/port[:subport] | vfabric vfabric-id|vfabric vfabric-id domain [domain-id]`

- Parameters**
- *node/slot/port[:subport]*—Enter the Interface type details.
  - *vfabric-ID*—Enter the vfabric ID.
  - *domain-id*—Enter the vfabric domain ID.

**Defaults** Not applicable

**Command Mode** GLOBAL CONFIGURATION

**Usage Information** Use this command to clear the Name Server statistics on either a specific or all the fibre channel interfaces, vfabric interfaces, and domain on a vfabric.

**Example**

```
OS10# clear fc ns switch statistics interface fc 1/1/1
```

**Supported Releases** 10.5.1.0 or later

## domain-id

Configures the domain-id for every vfabric.

**Syntax** `domain-id [preferred domain-id-val]`

|                           |                                                                                                                                                                                                                                                                                                                                                                                                                                                                                                                                                                                                                                                                                                                                                                                                                                                                                                                                                                                                                                                           |
|---------------------------|-----------------------------------------------------------------------------------------------------------------------------------------------------------------------------------------------------------------------------------------------------------------------------------------------------------------------------------------------------------------------------------------------------------------------------------------------------------------------------------------------------------------------------------------------------------------------------------------------------------------------------------------------------------------------------------------------------------------------------------------------------------------------------------------------------------------------------------------------------------------------------------------------------------------------------------------------------------------------------------------------------------------------------------------------------------|
| <b>Parameters</b>         | <ul style="list-style-type: none"> <li>• <code>domain-id</code>—Enter the domain ID of the E_Port.</li> <li>• <code>domain-id-val</code>—Valid values are from 1 to 239.</li> </ul>                                                                                                                                                                                                                                                                                                                                                                                                                                                                                                                                                                                                                                                                                                                                                                                                                                                                       |
| <b>Defaults</b>           | Dynamic Configuration                                                                                                                                                                                                                                                                                                                                                                                                                                                                                                                                                                                                                                                                                                                                                                                                                                                                                                                                                                                                                                     |
| <b>Command Mode</b>       | Vfabric CONFIGURATION                                                                                                                                                                                                                                                                                                                                                                                                                                                                                                                                                                                                                                                                                                                                                                                                                                                                                                                                                                                                                                     |
| <b>Usage Information</b>  | <ul style="list-style-type: none"> <li>• The configurations are supported only in the multiswitch mode. The configured domain ID can be preferred or dynamic.</li> <li>• If the domain ID is preferred, the switch requests preferred domain ID to the principal switch.</li> <li>• You can change the domain ID only when the vfabric is in an inactive state. To activate vfabric, add <code>vlan</code> and <code>fcmap</code> configuration under the vfabric configuration view. Ensure to configure the domain ID before configuring the <code>vlan</code> and <code>fcmap</code> in the vfabric configuration view.</li> <li>• When disruptive fabric reconfiguration (RCF) occurs, the switch transmits RDI request sequence with preferred domain ID. During nondisruptive reconfiguration (BF), the switch requests for previously allocated domain ID (previous runtime domain ID), if available. Otherwise, use the preferred domain ID.</li> <li>• The <code>no</code> form of this command resets to the default, dynamic value.</li> </ul> |
| <b>Example</b>            | <pre>OS10(conf-vfabric-&lt;vfabric-id&gt;)#domain-id preferred 2</pre>                                                                                                                                                                                                                                                                                                                                                                                                                                                                                                                                                                                                                                                                                                                                                                                                                                                                                                                                                                                    |
| <b>Supported Releases</b> | 10.5.1.0 or later                                                                                                                                                                                                                                                                                                                                                                                                                                                                                                                                                                                                                                                                                                                                                                                                                                                                                                                                                                                                                                         |

## e\_d\_tov

Configures the E\_D\_TOV FC timer value for every vfabric.

|                           |                                                                                                                                                                                                                                                                                                                                                                                                                                                                                                                                                                                                                                                                                                                                                                                                                                                                                                                                                                                                                                                                                                                                 |
|---------------------------|---------------------------------------------------------------------------------------------------------------------------------------------------------------------------------------------------------------------------------------------------------------------------------------------------------------------------------------------------------------------------------------------------------------------------------------------------------------------------------------------------------------------------------------------------------------------------------------------------------------------------------------------------------------------------------------------------------------------------------------------------------------------------------------------------------------------------------------------------------------------------------------------------------------------------------------------------------------------------------------------------------------------------------------------------------------------------------------------------------------------------------|
| <b>Syntax</b>             | <code>e_d_tov timeout-val</code>                                                                                                                                                                                                                                                                                                                                                                                                                                                                                                                                                                                                                                                                                                                                                                                                                                                                                                                                                                                                                                                                                                |
| <b>Parameters</b>         | <code>timeout-val</code> —Valid values are from 1000 to 10000.                                                                                                                                                                                                                                                                                                                                                                                                                                                                                                                                                                                                                                                                                                                                                                                                                                                                                                                                                                                                                                                                  |
| <b>Defaults</b>           | 2000 ms                                                                                                                                                                                                                                                                                                                                                                                                                                                                                                                                                                                                                                                                                                                                                                                                                                                                                                                                                                                                                                                                                                                         |
| <b>Command Mode</b>       | Vfabric CONFIGURATION                                                                                                                                                                                                                                                                                                                                                                                                                                                                                                                                                                                                                                                                                                                                                                                                                                                                                                                                                                                                                                                                                                           |
| <b>Usage Information</b>  | <ul style="list-style-type: none"> <li>• The configurations are supported only in the multiswitch mode.</li> <li>• If you do not receive an expected response within the expected time, then consider the condition as an error condition. This timer is used for the error conditions during link initialization, and the principal switch election. Match this value with the other end during port initialization. This type of configuration is not permitted when vfabric is active.</li> <li>• If the configured E_D_TOV value is not same on both the sides of the port, then the port is isolated. Ensure to configure the same E_D_TOV value on both the sides.</li> <li>• You can change the E_D_TOV value only when vfabric is in inactive state. The vfabric is activated only by adding <code>vlan</code> and <code>fcmap</code> configuration under the vfabric configuration view. Ensure to configure E_D_TOV before configuring the <code>vlan</code> and <code>fcmap</code> in the vfabric configuration view.</li> <li>• The <code>no</code> version of this command resets to the default value.</li> </ul> |
| <b>Example</b>            | <pre>OS10(conf-vfabric-&lt;vfabric-id&gt;)#e_d_tov 3000</pre>                                                                                                                                                                                                                                                                                                                                                                                                                                                                                                                                                                                                                                                                                                                                                                                                                                                                                                                                                                                                                                                                   |
| <b>Supported Releases</b> | 10.5.1.0 or later                                                                                                                                                                                                                                                                                                                                                                                                                                                                                                                                                                                                                                                                                                                                                                                                                                                                                                                                                                                                                                                                                                               |

## fc port-mode F | E

Configures the FC switch port mode.

|                   |                                 |
|-------------------|---------------------------------|
| <b>Syntax</b>     | <code>fc port-mode F   E</code> |
| <b>Parameters</b> | None                            |
| <b>Defaults</b>   | The port mode is:               |



- F—Multiswitch mode
- N—NPG mode

**Command Mode** Fibre Channel INTERFACE

**Usage Information**

- The configurations are supported only in the multiswitch mode. In F\_port mode, all the ports operate as F Port. On enabling the multiswitch mode, a port works as either a F\_port or an E\_port.
- To change modes, disable current mode and enable the new mode. This operation leads to traffic disruption on the corresponding port.
- You can disable the multiswitch mode only if you delete the related configurations.
- For NPG switch mode, the default port mode is N. You can change the port mode to F. The NPG switch mode does not support E port mode.
- In F port switch mode, you cannot change the port mode to E or F.
- The no form of this command resets the fc port mode to the default value.

**Example**

```
OS10(config-if-fc-1/1/1)#fc port-mode E
```

**Supported Releases**

10.5.1.0 or later

## feature fc

Enables the multiswitch feature.

**Syntax**

```
feature fc [domain-id domain-id-val | npg | fip-snooping [with-cvl] | multi-switch]
```

**Parameters**

- *with-cvl*—To enable CVL.
- *domain-id*—Enter the domain ID of the E\_Port.
- *domain-id-val*—Valid values are from 1 to 239.

**Defaults**

Disabled

**Command Mode**

GLOBAL CONFIGURATION

**Usage Information**

- Use the multiswitch option to support the multiswitch fabric mode.
- Delete multiswitch configurations when disabling a feature.
- You can disable the multiswitch mode only if you delete the related configurations.
- The no form of this command deletes the configuration.

**Example**

```
OS10(config)# feature fc multi-switch
```

**Supported Releases**

10.5.1.0 or later

## fspf cost

Configures the FSPF cost value for every interface.

**Syntax**

```
fspf cost cost-val
```

**Parameters**

*cost-val*—Valid values are from 1 to 65535.

**Defaults**

FSPF cost for the following is:

- 8G-125
- 16G-62
- 32G-31

**Command Mode**

Fibre Channel INTERFACE

**Usage Information**

- The configurations are supported only in the multiswitch mode.
- This command configures the cost of the selected interface. Also, it configures the same cost value on both ends of the link.
- Different cost values lead to repeat the request repeatedly or even indefinitely.
- The `no` version of this command resets the command to default value, for the interface speed.

**Example**

```
OS10(config-if-fc-1/1/1)#fspf cost 90
```

**Supported Releases**

10.5.1.0 or later

## fspf dead-interval

Configures the FSPF dead Interval value for every interface.

**Syntax** `fspf dead-interval timeout-val`

**Parameters** `timeout-val`—Valid values are from 1 to 65535.

**Defaults** 80 s

**Command Mode** Fiber channel INTERFACE

**Usage Information**

- The configurations are supported only in the multiswitch mode.
- This command specifies the maximum interval. You must first receive a hello message on the selected interface before the neighbor is considered lost and removed from the database.
- The `no` form of this command resets the command to default value, 80 s.

**Example**

```
OS10(config-if-fc-1/1/1)#fspf dead-interval 90
```

**Supported Releases**

10.5.1.0 or later

## fspf hello-interval

Configures the FSPF hello interval value for every interface.

**Syntax** `fspf hello-interval timeout-val`

**Parameters** `timeout-val`—Valid values are from 1 to 65535.

**Defaults** 20 s

**Command Mode** Fiber Channel INTERFACE

**Usage Information**

- The configurations are supported only in multiswitch mode.
- This command specifies the hello message interval to verify the health of the link in the VSAN.
- The `no` version of this command resets to the default value.

**Example**

```
OS10(config-if-fc-1/1/1)#fspf hello-interval 30
```

**Supported Releases**

10.5.1.0 or later

## fspf hold-time

Configures the FSPF hold-time value for vfabric.

**Syntax** `fspf hold-time timeout-val`

|                           |                                                                                                                                                                                                                                                                                                                                                                                                                                                                                                                                                                                                                                                                      |
|---------------------------|----------------------------------------------------------------------------------------------------------------------------------------------------------------------------------------------------------------------------------------------------------------------------------------------------------------------------------------------------------------------------------------------------------------------------------------------------------------------------------------------------------------------------------------------------------------------------------------------------------------------------------------------------------------------|
| <b>Parameters</b>         | <code>timeout-val</code> —Valid values are from 0 to 65535.                                                                                                                                                                                                                                                                                                                                                                                                                                                                                                                                                                                                          |
| <b>Defaults</b>           | 0ms                                                                                                                                                                                                                                                                                                                                                                                                                                                                                                                                                                                                                                                                  |
| <b>Command Mode</b>       | VFABRIC CONFIGURATION                                                                                                                                                                                                                                                                                                                                                                                                                                                                                                                                                                                                                                                |
| <b>Usage Information</b>  | <ul style="list-style-type: none"> <li>The configurations are supported only in multiswitch mode.</li> <li>This command configures the hold-time between two consecutive route computations in milliseconds, for the entire vfabric. If the specified time is shorter, the routing update is faster. However, the processor consumption increases accordingly. <ul style="list-style-type: none"> <li><b>NOTE:</b> Configure the same hold timer value on all the switches for consistent route convergence, and to avoid intermittent traffic loop.</li> </ul> </li> <li>The <code>no</code> version of this command resets to the default value of 0ms.</li> </ul> |
| <b>Example</b>            | <pre>OS10 (conf-vfabric-&lt;vfabric-id&gt;)#fspf hold-time 5000</pre>                                                                                                                                                                                                                                                                                                                                                                                                                                                                                                                                                                                                |
| <b>Supported Releases</b> | 10.5.1.0 or later                                                                                                                                                                                                                                                                                                                                                                                                                                                                                                                                                                                                                                                    |

## fspf retransmit-interval

Configures the FSPF retransmit interval value for every interface.

|                           |                                                                                                                                                                                                                                                                                                    |
|---------------------------|----------------------------------------------------------------------------------------------------------------------------------------------------------------------------------------------------------------------------------------------------------------------------------------------------|
| <b>Syntax</b>             | <code>fspf retransmit-interval timeout-val</code>                                                                                                                                                                                                                                                  |
| <b>Parameters</b>         | <code>timeout-val</code> —Valid values are from 1 to 65535.                                                                                                                                                                                                                                        |
| <b>Defaults</b>           | 5 s                                                                                                                                                                                                                                                                                                |
| <b>Command Mode</b>       | Fibre Channel INTERFACE                                                                                                                                                                                                                                                                            |
| <b>Usage Information</b>  | <ul style="list-style-type: none"> <li>The configurations are supported only in multiswitch mode.</li> <li>This command specifies the retransmit time interval for unacknowledged link state updates.</li> <li>The <code>no</code> version of this command resets to the default value.</li> </ul> |
| <b>Example</b>            | <pre>OS10 (config-if-fc-1/1/1)#fspf retransmit-interval 10</pre>                                                                                                                                                                                                                                   |
| <b>Supported Releases</b> | 10.5.1.0 or later                                                                                                                                                                                                                                                                                  |

## principal-priority

Configures the switch priority for every vfabric.

|                          |                                                                                                                                                                                                                                                                                                                                                                                                                                                                                                                                                                                                                                                                                                                                                                                                                                                                                                                                                    |
|--------------------------|----------------------------------------------------------------------------------------------------------------------------------------------------------------------------------------------------------------------------------------------------------------------------------------------------------------------------------------------------------------------------------------------------------------------------------------------------------------------------------------------------------------------------------------------------------------------------------------------------------------------------------------------------------------------------------------------------------------------------------------------------------------------------------------------------------------------------------------------------------------------------------------------------------------------------------------------------|
| <b>Syntax</b>            | <code>principal-priority priority-val</code>                                                                                                                                                                                                                                                                                                                                                                                                                                                                                                                                                                                                                                                                                                                                                                                                                                                                                                       |
| <b>Parameters</b>        | <code>priority-val</code> —Valid values are 1, and from 3 to 255.                                                                                                                                                                                                                                                                                                                                                                                                                                                                                                                                                                                                                                                                                                                                                                                                                                                                                  |
| <b>Defaults</b>          | 128                                                                                                                                                                                                                                                                                                                                                                                                                                                                                                                                                                                                                                                                                                                                                                                                                                                                                                                                                |
| <b>Command Mode</b>      | Vfabric CONFIGURATION                                                                                                                                                                                                                                                                                                                                                                                                                                                                                                                                                                                                                                                                                                                                                                                                                                                                                                                              |
| <b>Usage Information</b> | <ul style="list-style-type: none"> <li>The configurations are supported only in the multiswitch mode. 1 has the highest priority. A switch with priority 255 cannot become the principal switch. Priority 2 is not allowed during configuration.</li> <li>If two switches have the same priority, the switch with lower WWN becomes the principal switch. A switch with priority 255 cannot become the principal switch. Once elected, if the principal switch has a priority greater than 2, then it is changed to 2.</li> <li>You can modify the switch priority only when the vfabric is in inactive state. You can activate the vfabric only by adding VLAN and fomap configuration under the vfabric configuration view. Ensure to configure the switch priority before configuring the VLAN and fomap in the vfabric configuration view.</li> <li>The <code>no</code> version of this command resets to the default value of 128.</li> </ul> |

**Example**

```
OS10 (conf-vfabric-<vfabric-id>) #principal-priority 3
```

**Supported Releases**

10.5.1.0 or later

## r\_a\_tov

Configures the R\_A\_TOV FC timer value for vfabric.

**Syntax**

```
r_a_tov timeout-val
```

**Parameters**

timeout-val—Valid values are from 5000 to 10000.

**Defaults**

10000ms

**Command Mode**

VFabric CONFIGURATION

**Usage Information**

- The configurations are supported only in multiswitch mode.
- This timer is used to mark the error conditions during domain ID allocation, SW-RSCN, and NS QUERY. Match this value with the other end, during port initialization. This type of configuration is not permitted when vfabric is active.
- If the configured R\_A\_TOV value is not the same on both the sides of the port, then the port is isolated. Ensure to configure the same R\_A\_TOV value on both the sides.
- You can change the R\_A\_TOV value only when vfabric is in inactive state. You can activate the vfabric only by adding VLAN and fcmapi configuration under the vfabric configuration view. Ensure to configure the R\_A\_TOV before configuring the vlan, and fcmapi in the vfabric configuration view.
- The no version of this command resets to default value of 10000ms.

**Example**

```
OS10 (conf-vfabric-<vfabric-id>) #r_a_tov 3000
```

**Supported Releases**

10.5.1.0 or later

## show fc fabric

Shows switches in the FC fabric.

**Syntax**

```
show fc fabric
```

**Parameters**

None

**Defaults**

Not applicable

**Command Mode**

Fibre Channel INTERFACE

**Usage Information**

- The configurations are supported only in multiswitch mode.
- This command specifies the retransmit time interval for unacknowledged link state updates.
- The no version of this command resets to the default value.

**Example**

```
OS10#show fc fabric
Number of FC Switches = 2

Vfabric-Id Domain ID Switch WWNN

100 0x02 (02) *20:01:00:05:9b:00:11:5f
100 0x66 (102) >10:00:00:05:1e:03:ae:56

> Principal
*Local Switch
```

**Supported Releases**

10.5.1.0 or later

## show fc fabric interface

Shows the summary of the principal switch election states, ILS link type, port state, reason code, remote switch, and port name.

**Syntax** `show fc fabric interface`

**Parameters** None

**Defaults** Not applicable

**Command Mode** EXEC

- Usage Information**
- Use this command to display the summary of principal switch election states, ILS link type, port state, remote switch, and port name.
  - The Fabric states are Build Fabric, Reconfigure Fabric, EFP-Idle, EFP-Send, Principal-Switch, Non-Principal-Switch, No Domain, and Stable states.
  - The Link types are Unknown, Non-Principal ISL, Upstream Principal ISL, and Downstream Principal ISL.
  - The Reason codes are:
    - BB Credit Isolation
    - R\_A\_TOV Mismatch
    - E\_D\_TOV Mismatch
    - Flow Control Not Supported
    - Class of Services Not Supported
    - Port Mode mismatch Isolation
    - Invalid Switch Name Isolation
    - Not Capable Principal Switch
    - Domain ID Overlap
    - Isolation due to ELP Failure
    - Isolation due to Loop Back Connection
    - Isolation due to EFP Max Retransmission Exceeded
    - Isolation due to BF Max Retransmission Exceeded
    - Isolation due to RCF Max Retransmission Exceeded
    - Isolation due to DIA Max Retransmission Exceeded
    - Isolation due to RDI Max Retransmission Exceeded

### Example

```
OS10(config)# do show fc fabric interface
Fabric-State : Stable

Vfabric Intf Link Port Reason Remote Remote
Id type State Code Switch Name Port Name

2 fc1/1/25:2 DOWNSTREAM EPORT NONE 10:00:e4:f0:04:3e:3d:95
20:00:e4:f0:04:3e:3e:0f

2 fc1/1/25:1 NONPRINPLISL EPORT NONE 10:00:e4:f0:04:3e:3d:95
20:00:e4:f0:04:3e:3e:0e
```

**Supported Releases** 10.5.1.0 or later

## show fc fabric statistics

Shows the FC fabric statistics for an interface.

**Syntax** `show fc fabric statistics [interface type node/slot/port[:subport] | vfabric vfabric-id]`

- Parameters**
- `node/slot/port[:subport]`—Enter the Interface type details.
  - `vfabric-ID`—Enter the vfabric ID.

**Defaults** Not applicable

**Command Mode** GLOBAL CONFIGURATION

**Usage Information** Use this command to display the fabric statistics for an interface.

**Example**

```
OS10#show fc fabric statistics interface
fibrechannel 1/1/1
Number of Request packets received : ELP 8 EFP 12 BF 3 RCF 2 DIA 5
RDI 5
Number of Accept packets received : ELP ACC 8 EFP ACC 12 BF ACC 3 RCF
ACC 2 DIA ACC 5
RDI ACC 5
Number of Reject packets received : ELP RJT 8 EFP RJT 12 BF RJT 3 RCF
RJT 2 DIA RJT 5
RDI RJT 5
Number of Request packets transmitted : ELP 8 EFP 12 BF 3 RCF 2 DIA 5
RDI 5
Number of Accept packets transmitted : ELP ACC 8 EFP ACC 12 BF ACC 3 RCF
ACC 2 DIA ACC 5
RDI ACC 5
Number of Reject packets transmitted : ELP RJT 8 EFP RJT 12 BF RJT 3 RCF
RJT 2 DIA RJT 5
RDI RJT 5
```

**Supported Releases** 10.5.1.0 or later

## show fc flow-control-statistics

Displays flow-control counters for a specific domain or all domains.

**Syntax** show fc flow-control-statistics [domain domain-id | vfabric vfabric-id]

- Parameters**
- *domain-id*—Enter the domain ID of the E\_Port, from 1 to 239.
  - *vfabric-id*—Enter the vfabric ID.

**Default** None

**Command Mode** EXEC

**Usage Information** If multiswitch mode is disabled, this command does not return any output. If you do not specify a domain ID, this command displays counters for all domains. If you do not specify a vfabric ID, this command displays counters for all domains in all vfabric.

**Example**

```
OS10# show fc flow-control-statistics

S_E2E : Start e2e credit C_E2E : Current e2e credit
REC : Number of times credit was recovered
Z_credit : Number of times credit became zero
W_ACK1 : Frames waiting to get ACK1
W_credit : Transmit Frames waiting on credit

vfabric : 10 Source Domain : 36

D_ID | S_E2E | C_E2E | REC | Z_credit | W_ACK1 | W_credit

34 | 10 | 10 | 0 | 68 | 0 | 0
32 | 10 | 10 | 0 | 68 | 0 | 0
31 | 10 | 10 | 0 | 68 | 0 | 0
33 | 10 | 10 | 0 | 68 | 0 | 0
35 | 10 | 10 | 0 | 68 | 0 | 0

D_ID | NS_SENT | NS_ACK1_RECV | NS_ACK1_SENT

34 | 77 | 77 | 46
32 | 77 | 77 | 169
```

|    |    |    |     |
|----|----|----|-----|
| 31 | 77 | 77 | 184 |
| 33 | 77 | 77 | 46  |
| 35 | 77 | 77 | 153 |

**Supported Releases** 10.5.1.0 or later

## show fc fspf database

Displays the FSPF link state database information of a switch.

**Syntax** show fc fspf database

**Parameters** None

**Defaults** Not applicable

**Command Mode** GLOBAL CONFIGURATION

**Usage Information** Use this command to display the FSPF link state database information of a switch. The database information includes the entire LSR information of the fabric that is constructed based on the LSRs received from other switches.

### Example

```
OS10#show fc fspf database
Total number of Link State Data Base Entries = 2
FSPF Link State Database for Vfabric-Id 100 Domain 0x0c(12)
LSR Type = 1
Advertising domain ID = 0x0c(12)
LSR Age = 100
LSR Incarnation number = 0x80000005
LSR Checksum = 0x3caf
Number of links = 1
NbrDomainId IfIndex NbrIfIndex Link Type Cost

0x65(101) 0x00001095 0x00001085 1 125
FSPF Link State Database for Vfabric-Id 100 Domain 0x65(101)
LSR Type = 1
Advertising domain ID = 0x65(101)
LSR Age = 100
LSR Incarnation number = 0x80000005
LSR Checksum = 0x8443
Number of links = 1
NbrDomainId IfIndex NbrIfIndex Link Type Cost

0x0c(12) 0x00001085 0x00001095 1 125
```

**Supported Releases** 10.5.1.0 or later

## show fc fspf neighbor

Displays the FSPF neighbor information.

**Syntax** show fc fspf neighbor

**Parameters** None

**Defaults** Not applicable

**Command Mode** GLOBAL CONFIGURATION

**Usage Information** Use this command to display the FSPF neighbor information.

## Example

```
OS10#show fc fspf neighbor
Vfabric-Id Interface Neighbor-DomainID State Dead-Time

100 fc1/1/2 0x66(102) Full 00:00:39
```

**Supported Releases** 10.5.1.0 or later

## show fc fspf route

Displays the server and target ports.

**Syntax** show fc fspf route

**Parameters** None

**Defaults** Not applicable

**Command Mode** GLOBAL CONFIGURATION

**Usage Information** Use this command to display the FSPF route information, and the route to reach every other switch in the fabric.

## Example

```
OS10#show fc fspf route
vfabric-Id Dest-Domain Route-Cost Next-hop

100 0x66(102) 125 fc1/1/2
```

**Supported Releases** 10.5.1.0 or later

## show fc ns fabric

Shows all the Name Server entries in the FC fabric shared among the fabric switches.

**Syntax** show fc ns fabric

**Parameters** None

**Defaults** Not applicable

**Command Mode** GLOBAL CONFIGURATION

**Usage Information** Use this command to display all the remote name server entries in the FC fabric.

## Example

```
OS10#show fc ns fabric
Total number of devices = 1
Switch Name 10:00:5c:f9:dd:ef:0d:00
Domain Id 3
FC-Id 03:28:00
Port Name 20:01:f4:e9:d4:f9:fc:43
Node Name 20:00:f4:e9:d4:f9:fc:43
Class of Service 8
Symbolic Port Name XXX
Symbolic Node Name XXX
Port Type N_Port
FC4-Types:FC4-Features fcp(0x08):0x1
```

**Supported Releases** 10.5.1.0 or later



## show fc ns fabric brief

Shows the name server entries that are shared among the Fabric switches in the FC fabric briefly.

**Syntax** `show fc ns fabric brief`

**Parameters** None

**Defaults** Not applicable

**Command Mode** GLOBAL CONFIGURATION

**Usage Information** Use this command to briefly display all the remote name server entries in the FC fabric.

### Example

```
OS10#show fc ns fabric brief
Total number of devices = 2
Domain FC-ID WWPN

2 02:09:00 32:11:0e:fc:00:00:00:88 22:11:0e:fc:00:00:00:88
1 01:04:00 10:00:8c:7c:ff:17:f8:01 20:00:8c:7c:ff:17:f8:01
```

**Supported Releases** 10.5.1.0 or later

## show fc ns switch statistics

Shows the Name Server statistics for an interface.

**Syntax** `show fc ns switch statistics [interface type node/slot/port[:subport]] | vfabric vfabric-id|vfabric vfabric-id domain [domain-id]`

**Parameters**

- `node/slot/port[:subport]`—Enter interface information.
- `vfabric-id`—Enter the vfabric ID.
- `domain-id`—Enter the vfabric domain ID.

**Defaults** Not applicable

**Command Mode** GLOBAL CONFIGURATION

**Usage Information** Use this command to display the Name Server statistics for an interface.

### Example

```
show fc ns switch statistics
fibrechannel 1/1/6
 ReqRx AccTx RejTx
SCR 0 0 0
RNN_ID 0 0 0
RCS_ID 0 0 0
RFT_ID 0 0 0
RSPN_ID 0 0 0
RHA_ID 0 0 0
RFF_ID 0 0 0
RSNN_NN 0 0 0
GA_NXT 0 0 0
GPN_ID 0 0 0
GNN_ID 0 0 0
GCS_ID 0 0 0
GFT_ID 0 0 0
GSPN_ID 0 0 0
GPT_ID 0 0 0
GFPN_ID 0 0 0
GHA_ID 0 0 0
GFF_ID 0 0 0
GID_PN 0 0 0
GID_NN 0 0 0
GPN_NN 0 0 0
```

```

GSNN_NN 0 0 0
GID_FT 0 0 0
GPN_FT 0 0 0
GNN_FT 0 0 0
GNN_FF 0 0 0
GPN_FF 0 0 0
GID_PT 0 0 0
GID_FPN 0 0 0
GPNN_ID 0 0 0
GID_FF 0 0 0
GID_DP 0 0 0

 ReqTx
RSCN 0

 ReqRx ReqTx AccRx AccTx RejRx RejTx ReqReTx
SW_RSCN 0 0 0 0 0 0 0
GE_PT 0 0 0 0 0 0 0
GE_ID 0 0 0 0 0 0 0

```

**Supported Releases** 10.5.1.0 or later

## show fc switch

Shows the multiswitch mode.

**Syntax** `show fc switch`

**Parameters** None

**Defaults** Not applicable

**Command Mode** GLOBAL CONFIGURATION

**Usage Information** Use this command to display the current configured switch mode.

**Example**

```
OS10# show fc switch
```

**Supported Releases** 10.5.1.0 or later

## show interface fibre channel

Shows the fibre channel interface port type, BB\_Credit, and other port configurations.

**Syntax** `show interface fibrechannel node/slot/port[:subport]`

**Parameters** `node/slot/port[:subport]`—Enter the interface information.

**Defaults** Not applicable

**Command Mode** INTERFACE CONFIGURATION

**Usage Information** Use this command to display the type of fibre channel port, E or F port, BB credit, WWPN, open status, and other port statistics.

**Example**

```
OS10#show interface fibrechannel 1/1/1

Fibrechannel 1/1/1 is down, FC link is down
Address is 14:18:77:20:73:d0, Current address is 14:18:77:20:73:d0
Pluggable media present, SFP28 type is SFP28 25GBASE-SR
Wavelength is 850
Receive power reading is -2.378468 dBm
```

```

FC MTU 2188 bytes
LineSpeed 0
Operational Speed 0 over 20G
Port type is E_Port, Max BB credit is 8
WWN is 20:01:14:18:77:20:73:cf
Last clearing of "show interface" counters: 1 day 16:33:56
Input statistics:
0 frames, 0 bytes
0 class 2 good frames, 0 class 3 good frames
0 frame too long, 0 frame truncated, 0 CRC
0 link fail, 0 sync loss
0 primitive seq err, 0 LIP count
0 BB credit 0, 0 BB credit 0 packet drops
Output statistics:
0 frames, 0 bytes
0 class 2 frames, 0 class 3 frames
0 BB credit 0, 0 oversize frames
0 total errors
Rate Info:
Input 0 bytes/sec, 0 frames/sec, 0% of line rate
Output 0 bytes/sec, 0 frames/sec, 0% of line rate
Time since last interface status change: 1 day 16:33:57

```

**Supported Releases** 10.5.1.0 or later

## show vfabric

Shows the fc timer, E\_D\_TOV, R\_A\_TOV, principal switch priority, and domain ID values in the show vfabric command.

**Syntax** show vfabric *value*

**Parameters** *value*—Valid values are from 1 to 255.

**Defaults** Not applicable

**Command Mode** GLOBAL CONFIGURATION

**Usage Information** Use this command to display the fc timers, E\_D\_TOV and R\_A\_TOV, principal switch priority and domain ID values. Also, this command shows the configured domain ID, run-time domain ID, and the principal switch priority of the switch.

### Example

```

OS10# show vfabric
Fabric Name SAN_FABRIC
Fabric Type Multi-Switch
Fabric Id 10
VlanId 1002
FC-MAP 0xEFC00
FCF Priority 128
FKA-Adv-Period Enabled, 8
Config-State ACTIVE
Oper-State UP
=====
Switch Config Parameters
=====
Domain ID 3
Switch Priority 3
E-D-TOV(ms) 1000
R-A-TOV(ms) 5000
=====
Switch Fabric Parameters
=====
Run Time Domain ID 4
Run Time Switch Priority 3
=====
Switch Zoning Parameters
=====
Default Zone Mode: Deny

```

```
Active ZoneSet: zoneset5
=====
Members
fibrechannel1/1/11
fibrechannel1/1/17
fibrechannel1/1/22
```

**Supported Releases** 10.5.1.0 or later

## show vfabric fspf

Displays FSPF information at the vfabric level.

**Syntax** show vfabric fspf

**Parameters** None

**Defaults** Not applicable

**Command Mode** GLOBAL CONFIGURATION

**Usage Information** Use this command to display the FSPF information of an interface.

### Example

```
OS10#show vfabric fspf
FSPF routing for vfabric 10
SPF hold time is 0 msec
MinLsArrival = 1000 msec , MinLsInterval = 5000 msec
Local Domain is 0x64 (100)
Number of LSRs = 3, Total Checksum = 0x0001288b
Refresh time = 1800 sec
Max age = 3600 sec
Statistic counters :
Number of SPF computations = 3
Number of checksum errors = 0
Number of transmitted packets : LSU 10 LSA 10 Hello 25 Retransmitted LSU
10
Number of received packets: LSU 10 LSA 10 Hello 25 Error packets 5
```

**Supported Releases** 10.5.1.0 or later

## Multi-hop FIP-snooping bridge

In typical deployments, ENode-connected switches are not directly connected to the core FC switch. Multiple intermediate switches are connected in between the switches. To establish a point-to-point connection and for secure transmission between the ENode and the FCF, all intermediate switches must support FSB to pass the FIP and FCoE traffic.

OS10 switches support the multi-hop FIP-snooping bridge. You can interconnect multiple FSBs to communicate with an upstream FC switch.

- Access FSB— This is the node that is directly connected to ENode. In the following example, FSB1 is the access FSB.
- Core FSB— This is the node that is directly connected to the FCF. In the following example, FSB2 is the core FSB.

The default port mode is the ENode. You must explicitly configure the other modes using the `fip-snooping port-mode` command. The following port modes are supported:

- ENode—Only one ENode MAC address per interface can be learnt. Configure this mode on the port connected to the ENode.
- FCF—If you configure the FSB with FCF port mode, all the FIP packets sent between the ENode and the FCF are snooped and the sessions and ENodes are learnt. Configure the FCF mode on the access FSB ports connected to the FCF-facing side.
- ENode-transit—This mode is configured on the intermediate FSBs or Layer 2 (L2) DCBX switches to which ENodes are connected.

- FCF-transit—Only the FCF advertisement and VLAN responses are snooped to learn the FCF. The FCF-transit does not learn the ENodes and session information. Configure the FCF-transit mode on the FCF-facing side of the core FSB switch.

The FCF can be in NPG or F-Port mode. The access FSB switches validate the frames and installs ACLs per the FCF to allow only FCoE and FIP traffic across the FCF.

**NOTE:** Port-pinning is not supported on ENodes connected to an FSB switch that is in FCF-transit mode. You cannot view the ENodes or session information using the `show` commands.

### Clear virtual link frames

When an FSB clears an FCoE session for some reason, the other devices in the network, such as the ENode, FCF, and transit switches, are not informed and considers the session to be intact. FSB drops the FCoE data corresponding to the cleared session. The ENode takes a long time to identify the issue and to recover from it. At times, interface flapping occurs and might require manual intervention to recover. To recover automatically, FSB sends a Clear Virtual Link (CVL) frame from the FCF to the ENode.

## Configuration notes

- If you configure FSB with port pinning on the uplink or downlink side, you must configure the FCF-facing interface as FCF port mode.
- OS10 currently does not support a topology where a single port must be configured as both an ENode and an FCF-related port mode.
- If you configure FCF-transit port mode on an FSB, Dell EMC recommends not directly connecting ENodes on it.

## Configure multi-hop FSB

The following example shows a simple multi-hop FSB setup. CNA-2 and CNA-3 shown in this topology are for illustrative purposes only. The following example does not include CNA-2 and CNA-3 configurations.

Ensure that the access and core FSB switches are running in FSB mode.

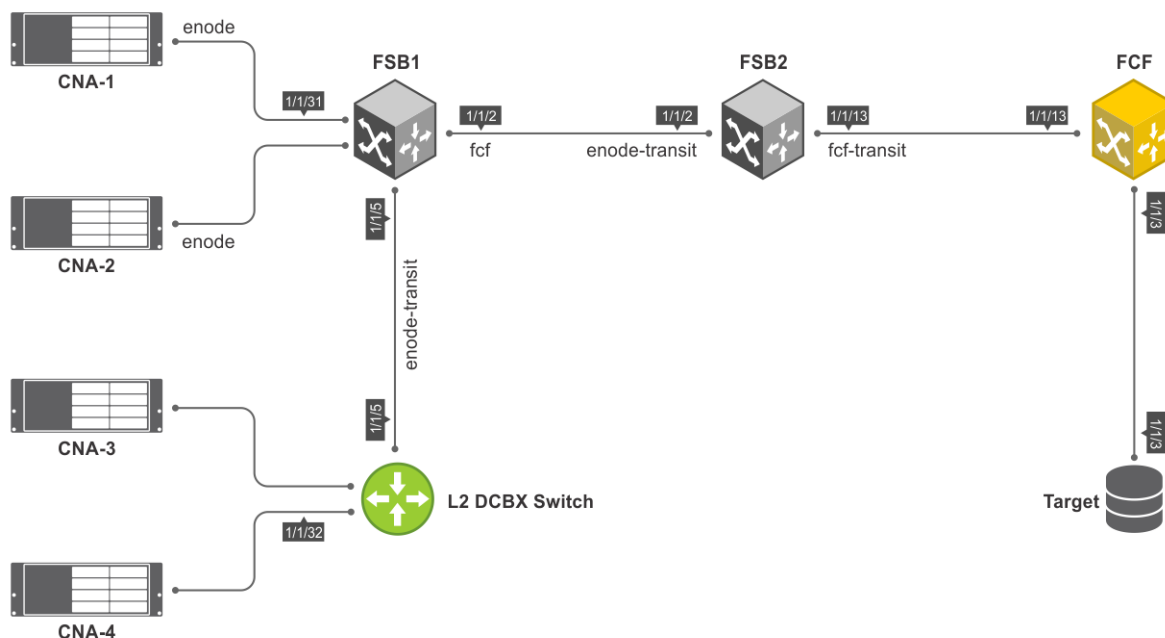

To configure multi-hop FSB:

1. Configure the L2 switch.
  - a. Disable flow control on the interfaces connected to CNA-4 and FSB1.

```
L2switch(config)# interface ethernet 1/1/32
L2switch(conf-if-eth1/1/32)# no flowcontrol receive
L2switch(conf-if-eth1/1/32)# no flowcontrol transmit
```

```
L2switch(config)# interface ethernet 1/1/5
L2switch(conf-if-eth1/1/5)# no flowcontrol receive
L2switch(conf-if-eth1/1/5)# no flowcontrol transmit
```

- b. Enable DCBX.

```
L2switch(config)# dcbx enable
```

- c. Create a VLAN for FCoE traffic to pass through.

```
L2switch(config)# interface vlan 777
```

- d. Create class-maps.

```
L2switch(config)# class-map type network-qos c3
L2switch(config-cmap-nqos)# match qos-group 3
```

```
L2switch(config)# class-map type queuing q0
L2switch(config-cmap-queuing)# match queue 0
L2switch(config-cmap-queuing)# exit
L2switch(config)# class-map type queuing q3
L2switch(config-cmap-queuing)# match queue 3
L2switch(config-cmap-queuing)# exit
```

- e. Create policy-maps.

```
L2switch# configure terminal
L2switch(config)# policy-map type network-qos nqpolicy
L2switch(config-pmap-network-qos)# class c3
L2switch(config-pmap-c-nqos)# pause
L2switch(config-pmap-c-nqos)# pfc-cos 3
```

```
L2switch(config)# policy-map type queuing ets_policy
L2switch(config-pmap-queuing)# class q0
L2switch(config-pmap-c-que)# bandwidth percent 30
L2switch(config-pmap-c-que)# class q3
L2switch(config-pmap-c-que)# bandwidth percent 70
```

- f. Create a qos-map.

```
L2switch(config)# qos-map traffic-class tc-q-map1
L2switch(config-qos-map)# queue 3 qos-group 3
L2switch(config-qos-map)# queue 0 qos-group 0-2,4-7
```

- g. Apply the QoS configurations on CNA-4 and FSB1 connected interfaces.

```
L2switch(config)# interface ethernet 1/1/32
L2switch(conf-if-eth1/1/32)# priority-flow-control mode on
L2switch(conf-if-eth1/1/32)# ets mode on
L2switch(conf-if-eth1/1/32)# trust-map dot1p default
L2switch(conf-if-eth1/1/32)# qos-map traffic-class tc-q-map1
L2switch(conf-if-eth1/1/32)# service-policy input type network-qos nqpolicy
L2switch(conf-if-eth1/1/32)# service-policy output type queuing ets_policy

L2switch(config)# interface ethernet 1/1/5
L2switch(conf-if-eth1/1/5)# priority-flow-control mode on
L2switch(conf-if-eth1/1/5)# ets mode on
L2switch(conf-if-eth1/1/5)# trust-map dot1p default
L2switch(conf-if-eth1/1/5)# qos-map traffic-class tc-q-map1
L2switch(conf-if-eth1/1/5)# service-policy input type network-qos nqpolicy
L2switch(conf-if-eth1/1/5)# service-policy output type queuing ets_policy
```

- h. Configure VLAN on CNA-4 and FSB1 connected interfaces.

```
L2switch(config)# interface ethernet 1/1/32
L2switch(conf-if-eth1/1/32)# switchport mode trunk
L2switch(conf-if-eth1/1/32)# switchport trunk allowed vlan 777

L2switch(config)# interface ethernet 1/1/5
```

```
L2switch(config-if-eth1/1/5)# switchport mode trunk
L2switch(config-if-eth1/1/5)# switchport trunk allowed vlan 777
```

2. Configure the access FSB, FSB1. This example describes

- a. Disable flow control on the interfaces connected to CNA1, L2 switch, and FSB2.

```
FSB1(config)# interface ethernet 1/1/31
FSB1(config-if-eth1/1/31)# no flowcontrol receive
FSB1(config-if-eth1/1/31)# no flowcontrol transmit

FSB1(config)# interface ethernet 1/1/5
FSB1(config-if-eth1/1/5)# no flowcontrol receive
FSB1(config-if-eth1/1/5)# no flowcontrol transmit

FSB1(config)# interface ethernet 1/1/2
FSB1(config-if-eth1/1/2)# no flowcontrol receive
FSB1(config-if-eth1/1/2)# no flowcontrol transmit
```

- b. Enable FIP snooping with cvl option.

```
FSB1(config)# feature fip-snooping with-cvl
```

- c. Enable DCBX.

```
FSB1(config)# dcbx enable
```

- d. Create an FCoE VLAN and configure FIP snooping on the FCoE VLAN.

```
FSB1(config)# interface vlan 777
FSB1(config-if-vl-777)# fip-snooping enable
```

- e. Create class-maps.

```
FSB1(config)# class-map type network-qos c3
FSB1(config-cmap-nqos)# match qos-group 3
```

```
FSB1(config)# class-map type queuing q0
FSB1(config-cmap-queuing)# match queue 0
FSB1(config-cmap-queuing)# exit
FSB1(config)# class-map type queuing q3
FSB1(config-cmap-queuing)# match queue 3
FSB1(config-cmap-queuing)# exit
```

- f. Create policy-maps.

```
FSB1(config)# policy-map type network-qos nqpolicy
FSB1(config-pmap-network-qos)# class c3
FSB1(config-pmap-c-nqos)# pause
FSB1(config-pmap-c-nqos)# pfc-cos 3
```

```
FSB1(config)# policy-map type queuing ets_policy
FSB1(config-pmap-queuing)# class q0
FSB1(config-pmap-c-que)# bandwidth percent 30
FSB1(config-pmap-c-que)# class q3
FSB1(config-pmap-c-que)# bandwidth percent 70
```

- g. Create a qos-map.

```
FSB1(config)# qos-map traffic-class tc-q-map1
FSB1(config-qos-map)# queue 3 qos-group 3
FSB1(config-qos-map)# queue 0 qos-group 0-2,4-7
```

- h. Apply the QoS configurations on CNA1, L2 switch, and FSB2 connected interfaces.

```
FSB1(config)# interface ethernet 1/1/31
FSB1(config-if-eth1/1/31)# priority-flow-control mode on
FSB1(config-if-eth1/1/31)# ets mode on
FSB1(config-if-eth1/1/31)# trust-map dot1p default
FSB1(config-if-eth1/1/31)# qos-map traffic-class tc-q-map1
FSB1(config-if-eth1/1/31)# service-policy input type network-qos nqpolicy
```

```

FSB1(conf-if-eth1/1/31)# service-policy output type queuing ets_policy

FSB1(config)# interface ethernet 1/1/5
FSB1(conf-if-eth1/1/5)# priority-flow-control mode on
FSB1(conf-if-eth1/1/5)# ets mode on
FSB1(conf-if-eth1/1/5)# trust-map dot1p default
FSB1(conf-if-eth1/1/5)# qos-map traffic-class tc-q-map1
FSB1(conf-if-eth1/1/5)# service-policy input type network-qos nqpolicy
FSB1(conf-if-eth1/1/5)# service-policy output type queuing ets_policy

FSB1(config)# interface ethernet 1/1/2
FSB1(conf-if-eth1/1/2)# priority-flow-control mode on
FSB1(conf-if-eth1/1/2)# ets mode on
FSB1(conf-if-eth1/1/2)# trust-map dot1p default
FSB1(conf-if-eth1/1/2)# qos-map traffic-class tc-q-map1
FSB1(conf-if-eth1/1/2)# service-policy input type network-qos nqpolicy
FSB1(conf-if-eth1/1/2)# service-policy output type queuing ets_policy

```

- i. Configure VLAN on CNA1, L2 switch, and FSB2 connected interfaces.

```

FSB1(config)# interface ethernet 1/1/31
FSB1(conf-if-eth1/1/31)# switchport mode trunk
FSB1(conf-if-eth1/1/31)# switchport trunk allowed vlan 777

FSB1(config)# interface ethernet 1/1/5
FSB1(conf-if-eth1/1/5)# switchport mode trunk
FSB1(conf-if-eth1/1/5)# switchport trunk allowed vlan 777

FSB1(config)# interface ethernet 1/1/2
FSB1(conf-if-eth1/1/2)# switchport mode trunk
FSB1(conf-if-eth1/1/2)# switchport trunk allowed vlan 777

```

- j. Configure FIP snooping port mode on the L2 DCBX switch connected interface and FSB2 connected interface. The default port mode is ENode. Hence, CNA1-connected interface does not require additional configuration.

On the L2 DCBX switch-connected interface:

```

FSB1(config)# interface ethernet 1/1/5
FSB1(conf-if-eth1/1/5)# fip-snooping port-mode enode-transit

```

On the FSB-connected interfaces:

```

FSB1(config)# interface ethernet 1/1/2
FSB1(conf-if-eth1/1/2)# fip-snooping port-mode fcf

```

### 3. Configure the core FSB, FSB2.

- a. Disable flow control on the interfaces connected to FSB1 and FCF.

```

FSB2(config)# interface ethernet 1/1/2
FSB2(conf-if-eth1/1/2)# no flowcontrol receive
FSB2(conf-if-eth1/1/2)# no flowcontrol transmit

FSB2(config)# interface ethernet 1/1/13
FSB2(conf-if-eth1/1/13)# no flowcontrol receive
FSB2(conf-if-eth1/1/13)# no flowcontrol transmit

```

- b. Enable FIP snooping with cvl option.

```

FSB2(config)# feature fip-snooping with-cvl

```

- c. Enable DCBX.

```

FSB2(config)# dcbx enable

```

- d. Create an FCoE VLAN and configure FIP snooping on the FCoE VLAN.

```

FSB2(config)# interface vlan 777
FSB2(conf-if-vl-777)# fip-snooping enable

```



e. Create class-maps.

```
FSB2(config)# class-map type network-qos c3
FSB2(config-cmap-nqos)# match qos-group 3
```

```
FSB2(config)# class-map type queuing q0
FSB2(config-cmap-queuing)# match queue 0
FSB2(config-cmap-queuing)# exit
FSB2(config)# class-map type queuing q3
FSB2(config-cmap-queuing)# match queue 3
FSB2(config-cmap-queuing)# exit
```

f. Create policy-maps.

```
FSB2(config)# policy-map type network-qos nqpolicy
FSB2(config-pmap-network-qos)# class c3
FSB2(config-pmap-c-nqos)# pause
FSB2(config-pmap-c-nqos)# pfc-cos 3
```

```
FSB2(config)# policy-map type queuing ets_policy
FSB2(config-pmap-queuing)# class q0
FSB2(config-pmap-c-que)# bandwidth percent 30
FSB2(config-pmap-c-que)# class q3
FSB2(config-pmap-c-que)# bandwidth percent 70
```

g. Create a qos-map.

```
FSB2(config)# qos-map traffic-class tc-q-map1
FSB2(config-qos-map)# queue 3 qos-group 3
FSB2(config-qos-map)# queue 0 qos-group 0-2,4-7
```

h. Apply the QoS configurations on FSB1 and FCF connected interfaces.

```
FSB2(config)# interface ethernet 1/1/2
FSB2(conf-if-eth1/1/2)# priority-flow-control mode on
FSB2(conf-if-eth1/1/2)# ets mode on
FSB2(conf-if-eth1/1/2)# trust-map dot1p default
FSB2(conf-if-eth1/1/2)# qos-map traffic-class tc-q-map1
FSB2(conf-if-eth1/1/2)# service-policy input type network-qos nqpolicy
FSB2(conf-if-eth1/1/2)# service-policy output type queuing ets_policy

FSB2(config)# interface ethernet 1/1/13
FSB2(conf-if-eth1/1/13)# priority-flow-control mode on
FSB2(conf-if-eth1/1/13)# ets mode on
FSB2(conf-if-eth1/1/13)# trust-map dot1p default
FSB2(conf-if-eth1/1/13)# qos-map traffic-class tc-q-map1
FSB2(conf-if-eth1/1/13)# service-policy input type network-qos nqpolicy
FSB2(conf-if-eth1/1/13)# service-policy output type queuing ets_policy
```

i. Configure VLAN on FSB1 and FCF connected interfaces.

```
FSB2(config)# interface ethernet 1/1/2
FSB2(conf-if-eth1/1/2)# switchport mode trunk
FSB2(conf-if-eth1/1/2)# switchport trunk allowed vlan 777

FSB2(config)# interface ethernet 1/1/13
FSB2(conf-if-eth1/1/13)# switchport mode trunk
FSB2(conf-if-eth1/1/13)# switchport trunk allowed vlan 777
```

j. Configure FIP snooping port mode on FSB1 and FCF connected interfaces.

On the FSB1-connected interface:

```
FSB2(config)# interface ethernet 1/1/2
FSB2(conf-if-eth1/1/2)# fip-snooping port-mode enode-transit
```

On the FCF-connected interface:

```
FSB2(config)# interface ethernet 1/1/13
FSB2(conf-if-eth1/1/13)# fip-snooping port-mode fcf-transit
```

4. Configure the FCF. The following configuration assumes that the FCF is in F-Port mode.

- a. Disable flow control on the interface connected to FSB2.

```
FCF(config)# interface ethernet 1/1/13
FCF(conf-if-eth1/1/13)# no flowcontrol receive
FCF(conf-if-eth1/1/13)# no flowcontrol transmit
```

- b. Enable Fiber Channel F-Port mode globally.

```
FCF(config)# feature fc domain-id 2
```

- c. Create zones.

```
FCF(config)# fc zone zoneA
FCF(config-fc-zone-zoneA)# member wwn 20:01:f4:e9:d4:a4:7d:c3
FCF(config-fc-zone-zoneA)# member wwn 21:00:00:24:ff:7c:ae:0e
```

- d. Create zoneset.

```
FCF(config)# fc zoneset zonesetA
FCF(conf-fc-zoneset-set)# member zoneA
```

- e. Create a vfabric VLAN.

```
FCF(config)# interface vlan 777
```

- f. Create vfabric and activate the zoneset.

```
FCF(config)# vfabric 2
FCF(conf-vfabric-2)# vlan 777
FCF(conf-vfabric-2)# fcoe fcmap 0xEFC00
FCF(conf-vfabric-2)# zoneset activate zonesetA
```

- g. Enable DCBX.

```
FCF(config)# dcbx enable
```

- h. Create class maps and policy maps.

```
FCF(config)# class-map type network-qos c3
FCF(config-cmap-nqos)# match qos-group 3
```

```
FCF(config)# class-map type queuing q0
FCF(config-cmap-queuing)# match queue 0
FCF(config-cmap-queuing)# exit
FCF(config)# class-map type queuing q3
FCF(config-cmap-queuing)# match queue 3
FCF(config-cmap-queuing)# exit
```

```
FCF(config)# policy-map type network-qos nqpolicy
FCF(config-pmap-network-qos)# class c3
FCF(config-pmap-c-nqos)# pause
FCF(config-pmap-c-nqos)# pfc-cos 3
```

```
FCF(config)# policy-map type queuing ets_policy
FCF(config-pmap-queuing)# class q0
FCF(config-pmap-c-que)# bandwidth percent 30
FCF(config-pmap-c-que)# class q3
FCF(config-pmap-c-que)# bandwidth percent 70
```

- i. Create a qos-map.

```
FCF(config)# qos-map traffic-class tc-q-map1
FCF(config-qos-map)# queue 3 qos-group 3
FCF(config-qos-map)# queue 0 qos-group 0-2,4-7
```

- j. Apply vfabric on FSB2 and target connected interfaces.

```
FCF(config)# interface ethernet 1/1/13
FCF(config-if-eth1/1/13)# no shutdown
FCF(config-if-eth1/1/13)# switchport access vlan 1
FCF(config-if-eth1/1/13)# vfabric 2
```

```
FCF(config)# interface fibrechannel 1/1/3
FCF(config-if-fc1/1/3)# description target_connected_port
FCF(config-if-fc1/1/3)# no shutdown
FCF(config-if-fc1/1/3)# vfabric 2
```

- k. Apply QoS configurations on the interface connected to FSB2.

```
FCF(config)# interface ethernet 1/1/13
FCF(config-if-eth1/1/13)# priority-flow-control mode on
FCF(config-if-eth1/1/13)# ets mode on
FCF(config-if-eth1/1/13)# trust-map dot1p default
FCF(config-if-eth1/1/13)# qos-map traffic-class tc-q-map1
FCF(config-if-eth1/1/13)# service-policy input type network-qos nqpolicy
FCF(config-if-eth1/1/13)# service-policy output type queuing ets_policy
```

## Verify multi-hop FSB configuration

Verify the configuration using the following show commands:

- To verify FSB mode and the CVL status, use the `show fcoe system` command.

```
FSB1# show fcoe system
Mode : FSB
CVL Status : Enabled
FCOE VLAN List (Operational) : 777
FCFs : 1
Enodes : 2
Sessions : 2
```

- To verify the discovered ENodes, use the `show fcoe enode` command.

```
FSB1# show fcoe enode
Enode MAC Enode Interface VLAN FCFs Sessions

32:03:cf:45:00:00 Eth 1/1/31 777 1 1
f4:e9:d4:f9:fc:40 Eth 1/1/5 777 1 1
```

- To verify the discovered FCFs, use the `show fcoe fcf` command.

```
FSB1# show fcoe fcf
FCF MAC FCF Interface VLAN FC-MAP FKA_ADV_PERIOD No.
of Enodes FCF Mode

14:18:77:20:86:ce Eth 1/1/2 777 0e:fc:00 8000
2 F
```

```
FSB2# show fcoe fcf
FCF MAC FCF Interface VLAN FC-MAP FKA_ADV_PERIOD No.
of Enodes FCF Mode

14:18:77:20:86:ce Eth 1/1/13 777 0e:fc:00 8000
0 FT
```

- To verify the list of FCoE sessions, use the `show fcoe sessions` command.

```
FSB1# show fcoe sessions
Enode MAC Enode Interface FCF MAC FCF interface VLAN FCoE
MAC FC-ID PORT WWPN
PORT WWNN
```

```

32:03:cf:45:00:00 Eth 1/1/31 14:18:77:20:86:ce Eth 1/1/2 777
0e:fc:00:05:00:05 05:00:05 33:00:55:2c:cf:55:00:00
23:00:55:2c:cf:55:00:00
f4:e9:d4:f9:fc:40 Eth 1/1/5 14:18:77:20:86:ce Eth 1/1/2 777
0e:fc:00:02:01:00 02:01:00 20:01:f4:e9:d4:a4:7d:c3
20:00:f4:e9:d4:a4:7d:c3

```

- To verify the name server entries on the FCF, use the `show fc ns switch brief` command.

```

FCF# show fc ns switch brief
Total number of devices = 3

Intf# Domain FC-ID Enode-WWPN Enode-WWNN

fibrechannel1/1/3 2 02:00:00 21:00:00:24:ff:7c:ae:0e
20:04:00:11:0d:64:67:00
ethernet1/1/13 2 02:01:00 20:01:f4:e9:d4:a4:7d:c3
23:00:55:2c:cf:55:00:00

```

- To verify the active zoneset on the FCF, use the `show fc zoneset active` command.

```

FCF# show fc zoneset active

vFabric id: 2
Active Zoneset: zonesetA
ZoneName ZoneMember
=====
zoneA
20:01:f4:e9:d4:a4:7d:c3

 21:00:00:24:ff:7c:ae:0e

```

## Sample Multi-hop FSB configuration

The following is a sample multi-hop FSB topology.

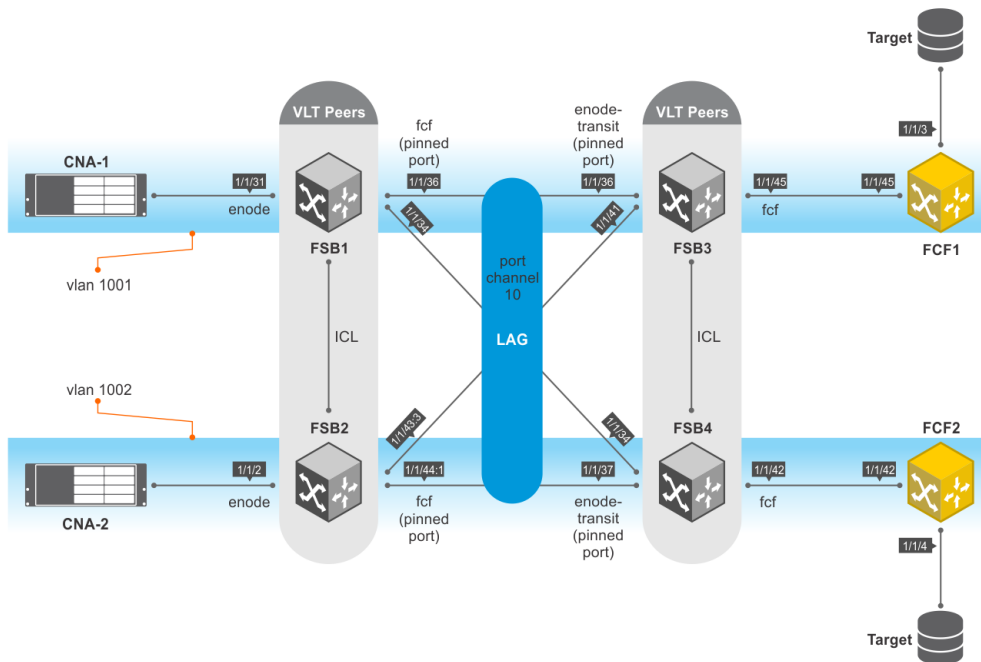

In this topology:

- FSB1 and FSB2—access FSBs.
- FSB3 and FSB4—core FSBs.

- VLT is configured between FSB1 and FSB2, and requires port-pinning for VLT port channels configured between access FSBs and core FSBs. The port modes are:
  - Directly-connected CNA ports—ENode
  - Ports connected to FSB3 and FSB4—FCF
- VLT is configured between FSB3 and FSB4, and requires port-pinning for VLT port channels configured between access and core FSBs. The port modes are:
  - Ports connected to FSB1 and FSB2—ENode-transit
  - Ports connected to FCFs, for pinning to work at ENode port—FCF

The following table lists the high-level configurations on FSB1, FSB3, and FCF1. These configurations apply to FSB2, FSB4, and FCF2, respectively.

**Table 19. High-level configurations on FSB1, FSB3, and FCF1**

| FSB1/FSB2                                                                                                                                                                                                                                                                                                                                                                                                                                                                                                                                                                                                                               | FSB3/FSB4                                                                                                                                                                                                                                                                                                                                                                                                                                                                                                                                                                                                                                                        | FCF1/FCF2                                                                                                                                                                                                                                                                                                                                                                                                                                                                                                                             |
|-----------------------------------------------------------------------------------------------------------------------------------------------------------------------------------------------------------------------------------------------------------------------------------------------------------------------------------------------------------------------------------------------------------------------------------------------------------------------------------------------------------------------------------------------------------------------------------------------------------------------------------------|------------------------------------------------------------------------------------------------------------------------------------------------------------------------------------------------------------------------------------------------------------------------------------------------------------------------------------------------------------------------------------------------------------------------------------------------------------------------------------------------------------------------------------------------------------------------------------------------------------------------------------------------------------------|---------------------------------------------------------------------------------------------------------------------------------------------------------------------------------------------------------------------------------------------------------------------------------------------------------------------------------------------------------------------------------------------------------------------------------------------------------------------------------------------------------------------------------------|
| <ol style="list-style-type: none"> <li>1. Enable FIP snooping.</li> <li>2. Enable DCBX.</li> <li>3. Create FCoE VLAN and configure FIP snooping.</li> <li>4. Create class-maps.</li> <li>5. Create policy-maps.</li> <li>6. Create a qos-map.</li> <li>7. Configure port channel.</li> <li>8. Configure VLTi interface member links.</li> <li>9. Configure VLT domain.</li> <li>10. Configure VLAN.</li> <li>11. Apply QoS configurations on uplink (FSB3/FSB4) and downlink interfaces (CNA-1/CNA-2). Configure the uplink interface as pinned-port.</li> <li>12. Configure FIP snooping port mode on the uplink interface.</li> </ol> | <ol style="list-style-type: none"> <li>1. Enable FIP snooping.</li> <li>2. Enable DCBX.</li> <li>3. Create FCoE VLAN and configure FIP snooping.</li> <li>4. Create class-maps.</li> <li>5. Create policy-maps.</li> <li>6. Create a qos-map.</li> <li>7. Configure port channel.</li> <li>8. Configure VLTi interface member links.</li> <li>9. Configure VLT domain.</li> <li>10. Configure VLAN.</li> <li>11. Apply QoS configurations on the uplink (FCF1/FCF2) and downlink interfaces (FSB1/FSB2). Configure the downlink interface as pinned-port.</li> <li>12. Configure FIP snooping port mode on the uplink interface and the port channel.</li> </ol> | <ol style="list-style-type: none"> <li>1. Enable Fiber Channel F-Port mode globally.</li> <li>2. Create zones.</li> <li>3. Create zoneset.</li> <li>4. Create a vfabric VLAN.</li> <li>5. Create vfabric and activate the zoneset.</li> <li>6. Enable DCBX.</li> <li>7. Create class-maps.</li> <li>8. Create policy-maps.</li> <li>9. Create a qos-map.</li> <li>10. Apply QoS configurations on the downlink interface (FSB3/FSB4).</li> <li>11. Apply vfabric on the downlink and uplink (target-connected) interfaces.</li> </ol> |

## FSB1 configuration

1. Enable FIP snooping.

```
FSB1(config)# feature fip-snooping with-cvl
```

2. Enable DCBX.

```
FSB1(config)# dcbx enable
```

3. Create FCoE VLAN and configure FIP snooping.

```
FSB1(config)#interface vlan1001
FSB1(conf-if-vl-1001)# fip-snooping enable
FSB1(conf-if-vl-1001)# no shutdown
```

```
FSB1(config)#interface vlan1002
FSB1(conf-if-vl-1002)# fip-snooping enable
FSB1(conf-if-vl-1002)# no shutdown
```

4. Create class-maps.

```
FSB1(config)# class-map type network-qos c3
FSB1(config-cmap-nqos)# match qos-group 3
```

```
FSB1(config)# class-map type queuing q0
FSB1(config-cmap-queuing)# match queue 0
FSB1(config-cmap-queuing)# exit
FSB1(config)# class-map type queuing q3
FSB1(config-cmap-queuing)# match queue 3
FSB1(config-cmap-queuing)# exit
```

5. Create policy-maps.

```
FSB1(config)# policy-map type network-qos nqpolicy
FSB1(config-pmap-network-qos)# class c3
FSB1(config-pmap-c-nqos)# pause
FSB1(config-pmap-c-nqos)# pfc-cos 3
```

```
FSB1(config)# policy-map type queuing ets_policy
FSB1(config-pmap-queuing)# class q0
FSB1(config-pmap-c-que)# bandwidth percent 30
FSB1(config-pmap-c-que)# class q3
FSB1(config-pmap-c-que)# bandwidth percent 70
```

6. Create a qos-map.

```
FSB1(config)# qos-map traffic-class tc-q-map1
FSB1(config-qos-map)# queue 3 qos-group 3
FSB1(config-qos-map)# queue 0 qos-group 0-2,4-7
```

7. Configure port channel.

```
FSB1(config)# interface port-channel 10
FSB1(conf-if-po-10)# no shutdown
FSB1(conf-if-po-10)# vlt-port-channel 1
```

8. Configure VLTi interface member links.

```
FSB1(config)# interface ethernet1/1/32
FSB1(conf-if-eth1/1/32)# no shutdown
FSB1(conf-if-eth1/1/32)# no switchport
```

```
FSB1(config)# interface ethernet1/1/33
FSB1(conf-if-eth1/1/33)# no shutdown
FSB1(conf-if-eth1/1/33)# no switchport
```

```
FSB1(config)# interface ethernet1/1/34
FSB1(conf-if-eth1/1/34)# no shutdown
FSB1(conf-if-eth1/1/34)# no switchport
FSB1(conf-if-eth1/1/34)# channel-group 10
```

```
FSB1(config)# interface ethernet 1/1/36
FSB1(conf-if-eth1/1/36)# no shutdown
FSB1(conf-if-eth1/1/36)# no switchport
FSB1(conf-if-eth1/1/36)# channel-group 10
```

9. Configure VLT domain.

```
FSB1(config)# vlt-domain 2
FSB1(conf-vlt-2)# discovery-interface ethernet1/1/32-1/1/33
FSB1(conf-vlt-2)# vlt-mac 1a:2b:3c:0a:0b:0c
```

10. Configure VLAN on FSB1.

```
FSB1(config)# interface ethernet 1/1/31
FSB1(conf-if-eth1/1/31)# no shutdown
FSB1(conf-if-eth1/1/31)# switchport mode trunk
```

```
FSB1(conf-if-eth1/1/31)# switchport access vlan 1
FSB1(conf-if-eth1/1/31)# switchport trunk allowed vlan 1001
```

```
FSB1(config)# interface port-channel 10
FSB1(conf-if-po-10)# switchport mode trunk
FSB1(conf-if-po-10)# switchport access vlan 1
FSB1(conf-if-po-10)# switchport trunk allowed vlan 1001-1002
```

11. Apply QoS configurations on the interfaces connected to FSB2 and CNA-1. Configure the interface connected to FSB2 as pinned-port.

```
FSB1(config)# interface ethernet 1/1/36
FSB1(conf-if-eth1/1/36)# flowcontrol receive off
FSB1(conf-if-eth1/1/36)# priority-flow-control mode on
FSB1(conf-if-eth1/1/36)# ets mode on
FSB1(conf-if-eth1/1/36)# trust-map dot1p default
FSB1(conf-if-eth1/1/36)# qos-map traffic-class tc-q-map1
FSB1(conf-if-eth1/1/36)# service-policy input type network-qos nqpolicy
FSB1(conf-if-eth1/1/36)# service-policy output type queuing ets_policy
FSB1(conf-if-eth1/1/36)# fcoe-pinned-port
```

```
FSB1(config)# interface ethernet 1/1/31
FSB1(conf-if-eth1/1/31)# flowcontrol receive off
FSB1(conf-if-eth1/1/31)# priority-flow-control mode on
FSB1(conf-if-eth1/1/31)# ets mode on
FSB1(conf-if-eth1/1/31)# trust-map dot1p default
FSB1(conf-if-eth1/1/31)# qos-map traffic-class tc-q-map1
FSB1(conf-if-eth1/1/31)# service-policy input type network-qos nqpolicy
FSB1(conf-if-eth1/1/31)# service-policy output type queuing ets_policy
```

12. Configure FIP snooping port mode on the port channel interface. The default port mode is ENode. Hence, the interface connected to CNA-1 does not require additional configuration.

```
FSB1(config)# interface port-channel 10
FSB1(conf-if-po-10)# fip-snooping port-mode fcf
```

## FSB2 configuration

1. Enable FIP snooping.

```
FSB2(config)# feature fip-snooping with-cvl
```

2. Enable DCBX.

```
FSB2(config)# dcbx enable
```

3. Create FCoE VLAN and configure FIP snooping.

```
FSB2(config)#interface vlan1001
FSB2(conf-if-vl-1001)# fip-snooping enable
FSB2(conf-if-vl-1001)# no shutdown
```

```
FSB2(config)#interface vlan1002
FSB2(conf-if-vl-1002)# fip-snooping enable
FSB2(conf-if-vl-1002)# no shutdown
```

4. Create class-maps.

```
FSB2(config)# class-map type network-qos c3
FSB2(config-cmap-nqos)# match qos-group 3
```

```
FSB2(config)# class-map type queuing q0
FSB2(config-cmap-queuing)# match queue 0
FSB2(config-cmap-queuing)# exit
FSB2(config)# class-map type queuing q3
```

```
FSB2(config-cmap-queuing)# match queue 3
FSB2(config-cmap-queuing)# exit
```

5. Create policy-maps.

```
FSB2(config)# policy-map type network-qos nqpolicy
FSB2(config-pmap-network-qos)# class c3
FSB2(config-pmap-c-nqos)# pause
FSB2(config-pmap-c-nqos)# pfc-cos 3
```

```
FSB2(config)# policy-map type queuing ets_policy
FSB2(config-pmap-queuing)# class q0
FSB2(config-pmap-c-que)# bandwidth percent 30
FSB2(config-pmap-c-que)# class q3
FSB2(config-pmap-c-que)# bandwidth percent 70
```

6. Create a qos-map.

```
FSB2(config)# qos-map traffic-class tc-q-map1
FSB2(config-qos-map)# queue 3 qos-group 3
FSB2(config-qos-map)# queue 0 qos-group 0-2,4-7
```

7. Configure port channel.

```
FSB2(config)# interface port-channel 10
FSB2(conf-if-po-10)# no shutdown
FSB2(conf-if-po-10)# vlt-port-channel 1
```

8. Configure VLTi interface member links.

```
FSB2(config)# interface ethernet1/1/43:1
FSB2(conf-if-eth1/1/43:1)# no shutdown
FSB2(conf-if-eth1/1/43:1)# no switchport
```

```
FSB2(config)# interface ethernet1/1/43:2
FSB2(conf-if-eth1/1/43:2)# no shutdown
FSB2(conf-if-eth1/1/43:2)# no switchport
```

```
FSB2(config)# interface ethernet 1/1/43:3
FSB2(conf-if-eth1/1/43:3)# no shutdown
FSB2(conf-if-eth1/1/43:3)# no switchport
FSB2(conf-if-eth1/1/43:3)# channel-group 10
```

```
FSB2(config)# interface ethernet1/1/44:1
FSB2(conf-if-eth1/1/44:1)# no shutdown
FSB2(conf-if-eth1/1/44:1)# no switchport
FSB2(conf-if-eth1/1/44:1)# channel-group 10
```

9. Configure VLT domain.

```
FSB2(config)# vlt-domain 2
FSB2(conf-vlt-2)# discovery-interface ethernet1/1/43:1-1/1/43:2
FSB2(conf-vlt-2)# vlt-mac 1a:2b:3c:0a:0b:0c
```

10. Configure VLAN on FSB2.

```
FSB2(config)# interface ethernet 1/1/2
FSB2(conf-if-eth1/1/2)# no shutdown
FSB2(conf-if-eth1/1/2)# switchport mode trunk
FSB2(conf-if-eth1/1/2)# switchport access vlan 1
FSB2(conf-if-eth1/1/2)# switchport trunk allowed vlan 1002
```

```
FSB2(config)# interface port-channel 10
FSB2(conf-if-po-10)# switchport mode trunk
FSB2(conf-if-po-10)# switchport access vlan 1
FSB2(conf-if-po-10)# switchport trunk allowed vlan 1001-1002
```



11. Apply QoS configurations on the interfaces connected to FSB4 and CNA-2. Configure the interface connected to FSB4 as pinned-port.

```
FSB2(config)# interface ethernet 1/1/44:1
FSB2(conf-if-eth1/1/44:1)# flowcontrol receive off
FSB2(conf-if-eth1/1/44:1)# priority-flow-control mode on
FSB2(conf-if-eth1/1/44:1)# ets mode on
FSB2(conf-if-eth1/1/44:1)# trust-map dot1p default
FSB2(conf-if-eth1/1/44:1)# qos-map traffic-class tc-q-map1
FSB2(conf-if-eth1/1/44:1)# service-policy input type network-qos nqpolicy
FSB2(conf-if-eth1/1/44:1)# service-policy output type queuing ets_policy
FSB2(conf-if-eth1/1/44:1)# fcoe-pinned-port
```

```
FSB2(config)# interface ethernet 1/1/2
FSB2(conf-if-eth1/1/2)# flowcontrol receive off
FSB2(conf-if-eth1/1/2)# priority-flow-control mode on
FSB2(conf-if-eth1/1/2)# ets mode on
FSB2(conf-if-eth1/1/2)# trust-map dot1p default
FSB2(conf-if-eth1/1/2)# qos-map traffic-class tc-q-map1
FSB2(conf-if-eth1/1/2)# service-policy input type network-qos nqpolicy
FSB2(conf-if-eth1/1/2)# service-policy output type queuing ets_policy
```

12. Configure FIP snooping port mode on the port channel interface. The default port mode is ENode. Hence, the interface connected to CNA-2 does not require additional configuration.

```
FSB2(config)# interface port-channel 10
FSB2(conf-if-po-10)# fip-snooping port-mode fcf
```

## FSB3 configuration

1. Enable FIP snooping.

```
FSB3(config)# feature fip-snooping with-cvl
```

2. Enable DCBX.

```
FSB3(config)# dcbx enable
```

3. Create FCoE VLAN and configure FIP snooping.

```
FSB3(config)#interface vlan1001
FSB3(conf-if-vl-1001)# fip-snooping enable
FSB3(conf-if-vl-1001)# no shutdown
```

```
FSB3(config)#interface vlan1002
FSB3(conf-if-vl-1002)# fip-snooping enable
FSB3(conf-if-vl-1002)# no shutdown
```

4. Create class-maps.

```
FSB3(config)# class-map type network-qos c3
FSB3(config-cmap-nqos)# match qos-group 3
```

```
FSB3(config)# class-map type queuing q0
FSB3(config-cmap-queuing)# match queue 0
FSB3(config-cmap-queuing)# exit
FSB3(config)# class-map type queuing q3
FSB3(config-cmap-queuing)# match queue 3
FSB3(config-cmap-queuing)# exit
```

5. Create policy-maps.

```
FSB3(config)# policy-map type network-qos nqpolicy
FSB3(config-pmap-network-qos)# class c3
```

```
FSB3(config-pmap-c-nqos)# pause
FSB3(config-pmap-c-nqos)# pfc-cos 3
```

```
FSB3(config)# policy-map type queuing ets_policy
FSB3(config-pmap-queuing)# class q0
FSB3(config-pmap-c-que)# bandwidth percent 30
FSB3(config-pmap-c-que)# class q3
FSB3(config-pmap-c-que)# bandwidth percent 70
```

6. Create a qos-map.

```
FSB3(config)# qos-map traffic-class tc-q-map1
FSB3(config-qos-map)# queue 3 qos-group 3
FSB3(config-qos-map)# queue 0 qos-group 0-2,4-7
```

7. Configure port channel.

```
FSB3(config)# interface port-channel 10
FSB3(conf-if-po-10)# no shutdown
FSB3(conf-if-po-10)# vlt-port-channel 1
```

8. Configure VLTi interface member links.

```
FSB3(config)# interface ethernet1/1/39
FSB3(conf-if-eth1/1/39)# no shutdown
FSB3(conf-if-eth1/1/39)# no switchport
```

```
FSB3(config)# interface ethernet1/1/40
FSB3(conf-if-eth1/1/40)# no shutdown
FSB3(conf-if-eth1/1/40)# no switchport
```

```
FSB3(config)# interface ethernet1/1/41
FSB3(conf-if-eth1/1/41)# no shutdown
FSB3(conf-if-eth1/1/41)# no switchport
FSB3(conf-if-eth1/1/41)# channel-group 10
```

```
FSB3(config)# interface ethernet 1/1/36
FSB3(conf-if-eth1/1/36)# no shutdown
FSB3(conf-if-eth1/1/36)# no switchport
FSB3(conf-if-eth1/1/36)# channel-group 10
```

9. Configure VLT domain.

```
FSB3(config)# vlt-domain 3
FSB3(conf-vlt-3)# discovery-interface ethernet1/1/39-1/1/40
FSB3(conf-vlt-3)# vlt-mac 1a:2b:3c:2a:1b:1c
```

10. Configure VLAN on FSB3.

```
FSB3(config)# interface ethernet 1/1/45
FSB3(conf-if-eth1/1/45)# no shutdown
FSB3(conf-if-eth1/1/45)# switchport mode trunk
FSB3(conf-if-eth1/1/45)# switchport access vlan 1
FSB3(conf-if-eth1/1/45)# switchport trunk allowed vlan 1001
```

```
FSB3(config)# interface port-channel 10
FSB3(conf-if-po-10)# switchport mode trunk
FSB3(conf-if-po-10)# switchport access vlan 1
FSB3(conf-if-po-10)# switchport trunk allowed vlan 1001-1002
```

11. Apply QoS configurations on the interfaces connected to FCB1 and FSB1. Configure the interface connected to FSB1 as pinned-port.

```
FSB3(config)# interface ethernet 1/1/45
FSB3(conf-if-eth1/1/45)# flowcontrol receive off
FSB3(conf-if-eth1/1/45)# priority-flow-control mode on
FSB3(conf-if-eth1/1/45)# ets mode on
FSB3(conf-if-eth1/1/45)# trust-map dot1p default
```

```
FSB3(config-if-eth1/1/45)# qos-map traffic-class tc-q-map1
FSB3(config-if-eth1/1/45)# service-policy input type network-qos nqpolicy
FSB3(config-if-eth1/1/45)# service-policy output type queuing ets_policy
```

```
FSB3(config)# interface ethernet 1/1/36
FSB3(config-if-eth1/1/36)# flowcontrol receive off
FSB3(config-if-eth1/1/36)# priority-flow-control mode on
FSB3(config-if-eth1/1/36)# ets mode on
FSB3(config-if-eth1/1/36)# trust-map dot1p default
FSB3(config-if-eth1/1/36)# qos-map traffic-class tc-q-map1
FSB3(config-if-eth1/1/36)# service-policy input type network-qos nqpolicy
FSB3(config-if-eth1/1/36)# service-policy output type queuing ets_policy
FSB3(config-if-eth1/1/36)# fcoe-pinned-port
```

12. Configure FIP snooping port mode on the port channel and the interface connected to FCF1.

```
FSB3(config)# interface port-channel 10
FSB3(config-if-po-10)# fip-snooping port-mode enode-transit
```

```
FSB3(config)# interface ethernet 1/1/45
FSB3(config-if-eth1/1/45)# fip-snooping port-mode fcf
```

## FSB4 configuration

1. Enable FIP snooping.

```
FSB4(config)# feature fip-snooping with-cvl
```

2. Enable DCBX.

```
FSB4(config)# dcbx enable
```

3. Create FCoE VLAN and configure FIP snooping.

```
FSB4(config)#interface vlan1001
FSB4(config-if-vl-1001)# fip-snooping enable
FSB4(config-if-vl-1001)# no shutdown
```

```
FSB4(config)#interface vlan1002
FSB4(config-if-vl-1002)# fip-snooping enable
FSB4(config-if-vl-1002)# no shutdown
```

4. Create class-maps.

```
FSB4(config)# class-map type network-qos c3
FSB4(config-cmap-nqos)# match qos-group 3
```

```
FSB4(config)# class-map type queuing q0
FSB4(config-cmap-queuing)# match queue 0
FSB4(config-cmap-queuing)# exit
FSB4(config)# class-map type queuing q3
FSB4(config-cmap-queuing)# match queue 3
FSB4(config-cmap-queuing)# exit
```

5. Create policy-maps.

```
FSB4(config)# policy-map type network-qos nqpolicy
FSB4(config-pmap-network-qos)# class c3
FSB4(config-pmap-c-nqos)# pause
FSB4(config-pmap-c-nqos)# pfc-cos 3
```

```
FSB4(config)# policy-map type queuing ets_policy
FSB4(config-pmap-queuing)# class q0
FSB4(config-pmap-c-que)# bandwidth percent 30
```

```
FSB4(config-pmap-c-que)# class q3
FSB4(config-pmap-c-que)# bandwidth percent 70
```

6. Create a qos-map.

```
FSB4(config)# qos-map traffic-class tc-q-map1
FSB4(config-qos-map)# queue 3 qos-group 3
FSB4(config-qos-map)# queue 0 qos-group 0-2,4-7
```

7. Configure port channel.

```
FSB4(config)# interface port-channel 10
FSB4(conf-if-po-10)# no shutdown
FSB4(conf-if-po-10)# vlt-port-channel 1
```

8. Configure VLTi interface member links.

```
FSB4(config)# interface ethernet1/1/34
FSB4(conf-if-eth1/1/34)# no shutdown
FSB4(conf-if-eth1/1/34)# no switchport
FSB4(conf-if-eth1/1/34)# channel-group 10
```

```
FSB4(config)# interface ethernet1/1/37
FSB4(conf-if-eth1/1/37)# no shutdown
FSB4(conf-if-eth1/1/37)# no switchport
FSB4(conf-if-eth1/1/37)# channel-group 10
```

9. Configure VLT domain.

```
FSB4(config)# vlt-domain 3
FSB4(conf-vlt-2)# discovery-interface ethernet1/1/40
FSB4(conf-vlt-2)# vlt-mac 1a:2b:3c:2a:1b:1c
```

10. Configure VLAN on FSB4.

```
FSB4(config)# interface ethernet 1/1/42
FSB4(conf-if-eth1/1/42)# no shutdown
FSB4(conf-if-eth1/1/42)# switchport mode trunk
FSB4(conf-if-eth1/1/42)# switchport access vlan 1
FSB4(conf-if-eth1/1/42)# switchport trunk allowed vlan 1002
```

```
FSB4(config)# interface port-channel 10
FSB4(conf-if-po-10)# switchport mode trunk
FSB4(conf-if-po-10)# switchport access vlan 1
FSB4(conf-if-po-10)# switchport trunk allowed vlan 1001-1002
```

11. Apply QoS configurations on the interfaces connected to FCF2.

```
FSB4(config)# interface ethernet 1/1/42
FSB4(conf-if-eth1/1/42)# flowcontrol receive off
FSB4(conf-if-eth1/1/42)# priority-flow-control mode on
FSB4(conf-if-eth1/1/42)# ets mode on
FSB4(conf-if-eth1/1/42)# trust-map dot1p default
FSB4(conf-if-eth1/1/42)# qos-map traffic-class tc-q-map1
FSB4(conf-if-eth1/1/42)# service-policy input type network-qos nqpolicy
FSB4(conf-if-eth1/1/42)# service-policy output type queuing ets_policy
```

12. Configure FIP snooping port mode on the port channel and the interface connected to FCF2. Configure the interface connected to FSB2 as pinned-port.

```
FSB4(config)# interface port-channel 10
FSB4(conf-if-po-10)# fip-snooping port-mode enode-transit
```

```
FSB4(config)# interface ethernet 1/1/42
FSB4(conf-if-eth1/1/42)# fip-snooping port-mode fcf
```

```
FSB4(config)# interface ethernet 1/1/37
FSB4(conf-if-eth1/1/37)# fcoe-pinned-port
```

## FCF1 configuration

1. Enable Fiber Channel F-Port mode globally.

```
FCF1(config)# feature fc domain-id 2
```

2. Create zones.

```
FCF1(config)# fc zone zoneA
FCF1(config-fc-zone-zoneA)# member wwn 23:05:22:11:0d:64:67:11
FCF1(config-fc-zone-zoneA)# member wwn 50:00:d3:10:00:ec:f9:00
```

3. Create zoneset.

```
FCF1(config)# fc zoneset zonesetA
FCF1(config-fc-zoneset-setA)# member zoneA
```

4. Create a vfabric VLAN.

```
FCF1(config)# interface vlan 1001
```

5. Create vfabric and activate the zoneset.

```
FCF1(config)# vfabric 1
FCF1(config-vfabric-1)# vlan 1001
FCF1(config-vfabric-1)# fcoe fcmap 0xEFC00
FCF1(config-vfabric-1)# zoneset activate zonesetA
```

6. Enable DCBX.

```
FCF1(config)# dcbx enable
```

7. Create class-maps.

```
FCF1(config)# class-map type network-qos c3
FCF1(config-cmap-nqos)# match qos-group 3
```

```
FCF1(config)# class-map type queuing q0
FCF1(config-cmap-queuing)# match queue 0
FCF1(config-cmap-queuing)# exit
FCF1(config)# class-map type queuing q3
FCF1(config-cmap-queuing)# match queue 3
FCF1(config-cmap-queuing)# exit
```

8. Create policy-maps.

```
FCF1(config)# policy-map type network-qos nqpolicy
FCF1(config-pmap-network-qos)# class c3
FCF1(config-pmap-c-nqos)# pause
FCF1(config-pmap-c-nqos)# pfc-cos 3
```

```
FCF1(config)# policy-map type queuing ets_policy
FCF1(config-pmap-queuing)# class q0
FCF1(config-pmap-c-que)# bandwidth percent 30
FCF1(config-pmap-c-que)# class q3
FCF1(config-pmap-c-que)# bandwidth percent 70
```

9. Create a qos-map.

```
FCF1(config)# qos-map traffic-class tc-q-map1
FCF1(config-qos-map)# queue 3 qos-group 3
FCF1(config-qos-map)# queue 0 qos-group 0-2,4-7
```

10. Apply QoS configurations on the interface connected to FSB3.

```
FCF1(config)# interface ethernet 1/1/45
FCF1(config-if-eth1/1/45)# no shutdown
FCF1(config-if-eth1/1/45)# flowcontrol receive off
FCF1(config-if-eth1/1/45)# priority-flow-control mode on
```

```
FCF1(conf-if-eth1/1/45)# ets mode on
FCF1(conf-if-eth1/1/45)# trust-map dot1p default
FCF1(conf-if-eth1/1/45)# qos-map traffic-class tc-q-map1
FCF1(conf-if-eth1/1/45)# service-policy input type network-qos nqpolicy
FCF1(conf-if-eth1/1/45)# service-policy output type queuing ets_policy
```

11. Apply vfabric on the interfaces connected to FSB3 and the target.

```
FCF1(config)# interface ethernet 1/1/45
FCF1(conf-if-eth1/1/45)# switchport access vlan 1
FCF1(conf-if-eth1/1/45)# vfabric 1
```

```
FCF1(config)# interface fibrechannel 1/1/3
FCF1(conf-if-fc1/1/3)# description target_connected_port
FCF1(conf-if-fc1/1/3)# no shutdown
FCF1(conf-if-fc1/1/3)# vfabric 1
```

## FCF2 configuration

1. Enable Fiber Channel F-Port mode globally.

```
FCF2(config)# feature fc domain-id 3
```

2. Create zones.

```
FCF2(config)# fc zone zoneB
FCF2(config-fc-zone-zoneB)# member wwn 20:01:00:0e:1e:f1:f1:84
FCF2(config-fc-zone-zoneB)# member wwn 53:00:a3:10:00:ec:f9:01
```

3. Create zoneset.

```
FCF2(config)# fc zoneset zonesetB
FCF2(conf-fc-zoneset-setB)# member zoneB
```

4. Create a vfabric VLAN.

```
FCF2(config)# interface vlan 1002
```

5. Create vfabric and activate the zoneset.

```
FCF2(config)# vfabric 2
FCF2(conf-vfabric-2)# vlan 1002
FCF2(conf-vfabric-2)# fcoe fcmap 0xEFC00
FCF2(conf-vfabric-2)# zoneset activate zonesetB
```

6. Enable DCBX.

```
FCF2(config)# dcbx enable
```

7. Create class-maps.

```
FCF2(config)# class-map type network-qos c3
FCF2(config-cmap-nqos)# match qos-group 3
```

```
FCF2(config)# class-map type queuing q0
FCF2(config-cmap-queuing)# match queue 0
FCF2(config-cmap-queuing)# exit
FCF2(config)# class-map type queuing q3
FCF2(config-cmap-queuing)# match queue 3
FCF2(config-cmap-queuing)# exit
```

8. Create policy-maps.

```
FCF2(config)# policy-map type network-qos nqpolicy
FCF2(config-pmap-network-qos)# class c3
```

```
FCF2(config-pmap-c-nqos)# pause
FCF2(config-pmap-c-nqos)# pfc-cos 3
```

```
FCF2(config)# policy-map type queuing ets_policy
FCF2(config-pmap-queuing)# class q0
FCF2(config-pmap-c-que)# bandwidth percent 30
FCF2(config-pmap-c-que)# class q3
FCF2(config-pmap-c-que)# bandwidth percent 70
```

9. Create a qos-map.

```
FCF2(config)# qos-map traffic-class tc-q-map1
FCF2(config-qos-map)# queue 3 qos-group 3
FCF2(config-qos-map)# queue 0 qos-group 0-2,4-7
```

10. Apply QoS configurations on the interface connected to FSB4.

```
FCF2(config)# interface ethernet 1/1/42
FCF2(conf-if-eth1/1/42)# no shutdown
FCF2(conf-if-eth1/1/42)# flowcontrol receive off
FCF2(conf-if-eth1/1/42)# priority-flow-control mode on
FCF2(conf-if-eth1/1/42)# ets mode on
FCF2(conf-if-eth1/1/42)# trust-map dot1p default
FCF2(conf-if-eth1/1/42)# qos-map traffic-class tc-q-map1
FCF2(conf-if-eth1/1/42)# service-policy input type network-qos nqpolicy
FCF2(conf-if-eth1/1/42)# service-policy output type queuing ets_policy
```

11. Apply vfabric on the interfaces connected to FSB4 and the target.

```
FCF2(config)# interface ethernet 1/1/42
FCF2(conf-if-eth1/1/42)# switchport access vlan 1
FCF2(conf-if-eth1/1/42)# vfabric 1
```

```
FCF2(config)# interface fibrechannel 1/1/4
FCF2(conf-if-fc1/1/4)# description target_connected_port
FCF2(conf-if-fc1/1/4)# no shutdown
FCF2(conf-if-fc1/1/4)# vfabric 2
```

## Verify the configuration

Use the following show commands to verify the configuration:

### FSB1

```
FSB1# show fcoe sessions
Enode MAC Enode Interface FCF MAC FCF interface VLAN FCoE
MAC FC-ID PORT WWPN
PORT WWNN

f4:e9:d4:f9:fc:42 Eth 1/1/31 14:18:77:20:86:ce Po 10(Eth 1/1/36) 1001
0e:fc:00:02:02:00 02:02:00 23:05:22:11:0d:64:67:11 22:04:22:13:0d:64:67:00
```

```
FSB1# show fcoe fcf
FCF MAC FCF Interface VLAN FC-MAP FKA_ADV_PERIOD No. of
Enodes FCF Mode

14:18:77:20:86:ce Po 10(Eth 1/1/36) 1001 0e:fc:00 8000
1 F
```

```
FSB1# show fcoe system
Mode : FSB
CVL Status : Enabled
FCOE VLAN List (Operational) : 1001,1002
FCFs : 1
```

```

Enodes : 1
Sessions : 1

```

### FSB2

```

FSB2# show fcoe sessions
Enode MAC Enode Interface FCF MAC FCF interface VLAN FCoE
MAC FC-ID PORT WWPN PORT WWNN

00:0e:1e:f1:f1:84 Eth 1/1/1 14:18:77:20:80:ce Po 10(Eth 1/1/44:1)1002
0e:fc:00:02:01:00 02:01:00 20:01:00:0e:1e:f1:f1:84 20:00:00:0e:1e:f1:f1:84

```

```

FSB2# show fcoe fcf
FCF MAC FCF Interface VLAN FC-MAP FKA_ADV_PERIOD No. of
Enodes FCF Mode

14:18:77:20:80:ce Po 10(Eth 1/1/44:1) 1002 0e:fc:00 8000
1 F

```

```

FSB2# show fcoe system
Mode : FSB
CVL Status : Enabled
FCOE VLAN List (Operational) : 1001,1002
FCFs : 1
Enodes : 1
Sessions : 1

```

### FSB3

```

FSB3# show fcoe sessions
Enode MAC Enode Interface FCF MAC FCF interface VLAN FCoE
MAC FC-ID PORT WWPN PORT WWNN

f4:e9:d4:f9:fc:42 Po 10(Eth 1/1/36) 14:18:77:20:86:ce Eth 1/1/45 1001
0e:fc:00:02:02:00 02:02:00 23:05:22:11:0d:64:67:11 22:04:22:13:0d:64:67:00

```

```

FSB3# show fcoe fcf
FCF MAC FCF Interface VLAN FC-MAP FKA_ADV_PERIOD No. of
Enodes FCF Mode

14:18:77:20:86:ce Eth 1/1/45 1001 0e:fc:00 8000
1 F

```

```

FSB3# show fcoe system
Mode : FSB
CVL Status : Enabled
FCOE VLAN List (Operational) : 1001,1002
FCFs : 1
Enodes : 1
Sessions : 1

```

### FSB4

```

FSB4# show fcoe sessions
Enode MAC Enode Interface FCF MAC FCF interface VLAN
FCoE MAC FC-ID PORT WWPN PORT WWNN

```



```
00:0e:1e:f1:f1:84 Po 10(Eth 1/1/37) 14:18:77:20:80:ce Eth 1/1/42 1002
0e:fc:00:02:01:00 02:01:00 20:01:00:0e:1e:f1:f1:84 20:00:00:0e:1e:f1:f1:84
```

```
FSB4# show fcoe fcf
FCF MAC FCF Interface VLAN FC-MAP FKA_ADV_PERIOD No. of
Enodes FCF Mode

14:18:77:20:80:ce Eth 1/1/42 1002 0e:fc:00 8000
1 F
```

```
FSB4# show fcoe system
Mode : FSB
CVL Status : Enabled
FCOE VLAN List (Operational) : 1001,1002
FCFs : 1
Enodes : 1
Sessions : 1
```

## FCF1

```
FCF1# show fcoe sessions
Enode MAC Enode Interface FCF MAC FCF interface VLAN FCoE
MAC FC-ID PORT WWPN PORT WWNN

f4:e9:d4:f9:fc:42 Eth 1/1/45 14:18:77:20:86:ce ~ 1001 0e:fc:00:02:02:00
02:02:00 23:05:22:11:0d:64:67:11 22:04:22:13:0d:64:67:00
```

```
FCF1# show fc ns switch brief
Total number of devices = 2
```

| Intf#                   | Domain | FC-ID    | Enode-WWPN              | Enode-WWNN |
|-------------------------|--------|----------|-------------------------|------------|
| fibrechannell1/1/3      | 2      | 02:00:00 | 50:00:d3:10:00:ec:f9:00 |            |
| 51:00:d3:10:00:ec:f9:01 |        |          |                         |            |
| ethernet1/1/45          | 2      | 02:02:00 | 23:05:22:11:0d:64:67:11 |            |
| 22:04:22:13:0d:64:67:00 |        |          |                         |            |

## FCF2

```
FCF2# show fcoe sessions
Enode MAC Enode Interface FCF MAC FCF interface VLAN FCoE
MAC FC-ID PORT WWPN PORT WWNN

00:0e:1e:f1:f1:84 Eth 1/1/42 14:18:77:20:80:ce ~ 1002 0e:fc:00:02:01:00
02:00:01 20:01:00:0e:1e:f1:f1:84 20:00:00:0e:1e:f1:f1:84
```

```
FCF2# show fc ns switch brief
Total number of devices = 2
```

| Intf#                   | Domain | FC-ID    | Enode-WWPN              | Enode-WWNN |
|-------------------------|--------|----------|-------------------------|------------|
| fibrechannell1/1/4      | 3      | 02:01:00 | 53:00:a3:10:00:ec:f9:01 |            |
| 52:00:a3:10:00:ec:f9:00 |        |          |                         |            |
| ethernet1/1/42          | 3      | 02:00:01 | 20:01:00:0e:1e:f1:f1:84 |            |
| 20:00:00:0e:1e:f1:f1:84 |        |          |                         |            |

## Configuration guidelines

When configuring different modes; for example, F\_Port, NPG, or FSB, consider the following:

- F\_Port, NPG, and FSB modes are mutually exclusive. You can enable only one at a time.
- You can enable the mode-specific commands only after enabling the specific feature.

- Before you disable the F\_Port and NPG features, delete the mode-specific configurations. When you disable FSB, the system automatically removes the configurations.
- If you connect a storage device (target) to the IOM Fibrechannel port and if the port is operationally UP, then the storage device will induce a port flap until you configure the FC DirectAttach uplink (vfabric) configuration on this port. This is because, the storage device tries to login to the IOM switch and flaps the port in case it does not receive the response. This is because the IOM side needs to be configured yet. Once you complete the configuration on the IOM side, then flaps are stopped and storage device logs in to the IOM switch.
- While configuring or unconfiguring the FC-Gateway uplink, the uplink interface flaps. As UFD is enabled by default for NPG (FCGateway Uplink) in SmartFabric mode; UFD brings down the server facing ports which are deployed with same FCoE VLAN as FCGateway uplink.
- Fibrechannel port flaps are observed on the IOM side if the IOM is operationally up and is connected to a storage device without configuring the FCDirectAttach uplink (vfabric) on this port. These flaps are induced by the storage device, as the storage device is unable to login to the IOM until the configuration on this port is applied. After the FCDirectAttach uplink (vfabric) configuration is completed on this port, the flaps stop and the storage device logs in to the IOM switch.

## NPIV Proxy Gateway cascading

OS10 supports connecting two switches as NPIV Proxy Gateways (NPIVs) between Converged Network Adapters (CNAs) or Fibre Channel Host Bus Adapters (FC HBAs) and FCoE Forwarder (FCF) switches.

In the following figure, NPG1 and NPG2 connect to each other which provide FCoE and FC services for CNA1 and FC HBA1, and the FCF1 switch.

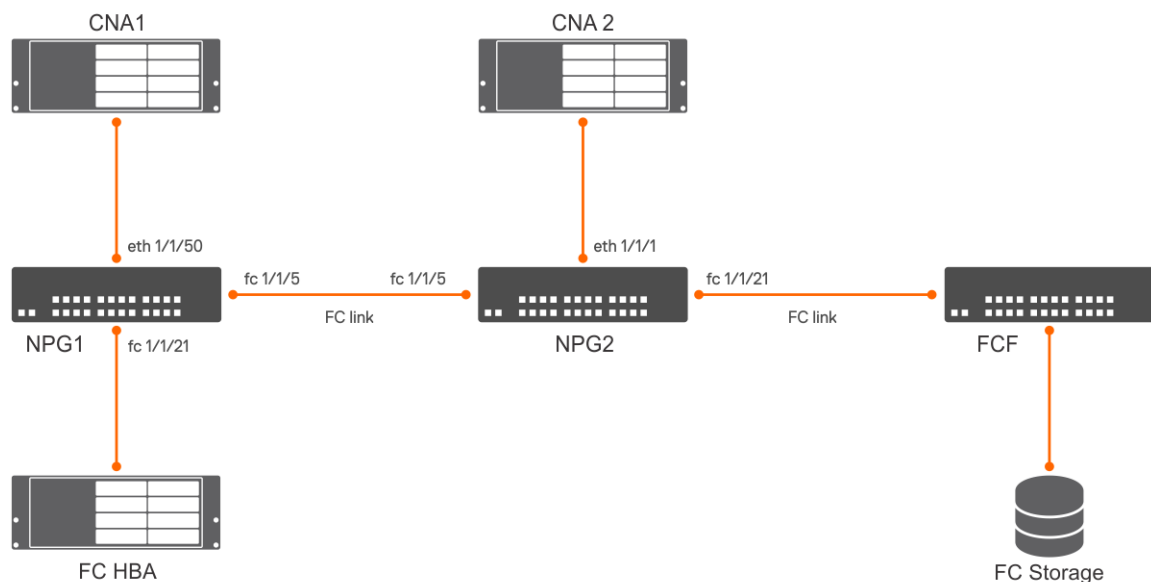

## NPG1 switch configuration

1. Enable the NPG feature.

```
OS10(config)# feature fc npg
```

2. Configure vFabric.

```
OS10(config)# vfabric 2
OS10(conf-vfabric-2)# vlan 1000
OS10(conf-vfabric-2)# name fcoe_fabric
OS10(conf-vfabric-2)# fcoe fcmapi 0efc02
```

3. Apply the vFabric configuration on the interface that connects to FC HBA and change the port mode to F\_Port.

```
OS10(config)# interface fibrechannel 1/1/21
OS10(conf-if-fc1/1/21)# vfabric 2
```

4. Apply the vFabric configuration on the interface that connects to CNA 1.

```
OS10(config)# interface ethernet 1/1/50
OS10(conf-if-eth1/1/50)# vfabric 2
```

5. Enable DCBX globally.

```
OS10(config)# dcbx enable
```

6. Create a class map and policy map.

```
OS10(config)# class-map type network-qos cmap1
OS10(config-cmap-nqos)# match qos-group 3
OS10(config)# policy-map type network-qos pmap1
OS10(config-pmap-network-qos)# class cmap1
OS10(config-pmap-c-nqos)# pause
OS10(config-pmap-c-nqos)# pfc-cos 3
```

7. Disable LLFC on the interface that connects to CNA 1.

```
OS10(config)# interface ethernet 1/1/50
OS10(conf-if-eth1/1/50)# no flowcontrol receive
```

8. Enable the PFC mode on the interface that connects to CNA 1.

```
OS10(config)# interface ethernet 1/1/50
OS10(conf-if-eth1/1/50)# priority-flow-control mode on
```

9. Apply the service policy on the interface that connects to CNA 1.

```
OS10(config)# interface ethernet 1/1/50
OS10(conf-if-eth1/1/50)# service-policy input type network-qos pmap1
```

10. Configure the interface that connects to NPG2.

```
OS10(config)# interface fibrechannel 1/1/5
OS10(config-if-fc1/1/5)# vfabric 2
```

## NPG2 switch configuration

1. Enable the NPG feature.

```
OS10(config)# feature fc npg
```

2. Configure vFabric.

```
OS10(config)# vfabric 2
OS10(conf-vfabric-2)# vlan 1000
OS10(conf-vfabric-2)# name fcoe_fabric
OS10(conf-vfabric-2)# fcoe fcmap 0efc02
```

3. Apply the vFabric configuration on the interface that connects to the NPG1 switch. Change port mode to F\_Port.

```
OS10(config)# interface fibrechannel 1/1/5
OS10(conf-if-fc1/1/21)# vfabric 2
OS10(conf-if-fc1/1/21)# fc port-mode f
```

4. Apply the vFabric configuration on the interface that connect to CNA 2.

```
OS10(config)# interface ethernet 1/1/1
OS10(conf-if-eth1/1/1)# vfabric 2
```

5. Enable DCBX globally.

```
OS10(config)# dcbx enable
```

6. Create a class map and policy map.

```
OS10(config)# class-map type network-qos cmap1
OS10(config-cmap-nqos)# match qos-group 3
OS10(config)# policy-map type network-qos pmap1
OS10(config-pmap-network-qos)# class cmap1
OS10(config-pmap-c-nqos)# pause
OS10(config-pmap-c-nqos)# pfc-cos 3
```

7. Disable LLFC on the interface that connects to CNA 2.

```
OS10(config)# interface ethernet 1/1/1
OS10(conf-if-eth1/1/1)# no flowcontrol receive
```

8. Enable PFC mode on the interface that connects to CNA 2.

```
OS10(config)# interface ethernet 1/1/1
OS10(conf-if-eth1/1/1)# priority-flow-control mode on
```

9. Apply the service policy on the interface that connects to CNA 2.

```
OS10(config)# interface ethernet 1/1/1
OS10(conf-if-eth1/1/1)# service-policy input type network-qos pmap1
```

10. Configure the interface that connects to FCF.

```
OS10(config)# interface fibrechannel 1/1/21
OS10(config-if-fc1/1/21)# vfabric 2
```

## Support for untagged VLAN in FCoE

In SmartFabric mode, OS10 provides support to use any untagged VLAN for FCoE Ethernet uplinks and Ethernet server ports, which are part of the FCoE VLAN.

The FCoE uplink identifies FIP Snooping bridge (FSB) mode at the switch. You must configure the same untagged VLAN on the FCoE uplinks and server ports for the FCoE sessions to come up.

In SmartFabric mode, you can assign any untagged VLAN to Ethernet server ports that belong to a FCoE VLAN that has one or more FC Gateway uplinks. The FC Gateway uplink identifies N-Port Proxy Gateway (NPG) mode at the switch. Also you can assign any untagged VLAN to Ethernet server ports that belong to a FCoE VLAN that has one or more FC Direct attach uplinks. The FC Direct attach uplink identifies F-Port mode at the switch.

### Restrictions

- SmartFabric mode does not support multiple FCoE uplinks from the same IOM.
- In FCoE mode, the untagged VLAN on the server port and the FCoE uplink must be the same. This condition ensures that the untagged FIP VLAN discovery packets in the L2 frame, switch to the untagged VLAN.
- You cannot configure multiple FCoE uplinks corresponding to different untagged VLANs.

## Rebalance FC sessions (NPG)

The Rebalance FC sessions feature enables you to balance the FC sessions in the NPIV Proxy Gateway (NPG) mode. The NPG mode bridges Fibre Channel over Ethernet (FCoE) and Fibre Channel (FC). This is done by exporting the configured upstream FC connections as Fibre Channel Forwarder (FCFs) to both FC and FCoE downstream ports. When multiple FCFs are connected to the NPG-enabled switch, the Node (CNA or HBA) selects the FCF to be logged in and loads all FCFs equally.

Along with the existing load balancing done during session establishment, you can also manually trigger an ENode-based rebalancing using the management interface command. Manual rebalance is done at the vFabric level by specifying the vFabric id. The session count and link speed are used as factors for stabilizing the system. Session count of an uplink includes the count of both Fabric Login Sessions (FLOGI) and Fabric Discovery Sessions (FDISC). Link speed corresponds to the speed of the FC uplinks.

You can also simulate load rebalancing. The simulation displays the current system state and the session displacements that need to be done to rebalance the system.

System log messages are received when the system closes a session for rebalancing. The log message provides the Fabric id, VLAN Id, FCoE MAC and the reason for termination.

## Load balancing after system reboot

After reboot, upstream FC connections to the end-devices become operational first and carry more sessions than the other upstream FC connections to SAN. This requires load balancing. You can address load balancing in the following ways:

- After reboot, check the system state and trigger rebalance using the CLI.
- Configure the delay fcf-adv timer. The delay timer starts when a new FC upstream interface is available. When the timer expires, the upstream connection and the other available connections become operational. This configuration ensures that there is enough time for all upstream connections to become operational before processing the session requests from end devices. Depending on the topology, you can decide the timeout value.

## NPG rebalance topology

The NPG rebalance topology has an OS10 switch operating in NPG mode and two FC upstream interfaces (fc 1/1/1 and fc 1/1/2) having a speed of 16 G.

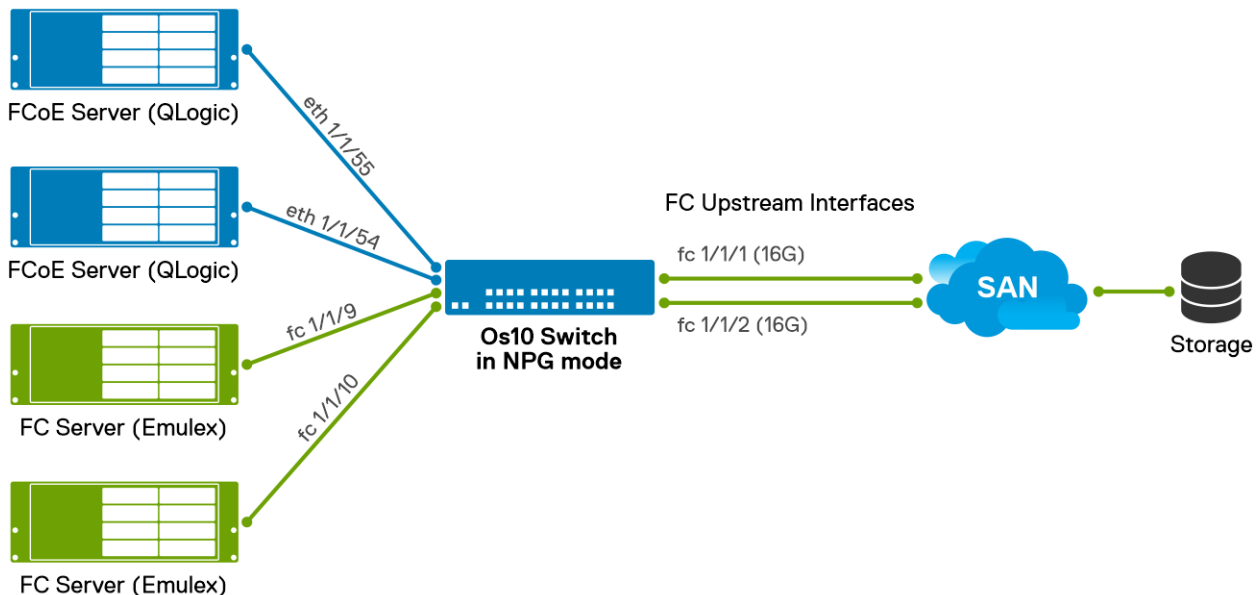

Two FCoE end points (C NAs) are attached to ports eth 1/1/54 and eth 1/1/55, which carry the FCoE traffic. FC end points (HBAs) are attached to ports fc 1/1/9 and fc 1/1/10, and they carry pure FC traffic.

Both the FCoE traffic and FC traffic need to be balanced across the FC upstream interfaces (fc 1/1/1 and fc 1/1/2) available in the NPG switch.

Use the information in the following sections to configure an NPG switch:

## NPG switch configurations

### Enable NPG mode of operation

```
OS10# show fc switch
Switch Mode : Disabled
Switch WWN :

OS10(config)# feature fc npg

OS10# show fc switch
Switch Mode : NPG
Switch WWN : 10:00:14:18:77:20:73:cf
OS10#
```

## Create VLAN

```
OS10(config)# interface vlan 100
```

## Create vFabric

```
OS10(config)# vfabric 100
OS10(conf-vfabric-100)# vlan 100
OS10(conf-vfabric-100)# name NPG_Fabric
OS10(conf-vfabric-100)# fcoe fcmapping 0efc01
OS10(conf-vfabric-100)# exit
```

## Apply vFabric and FC port-mode configuration on the interface that connects to FC end point (HBA)

```
OS10(config)# interface range fibrechannel 1/1/9,1/1/10
OS10(conf-range-fc1/1/9,1/1/10)# vfabric 100
OS10(conf-range-fc1/1/9,1/1/10)# fc port-mode F
OS10(conf-range-fc1/1/9,1/1/10)# no shut
OS10(conf-range-fc1/1/9,1/1/10)# exit
```

## Enable DCBx globally

```
OS10(config)# dcbx enable
```

## Create class map and policy map

```
OS10(config)# class-map type network-qos cmap1
OS10(config-cmap-nqos)# match qos-group 3
OS10(config)# policy-map type network-qos pmap1
OS10(config-pmap-network-qos)# class cmap1
OS10(config-pmap-c-nqos)# pause
OS10(config-pmap-c-nqos)# pfc-cos 3
OS10(config-pmap-c-nqos)# exit
```

## Disable LLFC on the interface that connects to FCoE end points (CNA)

```
OS10(config)# interface range ethernet 1/1/54,1/1/55
OS10(conf-range-eth1/1/54,1/1/55)# no flowcontrol receive
OS10(conf-range-eth1/1/54,1/1/55)# exit
```

## Apply service policy and enable PFC mode on the interface that connects to FCoE end point (CNA)

```
OS10(config)# interface range ethernet 1/1/54,1/1/55
OS10(conf-range-eth1/1/54,1/1/55)# service-policy input type network-qos pmap1
OS10(conf-range-eth1/1/54,1/1/55)# priority-flow-control mode on
OS10(conf-range-eth1/1/54,1/1/55)# exit
```

### Apply vFabric configuration on the interface that connects to FCoE end points (CNA)

```
OS10(config)# interface range ethernet 1/1/54,1/1/55
OS10(conf-range-eth1/1/54,1/1/55)# vfabric 100
OS10(conf-range-eth1/1/54,1/1/55)# no shut
OS10(conf-range-eth1/1/54,1/1/55)# exit
```

### Apply vFabric configuration on the FC upstream interfaces

```
OS10(config)# interface range fibrechannel 1/1/1,1/1/2
OS10(conf-range-fc1/1/1,1/1/2)# vfabric 100
OS10(conf-range-fc1/1/1,1/1/2)# no shut
OS10(conf-range-fc1/1/1,1/1/2)# exit
```

### Apply FCoE delay FCF advertisement configuration globally

```
OS10(config)# fcoe delay fcf-adv 15
```

## Example: Manual rebalance trigger

This section describes how to use the manual rebalance CLI command to rebalance the load when the system is in an unbalanced state.

```
OS10#re-balance npg sessions vfabric 100
```

### Fabric Id 100 state before rebalancing

| Uplink Intf | FLOGI | FDISC | Load | Speed (Gbps) | Excess Load |
|-------------|-------|-------|------|--------------|-------------|
| Fc 1/1/1    | 1     | 9     | 10   | 8            | 7           |
| Fc 1/1/2    | 3     | 3     | 6    | 16           | 0           |
|             | 4     | 12    | 16   | 24           | 7           |

Session Re-distributions:

16 Session Re-distribution(s)

| Node WWPN sessions      | From Uplink Intf | To Uplink Intf | No.of |
|-------------------------|------------------|----------------|-------|
| 20:01:d4:ae:52:1a:ee:54 | Fc 1/1/1         | Fc 1/1/2       | 10    |
| 21:01:d4:ae:52:1a:ee:54 | Fc 1/1/2         | Fc 1/1/1       | 2     |
| 22:01:d4:ae:52:1a:ee:54 | Fc 1/1/2         | Fc 1/1/1       | 2     |
| 23:01:d4:ae:52:1a:ee:54 | Fc 1/1/2         | Fc 1/1/1       | 2     |

### Fabric Id 100 expected state after rebalancing

| Uplink Intf | FLOGI | FDISC | Load | Speed (Gbps) | Excess Load |
|-------------|-------|-------|------|--------------|-------------|
| Fc 1/1/1    | 3     | 3     | 6    | 8            | 1           |
| Fc 1/1/2    | 1     | 9     | 10   | 16           | 0           |
|             | 4     | 12    | 16   | 24           | 1           |

You can use manual rebalancing when you:

**Add new FC uplink to a balanced system**

Consider a topology with the following structure:

- NPG switch with two FC uplinks (fc 1/1/1 and fc 1/1/2) of the same speed (16G)
- Ports connecting to both FCoE and FC end points (eth 1/1/54, eth 1/1/55, fc 1/1/9 and fc 1/1/10)

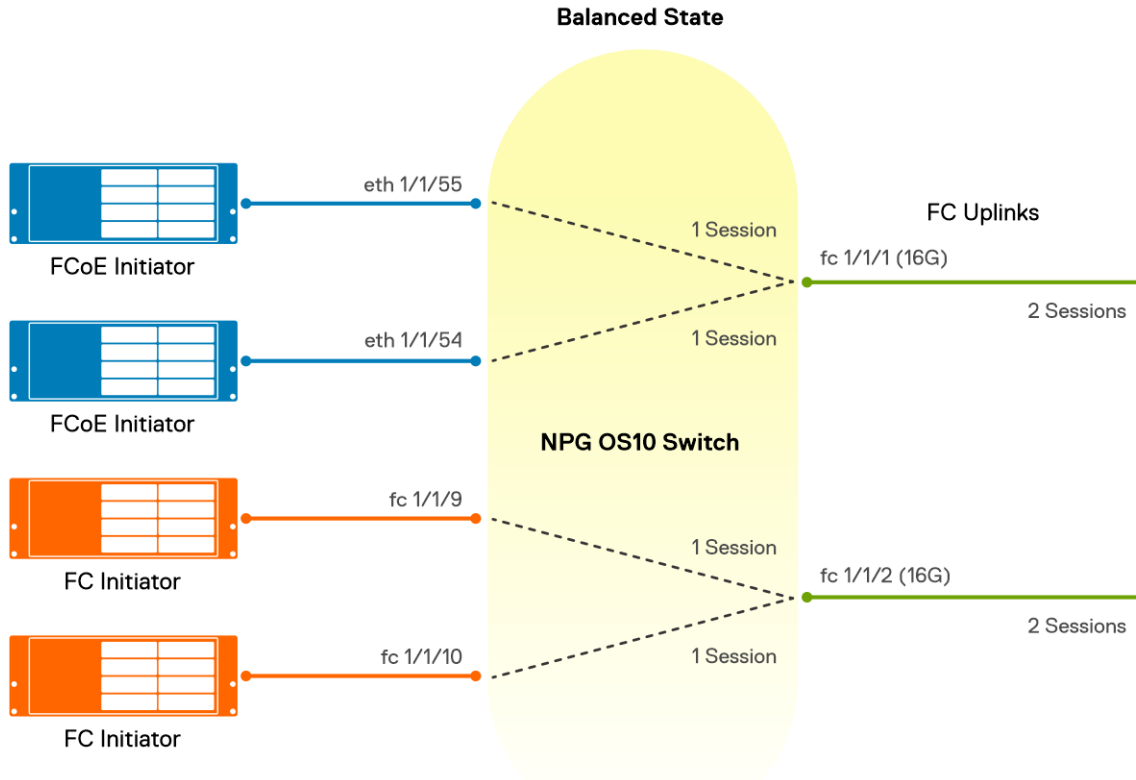

All the end points (servers) are logged in to the storage through the NPG switch. One FLOGI session is associated with each server.

The NPG switch has four sessions that need to be mapped between two FC uplink (fc 1/1/1 and fc 1/1/2).

The NPG switch maps two sessions from eth 1/1/54 and eth 1/1/55 to fc 1/1/1, and two sessions from fc 1/1/9 and 1/1/10 to fc 1/1/2 to maintain a balanced state.

When you add two more FC uplinks, fc 1/1/3 and fc 1/1/4 in the NPG switch, the system becomes unbalanced. Issue a manual rebalance CLI command to move the system back to a balanced state, with each FC uplink (fc 1/1/1, fc 1/1/2, fc 1/1/3 and fc 1/1/4) having one session each.

**Receive session log out (FLOGO or CVL) from the end points**

Consider the NPG switch with:

- two FC uplinks (fc 1/1/1 and fc 1/1/2) of the same speed(16 G)
- four ports (eth 1/1/54, eth 1/1/55, fc 1/1/9 and fc 1/1/10) connecting the FC and FCoE end points

Each end point has one session associated with it. The NPG switch maps two sessions to each FC uplink to balance the system.

Consider both the FC end points sending a session termination request (FLOGO) to the NPG switch. The system closes the sessions in fc 1/1/10, and the system moves to an unbalanced state.

When you bring two more FC uplinks fc 1/1/3 and fc 1/1/4 in the NPG switch, the system becomes unbalanced. Issue a manual rebalance CLI command to move the system back to a balanced state, with each FC uplink (fc 1/1/1, fc 1/1/2, fc 1/1/3 and fc 1/1/4) having one session each.

Now consider both the FC end points sending a session termination request (FLOGO) to the NPG switch. The system closes the sessions in fc 1/1/10, and moves to an unbalanced state.

When you issue the manual rebalance command, the system redistributes the session so that the FC uplinks (fc 1/1/1 and fc 1/1/2) have one session each.



## Receive Fabric Discovery Request (FDISC) from an end point

Consider the NPG switch with:

- two FC uplinks (fc 1/1/1 and fc 1/1/2) of different speed (8 G and 16 G)
- two ports (eth 1/1/54, eth 1/1/55) connecting the FCoE end points

Each end point has one session that is associated with it. The NPG switch maps one session to each FC uplink to balance the system.

Consider the end point connected to eth 1/1/55 establishes four more Fabric Discovery Sessions (FDISC). The FDISC sessions are mapped to the same FC uplink, which has the FLOGI of the end point (fc 1/1/1) and the system moves to an unbalanced state.

When you issue the manual rebalance command, the system redistributes the sessions and the uplink 1/1/1 has one session from one of the end points. The remaining five sessions from the other end points are mapped to fc 1/1/2.

This makes the system better where in the link with the maximum speed holds more sessions than the link with minimum speed.

## Equivalent RESTCONF request for the rebalancing CLIs

The following table lists the equivalent RESTConf request for the rebalancing CLI commands:

**Table 20. RESTConf request**

|                                                                                 | CLI Command                                        | RESTConf Request                                                                                                                                                                                                                                      |
|---------------------------------------------------------------------------------|----------------------------------------------------|-------------------------------------------------------------------------------------------------------------------------------------------------------------------------------------------------------------------------------------------------------|
| REST-TRANSLATE-OS10#<br>re-balance npg<br>sessions vfabric 2                    | re-balance npg sessions vfabric 2                  | curl -i -k -H "Accept: application/json" -H "Content-Type: application/json" -u \$USER_NAME:\$PASSWORD -d '{"input":{"vfabric-id":2,"command-type":"ACTUAL_REBALANCE"}}' -X POST https://\$MGMT_IP/restconf/operations/dell-fc-services:npg-rebalance |
| REST-TRANSLATE-OS10#<br>re-balance npg<br>sessions vfabric 2<br>dry-run         | re-balance npg sessions vfabric 2<br>dry-run       | curl -i -k -H "Accept: application/json" -H "Content-Type: application/json" -u \$USER_NAME:\$PASSWORD -d '{"input":{"vfabric-id":2,"command-type":"DRY_RUN"}}' -X POST https://\$MGMT_IP/restconf/operations/dell-fc-services:npg-rebalance          |
| REST-TRANSLATE-OS10#<br>re-balance npg<br>sessions vfabric 2<br>dry-run brief   | re-balance npg sessions vfabric 2<br>dry-run brief | curl -i -k -H "Accept: application/json" -H "Content-Type: application/json" -u \$USER_NAME:\$PASSWORD -d '{"input":{"vfabric-id":2,"command-type":"DRY_RUN_BRIEF"}}' -X POST https://\$MGMT_IP/restconf/operations/dell-fc-services:npg-rebalance    |
| REST-TRANSLATE-OS10#<br>show npg re-balance-<br>statistics uplink-<br>interface | show npg re-balance-statistics<br>uplink-interface | curl -i -k -H "Accept: application/json" -u \$USER_NAME:\$PASSWORD -X GET https://\$MGMT_IP/restconf/data/dell-fc-services:npg-re-balance/uplink-intf-stats                                                                                           |
| REST-TRANSLATE-OS10#<br>show npg re-balance-<br>statistics node-<br>interface   | show npg re-balance-statistics<br>node-interface   | curl -i -k -H "Accept: application/json" -u \$USER_NAME:\$PASSWORD -X GET https://\$MGMT_IP/restconf/data/dell-fc-services:npg-re-balance/node-intf-stats                                                                                             |

## F\_Port commands

The following commands are supported on F\_Port mode:

## fc alias

Creates an FC alias. After creating the alias, add members to the FC alias. An FC alias can have a maximum of 255 unique members.

|                          |                                                                                                                                                                                                                                                                                      |
|--------------------------|--------------------------------------------------------------------------------------------------------------------------------------------------------------------------------------------------------------------------------------------------------------------------------------|
| <b>Syntax</b>            | <code>fc alias alias-name</code>                                                                                                                                                                                                                                                     |
| <b>Parameters</b>        | <code>alias-name</code> — Enter a name for the FC alias.                                                                                                                                                                                                                             |
| <b>Defaults</b>          | Not configured                                                                                                                                                                                                                                                                       |
| <b>Command Mode</b>      | CONFIGURATION                                                                                                                                                                                                                                                                        |
| <b>Usage Information</b> | The <code>no</code> version of this command deletes the FC alias. To delete an FC alias, first remove it from the FC zone.<br><br>Supported on the MX9116n switch in Full Switch mode starting in release 10.4.1.0. Also supported in SmartFabric mode starting in release 10.5.0.1. |

### Example

```
OS10(config)# fc alias test
OS10(config-fc-alias-test)# member wwn 21:00:00:24:ff:7b:f5:c9
OS10(config-fc-alias-test)# member wwn 20:25:78:2b:cb:6f:65:57
```

|                           |                  |
|---------------------------|------------------|
| <b>Supported Releases</b> | 10.3.1E or later |
|---------------------------|------------------|

## fc zone

Creates an FC zone and adds members to the zone. An FC zone can have a maximum of 255 unique members.

|                          |                                                                                                                                                                                                                                                                                       |
|--------------------------|---------------------------------------------------------------------------------------------------------------------------------------------------------------------------------------------------------------------------------------------------------------------------------------|
| <b>Syntax</b>            | <code>fc zone zone-name</code>                                                                                                                                                                                                                                                        |
| <b>Parameters</b>        | <code>zone-name</code> — Enter a name for the zone.                                                                                                                                                                                                                                   |
| <b>Defaults</b>          | Not configured                                                                                                                                                                                                                                                                        |
| <b>Command Mode</b>      | CONFIGURATION                                                                                                                                                                                                                                                                         |
| <b>Usage Information</b> | The <code>no</code> version of this command deletes the FC zone. To delete an FC zone, first remove it from the FC zoneset.<br><br>Supported on the MX9116n switch in Full Switch mode starting in release 10.4.1.0. Also supported in SmartFabric mode starting in release 10.5.0.1. |

### Example

```
OS10(config)# fc zone hba1
OS10(config-fc-zone-hba1)# member wwn 10:00:00:90:fa:b8:22:19
OS10(config-fc-zone-hba1)# member wwn 21:00:00:24:ff:7b:f5:c8
```

|                           |                  |
|---------------------------|------------------|
| <b>Supported Releases</b> | 10.3.1E or later |
|---------------------------|------------------|

## fc zoneset

Creates an FC zoneset and adds the existing FC zones to the zoneset.

|                     |                                                                                                                                                             |
|---------------------|-------------------------------------------------------------------------------------------------------------------------------------------------------------|
| <b>Syntax</b>       | <code>fc zoneset zoneset-name</code>                                                                                                                        |
| <b>Parameters</b>   | <code>zoneset-name</code> — Enter a name for the FC zoneset. The name must start with a letter and may contain these characters: A-Z, a-z, 0-9, \$, _, -, ^ |
| <b>Defaults</b>     | Not configured                                                                                                                                              |
| <b>Command Mode</b> | CONFIGURATION                                                                                                                                               |

|                           |                                                                                                                                                                                                                           |
|---------------------------|---------------------------------------------------------------------------------------------------------------------------------------------------------------------------------------------------------------------------|
| <b>Usage Information</b>  | The <code>no</code> version of this command removes the FC zoneset.<br>Supported on the MX9116n switch in Full Switch mode starting in release 10.4.1.0. Also supported in SmartFabric mode starting in release 10.5.0.1. |
| <b>Example</b>            | <pre>OS10(config)# fc zoneset set OS10(config-fc-zoneset-set)# member hba1</pre>                                                                                                                                          |
| <b>Supported Releases</b> | 10.3.1E or later                                                                                                                                                                                                          |

## feature fc

Enables the F\_Port globally.

|                           |                                                                                                                                                                                                                                                                                                                |
|---------------------------|----------------------------------------------------------------------------------------------------------------------------------------------------------------------------------------------------------------------------------------------------------------------------------------------------------------|
| <b>Syntax</b>             | <code>feature fc domain-id domain-id</code>                                                                                                                                                                                                                                                                    |
| <b>Parameters</b>         | <code>domain-id</code> — Enter the domain ID of the F_Port, from 1 to 239.                                                                                                                                                                                                                                     |
| <b>Defaults</b>           | Disabled                                                                                                                                                                                                                                                                                                       |
| <b>Command Mode</b>       | CONFIGURATION                                                                                                                                                                                                                                                                                                  |
| <b>Usage Information</b>  | The <code>no</code> version of this command disables the F_Port. You can disable the F_Port only when vfabric and zoning configurations are not available. Before disabling the F_Port, remove the vfabric and zoning configurations. You can enable only one of the following at a time: F_Port, NPG, or FSB. |
| <b>Example</b>            | <pre>OS10(config)# feature fc domain-id 100</pre>                                                                                                                                                                                                                                                              |
| <b>Supported Releases</b> | 10.3.1E or later                                                                                                                                                                                                                                                                                               |

## member (alias)

Add members to existing FC aliases. Identify a member by an FC alias, a world wide name (WWN), or an FC ID.

|                           |                                                                                                                                                                                                                                            |
|---------------------------|--------------------------------------------------------------------------------------------------------------------------------------------------------------------------------------------------------------------------------------------|
| <b>Syntax</b>             | <code>member {wwn wwn-ID   fc-id fc-id}</code>                                                                                                                                                                                             |
| <b>Parameters</b>         | <ul style="list-style-type: none"> <li>• <code>wwn-ID</code> — Enter the WWN name.</li> <li>• <code>fc-id</code> — Enter the FC ID name.</li> </ul>                                                                                        |
| <b>Defaults</b>           | Not configured                                                                                                                                                                                                                             |
| <b>Command Mode</b>       | Alias CONFIGURATION                                                                                                                                                                                                                        |
| <b>Usage Information</b>  | Supported on the MX9116n switch in Full Switch mode starting in release 10.4.0E(R3S). Also supported in SmartFabric mode starting in release 10.5.0.1<br>The <code>no</code> version of this command removes the member from the FC alias. |
| <b>Example</b>            | <pre>OS10(config)# fc alias test OS10(config-fc-alias-test)# member wwn 21:00:00:24:ff:7b:f5:c9 OS10(config-fc-alias-test)# member wwn 20:25:78:2b:cb:6f:65:57</pre>                                                                       |
| <b>Supported Releases</b> | 10.3.1E or later                                                                                                                                                                                                                           |

## member (zone)

Adds members to existing zones. Identify a member by an FC alias, a world wide name (WWN), or an FC ID.

**Syntax** `member {alias-name alias-name | wwn wwn-ID | fc-id fc-id}`

- Parameters**
- *alias-name* — Enter the FC alias name.
  - *wwn-ID* — Enter the WWN name.
  - *fc-id* — Enter the FC ID name.

**Defaults** Not configured

**Command Mode** Zone CONFIGURATION

**Usage Information** Supported on the MX9116n switch in Full Switch mode starting in release 10.4.0E(R3S). Also supported in SmartFabric mode starting in release 10.5.0.1

The `no` version of this command removes the member from the zone.

### Example

```
OS10(config)# fc zone hba1
OS10(config-fc-zone-hba1)# member wwn 10:00:00:90:fa:b8:22:19
OS10(config-fc-zone-hba1)# member wwn 21:00:00:24:ff:7b:f5:c8
```

**Supported Releases** 10.3.1E or later

## member (zoneset)

Adds zones to an existing zoneset.

**Syntax** `member zone-name`

**Parameters** *zone-name* — Enter an existing zone name.

**Defaults** Not configured

**Command Mode** Zoneset CONFIGURATION

**Usage Information** Supported on the MX9116n switch in Full Switch mode starting in release 10.4.0E(R3S). Also supported in SmartFabric mode starting in release 10.5.0.1

The `no` version of this command removes the zone from the zoneset.

### Example

```
OS10(config)# fc zoneset set
OS10(conf-fc-zoneset-set)# member hba1
```

**Supported Releases** 10.3.1E or later

## show fc alias

Displays the details of a FC alias and its members.

**Syntax** `show fc alias [alias-name]`

**Parameters** *alias-name* — (Optional) Enter the FC alias name.

**Default** Not configured

**Command Mode** EXEC

**Usage Information** Supported on the MX9116n switch in Full Switch mode starting in release 10.4.0E(R3S). Also supported in SmartFabric mode starting in release 10.5.0.1

## Example

```
OS10# show fc alias

Alias Name Alias Member
=====
test 21:00:00:24:ff:7b:f5:c9
 20:25:78:2b:cb:6f:65:57

OS10#
```

**Supported Releases** 10.3.1E or later

## show fc interface-area-id mapping

Displays the FC ID to interface mapping details.

**Syntax** show fc interface-area-id mapping

**Parameters** None

**Default** Not configured

**Command Mode** EXEC

**Usage Information** None

## Example

```
OS10# show fc interface-area-id mapping
Intf Name FC-ID Status
=====
ethernet1/1/40 0a:02:00 Active
```

**Supported Releases** 10.4.1.0 or later

## show fc ns switch

Displays the details of the FC NS switch parameters.

**Syntax** show fc ns switch [brief]

**Parameters** None

**Default** Not configured

**Command Mode** EXEC

**Usage Information** None

## Example

```
OS10# show fc ns switch

Total number of devices = 1
Switch Name 10:00:14:18:77:13:38:28
Domain Id 4
Switch Port port-channel10(Eth 1/1/9)
FC-Id 04:00:00
Port Name 50:00:d3:10:00:ec:f9:05
Node Name 50:00:d3:10:00:ec:f9:00
Class of Service 8
Symbolic Port Name Compellent Port QLGC FC 8Gbps; Slot=06
Port=01 in Controller: SN 60665 of Storage Center: DEVTEST 60665
Symbolic Node Name Compellent Storage Center: DEVTEST 60665
Port Type N_PORT
```

```
Registered with NameServer Yes
Registered for SCN No
```

### Example (brief)

```
OS10# show fc ns switch brief
Total number of devices = 1
Intf# Domain FC-ID Enode-WWPN
Enode-WWNN
port-channel10(Eth 1/1/9) 4 04:00:00 10:00:00:90:fa:b8:22:18
20:00:00:90:fa:b8:22:18
```

**Supported Releases** 10.3.1E or later

## show fc zone

Displays the FC zones and the zone members.

**Syntax** `show fc zone [zone-name]`  
**Parameters** `zone-name` — Enter the FC zone name.  
**Default** Not configured  
**Command Mode** EXEC  
**Usage Information** None

### Example

```
OS10# show fc zone

Zone Name Zone Member
=====
hba1 21:00:00:24:ff:7b:f5:c8
10:00:00:90:fa:b8:22:19
21:00:00:24:ff:7f:ce:ee
21:00:00:24:ff:7f:ce:ef
hba2 20:01:00:0e:1e:e8:e4:99
50:00:d3:10:00:ec:f9:1b
50:00:d3:10:00:ec:f9:05
50:00:d3:10:00:ec:f9:1f
20:35:78:2b:cb:6f:65:57
```

### Example (with zone name)

```
OS10# show fc zone hba1

Zone Name Zone Member
=====
hba1 21:00:00:24:ff:7b:f5:c8
10:00:00:90:fa:b8:22:19
21:00:00:24:ff:7f:ce:ee
21:00:00:24:ff:7f:ce:ef
```

**Supported Releases** 10.3.1E or later

## show fc zoneset

Displays the FC zonesets, the zones in the zoneset, and the zone members.

**Syntax** `show fc zoneset [active | zoneset-name]`  
**Parameters** `zoneset-name` — Enter the FC zoneset name.  
**Default** Not configured

**Command Mode** EXEC

**Usage Information** None

**Example**

```
OS10# show fc zoneset
ZoneSetName ZoneName ZoneMember
=====
set hba1 21:00:00:24:ff:7b:f5:c8
 10:00:00:90:fa:b8:22:19
 21:00:00:24:ff:7f:ce:ee
 21:00:00:24:ff:7f:ce:ef

 hba2 20:01:00:0e:1e:e8:e4:99
 50:00:d3:10:00:ec:f9:1b
 50:00:d3:10:00:ec:f9:05
 50:00:d3:10:00:ec:f9:1f
 20:35:78:2b:cb:6f:65:57

vFabric id: 100
Active Zoneset: set
ZoneName ZoneMember
=====
hba2 20:01:00:0e:1e:e8:e4:99
 20:35:78:2b:cb:6f:65:57
 50:00:d3:10:00:ec:f9:05
 50:00:d3:10:00:ec:f9:1b
 50:00:d3:10:00:ec:f9:1f

hba1 *10:00:00:90:fa:b8:22:19
 *21:00:00:24:ff:7b:f5:c8
 21:00:00:24:ff:7f:ce:ee
 21:00:00:24:ff:7f:ce:ef
```

**Example (active zoneset)**

```
OS10# show fc zoneset active

vFabric id: 100
Active Zoneset: set
ZoneName ZoneMember
=====
hba2 20:01:00:0e:1e:e8:e4:99
 20:35:78:2b:cb:6f:65:57
 50:00:d3:10:00:ec:f9:05
 50:00:d3:10:00:ec:f9:1b
 50:00:d3:10:00:ec:f9:1f

hba1 *10:00:00:90:fa:b8:22:19
 *21:00:00:24:ff:7b:f5:c8
 21:00:00:24:ff:7f:ce:ee
 21:00:00:24:ff:7f:ce:ef
```

**Example (with zoneset name)**

```
OS10# show fc zoneset set
ZoneSetName ZoneName ZoneMember
=====
set hba1 21:00:00:24:ff:7b:f5:c8
 10:00:00:90:fa:b8:22:19
 21:00:00:24:ff:7f:ce:ee
 21:00:00:24:ff:7f:ce:ef

 hba2 20:01:00:0e:1e:e8:e4:99
 50:00:d3:10:00:ec:f9:1b
 50:00:d3:10:00:ec:f9:05
 50:00:d3:10:00:ec:f9:1f
 20:35:78:2b:cb:6f:65:57
```

**Supported Releases** 10.3.1E or later

## zone default-zone permit

Enables access between all logged-in FC nodes of the vfabric in the absence of an active zoneset configuration.

|                           |                                                                                                                                                                                                                                      |
|---------------------------|--------------------------------------------------------------------------------------------------------------------------------------------------------------------------------------------------------------------------------------|
| <b>Syntax</b>             | <code>zone default-zone permit</code>                                                                                                                                                                                                |
| <b>Parameters</b>         | None                                                                                                                                                                                                                                 |
| <b>Defaults</b>           | Not configured                                                                                                                                                                                                                       |
| <b>Command Mode</b>       | Vfabric CONFIGURATION                                                                                                                                                                                                                |
| <b>Usage Information</b>  | A default zone advertises a maximum of 255 members in the registered state change notification (RSCN) message. The <code>no</code> version of this command disables access between the FC nodes in the absence of an active zoneset. |
| <b>Example</b>            | <pre>OS10(config)# vfabric 100 OS10(conf-vfabric-100)# zone default-zone permit</pre>                                                                                                                                                |
| <b>Supported Releases</b> | 10.3.1E or later                                                                                                                                                                                                                     |

## zoneset activate

Activates an existing zoneset. You can activate only one zoneset in a vfabric.

|                           |                                                                                                                                                                                                                                                                                                                                                                                                                                                                            |
|---------------------------|----------------------------------------------------------------------------------------------------------------------------------------------------------------------------------------------------------------------------------------------------------------------------------------------------------------------------------------------------------------------------------------------------------------------------------------------------------------------------|
| <b>Syntax</b>             | <code>zoneset activate zoneset-name</code>                                                                                                                                                                                                                                                                                                                                                                                                                                 |
| <b>Parameters</b>         | <code>zoneset-name</code> — Enter an existing zoneset name.                                                                                                                                                                                                                                                                                                                                                                                                                |
| <b>Defaults</b>           | Not configured                                                                                                                                                                                                                                                                                                                                                                                                                                                             |
| <b>Command Mode</b>       | vfabric CONFIGURATION                                                                                                                                                                                                                                                                                                                                                                                                                                                      |
| <b>Usage Information</b>  | After you disable an active zoneset, the <code>zone default-zone permit</code> command configuration takes effect. Based on this configuration, the default zone allows or denies access between all the logged-in FC nodes of the vfabric. The <code>no</code> version of this command deactivates the zoneset.<br><br>Supported on the MX9116n switch in Full Switch mode starting in release 10.4.1.0. Also supported in SmartFabric mode starting in release 10.5.0.1. |
| <b>Example</b>            | <pre>OS10(config)# vfabric 100 OS10(conf-vfabric-100)# zoneset activate set</pre>                                                                                                                                                                                                                                                                                                                                                                                          |
| <b>Supported Releases</b> | 10.3.1E or later                                                                                                                                                                                                                                                                                                                                                                                                                                                           |

## NPG commands

The following commands are supported on NPG mode:

### fc port-mode F

Configures port mode on Fibre Channel interfaces.

|                     |                             |
|---------------------|-----------------------------|
| <b>Syntax</b>       | <code>fc port-mode F</code> |
| <b>Parameters</b>   | None                        |
| <b>Defaults</b>     | N_Port                      |
| <b>Command Mode</b> | Fibre Channel INTERFACE     |



**Usage Information** Configure the port mode when the port is in Shut mode and when NPG mode is enabled. The `no` version of this command returns the port mode to default.

**Example**

```
OS10(config)# interface fibrechannel 1/1/1
OS10(conf-if-fc1/1/1)# fc port-mode F
```

**Supported Releases** 10.4.1.0 or later

## feature fc npg

Enables the NPG mode globally.

**Syntax** `feature fc npg`

**Parameters** None

**Defaults** Disabled

**Command Mode** CONFIGURATION

**Usage Information** You can enable only one of the following at a time: F\_Port, NPG, or FSB. The `no` version of this command disables NPG mode.

**Example**

```
OS10(config)# feature fc npg
```

**Supported Releases** 10.4.0E(R1) or later

## show npg devices

Displays the NPG devices connected to the switch.

**Syntax** `show npg devices [brief]`

**Parameters** None

**Default** Not configured

**Command Mode** EXEC

**Usage Information** Use the `brief` option to display minimum details.

**Example**

```
OS10# show npg devices
ENode[0]:
ENode MAC :d4:ae:52:1a:ee:54
ENode Interface: port-channel10(Eth 1/1/9)
FCF MAC :14:18:77:20:7c:e3
Fabric Interface :Fc 1/1/25
FCoE Vlan :1001
Vfabric Id :10
ENode WWPN :20:01:d4:ae:52:1a:ee:54
ENode WWNN :20:00:d4:ae:52:1a:ee:54
FCoE MAC :0e:fc:00:01:04:02
FC-ID :01:04:02
Login Method :FLOGI
Time since discovered(in Secs) :6253
Status :LOGGED_IN
```

**Example (brief)**

```
Total NPG Devices = 1
ENode-Interface ENode-WWPN FCoE-Vlan Fabric-Intf Vfabric-Id Log

```

```
Po 10 (Eth 1/1/9) 20:01:d4:ae:52:1a:ee:54 1001 Fc 1/1/25 10 FLO
LOGGED_IN
```

**Supported Releases** 10.4.0E(R1) or later

## show npg uplink-interface

Display information in a FC upstream interface.

**Syntax** `show npg uplink-interfaces [vfabric vfabric-id [fcf-info] | [fcf-info]]`

**Parameters**

- `fcf-info` - FCF Availability Status, fabric name of the FC upstream switch connected, error reason, FCF advertisement delay timeout left and duplicate FC id assignment counter.

**Default** Not configured

**Command Mode** EXEC

**Usage Information** Displays the details of FC upstream interfaces in all the available or specified vFabrics along with the FC Id and BB Credit.

This command is supported in NPG mode.

The fields and the corresponding descriptions are described as follows:

- **Uplink Intf**—The name of the FC uplink interface.
- **FCF Availability Status**—Status of the logical FCF of that fabric, whether it is available to establish session or not. This field takes values as Yes or No.
- **FAD timeout left**—Number of seconds left for the FCF Advertisement Delay timer to expire.
- **Upstream fabric name**—Fabric name of the upstream FC switch/Multi-switch to which this interface is connected.
- **Error reason**—Reason for error in the FC uplink interface. Following are few possible error reasons:
  1. FC Port Down
  2. No Response For FLOGI
  3. Duplicate FC ID
  4. FLOGI Rejected
  5. Vfabric Inactive
- **Duplicate FC IDs**—Number of Duplicate address(FC ID) assignments happened in the interface.
- **FC ID**—FC-ID allocated to the initial FLOGI request from NPG switch on the interface.
- **BB Credit**—Transmit Buffer to Buffer Credit.
- **Speed**—Link speed of the FC uplink interface.
- **FLOGI**—Number of Fabric Login Sessions in the FC uplink interface.
- **FDISC**—Number of Fabric Discovery Session in the FC uplink interface.
- **Total**—Total number of sessions (FLOGI and FDISC) in the FC uplink interface.
- **Re-distributed**—Number of sessions redistributed for better load balancing in the interface.

### Example

```
OS10#show npg uplink-interfaces vfabric 100

VFabric Id : 100
Uplink
Intf FC Id BB Credit Speed
 (Gbps) FLOGI FDISC Total Re-distributed

Fc 1/1/1 01:00:01 2 8 3 3 6 6
Fc 1/1/2 01:00:02 4 16 1 9 10 15
```

```
OS10#show npg uplink-interfaces

VFabric Id : 100
Uplink
Intf FC Id BB Credit Speed
 (Gbps) FLOGI FDISC Total Re-
distributed
```

```

Fc 1/1/1 01:00:01 2 8 3 3 6 6
Fc 1/1/2 01:00:02 4 16 1 9 10 15

VFabric Id : 200
Uplink
Intf FC Id BB Credit Speed
distributed (Gbps) FLOGI FDISC Total Re-

Fc 1/1/11 01:00:0B 2 8 3 3 6 10
Fc 1/1/12 01:00:0C 4 16 1 0 1 1

VFabric Id : 300
Uplink
Intf FC Id BB Credit Speed
distributed (Gbps) FLOGI FDISC Total Re-

Fc 1/1/13 01:00:03 2 8 3 3 6 0
Fc 1/1/14 01:00:04 4 16 1 6 7 5

```

```

OS10#show npg uplink-interfaces fcf-info
VFabric Id : 200
FAD Timeout Left : 10 second(s)
FCF Availability Status : No

Uplink
Intf Upstream Fabric-Name Error Reason Duplicate

Fc 1/1/11 10:01:d4:ae:52:1a:ee:50 FLOGI_REJECTED 1
Fc 1/1/12 10:01:d4:ae:52:2b:ff:52 NONE 0

VFabric Id : 300
FAD Timeout Left : 0 second(s)
FCF Availability Status : Yes

Uplink
Intf Upstream Fabric-Name Error Reason Duplicate

Fc 1/1/13 20:01:d4:ae:52:1a:ee:53 NONE 1
Fc 1/1/14 20:01:d4:ae:52:7d:aa:54 NONE 0

OS10#show npg uplink-interfaces vfabric 200 fcf-info
VFabric Id : 200
FAD Timeout Left : 10 second(s)
FCF Availability Status : No

Uplink
Intf Upstream Fabric-Name Error Reason Duplicate

Fc 1/1/11 10:01:d4:ae:52:1a:ee:50 FLOGI_REJECTED 1
Fc 1/1/12 10:01:d4:ae:52:2b:ff:52 NONE 0

```

**Supported Releases** 10.5.1.0 or later

## F\_Port and NPG commands

The following commands are supported on both F\_Port and NPG modes:

## clear fc statistics

Clears FC statistics for specified vfabric or fibre channel interface.

**Syntax** `clear fc statistics [vfabric vfabric-ID | interface fibrechannel]`

- Parameters**
- *vfabric-ID* — Enter the vfabric ID.
  - *fibrechannel* — Enter the fibre channel interface name.

**Default** Not configured

**Command Mode** EXEC

**Usage Information** None

**Example**

```
OS10# clear fc statistics vfabric 100
OS10# clear fc statistics interface fibrechannel1/1/25
```

**Supported Releases** 10.4.1.0 or later

## fcoe

Adds FCoE parameters to the vfabric.

**Syntax** `fcoe {fcmmap fc-map | fcf-priority fcf-priority-value | fka-adv-period adv-period | vlan-priority vlan-priority-value | keep-alive}`

- Parameters**
- *fc-map* — Enter the FC map ID, from 0xefc00 to 0xefcff.
  - *fcf-priority-value* — Enter the FCF priority value, from 1 to 255.
  - *adv-period* — Enter the FCF keepalive advertisement period, from 8 to 90 seconds.
  - *vlan-priority-value* — Enter the VLAN priority value, from 0 to 7.

- Defaults**
- *fcmmap*—0x0EFC00
  - *fcf-priority*—128
  - *fka-adv-period*—8
  - *vlan-priority*—3
  - *keep-alive*—True

**Command Mode** Vfabric CONFIGURATION

**Usage Information** The no version of this command disables the FCoE parameters.

**Example**

```
OS10(config)# vfabric 10
OS10(conf-vfabric-10)# name 10
OS10(conf-vfabric-10)# fcoe fcmmap 0x0efc01
OS10(conf-vfabric-10)# fcoe fcf-priority 128
OS10(conf-vfabric-10)# fcoe fka-adv-period 8
OS10(conf-vfabric-10)# fcoe vlan-priority 3
```

**Supported Releases** 10.3.1E or later

## fcoe delay fcf-adv

Delay the Multicast Discovery Advertisement from FCFs to be sent to Enodes.

**Syntax** `fcoe delay fcf-adv timeout`

|                           |                                                                                                                                                                                    |
|---------------------------|------------------------------------------------------------------------------------------------------------------------------------------------------------------------------------|
| <b>Parameters</b>         | timeout - Timeout range specified in seconds. Range is 1 to 30 seconds.                                                                                                            |
| <b>Default</b>            | Not configured                                                                                                                                                                     |
| <b>Command Mode</b>       | Global config                                                                                                                                                                      |
| <b>Usage Information</b>  | Time to wait after the last FCF connects to the NPG switch to send the Multicast discovery Advertisement. This command is supported in NPG mode.                                   |
| <b>Example</b>            | <pre>OS10(config)# fcoe delay fcf-adv 16</pre>                                                                                                                                     |
| <b>Supported Releases</b> | 10.4.0E(R1) or later In previous releases, the command is not available in full switch mode. From this release, the command is available both in full switch mode and fabric mode. |

## name

Configures a vfabric name.

|                           |                                                                             |
|---------------------------|-----------------------------------------------------------------------------|
| <b>Syntax</b>             | <code>name vfabric-name</code>                                              |
| <b>Parameters</b>         | <code>vfabric-name</code> — Enter a name for the vfabric.                   |
| <b>Defaults</b>           | Not configured                                                              |
| <b>Command Mode</b>       | Vfabric CONFIGURATION                                                       |
| <b>Usage Information</b>  | The <code>no</code> version of this command removes the vfabric name..      |
| <b>Example</b>            | <pre>OS10(config)# vfabric 100 OS10(conf-vfabric-100)# name test_vfab</pre> |
| <b>Supported Releases</b> | 10.3.1E or later                                                            |

## Re-balance the FC sessions

Re-balances the FC sessions across FC uplinks.

|                          |                                                                                                                                                                                                                                                                                                                                                                                                                                                                                                                                                                                                                                                                                                                                                                                                                                      |
|--------------------------|--------------------------------------------------------------------------------------------------------------------------------------------------------------------------------------------------------------------------------------------------------------------------------------------------------------------------------------------------------------------------------------------------------------------------------------------------------------------------------------------------------------------------------------------------------------------------------------------------------------------------------------------------------------------------------------------------------------------------------------------------------------------------------------------------------------------------------------|
| <b>Syntax</b>            | <code>re-balance fc npg sessions vfabric vfabric-id [dry-run][brief]</code>                                                                                                                                                                                                                                                                                                                                                                                                                                                                                                                                                                                                                                                                                                                                                          |
| <b>Parameters</b>        | None                                                                                                                                                                                                                                                                                                                                                                                                                                                                                                                                                                                                                                                                                                                                                                                                                                 |
| <b>Default</b>           | Not configured                                                                                                                                                                                                                                                                                                                                                                                                                                                                                                                                                                                                                                                                                                                                                                                                                       |
| <b>Command Mode</b>      | EXEC                                                                                                                                                                                                                                                                                                                                                                                                                                                                                                                                                                                                                                                                                                                                                                                                                                 |
| <b>Usage Information</b> | <p>Triggers the load-balancing mechanism to redistribute the sessions across the FC uplinks.</p> <p>The <code>dry-run</code> option displays the current state of the system, sessions that are cleared, and the system state after balancing is done without actually doing it. You can use the <code>brief</code> option (both in dry run and actual run) to view or session redistribution information.</p> <p>You can configure <code>fcoe delay fcf-adv</code> timer that is based on the switch configuration to balance the system d reload. Even if the system is unbalanced after reload, you can use this command in the switch to balance the session the uplinks.</p> <p>This command is supported in the NPG mode.</p> <p>The following table lists the fields and descriptions that are displayed in this command:</p> |

**Table 21. Fields and Descriptions**

| Fields      | Description                         |
|-------------|-------------------------------------|
| Uplink Intf | The name of the FC uplink interface |

**Table 21. Fields and Descriptions (continued)**

| Fields           | Description                                                                                                                                                                                                                                      |
|------------------|--------------------------------------------------------------------------------------------------------------------------------------------------------------------------------------------------------------------------------------------------|
| FLOGI            | Number of Fabric Login Sessions in the FC uplink interface                                                                                                                                                                                       |
| FDISC            | Number of Fabric Discovery Sessions in the FC uplink interface                                                                                                                                                                                   |
| Load             | Total number of sessions (FLOGI and FDISC) in the FC uplink interface                                                                                                                                                                            |
| Speed            | Link speed of the FC uplink interface                                                                                                                                                                                                            |
| Excess Load      | Excess load is the absolute (Current load on the link - ((Minimum load per 8G speed in state) * port-speed/8G)). It captures the level to which the corresponding link is oversubscribed when compared to other FC upstream links in the system. |
| Node WWPN        | World-Wide Port Name is used for the Fabric Login Request of the Server that is connected to the OS10 switch. It can be an FCoE server or an FC server.                                                                                          |
| From Uplink Intf | Interface name of the FC uplink from which the sessions from the server are redistributed                                                                                                                                                        |
| To Uplink Intf   | Interface name of the FC uplink to which the sessions are mapped when the server logs in                                                                                                                                                         |
| No. of sessions  | Count of redistributed sessions.                                                                                                                                                                                                                 |

**Example**

```
OS10#re-balance npg sessions vfabric 100 dry-run

Fabric Id 100 Current State
Uplink FLOGI FDISC Load Speed Excess
Intf (Gbps) Load

Fc 1/1/1 1 9 10 8 7
Fc 1/1/2 3 3 6 16 0

 4 12 16 24 7

Session Displacements:

Total No. of Node(s) : 4
No. of Node(s) displaced : 4

Node WWPN From Uplink Intf To Uplink Intf No.of ses

20:01:d4:ae:52:1a:ee:54 Fc 1/1/1 Fc 1/1/2 10
21:01:d4:ae:52:1a:ee:54 Fc 1/1/2 Fc 1/1/1 2
22:01:d4:ae:52:1a:ee:54 Fc 1/1/2 Fc 1/1/1 2
23:01:d4:ae:52:1a:ee:54 Fc 1/1/2 Fc 1/1/1 2

Fabric Id 100 State after Re-balancing
Uplink FLOGI FDISC Load Speed Excess
Intf (Gbps) Load

Fc 1/1/1 3 3 6 8 1
Fc 1/1/2 1 9 10 16 0

 4 12 16 24 1

```

```
OS10#re-balance npg sessions vfabric 100 dry-run brief

Fabric Id 100 Session Displacements:

Total No. of Node(s) : 4
No. of Node(s) displaced : 4

Node WWPN From Uplink Intf To Uplink Intf No.of ses

20:01:d4:ae:52:1a:ee:54 Fc 1/1/1 Fc 1/1/2 10
```

```

21:01:d4:ae:52:1a:ee:54 Fc 1/1/2 Fc 1/1/1 2
22:01:d4:ae:52:1a:ee:54 Fc 1/1/2 Fc 1/1/1 2
23:01:d4:ae:52:1a:ee:54 Fc 1/1/2 Fc 1/1/1 2

```

```
OS10#re-balance npg sessions vfabric 100
```

```

Fabric Id 100 State before Re-balancing
Uplink FLOGI FDISC Load Speed Excess
Intf (Gbps) Load

Fc 1/1/1 1 9 10 8 7
Fc 1/1/2 3 3 6 16 0

 4 12 16 24 7

```

```
Session Displacements:
```

```
Total No. of Node(s) : 4
No. of Node(s) displaced : 4
```

```

Node WWPN From Uplink Intf To Uplink Intf No.of sessi

20:01:d4:ae:52:1a:ee:54 Fc 1/1/1 Fc 1/1/2 10
21:01:d4:ae:52:1a:ee:54 Fc 1/1/2 Fc 1/1/1 2
22:01:d4:ae:52:1a:ee:54 Fc 1/1/2 Fc 1/1/1 2
23:01:d4:ae:52:1a:ee:54 Fc 1/1/2 Fc 1/1/1 2

```

```

Fabric Id 100 Expected State after Re-balancing
Uplink FLOGI FDISC Load Speed Excess
Intf (Gbps) Load

Fc 1/1/1 3 3 6 8 1
Fc 1/1/2 1 9 10 16 0

 4 12 16 24 1

```

### Supported Releases

10.4.0E(R1) or later

## show npg uplink-interface

Display information in a FC upstream interface.

**Syntax** `show npg uplink-interfaces [vfabric vfabric-id [fcf-info] | [fcf-info]]`

**Parameters**

- `fcf-info` - FCF Availability Status, fabric name of the FC upstream switch connected, error reason, FCF advertisement delay timeout left and duplicate FC id assignment counter.

**Default** Not configured

**Command Mode** EXEC

**Usage Information** Displays the details of FC upstream interfaces in all the available or specified vFabrics along with the FC Id and BB Credit.

This command is supported in NPG mode.

The fields and the corresponding descriptions are described as follows:

- **Uplink Intf**—The name of the FC uplink interface.
- **FCF Availability Status**—Status of the logical FCF of that fabric, whether it is available to establish session or not. This field takes values as Yes or No.
- **FAD timeout left**—Number of seconds left for the FCF Advertisement Delay timer to expire.
- **Upstream fabric name**—Fabric name of the upstream FC switch/Multi-switch to which this interface is connected.

- **Error reason**—Reason for error in the FC uplink interface. Following are few possible error reasons:
  1. FC Port Down
  2. No Response For FLOGI
  3. Duplicate FC ID
  4. FLOGI Rejected
  5. Vfabric Inactive
- **Duplicate FC IDs**—Number of Duplicate address(FC ID) assignments happened in the interface.
- **FC ID**—FC-ID allocated to the initial FLOGI request from NPG switch on the interface.
- **BB Credit**—Transmit Buffer to Buffer Credit.
- **Speed**—Link speed of the FC uplink interface.
- **FLOGI**—Number of Fabric Login Sessions in the FC uplink interface.
- **FDISC**—Number of Fabric Discovery Session in the FC uplink interface.
- **Total**—Total number of sessions (FLOGI and FDISC) in the FC uplink interface.
- **Re-distributed**—Number of sessions redistributed for better load balancing in the interface.

### Example

```
OS10#show npg uplink-interfaces vfabric 100
```

```
VFabric Id : 100
Uplink
Intf FC Id BB Credit Speed
 (Gbps) FLOGI FDISC Total Re-distributed

Fc 1/1/1 01:00:01 2 8 3 3 6 6
Fc 1/1/2 01:00:02 4 16 1 9 10 15
```

```
OS10#show npg uplink-interfaces
```

```
VFabric Id : 100
Uplink
Intf FC Id BB Credit Speed
 (Gbps) FLOGI FDISC Total Re-
distributed

Fc 1/1/1 01:00:01 2 8 3 3 6 6
Fc 1/1/2 01:00:02 4 16 1 9 10 15
```

```
VFabric Id : 200
Uplink
Intf FC Id BB Credit Speed
 (Gbps) FLOGI FDISC Total Re-
distributed

Fc 1/1/11 01:00:0B 2 8 3 3 6 10
Fc 1/1/12 01:00:0C 4 16 1 0 1 1
```

```
VFabric Id : 300
Uplink
Intf FC Id BB Credit Speed
 (Gbps) FLOGI FDISC Total Re-
distributed

Fc 1/1/13 01:00:03 2 8 3 3 6 0
Fc 1/1/14 01:00:04 4 16 1 6 7 5
```

```
OS10#show npg uplink-interfaces fcf-info
```

```
VFabric Id : 200
FAD Timeout Left : 10 second(s)
FCF Availability Status : No
```

```
Uplink
Intf Upstream Fabric-Name Error Reason Duplicate
 FC-Id(s)

Fc 1/1/11 10:01:d4:ae:52:1a:ee:50 FLOGI_REJECTED 1
Fc 1/1/12 10:01:d4:ae:52:2b:ff:52 NONE 0
```

```
VFabric Id : 300
```



```

FAD Timeout Left : 0 second(s)
FCF Availability Status : Yes

Uplink
Intf Upstream Fabric-Name Error Reason Duplicate

Fc 1/1/13 20:01:d4:ae:52:1a:ee:53 NONE 1
Fc 1/1/14 20:01:d4:ae:52:7d:aa:54 NONE 0

OS10#show npg uplink-interfaces vfabric 200 fcf-info
VFabric Id : 200
FAD Timeout Left : 10 second(s)
FCF Availability Status : No

Uplink
Intf Upstream Fabric-Name Error Reason Duplicate

Fc 1/1/11 10:01:d4:ae:52:1a:ee:50 FLOGI_REJECTED 1
Fc 1/1/12 10:01:d4:ae:52:2b:ff:52 NONE 0

```

**Supported Releases** 10.5.1.0 or later

## show npg node-interface

Display details in a Node-facing interface.

- Syntax** show npg node-interfaces [vfabric vfabric-id]
- Parameters** None
- Default** Not configured
- Command Mode** EXEC
- Usage Information** Displays the statistics of node facing interfaces in all available or specified vFabrics. This command is supported in NPG mode.

The following table lists the fields and descriptions displayed in the output:

**Table 22. Fields and Descriptions**

| Fields         | Description                                                                 |
|----------------|-----------------------------------------------------------------------------|
| Node Intf      | Interface name of the port to which a FCoE or FC Node (Server) is connected |
| FLOGI          | Number of Fabric Login Sessions in the node-facing interface                |
| FDISC          | Number of Fabric Discovery Sessions in the FC uplink interface              |
| Re-distributed | Number of sessions redistributed for better load balancing in the interface |

### Example

```

OS10#show npg node-interfaces vfabric 100
VFabric Id : 100

Node Intf FLOGI FDISC Re-distributed

Fc 1/1/9 1 1 2
Fc 1/1/10 1 1 2
Eth 1/1/54 1 1 2
Eth 1/1/55 1 9 10

OS10#show npg node-interfaces

```

```

VFabric Id : 100
Node Intf FLOGI FDISC Re-distributed

Fc 1/1/9 1 1 2
Fc 1/1/10 1 1 2
Eth 1/1/54 1 1 2
Eth 1/1/55 1 9 10

VFabric Id : 200
Node Intf FLOGI FDISC Re-distributed

Fc 1/1/7 1 1 2

VFabric Id : 300
Node Intf FLOGI FDISC Re-distributed

Eth 1/1/51 1 9 10

```

**Supported Releases** 10.4.0E(R1) or later

## show fc statistics

Displays the FC statistics.

**Syntax** `show fc statistics {vfabric vfabric-ID | interface fibrenchannel}`

- Parameters**
- *vfabric-ID* — Enter the vfabric ID.
  - *fibrenchannel* — Enter the Fibre Channel interface name.

**Default** Not configured

**Command Mode** EXEC

**Usage Information** None

**Example (vfabric)**

```

OS10# show fc statistics vfabric 100
Number of FLOGI : 43
Number of FDISC : 6
Number of FLOGO : 0
Number of FLOGI Accepts : 43
Number of FLOGI Rejects : 0
Number of FDISC Accepts : 6
Number of FDISC Rejects : 0
Number of FLOGO Accepts : 0
Number of FLOGO Rejects : 0

```

**Example (interface)**

```

OS10# show fc statistics interface fibrenchannel1/1/25:1
Number of FLOGI : 1
Number of FDISC : 0
Number of FLOGO : 0
Number of FLOGI Accepts : 1
Number of FLOGI Rejects : 0
Number of FDISC Accepts : 0
Number of FDISC Rejects : 0
Number of FLOGO Accepts : 0
Number of FLOGO Rejects : 0

```

**Supported Releases** 10.3.1E or later

## show fc switch

Displays FC switch parameters.

**Syntax** show fc switch

**Parameters** None

**Default** Not configured

**Command Mode** EXEC

**Usage Information** None

### Example

```
OS10# show fc switch
Switch Mode : FPORT
Switch WWN : 10:00:14:18:77:20:8d:cf
```

**Supported Releases** 10.3.1E or later

## show running-config vfabric

Displays the running configuration for the vfabric.

**Syntax** show running-config vfabric

**Parameters** None

**Defaults** Not configured

**Command Mode** EXEC

**Usage Information** None

### Example

```
OS10# show running-configuration vfabric
!
vfabric 10
vlan 100
fcoe fcmap 0xEFC00
fcoe fcf-priority 140
fcoe fka-adv-period 13
```

**Supported Releases** 10.4.0E(R1) or later

## show vfabric

Displays vfabric details.

**Syntax** show vfabric

**Parameters** None

**Default** Not configured

**Command Mode** EXEC

**Usage Information** None

### Example

```
OS10# show vfabric
Fabric Name SAN_FABRIC
```

```

Fabric Type FPORT
Fabric Id 10
VlanId 1001
FC-MAP 0EFC00
Config-State ACTIVE
Oper-State UP
=====
Switch Config Parameters
=====
Domain ID 4
=====
Switch Zoning Parameters
=====
Default Zone Mode: Deny
Active ZoneSet: zoneset5
=====
Members
 fibrechannell1/1/25
 port-channel10 (Eth 1/1/9)

```

**Supported Releases** 10.3.1E or later

## vfabric

Configures a vfabric.

**Syntax** `vfabric fabric-ID`

**Parameters** `fabric-ID` — Enter the fabric ID, from 1 to 255.

**Defaults** Not configured

**Command Mode** CONFIGURATION

**Usage Information** Enable the F\_Port or NPG feature before configuring a vfabric. You can configure only one vfabric in F\_Port mode. The vfabric becomes active only when you configure the vfabric with a valid VLAN and FC map. Do not use spanned VLAN as vfabric VLAN.

The `no` version of this command removes the vfabric. You can remove a vfabric only when it is not applied on any interface.

Supported on the MX9116n switch in Full Switch mode starting in release 10.4.1.0. Also supported in SmartFabric mode starting in release 10.5.0.1.

**Example**

```
OS10(config)# vfabric 100
```

**Supported Releases** 10.3.1E or later

## vfabric (interface)

Applies an existing vfabric to an Ethernet or FC interface.

**Syntax** `vfabric fabric-ID`

**Parameters** `fabric-ID` — Enter the fabric ID, from 1 to 255.

**Defaults** Not configured

**Command Mode** INTERFACE

**Usage Information** The `no` version of this command removes the vfabric from the interface.

## Example

```
OS10(config)# interface fibrechannel 1/1/1
OS10(conf-if-fc1/1/1)# vfabric 100
```

```
OS10(config)# interface ethernet 1/1/10
OS10(conf-if-eth1/1/10)# vfabric 200
```

## Supported Releases

10.3.1E or later

## vlan

Associates an existing VLAN ID to the vfabric to carry traffic.

### Syntax

`vlan vlan-ID`

### Parameters

*vlan-ID* — Enter an existing VLAN ID.

### Defaults

Not configured

### Command Mode

Vfabric CONFIGURATION

### Usage Information

Create the VLAN ID before associating it to the vfabric. Do not use spanned VLAN as vfabric VLAN. The no version of this command removes the VLAN ID from the vfabric.

## Example

```
OS10(config)# interface vlan 1023
OS10(conf-if-vl-1023)# exit
OS10(config)# vfabric 100
OS10(conf-vfabric-100)# vlan 1023
```

## Supported Releases

10.3.1E or later

## FIP-snooping commands

The following commands are supported on FIP-snooping mode:

### feature fip-snooping

Enables the FIP snooping feature globally.

### Syntax

`feature fip-snooping [with-cvl]`

### Parameters

*with-cvl* — To enable CVL.

### Defaults

Disabled

### Command Mode

CONFIGURATION

### Usage Information

You can enable only one of the following at a time: F\_Port, NPG, or FSB.

You can include the `with-cvl` option to send a Clear Virtual Link (CVL) frame from the FCF to the ENode. This option helps the system to recover automatically if an FCoE session drops. If FIP snooping is already enabled, you can enter the `feature fip-snooping with-cvl` command to enable CVL. You do not have to explicitly disable FIP snooping to enable CVL. However, to disable CVL, you must disable FIP snooping and then re-enable it without the `with-cvl` option.

The `no` version of this command disables FIP snooping. When you disable FIP snooping, the system automatically deletes all the FIP snooping VLAN and port mode configurations. If any FIP snooping-related configurations are present in the system, OS10 returns an error message. You can only disable FIP snooping after you remove all the FIP snooping-related configurations from the system.

**Example**

```
OS10(config)# feature fip-snooping
```

```
OS10(config)# feature fip-snooping with-cvl
```

**Supported Releases**

10.4.0E(R1) or later

## fip-snooping enable

Enables FIP snooping on a specified VLAN.

**Syntax** `fip-snooping enable`

**Parameters** None

**Defaults** Disabled

**Command Mode** VLAN INTERFACE

**Usage Information** Enable FIP snooping on a VLAN only after enabling the FIP snooping feature globally using the `feature fip-snooping` command. OS10 supports FIP snooping on a maximum of 12 VLANs. The `no` version of this command disables FIP snooping on the VLAN.

**Example**

```
OS10(config)# interface vlan 3
OS10(conf-if-vl-3)# fip-snooping enable
```

**Supported Releases**

10.4.0E(R1) or later

## fip-snooping fc-map

Configures the FC map value for a specific VLAN.

**Syntax** `fip-snooping fc-map fc-map`

**Parameters** *fc-map* — Enter the FC map ID, from 0xefc00 to 0xefcff.

**Defaults** Not configured

**Command Mode** VLAN INTERFACE

**Usage Information** The `no` version of this command disables the FC map configuration.

**Example**

```
OS10(config)# interface vlan 3
OS10(conf-if-vl-3)# fip-snooping fc-map 0xEFC64
```

**Supported Releases**

10.4.0E(R1) or later

## fip-snooping port-mode

Sets FIP snooping port mode for interfaces.

**Syntax** `fip-snooping port-mode {enode | enode-transit | fcf | fcf-transit}`

**Parameters** `enode | enode-transit | fcf | fcf-transit`—Enter the keyword to set FIP snooping port mode.

**Defaults** ENode port mode

|                           |                                                                                                                                                                                                                                                                                                                                                                                                                                                                                                                                                                                                                                                                                                                                                                                                                                                                                                |
|---------------------------|------------------------------------------------------------------------------------------------------------------------------------------------------------------------------------------------------------------------------------------------------------------------------------------------------------------------------------------------------------------------------------------------------------------------------------------------------------------------------------------------------------------------------------------------------------------------------------------------------------------------------------------------------------------------------------------------------------------------------------------------------------------------------------------------------------------------------------------------------------------------------------------------|
| <b>Command Mode</b>       | INTERFACE                                                                                                                                                                                                                                                                                                                                                                                                                                                                                                                                                                                                                                                                                                                                                                                                                                                                                      |
| <b>Usage Information</b>  | <p>OS10 supports this configuration only on a switch running FSB mode, and on Ethernet and port-channel interfaces. You cannot configure FIP snooping port mode on a port channel member.</p> <p>Use this command to change the port mode. By default, the port mode of an interface is set to ENode. Configure the port mode only after you enable FIP snooping. Before you disable FIP snooping, reset the port mode to its default value, ENode.</p> <p>You cannot disable FIP snooping when the port mode is set to a non-default value (enode-transit, fcf, or fcf-transit).</p> <p>If you want to change the port mode from one value to another, you can directly use the <code>fip-snooping port mode</code> command. You do not have to explicitly use the <code>no</code> form of the command.</p> <p>The <code>no</code> version of this command resets the port mode to ENode.</p> |
| <b>Example</b>            | <pre>OS10(config)# interface ethernet 1/1/32 OS10(conf-if-eth1/1/32)# fip-snooping port-mode fcf</pre>                                                                                                                                                                                                                                                                                                                                                                                                                                                                                                                                                                                                                                                                                                                                                                                         |
| <b>Supported Releases</b> | 10.4.0E(R1) or later 10.4.3.0 or later—Support for enode-transit and fcf-transit port modes added.                                                                                                                                                                                                                                                                                                                                                                                                                                                                                                                                                                                                                                                                                                                                                                                             |

## FCoE commands

The following commands are supported on all the three modes: F\_Port, NPG, and FSB.

### clear fcoe database

Clears the FCoE database for the specified VLAN.

|                           |                                                                                                                                                                                                                                                                                                                         |
|---------------------------|-------------------------------------------------------------------------------------------------------------------------------------------------------------------------------------------------------------------------------------------------------------------------------------------------------------------------|
| <b>Syntax</b>             | <code>clear fcoe database vlan <i>vlan-id</i> {enode <i>enode-mac-address</i>   fcf <i>fcf-mac-address</i>   session <i>fcoe-mac-address</i>}</code>                                                                                                                                                                    |
| <b>Parameters</b>         | <ul style="list-style-type: none"> <li>• <i>vlan-id</i> — Enter the VLAN ID.</li> <li>• <i>enode-mac-address</i> — Enter the MAC address of the ENode.</li> <li>• <i>fcf-mac-address</i> — Enter the MAC address of the FCF.</li> <li>• <i>fcoe-mac-address</i> — Enter the MAC address of the FCoE session.</li> </ul> |
| <b>Default</b>            | Not configured                                                                                                                                                                                                                                                                                                          |
| <b>Command Mode</b>       | EXEC                                                                                                                                                                                                                                                                                                                    |
| <b>Usage Information</b>  | None                                                                                                                                                                                                                                                                                                                    |
| <b>Example</b>            | <pre>OS10# clear fcoe database vlan 100 enode aa:bb:cc:00:00:00</pre>                                                                                                                                                                                                                                                   |
| <b>Supported Releases</b> | 10.4.0E(R1) or later                                                                                                                                                                                                                                                                                                    |

### clear fcoe statistics

Clears FCoE statistics for specified interface.

|                   |                                                                                                                    |
|-------------------|--------------------------------------------------------------------------------------------------------------------|
| <b>Syntax</b>     | <code>clear fcoe statistics [<i>interface interface-type</i>]</code>                                               |
| <b>Parameters</b> | <i>interface-type</i> — (Optional) Enter the interface type. The interface may be ethernet, VLAN, or port-channel. |
| <b>Default</b>    | Not configured                                                                                                     |

|                           |                                                                                                                                                  |
|---------------------------|--------------------------------------------------------------------------------------------------------------------------------------------------|
| <b>Command Mode</b>       | EXEC                                                                                                                                             |
| <b>Usage Information</b>  | If you do not specify the <code>interface interface-type</code> information, the command clears the statistics for all the interfaces and VLANs. |
| <b>Example</b>            | <pre>OS10# clear fcoe statistics interface ethernet 1/1/1 OS10# clear fcoe statistics interface port-channel 5</pre>                             |
| <b>Supported Releases</b> | 10.4.0E(R1) or later                                                                                                                             |

## fcoe delay fcf-adv

Delay the Multicast Discovery Advertisement from FCFs to be sent to Enodes.

|                           |                                                                                                                                                                                    |
|---------------------------|------------------------------------------------------------------------------------------------------------------------------------------------------------------------------------|
| <b>Syntax</b>             | <code>fcoe delay fcf-adv timeout</code>                                                                                                                                            |
| <b>Parameters</b>         | timeout - Timeout range specified in seconds. Range is 1 to 30 seconds.                                                                                                            |
| <b>Default</b>            | Not configured                                                                                                                                                                     |
| <b>Command Mode</b>       | Global config                                                                                                                                                                      |
| <b>Usage Information</b>  | Time to wait after the last FCF connects to the NPG switch to send the Multicast discovery Advertisement. This command is supported in NPG mode.                                   |
| <b>Example</b>            | <pre>OS10(config)# fcoe delay fcf-adv 16</pre>                                                                                                                                     |
| <b>Supported Releases</b> | 10.4.0E(R1) or later In previous releases, the command is not available in full switch mode. From this release, the command is available both in full switch mode and fabric mode. |

## fcoe-pinned-port

Marks a port as a pinned port in the port-channel. This configuration is supported on FSB, Ethernet LAG in NPG, and F\_Port mode. It is not supported on a VLTi LAG.

|                           |                                                                                                                                                                                                                                                                                                                |
|---------------------------|----------------------------------------------------------------------------------------------------------------------------------------------------------------------------------------------------------------------------------------------------------------------------------------------------------------|
| <b>Syntax</b>             | <code>fcoe-pinned-port</code>                                                                                                                                                                                                                                                                                  |
| <b>Parameters</b>         | <code>node/slot/port[:subport]</code> —Enter the interface type details.                                                                                                                                                                                                                                       |
| <b>Defaults</b>           | Disabled                                                                                                                                                                                                                                                                                                       |
| <b>Command Mode</b>       | Port-channel INTERFACE                                                                                                                                                                                                                                                                                         |
| <b>Usage Information</b>  | You can configure only single port per port-channel. If the port is not configured properly, or if the pinned port goes down, the other ports in the port-channel are not used even if the ports have valid path to server. The <code>no</code> version of this command removes the pinned port configuration. |
| <b>Example</b>            | <pre>OS10(conf-if-eth-1/1/9)# channel-member 10 OS10(conf-if-eth-1/1/9)# fcoe-pinned-port Warning: Any existing FCoE session in port-channel will get cleared. Do you want to continue(yes/no)?yes</pre>                                                                                                       |
| <b>Supported Releases</b> | 10.4.2.0 or later                                                                                                                                                                                                                                                                                              |

## fcoe max-sessions-per-enodemac

Configures the maximum number of sessions allowed for an ENode.

|               |                                                                |
|---------------|----------------------------------------------------------------|
| <b>Syntax</b> | <code>fcoe max-sessions-per-enodemac max-session-number</code> |
|---------------|----------------------------------------------------------------|



|                           |                                                                                                                                                                                                                                                                                                                           |
|---------------------------|---------------------------------------------------------------------------------------------------------------------------------------------------------------------------------------------------------------------------------------------------------------------------------------------------------------------------|
| <b>Parameters</b>         | <i>max-session-number</i> — Enter the maximum number of sessions to be allowed, from 1 to 64.                                                                                                                                                                                                                             |
| <b>Defaults</b>           | 32                                                                                                                                                                                                                                                                                                                        |
| <b>Command Mode</b>       | CONFIGURATION                                                                                                                                                                                                                                                                                                             |
| <b>Usage Information</b>  | The <code>no</code> version of this command resets the number of sessions to the default value.                                                                                                                                                                                                                           |
|                           | <b>NOTE:</b> This command is not available in the fabric mode of MX9116N-ON. So in MX9116N-ON, the number of FCoE sessions is always 32. If the device is in Full-switch mode, you can configure the maximum number of FCoE sessions per ENode to be 64 using the <code>fcoe max-sessions-per-enodemac 64</code> command. |
| <b>Example</b>            | <pre>OS10(config)# fcoe max-sessions-per-enodemac 64</pre>                                                                                                                                                                                                                                                                |
| <b>Supported Releases</b> | 10.4.0E(R1) or later                                                                                                                                                                                                                                                                                                      |

## fcoe priority-bits

Configures the priority bits for FCoE application TLVs.

|                           |                                                                                                                                                                                    |
|---------------------------|------------------------------------------------------------------------------------------------------------------------------------------------------------------------------------|
| <b>Syntax</b>             | <code>fcoe priority-bits <i>priority-value</i></code>                                                                                                                              |
| <b>Parameter</b>          | <i>priority-value</i> — Enter PFC priority value advertised in FCoE application TLV. You can enter one of the following values: 0x01, 0x02, 0x04, 0x08, 0x10, 0x20, 0x40, or 0x80. |
| <b>Default</b>            | 0x08                                                                                                                                                                               |
| <b>Command Mode</b>       | CONFIGURATION                                                                                                                                                                      |
| <b>Usage Information</b>  | You can configure only one PFC priority at a time. The <code>no</code> version of this command returns the configuration to default value.                                         |
| <b>Example</b>            | <pre>OS10(config)# fcoe priority-bits 0x08</pre>                                                                                                                                   |
| <b>Supported Releases</b> | 10.4.0E(R3) or later                                                                                                                                                               |

## lldp tlv-select dcbxp-appln fcoe

Enables FCoE application TLV for an interface.

|                          |                                                                                                                                                                                                                                                                                                                                                                                                                                                                                                                         |
|--------------------------|-------------------------------------------------------------------------------------------------------------------------------------------------------------------------------------------------------------------------------------------------------------------------------------------------------------------------------------------------------------------------------------------------------------------------------------------------------------------------------------------------------------------------|
| <b>Syntax</b>            | <code>lldp tlv-select dcbxp-appln fcoe</code>                                                                                                                                                                                                                                                                                                                                                                                                                                                                           |
| <b>Parameter</b>         | None                                                                                                                                                                                                                                                                                                                                                                                                                                                                                                                    |
| <b>Default</b>           | Enabled                                                                                                                                                                                                                                                                                                                                                                                                                                                                                                                 |
| <b>Command Mode</b>      | INTERFACE                                                                                                                                                                                                                                                                                                                                                                                                                                                                                                               |
| <b>Usage Information</b> | <p>The default priority value advertised in FCoE application TLV is 3. If the PFC configuration in an interface matches 3, then the FCoE application TLV is advertised as 3. Otherwise, FCoE application TLV is not advertised.</p> <p>When you configure the application priority using <code>fcoe priority-bits</code> command, the configured value is advertised in the TLV, which is not dependent on PFC configuration.</p> <p>The <code>no</code> version of this command disables the FCoE application TLV.</p> |
| <b>Example</b>           | <pre>OS10(conf-if-eth1/1/1)# lldp tlv-select dcbx-appln fcoe</pre>                                                                                                                                                                                                                                                                                                                                                                                                                                                      |

**Supported Releases**

10.4.0E(R3) or later

## re-balance fc npg sessions vfabric

Re-balances the FC sessions across FC uplinks.

**Syntax** `re-balance fc npg sessions vfabric vfabric-id [dry-run] [brief]`**Parameters** None**Defaults** Not configured**Command Mode** EXEC

**Usage Information** Triggers the load-balancing mechanism to redistribute the sessions across the FC uplinks. The `dry-run` option displays the current state of the system, sessions that are cleared, and the system state after the load balancing is done without actually doing it. You can use the `brief` option (both in dry run and actual run) to view only the session redistribution information. You can configure `fcoe delay fcf-adv` timer that is based on the switch configuration to balance the system during reload. Even if the system is unbalanced after reload, you can use this command in the switch to balance the sessions, within the uplinks. This command is supported in the NPG mode. Re-balance is not recommended for a NPG cascading topology. The fields and their corresponding descriptions displayed in this command are as follows:

- Uplink Intf—The name of the FC uplink interface.
- FLOGI—Number of Fabric Login Sessions in the FC uplink interface.
- FDISC—Number of Fabric Discovery Sessions in the FC uplink interface.
- Load—Total number of sessions (FLOGI and FDISC) in the FC uplink interface.
- Speed—Link speed of the FC uplink interface.
- Excess Load—Excess load is the absolute (Current load on the link - ((Minimum load per 8G speed in current state) \* port-speed/8G)). It captures the level to which the corresponding link is oversubscribed when compared to other FC upstream links in the system.
- Node WWPN—World-Wide Port Name is used for the Fabric Login Request of the Server that is connected to the OS10 switch. It can be an FCoE server or an FC server.
- From Uplink Intf—Interface name of the FC uplink from which the sessions from the server are redistributed.
- To Uplink Intf—Interface name of the FC uplink to which the sessions are mapped when the server logins.
- No. of sessions—Count of redistributed sessions.

**Example**

```
OS10#re-balance npg sessions vfabric 100 dry-run
```

```
Fabric Id 100 Current State
```

| Uplink Intf | FLOGI | FDISC | Load | Speed (Gbps) | Excess Load |
|-------------|-------|-------|------|--------------|-------------|
|-------------|-------|-------|------|--------------|-------------|

|          |   |    |    |    |   |
|----------|---|----|----|----|---|
| Fc 1/1/1 | 1 | 9  | 10 | 8  | 7 |
| Fc 1/1/2 | 3 | 3  | 6  | 16 | 0 |
|          | 4 | 12 | 16 | 24 | 7 |

```

Session Displacements:
```

```
Total No. of Node(s) : 4
```

```
No. of Node(s) displaced : 4
```

```

Node WWPN From Uplink Intf To Uplink Intf No.of sessions
```

|                         |          |          |    |
|-------------------------|----------|----------|----|
| 20:01:d4:ae:52:1a:ee:54 | Fc 1/1/1 | Fc 1/1/2 | 10 |
| 21:01:d4:ae:52:1a:ee:54 | Fc 1/1/2 | Fc 1/1/1 | 2  |
| 22:01:d4:ae:52:1a:ee:54 | Fc 1/1/2 | Fc 1/1/1 | 2  |
| 23:01:d4:ae:52:1a:ee:54 | Fc 1/1/2 | Fc 1/1/1 | 2  |

```
Fabric Id 100 State after Re-balancing
```

| Uplink Intf | FLOGI | FDISC | Load | Speed (Gbps) | Excess Load |
|-------------|-------|-------|------|--------------|-------------|
| Fc 1/1/1    | 3     | 3     | 6    | 8            | 1           |
| Fc 1/1/2    | 1     | 9     | 10   | 16           | 0           |
|             | 4     | 12    | 16   | 24           | 1           |

```
OS10#re-balance npg sessions vfabric 100 dry-run brief
```

```
Fabric Id 100 Session Displacements:
```

```
Total No. of Node(s) : 4
No. of Node(s) displaced : 4
```

| Node WWPN               | From Uplink Intf | To Uplink Intf | No.of sessions |
|-------------------------|------------------|----------------|----------------|
| 20:01:d4:ae:52:1a:ee:54 | Fc 1/1/1         | Fc 1/1/2       | 10             |
| 21:01:d4:ae:52:1a:ee:54 | Fc 1/1/2         | Fc 1/1/1       | 2              |
| 22:01:d4:ae:52:1a:ee:54 | Fc 1/1/2         | Fc 1/1/1       | 2              |
| 23:01:d4:ae:52:1a:ee:54 | Fc 1/1/2         | Fc 1/1/1       | 2              |

```
OS10#re-balance npg sessions vfabric 100
```

```
Fabric Id 100 State before Re-balancing
```

| Uplink Intf | FLOGI | FDISC | Load | Speed (Gbps) | Excess Load |
|-------------|-------|-------|------|--------------|-------------|
| Fc 1/1/1    | 1     | 9     | 10   | 8            | 7           |
| Fc 1/1/2    | 3     | 3     | 6    | 16           | 0           |
|             | 4     | 12    | 16   | 24           | 7           |

```
Session Displacements:
```

```
Total No. of Node(s) : 4
No. of Node(s) displaced : 4
```

| Node WWPN               | From Uplink Intf | To Uplink Intf | No.of sessions |
|-------------------------|------------------|----------------|----------------|
| 20:01:d4:ae:52:1a:ee:54 | Fc 1/1/1         | Fc 1/1/2       | 10             |
| 21:01:d4:ae:52:1a:ee:54 | Fc 1/1/2         | Fc 1/1/1       | 2              |
| 22:01:d4:ae:52:1a:ee:54 | Fc 1/1/2         | Fc 1/1/1       | 2              |
| 23:01:d4:ae:52:1a:ee:54 | Fc 1/1/2         | Fc 1/1/1       | 2              |

```
Fabric Id 100 Expected State after Re-balancing
```

| Uplink Intf | FLOGI | FDISC | Load | Speed (Gbps) | Excess Load |
|-------------|-------|-------|------|--------------|-------------|
| Fc 1/1/1    | 3     | 3     | 6    | 8            | 1           |
| Fc 1/1/2    | 1     | 9     | 10   | 16           | 0           |
|             | 4     | 12    | 16   | 24           | 1           |

### Supported Releases

10.4.0E(R1) or later

## show fcoe enode

Displays the details of ENodes connected to the switch.

**Syntax** `show fcoe enode [enode-mac-address]`

**Parameters** *enode-mac-address* — (Optional) Enter the MAC address of ENode. This option displays details pertaining to the specified ENode.

**Default** Not configured

**Command Mode** EXEC

**Usage Information** None

**Example**

```
OS10# show fcoe enode
Enode MAC Enode Interface VLAN FCFs Sessions

d4:ae:52:1b:e3:cd Po 20 (Eth 1/1/3) 1001 1 1
```

**Supported Releases** 10.4.0E(R1) or later

## show fcoe fcf

Displays details of the FCFs connected to the switch.

**Syntax** `show fcoe fcf [fcf-mac-address]`

**Parameters** *fcf-mac-address* — (Optional) Enter the MAC address of the FCF. This option displays details of the specified FCF.

**Default** Not configured

**Command Mode** EXEC

**Usage Information** In NPG mode, displays all the logical FCF(s) associated with various fabrics available in the gateway switch. Since this logical FCF is not associated with any particular interface, the FCF interface column of this command's output will display a '~' symbol instead of the interface name. This convention is similar to the one used in FPORT and Multi-switch mode of operation.

**Example**

```
OS10# show fcoe fcf
FCF MAC FCF Interface VLAN FC-MAP FKA_ADV_PERIOD No.
of Enodes FCF Mode

00:0c:84:a8:00:00 Eth 1/1/36 777 0e:fc:00 8000
0 F
00:0d:84:a8:01:02 Eth 1/1/37 778 0e:fc:01 8000
0 FT
```

```
OS10# show fcoe fcf
FCF MAC FCF Interface VLAN FC-MAP FKA_ADV_PERIOD No. of
Enodes

54:7f:ee:37:34:40 ~ 100 0e:fc:00 4000
2
54:7f:ee:37:34:40 ~ 200 0e:fc:01 4000
0
```

```
OS10# show fcoe fcf 54:7f:ee:37:34:40
FCF MAC FCF Interface VLAN FC-MAP FKA_ADV_PERIOD No. of
Enodes

54:7f:ee:37:34:40 ~ 100 0e:fc:00 4000
2
```

```
54:7f:ee:37:34:40 ~ 200 0e:fc:01 4000
0
```

**Supported Releases** 10.4.0E(R1) or later

## show fcoe pinned-port

Displays the port-channel, the corresponding pinned-port configuration, and the port status if the FCoE sessions are formed.

**Syntax** `show fcoe pinned-port [port-channel port-channel-id]`  
**Parameters** *port-channel-id*—Enter the port-channel ID to display the corresponding configuration.  
**Default** Not configured  
**Command Mode** EXEC  
**Usage Information** None

### Example

```
OS10# show fcoe pinned-port

Interface pinned-port FCoE Status

Po 10 Eth 1/1/1 Up
Po 20 Eth 1/1/3 Up
Po 30 Eth 1/1/7 Down
```

**Supported Releases** 10.4.2.0 or later

## show fcoe sessions

Displays the details of the established FCoE sessions.

**Syntax** `show fcoe sessions [interface vlan vlan-id]`  
**Parameters** *vlan-id* — (Optional) Enter the VLAN ID. This option displays the sessions established on the specified VLAN.  
**Default** Not configured  
**Command Mode** EXEC  
**Usage Information** None

### Example

```
Enode MAC Enode Interface FCF MAC FCF interface
VLAN FCoE MAC FC-ID PORT WWPN
aa:bb:cc:00:00:00 Po 20(Eth 1/1/3) aa:bb:cd:00:00:00 Po 10(Eth 1/1/1)
100 0e:fc:00:01:00:01 01:00:01 31:00:0e:fc:00:00:00:00
21:00:0e:fc:00:00:00
aa:bb:cc:00:00:00 Po 20(Eth 1/1/3) aa:bb:cd:00:00:00 Po 10(Eth 1/1/1)
100 0e:fc:00:01:00:02 01:00:02 31:00:0e:fc:00:00:00:00
21:00:0e:fc:00:00:00
```

**Supported Releases** 10.4.0E(R1) or later

## show fcoe statistics

Displays the statistical details of the FCoE control plane.

|                          |                                                                                                                             |
|--------------------------|-----------------------------------------------------------------------------------------------------------------------------|
| <b>Syntax</b>            | <code>show fcoe statistics [interface <i>interface-type</i>]</code>                                                         |
| <b>Parameters</b>        | <i>interface-type</i> — (Optional) Enter the type of interface. This option displays statistics of the specified interface. |
| <b>Default</b>           | Not configured                                                                                                              |
| <b>Command Mode</b>      | EXEC                                                                                                                        |
| <b>Usage Information</b> | None                                                                                                                        |

### Example

```
OS10# show fcoe statistics interface port-channel10
Number of Vlan Requests :0
Number of Vlan Notifications :0
Number of Multicast Discovery Solicits :2
Number of Unicast Discovery Solicits :0
Number of FLOGI :2
Number of FDISC :16
Number of FLOGO :0
Number of Enode Keep Alive :9021
Number of VN Port Keep Alive :3349
Number of Multicast Discovery Advertisement :4437
Number of Unicast Discovery Advertisement :2
Number of FLOGI Accepts :2
Number of FLOGI Rejects :0
Number of FDISC Accepts :16
Number of FDISC Rejects :0
Number of FLOGO Accepts :0
Number of FLOGO Rejects :0
Number of CVL :0
Number of FCF Discovery Timeouts :0
Number of VN Port Session Timeouts :0
Number of Session failures due to Hardware Config :0
```

|                           |                      |
|---------------------------|----------------------|
| <b>Supported Releases</b> | 10.4.0E(R1) or later |
|---------------------------|----------------------|

## show fcoe system

Displays system information related to the FCoE.

|                          |                               |
|--------------------------|-------------------------------|
| <b>Syntax</b>            | <code>show fcoe system</code> |
| <b>Parameters</b>        | None                          |
| <b>Default</b>           | Not configured                |
| <b>Command Mode</b>      | EXEC                          |
| <b>Usage Information</b> | None                          |

### Example

```
OS10# show fcoe system
Mode: FIP Snooping Bridge
CVL Status: Enabled
FCOE VLAN List (Operational) : 1, 100
FCFs : 1
Enodes : 2
Sessions : 17
```

|                           |                      |
|---------------------------|----------------------|
| <b>Supported Releases</b> | 10.4.0E(R1) or later |
|---------------------------|----------------------|

## show fcoe vlan

Displays details of FIP-snooping VLANs.

**Syntax** show fcoe vlan

**Parameters** None

**Default** Not configured

**Command Mode** EXEC

**Usage Information** None

### Example

```
OS10# show fcoe vlan
* = Default VLAN
VLAN FC-MAP FCFs Enodes Sessions
---- -
*1 - - - -
100 0X0EFC00 1 2 17
```

**Supported Releases** 10.4.0E(R1) or later

## Layer 2

|                                                   |                                                                                                                                                                                                                                                                  |
|---------------------------------------------------|------------------------------------------------------------------------------------------------------------------------------------------------------------------------------------------------------------------------------------------------------------------|
| <b>802.1X</b>                                     | Verifies device credentials before sending or receiving packets using the Extensible Authentication Protocol (EAP), see <a href="#">802.1X Commands</a> .                                                                                                        |
| <b>Link Aggregation Control Protocol (LACP)</b>   | Exchanges information between two systems and automatically establishes a link aggregation group (LAG) between the systems, see <a href="#">LACP Commands</a> .                                                                                                  |
| <b>Link Layer Discovery Protocol (LLDP)</b>       | Enables a local area network (LAN) device to advertise its configuration and receive configuration information from adjacent LLDP-enabled infrastructure devices, see <a href="#">LLDP Commands</a> .                                                            |
| <b>Media Access Control (MAC)</b>                 | Configures limits, redundancy, balancing, and failure detection settings for devices on your network using tables, see <a href="#">MAC Commands</a> .                                                                                                            |
| <b>Multiple Spanning-Tree (MST)</b>               | Maps MST instances and maps many virtual local area networks (VLANs) to a single spanning-tree instance, reducing the number of required instances, see <a href="#">MST Commands</a> .                                                                           |
| <b>Rapid Per-VLAN Spanning-Tree Plus (RPVST+)</b> | Combination of rapid spanning-tree and per-VLAN spanning-tree plus for faster convergence and interoperability, see <a href="#">RPVST+ Commands</a> .                                                                                                            |
| <b>Rapid Spanning-Tree Protocol (RSTP)</b>        | Faster convergence and interoperability with devices configured with the Spanning-Tree and Multiple Spanning-Tree Protocols (STPs and MSTPs), see <a href="#">RSTP Commands</a> .                                                                                |
| <b>Virtual LANs (VLANs)</b>                       | Improved security to isolate groups of users into different VLANs and the ability to create a single VLAN across multiple devices, see <a href="#">VLAN Commands</a> .                                                                                           |
| <b>Port Monitoring (Local/Remote)</b>             | Port monitoring of ingress or egress traffic, or both ingress and egress traffic, on specified port(s). Monitoring methods include port-mirroring, remote port monitoring, and encapsulated remote-port monitoring (see <a href="#">Local/Remote Commands</a> ). |

### Configuration notes

Dell EMC PowerSwitch S4200-ON Series:

The default MAC aging time is set as 550 seconds. This is the maximum value that can be configured.

## 802.1X

The IEEE 802.1X standard defines a client and server-based access control that prevents unauthorized clients from connecting to a LAN through publicly accessible ports. Authentication is only required in OS10 for inbound traffic. Outbound traffic transmits regardless of the authentication state.

802.1X employs the extensible authentication protocol (EAP) to provide device credentials to an authentication server, typically remote authentication dial-in service (RADIUS), using an intermediary network access device. The network access device mediates all communication between the end-user device and the authentication server so the network remains secure.

The network access device uses EAP-over-Ethernet, also known as EAPOL—EAP over LAN, to communicate with the end-user device and EAP-over-RADIUS to communicate with the server.



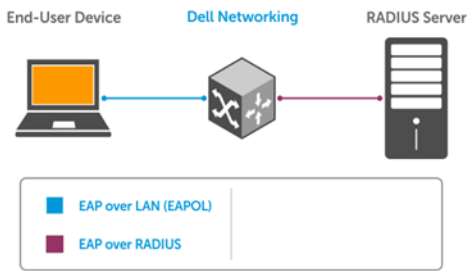

**NOTE:** OS10 supports only RADIUS as the back-end authentication server.

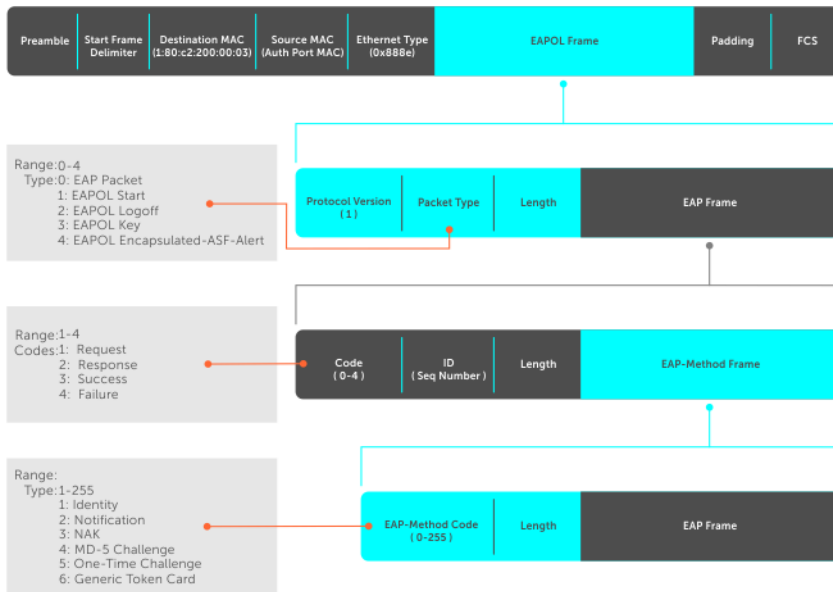

The authentication process contains three devices:

- **Supplicant** — The device attempting to access the network performs the role of supplicant. Regular traffic from this device does not reach the network until the port associated to the device is authorized. Before that, the supplicant can only exchange 802.1x messages (EAPOL frames) with the authenticator.
- **Authenticator** — The authenticator is the gate keeper of the network, translating and forwarding requests and responses between the authentication server and the supplicant. The authenticator also changes the status of the port based on the results of the authentication process. The authenticator runs on the Dell EMC device.
- **Authentication-server** — The authentication-server selects the authentication method, verifies the information that the supplicant provides, and grants network access privileges.

### Configuration notes

All Dell EMC PowerSwitches except MX-Series, S4200-Series, S5200 Series, and Z9332F-ON:

802.1X becomes fully functional only when the feature is enabled globally. If you do not enable 802.1X globally but enable only at the interface level, the system displays the Dot1x Not Enabled message.

## Port authentication

The process begins when the authenticator senses a link status change from down to up:

1. The authenticator requests that the supplicant identify itself using an *EAP Request Identity* frame.
2. The supplicant responds with its identity in an *EAP Response Identity* frame.
3. The authenticator decapsulates the EAP response from the EAPOL frame, encapsulates it in a *RADIUS Access Request* frame, and forwards the frame to the authentication server.
4. The authentication server replies with an *Access Challenge* frame who requests that the supplicant verifies its identity using an EAP-Method. The authenticator translates and forwards the challenge to the supplicant.
5. The supplicant negotiates the authentication method and provides the *EAP Request* information in an *EAP Response*. Another *Access Request* frame translates and forwards the response to the authentication server.

6. If the identity information the supplicant provides is valid, the authentication server sends an *Access Accept* frame that specifies the network privileges. The authenticator changes the port state to authorize and forwards an *EAP Success* frame. If the identity information is invalid, the server sends an *Access Reject* frame. If the port state remains unauthorized, the authenticator forwards an *EAP Failure* frame.

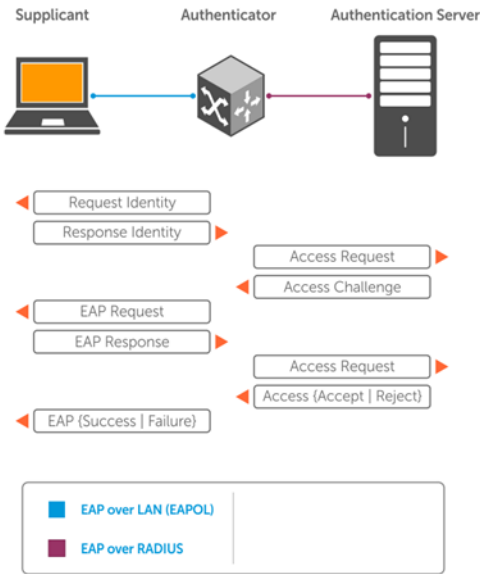

## EAP over RADIUS

802.1X uses RADIUS to transfer EAP packets between the authenticator and the authentication server. EAP messages are encapsulated in RADIUS packets as an attribute of type, length, value (TLV) format—the *type* value for EAP messages is 79.

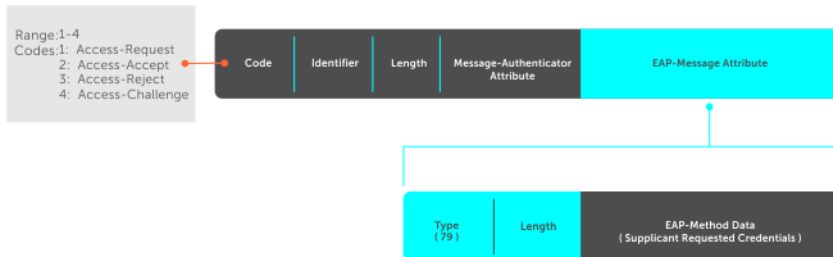

## Configure 802.1X

You can configure and enable 802.1X on a port in a single process. OS10 supports 802.1X with EAP-MD5, EAP-TLS, and EAP-TTLS. All platforms support RADIUS as the authentication server.

If the primary RADIUS server becomes unresponsive, the authenticator begins using a secondary RADIUS server if configured.

**NOTE:** 802.1X is not supported on port channels or port channel members.

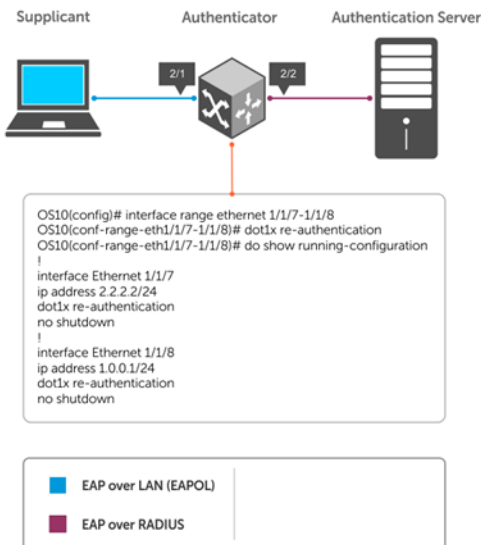

## Enable 802.1X

1. Enable 802.1X globally in CONFIGURATION mode.

```
dot1x system-auth-control
```

2. Enter an interface or a range of interfaces in CONFIGURATION mode.

```
interface range
```

3. Enable 802.1X on the supplicant interface only in INTERFACE mode.

```
dot1x port-control auto
```

### Configure and verify 802.1X configuration

```

OS10(config)# dot1x system-auth-control
OS10(config)# interface range ethernet 1/1/7-1/1/8
OS10(conf-range-eth1/1/7-1/1/8)# dot1x port-control auto
OS10(conf-range-eth1/1/7-1/1/8)# dot1x re-authentication
OS10(conf-range-eth1/1/7-1/1/8)# do show dot1x interface ethernet 1/1/7

```

```
802.1x information on ethernet1/1/7
```

```

Dot1x Status: Enable
Port Control: AUTO
Port Auth Status: UNAUTHORIZED
Re-Authentication: Enable
Tx Period: 60 seconds
Quiet Period: 60 seconds
Supplicant Timeout: 30 seconds
Server Timeout: 30 seconds
Re-Auth Interval: 3600 seconds
Max-EAP-Req: 2
Host Mode: MULTI_HOST
Auth PAE State: Initialize
Backend State: Idle

```

## Identity retransmissions

If the authenticator sends a *Request Identity* frame but the supplicant does not respond, the authenticator waits 30 seconds and then retransmits the frame. There are several reasons why the supplicant might fail to respond—the supplicant maybe booting when the request arrived, there may be a physical layer problem, and so on.

1. Configure the amount of time that the authenticator waits before retransmitting an EAP *Request Identity* frame in INTERFACE mode, from 1 to 65535 – 1 year, default 60.

```
dot1x timeout tx-period seconds
```

2. Configure a maximum number of times the authenticator retransmits a *Request Identity* frame in INTERFACE mode from 1 to 10, default 2.

```
dot1x max-req retry-count
```

### Configure and verify retransmission time

```
OS10(config)# dot1x system-auth-control
OS10(config)# interface range ethernet 1/1/7-1/1/8
OS10(conf-range-eth1/1/7-1/1/8)# dot1x timeout tx-period 120
OS10(conf-range-eth1/1/7-1/1/8)# dot1x max-req 5
OS10(conf-range-eth1/1/7-1/1/8)# do show dot1x interface ethernet 1/1/7
```

```
802.1x information on ethernet1/1/7

Dot1x Status: Enable
Port Control: AUTO
Port Auth Status: UNAUTHORIZED
Re-Authentication: Enable
Tx Period: 120 seconds
Quiet Period: 60 seconds
Supplicant Timeout: 30 seconds
Server Timeout: 30 seconds
Re-Auth Interval: 3600 seconds
Max-EAP-Req: 5
Host Mode: MULTI_HOST
Auth PAE State: Initialize
Backend State: Idle
```

### View interface running configuration

```
OS10(conf-range-eth1/1/7-1/1/8)# do show running-configuration interface
...
!
interface ethernet1/1/7
 no shutdown
 dot1x max-req 5
 dot1x port-control auto
 dot1x re-authentication
 dot1x timeout quiet-period 120
 dot1x timeout tx-period 120
!
interface ethernet1/1/8
 no shutdown
 dot1x max-req 5
 dot1x port-control auto
 dot1x re-authentication
 dot1x timeout quiet-period 120
 dot1x timeout tx-period 120
...
```

## Failure quiet period

If the supplicant fails the authentication process, the authenticator sends another Request Identity frame after 30 seconds by default. The quiet period is a transmit interval time after a failed authentication.

The Request Identity Retransmit interval is for an unresponsive supplicant. You can configure the interval for a maximum of 10 times for an unresponsive supplicant.

1. Configure the amount of time that the authenticator waits to retransmit a *Request Identity* frame after a failed authentication in INTERFACE mode from 1 to 65535, default 60 seconds.

```
dot1x timeout quiet-period seconds
```

### Configure and verify port authentication

```
OS10(conf-range-eth1/1/7-1/1/8)# dot1x timeout quiet-period 120
OS10(conf-range-eth1/1/7-1/1/8)# do show dot1x interface ethernet 1/1/7
802.1x information on ethernet1/1/7

Dot1x Status: Enable
Port Control: AUTO
Port Auth Status: UNAUTHORIZED
Re-Authentication: Enable
Tx Period: 120 seconds
Quiet Period: 120 seconds
Supplicant Timeout: 30 seconds
Server Timeout: 30 seconds
Re-Auth Interval: 3600 seconds
Max-EAP-Req: 5
Host Mode: MULTI_HOST
Auth PAE State: Initialize
Backend State: Idle
```

### View interface running configuration

```
OS10(conf-range-eth1/1/7-1/1/8)# do show running-configuration interface
...
!
interface ethernet1/1/7
 no shutdown
 dot1x max-req 5
 dot1x port-control auto
 dot1x re-authentication
 dot1x timeout quiet-period 120
 dot1x timeout tx-period 120
!
interface ethernet1/1/8
 no shutdown
 dot1x max-req 5
 dot1x port-control auto
 dot1x re-authentication
 dot1x timeout quiet-period 120
 dot1x timeout tx-period 120
...

```

## Port control mode

802.1X requires a port to be in one of three states—force-authorized, force-unauthorized, or auto.

- force-authorized (default)** This is an *authorized state*. A device connected to this port does not use the authentication process but can communicate on the network. Placing the port in this state is the same as disabling 802.1X on the port. *force-authorized* is the default mode.
- force-unauthorized** This is an *unauthorized state*. A device connected to a port does not use the authentication process but is *not* allowed to communicate on the network. Placing the port in this state is the same as shutting down the port. Any attempt by the supplicant to initiate authentication is ignored.
- auto** This is an *unauthorized state* by default. A device connected to this port is subject to the authentication process. If the process is successful, the port is authorized and the connected device communicates on the network.

- Place a port in the auto, force-authorized (default), or force-unauthorized state in INTERFACE mode.

```
dot1x port-control {auto | force-authorized | force-unauthorized}
```

### Configure and verify force-authorized state

```
OS10(conf-range-eth1/1/7-1/1/8)# dot1x port-control force-authorized
OS10(conf-range-eth1/1/7-1/1/8)# do show dot1x interface ethernet 1/1/7

802.1x information on ethernet1/1/7

Dot1x Status: Enable
Port Control: AUTHORIZED
Port Auth Status: UNAUTHORIZED
Re-Authentication: Enable
Tx Period: 120 seconds
Quiet Period: 120 seconds
Supplicant Timeout: 30 seconds
Server Timeout: 30 seconds
Re-Auth Interval: 3600 seconds
Max-EAP-Req: 5
Host Mode: MULTI_HOST
Auth PAE State: Initialize
Backend State: Initialize
```

### View interface running configuration

```
OS10(conf-range-eth1/1/7-1/1/8)# do show running-configuration interface
...
!
interface ethernet1/1/7
 no shutdown
 dot1x max-req 5
 dot1x re-authentication
 dot1x timeout quiet-period 120
 dot1x timeout tx-period 120
!
interface ethernet1/1/8
 no shutdown
 dot1x max-req 5
 dot1x re-authentication
 dot1x timeout quiet-period 120
 dot1x timeout tx-period 120
...

```

## Reauthenticate a port

Configures the time period for reauthentication. After the supplicant is authenticated and the port is authorized, configure the authenticator to reauthenticate the supplicant. If you enable reauthentication, the supplicant reauthenticates every 3600 seconds.

- Reauthenticate the supplicant in INTERFACE mode, from 1 to 65535, default 3600.

```
dot1x timeout re-authperiod seconds
```

### Configure and verify reauthentication time period

```
OS10(config)# interface range ethernet 1/1/7-1/1/8
OS10(conf-range-eth1/1/7-1/1/8)# dot1x re-authentication
OS10(conf-range-eth1/1/7-1/1/8)# dot1x timeout re-authperiod 3600
OS10(conf-range-eth1/1/7-1/1/8)# show dot1x interface ethernet 1/1/7

802.1x information on ethernet1/1/7

Dot1x Status: Enable
Port Control: AUTHORIZED
Port Auth Status: UNAUTHORIZED
Re-Authentication: Enable
```

```

Tx Period: 120 seconds
Quiet Period: 120 seconds
Supplicant Timeout: 30 seconds
Server Timeout: 30 seconds
Re-Auth Interval: 3600 seconds
Max-EAP-Req: 5
Host Mode: MULTI_HOST
Auth PAE State: Initialize
Backend State: Initialize

```

### View interface running configuration

```

OS10(conf-range-eth1/1/7-1/1/8)# do show running-configuration interface
...
!
interface ethernet1/1/7
 no shutdown
 dot1x max-req 5
 dot1x re-authentication
 dot1x timeout quiet-period 120
 dot1x timeout re-authperiod 3600
 dot1x timeout tx-period 120
!
interface ethernet1/1/8
 no shutdown
 dot1x max-req 5
 dot1x re-authentication
 dot1x timeout quiet-period 120
 dot1x timeout re-authperiod 3600
 dot1x timeout tx-period 120
...

```

## Configure timeouts

If the supplicant or authentication server is unresponsive, the authenticator terminates the authentication process after 30 seconds by default. Configure the amount of time the authenticator waits for a response before termination.

- Terminate the authentication process due to an unresponsive supplicant in INTERFACE mode, from 1 to 65535, default 30.

```
dot1x timeout supp-timeout seconds
```

- Terminate the authentication process due to an unresponsive authentication server in INTERFACE mode, from 1 to 65535, default 30.

```
dot1x timeout server-timeout seconds
```

### Configure and verify server timeouts

```

OS10(conf-range-eth1/1/7-1/1/8)# dot1x timeout supp-timeout 45
OS10(conf-range-eth1/1/7-1/1/8)# dot1x timeout server-timeout 60
OS10(conf-range-eth1/1/7-1/1/8)# do show dot1x interface ethernet 1/1/7

802.1x information on ethernet1/1/7

Dot1x Status: Enable
Port Control: AUTHORIZED
Port Auth Status: UNAUTHORIZED
Re-Authentication: Enable
Tx Period: 120 seconds
Quiet Period: 120 seconds
Supplicant Timeout: 45 seconds
Server Timeout: 60 seconds
Re-Auth Interval: 3600 seconds
Max-EAP-Req: 5
Host Mode: MULTI_HOST
Auth PAE State: Initialize
Backend State: Initialize

```

## View interface running configuration

```
OS10(conf-range-eth1/1/7-1/1/8)# do show running-configuration interface
...
!
interface ethernet1/1/7
 no shutdown
 dot1x max-req 5
 dot1x re-authentication
 dot1x timeout quiet-period 120
 dot1x timeout re-authperiod 3600
 dot1x timeout server-timeout 60
 dot1x timeout supp-timeout 45
 dot1x timeout tx-period 120
!
interface ethernet1/1/8
 no shutdown
 dot1x max-req 5
 dot1x re-authentication
 dot1x timeout quiet-period 120
 dot1x timeout re-authperiod 3600
 dot1x timeout server-timeout 60
 dot1x timeout supp-timeout 45
 dot1x timeout tx-period 120
...
```

## Configure RADIUS server

To configure RADIUS server for 802.1x authentication, use the `radius-server host` command. Enter the server IP address or host name, and the shared secret key used to authenticate the OS10 switch on a RADIUS host.

- Configure a RADIUS over TLS authentication on a RADIUS server in CONFIGURATION mode.

```
radius-server host {hostname | ip-address} key {0 authentication-key | 9
authentication-key | authentication-key} [auth-port port-number]
```

To configure more than one RADIUS server for 802.1x authentication, re-enter the `radius-server host tls` command multiple times. If you configure multiple RADIUS servers, OS10 attempts to connect in the order you configured them. An OS10 switch connects with the configured RADIUS servers one at a time, until a RADIUS server responds with an accept or reject response. The switch tries to connect with a server for the configured number of retransmit retries and timeout period.

Configure global settings for the timeout and retransmit attempts allowed on RADIUS servers as described in [RADIUS authentication](#).

### Configure RADIUS for 802.1x authentication

```
OS10(config)# radius-server host 1.5.6.4 key secret1
OS10(config)# radius-server retransmit 10
OS10(config)# radius-server timeout 10
```

## 802.1X commands

### dot1x host-mode

Allows 802.1X authentication for either a single supplicant or multiple supplicants on an interface.

**Syntax** `dot1x host-mode {multi-host}`

**Parameters**

- `multi-host` — Allows attachment of multiple hosts to a single 802.1X-enabled port. You can only authorize one of the attached clients for all clients to grant network access. If the port becomes unauthorized (reauthentication fails or receives an EAPOL-logoff message), the device denies network access to all the attached clients.

**Default** Multihost



**Command Mode** INTERFACE

**Usage Information** The no version of this command resets the value to the default.

**Example**

```
OS10(conf-range-eth1/1/7-1/1/8)# dot1x host-mode multi-host
```

**Supported Releases** 10.2.0E or later

## dot1x max-req

Changes the maximum number of requests that the device sends to a supplicant before restarting 802.1X authentication.

**Syntax** dot1x max-req *retry-count*

**Parameters** max-req *retry-count* — Enter the retry count for the request sent to the supplicant before restarting 802.1X reauthentication, from 1 to 10.

**Default** 2

**Command Mode** INTERFACE

**Usage Information** The no version of this command resets the value to the default.

**Example**

```
OS10(conf-range-eth1/1/7-1/1/8)# dot1x max-req 4
```

**Supported Releases** 10.2.0E or later

## dot1x port-control

Controls the 802.1X authentication that is performed on the interface.

**Syntax** dot1x port-control {force-authorized | force-unauthorized | auto}

**Parameters**

- force-authorized — Disables 802.1X authentication on the interface and allows all traffic on the interface without authentication.
- force-unauthorized — Keeps the port in the unauthorized state, ignoring all attempts by the client to authenticate.
- auto — Enables 802.1X authentication on the interface.

**Default** Force-authorized

**Command Mode** INTERFACE

**Usage Information** The no version of this command resets the value to the default.

**Example**

```
OS10(config)# interface range ethernet 1/1/7-1/1/8
OS10(conf-range-eth1/1/7-1/1/8)# dot1x port-control auto
```

**Supported Releases** 10.2.0E or later

## dot1x reauthentication

Enables periodic reauthentication of 802.1X supplicants.

**Syntax** dot1x re-authentication

|                           |                                                                                                           |
|---------------------------|-----------------------------------------------------------------------------------------------------------|
| <b>Parameters</b>         | None                                                                                                      |
| <b>Default</b>            | Disabled                                                                                                  |
| <b>Command Mode</b>       | INTERFACE                                                                                                 |
| <b>Usage Information</b>  | The <code>no</code> version of this command disables the periodic reauthentication of 802.1X supplicants. |
| <b>Example</b>            | <pre>OS10(conf-range-eth1/1/7-1/1/8)# dot1x re-authentication</pre>                                       |
| <b>Supported Releases</b> | 10.2.0E or later                                                                                          |

## dot1x timeout quiet-period

Sets the number of seconds that the device remains in the quiet state following a failed authentication exchange with a supplicant.

|                           |                                                                                                                              |
|---------------------------|------------------------------------------------------------------------------------------------------------------------------|
| <b>Syntax</b>             | <code>dot1x timeout quiet-period <i>seconds</i></code>                                                                       |
| <b>Parameters</b>         | <code>quiet period <i>seconds</i></code> — Enter the number of seconds for the 802.1X quiet period timeout, from 1 to 65535. |
| <b>Default</b>            | 60 seconds                                                                                                                   |
| <b>Command Mode</b>       | INTERFACE                                                                                                                    |
| <b>Usage Information</b>  | The <code>no</code> version of this command resets the value to the default.                                                 |
| <b>Example</b>            | <pre>OS10(conf-range-eth1/1/7-1/1/8)# dot1x timeout quiet-period 120</pre>                                                   |
| <b>Supported Releases</b> | 10.2.0E or later                                                                                                             |

## dot1x timeout re-authperiod

Sets the number of seconds between reauthentication attempts.

|                           |                                                                                                                                   |
|---------------------------|-----------------------------------------------------------------------------------------------------------------------------------|
| <b>Syntax</b>             | <code>dot1x timeout re-authperiod <i>seconds</i></code>                                                                           |
| <b>Parameters</b>         | <code>re-authperiod <i>seconds</i></code> — Enter the number of seconds for the 802.1X reauthentication timeout, from 1 to 65535. |
| <b>Default</b>            | 3600 seconds                                                                                                                      |
| <b>Command Mode</b>       | INTERFACE                                                                                                                         |
| <b>Usage Information</b>  | The <code>no</code> version of this command resets the value to the default.                                                      |
| <b>Example</b>            | <pre>OS10(conf-range-eth1/1/7-1/1/8)# dot1x timeout re-authperiod 7200</pre>                                                      |
| <b>Supported Releases</b> | 10.2.0E or later                                                                                                                  |

## dot1x timeout server-timeout

Sets the number of seconds that the device waits before retransmitting a packet to the authentication server.

|               |                                                          |
|---------------|----------------------------------------------------------|
| <b>Syntax</b> | <code>dot1x timeout server-timeout <i>seconds</i></code> |
|---------------|----------------------------------------------------------|

|                           |                                                                                                                   |
|---------------------------|-------------------------------------------------------------------------------------------------------------------|
| <b>Parameters</b>         | <code>server-timeout seconds</code> — Enter the number of seconds for the 802.1X server timeout, from 1 to 65535. |
| <b>Default</b>            | 30 seconds                                                                                                        |
| <b>Command Mode</b>       | INTERFACE                                                                                                         |
| <b>Usage Information</b>  | The <code>no</code> version of this command resets the value to the default.                                      |
| <b>Example</b>            | <pre>OS10(conf-range-eth1/1/7-1/1/8)# dot1x server-timeout 60</pre>                                               |
| <b>Supported Releases</b> | 10.2.0E or later                                                                                                  |

## dot1x timeout supp-timeout

Sets the number of seconds that the device waits for the supplicant to respond to an EAP request frame before the device retransmits the frame.

|                           |                                                                                                                     |
|---------------------------|---------------------------------------------------------------------------------------------------------------------|
| <b>Syntax</b>             | <code>dot1x timeout supp-timeout seconds</code>                                                                     |
| <b>Parameters</b>         | <code>supp-timeout seconds</code> — Enter the number of seconds for the 802.1X supplicant timeout, from 1 to 65535. |
| <b>Default</b>            | 30 seconds                                                                                                          |
| <b>Command Mode</b>       | INTERFACE                                                                                                           |
| <b>Usage Information</b>  | The <code>no</code> version of this command resets the value to the default.                                        |
| <b>Example</b>            | <pre>OS10(conf-range-eth1/1/7-1/1/8)# dot1x timeout supp-timeout 45</pre>                                           |
| <b>Supported Releases</b> | 10.2.0E or later                                                                                                    |

## dot1x timeout tx-period

Sets the number of seconds that the device waits for a response to an EAP-request/identity frame from the supplicant before retransmitting the request.

|                           |                                                                                                                    |
|---------------------------|--------------------------------------------------------------------------------------------------------------------|
| <b>Syntax</b>             | <code>dot1x timeout tx-period seconds</code>                                                                       |
| <b>Parameters</b>         | <code>tx-period seconds</code> — Enter the number of seconds for the 802.1X transmission timeout, from 1 to 65535. |
| <b>Default</b>            | 60 seconds                                                                                                         |
| <b>Command Mode</b>       | INTERFACE                                                                                                          |
| <b>Usage Information</b>  | The <code>no</code> version of this command resets the value to the default.                                       |
| <b>Example</b>            | <pre>OS10(conf-range-eth1/1/7-1/1/8)# dot1x timeout tx-period 120</pre>                                            |
| <b>Supported Releases</b> | 10.2.0E or later                                                                                                   |

## show dot1x

Displays global 802.1X configuration information.

|                          |                |
|--------------------------|----------------|
| <b>Syntax</b>            | show dot1x     |
| <b>Parameters</b>        | None           |
| <b>Default</b>           | Not configured |
| <b>Command Mode</b>      | EXEC           |
| <b>Usage Information</b> | None           |

### Example

```
OS10# show dot1x
PAE Capability: Authenticator only
Protocol Version: 2
System Auth Control: Enable
Auth Server: Radius
```

**Supported Releases** 10.2.0E or later

## show dot1x interface

Displays 802.1X configuration information.

|                          |                                                                                      |
|--------------------------|--------------------------------------------------------------------------------------|
| <b>Syntax</b>            | show dot1x interface ethernet <i>node/slot/port[:subport]</i>                        |
| <b>Parameters</b>        | ethernet <i>node/slot/port[:subport]</i> —Enter the Ethernet interface information.  |
| <b>Command Mode</b>      | EXEC                                                                                 |
| <b>Usage Information</b> | Use this command to view the dot1x interface configuration for a specific interface. |

### Example

```
OS10# show dot1x interface
802.1x information on ethernet1/1/1

Dot1x Status: Enable
802.1x information on ethernet1/1/2

Dot1x Status: Enable
802.1x information on ethernet1/1/3

Dot1x Status: Enable
802.1x information on ethernet1/1/4

Dot1x Status: Enable
802.1x information on ethernet1/1/5

Dot1x Status: Enable
802.1x information on ethernet1/1/6

Dot1x Status: Enable
802.1x information on ethernet1/1/7

Dot1x Status: Enable
Port Control: AUTO
Port Auth Status: UNAUTHORIZED
--more--
```

### Example (when dot1x is not enabled globally)

```
OS10# show dot1x interface
802.1x not enabled in the system
OS10#
```

**Supported Releases** 10.2.0E or later

## RADIUS server commands

### radius-server host

Configures a RADIUS server and the key used to authenticate the switch on the server.

**Syntax** `radius-server host {hostname | ip-address} key {0 authentication-key | 9 authentication-key | authentication-key} [auth-port port-number]`

- Parameters**
- `hostname` — Enter the host name of the RADIUS server.
  - `ip-address` — Enter the IPv4 (A.B.C.D) or IPv6 (x:x:x::x) address of the RADIUS server.
  - `key 0 authentication-key` — Enter an authentication key in plain text. A maximum of 42 characters.
  - `key 9 authentication-key` — Enter an authentication key in encrypted format. A maximum of 128 characters.
  - `authentication-key` — Enter an authentication in plain text. A maximum of 42 characters. It is not necessary to enter 0 before the key.
  - `auth-port port-number` — (Optional) Enter the UDP port number used on the server for authentication, from 1 to 65535, default 1812.

**Default** Not configured

**Command Mode** CONFIGURATION

**Usage Information** The authentication key must match the key configured on the RADIUS server. You cannot enter spaces in the key. The `show running-configuration` output displays both unencrypted and encrypted keys in encrypted format. Configure global settings for the timeout and retransmit attempts allowed on RADIUS servers using the `radius-server retransmit` and `radius-server timeout` commands.

Supported on the MX9116n and MX5108n switches in Full Switch mode starting in release 10.4.0E(R3S). Also supported in SmartFabric mode starting in release 10.5.0.1.

The `no` version of this command removes a RADIUS server configuration.

**Example**

```
OS10(config)# radius-server host 1.5.6.4 key secret1
```

**Supported Releases** 10.2.0E or later

### radius-server host tls

Configures a RADIUS server for RADIUS over TLS user authentication and secure communication. For RADIUS over TLS authentication, the `radsec` shared key and a security profile that uses an X.509v3 certificate are required.

**Syntax** `radius-server host {hostname | ip-address} tls security-profile profile-name [auth-port tcp-port-number] key {0 authentication-key | 9 authentication-key | authentication-key}`

- Parameters**
- `hostname` — Enter the host name of the RADIUS server.
  - `ip-address` — Enter the IPv4 (A.B.C.D) or IPv6 (x:x:x::x) address of the RADIUS server.
  - `tls` — Enter `tls` to secure RADIUS server communication using the TLS protocol.
  - `security-profile profile-name` — Enter the name of an X.509v3 security profile to use with RADIUS over TLS authentication. To configure a security profile for an OS10 application, see [Security profiles](#).
  - `auth-port tcp-port-number` — (Optional) Enter the TCP port number that the server uses for authentication. The range is from 1 to 65535. The default is 2083.

- `key 0 authentication-key` — Enter the `radsec` shared key in plain text.
- `key 9 authentication-key` — Enter the `radsec` shared key in encrypted format.
- `authentication-key` — Enter the `radsec` shared key in plain text. It is not necessary to enter 0 before the key.

**Default** TCP port 2083 on a RADIUS server for RADIUS over TLS communication

**Command Mode** CONFIGURATION

**Usage Information** For RADIUS over TLS authentication, configure the `radsec` shared key on the server and OS10 switch. The `show running-configuration` output displays both the unencrypted and encrypted key in encrypted format. Configure global settings for the timeout and retransmit attempts allowed on a RADIUS over TLS servers using the `radius-server retransmit` and `radius-server timeout` commands.

RADIUS over TLS authentication requires that X.509v3 PKI certificates are configured on a certification authority and installed on the switch. For more information, including a complete RADIUS over TLS example, see [X.509v3 certificates](#).

Supported on the MX9116n and MX5108n switches in Full Switch mode starting in release 10.4.3.0. Also supported in SmartFabric mode starting in release 10.5.0.1.

The `no` version of this command removes a RADIUS server from RADIUS over TLS communication.

**Example**

```
OS10(config)# radius-server host 1.5.6.4 tls security-profile radius-
admin key radsec
```

**Supported Releases** 10.4.3.0 or later

## radius-server nas-ip-address

Configures RADIUS attribute 4, NAS-IP-Address in the RADIUS request packet.

**Syntax** `radius-server nas-ip-address ipv4-address`

**Parameters** `ipv4-address`—Enter an arbitrary IP address to be configured as the NAS IP address in A.B.C.D format.

**Defaults** By default, the NAS IP attribute uses the management ethernet IP address. If management VRF is used for RADIUS authentication, this attribute uses a static IP address, 127.100.100.2.

**Command Mode** CONFIGURATION

**Usage Information** Use this command when you use the management VRF for RADIUS authentication. This command configures an arbitrary IP address to be used as RADIUS attribute 4, NAS-IP-Address without changing the source IP address in the IP header of the RADIUS packets.

The `no` version of this command removes the configuration.

**Example**

```
OS10(config)# radius-server nas-ip-address 10.5.1.1
```

**Supported Releases** 10.5.1.0 or later

## radius-server retransmit

Configures the number of authentication attempts allowed on RADIUS servers.

**Syntax** `radius-server retransmit retries`

**Parameters** `retries` — Enter the number of retry attempts, from 0 to 10.

**Default** An OS10 switch retransmits a RADIUS authentication request three times.

|                           |                                                                                                                                                                                                                                                                                                                                                                                                        |
|---------------------------|--------------------------------------------------------------------------------------------------------------------------------------------------------------------------------------------------------------------------------------------------------------------------------------------------------------------------------------------------------------------------------------------------------|
| <b>Command Mode</b>       | CONFIGURATION                                                                                                                                                                                                                                                                                                                                                                                          |
| <b>Usage Information</b>  | <p>Use this command to globally configure the number of retransmit attempts allowed for authentication requests on RADIUS servers.</p> <p>Supported on the MX9116n and MX5108n switches in Full Switch mode starting in release 10.4.0E(R3S). Also supported in SmartFabric mode starting in release 10.5.0.1.</p> <p>The <code>no</code> version of this command resets the value to the default.</p> |
| <b>Example</b>            | <pre>OS10(config)# radius-server retransmit 5</pre>                                                                                                                                                                                                                                                                                                                                                    |
| <b>Supported Releases</b> | 10.2.0E or later                                                                                                                                                                                                                                                                                                                                                                                       |

## radius-server timeout

Configures the timeout used to resend RADIUS authentication requests.

|                           |                                                                                                                                                                                                                                                                                                                                                         |
|---------------------------|---------------------------------------------------------------------------------------------------------------------------------------------------------------------------------------------------------------------------------------------------------------------------------------------------------------------------------------------------------|
| <b>Syntax</b>             | <code>radius-server timeout seconds</code>                                                                                                                                                                                                                                                                                                              |
| <b>Parameters</b>         | <code>seconds</code> — Enter the time in seconds for retransmission, from 1 to 100.                                                                                                                                                                                                                                                                     |
| <b>Default</b>            | An OS10 switch stops sending RADIUS authentication requests after five seconds.                                                                                                                                                                                                                                                                         |
| <b>Command Mode</b>       | CONFIGURATION                                                                                                                                                                                                                                                                                                                                           |
| <b>Usage Information</b>  | <p>Use this command to globally configure the timeout value used on RADIUS servers.</p> <p>Supported on the MX9116n and MX5108n switches in Full Switch mode starting in release 10.4.0E(R3S). Also supported in SmartFabric mode starting in release 10.5.0.1.</p> <p>The <code>no</code> version of this command resets the value to the default.</p> |
| <b>Example</b>            | <pre>OS10(config)# radius-server timeout 90</pre>                                                                                                                                                                                                                                                                                                       |
| <b>Supported Releases</b> | 10.2.0E or later                                                                                                                                                                                                                                                                                                                                        |

## radius-server vrf

Configures the RADIUS server for the management or non-default VRF instance.

|                           |                                                                                                                                                                                                                                                                                                                                   |
|---------------------------|-----------------------------------------------------------------------------------------------------------------------------------------------------------------------------------------------------------------------------------------------------------------------------------------------------------------------------------|
| <b>Syntax</b>             | <code>radius-server vrf {management   vrf-name}</code>                                                                                                                                                                                                                                                                            |
| <b>Parameters</b>         | <ul style="list-style-type: none"> <li><code>management</code> — Enter the keyword to configure the RADIUS server for the management VRF instance.</li> <li><code>vrf-name</code> — Enter the keyword then the name of the VRF to configure the RADIUS server for that non-default VRF instance.</li> </ul>                       |
| <b>Defaults</b>           | Not configured                                                                                                                                                                                                                                                                                                                    |
| <b>Command Mode</b>       | CONFIGURATION                                                                                                                                                                                                                                                                                                                     |
| <b>Usage Information</b>  | <p>Use this command to associate RADIUS servers with a VRF. If you do not configure a VRF on the RADIUS server list, the servers are on the default VRF. RADIUS server lists and VRFs have one-to-one mapping.</p> <p>The <code>no</code> version of this command removes the RADIUS server from the management VRF instance.</p> |
| <b>Example</b>            | <pre>OS10(config)# radius-server vrf management OS10(config)# radius-server vrf blue</pre>                                                                                                                                                                                                                                        |
| <b>Supported Releases</b> | 10.4.0E(R1) or later                                                                                                                                                                                                                                                                                                              |

# Far-end failure detection

Far-End Failure Detection (FEFD) is a protocol that detects remote data link errors in a network.

FEFD uses a link layer echo protocol to detect and signal far-end failures over Ethernet and optical links. When you enable FEFD, switches periodically exchange FEFD echo frames to identify link failures. If the local switch does not receive an echo from its peer for the time interval of three times the configured FEFD message interval, the local switch assumes that the peer link is down. The default interval for FEFD message interval is 15 seconds. For example, with the default configuration, if the local switch does not receive an echo message for 45 seconds from its peer, it brings the peer link down.

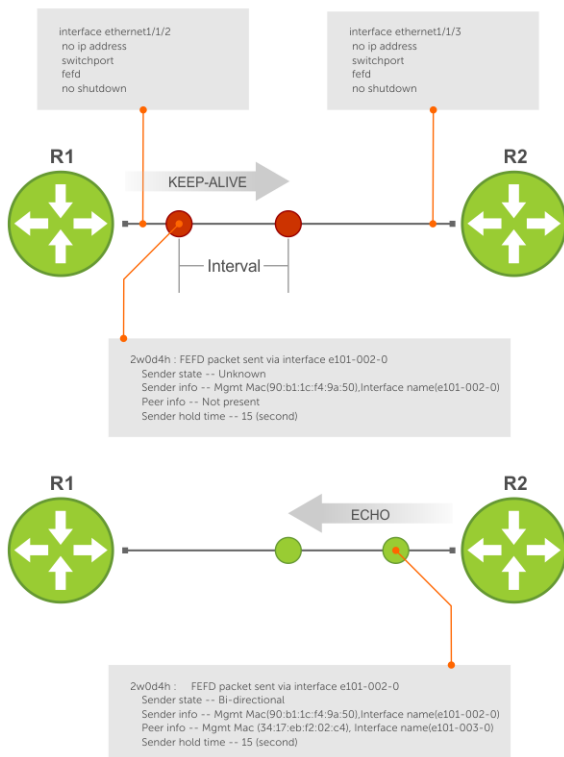

## FEFD helps detect far-end failure when the following problems occur:

- Only one side receives packets although the physical layer (L1) of the link is up on both sides.
- Transceivers are not connected to the correct ports.

## FEFD states

FEFD comprises the following four states:

- **Idle**—FEFD is disabled.
- **Unknown**—Shown when FEFD is enabled and changes to **bi-directional** after successful handshake with the peer. Also shown if the peer goes down in **normal** mode.
- **bi-directional**—Interface is up, connected, and receiving echoes of its neighbor.
- **err-disabled**—Only found when FEFD mode is **aggressive** and when the interface has not received three echoes of its neighbor. To reset an interface in this state, use the `fefd reset` command.

## FEFD modes

FEFD operates in two modes—Normal mode and aggressive mode.

- **Normal mode**—When you enable Normal mode on an interface and a far-end failure is detected, no intervention is required to reset the interface to bring it back to an FEFD operational state.
- **Aggressive mode**—When you enable Aggressive mode on an interface in the same state, you must manually reset the interface.

## The following events explain how FEFD state transition occurs:

- When you enable FEFD on an interface a link transitions from idle state to unknown state.



- In the unknown state, the interface starts transmitting link state information at a regular interval. The interface state changes to bi-directional when a handshake is complete with the peer.
- When an interface is in bi-directional state, if it does not receive an echo from its peer for the time interval of three times the configured FEFD message interval, the interface state changes to unknown in Normal mode. In Aggressive mode, the interface state changes to err-disabled.

If the interface state changes to err-disabled, use the `fefd reset [interface]` global command to reset these interfaces. The unknown or err-disabled state brings the line protocol down so that the protocols above it can detect that the peer link is down.

**Table 23. FEFD state changes**

| Local event (User intervention)            | Configured FEFD mode | Local state (Show display) (Result) | Local admin State (Result) | Local line protocol Status (Result) | Remote state (Show display) (Result) | Remote admin state | Remote line protocol status |
|--------------------------------------------|----------------------|-------------------------------------|----------------------------|-------------------------------------|--------------------------------------|--------------------|-----------------------------|
| Shutdown(user configuration)               | Normal               | Admin Shutdown                      | Down                       | Down                                | Line protocol is down.               | Up                 | Down                        |
| Shutdown(user configuration)               | Aggressive           | Admin Shutdown                      | Down                       | Down                                | Line protocol is down.               | Up                 | Down                        |
| FEFD+ FEFD disable(user configuration)     | Normal               | Locally disabled                    | Up                         | Up                                  | Unknown                              | Up                 | Down                        |
| FEFD + FEFD disable(user configuration)    | Aggressive           | Locally disabled                    | Up                         | Down                                | Err-disabled                         | Up                 | Down                        |
| Link Failure (Remove cable or transceiver) | Normal               | Unknown                             | Up                         | Down                                | Unknown                              | Up                 | Down                        |
| Link Failure(Remove cable or transceiver)  | Aggressive           | Unknown                             | Up                         | Down                                | Unknown                              | Up                 | Down                        |
| FEFD enable(user configuration)            | Normal               | Bi-directional                      | Up                         | Up                                  | Bi-directional                       | Up                 | Up                          |
| FEFD enable(user configuration)            | Aggressive           | Bi-directional                      | Up                         | Up                                  | Bi-directional                       | Up                 | Up                          |

**Restrictions**

- You can enable FEFD globally or on an interface. If FEFD is enabled globally, the FEFD interface configuration overrides global FEFD configuration.
- OS10 supports FEFD only on physical interfaces. FEFD is not supported on any other interfaces. However, you can enable FEFD on individual physical interfaces that belong to a port channel.

## Enable FEFD globally

To configure FEFD globally:

1. Do one of the following:

- Configure FEFD Normal mode globally using the `fefd-global` command in CONFIGURATION mode.

```
OS10(Config)# fefd-global
```

- Configure FEFD Normal mode globally using the `fefd-global mode normal` command in CONFIGURATION mode.

```
OS10(Config)# fefd-global mode normal
```

- Configure FEFD Aggressive mode globally using the `fefd-global mode aggressive` command in CONFIGURATION mode.

```
OS10(Config)# fefd-global mode aggressive
```

2. (Optional) Configure the FEFD interval using the `fefd-global interval` command in CONFIGURATION mode and enter the interval in seconds. The range is from 3 to 255 seconds.

```
OS10(Config)# fefd-global interval 20
```

3. (Optional) Disable FEFD on a specific interface if required using the `fefd disable` command in INTERFACE mode.

```
OS10(Config-if-eth1/1/1)# no fefd interval 20
```

For more information, refer to [Related Videos](#) section.

## Enable FEFD on interface

To configure FEFD on an interface:

1. Do one of the following:

- Configure FEFD Normal mode on an interface using the `fefd` command in INTERFACE mode.

```
OS10(Config-if-eth1/1/1)# fefd
```

- Configure FEFD Normal mode on an interface using the `fefd mode normal` command in INTERFACE mode.

```
OS10(Config-if-eth1/1/1)# fefd mode normal
```

- Configure FEFD Aggressive mode on an interface using the `fefd mode aggressive` command in INTERFACE mode.

```
OS10(Config-if-eth1/1/1)# fefd mode aggressive
```

2. (Optional) Configure the FEFD interval using the `fefd interval` command in INTERFACE mode and enter the interval in seconds. The range is from 3 to 255 seconds.

```
OS10(Config-if-eth1/1/1)# fefd interval 20
```

For more information, refer the [Related Videos](#) section.

## Reset FEFD err-disabled interface

When the system detects a far-end failure in FEFD aggressive mode, the interface moves to err-disabled state. To bring back the interface to FEFD operational state:

- Enter the `fefd reset` command in EXEC mode.

```
OS10# fefd reset ethernet 1/1/1
```

## Display FEFD information

To view FEFD information:

- To view FEFD information globally, use the `show fefd` command in EXEC mode.
- To view FEFD information for an interface, use the `show fefd interface` command in EXEC mode.

The following is a sample output of FEFD global information:

```
OS10# show fefd
FEFD is globally 'ON', interval is 15 seconds, mode is Normal.
INTERFACE MODE INTERVAL STATE
=====
eth1/1/1 NA NA Idle (Not running)
eth1/1/2 NA NA Idle (Not running)
eth1/1/3 NA NA Idle (Not running)
eth1/1/4 NA NA Idle (Not running)
eth1/1/5 NA NA Idle (Not running)
eth1/1/6 NA NA Idle (Not running)
eth1/1/7 NA NA Idle (Not running)
```

The following is a sample output of FEFD information for an interface:

```
rt-maa-s4248FBL-3# show fefd ethernet 1/1/1
FEFD is globally 'ON', interval is 15 seconds, mode is Normal.
INTERFACE MODE INTERVAL STATE
=====
eth1/1/1 NA NA Idle (Not running)
```

## FEFD Commands

### debug fefd

Enables debugging of FEFD.

**Syntax** `debug fefd {all | events | packets} [interface]`

**Parameters**

- `all`—Enter the keyword to view all FEFD debug information.
- `events`—Enter the keyword to view debug information about FEFD state changes.
- `packets`—Enter the keyword to view debug information about FEFD packets that are sent and received.
- (Optional) `interface`—Enter interface information.

**Default** Not configured

**Command Mode** EXEC Privilege

**Example**

```
OS10# debug fefd
```

**Supported Releases** 10.4.3.0 or later

### fefd

Configures FEFD on an interface.

**Syntax** `fefd [mode {normal | aggressive} | interval seconds | disable]`

**Parameters**

- (Optional) `mode`—Enter the keyword and enter either `normal` to enable the normal mode or `aggressive` to enable the aggressive mode.

- `interval`—Enter the keyword and enter the FEFD interval in seconds to configure the interval between FEFD control packets on an interface. The range is from 3 to 255. The default value is 15 seconds.
- `disable`—Enter the keyword to disable FEFD on a specific interface when you configure FEFD globally.

**Default** Not configured

**Command Mode** INTERFACE

**Usage Information** The `fefd` command without any arguments enables the normal mode with the default FEFD interval of 15 seconds.

If you use the `no fefd` command, the system does not disable FEFD if the `fefd mode` command is already present in the configuration. Similarly, if you use the `no fefd mode` command, the system does not disable FEFD if the `fefd` command is already present in the configuration.

To disable FEFD on an interface when FEFD globally enabled, use the `fefd disable` command on the interface.

To unconfigure FEFD on an interface, use either the `no fefd` command or the `no fefd mode` command. To return to the default FEFD interval, use the `no fefd interval` command.

**Example**

```
OS10(conf-if-eth1/1/9)# fefd
```

```
OS10(conf-if-eth1/1/9)# fefd mode aggressive
```

```
OS10(conf-if-eth1/1/9)# fefd mode interval 10
```

**Supported Releases** 10.4.3.0 or later

## fefd-global

Configures FEFD globally.

**Syntax** `fefd-global [mode {normal | aggressive} | interval seconds]`

- Parameters**
- (Optional) `mode`—Enter the keyword and enter either `normal` to enable the Normal mode or `aggressive` to enable the aggressive mode.
  - (Optional) `interval`—Enter the keyword and enter the FEFD interval in seconds to configure the interval between FEFD control packets globally. The range is from 3 to 255. The default value is 15 seconds.

**Default** Not configured

**Command Mode** CONFIGURATION

**Usage Information** The `fefd-global` command without arguments enables Normal mode with the default FEFD interval of 15 seconds.

If you use the `no fefd-global` command, the system does not disable FEFD if the `fefd-global mode` command is already present in the configuration. Similarly, if you use the `no fefd-global mode` command, the system does not disable FEFD if the `fefd-global` command is already present in the configuration.

To unconfigure FEFD globally, use either the `no fefd-global` command or the `no fefd-global mode` command. To return to the default FEFD interval, use the `no fefd-global interval` command.

## Example

```
OS10(config)# fefd-global
```

```
OS10(config)# fefd-global mode aggressive
```

```
OS10(config)# fefd mode interval 10
```

## Supported Releases

10.4.3.0 or later

## fefd reset

Resets interfaces that are in error-disabled state because FEFD is set to Aggressive mode.

### Syntax

```
fefd reset [interface]
```

### Parameters

- (Optional) *interface*—Enter the interface name to reset the error-disabled state of the interface because FEFD is set to Aggressive mode.

### Default

Not configured

### Command Mode

EXEC

### Usage Information

If you do not enter the interface name, this command resets the error-disabled state of all interfaces because FEFD is set to Aggressive mode.

## Example

```
OS10# fefd reset
```

```
OS10# fefd reset ethernet 1/1/2
```

## Supported Releases

10.4.3.0 or later

## show fefd

Displays FEFD information globally or for a specific interface.

### Syntax

```
show fefd [interface]
```

### Parameters

- (Optional) *interface*—Enter the interface information.

### Default

Not configured

### Command Mode

EXEC and EXEC Privilege

### Usage Information

The following table describes the fields in the `show fefd` command output:

| Field            | Description                                                                                                                                                                                                                                                                                                                                                                                                                |
|------------------|----------------------------------------------------------------------------------------------------------------------------------------------------------------------------------------------------------------------------------------------------------------------------------------------------------------------------------------------------------------------------------------------------------------------------|
| <b>Interface</b> | Displays the interface name                                                                                                                                                                                                                                                                                                                                                                                                |
| <b>Mode</b>      | Displays the mode—Aggressive, Normal, or NA when the interface contains <code>fefd reset</code> in its configuration.                                                                                                                                                                                                                                                                                                      |
| <b>Interval</b>  | Displays the interval between FEFD packets.                                                                                                                                                                                                                                                                                                                                                                                |
| <b>State</b>     | Displays the state of the interface and can be one of the following: <ul style="list-style-type: none"><li>• Bi-directional—Interface is up, connected, and receiving echoes of its neighbor.</li><li>• Err-disabled—Only found when FEFD mode is Aggressive and when the interface has not received three echoes of its neighbor. To reset an interface in this state, use the <code>fefd reset</code> command.</li></ul> |

| Field | Description                                                                                                                                                                                                                                                                                                                                                                                                                                                                                                                                                                                   |
|-------|-----------------------------------------------------------------------------------------------------------------------------------------------------------------------------------------------------------------------------------------------------------------------------------------------------------------------------------------------------------------------------------------------------------------------------------------------------------------------------------------------------------------------------------------------------------------------------------------------|
|       | <ul style="list-style-type: none"> <li>Unknown—Shown when FEFD is enabled and changes to <code>bi-directional</code> after successful handshake with the peer. Also shown if the peer goes down in <code>normal</code> mode.</li> <li>Locally disabled—Interface contains the <code>fefd reset</code> command in its configuration.</li> <li>Admin Shutdown—Interface is disabled using the <code>shutdown</code> command.</li> <li>Line protocol is down—The state on the remote device when an interface of the local device is disabled with the <code>shutdown</code> command.</li> </ul> |

### Example

```
OS10# show fefd
FEFD is globally 'ON', interval is 22 seconds, mode is NORMAL.
INTERFACE MODE INTERVAL STATE
=====
eth1/1/1 Normal 22 Unknown
eth1/1/2 Normal 22 Unknown
eth1/1/3 Normal 22 Unknown
eth1/1/4 Normal 22 Unknown
eth1/1/5 Normal 22 Unknown
eth1/1/6 Normal 22 Unknown
eth1/1/7 Normal 22 Unknown
eth1/1/8 Normal 22 Unknown
eth1/1/9 Aggressive 22 Err-disabled
eth1/1/10 Normal 22 Unknown
```

**Supported Releases** 10.4.3.0 or later

## Link Aggregation Control Protocol

Group Ethernet interfaces to form a single link layer interface called a LAG or port channel. Aggregating multiple links between physical interfaces creates a single logical LAG, which balances traffic across the member links within an aggregated Ethernet bundle and increases the uplink bandwidth. If one member link fails, the LAG continues to carry traffic over the remaining links. For information about LAG load balancing and hashing, see [Load balancing](#).

You can use LACP to create dynamic LAGs exchanging information between two systems (also called Partner Systems) and automatically establishing the LAG between the systems. LACP permits the exchange of messages on a link to:

- Agree on the identity of the LAG to which the link belongs.
- Move the link to that LAG.
- Enable the transmission and reception functions.

LACP functions by constantly exchanging custom MAC PDUs across LAN Ethernet links. The protocol only exchanges packets between ports you configure as LACP-capable.

### Modes

A LAG includes three configuration modes—on, active, and passive.

- On** Sets the Channeling mode to Static. The interface acts as a member of the static LAG.
- Active** Sets the interface in the Active Negotiating state. LACP runs on any link that is configured in this mode. A port in Active mode automatically initiates negotiations with other ports by using LACP packets. A port in Active mode can set up a port channel with another port in Active mode or Passive mode.
- Passive** Sets the interface in an Inactive Negotiating state, but LACP runs on the link. A port in Passive mode also responds to negotiation requests (from ports in Active mode). Ports in Passive mode respond to LACP packets. A port in Passive mode cannot set up a LAG with another port in Passive mode.

- There is no dual-membership in static and dynamic LAGs:

- If a physical interface is a part of a static LAG, the `channel-group id mode {active | passive}` command is rejected on that interface.
- If a physical interface is a part of a dynamic LAG, the `channel-group id` command is rejected on that interface.
- You cannot add static and dynamic members to the same LAG.
- There is a difference between the `shutdown` and `no interface port-channel` commands:
  - The `shutdown` command on LAG xyz disables the LAG and retains the user commands.
  - The `no interface port-channel channel-number` command deletes the specified LAG, including a dynamically created LAG. The interfaces restore and are ready for configuration.
- A maximum of 128 port channels with up to 32 members per port channel are allowed.

## Configuration

LACP is enabled globally by default. You can configure aggregated ports with compatible active and passive LACP modes to automatically link them.

1. Configure the system priority in CONFIGURATION mode (1 to 65535; the higher the number, the lower the priority; default 32768).

```
lacp system-priority priority-value
```

2. Configure the LACP port priority in INTERFACE mode (1 to 65535; the higher the number, the lower the priority; default 32768).

```
lacp port-priority priority-value
```

3. Configure the LACP rate in INTERFACE mode (default normal).

```
lacp rate [fast | normal]
```

### Configure LACP

```
OS10(config)# lacp system-priority 65535
OS10(config)# interface range ethernet 1/1/7-1/1/8
OS10(conf-range-eth1/1/7-1/1/8)# lacp port-priority 4096
OS10(conf-range-eth1/1/7-1/1/8)# lacp rate fast
```

### Verify LACP configuration

```
OS10(conf-range-eth1/1/7-1/1/8)# do show running-configuration
...
!
interface ethernet1/1/7
 lacp port-priority 4096
 lacp rate fast
 no shutdown
!
interface ethernet1/1/8
 lacp port-priority 4096
 lacp rate fast
 no shutdown
!
...
```

## Interfaces

Create a LAG, and add LAG member interfaces. By default, all interfaces are in `no shutdown` and `switchport` modes.

1. Create a LAG in CONFIGURATION mode.

```
interface port-channel port-channel number
```

2. Enter INTERFACE mode.

```
interface ethernet node/slot/port[:subport]
```

3. Set the channel group mode to Active in INTERFACE mode.

```
channel-group number mode active
```

### Configure dynamic LAG interfaces

```
OS10(config)# interface port-channel 10
OS10(conf-if-po-10)# exit
OS10(config)# interface ethernet 1/1/10
OS10(conf-if-eth1/1/10)# no switchport
OS10(conf-if-eth1/1/10)# channel-group 10 mode active
OS10(conf-if-eth1/1/10)# exit
OS10(config)# interface ethernet 1/1/11
OS10(conf-if-eth1/1/11)# no switchport
OS10(conf-if-eth1/1/11)# channel-group 10 mode active
```

## Rates

Protocol data units (PDUs) are exchanged between port channel (LAG) interfaces to maintain LACP sessions. PDUs are transmitted at either a slow or fast transmission rate, depending on the LACP timeout value. The configured rate interval is used to check whether the partner link is alive or not. The links are ungrouped if three consecutive LACP PDUs are missed. The timeout value depends on the configured rate interval. If the rate interval is fast, then LACP PDUs are sent once every second. If the rate interval is normal, then the LACP PDUs are sent once every 30 seconds.

By default, the LACP rate is `normal` (long timeout). If you configure a `fast` LACP rate, a short timeout sets.

- Set the LACP rate in CONFIGURATION mode.

```
lacp rate [fast | normal]
```

### Configure LACP timeout

```
OS10(conf-if-eth1/1/29)# lacp rate fast
```

### View port status

```
OS10# show lacp port-channel

Port-channel 41 admin up, oper up, mode lacp
Actor System ID: Priority 32768, Address e4:f0:04:fe:9f:e1
Partner System ID: Priority 4096, Address de:11:de:11:de:11
Actor Admin Key 41, Oper Key 41, Partner Oper Key 41
Fallback: Not configured, Fallback port preemption: Configured, Fallback timeout: 15
seconds
Fallback Port Elected:
LACP LAG ID 41 is an aggregatable link
A - Active LACP, B - Passive LACP, C - Short Timeout, D - Long Timeout
E - Aggregatable Link, F - Individual Link, G - IN_SYNC, H - OUT_OF_SYNC,
I - Collection enabled, J - Collection disabled, K - Distribution enabled,
L - Distribution disabled, M - Partner Defaulted, N - Partner Non-defaulted,
O - Receiver is in expired state, P - Receiver is not in expired state
Port ethernet1/1/14 is Enabled, LACP is enabled and mode is lacp
Actor Admin: State BCFHJKNO Key 20 Priority 32768
Oper: State BDEGIKNO Key 20 Priority 32768
Partner Admin: State BCEGIKNP Key 0 Priority 0
Oper: State BDEGIKNO Key 10 Priority 32768
Port ethernet1/1/16 is Enabled, LACP is enabled and mode is lacp
Actor Admin: State BCFHJKNO Key 20 Priority 32768
Oper: State BDEGIKNO Key 20 Priority 32768
Partner Admin: State BCEGIKNP Key 0 Priority 0
Oper: State BDEGIKNO Key 10 Priority 32768
```



## Sample configuration

This sample topology is based on two routers—Alpha and Bravo.

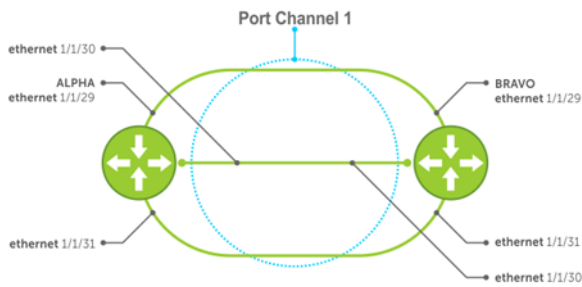

### Alpha LAG configuration summary

```
OS10(config)# interface port-channel 1
OS10(config-if-po-1)# exit
OS10(config)# interface ethernet 1/1/29
OS10(config-if-eth1/1/29)# no switchport
OS10(config-if-eth1/1/29)# channel-group 1 mode active
OS10(config-if-eth1/1/29)# interface ethernet 1/1/30
OS10(config-if-eth1/1/30)# no switchport
OS10(config-if-eth1/1/30)# channel-group 1 mode active
OS10(config-if-eth1/1/30)# interface ethernet 1/1/31
OS10(config-if-eth1/1/31)# no switchport
OS10(config-if-eth1/1/31)# channel-group 1 mode active
```

### Bravo LAG configuration summary

```
OS10(config)# interface port-channel 1
OS10(config-if-po-1)# exit
OS10(config)# interface ethernet 1/1/29
OS10(config-if-eth1/1/29)# no switchport
OS10(config-if-eth1/1/29)# channel-group 1 mode active
OS10(config-if-eth1/1/29)# interface ethernet 1/1/30
OS10(config-if-eth1/1/30)# no switchport
OS10(config-if-eth1/1/30)# channel-group 1 mode active
OS10(config-if-eth1/1/30)# interface ethernet 1/1/31
OS10(config-if-eth1/1/31)# no switchport
OS10(config-if-eth1/1/31)# channel-group 1 mode active
```

### Alpha verify LAG port configuration

```
OS10# show lacp port-channel

Port-channel 41 admin up, oper up, mode lacp
Actor System ID: Priority 32768, Address e4:f0:04:fe:9f:e1
Partner System ID: Priority 4096, Address de:11:de:11:de:11
Actor Admin Key 41, Oper Key 41, Partner Oper Key 41
Fallback: Not configured, Fallback port preemption: Configured, Fallback timeout: 15
seconds
Fallback Port Elected:
LAG ID 41 is an aggregatable link
A - Active LACP, B - Passive LACP, C - Short Timeout, D - Long Timeout
E - Aggregatable Link, F - Individual Link, G - IN_SYNC, H - OUT_OF_SYNC,
I - Collection enabled, J - Collection disabled, K - Distribution enabled,
L - Distribution disabled, M - Partner Defaulted, N - Partner Non-defaulted,
O - Receiver is in expired state, P - Receiver is not in expired state
Port ethernet1/1/29 is Enabled, LACP is enabled and mode is lacp
Actor Admin: State BCFHJKNO Key 1 Priority 32768
Oper: State BDEGIKNO Key 1 Priority 32768
Partner Admin: State BCEGIKNP Key 0 Priority 0
Oper: State BDEGIKNO Key 1 Priority 32768
Port ethernet1/1/30 is Enabled, LACP is enabled and mode is lacp
Actor Admin: State BCFHJKNO Key 1 Priority 32768
```

```
Oper: State BDEGIKNO Key 1 Priority 32768
Partner Admin: State BCEGIKNP Key 0 Priority 0
Oper: State BDEGIKNO Key 1 Priority 32768
Port ethernet1/1/31 is Enabled, LACP is enabled and mode is lacp
Actor Admin: State BCFHJKNO Key 1 Priority 32768
Oper: State BDEGIKNO Key 1 Priority 32768
Partner Admin: State BCEGIKNP Key 0 Priority 0
Oper: State BDEGIKNO Key 1 Priority 32768
```

### Bravo verify LAG port configuration

```
OS10# show interface ethernet 1/1/29

Ethernet 1/1/1 is up, line protocol is up
Port is part of Port-channel 51
Hardware is Eth, address is 14:18:77:16:87:69
Current address is 14:18:77:16:87:69
Pluggable media present, SFP+ type is SFP+ 10GBASE-CR-1.0M
Wavelength is 256
Interface index is 13
Internet address is not set
Mode of IPv4 Address Assignment: not set
Interface IPv6 oper status: Disabled
MTU 1532 bytes, IP MTU 1500 bytes
LineSpeed 10G, Auto-Negotiation off
Flowcontrol rx on tx off
ARP type: ARPA, ARP Timeout: 60
Last clearing of "show interface" counters: 1 weeks 2 days 17:28:08
Queuing strategy: fifo
Input statistics:
 15106397000 packets, 11528982238100 octets
 3060849 64-byte pkts, 14861427 over 64-byte pkts, 1517469049 over 127-byte pkts
 3034145980 over 255-byte pkts, 6068398147 over 511-byte pkts, 4.468461548e+09 over
1023-byte pkts
 8264551355 Multicasts, 58222 Broadcasts, 6841787421 Unicasts
 0 runts, 0 giants, 0 throttles
 0 CRC, 0 overrun, 0 discarded
Output statistics:
 17635407286 packets, 13466675848151 octets
 227562 64-byte pkts, 9344941 over 64-byte pkts, 1772495308 over 127-byte pkts
 3544631784 over 255-byte pkts, 7088975548 over 511-byte pkts, 5.219732143e+09 over
1023-byte pkts
 9178766150 Multicasts, 23987 Broadcasts, 8456617151 Unicasts
 0 throttles, 699052 discarded, 0 Collisions, wred drops
Rate Info(interval 30 seconds):
Input 118 Mbits/sec, 18840 packets/sec, 1% of line rate
Output 118 Mbits/sec, 18869 packets/sec, 1% of line rate
Time since last interface status change: 2 days 17:52:58
```

### Verify LAG 1

```
OS10# show interface port-channel 1

Port-channel 51 is up, line protocol is up
Address is 14:18:77:16:87:9c, Current address is 14:18:77:16:87:9c
Interface index is 49
Internet address is not set
Mode of IPv4 Address Assignment: not set
Interface IPv6 oper status: Disabled
MTU 1532 bytes, IP MTU 1500 bytes
LineSpeed 160G
Minimum number of links to bring Port-channel up is 1
Maximum active members that are allowed in the portchannel is 32
Members in this channel: Eth 1/1/1-1/1/8,1/1/25:1-1/1/25:4,
 1/1/26:1-
 1/1/26:4
ARP type: ARPA, ARP Timeout: 60
Last clearing of "show interface" counters: 1 weeks 2 days 17:29:26
Queuing strategy: fifo
Input statistics:
 364901496976 packets, 278652802328510 octets
 42975359 64-byte pkts, 148695530 over 64-byte pkts, 36673423689 over 127-byte pkts
```

```

73342977260 over 255-byte pkts, 146685062757 over 511-byte pkts, 1.08008362381e+11
over 1023-byte pkts
226014744592 Multicasts, 1748572 Broadcasts, 138885003719 Unicasts
0 runts, 0 giants, 0 throttles
0 CRC, 0 overrun, 0 discarded
Output statistics:
296360281011 packets, 226358952945618 octets
3524494 64-byte pkts, 82594679 over 64-byte pkts, 29792079210 over 127-byte pkts
59581169090 over 255-byte pkts, 119160073632 over 511-byte pkts, 8.7740839906e+10
over 1023-byte pkts
157108504268 Multicasts, 244622 Broadcasts, 139251532180 Unicasts
0 throttles, 1598455 discarded, 0 Collisions, wred drops
Rate Info(interval 30 seconds):
Input 3028 Mbits/sec, 483023 packets/sec, 1% of line rate
Output 1992 Mbits/sec, 317768 packets/sec, 1% of line rate
Time since last interface status change: 2 days 17:54:56

```

### Verify LAG status

```

OS10# show lacp port-channel

Port-channel 51 is up, line protocol is up
Address is 14:18:77:16:87:9c, Current address is 14:18:77:16:87:9c
Interface index is 49
Internet address is not set
Mode of IPv4 Address Assignment: not set
Interface IPv6 oper status: Disabled
MTU 1532 bytes, IP MTU 1500 bytes
LineSpeed 160G
Minimum number of links to bring Port-channel up is 1
Maximum active members that are allowed in the portchannel is 32
Members in this channel: Eth 1/1/1-1/1/8,1/1/25:1-1/1/25:4,
1/1/26:1-
1/1/26:4
ARP type: ARPA, ARP Timeout: 60
Last clearing of "show interface" counters: 1 weeks 2 days 17:29:26
Queuing strategy: fifo
Input statistics:
364901496976 packets, 278652802328510 octets
42975359 64-byte pkts, 148695530 over 64-byte pkts, 36673423689 over 127-byte pkts
73342977260 over 255-byte pkts, 146685062757 over 511-byte pkts, 1.08008362381e+11
over 1023-byte pkts
226014744592 Multicasts, 1748572 Broadcasts, 138885003719 Unicasts
0 runts, 0 giants, 0 throttles
0 CRC, 0 overrun, 0 discarded
Output statistics:
296360281011 packets, 226358952945618 octets
3524494 64-byte pkts, 82594679 over 64-byte pkts, 29792079210 over 127-byte pkts
59581169090 over 255-byte pkts, 119160073632 over 511-byte pkts, 8.7740839906e+10
over 1023-byte pkts
157108504268 Multicasts, 244622 Broadcasts, 139251532180 Unicasts
0 throttles, 1598455 discarded, 0 Collisions, wred drops
Rate Info(interval 30 seconds):
Input 3028 Mbits/sec, 483023 packets/sec, 1% of line rate
Output 1992 Mbits/sec, 317768 packets/sec, 1% of line rate
Time since last interface status change: 2 days 17:54:56

```

### Verify LAG membership

```

OS10# show lacp interface ethernet 1/1/29

Interface ethernet1/1/1 is up
Channel group is 51 port channel is 51
PDUS sent: 27913
PDUS rcvd: 27882
Marker sent: 0
Marker rcvd: 0
Marker response sent: 0
Marker response rcvd: 0
Unknown packetse rcvd: 0
Illegal packetse rcvd: 0
Local Port: 1176 MAC Address=14:18:77:16:87:68

```

```

System Identifier=32768,14:18:77:16:87:68
Port Identifier=32768,1176
Operational key=51
LACP_Activity=active
LACP_Timeout=Long Timeout(30s)
Synchronization=IN_SYNC
Collecting=true
Distributing=true
Partner information refresh timeout=Long Timeout(90s)
Actor Admin State=ADEHJLMP
Actor Oper State=ADEGIKNP
Neighbor: 33
MAC Address=f0:ce:10:f0:ce:10
System Identifier=4096,f0:ce:10:f0:ce:10
Port Identifier=32768,33
Operational key=51
LACP_Activity=active
LACP_Timeout=Long Timeout(30s)
Synchronization=IN_SYNC
Collecting=true
Distributing=true
Partner Admin State=BDEGIKMP
Partner Oper State=ADEGIKNP

```

## LACP fallback

LACP fallback allows downstream devices, like servers which are connected to ports of a switch configured as LACP, to establish a link when the system is not able to finalize the LACP handshake.

For example, when servers boot in PXE mode, the server cannot exchange LACP PDUs and the switch does not enable the ports.

Whenever a PXE server reboots, both the port channel and ports go down. While rebooting, the ports come up, but not the port channel. LACP fallback enables the port-channel to be up and keeps sending packets to the PXE server.

When you enable LACP fallback, the switch starts a timer. If the timer expires before LACP completes, then the switch selects one port of the port group and makes it operational.

You can set the timer using the `lACP fallback timeout timer-value` command.

The LACP fallback feature adds a member port to LACP port channel if it does not receive LACP PDUs from the peer for a particular period.

The server uses the fallback port to finalize the PXE-boot process. When the server starts with the operating system, the process completes the LACP handshake and the fallback port reunites the other members. The member port becomes active and sends packets to the PXE server.

When the switch starts receiving LACP PDU, OS10 ungroups the statically added member port from LACP port channel and resumes with normal LACP functionality.

When you enable LACP fallback, the port that comes up is selected based on the following:

- LACP port priority configuration allows deterministic port allocation. The port with the least priority is placed in the active state when a port channel is in LACP fallback mode.
- If all the ports in a port channel have same port priority, the switch internally compares the interface names by base name, module number, port number, and then selects the lowest one to be active. For example, ethernet 1/1/1 is less than ethernet 1/1/2 and hence Ethernet 1 becomes active.
- In a VLT network, if the interface name is the same on both the VLT peers, then the port in switch with lower system MAC address becomes active.

If you do not enable LACP fallback in one of the VLT peers, or configure different time-out values in the peers, then the switch might behave differently.

### Limitations

- OS10 switches cannot be a PXE client irrespective of whether it acts as a VLT peer or ToR switch.
- If you are configuring LACP fallback in a VLT domain, configure `lACP fallback` commands in both the VLT peers.
- The LACP fallback feature adds or groups a member port to the port channel only when the switch does not receive LACP PDUs from the peer, to make the link that is connected to the PXE client device as operational. As PXE clients handle untagged DHCP request, you need to configure the LACP fallback only on an untagged VLAN to reach the DHCP/PXE server.

- After the LACP fallback election, if a port with lower priority port is configured to be part of the same port channel, it would trigger reelection.

## Configure LACP fallback

1. Enable LACP fallback with the `lacp fallback enable` command in port channel INTERFACE mode.
2. Set a timer for receiving LACP PDUs using `lacp fallback timeout timer-value` in port channel INTERFACE mode.
3. (Optional) Enable or disable LACP fallback port preemption using `lacp fallback preemption {enable | disable}` in port channel INTERFACE mode.

### Example configuration

```
OS10# configure terminal
OS10(config)# interface port-channel 1
OS10(conf-if-po-1)# lacp fallback enable
OS10(conf-if-po-1)# lacp fallback timeout 20
OS10(conf-if-po-1)# lacp fallback preemption enable
```

### View LACP fallback configuration

```
OS10# show port-channel summary
```

```
Flags: D - Down I - member up but inactive P - member up and active
 U - Up (port-channel) F - Fallback enabled
```

| Group | Port-Channel  | Type     | Protocol | Member Ports          |
|-------|---------------|----------|----------|-----------------------|
| 1     | port-channell | (UF) Eth | DYNAMIC  | 1/1/10 (P) 1/1/11 (I) |

## LACP fallback in non-VLT network

In a non-VLT network, LACP fallback enables rebooting of ToR or server that is connected to the switch through normal LACP. The other end of the switch is connected to a DHCP/PXE server, as shown in the following figure:

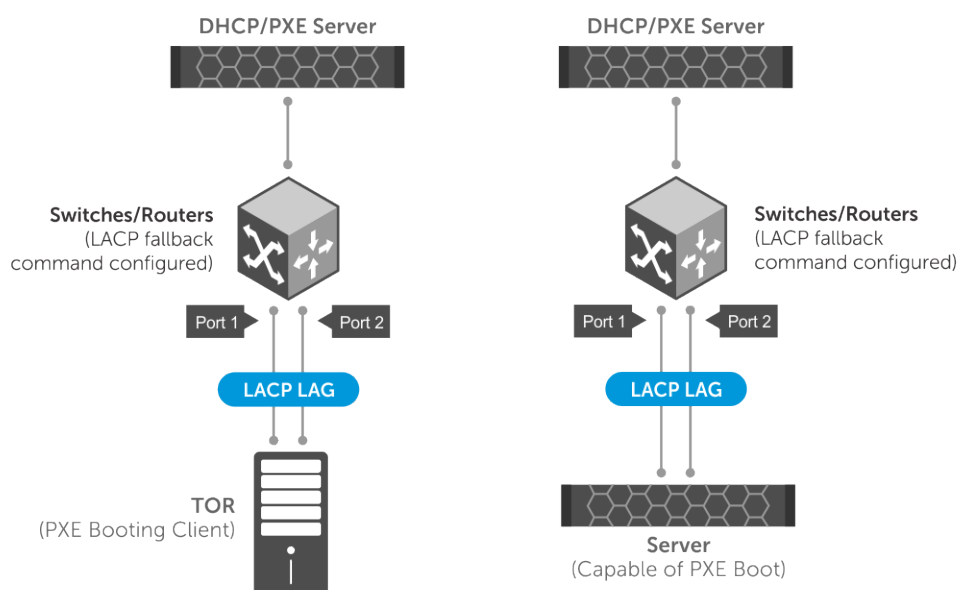

In the above scenario, LACP fallback works as follows:

1. The ToR/server boots
2. The switch detects the link that is up and checks fallback enabled status. If fallback is enabled, the device waits for the time-out period for any LACP BPDUs. If there are no LACP BPDUs received within the time period, then the LAG enters into fallback mode and adds the first operationally UP port to the port channel instead of placing it in an inactive state.
3. Now the ToR/server has one port up and active. The active port sends packets to the DHCP/PXE server.
4. After receiving response from the DHCP server, the ToR/server boots from the TFTP/NFS server.
5. When the ToR/server is fully loaded with the boot image and configurations, the server starts sending LACP PDUs.
6. When the switch receives LACP PDUs from ToR/server, the device comes out of the fallback mode and activates the LAG through normal LACP process.

## LACP fallback in VLT domain

In a VLT domain, LACP fallback enables rebooting of ToR or server that is connected to VLT nodes through VLT port channel. The other end of the VLT nodes is connected to a DHCP/PXE server, as shown in the following figure:

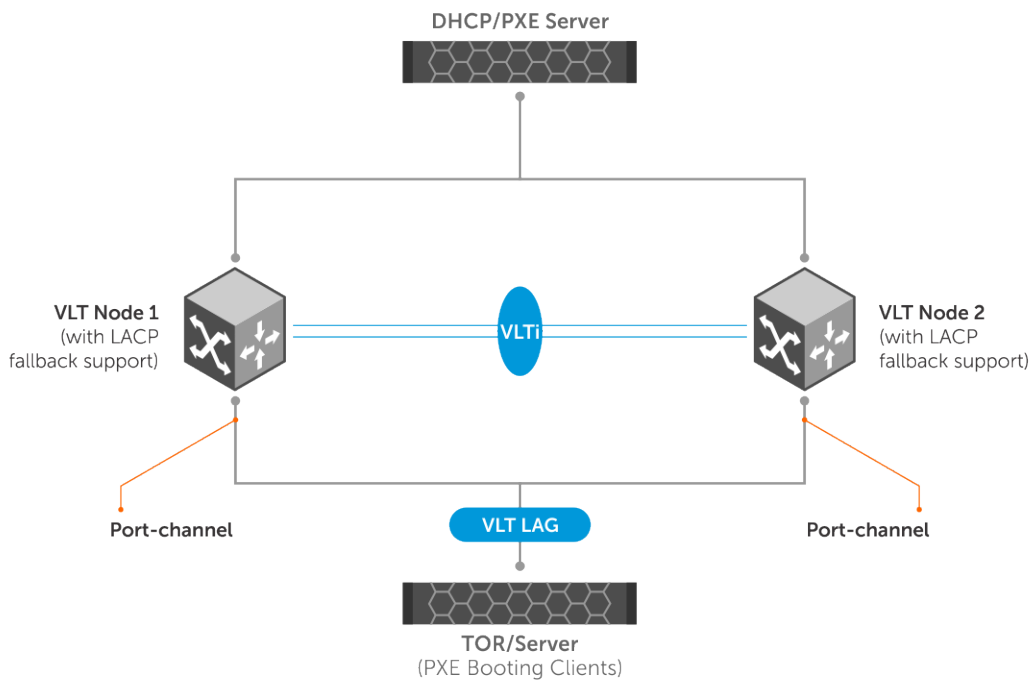

In the above scenario, LACP fallback works as follows:

1. The ToR/server boots
2. One of the VLT peers takes care of controlling the LACP fallback mode. All events are sent to the controlling VLT peer for deciding the port that should be brought up and then the decision is passed on to peer device.
3. The controlling VLT peer can decide to bring up one of the ports in either the local port channel or in the peer VLT port channel.
4. One of the ports, local, or peer, becomes active based on the decision of the controlling VLT peer.
5. Now the ToR/server has one port up and active. The active port sends packets to the DHCP/PXE server.
6. After receiving response from the DHCP server, the ToR/server boots from the TFTP/NFS server.
7. When the ToR/server is fully loaded with the boot image and configurations, the server starts sending LACP PDUs.
8. When the switch receives LACP PDUs from ToR/server, the controlling VLT peer makes the LACP port to come out of the fallback mode and to resume the normal functionality.

# LACP commands

## channel-group

Assigns and configures a physical interface to a port channel group.

|                           |                                                                                                                                                                                                                                                                                                                                                                                                                                                                                                                                                                                                                                                                                                                                                                                                 |
|---------------------------|-------------------------------------------------------------------------------------------------------------------------------------------------------------------------------------------------------------------------------------------------------------------------------------------------------------------------------------------------------------------------------------------------------------------------------------------------------------------------------------------------------------------------------------------------------------------------------------------------------------------------------------------------------------------------------------------------------------------------------------------------------------------------------------------------|
| <b>Syntax</b>             | <code>channel-group <i>number</i> mode {active   on   passive}</code>                                                                                                                                                                                                                                                                                                                                                                                                                                                                                                                                                                                                                                                                                                                           |
| <b>Parameters</b>         | <ul style="list-style-type: none"><li>• <i>number</i> — Enter the port channel group number (1 to 128). The maximum number of port channels is 128.</li><li>• <i>mode</i> — Enter the interface port channel mode.</li><li>• <i>active</i> — Enter to enable the LACP interface. The interface is in the Active Negotiating state when the port starts negotiations with other ports by sending LACP packets.</li><li>• <i>on</i> — Enter so that the interface is not part of a dynamic LAG but acts as a static LAG member.</li><li>• <i>passive</i> — Enter to only enable LACP if it detects a device. The interface is in the Passive Negotiation state when the port responds to the LACP packets that it receives but does not initiate negotiation until it detects a device.</li></ul> |
| <b>Default</b>            | Not configured                                                                                                                                                                                                                                                                                                                                                                                                                                                                                                                                                                                                                                                                                                                                                                                  |
| <b>Command Mode</b>       | INTERFACE                                                                                                                                                                                                                                                                                                                                                                                                                                                                                                                                                                                                                                                                                                                                                                                       |
| <b>Usage Information</b>  | When you delete the last physical interface from a port channel, the port channel remains. Configure these attributes on an individual member port. If you configure a member port with an incompatible attribute, OS10 suspends that port in the port channel. The member ports in a port channel must have the same setting for link speed capability and duplex capability. The <code>no</code> version of this command removes the interface from the port channel.                                                                                                                                                                                                                                                                                                                         |
| <b>Example</b>            | <pre>OS10(config)# interface ethernet 1/1/10 OS10(conf-if-eth1/1/10)# channel-group 10 mode active OS10(conf-if-eth1/1/10)# exit OS10(config)# interface ethernet 1/1/11 OS10(conf-if-eth1/1/11)# channel-group 10 mode active</pre>                                                                                                                                                                                                                                                                                                                                                                                                                                                                                                                                                            |
| <b>Supported Releases</b> | 10.2.0E or later                                                                                                                                                                                                                                                                                                                                                                                                                                                                                                                                                                                                                                                                                                                                                                                |

## clear lacp counters

Clears the statistics for all interfaces for LACP groups.

|                               |                                                                                                                                                                                                                                   |
|-------------------------------|-----------------------------------------------------------------------------------------------------------------------------------------------------------------------------------------------------------------------------------|
| <b>Syntax</b>                 | <code>clear lacp counters [interface port-channel <i>channel-number</i>]</code>                                                                                                                                                   |
| <b>Parameters</b>             | <ul style="list-style-type: none"><li>• <i>interface port channel</i> — (Optional) Enter the interface port channel number.</li><li>• <i>channel-number</i> — (Optional) Enter the LACP port channel number (1 to 128).</li></ul> |
| <b>Default</b>                | Not configured                                                                                                                                                                                                                    |
| <b>Command Mode</b>           | EXEC                                                                                                                                                                                                                              |
| <b>Usage Information</b>      | If you use this command for a static port channel group without enabling the aggregation protocol, the device ignores the command. If you do not enter a port channel number, the LACP counters for all LACP port groups clear.   |
| <b>Example</b>                | <pre>OS10# clear lacp counters</pre>                                                                                                                                                                                              |
| <b>Example (Port-Channel)</b> | <pre>OS10# clear lacp counters interface port-channel 20</pre>                                                                                                                                                                    |
| <b>Supported Releases</b>     | 10.2.0E or later                                                                                                                                                                                                                  |

## lACP fallback enable

Enables LACP fallback mode.

|                          |                                                             |
|--------------------------|-------------------------------------------------------------|
| <b>Syntax</b>            | <code>lACP fallback enable</code>                           |
| <b>Parameters</b>        | None                                                        |
| <b>Default</b>           | Disabled                                                    |
| <b>Command Mode</b>      | Port-channel INTERFACE                                      |
| <b>Usage Information</b> | The no version of this command disables LACP fallback mode. |

### Example

```
OS10# configure terminal
OS10(config)# interface port-channel 1
OS10(conf-if-po-1)# lACP fallback enable
```

|                           |                      |
|---------------------------|----------------------|
| <b>Supported Releases</b> | 10.3.2E(R3) or later |
|---------------------------|----------------------|

## lACP fallback preemption

Enables or disables LACP fallback port preemption.

|                          |                                                                                                                                                                                                                                                                                                                                                                                                                                                                                                                                                                                                                                                                                                                                                                             |
|--------------------------|-----------------------------------------------------------------------------------------------------------------------------------------------------------------------------------------------------------------------------------------------------------------------------------------------------------------------------------------------------------------------------------------------------------------------------------------------------------------------------------------------------------------------------------------------------------------------------------------------------------------------------------------------------------------------------------------------------------------------------------------------------------------------------|
| <b>Syntax</b>            | <code>lACP fallback preemption {enable   disable}</code>                                                                                                                                                                                                                                                                                                                                                                                                                                                                                                                                                                                                                                                                                                                    |
| <b>Parameters</b>        | <ul style="list-style-type: none"><li>• <code>enable</code>—Enables preemption on the port channel.</li><li>• <code>disable</code>—Disables preemption on the port channel.</li></ul>                                                                                                                                                                                                                                                                                                                                                                                                                                                                                                                                                                                       |
| <b>Default</b>           | Enabled                                                                                                                                                                                                                                                                                                                                                                                                                                                                                                                                                                                                                                                                                                                                                                     |
| <b>Command Mode</b>      | Port-channel INTERFACE                                                                                                                                                                                                                                                                                                                                                                                                                                                                                                                                                                                                                                                                                                                                                      |
| <b>Usage Information</b> | <p>When you enable preemption, the fallback port election preempts the already elected fallback port and elects a new fallback port.</p> <p>The new port is elected based on the following events:</p> <ul style="list-style-type: none"><li>• When a nonfallback port is configured with low priority.</li><li>• When a low-priority port becomes operationally UP.</li><li>• When a port with the least numbering is operationally UP.</li><li>• If nondefault LACP port priority is configured on a port even though preemption is disabled, a port with the lowest priority is elected as fallback port,</li><li>• The <code>lACP fallback preemption disable</code> command is not applicable on port priority events that you have configured or triggered.</li></ul> |

### Example

```
OS10# configure terminal
OS10(config)# interface port-channel 1
OS10(conf-if-po-1)# lACP fallback preemption enable
```

```
OS10# configure terminal
OS10(config)# interface port-channel 1
OS10(conf-if-po-1)# lACP fallback preemption disable
```

|                           |                   |
|---------------------------|-------------------|
| <b>Supported Releases</b> | 10.4.1.0 or later |
|---------------------------|-------------------|



## lacp fallback timeout

Configures LACP fallback time-out period.

|                          |                                                                                       |
|--------------------------|---------------------------------------------------------------------------------------|
| <b>Syntax</b>            | <code>lacp fallback timeout <i>timer-value</i></code>                                 |
| <b>Parameters</b>        | <i>timer-value</i> —Enter the timer values in seconds, ranging from 0 to 100 seconds. |
| <b>Default</b>           | 15 seconds                                                                            |
| <b>Command Mode</b>      | Port-channel INTERFACE                                                                |
| <b>Usage Information</b> | The <code>no</code> version of this command returns the timer to default value.       |

### Example

```
OS10# configure terminal
OS10(config)# interface port-channel 1
OS10(conf-if-po-1)# lacp fallback timeout 20
```

**Supported Releases** 10.3.2E(R3) or later

## lacp max-bundle

Configures the maximum number of active members that are allowed in a port channel.

|                          |                                                                                                  |
|--------------------------|--------------------------------------------------------------------------------------------------|
| <b>Syntax</b>            | <code>lacp max-bundle <i>max-bundle-number</i></code>                                            |
| <b>Parameters</b>        | <i>max-bundle-number</i> — Enter the maximum bundle size (1 to 32).                              |
| <b>Default</b>           | 32                                                                                               |
| <b>Command Mode</b>      | INTERFACE                                                                                        |
| <b>Usage Information</b> | The <code>no</code> version of this command resets the maximum bundle size to the default value. |

### Example

```
OS10(conf-if-po-10)# lacp max-bundle 10
```

**Supported Releases** 10.2.0E or later

## Lacp port-priority

Sets the priority for the physical interfaces for LACP.

|                          |                                                                                                                                                                                                                                                                                                                                                                                                                                                                           |
|--------------------------|---------------------------------------------------------------------------------------------------------------------------------------------------------------------------------------------------------------------------------------------------------------------------------------------------------------------------------------------------------------------------------------------------------------------------------------------------------------------------|
| <b>Syntax</b>            | <code>lacp port-priority <i>priority</i></code>                                                                                                                                                                                                                                                                                                                                                                                                                           |
| <b>Parameters</b>        | <i>priority</i> — Enter the priority for the physical interfaces (0 to 65535).                                                                                                                                                                                                                                                                                                                                                                                            |
| <b>Default</b>           | 32768                                                                                                                                                                                                                                                                                                                                                                                                                                                                     |
| <b>Command Mode</b>      | INTERFACE                                                                                                                                                                                                                                                                                                                                                                                                                                                                 |
| <b>Usage Information</b> | LACP uses the port priority with the port number to create the port identifier. The port priority decides which ports are put into Standby mode when there is a hardware limitation that prevents all compatible ports from aggregating, or when you have up to 32 ports configured for the channel group. When setting the priority, a higher number means a lower priority. The <code>no</code> version of this command returns the port priority to the default value. |

### Example

```
OS10(conf-range-eth1/1/7-1/1/8)# lacp port-priority 32768
```

**Supported Releases** 10.2.0E or later

## lacp rate

Sets the rate at which LACP sends control packets.

**Syntax** `lacp rate {fast | normal}`

- Parameters**
- `fast` — Enter the fast rate of 1 second.
  - `normal` — Enter the default rate of 30 seconds.

**Default** 30 seconds

**Command Mode** INTERFACE

**Usage Information** Change the LACP timer rate to modify the duration of the LACP timeout. The `no` version of this command resets the rate to the default value.

**Example**

```
OS10(conf-range-eth1/1/7-1/1/8)# lacp rate fast
```

**Supported Releases** 10.2.0E or later

## lacp system-priority

Sets the system priority of the device for LACP.

**Parameters** `priority` — Enter the priority value for physical interfaces (0 to 65535).

**Default** 32768

**Command Mode** CONFIGURATION

**Usage Information** Each device that runs LACP has an LACP system priority value. LACP uses the system priority with the MAC address to form the system ID and also during negotiation with other systems. The system ID is unique for each device. The `no` version of this command resets the system priority to the default value.

**Example**

```
OS10(config)# lacp system-priority 32768
```

**Supported Releases** 10.2.0E or later

## show lacp counter

Displays information about LACP statistics.

**Syntax** `show lacp counter [interface port-channel channel-number]`

- Parameters**
- `interface port channel` — (Optional) Enter the interface port-channel.
  - `channel-number` — (Optional) Enter the LACP channel group number (1 to 128).

**Default** Not configured

**Command Mode** EXEC

**Usage Information** If you do not enter the `channel-number` parameter, all channel groups display.

**Example**

```
OS10# show lacp counter interface port-channel 11
LACPDU's Port Marker Marker Response LACPDU's
----- Sent Recv Sent Recv Sent Recv Err Pkts

ethernet1/1/1:1 0 0 0 0 7950 7948 0
ethernet1/1/2:1 0 0 0 0 7950 7948 0
ethernet1/1/3:1 0 0 0 0 7950 7948 0
ethernet1/1/4:1 0 0 0 0 7950 7948 0
```

|                  |   |   |   |   |      |      |   |
|------------------|---|---|---|---|------|------|---|
| ethernet1/1/5:1  | 0 | 0 | 0 | 0 | 7950 | 7948 | 0 |
| ethernet1/1/6:1  | 0 | 0 | 0 | 0 | 7950 | 7948 | 0 |
| ethernet1/1/7:1  | 0 | 0 | 0 | 0 | 7950 | 7948 | 0 |
| ethernet1/1/8:1  | 0 | 0 | 0 | 0 | 7950 | 7948 | 0 |
| ethernet1/1/9:1  | 0 | 0 | 0 | 0 | 7967 | 7961 | 0 |
| ethernet1/1/10:1 | 0 | 0 | 0 | 0 | 7967 | 7961 | 0 |
| ethernet1/1/11:1 | 0 | 0 |   |   |      |      |   |

**Supported Releases** 10.2.0E or later

## show lacp interface

Displays information about specific LACP interfaces.

**Syntax** `show lacp interface ethernet node/slot/port`

**Parameters** `node/slot/port` — Enter the interface information.

**Default** Not configured

**Command Mode** EXEC

**Usage Information** The *LACP\_activity* field displays if you configure the link in Active or Passive port channel mode. The *Port Identifier* field displays the port priority as part of the information including the port number. For example, Port Identifier=0x8000,0x101, where the port priority value is 0x8000 and the port number value is 0x101.

### Example

```
OS10# show lacp interface ethernet 1/1/129
Invalid Port id, Max. Port Id is: 32
OS10# show lacp interface ethernet 1/1/29

Interface ethernet1/1/1 is up
Channel group is 51 port channel is 51
PDUS sent: 27913
PDUS rcvd: 27882
Marker sent: 0
Marker rcvd: 0
Marker response sent: 0
Marker response rcvd: 0
Unknown packetse rcvd: 0
Illegal packetse rcvd: 0
Local Port: 1176 MAC Address=14:18:77:16:87:68
System Identifier=32768,14:18:77:16:87:68
Port Identifier=32768,1176
Operational key=51
LACP_Activity=active
LACP_Timeout=Long Timeout(30s)
Synchronization=IN_SYNC
Collecting=true
Distributing=true
Partner information refresh timeout=Long Timeout(90s)
Actor Admin State=ADEHJLMP
Actor Oper State=ADEGIKNP
Neighbor: 33
MAC Address=f0:ce:10:f0:ce:10
System Identifier=4096,f0:ce:10:f0:ce:10
Port Identifier=32768,33
Operational key=51
LACP_Activity=active
LACP_Timeout=Long Timeout(30s)
Synchronization=IN_SYNC
Collecting=true
Distributing=true
Partner Admin State=BDEGIKMP
Partner Oper State=ADEGIKNP
```

**Supported Releases** 10.2.0E or later

## show lacp neighbor

Displays information about LACP neighbors.

**Syntax** show lacp neighbor [interface port-channel *channel-number*]

**Parameters**

- *interface port channel* — (Optional) Enter the interface port-channel.
- *channel-number* — (Optional) Enter the port channel number for the LACP neighbor (1 to 128).

**Default** Not configured

**Command Mode** EXEC

**Usage Information** If you do not enter the *channel-number* parameter, all channel groups display .

### Example

```
OS10# show lacp neighbor interface port-channel 1

Flags:S-Device is sending Slow LACPDUs F-Device is sending Fast LACPdus
 A-Device is in Active mode P-Device is in Passive mode
Port-channel port-channell neighbors
Port: ethernet1/1/29
Partner System Priority: 32768
Partner System ID: 00:01:e8:8a:fd:9e
Partner Port: 178
Partner Port Priority: 32768
Partner Oper Key: 1
Partner Oper State:aggregation synchronization collecting distributing
defaulted expired
```

**Supported Releases** 10.2.0E or later

## show lacp port channel

Displays information about LACP port channels.

**Syntax** show lacp port-channel [interface port-channel *channel-number*]

**Parameters**

- *interface port channel* — (Optional) Enter the interface port-channel.
- *channel-number* — (Optional) Enter the port channel number for the LACP neighbor (1 to 128).

**Default** Not configured

**Command Mode** EXEC

**Usage Information** All channel groups display if you do not enter the *channel-number* parameter.

### Example

```
OS10# show lacp port-channel 1

Port-channel 1 admin up, oper up, mode lacp
Actor System ID: Priority 32768, Address 90:b1:1c:f4:9b:8a
Partner System ID: Priority 32768, Address 00:01:e8:8a:fd:9e
Actor Admin Key 1, Oper Key 1, Partner Oper Key 1
LACP LAG ID 1 is an aggregatable link
A-Active LACP, B-Passive LACP, C-Short Timeout, D-Long Timeout
E-Aggregatable Link, F-Individual Link, G-IN_SYNC, H-OUT_OF_SYNC,
I-Collection enabled, J-Collection disabled, K-Distribution enabled,
L-Distribution disabled, M-Partner Defaulted, N-Partner Non-defaulted,
O-Receiver is in expired state, P-Receiver is not in expired state
Port ethernet1/1/29 is Enabled, LACP is enabled and mode is lacp
```

```
Actor Admin: State BCFHJKNO Key 1 Priority 32768
 Oper: State BDEGIKNO Key 1 Priority 32768
Partner Admin: State BCEGIKNP Key 0 Priority 0
 Oper: State BDEGIKMO Key 1 Priority 32768
```

**Supported Releases** 10.2.0E or later

## show lacp system-identifier

Displays the LACP system identifier for a device.

**Syntax** `show lacp system-identifier`

**Parameters** None

**Default** Not configured

**Command Mode** EXEC

**Usage Information** The LACP system ID is a combination of the configurable LACP system priority value and the MAC address. Each system that runs LACP has an LACP system priority value. Configure a value between 1 and 65535. The default value is 32768. LACP uses the system priority with the MAC address to form the system ID and uses the system priority during negotiation with other devices. A higher system priority value means a lower priority. The system ID is different for each device.

### Example

```
OS10# show lacp system-identifier

Actor System ID: Priority 32768, Address 90:b1:1c:f4:9b:8a
```

**Supported Releases** 10.2.0E or later

## Link Layer Discovery Protocol

Dell EMC SmartFabric OS10 supports:

- Link Layer Discovery protocol (LLDP)
- Link Layer Discovery Protocol — Media Endpoint Discovery (LLDP-MED)

LLDP is a one-way protocol that enables network devices on a local area network (LAN) to discover and advertise its capabilities to adjacent LAN devices. LLDP devices advertise its capabilities in the form of LLDP data units (LLDPDUs).

LLDP-MED is an LLDP enhancement that enables endpoint devices and network connected devices to advertise their characteristics and configuration information.

LLDP-MED network connected devices such as switches provide access to the IEEE 802-based LAN infrastructure for LLDP-MED endpoint devices, such as IP phones. OS10 switch acts as an LLDP-MED network connected device.

- By default, LLDP and LLDP-MED are enabled on the interfaces.
  -  **NOTE:** You cannot configure LLDP-MED on the management interface.
- An LLDP-enabled interface supports up to eight neighbors. OS10 switch supports a maximum of 250 neighbors per system.
- OS10 switches periodically transmit LLDPDUs. The default transmission interval is 30 seconds.
- OS10 switches receive LLDPDU information from a neighbor. The information expires after a specific amount of time, called time to live (TTL). The default TTL value is 120 seconds.
- OS10 switches allow LLDPDUs in spanning-tree blocked ports.
- OS10 switches do not allow LLDPDUs in 802.1X-controlled ports until the connected device is authenticated.

LLDPDU is a sequence of type, length, and value (TLV).

- Type — Contains the TLV type.
- Length — Size of the value field, in bytes.
- Value — Contains the capability information of the device to be advertised.

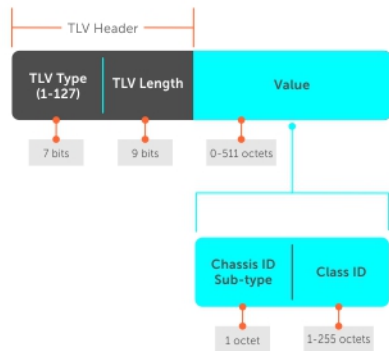

LLDPDU's include mandatory and optional TLVs. Each LLDPDU starts with three mandatory TLVs, zero or more optional TLVs, and end of LLDPDU TLV.

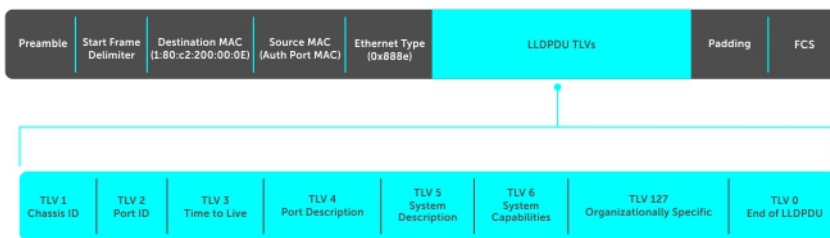

## Mandatory TLVs

OS10 supports the three mandatory TLVs. These mandatory TLVs are at the beginning of the LLDPDU in the following order:

- Chassis ID TLV
- Port ID TLV
- Time-to-live TLV

**Table 24. Mandatory TLVs**

| Mandatory TLVs | Type | Description                                                              |
|----------------|------|--------------------------------------------------------------------------|
| Chassis ID     | 1    | Identifies the chassis.                                                  |
| Port ID        | 2    | Identifies a port through which the LAN device transmits LLDPDU's.       |
| Time-to-live   | 3    | Number of seconds that the received information in this LLDPDU is valid. |
| End of LLDPDU  | 0    | Marks the end of an LLDPDU.                                              |

## Optional TLVs

Optional TLVs include:

- Basic TLVs
- Organizationally specific TLVs
- Custom TLVs



**NOTE:** The maximum size of the LLDPDU supported on the transmission side is 1500 bytes. If the size of the TLVs that are transmitted exceeds 1500 bytes when adding one optional TLV of a particular type, the complete optional TLVs of that type are removed and only the optional TLVs that fit the maximum supported size are allowed.

## Basic TLVs

**Table 25. Basic TLVs**

| TLV                 | Type | Description                                                                                                                                                                                                 |
|---------------------|------|-------------------------------------------------------------------------------------------------------------------------------------------------------------------------------------------------------------|
| Port description    | 4    | User-defined alphanumeric string that describes the port (port ID or interface description).                                                                                                                |
| System name         | 5    | User-defined alphanumeric string that identifies the system.                                                                                                                                                |
| System description  | 6    | Includes the following information: <ul style="list-style-type: none"> <li>• Host description</li> <li>• Dell OS version</li> <li>• Dell application software version</li> <li>• Build timestamp</li> </ul> |
| System capabilities | 7    | Determines the capabilities of the system.                                                                                                                                                                  |
| Management address  | 8    | Network address of the management interface.                                                                                                                                                                |

## Organizationally specific TLVs

**Table 26. 802.1x organizationally specific TLVs (Type – 127, OUI – 00-80-C2)**

| TLV               | Subtype | Description                                                                                                                                                                                                   |
|-------------------|---------|---------------------------------------------------------------------------------------------------------------------------------------------------------------------------------------------------------------|
| Link aggregation  | 7       | <ul style="list-style-type: none"> <li>• Indicates whether the link associated with the port on which the LLDPDU is transmitted is aggregated.</li> <li>• Provides the aggregated port identifier.</li> </ul> |
| Port VLAN ID      | 1       | Untagged VLAN to which a port belongs.                                                                                                                                                                        |
| Protocol identity | 4       | Not supported.                                                                                                                                                                                                |
| VLAN name         | 3       | Allows an IEEE 802.1Q-compatible device to advertise the assigned name of any VLAN with which it is configured. <p><b>NOTE:</b> By default, VLAN name TLV will be disabled.</p>                               |

**Table 27. 802.3 organizationally-specific TLVs (Type – 127, OUI – 00-12-0F)**

| TLV                          | Subtype | Description                                                                                                                                                       |
|------------------------------|---------|-------------------------------------------------------------------------------------------------------------------------------------------------------------------|
| MAC/PHY configuration/status | 1       | Indicates: <ul style="list-style-type: none"> <li>• Duplex and bit rate capability and the current duplex and bit rate settings of the sending device.</li> </ul> |

**Table 27. 802.3 organizationally-specific TLVs (Type – 127, OUI – 00-12-0F) (continued)**

| TLV                | Subtype | Description                                                                                                                         |
|--------------------|---------|-------------------------------------------------------------------------------------------------------------------------------------|
|                    |         | <ul style="list-style-type: none"> <li>Whether the current settings are due to auto-negotiation or manual configuration.</li> </ul> |
| Power through MDI  | 2       | Not supported.                                                                                                                      |
| Maximum frame size | 4       | Maximum frame size capability of the MAC and PHY.                                                                                   |

**Table 28. Service tag TLV (Type – 127, OUI – 0xF8-0xB1-0x56)**

| TLV         | Subtype | Description                                                   |
|-------------|---------|---------------------------------------------------------------|
| Service tag | 21      | Indicates the service tag that is associated with the device. |

**Table 29. Solution ID TLVs (Type – 127, OUI – 0xF8-0xB1-0x56)**

| TLV                   | Subtype | Description                          |
|-----------------------|---------|--------------------------------------|
| Product base          | 22      | Indicates the product base.          |
| Product serial number | 23      | Indicates the product serial number. |
| Product part number   | 24      | Indicates the product part number.   |

## Custom TLVs

### iDRAC organizationally specific TLVs

**Table 30. iDRAC organizationally specific TLVs; Subtypes used in iDRAC custom TLVs (Type – 127, OUI – 0xF8-0xB1-0x56)**

| TLV                 | Subtype | Description                                                                                                                                                              |
|---------------------|---------|--------------------------------------------------------------------------------------------------------------------------------------------------------------------------|
| Originator          | 1       | Indicates the iDRAC string that is used as the originator. This string enables external switches to identify iDRAC LLDPDUs.                                              |
| Port type           | 2       | Following are the applicable port types: <ol style="list-style-type: none"> <li>iDRAC port (dedicated)</li> <li>NIC port</li> <li>iDRAC and NIC port (shared)</li> </ol> |
| Port FQDD           | 3       | Port number that uniquely identifies a NIC port within a server.                                                                                                         |
| Server service tag  | 4       | Service tag ID of the server.                                                                                                                                            |
| Server model name   | 5       | Model name of the server. For example, PowerEdge FC640.                                                                                                                  |
| Server slot number  | 6       | Slot number of the server. For example, 1, 2, 3, 1a, and 1b.                                                                                                             |
| Chassis service tag | 7       | Service tag ID of the chassis. (Applicable only to blade servers.)                                                                                                       |
| Chassis model       | 8       | Model name of the chassis. (Applicable only to blade servers.)                                                                                                           |



**Table 30. iDRAC organizationally specific TLVs; Subtypes used in iDRAC custom TLVs (Type – 127, OUI – 0xF8-0xB1-0x56) (continued)**

| TLV             | Subtype | Description                                                                                       |
|-----------------|---------|---------------------------------------------------------------------------------------------------|
| IOM service tag | 9       | Service tag ID of the IOM device. (Applicable only to blade servers.)                             |
| IOM model name  | 10      | Model name of the IOM device. (Applicable only to blade servers.)                                 |
| IOM slot label  | 11      | Slot label of the IOM device. For example, A1, B1, A2, and B2 (applicable only to blade servers). |
| IOM port number | 12      | Port number of the NIC. For example, 1, 2, and 3.                                                 |

### Isilon organizationally-specific TLVs

**Table 31. Isilon-related TLVs (Type – 127, OUI – 0xF8-0xB1-0x56)**

| TLV                                                                                                     | Subtype | Description                                                                                                                                                                                                                                   |
|---------------------------------------------------------------------------------------------------------|---------|-----------------------------------------------------------------------------------------------------------------------------------------------------------------------------------------------------------------------------------------------|
| <b>Subtypes used in LLDP custom TLVs that are transacted by the Isilon nodes</b>                        |         |                                                                                                                                                                                                                                               |
| Originator                                                                                              | 1       | Indicates the Isilon string that is used as the originator. This string enables the OS10 switches to identify the Isilon originated LLDPDUs.                                                                                                  |
| RA prefix                                                                                               | 2       | Indicates the IPV6 address prefix for SLAAC. Isilon nodes uses this prefix to communicate with the master and the OS10 switch to compute the Virtual IP address for the specific fabric instance. The RA prefix is different for each fabric. |
| Fabric ID                                                                                               | 3       | Indicates the ID of the fabric the LLDPDU is originating from.                                                                                                                                                                                |
| <b>Isilon-related TLVs – Subtypes used in LLDP custom TLVs that are transacted by the OS10 switches</b> |         |                                                                                                                                                                                                                                               |
| Originator                                                                                              | 1       | Indicates the OS10 string that is used as the originator. The string enables the OS10 switches to identify LLDPDUs.                                                                                                                           |
| Role                                                                                                    | 2       | Following are the applicable roles:<br><ol style="list-style-type: none"> <li>1. LEAF</li> <li>2. SPINE</li> <li>3. UNKNOWN</li> </ol>                                                                                                        |
| IP address                                                                                              | 3       | Indicates the IPV6 address of the originator.                                                                                                                                                                                                 |
| Virtual IP address of the fabric                                                                        | 4       | Virtual IP address of the master node. The Isilon nodes can also use this IPV6 address when needed.                                                                                                                                           |
| MAC address of the physical interface                                                                   | 5       | MAC address used by the OS10 switches for ND.                                                                                                                                                                                                 |

## Configure LLDP

Enable LLDP globally or on an interface and advertise the TLVs out of an interface.

## Disable and reenable LLDP

By default, LLDP is enabled globally, on each physical interface, and on management port. You can disable LLDP globally and on an interface. If you disable LLDP globally, LLDP is disabled on all interfaces irrespective of whether LLDP is previously enabled or disabled on an interface. When you enable LLDP globally, the interface-level LLDP configuration takes precedence over the global LLDP configuration.

### Disable LLDP

- Disable LLDP globally in CONFIGURATION mode.

```
OS10(config)# no lldp enable
```

- Disable LLDP on an interface, use the `lldp transmit` and `lldp receive` commands in INTERFACE mode.

```
OS10(config-if-eth1/1/2)# no lldp transmit
OS10(config-if-eth1/1/2)# no lldp receive
```

Management interface:

```
OS10(config-if-ma-1/1/1)# no lldp transmit
OS10(config-if-ma-1/1/1)# no lldp receive
```

### Enable LLDP

When LLDP is disabled on a switch, you can reenable LLDP globally or on an interface.

- To enable LLDP globally:

Enable LLDP globally in CONFIGURATION mode.

```
OS10(config)# lldp enable
```

- To enable LLDP on an interface:

When you enable LLDP globally, it is enabled on all interfaces. You can enable or disable LLDP on individual interfaces to both transmit and receive LLDP information. Also, you can configure an interface to only transmit or receive LLDP information.

Enable LLDP in INTERFACE mode.

```
OS10(config)# interface ethernet 1/1/1
OS10(config-if-eth1/1/1)# lldp transmit
OS10(config-if-eth1/1/1)# lldp receive
```

Management interface:

```
OS10(config)# interface mgmt 1/1/1
OS10(config-if-ma-1/1/1)# lldp transmit
OS10(config-if-ma-1/1/1)# lldp receive
```

## Set the LLDP packet timer values

You can configure LLDP packet timer values for LLDPDU transmission.

### Set the LLDP timer

Configure the rate in seconds at which LLDP packets send to the peers. The default value of the LLDP timer is 30 seconds.

Configure the LLDP packet timer value in CONFIGURATION mode.

```
lldp timer seconds
```

### Set the LLDP reinitialization timer

Change the delay time in seconds for LLDP to initialize on any interface. The default delay timer value is 2 seconds.

Enter the time delay in seconds in CONFIGURATION mode.

```
lldp reinit seconds
```

### Set the multiplier value for the hold time

Configure the multiplier value for the hold time. The system uses the multiple value to calculate the TTL value for the LLDP advertisements. The default holdtime-multiplier value is 4.

Enter the multiplier value for the hold time in CONFIGURATION mode.

```
lldp holdtime-multiplier
```

```
OS10(config)# lldp timer 60
OS10(config)# lldp reinit 5
```

### View LLDP timers

```
OS10# show lldp timers
LLDP Timers:
Holdtime in seconds: 240
Reinit-time in seconds: 5
Transmit interval in seconds: 60
```

## Time to live

TTL or hold time is the amount of time, in seconds, that a receiving system waits to hold the information before discarding it. The formula to calculate the hold time = LLDP timer value x holdtime-multiplier value. The `no` version of this command resets the value to the default.

For example, LLDP timer transmit interval is set to 30 seconds and the holdtime-multiplier is set to 4, the TTL is 120 seconds (30 x 4). The default TTL of 120 seconds. You can adjust the TTL value by changing the multiplier value of the holdtime.

1. Adjust the TTL value in CONFIGURATION mode.

```
lldp holdtime-multiplier
```

2. Return to the default multiplier value in CONFIGURATION mode.

```
no lldp holdtime-multiplier
```

```
OS10(config)# lldp holdtime-multiplier 2
```

### View LLDP timers

```
OS10# show lldp timers
LLDP Timers:
Holdtime in seconds: 60
Reinit-time in seconds: 2
Transmit interval in seconds: 30
```

## Configure LLDP to advertise TLVs

Configure the system to advertise TLVs from specific interfaces. If you configure the LLDP to advertise TLVs on an interface, only the interface sends LLDPDUs with the specified TLVs.

By default, all LLDP TLVs except VLAN name TLV are advertised. To advertise VLAN name TLV, you can configure the system to advertise the names of VLANs in LLDPDUs. For more information, see [Advertise VLAN name TLVs](#).

1. Enable basic TLV attributes to transmit and receive LLDP packets in INTERFACE mode.

```
lldp tlv-select basic-tlv {port-description | system-name | system-description |
system-capabilities | management-address}
```

2. Enable dot3 TLVs to transmit and receive LLDP packets in INTERFACE mode.

```
lldp tlv-select dot3tlv {macphy-config | max-framesize}
```

3. Enable dot1 TLVs to transmit and receive LLDP packets in INTERFACE mode.

```
lldp tlv-select dot1tlv {port-vlan-id | link-aggregation | vlan-name}
```

## Advertise VLAN Name TLVs

You can configure the system to advertise the names of VLANs in LLDPDUs. Configure the VLAN names before you configure the system to advertise VLAN names.

By default, this feature is disabled. After you enable this feature, the system starts sending LLDPDUs with the configured name of the default VLAN. If the default VLAN does not have a configured name, the system does not send an LLDPDU with a VLAN name TLV.

### Transmit VLAN name of the default VLAN

1. Enter INTERFACE mode from CONFIGURATION mode.

```
interface ethernet 1/1/1
```

2. Enable the `vlan-name` option in INTERFACE mode.

```
lldp tlv-select dot1-tlv vlan-name
```

3. Enter INTERFACE VLAN mode from CONFIGURATION mode.

```
interface vlan 1
```

4. Specify a name for VLAN 1 in INTERFACE VLAN mode.

```
vlan-name vlan1
```

### Transmit the VLAN names of a specific set of VLANs

When you configure the interface to send the names of specific VLANs using `lldp vlan-name-tlv allowed vlan` command, the interface can transmit a maximum of eight VLAN names. If you specify 10 VLANs and the default VLAN has a name, the interface transmits LLDPDUs with VLAN names of the default VLAN and the first seven VLANs configured with a name. If the default VLAN does not have a name, the interface transmits the VLAN names of the first eight VLANs that have a name.

1. Create a VLAN in CONFIGURATION mode.

```
interface vlan vlan-id
```

2. Specify a name for the required VLANs in INTERFACE mode.

```
vlan-name vlan-name
```

3. Configure Port mode as trunk from INTERFACE mode.

```
switchport mode trunk
```

4. Enable the `vlan-name` option in INTERFACE mode.

```
lldp tlv-select dot1-tlv vlan-name
```

5. Configure the interface to be an untagged member of the created VLANs in INTERFACE mode.

```
switchport trunk allowed vlan vlan-range
```

6. Configure the interface to send the names of specific VLANs in PDUs in INTERFACE mode.

```
lldp vlan-name-tlv allowed vlan vlan-ids
```

### Examples for configuring the system to transmit VLAN name in TLVs

Specify names for VLANs from 1 to 10 and configure ethernet 1/1/1 interface to transmit the names of nine VLANs. The interface is not explicitly configured to transmit the name of the default VLAN which is VLAN 1.

```
OS10# configure terminal
OS10(config)# interface vlan 1
OS10(conf-if-vl-1)#vlan-name vlan1
OS10(conf-if-vl-1)# exit
OS10(config)# interface vlan 2
OS10(conf-if-vl-2)#vlan-name vlan2
OS10(config)# interface vlan 3
OS10(conf-if-vl-3)#vlan-name vlan4
OS10(config)# interface vlan 4
OS10(conf-if-vl-4)#vlan-name vlan4
OS10(config)# interface vlan 5
OS10(conf-if-vl-5)#vlan-name vlan5
OS10(config)# interface vlan 6
OS10(conf-if-vl-6)#vlan-name vlan6
OS10(config)# interface vlan 7
OS10(conf-if-vl-7)#vlan-name vlan7
OS10(config)# interface vlan 8
OS10(conf-if-vl-8)#vlan-name vlan8
OS10(config)# interface vlan 9
OS10(conf-if-vl-9)#vlan-name vlan9
OS10(config)# interface vlan 10
OS10(conf-if-vl-10)#vlan-name vlan10
OS10(config)# interface ethernet 1/1/1
OS10(conf-if-eth1/1/1)# switchport mode trunk
OS10(conf-if-eth1/1/1)# switchport trunk allowed vlan 2-10
OS10(config)# interface ethernet 1/1/1
OS10(conf-if-eth1/1/1)#lldp vlan-name-tlv allowed vlan 2,3,4,5,6,7,8,9,10
```

The interface transmits the name of the default VLAN even if the default VLAN ID is not explicitly configured. The interface transmits the first eight VLAN names and excludes the names of VLAN 9 and VLAN 10. Following shows that the interface transmits the names of VLANs 1 to 8:

```
OS10# show lldp interface ethernet 1/1/1 local-device
Device ID: 34:17:eb:f2:05:c4
Port ID: ethernet1/1/1
System Name: OS10
Capabilities: Router, Bridge, Repeater
System description:
 Dell EMC Networking OS10 Enterprise.
 Copyright (c) 1999-2019 by Dell Inc. All Rights Reserved.
 System Description: OS10 Enterprise.
 OS Version: 10.4.9999EX.
 System Type: S4048-ON
Port description: ethernet1/1/1
Time To Live: 120
Maximum size of LLDP PDU: 1500
Current LLDP PDU Size: 387
LLDP PDU Truncated(Too many TLV's): false
VLAN Name(s):
 VLAN NAME

 1 vlan1
 2 vlan2
 3 vlan3
 4 vlan4
 5 vlan5
 6 vlan6
 7 vlan7
 8 vlan8
Maximum size of LLDP PDU: 1500
Current LLDP PDU Size: 386
LLDP PDU Truncated(Too many TLV's): false
LLDP MED Capabilities:
 Supported:
 LLDP-MED Capabilities,
 Network Policy,
 Inventory Management
 Current:
 LLDP-MED Capabilities,
```

```
Network Policy
LLDP MED Device Type: Network connectivity
```

Following example shows the name of VLAN 3 is deleted:

```
OS10(conf-if-eth1/1/1)# no lldp vlan-name-tlv allowed vlan 3
```

Following output shows that the interface deletes VLAN 3 and starts sending the name of VLAN 9:

```
OS10# show lldp interface ethernet 1/1/1 local-device
Device ID: 34:17:eb:f2:05:c4
Port ID: ethernet1/1/1
System Name: OS10
Capabilities: Router, Bridge, Repeater
System description:
 Dell EMC Networking OS10 Enterprise.
 Copyright (c) 1999-2019 by Dell Inc. All Rights Reserved.
 System Description: OS10 Enterprise.
 OS Version: 10.4.9999EX.
 System Type: S4048-ON
Port description: ethernet1/1/1
Time To Live: 120
Maximum size of LLDP PDU: 1500
Current LLDP PDU Size: 387
LLDP PDU Truncated(Too many TLV's): false
VLAN Name(s):

VLAN NAME

1 vlan1
2 vlan2
4 vlan4
5 vlan5
6 vlan6
7 vlan7
8 vlan8
9 vlan9
Maximum size of LLDP PDU: 1500
Current LLDP PDU Size: 386
LLDP PDU Truncated(Too many TLV's): false
LLDP MED Capabilities:
 Supported:
 LLDP-MED Capabilities,
 Network Policy,
 Inventory Management
 Current:
 LLDP-MED Capabilities,
 Network Policy
LLDP MED Device Type: Network connectivity
```

## Disable and reenable LLDP TLVs

By default, the interfaces advertise all LLDP TLVs except VLAN name TLV.

- Disable LLDP TLVs in INTERFACE mode.

```
no lldp tlv-select basic-tlv {port-description | system-name | system-description |
system-capabilities | management-address}
no lldp tlv-select dot1tlv {port-vlan-id | link-aggregation | vlan-name}
no lldp tlv-select dot3tlv {macphy-config | max-framesize}
```

### Disable LLDP TLVs

```
OS10(config)# interface ethernet 1/1/2
OS10(conf-if-eth1/1/2)# no lldp tlv-select basic-tlv system-name system-description
OS10(conf-if-eth1/1/2)# no lldp tlv-select dot1tlv port-vlan-id
OS10(conf-if-eth1/1/2)# no lldo tlv-select dot3tlv max-framesize
```

To reenable LLDP TLVs advertise on an interface, use the following commands:

## Enable LLDP TLVs

```
OS10(config)# interface ethernet 1/1/2
OS10(conf-if-eth1/1/2)# lldp tlv-select basic-tlv system-name system-description
OS10(conf-if-eth1/1/2)# lldp tlv-select dot1tlv port-vlan-id
```

## Disable and enable LLDP TLVs on management ports

By default, management ports advertise all LLDP TLVs except VLAN name TLV. You can disable the LLDP TLV advertisement on management ports using the following commands:

- Disable LLDP TLVs in INTERFACE mode.

```
no lldp tlv-select basic-tlv {port-description | system-name | system-description |
system-capabilities | management-address}
no lldp tlv-select dot1tlv {port-vlan-id | vlan-name}
```

## Disable LLDP TLVs

```
OS10(config)# interface mgmt 1/1/1
OS10(conf-if-ma-1/1/1)# no lldp tlv-select basic-tlv system-name system-description
OS10(conf-if-ma-1/1/1)# no lldp tlv-select dot1tlv port-vlan-id
```

To advertise LLDP TLVs from the management ports, use the following commands:

## Enable LLDP TLVs

```
OS10(config)# interface mgmt 1/1/1
OS10(conf-if-ma-1/1/1)# lldp tlv-select basic-tlv system-name system-description
OS10(conf-if-ma-1/1/1)# lldp tlv-select dot1tlv port-vlan-id
```

## Advertise management address TLVs in a VLT domain

The management address TLV advertises the IP address of the management interface to adjacent LAN devices. The system advertises this information in the management address TLV of all the physical ports. In a VLT domain, peer VLT devices transmit the IP address of their local management interface in the management address TLV.

To integrate with solutions such as the Cisco Application Centric Infrastructure (ACI), OS10 switches that are VLT peers, must advertise one common IP address in the management address TLV of the LLDPDU. This common IP address is also known as a virtual IP address, so that the VLT peers appear as a single switch to the Cisco ACI.

Configure OS10 switches that are part of a VLT pair to select a single IPv4 or IPv6 address as the virtual IP address. When you enable this feature, OS10 selects the lowest IP address per subnet that is configured on the management interface or management VLAN as the virtual IP address. LLDP advertises this virtual IP address in the management address TLV.

 **NOTE:** This feature works only on devices that are part of a VLT domain.

## Advertise virtual management IP address in management address TLV

You can enable the system to select a single IP address in a VLT pair, using the `lldp management-addr-tlv {ipv4 | ipv6} virtual-ip` command globally or on a specific interface. LLDP advertises the elected virtual IP address in the management address TLV.

To enable the service to send the virtual management IP address in the management address TLV:

- Enable the service to send the virtual IP address in the management address TLV using `lldp management-addr-tlv {ipv4 | ipv6} virtual-ip` in CONFIGURATION mode.

When enabled in CONFIGURATION mode, the configuration applies globally and the system advertises the elected IP address in the management address TLV.

- Enable the service to send the virtual IP address in the management address TLV using `lldp management-addr-tlv {ipv4 | ipv6} virtual-ip` in INTERFACE mode.

When enabled in INTERFACE mode, the configuration applies to the specific interface and the system advertises the elected IP address in the management address TLV.

```
OS10(config)#lldp management-addr-tlv ipv4 virtual-ip
OS10(config-if-eth1/1/6)#lldp management-addr-tlv ipv4 virtual-ip
OS10(config-if-eth1/1/6)#lldp management-addr-tlv ipv6 virtual-ip
```

## Example: Advertise TLVs configuration

The following configuration example describes how to configure the system to advertise LLDP TLVs.

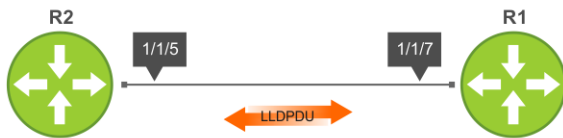

### Sample configuration on R1:

Enable the list of LLDP TLVs needs to be advertised from R1.

```
R1# configure terminal
R1(config)# interface ethernet 1/1/7
R1(conf-if-eth1/1/7)# switchport
R1(conf-if-eth1/1/7)# no shutdown
R1(conf-if-eth1/1/7)# lldp tlv-select basic-tlv system-name
R1(conf-if-eth1/1/7)# lldp tlv-select dot3tlv macphy-config
R1(conf-if-eth1/1/7)# lldp tlv-select dot3tlv max-framesize
R1(conf-if-eth1/1/7)# lldp tlv-select dot1tlv link-aggregation
R1(conf-if-eth1/1/7)# lldp tlv-select dot1tlv port-vlan-id
R1(conf-if-eth1/1/7)# lldp management-addr-tlv ipv4 virtual-ip
```

### Sample configuration on R2:

Enable the list of LLDP TLVs needs to be advertised from R2.

```
R1# configure terminal
R2(config)# interface ethernet 1/1/5
R2(conf-if-eth1/1/5)# switchport
R2(conf-if-eth1/1/5)# no shutdown
R2(conf-if-eth1/1/5)# lldp tlv-select basic-tlv system-name
R2(conf-if-eth1/1/5)# lldp tlv-select dot3tlv macphy-config
R2(conf-if-eth1/1/5)# lldp tlv-select dot3tlv max-framesize
R2(conf-if-eth1/1/5)# lldp tlv-select dot1tlv link-aggregation
R2(conf-if-eth1/1/5)# lldp tlv-select dot1tlv port-vlan-id
R1(conf-if-eth1/1/5)# lldp management-addr-tlv ipv4 virtual-ip
```

## View LLDP configuration

- View the LLDP configuration.

```
OS10# show running-configuration
```

- View LLDP error messages.

```
show lldp errors
```

### View LLDP errors

```
OS10# show lldp errors
Total Memory Allocation Failures : 0
Total Input Queue Overflows : 0
Total Table Overflows : 0
```



- View the LLDP traffic details.

```
show lldp traffic
```

### View LLDP global traffic

```
OS10# show lldp traffic
LLDP traffic statistics:
Total Frames Out : 0
Total Entries Aged : 0
Total Frames In : 0
Total Frames Received In Error : 0
Total Frames Discarded : 0
Total TLVS Unrecognized : 0
Total TLVS Discarded : 0
```

### View LLDP interface traffic

```
OS10# show lldp traffic interface ethernet 1/1/1
LLDP Traffic Statistics:
Total Frames Out : 0
Total Entries Aged : 0
Total Frames In : 0
Total Frames Received In Error : 0
Total Frames Discarded : 0
Total TLVS Unrecognized : 0
Total TLVS Discarded : 0

LLDP MED Traffic Statistics:
Total Med Frames Out : 0
Total Med Frames In : 0
Total Med Frames Discarded : 0
Total Med TLVS Discarded : 0
Total Med Capability TLVS Discarded: 0
Total Med Policy TLVS Discarded : 0
Total Med Inventory TLVS Discarded : 0
```

## View LLDP neighbor advertisements

- View brief information about the LLDP neighbors learned by the OS10 switch.

```
show lldp neighbors
```

### View LLDP neighbors

```
OS10# show lldp neighbors
Loc PortID Rem Host Name Rem Port Id Rem Chassis Id

ethernet1/1/2 Not Advertised fortyGigE 0/56 00:01:e8:8a:fd:35
ethernet1/1/20:1 Not Advertised GigabitEthernet 1/0 00:01:e8:05:db:05
```

- View LLDP neighbor information for a specific interface.

```
show lldp neighbors interface ethernetnode/slot/port[:subport]
```

### View LLDP neighbors interface

```
OS10# show lldp neighbors interface ethernet 1/1/1
Loc PortID Rem Host Name Rem Port Id Rem Chassis Id

ethernet1/1/1 OS10 ethernet1/1/2 4:17:eb:f7:06:c4
```

- View the detailed LLDP neighbor information for a specific interface.

```
show lldp neighbors detail
```

## View LLDP neighbors detail

```
OS10# show lldp neighbors interface ethernet 1/1/1 detail

Remote Chassis ID Subtype: Mac address (4)
Remote Chassis ID: 00:13:21:57:ca:40
Remote Port Subtype: Interface name (5)
Remote Port ID: ethernet1/1/10
Remote Port Description: Ethernet port 1
Local Port ID: ethernet1/1/1
Locally assigned remote Neighbor Index: 3
Remote TTL: 120
Information valid for next 105 seconds
Time since last information change of this neighbor: 00:00:15
Remote System Name: LLDP-pkt-gen
Remote Management Address (IPv4): 10.1.1.1
Remote System Desc: LLDP packet generator using scapy
Existing System Capabilities: Repeater, Bridge, Router
Enabled System Capabilities: Repeater, Bridge, Router
Remote Max Frame Size: 0
Remote Aggregation Status: false
MAC PHY Configuration:
 Auto-neg supported: 1
 Auto-neg enabled: 1
 Auto-neg advertised capabilities:
 10BASE-T half duplex mode,
 10BASE-T full duplex mode,
 100BASE-TX half duplex mode,
 100BASE-TX full duplex mode
MED Capabilities:
 Supported:
 LLDP-MED Capabilities,
 Network Policy,
 Location Identification,
 Extended Power via MDI - PSE,
 Extended Power via MDI - PD,
 Inventory Management
 Current:
 LLDP-MED Capabilities,
 Network Policy,
 Location Identification,
 Extended Power via MDI - PD,
 Inventory Management
 Device Class: Endpoint Class 3
Network Policy:
 Application: voice, Tag: Tagged, Vlan: 50, L2 Priority: 6, DSCP Value: 46
Inventory Management:
 H/W Revision : 12.1.1
 F/W Revision : 10.1.9750B
 S/W Revision : 10.1.9750B
 Serial Number : B11G152
 Manufacturer : Dell
 Model : S6010-ON
 Asset ID : E1001
Power-via-MDI:
 Power Type: PD Device
 Power Source: Local and PSE
 Power Priority: Low
 Power required: 6.5
Location Identification:
 Civic-based:
 2C:02:49:4E:01:02:54:4E:03:07:43:68:65:6E:6E:61:69:04:06:47:75:69:
 6E:64:79:05:0B:53:49:44:43:4F:49:6E:64:45:73:74:17:05:4F:54:50:2D:
 31
 ECS-ELIN:
 39:39:36:32:30:33:35:38:32:34
```

# LLDP-MED

Network connectivity devices and endpoint devices exchange LLDP-MED TLVs for interoperability and store advertised information.

OS supports the following LLDP-MED TLVs:

- LLDP-MED capabilities
- Network policy
- Inventory management
- Location identification
- Extended power via MDI

**NOTE:** LLDP-MED is designed for but not limited to VoIP endpoints.

**Table 32. LLDP-MED organizationally specific TLVs (Type – 127)**

| TLV                    | Subtype | Description                                                                                                                                                                                                      |
|------------------------|---------|------------------------------------------------------------------------------------------------------------------------------------------------------------------------------------------------------------------|
| LLDP-MED capabilities  | 1       | <ul style="list-style-type: none"> <li>• If the transmitting device supports LLDP-MED</li> <li>• What LLDP-MED TLVs are supported</li> <li>• LLDP device class</li> </ul>                                        |
| Network policy         | 2       | <ul style="list-style-type: none"> <li>• Application type</li> <li>• VLAN ID</li> <li>• L2 priority</li> <li>• DSCP value</li> </ul>                                                                             |
| Local identification   | 3       | Physical location of the device expressed in one of three formats: <ul style="list-style-type: none"> <li>• Coordinate-based LCI</li> <li>• Civic address LCI</li> <li>• Emergency call services ELIN</li> </ul> |
| Extended power-via-MDI | 4       | <ul style="list-style-type: none"> <li>• Power requirements</li> <li>• Priority</li> <li>• Power status</li> </ul>                                                                                               |

**NOTE:** Only Rx function is supported for location identification and extended power via MDI TLVs.

## LLDP-MED capabilities TLV

The LLDP-MED capabilities TLV communicates the types of TLVs that the endpoint device and network-connectivity device support. The value of the LLDP-MED capabilities field in the TLV is a 2–octet bitmap. Each bit represents an LLDP-MED capability.



**Table 33. LLDP-MED capabilities TLV**

| Bit position | TLV                   |
|--------------|-----------------------|
| 0            | LLDP-MED capabilities |
| 1            | Network policy        |

**Table 33. LLDP-MED capabilities TLV (continued)**

| Bit position | TLV                         |
|--------------|-----------------------------|
| 2            | Location ID                 |
| 3            | Extended power over MDI-PSE |
| 4            | Extended power over MDI-PD  |
| 5            | Inventory                   |
| 6-15         | Reserved                    |

**Table 34. LLDP-MED device types**

| Bit position | Device type          |
|--------------|----------------------|
| 0            | Not defined          |
| 1            | Endpoint Class 1     |
| 2            | Endpoint Class 2     |
| 3            | Endpoint Class 3     |
| 4            | Network connectivity |
| 5-255        | Reserved             |

## LLDP-MED network policies TLVs

A network policy in the context of LLDP-MED is a VLAN configuration of a device and associated L2 and L3 configurations.

LLDP-MED network policies TLV include:

- VLAN ID
- VLAN tagged or untagged status
- L2 priority
- DSCP value



You can configure a LLDP-MED network policy to generate an individual network policy TLV for each application type. For more information, see [Define network policies](#).

**NOTE:** Signaling is a series of control packets that are exchanged between an endpoint device and a network-connectivity device to establish and maintain a connection. These signal packets might require a different network policy than the media packets where a connection is made. In this case, configure the signaling application.

**Table 35. LLDP-MED Network policies TLVs**

| Type | Application     | Description                                                                                          |
|------|-----------------|------------------------------------------------------------------------------------------------------|
| 0    | Reserved        | —                                                                                                    |
| 1    | Voice           | Used for dedicated IP telephony handsets and other appliances supporting interactive voice services. |
| 2    | Voice signaling | Used only if voice control packets use a separate network policy than voice data.                    |
| 3    | Guest voice     | Used only for a separate limited voice service for guest users with their own IP telephony handsets  |

**Table 35. LLDP-MED Network policies TLVs (continued)**

| Type  | Application           | Description                                                                                                                                                                                                 |
|-------|-----------------------|-------------------------------------------------------------------------------------------------------------------------------------------------------------------------------------------------------------|
|       |                       | and other appliances supporting interactive voice services.                                                                                                                                                 |
| 4     | Guest voice signaling | Used only if guest voice control packets use a separate network policy than voice data.                                                                                                                     |
| 5     | SoftPhone voice       | Used for softphone applications on a device such as a personal computer or laptop. This class does not support multiple VLANs and if required, uses an untagged VLAN or a single tagged data-specific VLAN. |
| 6     | Video conferencing    | Used only for dedicated video conferencing and similar appliances supporting real-time interactive video.                                                                                                   |
| 7     | Streaming video       | Used for broadcast or multicast-based video content distribution and similar applications supporting streaming video services that require specific network policy treatment.                               |
| 8     | Video signaling       | Used only if video control packets use a separate network policy than the video data.                                                                                                                       |
| 9-255 | Reserved              | —                                                                                                                                                                                                           |

## Disable and reenable LLDP-MED

By default, LLDP-MED is enabled on all interfaces except on the management interface.

### Disable LLDP-MED

- Disable LLDP-MED on an interface, use the `lldp med disable` command in INTERFACE mode.

```
OS10(conf-if-eth1/1/1)# lldp med disable
```

### Enable LLDP-MED

When LLDP-MED is disabled, you can reenable LLDP-MED on an interface.

- Enable LLDP-MED on an interface, use `lldp med enable` command in INTERFACE mode.

```
OS10(conf-if-eth1/1/1)# lldp med enable
```

**NOTE:** If you enable LLDP MED on an interface, the system transmits MED TLVs only when it receives a TLV from a peer.

## Define LLDP-MED network policies

You can define one or more LLDP-MED network policies using the `lldp med` commands for any application and attach any network policies to the ports.

**NOTE:** You can create a maximum of 32 LLDP-MED network policies.

- Define the LLDP-MED network policy in CONFIGURATION mode.

```
lldp med network-policy number app {voice | voice-signaling | guest-voice |
guestvoice-signaling | softphone-voice | streaming-video | video-conferencing | video-
signaling} {vlan vlan-id vlan-type {tag | untag} priority priority dscp dscp value}
```

- Attach any defined network policy to the ports in INTERFACE mode.

```
lldp med network-policy {add | remove}
```

## Configure LLDP-MED network policy on an interface

```
OS10(config)# lldp med network-policy 1 app voice-signaling vlan 10 vlan-type tag
priority 2 dscp 1
OS10(config)# interface ethernet 1/1/1
OS10(conf-if-eth1/1/1)# lldp med network-policy add 1
```

## Network policy advertisement

LLDP-MED is enabled on all interfaces by default. Configure OS10 to advertise LLDP-MED TLVs from configured interfaces. Define LLDP-MED network policies before applying the policies to an interface. Attach only one network policy per interface.

- Define an LLDP-MED network-policy in INTERFACE mode.

```
lldp med network-policy {add | remove} number
```

- *add* — Attach the network policy to an interface.
- *remove* — Remove the network policy from an interface.
- *number* — Enter a network policy index number, from 1 to 32.

## Configure advertise LLDP-MED network policies

```
OS10(conf-if-eth1/1/5)# lldp med network-policy add 1
```

## Change the fast start repeat count

Fast start repeat enables a network-connectivity device to advertise itself at a faster rate for a limited amount of time. The fast start timer starts when a network-connectivity device receives the first LLDP frame from a newly detected endpoint.

The LLDP-MED fast start repeat count specifies the number of LLDP packets that are sent during the LLDP-MED fast start period. By default, the device sends three packets per interval. The number of packets that are sent during activation ranges from 1 to 10.

Rapid availability is crucial for applications such as emergency call service location (E911).

- Configure fast start repeat count which is the number of packets that are sent during activation in CONFIGURATION mode, from 1 to 10, default 3.

```
lldp-med fast-start-repeat-count number
```

## Configure fast start repeat count

```
OS10(config)# lldp med fast-start-repeat-count 5
```

## LLDP commands

### clear lldp counters

Clears LLDP and LLDP-MED transmit, receive, and discard statistics from all physical interfaces.

**Syntax** `clear lldp counters`

**Parameters** None

**Default** Not configured

**Command Mode** EXEC

**Usage Information** The counter default value resets to zero for all physical interfaces.

#### Example

```
OS10# clear lldp counters
```

**Supported Releases** 10.2.0E or later

## clear lldp table

Clears LLDP neighbor information for all interfaces.

**Syntax** `clear lldp table`  
**Parameters** None  
**Default** Not configured  
**Command Mode** EXEC  
**Usage Information** Neighbor information clears on all interfaces.

**Example**

```
OS10# clear lldp table
```

**Supported Releases** 10.2.0E or later

## lldp enable

Enables or disables LLDP globally.

**Syntax** `lldp enable`  
**Parameters** None  
**Default** Enabled  
**Command Mode** CONFIGURATION  
**Usage Information** This command enables LLDP globally for all Ethernet PHY interfaces, except on those interfaces where you manually disable LLDP. The `no` version of this command disables LLDP globally irrespective of whether you manually disable LLDP on an interface.

**Example**

```
OS10(config)# lldp enable
```

**Supported Releases** 10.3.1E or later

## lldp holdtime-multiplier

Configures the multiplier value for the hold time.

**Syntax** `lldp holdtime-multiplier integer`  
**Parameters** *integer* — Enter the holdtime-multiplier value, from 2 to 10.  
**Default** 4  
**Command Mode** CONFIGURATION  
**Usage Information** Hold time is the amount of time in seconds that a receiving system waits to hold the information before discarding it. Formula: Hold Time = (Updated Frequency Interval) x (Hold Time Multiplier). The `no` version of this command resets the value to the default.

**Example**

```
OS10(config)# lldp holdtime-multiplier 2
```

**Supported Releases** 10.2.0E or later

## lldp med fast-start-repeat-count

Configures the number of packets that are sent during the activation of the fast start mechanism.

|                           |                                                                                                                   |
|---------------------------|-------------------------------------------------------------------------------------------------------------------|
| <b>Syntax</b>             | <code>lldp-med fast-start-repeat-count <i>number</i></code>                                                       |
| <b>Parameters</b>         | <i>number</i> — Enter the number of packets sent during the activation of the fast start mechanism, from 1 to 10. |
| <b>Default</b>            | 3                                                                                                                 |
| <b>Command Mode</b>       | CONFIGURATION                                                                                                     |
| <b>Usage Information</b>  | None                                                                                                              |
| <b>Example</b>            | <pre>OS10(config)# lldp med fast-start-repeat-count 5</pre>                                                       |
| <b>Supported Releases</b> | 10.2.0E or later                                                                                                  |

## lldp med

Enables or disables LLDP-MED on an interface.

|                           |                                                                                                                                                                                                                                  |
|---------------------------|----------------------------------------------------------------------------------------------------------------------------------------------------------------------------------------------------------------------------------|
| <b>Syntax</b>             | <code>lldp med {enable   disable}</code>                                                                                                                                                                                         |
| <b>Parameters</b>         | <ul style="list-style-type: none"><li>• <code>enable</code> — Enable LLDP-MED on the interface.</li><li>• <code>disable</code> — Disable LLDP-MED on the interface.</li></ul>                                                    |
| <b>Default</b>            | Enabled with network-policy TLV                                                                                                                                                                                                  |
| <b>Command Mode</b>       | INTERFACE                                                                                                                                                                                                                        |
| <b>Usage Information</b>  | LLDP-MED communicates the types of TLVs that the endpoint device and network-connectivity device support. Use the <code>no lldp med</code> or <code>lldp med disable</code> command to disable LLDP-MED on a specific interface. |
| <b>Example</b>            | <pre>OS10(conf-if-eth1/1/1)# lldp med disable</pre>                                                                                                                                                                              |
| <b>Supported Releases</b> | 10.2.0E or later                                                                                                                                                                                                                 |

## lldp med network-policy

Manually defines an LLDP-MED network policy.

|                   |                                                                                                                                                                                                                                                                                                                                                                                                                                                                                                                                                                                                                                                                                                                                                            |
|-------------------|------------------------------------------------------------------------------------------------------------------------------------------------------------------------------------------------------------------------------------------------------------------------------------------------------------------------------------------------------------------------------------------------------------------------------------------------------------------------------------------------------------------------------------------------------------------------------------------------------------------------------------------------------------------------------------------------------------------------------------------------------------|
| <b>Syntax</b>     | <code>lldp med network-policy <i>number</i> app {voice   voice-signaling   guest-voice   guestvoice-signaling   softphone-voice   streaming-video   video-conferencing   video-signaling} {vlan <i>vlan-id</i> vlan-type {tag   untag} priority <i>priority</i> dscp <i>dscp value</i>}</code>                                                                                                                                                                                                                                                                                                                                                                                                                                                             |
| <b>Parameters</b> | <ul style="list-style-type: none"><li>• <i>number</i> — Enter a network policy index number, from 1 to 32.</li><li>• <i>app</i> — Enter the type of applications available for the network policy:<ul style="list-style-type: none"><li>◦ <code>voice</code> — Voice network-policy application</li><li>◦ <code>voice-signaling</code> — Voice-signaling network-policy application</li><li>◦ <code>guest-voice</code> — Guest voice network-policy application</li><li>◦ <code>guestvoice-signaling</code> — Guest voice signaling network policy application</li><li>◦ <code>softphone-voice</code> — SoftPhone voice network-policy application</li><li>◦ <code>streaming-video</code> — Streaming video network-policy application</li></ul></li></ul> |



- video-conferencing — Voice conference network-policy application
- video-signaling — Video signaling network-policy application
- vlan *vlan-id* — Enter the VLAN number for the selected application, from 1 to 4093.
- vlan-type — Enter the type of VLAN the application uses.
- tag — Enter a tagged VLAN number.
- untag — Enter an untagged VLAN number.
- priority *priority* — Enter the user priority set for the application.
- dscp *dscp value* — Enter the DSCP value set for the application.

**Default** Not configured

**Command Mode** CONFIGURATION

**Usage Information** You can create a maximum of 32 network policies and associate the LLDP-MED network policies to a port.

**Example**

```
OS10(config)# lldp med network-policy 10 app voice vlan 10 vlan-type tag
priority 2 dscp 1
```

**Supported Releases** 10.2.0E or later

## lldp med network-policy (Interface)

Attaches or deletes an LLDP-MED network policy to or from an interface.

**Syntax** `lldp med network-policy {add | remove} number`

- Parameters**
- add — Attach the network policy to an interface.
  - remove — Remove the network policy from an interface.
  - number — Enter a network policy index number, from 1 to 32.

**Default** Not configured

**Command Mode** INTERFACE

**Usage Information** Attach only one network policy for per interface.

**Example**

```
OS10(conf-if-eth1/1/5)# lldp med network-policy add 1
```

**Supported Release** 10.2.0E or later

## lldp med tlv-select

Configures the LLDP-MED TLV type to transmit or receive.

**Syntax** `lldp med tlv-select {network-policy | inventory}`

- Parameters**
- network-policy — Enable or disable the port description TLV.
  - inventory — Enable or disable the system TLV.

**Default** Enabled

**Command Mode** INTERFACE

**Usage Information** None

**Example**

```
OS10(conf-if-eth1/1/3)# lldp med tlv-select network-policy
```

**Supported Releases** 10.2.0E or later

## lldp port-description-tlv advertise

Specifies whether to advertise the interface description or the port id in the port description TLV.

**Syntax** `lldp port-description-tlv advertise [description | port-id]`

**Parameters**

- `description` — Advertise interface description.
- `port-id` — Advertise port id.

**Default** Interface description is advertised.

**Command Mode** INTERFACE

**Usage Information** Determines whether to advertise the interface description or the port ID in the port description TLV. According to RFC 2863, the `LLDPLocPortDesc` and `ifDescr` object values must be identical. To be compliant with RFC 2863, use the `port-id` option with the `lldp port-description-tlv advertise` command. The `port-id` option in this command returns the same value (port ID) for both `LLDPLocPortDesc` and `ifDescr` objects.

### Example

```
OS10(conf-if-eth1/1/1)# lldp port-description-tlv advertise description
```

```
OS10(conf-if-eth1/1/1)# lldp port-description-tlv advertise port-id
```

**Supported Releases** 10.4.3.0 or later

## lldp receive

Enables or disables the LLDP packet reception on a specific interface.

**Syntax** `lldp receive`

**Parameters** None

**Default** Not configured

**Command Mode** INTERFACE

**Usage Information** Enable LLDP globally on the system before using the `lldp receive` command. The `no` version of this command disables the reception of LLDP packets.

### Example

```
OS10(conf-if-eth1/1/3)# lldp receive
```

**Supported Releases** 10.2.0E or later

## lldp reinit

Configures the delay time in seconds for LLDP to initialize on any interface.

**Syntax** `lldp reinit seconds`

**Parameters** `seconds` — Enter the delay timer value in seconds, from 1 to 10.

**Default** 2 seconds

**Command Mode** CONFIGURATION

**Usage Information** The no version of this command resets the value to the default.

**Example**

```
OS10(config)# lldp reinit 5
```

**Supported Releases** 10.2.0E or later

## lldp timer

Configures the rate in seconds at which LLDP packets send to the peers.

**Syntax** `lldp timer seconds`

**Parameters** `seconds` — Enter the LLDP timer rate in seconds, from 5 to 254.

**Default** 30 seconds

**Command Mode** CONFIGURATION

**Usage Information** The no version of this command sets the LLDP timer back to its default value.

**Example**

```
OS10(config)# lldp timer 25
```

**Supported Releases** 10.2.0E or later

## lldp tlv-select basic-tlv

Enables or disables TLV attributes to transmit and receive LLDP packets.

**Syntax** `lldp tlv-select basic-tlv {port-description | system-name | system-description | system-capabilities | management-address [ipv4 | ipv6]}`

**Parameters**

- `port-description` — Enable or disable the port description TLV.
- `system-name` — Enable or disable the system TLV.
- `system-description` — Enable or disable the system description TLV.
- `system-capabilities` — Enable or disable the system capabilities TLV.
- `management-address` — Enable or disable the management address TLV (IPv4 and IPv6).
- `management-address ipv4` - Enable or disable only the IPv4 management address TLV.
- `management-address ipv6` - Enable or disable only the IPv6 management address TLV.

**Default** Enabled

**Command Mode** INTERFACE

**Usage Information** The no form of the command disables TLV attribute transmission and reception in LLDP packets.

**Example**

```
OS10(conf-if-eth1/1/3)# lldp tlv-select basic-tlv system-name
```

**Supported Releases** 10.2.0E or later

## lldp management-addr-tlv virtual-ip

Enables VLT peers to send the elected virtual IP address in the management address TLV.

**Syntax** `lldp management-addr-tlv {ipv4 | ipv6} virtual-ip`

|                           |                                                                                                                                                                                                                                                                                                                                                                                                                                    |
|---------------------------|------------------------------------------------------------------------------------------------------------------------------------------------------------------------------------------------------------------------------------------------------------------------------------------------------------------------------------------------------------------------------------------------------------------------------------|
| <b>Parameters</b>         | <ul style="list-style-type: none"> <li>• <code>ipv4</code> — Select <code>ipv4</code> for the VLT peers to send the virtual IPv4 address in the management TLV.</li> <li>• <code>ipv6</code> — Select <code>ipv6</code> for the VLT peers to send the virtual IPv6 address in the management TLV.</li> </ul>                                                                                                                       |
| <b>Default</b>            | Disabled                                                                                                                                                                                                                                                                                                                                                                                                                           |
| <b>Command Mode</b>       | <ul style="list-style-type: none"> <li>• CONFIGURATION</li> <li>• INTERFACE</li> </ul>                                                                                                                                                                                                                                                                                                                                             |
| <b>Usage Information</b>  | <p>When enabled in CONFIGURATION mode, the system advertises the elected IP address in the management address TLV of all the interfaces.</p> <p>When enabled in INTERFACE mode, the system advertises the elected IP address in the management address TLV of that specific interface.</p> <p>The <code>no</code> version of this command resets to default. By default, the system transmits the local management IP address.</p> |
| <b>Example</b>            | <pre>OS10(config)# lldp management-addr-tlv ipv4 virtual-ip OS10(conf-if-eth1/1/3)# lldp management-addr-tlv ipv6 virtual-ip</pre>                                                                                                                                                                                                                                                                                                 |
| <b>Supported Releases</b> | 10.5.0 or later                                                                                                                                                                                                                                                                                                                                                                                                                    |

## lldp tlv-select dot1tlv

Enables or disables the dot.1 TLVs to transmit in LLDP packets.

|                          |                                                                                                                                                                                                                                                                                                    |
|--------------------------|----------------------------------------------------------------------------------------------------------------------------------------------------------------------------------------------------------------------------------------------------------------------------------------------------|
| <b>Syntax</b>            | <code>lldp tlv-select dot1tlv { port-vlan-id   link-aggregation   vlan-name }</code>                                                                                                                                                                                                               |
| <b>Parameters</b>        | <ul style="list-style-type: none"> <li>• <code>port-vlan-id</code> — Enter the port VLAN ID.</li> <li>• <code>link-aggregation</code> — Enable the link aggregation TLV.</li> <li>• <code>vlan-name</code> — Configure dot1 TLVs to send and receive the names of VLANs in LLDP frames.</li> </ul> |
| <b>Default</b>           | Enabled. <code>vlan-name</code> is disabled.                                                                                                                                                                                                                                                       |
| <b>Command Mode</b>      | INTERFACE                                                                                                                                                                                                                                                                                          |
| <b>Usage Information</b> | <p>The <code>link-aggregation</code> parameter advertises link aggregation as a dot1 TLV in the LLDPDUs.</p> <p>The <code>vlan-name</code> parameter advertises the names of VLANs in LLDP frames.</p> <p>The <code>no</code> version of this command disables TLV transmissions.</p>              |

### Example (Port)

```
OS10(conf-if-eth1/1/3)# lldp tlv-select dot1tlv port-vlan-id
```

### Example (Link Aggregation)

```
OS10(conf-if-eth1/1/3)# lldp tlv-select dot1tlv link-aggregation
```

### Example (VLAN name)

```
OS10(conf-if-eth1/1/3)# lldp tlv-select dot1tlv vlan-name
```

|                           |                  |
|---------------------------|------------------|
| <b>Supported Releases</b> | 10.2.0E or later |
|---------------------------|------------------|

## lldp tlv-select dot3tlv

Enables or disables the dot3 TLVs to transmit in LLDP packets.

|                   |                                                                                                                                                                                      |
|-------------------|--------------------------------------------------------------------------------------------------------------------------------------------------------------------------------------|
| <b>Syntax</b>     | <code>lldp tlv-select dot3tlv { macphy-config   max-framesize }</code>                                                                                                               |
| <b>Parameters</b> | <ul style="list-style-type: none"> <li>• <code>macphy-config</code> — Enable the port VLAN ID TLV.</li> <li>• <code>max-framesize</code> — Enable maximum frame size TLV.</li> </ul> |

|                           |                                                                          |
|---------------------------|--------------------------------------------------------------------------|
| <b>Default</b>            | Enabled                                                                  |
| <b>Command Mode</b>       | INTERFACE                                                                |
| <b>Usage Information</b>  | The <code>no</code> version of this command disables TLV transmission.   |
| <b>Example</b>            | <pre>OS10(conf-if-eth1/1/3)# lldp tlv-select dot3tlv macphy-config</pre> |
| <b>Supported Releases</b> | 10.2.0E or later                                                         |

## lldp transmit

Enables the transmission of LLDP packets on a specific interface.

|                           |                                                                                                                |
|---------------------------|----------------------------------------------------------------------------------------------------------------|
| <b>Syntax</b>             | <code>lldp transmit</code>                                                                                     |
| <b>Parameters</b>         | None                                                                                                           |
| <b>Default</b>            | Not configured                                                                                                 |
| <b>Command Mode</b>       | INTERFACE                                                                                                      |
| <b>Usage Information</b>  | The <code>no</code> version of this command disables the transmission of LLDP packets on a specific interface. |
| <b>Example</b>            | <pre>OS10(conf-if-eth1/1/9)# lldp transmit</pre>                                                               |
| <b>Supported Releases</b> | 10.2.0E or later                                                                                               |

## lldp vlan-name-tlv allowed vlan

Specifies a single or multiple VLANs' names to transmit in LLDPDUs.

|                           |                                                                                                                                                                                                                                                                                                                                                                                                                                                                                                                                                                                                                                                                                                                                                                                                                                                                                                                      |
|---------------------------|----------------------------------------------------------------------------------------------------------------------------------------------------------------------------------------------------------------------------------------------------------------------------------------------------------------------------------------------------------------------------------------------------------------------------------------------------------------------------------------------------------------------------------------------------------------------------------------------------------------------------------------------------------------------------------------------------------------------------------------------------------------------------------------------------------------------------------------------------------------------------------------------------------------------|
| <b>Syntax</b>             | <code>lldp vlan-name-tlv allowed vlan <b>vlan-id</b></code>                                                                                                                                                                                                                                                                                                                                                                                                                                                                                                                                                                                                                                                                                                                                                                                                                                                          |
| <b>Parameters</b>         | <b>vlan-id</b> —Specify a single VLAN or multiple VLANs.                                                                                                                                                                                                                                                                                                                                                                                                                                                                                                                                                                                                                                                                                                                                                                                                                                                             |
| <b>Default</b>            | Disabled                                                                                                                                                                                                                                                                                                                                                                                                                                                                                                                                                                                                                                                                                                                                                                                                                                                                                                             |
| <b>Command Mode</b>       | INTERFACE                                                                                                                                                                                                                                                                                                                                                                                                                                                                                                                                                                                                                                                                                                                                                                                                                                                                                                            |
| <b>Usage Information</b>  | <p>This command specifies VLANs' names to transmit in LLDPDUs along with the configured default VLAN. If you do not use this command, the interface sends the name of the default VLAN if a name is configured.</p> <p>If you use this command to transmit multiple VLAN names, any VLAN configured without a name is excluded.</p> <p>An interface can transmit a maximum of eight VLAN names. If you specify 10 VLANs and if the default VLAN configured has a name, the interface transmits LLDPDUs with VLAN names of the default VLAN and the first seven VLANs that have a name configured. If the default VLAN does not have a name configured, the interface transmits the VLAN names of the first eight VLANs that have a name configured and excludes the default VLAN.</p> <p>This command is accessible to users with <code>sysadmin</code>, <code>secadmin</code>, and <code>netadmin</code> roles.</p> |
| <b>Example</b>            | <pre>OS10(conf-if-eth1/1/1)# lldp vlan-name-tlv allowed vlan vlan2</pre> <pre>OS10(conf-if-eth1/1/1)# lldp vlan-name-tlv allowed vlan 2-10,12,14-16,20,24</pre>                                                                                                                                                                                                                                                                                                                                                                                                                                                                                                                                                                                                                                                                                                                                                      |
| <b>Supported Releases</b> | 10.5.0 or later                                                                                                                                                                                                                                                                                                                                                                                                                                                                                                                                                                                                                                                                                                                                                                                                                                                                                                      |

## show lldp interface

Displays the LLDP information that is advertised from a specific interface.

**Syntax** `show lldp interface ethernet node/slot/port[:subport] [local-device | med]`

- Parameters**
- `ethernet node/slot/port[:subport]` — Enter the Ethernet interface information.
  - `local-device` — Enter the interface to view the local-device information.
  - `med` — Enter the interface to view the MED information.

**Default** None

**Command Mode** EXEC

**Usage Information** Use the `med` parameter to view MED information for a specific interface. Use the `local-device` parameter to view inventory details.

**Example**

```
OS10# show lldp interface ethernet 1/1/5
ethernet1/1/5
Tx State : Enabled
Rx State : Enabled
Tx SEM State : initialize
Rx SEM State : wait-port-operational
Notification Status : Disabled
Notification Type : mis-configuration
DestinationMacAddr : 01:80:c2:00:00:0e
```

**Example (Local Device)**

```
OS10# show lldp interface ethernet 1/1/1 local-device

Device ID: 90:b1:1c:f4:a6:25
Port ID: ethernet1/1/2:1
System Name: 0075
Capabilities: Router, Bridge, Repeater
System description:

Dell EMC Networking OS10 Enterprise.
Copyright (c) 1999-2019 by Dell Inc. All Rights Reserved.
System Description: OS10 Enterprise.
OS Version: 10.4.9999EX.
System Type: S4048-ON

Port description: ethernet1/1/2:1
VLAN Name(s):
 VLAN NAME

 2 VLAN2
 3 VLAN3
Maximum size of LLDP PDU: 1500
Current LLDP PDU Size: 359
LLDP PDU Truncated(Too many TLV's): false
Time To Live: 150
LLDP MED Capabilities:
Supported:
LLDP-MED Capabilities,
Network Policy,
Inventory Management
Current:
LLDP-MED Capabilities,
Network Policy
LLDP MED Device Type: Network connectivity
```

**Example (MED)**

```
OS10# show lldp interface ethernet 1/1/20:1 med
Port	Capabilities	Network Policy	Location	Inventory	POE
ethernet1/1/20:1 | Yes | Yes | No | No | No
Network Polices :
```

**Supported Releases** 10.2.0E or later

## show lldp errors

Displays the LLDP errors that are related to memory allocation failures, queue overflows, and table overflows.

**Syntax** show lldp errors

**Parameters** None

**Default** Not configured

**Command Mode** EXEC

**Usage Information** None

### Example

```
OS10# show lldp errors
Total Memory Allocation Failures: 0
Total Input Queue Overflows: 0
Total Table Overflows: 0
```

**Supported Release** 10.2.0E or later

## show lldp med

Displays the LLDP MED information for all the interfaces.

**Syntax** show lldp med

**Parameters** None

**Default** Not configured

**Command Mode** EXEC

**Usage Information** Use the show lldp interface command to view MED information for a specific interface.

### Example

```
OS10# show lldp med
Fast Start Repeat Count: 3
LLDP MED Device Type: Network Connectivity
Port	Capabilities	Network Policy	Location	Inventory	POE
ethernet1/1/1 | Yes | Yes | No | No | No
ethernet1/1/2 | Yes | Yes | No | No | No
ethernet1/1/3 | Yes | Yes | No | No | No
ethernet1/1/4 | Yes | Yes | No | Yes | No
ethernet1/1/5 | Yes | Yes | No | No | No
ethernet1/1/6 | Yes | Yes | No | No | No
ethernet1/1/7 | Yes | Yes | No | Yes | No
ethernet1/1/8 | Yes | Yes | No | No | No
ethernet1/1/9 | Yes | Yes | No | No | No
ethernet1/1/10 | Yes | Yes | No | No | No
ethernet1/1/11 | Yes | Yes | No | No | No
ethernet1/1/12 | Yes | Yes | No | No | No
ethernet1/1/13 | Yes | Yes | No | No | No
ethernet1/1/14 | Yes | Yes | No | No | No
ethernet1/1/15 | Yes | Yes | No | No | No
ethernet1/1/16 | Yes | Yes | No | No | No
ethernet1/1/17 | Yes | Yes | No | No | No
ethernet1/1/18 | Yes | Yes | No | No | No
ethernet1/1/19 | Yes | Yes | No | No | No
ethernet1/1/20 | Yes | Yes | No | No | No
ethernet1/1/21 | Yes | Yes | No | No | No
```

|                |  |     |  |     |  |    |  |    |  |    |
|----------------|--|-----|--|-----|--|----|--|----|--|----|
| ethernet1/1/22 |  | Yes |  | Yes |  | No |  | No |  | No |
| ethernet1/1/23 |  | Yes |  | Yes |  | No |  | No |  | No |
| ethernet1/1/24 |  | Yes |  | Yes |  | No |  | No |  | No |
| ethernet1/1/25 |  | Yes |  | Yes |  | No |  | No |  | No |
| ethernet1/1/26 |  | Yes |  | Yes |  | No |  | No |  | No |
| ethernet1/1/27 |  | Yes |  | Yes |  | No |  | No |  | No |
| ethernet1/1/28 |  | Yes |  | Yes |  | No |  | No |  | No |
| ethernet1/1/29 |  | Yes |  | Yes |  | No |  | No |  | No |
| ethernet1/1/30 |  | Yes |  | Yes |  | No |  | No |  | No |
| ethernet1/1/31 |  | Yes |  | Yes |  | No |  | No |  | No |
| ethernet1/1/32 |  | Yes |  | Yes |  | No |  | No |  | No |

**Supported Releases** 10.2.0E or later

## show lldp neighbors

Displays the system information of the LLDP neighbors.

**Syntax** `show lldp neighbors [detail | interface ethernet node/slot/port[:subport]]`

**Parameters**

- `detail` — View LLDP neighbor detailed information
- `interface ethernet node/slot/port[:subport]` — Enter the Ethernet interface information.

**Command Mode** EXEC

**Usage Information** This command status information includes local port ID, remote hostname, remote port ID, remote VLAN names, and remote node ID.

### Example

```
OS10# show lldp neighbors
Loc PortID Rem Host Name Rem Port Id Rem Chassis Id

ethernet1/1/2 Not Advertised fortyGigE 0/56 00:01:e8:8a:fd:35
ethernet1/1/20:1 Not Advertised GigabitEthernet 1/0 00:01:e8:05:db:05
```

### Example (Detail)

```
OS10# show lldp neighbors interface ethernet 1/1/1 detail

Remote Chassis ID Subtype: Mac address (4)
Remote Chassis ID: 00:50:56:a6:29:54
Remote Port Subtype: Interface alias (1)
Remote Port ID: ethernet1/1/1
Remote Port Description: ethernet1/1/1
Local Port ID: ethernet1/1/1
Locally assigned remote Neighbor Index: 2
Remote TTL: 120
Information valid for next 99 seconds
Time since last information change of this neighbor: 15:51:41
Remote System Name: OS10
Remote System Desc: OS10
Existing System Capabilities: Repeater, Bridge, Router
Enabled System Capabilities: Repeater, Bridge, Router
Remote Port Vlan ID: 1
Remote VLAN Name(s):
 VLAN NAME

 2 VLAN2
 6 VLAN6
Remote Max Frame Size: 1532
Remote Aggregation Status: false
MAC PHY Configuration:
Auto-neg supported: 1
Auto-neg enabled: 1
Auto-neg advertised capabilities:
1000BASE-T half duplex mode
Dell EMC Organization Specific Detail:
```



```
Originator: Switch
Service Tag: B8D1XC2
Product Base: base1
Product Serial Number: sn1
Product Part Number: pn1
```

**Example  
(Interface)**

```
OS10# show lldp neighbors interface ethernet 1/1/1
Loc PortID Rem Host Name Rem Port Id Rem Chassis Id

ethernet1/1/1 OS10 ethernet1/1/2 4:17:eb:f7:06:c4
```

**Supported  
Releases**

10.2.0E or later

## show lldp timers

Displays the LLDP hold time, delay time, and update frequency interval configuration information.

**Syntax** `show lldp timers`

**Parameters** None

**Default** Not configured

**Command Mode** EXEC

**Usage Information** None

**Example**

```
OS10# show lldp timers
LLDP Timers:
Holdtime in seconds: 120
Reinit-time in seconds: 6
Transmit interval in seconds: 30
```

**Supported  
Releases**

10.2.0E or later

## show lldp tlv-select interface

Displays the TLVs enabled for an interface.

**Syntax** `show lldp tlv-select interface ethernet node/slot/port[:subport]`

**Parameters** `ethernet node/slot/port[:subport]` — Enter the Ethernet interface information, from 1 to 253.

**Default** Not configured

**Command Mode** EXEC

**Usage Information** None

**Example**

```
OS10# show lldp tlv-select interface ethernet 1/1/1
port-description
system-capabilities
system-description
system-name
port-vlan
mac-phy-config
link-aggregation
max-frame-size
vlan-name
```

**Supported Releases** 10.2.0E or later

## show lldp traffic

Displays LLDP traffic information including counters, packets that are transmitted and received, discarded packets, and unrecognized TLVs.

**Syntax** `show lldp traffic [interface ethernet node/slot/port[:subport]]`

**Parameters** `interface ethernet node/slot/port[:subport]` — (Optional) Enter the Ethernet interface information to view the LLDP traffic.

**Default** Not configured

**Command Mode** EXEC

**Usage Information** None

### Example

```
OS10# show lldp traffic
LLDP Traffic Statistics:
Total Frames Out : 1504
Total Entries Aged : 2
Total Frames In : 67
Total Frames Received In Error : 0
Total Frames Discarded : 0
Total TLVS Unrecognized : 0
Total TLVS Discarded : 0
```

### Example (Interface)

```
OS10# show lldp traffic interface ethernet 1/1/2
LLDP Traffic Statistics:
Total Frames Out : 45
Total Entries Aged : 1
Total Frames In : 33
Total Frames Received In Error : 0
Total Frames Discarded : 0
Total TLVS Unrecognized : 0
Total TLVS Discarded : 0

LLDP MED Traffic Statistics:
Total Med Frames Out : 2
Total Med Frames In : 1
Total Med Frames Discarded : 0
Total Med TLVS Discarded : 0
Total Med Capability TLVS Discarded: 0
Total Med Policy TLVS Discarded : 0
Total Med Inventory TLVS Discarded : 0
```

**Supported Releases** 10.2.0E or later

## show network-policy profile

Displays network policy profiles.

**Syntax** `show network-policy profile [profile number]`

**Parameters** `profile number` — (Optional) Enter the network policy profile number, from 1 to 32.

**Default** Not configured

**Command Mode** EXEC

**Usage Information** If you do not enter the network profile ID, all configured network policy profiles display.

## Example

```
OS10# show network-policy profile 10
Network Policy Profile 10
 voice vlan 17 cos 4
 Interface:
 none
Network Policy Profile 30
 voice vlan 30 cos 5
 Interface:
 none
Network Policy Profile 36
 voice vlan 4 cos 3
 Interface:
 ethernet 1/1/1, ethernet 1/1/3-5
```

**Supported Releases** 10.2.0E or later

# Media Access Control

All Ethernet switching ports maintain media access control (MAC) address tables. Each physical device in your network contains a MAC address. OS10 devices automatically enter learned MAC addresses as dynamic entries in the MAC address table.

Learned MAC address entries are subject to aging. Set the aging timer to zero (0) to disable MAC aging. For any dynamic entry, if no packet arrives on the device with the MAC address as the source or destination address within the timer period, the address is removed from the table.

- Enter an aging time (in seconds) in CONFIGURATION mode, from 0 to 1000000, default 1800.

```
mac address-table aging-time seconds
```

## Configure Aging Time

```
OS10(config)# mac address-table aging-time 900
```

## Disable Aging Time

```
OS10(config)# mac address-table aging-time 0
```

# Static MAC Address

You manually configure a static MAC address entry. A static entry is not subject to aging.

- Create a static MAC address entry in the MAC address table in CONFIGURATION mode.

```
mac-address-table static nn:nn:nn:nn:nn vlan vlan-id interface [ethernet node/slot/
port[:subport] | port-channel channel-number]
```

**NOTE:** Before using the `mac-address-table static` command, create the required VLANs. If you do not create a VLAN before configuring a static MAC address entry, the system displays an error message.

## Set Static MAC Address

```
OS10(config)# interface vlan 10
OS10(conf-if-vl-11)# exit
OS10(config)# mac address-table static 34:17:eb:f2:ab:c6 vlan 10 interface ethernet 1/1/5
```

# MAC Address Table

OS10 maintains a list of MAC address table entries.

- View the contents of the MAC address table in EXEC mode.

```
show mac address-table {dynamic | static} [address mac-address | vlan vlan-id |
interface {ethernet node/slot/port[:subport] | port-channel number}] [count [vlan
vlan-id] [interface {type node/slot/port[:subport] | port-channel number}]
```

- `dynamic` — (Optional) Displays dynamic MAC address table entry information.
- `static` — (Optional) Displays static MAC address table entry information.
- `address mac-address` — (Optional) Displays MAC address information.
- `interface ethernet node/slot/port[:subport]` — (Optional) Displays a list of dynamic and static MAC address entries.
- `interface port-channel number` — (Optional) Displays port channel information, from 1 to 128.
- `count` — (Optional) Displays the number of dynamic and static MAC address entries.
- `vlan vlan-id` — (Optional) Displays information for a specified VLAN only, from 1 to 4093.

### View MAC Address Table Entries

```
OS10# show mac address-table
VlanId Mac Address Type Interface
1 00:00:15:c6:ca:49 dynamic ethernet1/1/21
1 00:00:20:2a:25:55 dynamic ethernet1/1/21
1 90:b1:1c:f4:aa:ce dynamic ethernet1/1/21
1 90:b1:1c:f4:aa:c6 dynamic ethernet1/1/21
10 34:17:eb:02:8c:33 static ethernet1/1/1
```

### View MAC Address Table Count

```
OS10# show mac address-table count
MAC Entries for all vlans :
Dynamic Address Count : 4
Static Address (User-defined) Count : 1
Total MAC Addresses in Use: 5
```

## Clear MAC Address Table

You can clear dynamic address entries that in the MAC address table maintains.

- Clear the MAC address table of dynamic entries in EXEC mode.

```
clear mac address-table dynamic [[all] [address mac_addr] [vlan vlan-id] [interface
{ethernet type node/slot/port[:subport] | port-channel number}]
```

- `all` — (Optional) Clear all dynamic entries.
- `address mac_address` — (Optional) Clear a MAC address entry.
- `vlan vlan-id` — (Optional) Clear a MAC address table entry from a VLAN number, from 1 to 4093.
- `ethernet node/slot/port[:subport]` — (Optional) Clear an Ethernet interface entry.
- `port-channel number` — (Optional) Clear a port-channel number, from 1 to 128.

### Clear MAC Address Table

```
OS10# clear mac address-table dynamic vlan 20 interface ethernet 1/2/20
```

## MAC Commands

### clear mac address-table dynamic

Clears L2 dynamic address entries from the MAC address table.

**Syntax** `clear mac address-table dynamic {all | address mac_addr | vlan vlan-id | interface {ethernet node/slot/port[:subport] | port-channel number}}`

|                           |                                                                                                                                                                                                                                                                                                                                                                                                                                                                                                                                                                                                                                                                                                                                                                                                                      |
|---------------------------|----------------------------------------------------------------------------------------------------------------------------------------------------------------------------------------------------------------------------------------------------------------------------------------------------------------------------------------------------------------------------------------------------------------------------------------------------------------------------------------------------------------------------------------------------------------------------------------------------------------------------------------------------------------------------------------------------------------------------------------------------------------------------------------------------------------------|
| <b>Parameters</b>         | <ul style="list-style-type: none"> <li>• <code>all</code> — (Optional) Delete all MAC address table entries.</li> <li>• <code>address mac_addr</code> — (Optional) Delete a configured MAC address from the address table in <code>nn:nn:nn:nn:nn:nn</code> format.</li> <li>• <code>vlan vlan-id</code> — (Optional) Delete all entries based on the VLAN number from the address table, from 1 to 4093.</li> <li>• <code>interface</code> — (Optional) Clear the interface type: <ul style="list-style-type: none"> <li>◦ <code>ethernet node/slot/port[:subport]</code> — Delete the Ethernet interface configuration from the address table.</li> <li>◦ <code>port-channel channel-number</code> — Delete the port-channel interface configuration from the address table, from 1 to 128.</li> </ul> </li> </ul> |
| <b>Default</b>            | Not configured                                                                                                                                                                                                                                                                                                                                                                                                                                                                                                                                                                                                                                                                                                                                                                                                       |
| <b>Command Mode</b>       | EXEC                                                                                                                                                                                                                                                                                                                                                                                                                                                                                                                                                                                                                                                                                                                                                                                                                 |
| <b>Usage Information</b>  | Use the <code>all</code> parameter to remove all dynamic entries from the address table.                                                                                                                                                                                                                                                                                                                                                                                                                                                                                                                                                                                                                                                                                                                             |
| <b>Example</b>            | <pre>OS10# clear mac address-table dynamic all</pre>                                                                                                                                                                                                                                                                                                                                                                                                                                                                                                                                                                                                                                                                                                                                                                 |
| <b>Example (VLAN)</b>     | <pre>OS10# clear mac address-table dynamic vlan 20</pre>                                                                                                                                                                                                                                                                                                                                                                                                                                                                                                                                                                                                                                                                                                                                                             |
| <b>Supported Releases</b> | 10.2.0E or later                                                                                                                                                                                                                                                                                                                                                                                                                                                                                                                                                                                                                                                                                                                                                                                                     |

## mac address-table aging-time

Configures the aging time for entries in the L2 address table.

|                           |                                                                                                                                                                          |
|---------------------------|--------------------------------------------------------------------------------------------------------------------------------------------------------------------------|
| <b>Syntax</b>             | <code>mac address-table aging-time seconds</code>                                                                                                                        |
| <b>Parameters</b>         | <code>seconds</code> — Enter the aging time for MAC table entries in seconds, from 0 to 1000000.                                                                         |
| <b>Default</b>            | 1800 seconds                                                                                                                                                             |
| <b>Command Mode</b>       | CONFIGURATION                                                                                                                                                            |
| <b>Usage Information</b>  | Set the aging timer to zero (0) to disable MAC address aging for all dynamic entries. The aging time counts from the last time that the device detected the MAC address. |
| <b>Example</b>            | <pre>OS10(config)# mac address-table aging-time 3600</pre>                                                                                                               |
| <b>Supported Releases</b> | 10.2.0E or later                                                                                                                                                         |

## mac address-table static

Configures a static entry for the Layer 2 MAC address table.

|                   |                                                                                                                                                                                                                                                                                                                                                                                                                                                                                                                                                                                              |
|-------------------|----------------------------------------------------------------------------------------------------------------------------------------------------------------------------------------------------------------------------------------------------------------------------------------------------------------------------------------------------------------------------------------------------------------------------------------------------------------------------------------------------------------------------------------------------------------------------------------------|
| <b>Syntax</b>     | <code>mac address-table static mac-address vlan vlan-id interface {ethernet node/slot/port[:subport]   port-channel number}</code>                                                                                                                                                                                                                                                                                                                                                                                                                                                           |
| <b>Parameters</b> | <ul style="list-style-type: none"> <li>• <code>mac-address</code> — Enter the MAC address to add to the table in <code>nn:nn:nn:nn:nn:nn</code> format.</li> <li>• <code>vlan vlan-id</code> — Enter the VLAN to apply the static MAC address to, from 1 to 4093.</li> <li>• <code>interface</code> — Enter the interface type: <ul style="list-style-type: none"> <li>◦ <code>ethernet node/slot/port[:subport]</code> — Enter the Ethernet information.</li> <li>◦ <code>port-channel channel-number</code> — Enter a port-channel interface number, from 1 to 128.</li> </ul> </li> </ul> |
| <b>Default</b>    | Not configured                                                                                                                                                                                                                                                                                                                                                                                                                                                                                                                                                                               |

|                               |                                                                                                                                                                                                                                                                        |
|-------------------------------|------------------------------------------------------------------------------------------------------------------------------------------------------------------------------------------------------------------------------------------------------------------------|
| <b>Command Mode</b>           | CONFIGURATION                                                                                                                                                                                                                                                          |
| <b>Usage Information</b>      | <p>If you configure the <code>switchport port-security</code> command on an interface, you can configure MAC address learning limit, sticky MAC address, and control MAC move.</p> <p>The <code>no</code> version of this command resets the value to the default.</p> |
| <b>Example (VLAN)</b>         | <pre>OS10(config)# mac address-table static 34:17:eb:f2:ab:c6 vlan 1 interface ethernet 1/1/30</pre>                                                                                                                                                                   |
| <b>Example (Port-Channel)</b> | <pre>OS10(config)# mac address-table static 34:17:eb:02:8c:33 vlan 10 interface port-channel 1</pre>                                                                                                                                                                   |
| <b>Supported Releases</b>     | 10.2.0E or later                                                                                                                                                                                                                                                       |

## show mac address-table

Displays information about the MAC address table.

**Syntax** `show mac address-table [address mac-address | aging-time | [count [vlan vlan-id] | dynamic | interface {ethernet node/slot/port[:subport] | port-channel number}] | static [address mac-address] | vlan vlan-id`

- Parameters**
- `address mac-address` — (Optional) Displays MAC address table information.
  - `aging-time` — (Optional) Displays MAC address table aging-time information.
  - `count` — (Optional) Displays the number of dynamic and static MAC address entries.
  - `dynamic` — (Optional) Displays dynamic MAC address table entries only.
  - `interface` — Set the interface type:
    - `ethernet node/slot/port[:subport]` — Displays MAC address table information for a physical interface.
    - `port-channel channel-number` — Displays MAC address table information for a port-channel interface, from 1 to 128.
  - `static` — (Optional) Displays static MAC address table entries only.
  - `vlan vlan-id` — (Optional) Displays VLAN information only, from 1 to 4093.

**Default** Not configured

**Command Mode** EXEC

**Usage Information** The network device maintains static MAC address entries saved in the startup configuration file, and reboots and deletes dynamic entries.

**Example (Address)**

```
OS10# show mac address-table address 90:b1:1c:f4:a6:8f
VlanId Mac Address Type Interface
1 90:b1:1c:f4:a6:8f dynamic ethernet1/1/3
```

**Example (Aging Time)**

```
OS10# show mac address-table aging-time
Global Mac-address-table aging time : 1800
```

**Example (Count)**

```
OS10# show mac address-table count
MAC Entries for all vlans :
Dynamic Address Count : 5
Static Address (User-defined) Count : 0
Total MAC Addresses in Use: 5
```

### Example (Dynamic)

```
OS10# show mac address-table dynamic
VlanId Mac Address Type Interface
1 90:b1:1c:f4:a6:8f dynamic ethernet1/1/3
```

### Example (Ethernet)

```
OS10# show mac address-table interface ethernet 1/1/3
VlanId Mac Address Type Interface
1 66:38:3a:62:31:3a dynamic ethernet1/1/3
```

**Supported Releases** 10.2.0E or later

## Spanning-tree protocol

This section describes how spanning-tree features work and also about the different variants of STP.

### Configuration notes

Dell EMC PowerSwitch S5200-ON Series and Z9332F-ON Series:

For RPVST with force-version STP convergence to work, ensure that the default VLAN is set to VLAN1. You must not configure it to any VLAN number other than VLAN1.

## Introduction to STP

The spanning-tree protocol is a Layer 2 network protocol that prevents loops in a network topology. Spanning-tree is useful when more than one network path exists and devices in the network are either competing for or sharing these paths.

By eliminating loops, the protocol improves scalability in a large network and allows you to implement redundant paths, which can be activated when the active paths fail.

Layer 2 loops occur in a network due to poor network design and without enabling xSTP protocols, can cause high switch CPU utilization and memory consumption.

**NOTE:** In L2 single rack, OS10 CLI is used to configure the spanning tree. For L3 fabric, SFS GUI is used to configure the spanning tree.

## Supported STP modes

The following variants of spanning-tree protocols are used in OS10 to provide a loop free layer 2 topology:

- Rapid Spanning Tree protocol can be seen as an evolution of the 802.1D standard. Primarily RSTP is created to address the slow convergence nature of STP protocol (802.1D).
- Multiple Spanning Tree protocol (MSTP) defined in IEEE standard (802.1s), is an evolution of spanning tree protocols allowing creation of multiple instance of spanning tree and mapping multiple VLANs to a specific spanning tree instance.
- Rapid per-VLAN spanning-tree protocol (Rapid-PVST) is a variant of RSTP protocol and supports creation of per VLAN spanning tree instance to isolate link fluctuations only to a particular VLAN segment and also helps in load balancing across different links.
- 802.1D STP Compatibility mode support. This mode enables the bridge to function as an IEEE Std 802.1D legacy STP compatible mode while the system is running RSTP or MSTP modes of the spanning tree protocol.
- RSTP and MSTP are backward compatible with STP 802.1D. When an interface receives STP BPDU, the system responds with the STP version of BPDU.

## Change STP modes

The default xSTP variant running in OS10 is Rapid-PVST. You can change the mode to RSTP or MSTP using the `spanning-tree mode {rstp | mst | rapid-pvst}` command.

## Mode specific functionality

### Enable and disable STP

Spanning Tree Protocol (STP) is enabled by default on the switches. You can disable the STP globally on the switch or at the interface level.

Disabling spanning tree at an instance level causes all the port members of that instance to disable the spanning tree. This moves the port to the Forwarding / Blocking state based on the operational status of the ports.

Use the `spanning-tree disable` command to disable the STP.

### Backward compatibility and interoperability

Spanning tree modes are backward compatible and inter-operable with STP version.

### BPDU extensions

STP extensions provide a means to ensure efficient network convergence by securely enforcing the active network topology. OS10 supports BPDU filtering, BPDU guard, root guard, and loop guard STP extensions.

The system discards regular data traffic after a BPDU violation.

|                       |                                                                                                                                                                                                                                                                                                                                                                                                                                                                                                                                                                                                                                                                                                                                                               |
|-----------------------|---------------------------------------------------------------------------------------------------------------------------------------------------------------------------------------------------------------------------------------------------------------------------------------------------------------------------------------------------------------------------------------------------------------------------------------------------------------------------------------------------------------------------------------------------------------------------------------------------------------------------------------------------------------------------------------------------------------------------------------------------------------|
| <b>BPDU filtering</b> | Stops sending or receiving BPDUs from a faulty device, there by protecting the network from unexpected flooding of BPDUs. Enabling BPDU Filtering on an interface causes the system to stop sending or receiving BPDUs.                                                                                                                                                                                                                                                                                                                                                                                                                                                                                                                                       |
| <b>BPDU guard</b>     | Blocks the L2 bridged ports and LAG ports connected to end hosts and servers from receiving any BPDUs. When you enable BPDU guard and when the BPDU frames are being received on the interface, the bridge or LAG is placed in the blocking state. In case of a LAG, ports are either STP blocked or shutdown based on the error disable command action. The data traffic is dropped but the port continues to forward BPDUs to the CPU that are later dropped. To prevent further reception of BPDUs, configure a port to shut down using the <code>error disable</code> command. For more information on this command.                                                                                                                                      |
| <b>Root guard</b>     | Preserves the root bridge position during network transitions. STP selects the root bridge with the lowest priority value. During network transitions, another bridge with a lower priority may attempt to become the root bridge and cause unpredictable network behavior. To avoid such an attempt and to preserve the position of the root bridge, configure the <code>spanning-tree guard root</code> command. This configuration places the port in an inconsistent state if the port receives superior BPDU. Root guard is enabled only on designated ports. The root guard configuration applies to all VLANs configured on the port.                                                                                                                  |
| <b>Loop guard</b>     | Prevents L2 forwarding loops caused by a cable or interface hardware failure. When a hardware failure occurs, a participating spanning-tree link becomes unidirectional and the port stops receiving BPDUs. When the blocked port stops receiving BPDUs, it transitions to a Forwarding state causing spanning-tree loops in the network. Enable loop guard using the <code>spanning-tree guard loop</code> command on an interface so that it transitions to the Loop-Inconsistent state until it receives BPDUs. After BPDUs are received, the port moves out of the Loop-Inconsistent or Blocking state and transitions to an appropriate state determined by STP. Enabling loop guard on a per-port basis enables it on all VLANs configured on the port. |

#### NOTE:

1. Root guard and Loop guard are mutually exclusive.
2. Configuring one overwrites the other from the active configuration.

1. Enable spanning-tree BPDU filter in INTERFACE mode.

```
spanning-tree bpdupfilter enable
```

2. Enable STP BPDU guard in INTERFACE mode.

```
spanning-tree bpduguard enable
```

BPDU guard violation causes the system to perform the following actions in the port channel:



- The interface and all member ports are disabled in the hardware.
- When the port is added to the port channel that is in the Error Disable state, the new member port is disabled in the hardware.
- When the port is removed from the port channel that is in the Error Disable state, the system clears the Error\_Disabled state on the physical port and enables it in the hardware.

To clear the Error Disabled state:

- Use the `shutdown` command on the interface.
- Use the `spanning-tree bpduguard disable` command to disable the BPDU guard on the interface.
- Use the `spanning-tree disable` command to disable STP on the interface.

### 3. Set the guard types to avoid loops in INTERFACE mode.

```
spanning-tree guard {loop | root | none}
```

- `loop` — Set the guard type to loop.
- `root` — Set the guard type to root.
- `none` — Set the guard type to none.

#### Port enabled with loop guard conditions

- Loop guard is supported on any STP-enabled port or port-channel interface.
- You cannot enable root guard and loop guard at the same time on an STP port. The loop guard configuration overwrites an existing root guard configuration and vice versa.
- Enabling BPDU guard and loop guard at the same time on a port results in a port that remains in blocking state and prevents traffic from flowing through it. For example, when you configure both Portfast BPDU guard and loop guard:
  - If a BPDU is received from a remote device, BPDU guard places the port in the Err-Disabled Blocking state and no traffic forwards on the port.
  - If no BPDU is received from a remote device which was sending BPDUs, loop guard places the port in the Loop-Inconsistent Blocking state and no traffic forwards on the port.
- When used in a Rapid-PVST network, STP loop guard performs per-port or per port-channel at a VLAN level. If no BPDUs are received on a port-channel interface, the port or port-channel transitions to a Loop-Inconsistent or Blocking state only for this VLAN.

#### BPDU filter

```
os10(conf-if-eth1/1/7)# spanning-tree bpdufilter enable
os10(conf-if-eth1/1/7)# do show spanning-tree interface ethernet 1/1/7
ethernet1/1/7 of vlan 1 is Designated Forwarding
Edge port: No (default)
Link type: point-to-point (auto)
Boundary: No, Bpdu-filter: Enable, Bpdu-Guard: Disable, Shutdown-on-Bpdu-Guard-
violation: No
Root-Guard: Disable, Loop-Guard: Disable
Bpdus (MRecords) Sent: 6, Received: 6410
Interface
Name PortID Prio Cost Sts Cost Designated

--
ethernet1/1/7 128.56 128 500 FWD 500 32769 90b1.1cf4.a625 128.56
```

#### BPDU guard

```
os10(config)# interface ethernet 1/1/7
os10(conf-if-eth1/1/7)# spanning-tree bpduguard enable
os10(conf-if-eth1/1/7)# do show spanning-tree interface ethernet 1/1/7
ethernet1/1/7 of vlan 1 is Designated Forwarding
Edge port: No (default)
Link type: point-to-point (auto)
Boundary: No, Bpdu-filter: Enable, Bpdu-Guard: Enable, Shutdown-on-Bpdu-Guard-
violation:
Yes
Root-Guard: Disable, Loop-Guard: Disable
Bpdus (MRecords) Sent: 6, Received: 6410
Interface
Name PortID Prio Cost Sts Cost Designated

PortID

```

```

ethernet1/1/7 128.56 128 500 FWD 500 32769 90b1.1cf4.a625
128.56

```

## Loop guard

```

OS10(config)# interface ethernet 1/1/4
OS10(config-if-eth1/1/4)# spanning-tree guard loop
OS10(config-if-eth1/1/4)# do show spanning-tree interface ethernet 1/1/4
ethernet1/1/4 of vlan1 is root Forwarding
Edge port:no (default) port guard :none (default)
Link type is point-to-point (auto)
Boundary: NO bpduguard filter : bpduguard shutdown-on-
violation :disable RootGuard: disable LoopGuard enable
Bpdus (MRecords) sent 7, received 20
Interface
Name PortID Prio Cost Sts Cost Bridge ID Designated

ethernet1/1/4 128.272 128 500 FWD 0 32769 90b1.1cf4.9d3b 128.272

```

## Root guard

```

os10(config-if-eth1/1/7)# spanning-tree guard root
os10(config-if-eth1/1/7)# do show spanning-tree interface ethernet 1/1/7
ethernet1/1/7 of vlan 1 is Designated Forwarding
Edge port: No (default)
Link type: point-to-point (auto)
Boundary: No, Bpdu-filter: Enable, Bpdu-Guard: Enable, Shutdown-on-Bpdu-Guard-violation:
Yes
Root-Guard: Enable, Loop-Guard: Disable
Bpdus (MRecords) Sent: 6, Received: 6410
Interface
Name PortID Prio Cost Sts Cost Designated
Bridge ID

ethernet1/1/7 128.56 128 500 FWD 500 32769 90b1.1cf4.a625
128.56

```

## Recover from BPDU guard violations

1. When there is BPDU guard violation on a port, OS10 either shuts down the port or moves it to BLOCKED state. Use the following command in CONFIGURATION mode to shutdown the port. The `no` version of the command moves the port to BLOCKED state.

```
errdisable detect cause bpduguard
```

2. In CONFIGURATION mode, use the following command to recover the ports from shutting down due to the detection of a BPDU Guard violation. When the recovery option is enabled, the port is brought up after the recovery timer expires. The default recovery timer value is 300 seconds. When the recovery option is disabled, the port remains shut down indefinitely. You must manually bring up the port using the `shutdown` and `no shutdown` commands.

```
errdisable recovery cause bpduguard
```

The `no` version of the command disables the recovery option.

3. To change the recover timer value, use the following command in CONFIGURATION mode. This recovery timer value is applicable only for shutdown case. For Blocking case, the default value of 300 seconds is used.

```
errdisable recovery interval interval-value
```

## Example configuration

```

OS10(config)# errdisable detect cause bpduguard
OS10(config)# errdisable recovery interval 45
OS10(config)# errdisable recovery cause bpduguard

```

## View detect and recovery details

```
OS10# show errdisable detect
```

| Error-Disable Cause | Detect Status |
|---------------------|---------------|
| bpduguard           | Enabled       |

```
OS10# show errdisable recovery
```

```
Error-Disable Recovery Timer Interval: 300 seconds
```

| Error-Disable Reason | Recovery Status |
|----------------------|-----------------|
| bpduguard            | Enabled         |

| Interface        | Errdisable Cause | Recovery Time left (seconds) |
|------------------|------------------|------------------------------|
| ethernet 1/1/1:1 | bpduguard        | 273                          |
| ethernet 1/1/2   | bpduguard        | 4                            |
| port-channel 12  | bpduguard        | 45                           |

## MAC flush optimization

OS10 offers a MAC address clearing technique that optimizes the number of MAC flush calls sent by the Spanning Tree Protocol (STP) module.

If the number of calls sent to the hardware is too high, traffic is dropped or flooded impacting system performance. To prevent traffic drops and flooding, you can use the MAC flush optimization feature.

This feature fine-tunes the MAC flush-related parameters, such as the MAC flush threshold and the MAC flush timer to reduce the number of calls sent to the hardware. The clear request sent to clear the MAC address table entry is called a flush indication. The number of calls that are sent is displayed as flush invocations in the show spanning-tree command.

You can enable the MAC flush optimization feature by setting the MAC flush timer to a non-zero value. This feature is enabled by default with a default timer value of 200 centi-seconds.

To disable MAC flush optimization, configure the MAC flush timer value to 0.

When you configure the MAC flush timer to a non-zero value and the threshold to zero, the system invokes instance-based flush once and starts the timer. When the timer expires, the system invokes an instance-based flush again.

The show spanning-tree {brief | details | active} command displays the following information:

```
Flush Interval 200 centi-sec, Flush Invocations 32
Flush Indication threshold 2
```

By default, this feature is enabled for RSTP, Rapid-PVST and MSTP. This feature is useful in a scalable topology with MSTP & rapid-PVST (multi-instance), where multiple MAC flush calls are invoked.

### RSTP

RSTP allows per port-based flush until the number of calls sent is equal to the MAC flush threshold value that you have configured.

When the number of calls that are sent reaches the configured threshold, RSTP ignores further per-port based flush and starts the MAC flush timer. When the timer expires, RSTP invokes an entire table flush, where it requests one flush for all the ports.

RSTP is a single instance and hence, MAC flush optimization is not required. However, to enable this feature, configure the MAC flush timer to a non-zero value. This configuration is applied globally and applies for RSTP, MSTP, and rapid-PVST. This configuration is retained when you change the STP mode.

For RSTP, the threshold is set to a higher value (65,535) because RSTP does not require this optimization. Even when this feature is enabled, the global flush is invoked only after the flush count reaches 65,535.

### MSTP

MSTP allows (VLAN-list, port) based flush until the number of calls sent is equal to the MAC flush threshold value that you have configured.

When the number of calls exceeds the configured threshold, MSTP ignores further (VLAN-list, port) based flush and starts the MAC flush timer. When the timer starts, the system blocks all further flush indications. When the timer expires for that specific instance, the system triggers instance-based flushing.

The default MAC flush threshold value for MSTP is 5.

### Rapid-PVST

Rapid-PVST allows (VLAN, port) based flush until the number of calls sent is equal to the MAC flush threshold value that is configured.

When the number of calls sent exceeds the configured threshold, rapid-PVST ignores further (VLAN, port) based flush and starts the MAC flush timer. When the timer starts, the system blocks further flush. When the timer expires for that specific instance, the system triggers VLAN-based flushing.

By default, the MAC flush threshold value is set to 5. However, Dell EMC recommends that you configure this value based on the number of ports that participate in the STP topology.

## Spanning-tree link type for rapid state transitions

As specified in IEEE 802.1w, OS10 assumes a port that runs in full-duplex mode is a point-to-point link. A point-to-point link transitions to forwarding state faster. By default, OS10 derives the link type of a port from the duplex mode. You can override the duplex mode using the `spanning-tree link-type` command.

OS10 assumes a port that runs in half-duplex mode is a shared link, to which the fast transition feature is not applicable. Also, if you explicitly designate a port as a shared link, you cannot use the fast transition feature, regardless of the duplex setting.

To hasten the spanning-tree state transitions, you can set the link type to point-to-point. To set the link type to point-to-point:

- Use the following command in INTERFACE mode.

```
spanning-tree link-type point-to-point
```

## Dynamic path cost calculation

Path cost of an interface (physical or port-channel) is calculated based on the speed of the port or port-channel. When the speed of the port or port-channel changes, the path cost recalculation is triggered based on the user defined configuration.

You can enable/disable dynamic recalculation of path cost using the `spanning-tree path-cost` command.

This cmd allows the protocol to do dynamic cost calculation whenever the channel-members are added or deleted. By default, this dynamic path cost calculation is enabled.

When dynamic path cost is disabled, protocol calculate the path cost when the port channel is coming up for the first time after creation or whenever dynamic path cost calculation is enabled and then disabled by management or when the user adds/removes member port to/from the port channel.

This feature allows the user to disable path cost re-calculation on link flap events. If disabled, the path cost of the lag is calculated based on the below formula  $LAG\ speed = speed\ of\ a\ single\ member * number\ of\ configured\ member\ ports$  (irrespective of its oper status).

Path cost changes only for the user event [addition/removal of channel-member]. Path cost is calculated based on the number of configured ports.

Dynamic path cost disable functionality is supported for VLT port channel.

## Debug facilities

Use the debug `spanning-tree bpdu` command to monitor and verify that the MST configuration is communicating as configured. To ensure all necessary parameters match — region name, region version, and VLAN to instance mapping, examine your individual devices. Use the `show spanning-tree mst` command to view the MST configuration, or use the `show running-configuration` command to view the overall MST configuration.

### MST flags for communication received from the same region

The MST routers are located in the same region. If the debug logs indicate that packets are coming from a *Different Region*, one of the key parameters does not match.

**MST region name and revision** The configured name and revisions must be identical among all devices. If the region name is blank, a name was configured on one device and was not configured or was configured differently on another — spelling and capitalization count.

**MST instances** Verify the VLAN-to-MST instance mapping using the `show` commands. If you see *extra* MST instances in the Sending or Received logs, an additional MST instance was configured on one router but not the others.

- View BPDUs in EXEC mode.

```
debug spanning-tree bpdu
```

- View MST-triggered topology change messages in EXEC mode.

```
debug spanning-tree events
```

### View MST configuration

```
OS10# show spanning-tree mst configuration
Region Name: force10
Revision: 100
MSTI VID
0 1,31-4093
1 2-10
2 11-20
3 21-30
```

## EdgePort

EdgePort allows the interface to forward traffic approximately 30 seconds sooner as it skips the Blocking and Learning states.

**⚠ CAUTION: Configure EdgePort only on links connecting to an end station. EdgePort can cause loops if you enable it on an interface connected to a network. Edge ports do not receive BPDUs.**

**ℹ NOTE:** Whenever a port becomes a designated port, it will start a timer called the edge delay while timer ( $\text{hello-time} + 1/2 * \text{hello-time}$ ); if the hello-time is set to 2 seconds, the edge delay while timer is 3 seconds. If BPDUs are not received for 3 seconds, then the port is declared as open edge on the fly and is moved to forwarding state.

OS10 supports auto edge feature . If the port does not receive BPDU for the hello-time + one second interval then it places the port into auto edge mode.

If the edge port receives any BPDU, it loses the edge port property.

- Enable EdgePort on an interface in INTERFACE mode.

```
spanning-tree port type edge
```

### Configure EdgePort

```
OS10(conf-if-eth1/1/4)# spanning-tree port type edge
```

### View interface status

```
os10# show spanning-tree interface ethernet 1/1/7
ethernet1/1/7 of vlan 1 is Designated Forwarding
Edge port: No (default)
Link type: point-to-point (auto)
Boundary: No, Bpdu-filter: Enable, Bpdu-Guard: Enable, Shutdown-on-Bpdu-Guard-violation:
Yes
Root-Guard: Enable, Loop-Guard: Disable
Bpdus (MRecords) Sent: 6, Received: 6410
Interface
Name PortID Prio Cost Sts Cost Designated
PortID

```

```
ethernet1/1/7 128.56 128 500 FWD 500 32769 90b1.1cf4.a625
128.56
```

## Common STP commands

This section explains about the common commands in STP. STP variant specific commands are explained in the individual sections under RSTP, MSTP, and Rapid-PVST.

There are two sets of STP related commands.

- STP commands that are common and can be used irrespective of the STP variant enabled on the device.
- STP commands that are specific to the particular STP variant.

### clear spanning-tree counters

Clears the counters for STP.

**Syntax** `clear spanning-tree counters [interface {ethernet node/slot/port[:subport] | port-channel number}]`

- Parameters**
- `interface` — Enter the interface type:
    - `ethernet node/slot/port[:subport]` — Deletes the spanning-tree counters from a physical port.
    - `port-channel number` — Deletes the spanning-tree counters for a port-channel interface, from 1 to 128.

**Default** Not configured

**Command Mode** EXEC

**Usage Information** Clear all STP counters on the device per the Ethernet interface or port-channel.

**Example**

```
OS10# clear spanning-tree counters interface port-channel 10
```

**Supported Releases** 10.2.0E or later

### debug spanning-tree

Enables STP to debug and display protocol information.

**Syntax** `debug spanning-tree {all | bpdu [tx | rx] | events}`

- Parameters**
- `all` — Debugs all spanning-tree operations.
  - `bpdu` — Enter transmit (*tx*) or receive (*rx*) to enable the debug direction.
  - `events` — Debugs STP events.

**Default** Not configured

**Command Mode** EXEC

**Usage Information** None

**Example**

```
OS10# debug spanning-tree bpdu rx
```

**Supported Releases** 10.5.0 or later

## errdisable detect cause bpduguard

Configures the port to be shut down or moves the port to blocked state on detecting a BPDU guard violation.

|                          |                                                                                                                                                                                                                                                                                                                                                                                                                                                                                                                                                                                                                                                                      |
|--------------------------|----------------------------------------------------------------------------------------------------------------------------------------------------------------------------------------------------------------------------------------------------------------------------------------------------------------------------------------------------------------------------------------------------------------------------------------------------------------------------------------------------------------------------------------------------------------------------------------------------------------------------------------------------------------------|
| <b>Syntax</b>            | <code>errdisable detect cause bpduguard</code>                                                                                                                                                                                                                                                                                                                                                                                                                                                                                                                                                                                                                       |
| <b>Parameters</b>        | None                                                                                                                                                                                                                                                                                                                                                                                                                                                                                                                                                                                                                                                                 |
| <b>Default</b>           | Enabled                                                                                                                                                                                                                                                                                                                                                                                                                                                                                                                                                                                                                                                              |
| <b>Command Mode</b>      | CONFIGURATION                                                                                                                                                                                                                                                                                                                                                                                                                                                                                                                                                                                                                                                        |
| <b>Usage Information</b> | <p>This command applies only to STP-enabled ports. The command takes effect only when the BPDU guard is configured on a port.</p> <p>When the detect cause option is enabled, the port is shut down whenever there is a BPDU guard violation.</p> <p>When the option is disabled, the port is not shut down but moved to BLOCKING state whenever there is a BPDU guard violation. In this case, the port is operationally DOWN in spanning-tree mode and when the recovery timer expires after 300 seconds, the port is UP irrespective of the recovery cause configuration.</p> <p>The <code>no</code> version of the command disables the detect cause option.</p> |

### Example

```
OS10(config)# errdisable detect cause bpduguard
```

**Supported Releases** 10.4.2.0 or later

## errdisable recovery cause bpduguard

Enables to recover the ports shut down due to BPDU Guard violation.

|                          |                                                                                                                                                                                                                                                                                                                                                                                                                                                                                                                                                                              |
|--------------------------|------------------------------------------------------------------------------------------------------------------------------------------------------------------------------------------------------------------------------------------------------------------------------------------------------------------------------------------------------------------------------------------------------------------------------------------------------------------------------------------------------------------------------------------------------------------------------|
| <b>Syntax</b>            | <code>errdisable recovery cause bpduguard</code>                                                                                                                                                                                                                                                                                                                                                                                                                                                                                                                             |
| <b>Parameters</b>        | None                                                                                                                                                                                                                                                                                                                                                                                                                                                                                                                                                                         |
| <b>Default</b>           | Disabled                                                                                                                                                                                                                                                                                                                                                                                                                                                                                                                                                                     |
| <b>Command Mode</b>      | CONFIGURATION                                                                                                                                                                                                                                                                                                                                                                                                                                                                                                                                                                |
| <b>Usage Information</b> | <p>This command applies only to STP-enabled ports. The command takes effect only when BPDU guard is configured on a port and <code>errdisable detect cause bpduguard</code> is enabled.</p> <p>When the recovery option is enabled, the port is brought up after the recovery timer expires.</p> <p>When the recovery option is disabled, the port is shut down indefinitely. You must manually bring up the port using the <code>shutdown</code> and <code>no shutdown</code> commands.</p> <p>The <code>no</code> version of the command disables the recovery option.</p> |

### Example

```
OS10(config)# errdisable recovery cause bpduguard
```

**Supported Releases** 10.4.2.0 or later

## errdisable recovery interval

Configures recovery interval timer to delay the recovery of ports when there is a BPDU Guard violation.

|                     |                                                                                           |
|---------------------|-------------------------------------------------------------------------------------------|
| <b>Syntax</b>       | <code>errdisable recovery interval <i>interval-value</i></code>                           |
| <b>Parameters</b>   | <i>interval-value</i> —Enter the time interval in seconds. The range is from 30 to 65535. |
| <b>Default</b>      | 300 seconds                                                                               |
| <b>Command Mode</b> | CONFIGURATION                                                                             |

|                           |                                                                                                                                                                                                                                                                                                                                                                                                                                   |
|---------------------------|-----------------------------------------------------------------------------------------------------------------------------------------------------------------------------------------------------------------------------------------------------------------------------------------------------------------------------------------------------------------------------------------------------------------------------------|
| <b>Usage Information</b>  | <p>This command applies only to STP-enabled ports. The command takes effect only when the BPDU guard is configured on a port. The recovery timer value is applicable only for shutdown case. For blocking case, the default value of 300 seconds is used.</p> <p>The recovery timer starts whenever there is a BPDU guard violation.</p> <p>The <code>no</code> version of the command resets the timer to the default value.</p> |
| <b>Example</b>            | <pre>OS10(config)# errdisable recovery interval 45</pre>                                                                                                                                                                                                                                                                                                                                                                          |
| <b>Supported Releases</b> | 10.4.2.0 or later                                                                                                                                                                                                                                                                                                                                                                                                                 |

## clear spanning-tree detected-protocol

Forces the ports to renegotiate with neighbors.

|                          |                                                                                                                                                                                                                                                                                                                                                                                |
|--------------------------|--------------------------------------------------------------------------------------------------------------------------------------------------------------------------------------------------------------------------------------------------------------------------------------------------------------------------------------------------------------------------------|
| <b>Syntax</b>            | <code>clear spanning-tree detected-protocol [interface {ethernet <i>node/slot/port[:subport]</i>   port-channel <i>number</i>}]</code>                                                                                                                                                                                                                                         |
| <b>Parameters</b>        | <ul style="list-style-type: none"> <li>• <code>interface</code> — Enter the interface type: <ul style="list-style-type: none"> <li>◦ <code>ethernet <i>node/slot/port[:subport]</i></code> — Enter the Ethernet interface information, from 1 to 48.</li> <li>◦ <code>port-channel <i>number</i></code> — Enter the port-channel number, from 1 to 128.</li> </ul> </li> </ul> |
| <b>Default</b>           | Not configured                                                                                                                                                                                                                                                                                                                                                                 |
| <b>Command Mode</b>      | EXEC                                                                                                                                                                                                                                                                                                                                                                           |
| <b>Usage Information</b> | Use this command to force the port to re-negotiate with neighbors. If you use this command without parameters, the command applies to each device port.                                                                                                                                                                                                                        |
| <b>Example</b>           | <pre>OS10# clear spanning-tree detected-protocol interface ethernet 1/1/1</pre>                                                                                                                                                                                                                                                                                                |
| <b>Supported Release</b> | 10.2.0E or later                                                                                                                                                                                                                                                                                                                                                               |

## spanning-tree bpdudfilter

Enables or disables BPDU filtering on an interface.

|                           |                                                                                                                                                                                                |
|---------------------------|------------------------------------------------------------------------------------------------------------------------------------------------------------------------------------------------|
| <b>Syntax</b>             | <code>spanning-tree bpdudfilter {enable   disable}</code>                                                                                                                                      |
| <b>Parameters</b>         | <ul style="list-style-type: none"> <li>• <code>enable</code> — Enables the BPDU filter on an interface.</li> <li>• <code>disable</code> — Disables the BPDU filter on an interface.</li> </ul> |
| <b>Default</b>            | Disabled                                                                                                                                                                                       |
| <b>Command Mode</b>       | INTERFACE                                                                                                                                                                                      |
| <b>Usage Information</b>  | Use the <code>enable</code> parameter to enable BPDU filtering.                                                                                                                                |
| <b>Example</b>            | <pre>OS10(conf-if-eth1/1/4)# spanning-tree bpdudfilter enable</pre>                                                                                                                            |
| <b>Supported Releases</b> | 10.2.0E or later                                                                                                                                                                               |



## spanning-tree bpduguard

Enables or disables the BPDU guard on an interface.

|                           |                                                                                                                                                                                                         |
|---------------------------|---------------------------------------------------------------------------------------------------------------------------------------------------------------------------------------------------------|
| <b>Syntax</b>             | <code>spanning-tree bpduguard {enable   disable}</code>                                                                                                                                                 |
| <b>Parameters</b>         | <ul style="list-style-type: none"><li>• <code>enable</code> — Enables the BPDU guard filter on an interface.</li><li>• <code>disable</code> — Disables the BPDU guard filter on an interface.</li></ul> |
| <b>Default</b>            | Disabled                                                                                                                                                                                                |
| <b>Command Mode</b>       | INTERFACE                                                                                                                                                                                               |
| <b>Usage Information</b>  | BPDU guard prevents a port from receiving BPDUs. If the port receives a BPDU, it is placed in the Error-Disabled state.                                                                                 |
| <b>Example</b>            | <pre>OS10(conf-if-eth1/1/4)# spanning-tree bpduguard enable</pre>                                                                                                                                       |
| <b>Supported Releases</b> | 10.2.0E or later                                                                                                                                                                                        |

## spanning-tree disable

Disables Spanning-Tree mode configured with the `spanning-tree mode` command globally on the switch or specified interfaces.

|                           |                                                                                                                         |
|---------------------------|-------------------------------------------------------------------------------------------------------------------------|
| <b>Syntax</b>             | <code>spanning-tree disable</code>                                                                                      |
| <b>Parameters</b>         | None                                                                                                                    |
| <b>Default</b>            | Not configured.                                                                                                         |
| <b>Usage Information</b>  | The <code>no</code> version of this command re-enables STP and applies the currently configured spanning-tree settings. |
| <b>Command Mode</b>       | CONFIGURATION<br>INTERFACE                                                                                              |
| <b>Example</b>            | <pre>OS10(config)# interface ethernet 1/1/4 OS10(config-if-eth1/1/4)# spanning-tree disable</pre>                       |
| <b>Supported Releases</b> | 10.3.0E or later                                                                                                        |

## spanning-tree guard

Enables or disables loop guard or root guard on an interface.

|                          |                                                                                                                                                                                                                                        |
|--------------------------|----------------------------------------------------------------------------------------------------------------------------------------------------------------------------------------------------------------------------------------|
| <b>Syntax</b>            | <code>spanning-tree guard {loop   root   none}</code>                                                                                                                                                                                  |
| <b>Parameters</b>        | <ul style="list-style-type: none"><li>• <code>loop</code> — Enables loop guard on an interface.</li><li>• <code>root</code> — Enables root guard on an interface.</li><li>• <code>none</code> — Sets the guard mode to none.</li></ul> |
| <b>Default</b>           | Not configured                                                                                                                                                                                                                         |
| <b>Usage Information</b> | Root guard and loop guard configurations are mutually exclusive. Configuring one overwrites the other from the active configuration.                                                                                                   |
| <b>Command Mode</b>      | INTERFACE                                                                                                                                                                                                                              |
| <b>Example</b>           | <pre>OS10(conf-if-eth1/1/4)# spanning-tree guard root</pre>                                                                                                                                                                            |

**Supported Releases** 10.2.0E or later

## spanning-tree link-type

Sets the spanning-tree link-type for faster convergence.

**Syntax** `spanning-tree link-type {auto | point-to-point | shared}`

**Parameters**

- `auto` — Enter the keyword to sets the link-type based on the duplex setting of the interface.
- `point-to-point`—Specifies that the interface is a point-to-point or full-duplex link.
- `shared`—Specifies that the interface is a half-duplex medium.

**Default** Auto

**Command Mode** INTERFACE

**Usage Information** As specified in IEEE 802.1w, OS10 assumes a port that runs in full-duplex mode as a point-to-point link. A point-to-point link transitions to forwarding state faster. By default, OS10 derives the link-type of a port from the duplex mode. You can override the duplex mode using the `spanning-tree link-type` command.

As half-duplex mode is considered as a shared link, the fast transition feature is not applicable for shared links. If you designate a port as a shared link, you cannot use the fast transition feature, regardless of the duplex setting.

**Example**

```
OS10(config-inf)# spanning-tree link-type point-to-point
```

**Supported Releases** OS10 legacy command.

## spanning-tree mac-flush-timer

Enables or disables MAC flush optimization.

**Syntax** `spanning-tree mac-flush-timer timer-interval`

**Parameters** `timer-interval`—Enter the timer interval in centi-seconds, from 0 to 500. The default value is 200 milli-seconds.

**Default** Enabled

**Command Mode** CONFIGURATION

**Usage Information** This command configures the flush interval time in centi-seconds, and controls the number of calls invoked from the spanning-tree module. If the timer is set to 0, MAC flush optimization is disabled. If the timer is set to a non-zero value, instance-based flushing occurs based on the MAC flush threshold value. The `no` version of this command resets the flush-interval timer to the default value.

**Example**

```
OS10(config)# spanning-tree mac-flush-timer 500
```

```
OS10(config)# no spanning-tree mac-flush-timer
```

**Supported Releases** 10.4.3.0 or later

## spanning-tree mode rstp

Enables an STP type: RSTP.

**Syntax** `spanning-tree mode rstp`

|                           |                                                                                                                    |
|---------------------------|--------------------------------------------------------------------------------------------------------------------|
| <b>Parameters</b>         | <ul style="list-style-type: none"> <li>• <code>rstp</code> — Sets STP mode to RSTP.</li> </ul>                     |
| <b>Default</b>            | Rapid-PVST                                                                                                         |
| <b>Command Mode</b>       | CONFIGURATION                                                                                                      |
| <b>Usage Information</b>  | All STP instances stop in the previous STP mode and restart in the new mode. You can also change to RSTP/MST mode. |
| <b>Example</b>            | <pre>OS10(config)# spanning-tree mode rstp</pre>                                                                   |
| <b>Supported Releases</b> | 10.2.0E or later                                                                                                   |

## spanning-tree port

Sets the port type as the EdgePort.

|                           |                                                                                                                                                                                  |
|---------------------------|----------------------------------------------------------------------------------------------------------------------------------------------------------------------------------|
| <b>Syntax</b>             | <code>spanning-tree port type edge</code>                                                                                                                                        |
| <b>Parameters</b>         | None                                                                                                                                                                             |
| <b>Default</b>            | Not configured                                                                                                                                                                   |
| <b>Command Mode</b>       | INTERFACE                                                                                                                                                                        |
| <b>Usage Information</b>  | When you configure an EdgePort on a device running STP, the port immediately transitions to the Forwarding state. Only configured ports connected to end hosts act as EdgePorts. |
| <b>Example</b>            | <pre>OS10(config-inf)# spanning-tree port type edge</pre>                                                                                                                        |
| <b>Supported Releases</b> | 10.2.0E or later                                                                                                                                                                 |

## show errdisable

Displays information on errdisable configurations and port recovery status.

|                          |                                                                                                                                                                                                                                                                                  |
|--------------------------|----------------------------------------------------------------------------------------------------------------------------------------------------------------------------------------------------------------------------------------------------------------------------------|
| <b>Syntax</b>            | <code>show errdisable [detect   recovery]</code>                                                                                                                                                                                                                                 |
| <b>Parameters</b>        | <ul style="list-style-type: none"> <li>• <code>detect</code>—Displays whether error disable detection is enabled.</li> <li>• <code>recovery</code>—Displays details of recovery cause, recovery interval, and recovery status of the error disabled port.</li> </ul>             |
| <b>Default</b>           | None                                                                                                                                                                                                                                                                             |
| <b>Command Mode</b>      | EXEC                                                                                                                                                                                                                                                                             |
| <b>Usage Information</b> | The <code>Errdisable Cause</code> column displays one or more reasons for the error-disabled state of an interface. If an interface is put in to error disabled state for multiple reasons, the interface does not come up unless you enable automatic recovery for all reasons. |
| <b>Example</b>           | <pre>OS10# show errdisable detect  Error-Disable Cause          Detect Status ----- bpduguard                    Enabled  OS10# show errdisable recovery  Error-Disable Recovery Timer Interval : 300 seconds  Error-Disable Reason Recovery Status</pre>                        |

|                    |                                       |               |
|--------------------|---------------------------------------|---------------|
| bpduguard          | Enabled                               |               |
| MLL violation      | Enabled                               |               |
| MAC-move-violation | Enabled                               |               |
| Left               |                                       | Recovery Time |
| Interface          | Errdisable Cause                      | (seconds)     |
| ethernet1/1/1:1    | bpduguard                             | 30            |
| ethernet1/1/1:2    | bpduguard                             | 1             |
| ethernet1/1/10     | bpduguard/mac-learning-limit/mac-move | 10            |
| port-channel100    | Mac-learning-limit                    | 50            |
| port-channel128    | mac-move                              | 49            |

**Supported Releases** 10.4.2.0 or later

## show spanning-tree interface

Displays spanning-tree interface information for Ethernet and port-channels.

**Syntax** `show spanning-tree interface {ethernet node/slot/port [:subport] | port-channel port-id} [detail]`

- Parameters**
- `ethernet node/slot/port[:subport]` — Displays spanning-tree information for a physical interface.
  - `port-channel port-id` — Displays spanning-tree information for a port-channel number, from 1 to 128.
  - `detail` — (Optional) Displays detailed information on the interface.

**Default** Not configured

**Command Mode** EXEC

**Usage Information** None

### Example

```
os10# show spanning-tree interface ethernet 1/1/7 detail
Port 56 (ethernet1/1/7) of vlan1 is designated Forwarding
Port path cost 500, Port priority 128, Port Identifier 128.56
Designated root priority: 32769, address: 34:17:ec:37:14:00
Designated bridge priority: 32769, address: 90:b1:1c:f4:a6:25
Designated port ID: 128.56, designated path cost: 500
Number of transitions to forwarding state: 1
Edge port: No (default)
Link Type: Point-to-Point
BPDU Sent: 6, Received: 6410
```

**Supported Releases** 10.2.0E or later

## Rapid per-VLAN spanning-tree

Rapid per-VLAN spanning-tree (Rapid-PVST) is used to create a single topology per VLAN. Rapid-PVST is enabled by default; it provides faster convergence than STP and runs on the default VLAN (VLAN 1).

Configuring Rapid-PVST is a four-step process:

1. Ensure the interfaces are in L2 mode.
2. Place the interfaces in VLANs. By default, switchport interfaces are members of the default (VLAN1).
3. Enable Rapid-PVST. This step is only required if another variation of STP is present.
4. (Optional) Select a non-default bridge-priority for the VLAN for load balancing.

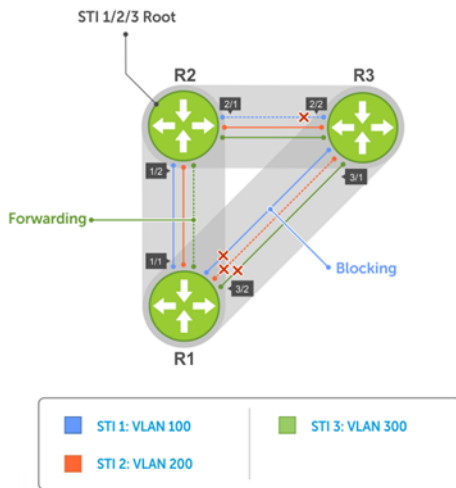

Each VLAN is assigned an incremental default bridge priority. For example, if VLAN 1 is assigned a bridge priority value of 32769, then VLAN 2 (if created) is assigned a bridge priority value of 32770; similarly, VLAN 10 (if created) is assigned a bridge priority value of 32778, and so on. All three instances have the same forwarding topology.

**NOTE:** Z9332F-ON supports a total of 64 instances, of which 3 VLANs are used for internal purposes. When you run Rapid-PVST flavor, each VLAN allocates one instance until the VLAN count reaches 61 and map the default instance after that.

## RSTP/MSTP/Rapid-PVST Force Version

RSTP/MSTP/Rapid-PVST is compatible and interoperable with the Spanning Tree Algorithm and Protocol (STP). An administrative Force Protocol Version parameter allows you to emulate the behavior of the previous versions of the spanning tree protocol that are not required for interoperability. The parameter applies to all the Bridge Ports.

### Force protocol version in RSTP

Spanning-tree RSTP force-version (STP)

- Setting the force version to STP forces the RSTP protocol to operate in 802.1D STP mode instead of the default protocol mode, RSTP.
- If the force version is STP, the rapid transitions are disabled.
- Default behavior is RSTP operation mode, which supports faster convergence.

### Force protocol version in MSTP

Spanning-tree MST force-version (STP/RSTP)

- Setting the force version to STP forces the MSTP protocol to operate in 802.1D STP mode instead of the default protocol mode, MSTP.
- If Force Protocol Version is STP, rapid transitions are disabled.
- Setting the force version to RSTP forces the MSTP protocol to operate in 802.1w RSTP mode instead of the default protocol mode, MSTP. In this mode, it transmits RST BPDU which skips the MSTI information.
- If Force Protocol Version is STP or RSTP, the received BPDUs are considered from a different MST Region.
- Default behavior is MSTP operation mode, which allows full MSTP behavior.
- OS10 does not support enabling force version per MST instance.

### Force protocol version in Rapid-PVST

Spanning-tree Rapid-PVST force-version (STP)

- Setting the force version to STP forces the Rapid-PVST protocol to operate in 802.1D STP mode instead of the default protocol mode RSTP on VLAN 1.
- If force version is STP, the rapid transitions are disabled on VLAN 1.
- OS10 does not support running force version STP on per VLAN level.

## Load balance and root selection

By default, all VLANs use the same forwarding topology — R2 is elected as the root and all 10G Ethernet ports have the same cost. Bridge priority can be modified for each VLAN to enable different forwarding topologies.

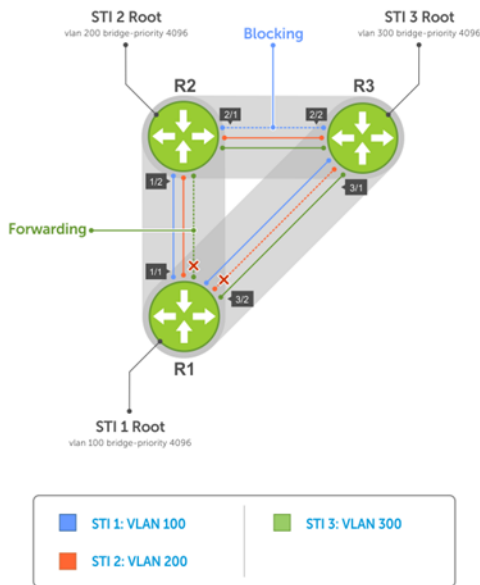

To achieve Rapid-PVST load balancing, assign a different priority on each bridge.

## Enable Rapid-PVST

By default, Rapid-PVST is enabled and creates an instance during VLAN creation. To participate in Rapid-PVST, port-channel or physical interfaces must be a member of a VLAN.

- Enable Rapid-PVST mode in CONFIGURATION mode.

```
spanning-tree mode rapid-pvst
```

### Configure Rapid-PVST

```
OS10(config)# spanning-tree mode rapid-pvst
```

### View Rapid-PVST configuration

```
os10# show spanning-tree active
Spanning tree enabled protocol rapid-pvst with force-version rstp
VLAN 1
Executing IEEE compatible Spanning Tree Protocol
Root ID Priority 32769, Address 3417.ec37.1400
Root Bridge hello time 2, max age 20, forward delay 15
Bridge ID Priority 32769, Address 90b1.1cf4.a625
Configured hello time 2, max age 20, forward delay 15
Flush Interval 200 centi-sec, Flush Invocations 8
Flush Indication threshold 5
Interface
Name PortID Prio Cost Sts Cost Designated Bridge ID PortID

ethernet1/1/5 128.40 128 500 BLK 500 32769 90b1.1cf4.9af2 128.40
ethernet1/1/6 128.48 128 500 BLK 500 32769 90b1.1cf4.9af2 128.48
ethernet1/1/7 128.56 128 500 FWD 500 32769 90b1.1cf4.a625 128.56
ethernet1/1/8 128.64 128 500 BLK 500 32769 90b1.1cf4.9af2 128.64
ethernet1/1/9 128.72 128 500 BLK 500 32769 90b1.1cf4.9af2 128.72
ethernet1/1/10 128.80 128 500 BLK 500 32769 90b1.1cf4.9af2 128.80
ethernet1/1/25 128.200 128 500 FWD 500 32769 90b1.1cf4.a625 128.200
ethernet1/1/26 128.208 128 500 FWD 0 32769 3417.ec37.1400 128.48
```

| Interface Name | Role | PortID  | Prio | Cost | Sts | Cost | Link-type |
|----------------|------|---------|------|------|-----|------|-----------|
| ethernet1/1/27 |      | 128.216 | 128  | 500  | BLK | 0    | 32769     |
| ethernet1/1/28 |      | 128.224 | 128  | 500  | BLK | 0    | 32769     |
| ethernet1/1/5  | Altr | 128.40  | 128  | 500  | BLK | 500  | AUTO      |
| ethernet1/1/6  | Altr | 128.48  | 128  | 500  | BLK | 500  | AUTO      |
| ethernet1/1/7  | Desg | 128.56  | 128  | 500  | FWD | 500  | AUTO      |
| ethernet1/1/8  | Altr | 128.64  | 128  | 500  | BLK | 500  | AUTO      |
| ethernet1/1/9  | Altr | 128.72  | 128  | 500  | BLK | 500  | AUTO      |
| ethernet1/1/10 | Altr | 128.80  | 128  | 500  | BLK | 500  | AUTO      |
| ethernet1/1/25 | Desg | 128.200 | 128  | 500  | FWD | 500  | AUTO      |
| ethernet1/1/26 | Root | 128.208 | 128  | 500  | FWD | 0    | AUTO      |
| ethernet1/1/27 | Altr | 128.216 | 128  | 500  | BLK | 0    | AUTO      |
| ethernet1/1/28 | Altr | 128.224 | 128  | 500  | BLK | 0    | AUTO      |

## Select the root bridge

Rapid-PVST determines the root bridge by the VLAN bridge priority. Assign one bridge a lower priority to increase the likelihood that it becomes the root bridge. The `show spanning-tree brief` command displays information about all ports regardless of the operational status.

- Assign a number as the bridge priority or designate it as the root in CONFIGURATION mode, from 0 to 61440.

```
spanning-tree {vlan vlan-id priority priority-value}
```

- `vlan-id` — Enter a value between 1 to 4093.
- `priority priority-value` — Enter the priority value in increments of 4096, default is 32768. The lower the number assigned, the more likely this bridge becomes the root bridge. The bridge priority the valid values are: 0, 4096, 8192, 12288, 16384, 20480, 24576, 28672, 32768, 36864, 40960, 45056, 49152, 53248, 57344, or 61440. All other values are rejected.

### Configure root bridge

```
OS10(config)# spanning-tree vlan 1 priority 4096
```

### View active configuration

```
OS10(config)# do show spanning-tree active
Spanning tree enabled protocol rapid-pvst with force-version rstp
VLAN 1
Executing IEEE compatible Spanning Tree Protocol
Root ID Priority 4097, Address 90b1.1cf4.a523
Root Bridge hello time 2, max age 20, forward delay 15
Bridge ID Priority 4097, Address 90b1.1cf4.a523
We are the root of VLAN 1
Configured hello time 2, max age 20, forward delay 15
Interface Name PortID Prio Cost Sts Cost Bridge ID Designated PortID

ethernet1/1/5 128.276 128 500 FWD 0 4097 90b1.1cf4.a523 128.276
ethernet1/1/6 128.280 128 500 FWD 0 4097 90b1.1cf4.a523 128.280
Interface Name Role PortID Prio Cost Sts Cost Link-type Edge

```

```

ethernet1/1/5 Desg 128.276 128 500 FWD 0 AUTO No
ethernet1/1/6 Desg 128.280 128 500 FWD 0 AUTO No

```

## View brief configuration

```

OS10# show spanning-tree brief
Spanning tree enabled protocol rapid-pvst with force-version rstp
VLAN 1
Executing IEEE compatible Spanning Tree Protocol
Root ID Priority 4097, Address 90b1.1cf4.a523
Root Bridge hello time 2, max age 20, forward delay 15
Bridge ID Priority 4097, Address 90b1.1cf4.a523
We are the root of VLAN 1
Configured hello time 2, max age 20, forward delay 15
Interface
Name PortID Prio Cost Sts Cost Bridge ID Designated PortID

ethernet1/1/1 128.260 128 200000000 FWD 0 32769 0000.0000.0000 128.260
ethernet1/1/2 128.264 128 200000000 FWD 0 32769 0000.0000.0000 128.264
ethernet1/1/3 128.268 128 200000000 FWD 0 32769 0000.0000.0000 128.268
ethernet1/1/4 128.272 128 200000000 FWD 0 32769 0000.0000.0000 128.272
ethernet1/1/5 128.276 128 500 FWD 0 4097 90b1.1cf4.a523 128.276
ethernet1/1/6 128.280 128 500 FWD 0 4097 90b1.1cf4.a523 128.280
ethernet1/1/7 128.284 128 200000000 FWD 0 32769 0000.0000.0000 128.284
ethernet1/1/8 128.288 128 200000000 FWD 0 32769 0000.0000.0000 128.288
ethernet1/1/9 128.292 128 200000000 FWD 0 32769 0000.0000.0000 128.292
ethernet1/1/10 128.296 128 200000000 FWD 0 32769 0000.0000.0000 128.296
ethernet1/1/11 128.300 128 200000000 FWD 0 32769 0000.0000.0000 128.300
ethernet1/1/12 128.304 128 200000000 FWD 0 32769 0000.0000.0000 128.304
ethernet1/1/13 128.308 128 200000000 FWD 0 32769 0000.0000.0000 128.308
ethernet1/1/14 128.312 128 200000000 FWD 0 32769 0000.0000.0000 128.312
ethernet1/1/15 128.316 128 200000000 FWD 0 32769 0000.0000.0000 128.316
ethernet1/1/16 128.320 128 200000000 FWD 0 32769 0000.0000.0000 128.320
ethernet1/1/17 128.324 128 200000000 FWD 0 32769 0000.0000.0000 128.324
ethernet1/1/18 128.328 128 200000000 FWD 0 32769 0000.0000.0000 128.328
ethernet1/1/19 128.332 128 200000000 FWD 0 32769 0000.0000.0000 128.332
ethernet1/1/20 128.336 128 200000000 FWD 0 32769 0000.0000.0000 128.336
ethernet1/1/21 128.340 128 200000000 FWD 0 32769 0000.0000.0000 128.340
ethernet1/1/22 128.344 128 200000000 FWD 0 32769 0000.0000.0000 128.344
ethernet1/1/23 128.348 128 200000000 FWD 0 32769 0000.0000.0000 128.348
ethernet1/1/24 128.352 128 200000000 FWD 0 32769 0000.0000.0000 128.352
ethernet1/1/25 128.356 128 200000000 FWD 0 32769 0000.0000.0000 128.356
ethernet1/1/26 128.360 128 200000000 FWD 0 32769 0000.0000.0000 128.360
ethernet1/1/27 128.364 128 200000000 FWD 0 32769 0000.0000.0000 128.364
ethernet1/1/28 128.368 128 200000000 FWD 0 32769 0000.0000.0000 128.368
ethernet1/1/29 128.372 128 200000000 FWD 0 32769 0000.0000.0000 128.372
ethernet1/1/30 128.376 128 200000000 FWD 0 32769 0000.0000.0000 128.376
ethernet1/1/31 128.380 128 200000000 FWD 0 32769 0000.0000.0000 128.380
ethernet1/1/32 128.384 128 200000000 FWD 0 32769 0000.0000.0000 128.384
Interface
Name Role PortID Prio Cost Sts Cost Link-type Edge

ethernet1/1/1 Disb 128.260 128 200000000 FWD 0 AUTO No
ethernet1/1/2 Disb 128.264 128 200000000 FWD 0 AUTO No
ethernet1/1/3 Disb 128.268 128 200000000 FWD 0 AUTO No
ethernet1/1/4 Disb 128.272 128 200000000 FWD 0 AUTO No
ethernet1/1/5 Desg 128.276 128 500 FWD 0 AUTO No
ethernet1/1/6 Desg 128.280 128 500 FWD 0 AUTO No
ethernet1/1/7 Disb 128.284 128 200000000 FWD 0 AUTO No
ethernet1/1/8 Disb 128.288 128 200000000 FWD 0 AUTO No
ethernet1/1/9 Disb 128.292 128 200000000 FWD 0 AUTO No
ethernet1/1/10 Disb 128.296 128 200000000 FWD 0 AUTO No
ethernet1/1/11 Disb 128.300 128 200000000 FWD 0 AUTO No

```

## Root assignment

Rapid-PVST assigns the root bridge according to the lowest bridge ID. Primary configuration assigns 24576 as the bridge priority whereas secondary configuration assigns 28672 as the bridge priority.



spanning-tree vlan *vlan-id* root primary command ensures that the switch has the lowest bridge priority value by setting the predefined value of 24,576. If an alternate root bridge is required, use the spanning-tree vlan *vlan-id* root secondary command. The command sets the priority for the switch to the predefined value of 28,672. If the primary root bridge fails, the command ensures that the alternate switch becomes the root bridge. It also assumes that the other switches in the network have a defined default priority value of 32,768.

- Configure the device as the root or secondary root in CONFIGURATION mode.

```
spanning-tree vlan vlan-id root {primary | secondary}
```

- *vlan-id* — Enter the VLAN ID number, from 1 to 4093.
- primary — Enter the bridge as primary or root bridge. The primary bridge value is 24576.
- secondary — Enter the bridge as the secondary root bridge. The secondary bridge value is 28672.

### Configure root bridge as primary

```
OS10(config)# spanning-tree vlan 1 root primary
```

### Verify root bridge information

```
OS10# show spanning-tree active
```

```
Spanning tree enabled protocol rapid-pvst with force-version rstp
VLAN 1
Executing IEEE compatible Spanning Tree Protocol
Root ID Priority 24577, Address 90b1.1cf4.a523
Root Bridge hello time 2, max age 20, forward delay 15
Bridge ID Priority 24577, Address 90b1.1cf4.a523
We are the root of VLAN 1
Configured hello time 2, max age 20, forward delay 15
Interface
Name PortID Prio Cost Sts Cost Bridge ID Designated PortID

ethernet1/1/5 128.276 128 500 FWD 0 24577 90b1.1cf4.a523 128.276
ethernet1/1/6 128.280 128 500 LRN 0 24577 90b1.1cf4.a523 128.280
Interface
Name Role PortID Prio Cost Sts Cost Link-type Edge

ethernet1/1/5 Desg 128.276 128 500 FWD 0 AUTO No
ethernet1/1/6 Desg 128.280 128 500 LRN 0 AUTO No
```

## Global parameters

All non-root bridges accept the timer values on the root bridge.

- Forward-time** Amount of time required for an interface to transition from the Discarding state to the Learning state or from the Learning state to the Forwarding state.
- Hello-time** Time interval within which the bridge sends BPDUs.
- Max-age** Length of time the bridge maintains configuration information before it refreshes information by recomputing the Rapid-PVST topology.

- Modify the forward-time in seconds in CONFIGURATION mode, from 4 to 30, default 15.

```
spanning-tree vlan vlan-id forward-time seconds
```

- Modify the hello-time in seconds in CONFIGURATION mode, from 1 to 10, default 2. With large configurations involving more numbers of ports, Dell EMC recommends increasing the hello-time.

```
spanning-tree vlan vlan-id hello-time seconds
```

- Modify the max-age (in seconds) in CONFIGURATION mode, from 6 to 40, default 20.

```
spanning-tree vlan vlan-id max-age seconds
```

## View Rapid-PVST global parameters

```
OS10# show spanning-tree active
Spanning tree enabled protocol rapid-pvst with force-version rstp
VLAN 1
Executing IEEE compatible Spanning Tree Protocol
Root ID Priority 32769, Address 90b1.1cf4.a523
Root Bridge hello time 2, max age 20, forward delay 15
Bridge ID Priority 32769, Address 90b1.1cf4.a523
We are the root of VLAN 1
Configured hello time 2, max age 20, forward delay 15
```

## Rapid-PVST commands

### show spanning-tree vlan

Displays Rapid-PVST status and configuration information by VLAN ID.

|                          |                                                                 |
|--------------------------|-----------------------------------------------------------------|
| <b>Syntax</b>            | show spanning-tree vlan <i>vlan-id</i>                          |
| <b>Parameters</b>        | vlan <i>vlan-id</i> — Enter the VLAN ID number, from 1 to 4093. |
| <b>Default</b>           | Not configured                                                  |
| <b>Command Mode</b>      | EXEC                                                            |
| <b>Usage Information</b> | None                                                            |

#### Example

```
OS10# show spanning-tree
Spanning tree enabled protocol rapid-pvst with force-version rstp
VLAN 1
Executing IEEE compatible Spanning Tree Protocol
Root ID Priority 32769, Address 3417.eb3a.c080
Root Bridge hello time 2, max age 20, forward delay 15
Bridge ID Priority 32769, Address 54bf.64be.f640
Configured hello time 2, max age 20, forward delay 15
Flush Interval 200 centi-sec, Flush Invocations 285
Flush Indication threshold 5
```

|                           |                  |
|---------------------------|------------------|
| <b>Supported Releases</b> | 10.2.0E or later |
|---------------------------|------------------|

### spanning-tree vlan cost

Sets the path cost of the interface per VLAN for PVST calculations.

|                     |                                                                                                                                                                                                                                                                                                                                                                                                                                                                                                                                                                                       |
|---------------------|---------------------------------------------------------------------------------------------------------------------------------------------------------------------------------------------------------------------------------------------------------------------------------------------------------------------------------------------------------------------------------------------------------------------------------------------------------------------------------------------------------------------------------------------------------------------------------------|
| <b>Syntax</b>       | spanning-tree vlan <i>vlan-id</i> cost { <i>value</i> }                                                                                                                                                                                                                                                                                                                                                                                                                                                                                                                               |
| <b>Parameters</b>   | <i>value</i> — Enter a port cost value to set the path cost of the interface for PVST calculations, from 1 to 200000000.                                                                                                                                                                                                                                                                                                                                                                                                                                                              |
| <b>Defaults</b>     | <ul style="list-style-type: none"><li>• 100- Mb/s Ethernet interface = 200000</li><li>• 1 Gigabit Ethernet interface = 20000</li><li>• 10-Gigabit Ethernet interface = 2000</li><li>• Port-channel interface with one 100 Mb/s Ethernet = 200000</li><li>• Port-channel interface with one 1 Gigabit Ethernet = 20000</li><li>• Port-channel interface with one 10 Gigabit Ethernet = 2000</li><li>• Port-channel with two 1 Gigabit Ethernet = 10000</li><li>• Port-channel with two 10 Gigabit Ethernet = 1000</li><li>• Port-channel with two 100 Mbps Ethernet = 100000</li></ul> |
| <b>Command Mode</b> | INTERFACE                                                                                                                                                                                                                                                                                                                                                                                                                                                                                                                                                                             |

**Usage Information** The media speed of a LAN interface determines the STP port path cost default value.

**Example**

```
OS10(conf-if-eth1/1/4)# spanning-tree vlan 10 cost 1000
```

**Supported Releases** 10.2.0E or later

## spanning-tree vlan disable

Disables spanning tree on a specified VLAN.

**Syntax** `spanning-tree vlan vlan-id disable`

**Parameters** *vlan-id* — Enter the VLAN ID number, from 1 to 4093.

**Default** Enabled

**Command Mode** CONFIGURATION

**Usage Information** The `no` version of this command enables spanning tree on the specified VLAN.

**Example**

```
OS10(config)# spanning-tree vlan 100 disable
```

**Supported Releases** 10.4.0E(R1) or later

## spanning-tree vlan forward-time

Configures a time interval for the interface to wait in the Blocking state or Learning state before moving to the Forwarding state.

**Syntax** `spanning-tree vlan vlan-id forward-time seconds`

**Parameters**

- *vlan-id* — Enter a VLAN ID number, from 1 to 4093.
- *seconds* — Enter the forward-delay time in seconds, from 4 to 30.

**Default** 15 seconds

**Command Mode** CONFIGURATION

**Usage Information** None

**Example**

```
OS10(config)# spanning-tree vlan 10 forward-time 16
```

**Supported Releases** 10.2.0E or later

## spanning-tree vlan force-version

Configures a forced version of spanning-tree to transmit BPDUs.

**Syntax** `spanning-tree vlan vlan-id force-version stp`

**Parameters**

- `stp` — Forces the version for the BPDUs transmitted by MST to STP

**Default** Not configured

**Command Mode** CONFIGURATION

**Usage Information** Forces a bridge that supports Rapid-PVST to operate in an STP-compatible mode.

**Example**

```
OS10(config)# spanning-tree rpvst force-version stp
```

**Supported Releases** 10.2.0E or later

## spanning-tree vlan hello-time

Sets the time interval between generation and transmission of Rapid-PVST BPDUs.

**Syntax** `spanning-tree vlan vlan-id hello-time seconds`

**Parameters**

- *vlan-id* — Enter the VLAN ID number, from 1 to 4093.
- *seconds* — Enter a hello-time interval value in seconds, from 1 to 10.

**Default** 2 seconds

**Command Mode** CONFIGURATION

**Usage Information** Dell EMC recommends increasing the hello-time for large configurations, especially configurations with multiple ports.

**Example**

```
OS10(config)# spanning-tree vlan 10 hello-time 5
```

**Supported Releases** 10.2.0E or later

## spanning-tree vlan mac-flush-threshold

Configures the MAC-flush threshold value for the specified VLAN.

**Syntax** `spanning-tree vlan vlan-id mac-flush-threshold threshold-value`

**Parameters**

- *vlan-id* — Enter the spanning-tree VLAN ID number, from 1 to 4093.
- *threshold-value*—Enter the threshold value for the number of flushes, from 0 to 65535. The default value is 5.

**Default** 5

**Command Mode** CONFIGURATION

**Usage Information** The threshold value indicates the number of port-based flush requests allowed to be invoked before starting the flush optimization. When the flush interval value is non-zero, port-and-instance-based flushing is triggered until the threshold is reached. Once the threshold is reached, MAC-flush timer starts. On timer expiry, the system triggers VLAN-based flushing. When the timer is running, any port-and-vlan-based flushing is suppressed. The `no` form of the command resets the flush indication threshold of the specific instance to its default value.

**Example**

```
OS10(config)# spanning-tree vlan 100 mac-flush-threshold 255
```

**Supported Releases** 10.4.0E(R1) or later

## spanning-tree vlan max-age

Configures the time period the bridge maintains configuration information before refreshing the information by recomputing Rapid-PVST.

**Syntax** `spanning-tree vlan vlan-id max-age seconds`

|                           |                                                                                    |
|---------------------------|------------------------------------------------------------------------------------|
| <b>Parameters</b>         | <code>max-age seconds</code> — Enter a maximum age value in seconds, from 6 to 40. |
| <b>Default</b>            | 20 seconds                                                                         |
| <b>Command Mode</b>       | CONFIGURATION                                                                      |
| <b>Usage Information</b>  | None                                                                               |
| <b>Example</b>            | <pre>OS10(config)# spanning-tree vlan 10 max-age 10</pre>                          |
| <b>Supported Releases</b> | 10.2.0E or later                                                                   |

## spanning-tree vlan priority

Sets the priority value for Rapid-PVST.

|                           |                                                                                                                                                                                                                                                                                      |
|---------------------------|--------------------------------------------------------------------------------------------------------------------------------------------------------------------------------------------------------------------------------------------------------------------------------------|
| <b>Syntax</b>             | <code>spanning-tree vlan vlan-id priority priority value</code>                                                                                                                                                                                                                      |
| <b>Parameters</b>         | <code>priority priority value</code> — Enter a bridge-priority value in increments of 4096, from 0 to 61440. Valid priority values are: 0, 4096, 8192, 12288, 16384, 20480, 24576, 28672, 32768, 36864, 40960, 45056, 49152, 53248, 57344, and 61440. All other values are rejected. |
| <b>Default</b>            | 32768                                                                                                                                                                                                                                                                                |
| <b>Command Mode</b>       | CONFIGURATION                                                                                                                                                                                                                                                                        |
| <b>Usage Information</b>  | The Rapid-PVST protocol determines the root bridge. Assign one bridge a lower priority to increase the probability of it being the root bridge. A lower <code>priority value</code> increases the probability of the bridge becoming a root bridge.                                  |
| <b>Example</b>            | <pre>OS10(config)# spanning-tree vlan 10 priority 0</pre>                                                                                                                                                                                                                            |
| <b>Supported Releases</b> | 10.2.0E or later                                                                                                                                                                                                                                                                     |

## spanning-tree vlan priority (Interface)

Sets an interface priority when two bridges compete for position as the root bridge.

|                           |                                                                                                                                                          |
|---------------------------|----------------------------------------------------------------------------------------------------------------------------------------------------------|
| <b>Syntax</b>             | <code>spanning-tree vlan vlan-id priority value</code>                                                                                                   |
| <b>Parameters</b>         | <code>value</code> — Enter a priority value in the increments of 16, from 0 to 240.                                                                      |
| <b>Default</b>            | 128                                                                                                                                                      |
| <b>Command Mode</b>       | INTERFACE                                                                                                                                                |
| <b>Usage Information</b>  | Identifies the interface to be placed into the forwarding mode when resolving a loop. Ports with lower numerical priority values have higher precedence. |
| <b>Example</b>            | <pre>OS10(conf-if-eth1/1/4)# spanning-tree vlan 10 priority 16</pre>                                                                                     |
| <b>Supported Releases</b> | 10.2.0E or later                                                                                                                                         |

## spanning-tree vlan root

Designates a device as the primary or secondary root bridge.

|                   |                                                                                                                  |
|-------------------|------------------------------------------------------------------------------------------------------------------|
| <b>Syntax</b>     | <code>spanning-tree vlan vlan-id root {primary   secondary}</code>                                               |
| <b>Parameters</b> | <ul style="list-style-type: none"> <li><code>vlan-id</code> — Enter a VLAN ID number, from 1 to 4093.</li> </ul> |

- `root` — Designate the bridge as the primary or secondary root.
- `primary` — Designate the bridge as the primary or root bridge.
- `secondary` — Designate the bridge as the secondary or secondary root bridge.

**Default** Not configured

**Command Mode** CONFIGURATION

**Usage Information** None

**Example**

```
OS10(config)# spanning-tree vlan 1 root primary
```

**Supported Releases** 10.2.0E or later

## spanning-tree rapid-pvst force-version

Configures a forced version of spanning-tree to transmit BPDUs.

**Syntax** `spanning-tree rapid-pvst force-version stp`

**Parameters**

- `stp` — Forces the version for the BPDUs transmitted by Rapid-PVST to STP

**Default** Not configured

**Command Mode** CONFIGURATION

**Usage Information** Forces a bridge that supports Rapid-PVST to operate in an STP-compatible mode.

**Example**

```
OS10(config)# spanning-tree rapid-pvst force-version stp
```

**Supported Releases** 10.2.0E or later

## Rapid Spanning-Tree Protocol

Rapid Spanning-Tree Protocol (RSTP) is similar to STP, but provides faster convergence and interoperability with devices configured with STP and MSTP. RSTP is disabled by default. All enabled interfaces in L2 mode automatically add to the RSTP topology.

Configuring RSTP is a two-step process:

1. Ensure that the interfaces are in L2 mode.
2. Globally enable RSTP.

### Enable STP globally and at interface

RSTP enables STP on all physical and port-channel interfaces which are in L2 mode to automatically include the interfaces as part of the RSTP topology. Only one path from a bridge to any other bridge is enabled. Bridges block a redundant path by disabling one of the link ports.

**Enable globally**

- Configure Spanning-Tree mode to RSTP in CONFIGURATION mode.

```
spanning-tree mode rstp
```

- Disable RSTP globally for all L2 interfaces in CONFIGURATION mode.

```
spanning-tree disable
```

- Re-enable RSTP globally for all L2 interfaces in CONFIGURATION mode.

```
no spanning-tree disable
```

**Enable at interface**

- Remove an interface from the RSTP topology in INTERFACE mode.

```
spanning-tree disable
```

- Re-enable an interface in INTERFACE mode.

```
no spanning-tree disable
```

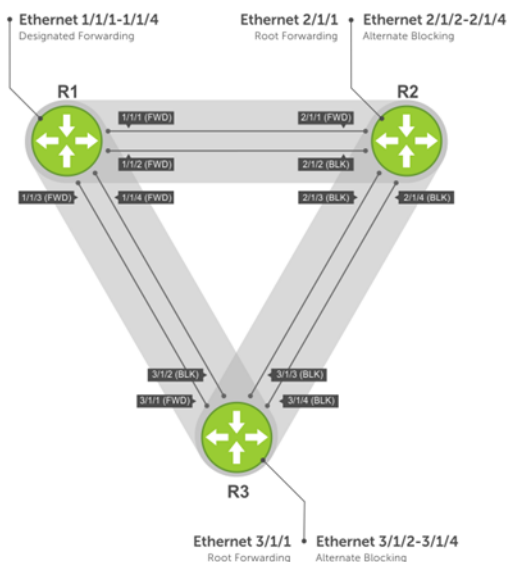

**View all port participating in RSTP**

```
OS10# show spanning-tree
Spanning tree enabled protocol rstp with force-version rstp
Executing IEEE compatible Spanning Tree Protocol
Root ID Priority 32768, Address 3417.4455.667f
Root Bridge hello time 2, max age 20, forward delay 15
Bridge ID Priority 32768, Address 90b1.1cf4.a523
Configured hello time 2, max age 20, forward delay 15
Interface
Name PortID Prio Cost Sts Cost Bridge ID Designated PortID

ethernet1/1/1 128.260 128 2000000000 BLK 0 0 0000.0000.0000 0.0
ethernet1/1/2 128.264 128 2000000000 BLK 0 0 0000.0000.0000 0.0
ethernet1/1/3 128.268 128 2000000000 BLK 0 0 0000.0000.0000 0.0
ethernet1/1/4 128.272 128 2000000000 BLK 0 0 0000.0000.0000 0.0
ethernet1/1/5:1 128.276 128 2000000000 BLK 0 0 0000.0000.0000 0.0
ethernet1/1/5:2 128.277 128 2000000000 BLK 0 0 0000.0000.0000 0.0
ethernet1/1/5:3 128.278 128 2000000000 BLK 0 0 0000.0000.0000 0.0
ethernet1/1/5:4 128.279 128 2000000000 BLK 0 0 0000.0000.0000 0.0
ethernet1/1/6:1 128.280 128 2000 FWD 0 32768 3417.4455.667f 128.150
ethernet1/1/6:2 128.281 128 2000 FWD 0 32768 3417.4455.667f 128.151
ethernet1/1/6:3 128.282 128 2000 FWD 0 32768 3417.4455.667f 128.152
ethernet1/1/6:4 128.283 128 2000 BLK 0 32768 3417.4455.667f 128.153
ethernet1/1/7 128.284 128 2000000000 BLK 0 0 0000.0000.0000 0.0
ethernet1/1/8 128.288 128 2000000000 BLK 0 0 0000.0000.0000 0.0
ethernet1/1/9 128.292 128 2000000000 BLK 0 0 0000.0000.0000 0.0
ethernet1/1/10 128.296 128 2000000000 BLK 0 0 0000.0000.0000 0.0
ethernet1/1/11 128.300 128 2000000000 BLK 0 0 0000.0000.0000 0.0
ethernet1/1/12 128.304 128 2000000000 BLK 0 0 0000.0000.0000 0.0
ethernet1/1/13 128.308 128 2000000000 BLK 0 0 0000.0000.0000 0.0
ethernet1/1/14 128.312 128 2000000000 BLK 0 0 0000.0000.0000 0.0
ethernet1/1/15 128.316 128 2000000000 BLK 0 0 0000.0000.0000 0.0
ethernet1/1/16 128.320 128 2000000000 BLK 0 0 0000.0000.0000 0.0
ethernet1/1/17 128.324 128 2000000000 BLK 0 0 0000.0000.0000 0.0
```

|                 |         |         |           |           |       |       |                |       |
|-----------------|---------|---------|-----------|-----------|-------|-------|----------------|-------|
| ethernet1/1/18  | 128.328 | 128     | 200000000 | BLK       | 0     | 0     | 0000.0000.0000 | 0.0   |
| ethernet1/1/19  | 128.332 | 128     | 200000000 | BLK       | 0     | 0     | 0000.0000.0000 | 0.0   |
| ethernet1/1/20  | 128.336 | 128     | 200000000 | BLK       | 0     | 0     | 0000.0000.0000 | 0.0   |
| ethernet1/1/21  | 128.340 | 128     | 200000000 | BLK       | 0     | 0     | 0000.0000.0000 | 0.0   |
| ethernet1/1/22  | 128.344 | 128     | 200000000 | BLK       | 0     | 0     | 0000.0000.0000 | 0.0   |
| ethernet1/1/23  | 128.348 | 128     | 200000000 | BLK       | 0     | 0     | 0000.0000.0000 | 0.0   |
| ethernet1/1/24  | 128.352 | 128     | 200000000 | BLK       | 0     | 0     | 0000.0000.0000 | 0.0   |
| ethernet1/1/25  | 128.356 | 128     | 200000000 | BLK       | 0     | 0     | 0000.0000.0000 | 0.0   |
| ethernet1/1/26  | 128.360 | 128     | 200000000 | BLK       | 0     | 0     | 0000.0000.0000 | 0.0   |
| ethernet1/1/27  | 128.364 | 128     | 200000000 | BLK       | 0     | 0     | 0000.0000.0000 | 0.0   |
| ethernet1/1/28  | 128.368 | 128     | 200000000 | BLK       | 0     | 0     | 0000.0000.0000 | 0.0   |
| ethernet1/1/29  | 128.372 | 128     | 200000000 | BLK       | 0     | 0     | 0000.0000.0000 | 0.0   |
| ethernet1/1/30  | 128.376 | 128     | 200000000 | BLK       | 0     | 0     | 0000.0000.0000 | 0.0   |
| ethernet1/1/31  | 128.380 | 128     | 200000000 | BLK       | 0     | 0     | 0000.0000.0000 | 0.0   |
| ethernet1/1/32  | 128.384 | 128     | 200000000 | BLK       | 0     | 0     | 0000.0000.0000 | 0.0   |
| Interface       |         |         |           |           |       |       |                |       |
| Name            | Role    | PortID  | Prio      | Cost      | Sts   | Cost  | Link-type      | Edge  |
| -----           | -----   | -----   | -----     | -----     | ----- | ----- | -----          | ----- |
| ethernet1/1/1   | Disb    | 128.260 | 128       | 200000000 | BLK   | 0     | AUTO           | No    |
| ethernet1/1/2   | Disb    | 128.264 | 128       | 200000000 | BLK   | 0     | AUTO           | No    |
| ethernet1/1/3   | Disb    | 128.268 | 128       | 200000000 | BLK   | 0     | AUTO           | No    |
| ethernet1/1/4   | Disb    | 128.272 | 128       | 200000000 | BLK   | 0     | AUTO           | No    |
| ethernet1/1/5:1 | Disb    | 128.276 | 128       | 200000000 | BLK   | 0     | AUTO           | No    |

**NOTE:** In a VLAN setup that contains IOM fabrics running more than 100 VLANs, enable RSTP before deploying the template from MSM.

## Global parameters

The root bridge sets the values for forward-time, hello-time, and max-age, and overwrites the values set on other bridges participating in the RSTP group.

**NOTE:** Dell EMC recommends that only experienced network administrators change the RSTP group parameters. Poorly planned modification of the RSTP parameters can negatively affect network performance.

- Forward-time** 15 seconds — Amount of time an interface waits in the Learning state before it transitions to the Forwarding state.
- Hello-time** 2 seconds — Time interval in which the bridge sends RSTP BPDUs.
- Max-age** 20 seconds — Length of time the bridge maintains configuration information before it refreshes that information by recomputing the RSTP topology.
- Port cost** Port cost values to set the path cost of the interface:
  - 100-Mb/s Ethernet interfaces — 200000
  - 1-Gigabit Ethernet interfaces — 20000
  - 10-Gigabit Ethernet interfaces — 2000
  - 40-Gigabit Ethernet interfaces — 500
  - Port-channel with 100 Mb/s Ethernet interfaces — 200000
  - Port-channel with 1-Gigabit Ethernet interfaces — 20000
  - Port-channel with 10-Gigabit Ethernet interfaces — 2000
  - Port-channel with 1x40Gigabit Ethernet interface — 500
  - Port-channel with 2x40Gigabit Ethernet interfaces — 250

- Change the forward-time in CONFIGURATION mode, from 4 to 30, default 15.

```
spanning-tree rstp forward-time seconds
```

- Change the hello-time in CONFIGURATION mode, from 1 to 10, default 2. With large configurations, especially those configurations with more ports, Dell EMC recommends increasing the hello-time.

```
spanning-tree rstp hello-time seconds
```

- Change the max-age in CONFIGURATION mode, from 6 to 40, default 20.

```
spanning-tree rstp max-age seconds
```



## View current global parameter values

```
OS10# show spanning-tree active

Spanning tree enabled protocol rstp with force-version rstp
Executing IEEE compatible Spanning Tree Protocol
Root ID Priority 32768, Address 90b1.1cf4.9b8a
Root Bridge hello time 2, max age 20, forward delay 15
Bridge ID Priority 32768, Address 90b1.1cf4.9b8a
We are the root
Configured hello time 2, max age 20, forward delay 15
Interface Designated
Name PortID Prio Cost Sts Cost Bridge ID PortID

ethernet1/1/1 244.128 128 500 BLK 0 32768 90b1.1cf4.9b8a 128.244
ethernet1/1/2 248.128 128 500 BLK 0 32768 90b1.1cf4.9b8a 128.248
ethernet1/1/3 252.128 128 500 FWD 0 32768 90b1.1cf4.9b8a 128.252
ethernet1/1/4 256.128 128 500 BLK 0 32768 90b1.1cf4.9b8a 128.256
Interface
Name Role PortID Prio Cost Sts Cost Link-type Edge

ethernet1/1/1 Altr 128.244 128 500 BLK 0 AUTO No
ethernet1/1/2 Altr 128.248 128 500 BLK 0 AUTO No
ethernet1/1/3 Root 128.252 128 500 FWD 0 AUTO No
ethernet1/1/4 Altr 128.256 128 500 BLK 0 AUTO No
```

## Interface parameters

Set the port cost and port priority values on interfaces in L2 mode.

**Port cost** Value based on the interface type. The previous table lists the default values. The greater the port cost, the less likely the port is selected as a forwarding port.

**Port priority** Influences the likelihood a port is selected to be a forwarding port in case several ports have the same port cost.

- Change the port cost of an interface in INTERFACE mode, from 1 to 20000000.

```
spanning-tree rstp cost cost
```

- Change the port priority of an interface in INTERFACE mode, from 0 to 240, default 128.

```
spanning-tree rstp priority priority-value
```

## View current interface parameters

```
OS10# show spanning-tree active

Spanning tree enabled protocol rstp with force-version rstp
Executing IEEE compatible Spanning Tree Protocol
Root ID Priority 32768, Address 90b1.1cf4.9b8a
Root Bridge hello time 2, max age 20, forward delay 15
Bridge ID Priority 32768, Address 90b1.1cf4.9b8a
We are the root
Configured hello time 2, max age 20, forward delay 15
Interface Designated
Name PortID Prio Cost Sts Cost Bridge ID PortID

ethernet1/1/1 244.128 128 500 BLK 0 32768 90b1.1cf4.9b8a 128.244
ethernet1/1/2 248.128 128 500 BLK 0 32768 90b1.1cf4.9b8a 128.248
ethernet1/1/3 252.128 128 500 FWD 0 32768 90b1.1cf4.9b8a 128.252
ethernet1/1/4 256.128 128 500 BLK 0 32768 90b1.1cf4.9b8a 128.256
Interface
Name Role PortID Prio Cost Sts Cost Link-type Edge

ethernet1/1/1 Altr 128.244 128 500 BLK 0 AUTO No
ethernet1/1/2 Altr 128.248 128 500 BLK 0 AUTO No
ethernet1/1/3 Root 128.252 128 500 FWD 0 AUTO No
ethernet1/1/4 Altr 128.256 128 500 BLK 0 AUTO No
```

## Root bridge selection

RSTP determines the root bridge. Assign one bridge a lower priority to increase the likelihood that it is selected as the root bridge.

- Assign a number as the bridge priority or designate it as the primary or secondary root bridge in CONFIGURATION mode. Configure the priority value range, from 0 to 65535 in multiples of 4096, default 32768. The lower the number assigned, the more likely the bridge becomes the root bridge.

```
spanning-tree rstp priority priority-value
```

### View bridge priority and root bridge assignment

```
OS10# show spanning-tree active
Spanning tree enabled protocol rstp with force-version rstp
Executing IEEE compatible Spanning Tree Protocol
Root ID Priority 32768, Address 3417.4455.667f
Root Bridge hello time 2, max age 20, forward delay 15
Bridge ID Priority 36864, Address 90b1.1cf4.a523
Configured hello time 2, max age 20, forward delay 15
Interface

Interface Name PortID Prio Cost Sts Cost Bridge ID Designated PortID

ethernet1/1/6:3 128.282 128 2000 FWD 0 32768 3417.4455.667f 128.152
ethernet1/1/6:4 128.283 128 2000 BLK 0 32768 3417.4455.667f 128.153
Interface

Interface Name Role PortID Prio Cost Sts Cost Link-type Edge

ethernet1/1/6:3 Root 128.282 128 2000 FWD 0 AUTO No
ethernet1/1/6:4 Altr 128.283 128 2000 BLK 0 AUTO No
```

## Spanning-tree link type for rapid state transitions

As specified in IEEE 802.1w, OS10 assumes a port that runs in full-duplex mode is a point-to-point link. A point-to-point link transitions to forwarding state faster. By default, OS10 derives the link type of a port from the duplex mode. You can override the duplex mode using the `spanning-tree link-type` command.

OS10 assumes a port that runs in half-duplex mode is a shared link, to which the fast transition feature is not applicable. Also, if you explicitly designate a port as a shared link, you cannot use the fast transition feature, regardless of the duplex setting.

To hasten the spanning-tree state transitions, you can set the link type to point-to-point. To set the link type to point-to-point:

- Use the following command in INTERFACE mode.

```
spanning-tree link-type point-to-point
```

## RSTP commands

### show spanning-tree active

Displays the RSTP configuration and information for RSTP-active interfaces.

**Syntax** `show spanning-tree active`

**Parameters** None

**Default** Not configured

**Command Mode** EXEC

**Usage** None

#### Information

#### Example

```
OS10# show spanning-tree active
```

```
Spanning tree enabled protocol rstp with force-version rstp
Executing IEEE compatible Spanning Tree Protocol
Root ID Priority 32768, Address 90b1.1cf4.9b8a
Root Bridge hello time 2, max age 20, forward delay 15
Bridge ID Priority 32768, Address 90b1.1cf4.9b8a
We are the root
Configured hello time 2, max age 20, forward delay 15
Interface Designated
Name PortID Prio Cost Sts Cost Bridge ID PortID

ethernet1/1/1 244.128 128 500 BLK 0 32768 90b1.1cf4.9b8a 128.244
ethernet1/1/2 248.128 128 500 BLK 0 32768 90b1.1cf4.9b8a 128.248
ethernet1/1/3 252.128 128 500 FWD 0 32768 90b1.1cf4.9b8a 128.252
ethernet1/1/4 256.128 128 500 BLK 0 32768 90b1.1cf4.9b8a 128.256
Interface
Name Role PortID Prio Cost Sts Cost Link-type Edge

ethernet1/1/1 Altr 128.244 128 500 BLK 0 AUTO No
ethernet1/1/2 Altr 128.248 128 500 BLK 0 AUTO No
ethernet1/1/3 Root 128.252 128 500 FWD 0 AUTO No
ethernet1/1/4 Altr 128.256 128 500 BLK 0 AUTO No
```

**Supported Releases** 10.2.0E or later

## spanning-tree mode rstp

Enables an STP type: RSTP.

**Syntax** `spanning-tree mode rstp`

**Parameters** • `rstp` — Sets STP mode to RSTP.

**Default** Rapid-PVST

**Command Mode** CONFIGURATION

**Usage Information** All STP instances stop in the previous STP mode and restart in the new mode. You can also change to RSTP/MST mode.

**Example**

```
OS10(config)# spanning-tree mode rstp
```

**Supported Releases** 10.2.0E or later

## spanning-tree rstp force-version

Configures a forced version of spanning tree to transmit BPDUs.

**Syntax** `spanning-tree rstp force-version stp`

**Parameters** `stp` — Force the version for the BPDUs transmitted by RSTP.

**Default** Not configured

**Command Mode** CONFIGURATION

**Usage Information** Forces a bridge to operate in an STP-compatible manner to avoid frame mis-ordering and duplication in known LAN protocols that are sensitive.

**Example**

```
OS10(config)# spanning-tree rstp force-version stp
```

**Supported Releases** 10.2.0E or later

## spanning-tree rstp forward-time

Configures a time interval for the interface to wait in the Blocking state or Learning state before moving to the Forwarding state.

|                           |                                                                                                                                                         |
|---------------------------|---------------------------------------------------------------------------------------------------------------------------------------------------------|
| <b>Syntax</b>             | <code>spanning-tree rstp forward-time <i>seconds</i></code>                                                                                             |
| <b>Parameters</b>         | <i>seconds</i> — Enter the number of seconds an interface waits in the Blocking or Learning States before moving to the Forwarding state, from 4 to 30. |
| <b>Default</b>            | 15 seconds                                                                                                                                              |
| <b>Command Mode</b>       | CONFIGURATION                                                                                                                                           |
| <b>Usage Information</b>  | None                                                                                                                                                    |
| <b>Example</b>            | <pre>OS10(config)# spanning-tree rstp forward-time 16</pre>                                                                                             |
| <b>Supported Releases</b> | 10.2.0E or later                                                                                                                                        |

## spanning-tree rstp hello-time

Sets the time interval between generation and transmission of RSTP BPDUs.

|                           |                                                                                                                        |
|---------------------------|------------------------------------------------------------------------------------------------------------------------|
| <b>Syntax</b>             | <code>spanning-tree rstp hello-time <i>seconds</i></code>                                                              |
| <b>Parameters</b>         | <i>seconds</i> — Enter a hello-time interval value in seconds, from 1 to 10.                                           |
| <b>Default</b>            | 2 seconds                                                                                                              |
| <b>Command Mode</b>       | CONFIGURATION                                                                                                          |
| <b>Usage Information</b>  | Dell EMC recommends increasing the hello-time for large configurations, especially configurations with multiple ports. |
| <b>Example</b>            | <pre>OS10(config)# spanning-tree rstp hello-time 5</pre>                                                               |
| <b>Supported Releases</b> | 10.2.0E or later                                                                                                       |

## spanning-tree rstp mac-flush-threshold

Sets the flush indication threshold value on the RSTP instance.

|                          |                                                                                                                                                                                                                                                                                                                                                                                                                                                                                                                                                                                                                                                                                                                                                                                     |
|--------------------------|-------------------------------------------------------------------------------------------------------------------------------------------------------------------------------------------------------------------------------------------------------------------------------------------------------------------------------------------------------------------------------------------------------------------------------------------------------------------------------------------------------------------------------------------------------------------------------------------------------------------------------------------------------------------------------------------------------------------------------------------------------------------------------------|
| <b>Syntax</b>            | <code>spanning-tree rstp mac-flush-threshold <i>threshold-value</i></code>                                                                                                                                                                                                                                                                                                                                                                                                                                                                                                                                                                                                                                                                                                          |
| <b>Parameters</b>        | <i>threshold-value</i> —Enter the threshold value for the number of flushes, from 0 to 65535. The default value is 65535.                                                                                                                                                                                                                                                                                                                                                                                                                                                                                                                                                                                                                                                           |
| <b>Default</b>           | 65535                                                                                                                                                                                                                                                                                                                                                                                                                                                                                                                                                                                                                                                                                                                                                                               |
| <b>Command Mode</b>      | CONFIGURATION                                                                                                                                                                                                                                                                                                                                                                                                                                                                                                                                                                                                                                                                                                                                                                       |
| <b>Usage Information</b> | The threshold value indicates the number of flush indications to go before the flush interval timer is triggered. When flush indication threshold is set to the default value and the flush interval is set to a non-default value, flushing occurs during the first flush indication trigger. When the flush indication threshold value is non-default (n) and flush interval value is non-default, port-based flushing is triggered until the threshold (n) is reached. Once the threshold is reached, the MAC flush timer starts. On timer expiry, the system triggers instance-based flushing. When the timer is running, all port-and-instance-based flushing is suppressed. The <code>no</code> form of the command sets the flush indication threshold to its default value. |
| <b>Example</b>           | <pre>OS10(config)# spanning-tree rstp mac-flush-threshold 255</pre>                                                                                                                                                                                                                                                                                                                                                                                                                                                                                                                                                                                                                                                                                                                 |

**Supported Releases** 10.4.0E(R1) or later

## spanning-tree rstp max-age

Configures the time period the bridge maintains configuration information before refreshing the information by recomputing the RSTP topology.

**Syntax** `max-age seconds`

**Parameters** `seconds` — Enter a maximum age value in seconds, from 6 to 40.

**Default** 20 seconds

**Command Mode** CONFIGURATION

**Usage Information** None

**Example**

```
OS10(config)# spanning-tree rstp max-age 10
```

**Supported Releases** 10.2.0E or later

## spanning-tree rstp priority

Sets the priority value for RSTP.

**Syntax** `spanning-tree rstp priority priority value`

**Parameters** `priority value` — Enter a bridge-priority value in increments of 4096, from 0 to 61440. Valid priority values are: 0, 4096, 8192, 12288, 16384, 20480, 24576, 28672, 32768, 36864, 40960, 45056, 49152, 53248, 57344, and 61440. All other values are rejected.

**Default** Not configured

**Command Mode** CONFIGURATION

**Usage Information** RSTP determines the root bridge but you can assign one bridge a lower priority to increase the probability of it being the root bridge. A lower *priority value* increases the probability of the bridge becoming a root bridge.

**Example**

```
OS10(config)# spanning-tree rstp priority 5002
```

**Supported Releases** 10.2.0E or later

## Multiple Spanning-Tree

MSTP is one of the variations of the rapid spanning-tree protocol that mitigates some of the challenges of Rapid-PVST. Rapid-PVST allows a spanning-tree instance for each VLAN. This 1:1 approach is not suitable if you have multiple VLANs — each spanning-tree instance costs bandwidth and processing resources. You can configure Multiple Spanning-Tree Instances (MSTIs) and map multiple VLANs to one spanning-tree instance to reduce the total number of instances..

When you enable MST, all ports in Layer 2 (L2) mode participate in all instances of MST. OS10 only supports one MST region.

You can achieve load balancing using the MST protocol (MSTP). For example, as shown in the following figure, when you map three VLANs to two multiple spanning-tree instances (MSTIs), VLAN 100 traffic takes a different path than VLAN 200 and 300 traffic.

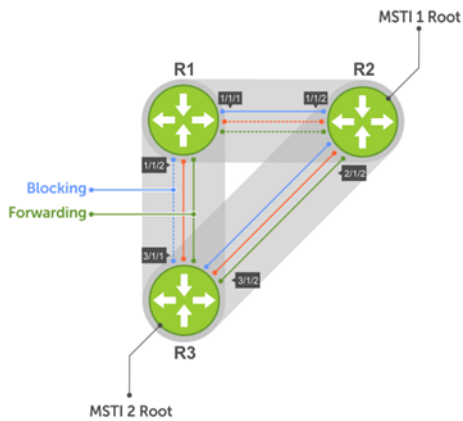

Configuring MST is a four-step process:

1. Enable MST, if the current running spanning-tree protocol (STP) version is not MST.
2. (Optional) Map the VLAN to different instances in such a way that the traffic is load balanced well and the link utilization is efficient.
3. Ensure the same region name is configured in all the bridges running MST.
4. (Optional) Configure the revision number. The revision number is the same on all the bridges.

## Configure MSTP

When you enable MST globally, all switch ports, port-channels, and VLAN interfaces get automatically assigned to MSTI zero (0). In a MSTI, only one path is enabled for forwarding.

- Enable MST in CONFIGURATION mode.

```
spanning-tree mode mst
```

### Configure and verify MSTP

```
OS10(config)# spanning-tree mode mst
OS10(config)# do show spanning-tree
show spanning-tree mst configuration
Region Name: abc
Revision: 0
MSTI VID
0 1,7-4093
1 2
2 3
3 4
4 5
5 6
```

### Add or remove interfaces

By default, all interfaces are enabled in L2 switchport mode, and all L2 interfaces are part of spanning-tree.

- Disable spanning-tree on an interface in INTERFACE mode.

```
spanning-tree disable
```

- Enable MST on an interface in INTERFACE mode.

```
no spanning-tree disable
```

## Create instances

You can create multiple MSTP instances and map VLANs. To take full advantage of the MSTP, create multiple MSTIs and map VLANs to them.

1. Enter an instance number in CONFIGURATION mode.

```
spanning tree mst configuration
```

2. Enter the MST instance number in MULTIPLE-SPANNING-TREE mode, from 0 to 63. For Z9332F-ON platform, the MULTIPLE-SPANNING-TREE mode is from 0 to 61.

```
instance instance-number
```

3. Enter the VLAN and IDs to participate in the MST instance in MULTIPLE-SPANNING-TREE mode, from 1 to 4096.

```
instance vlan-id
```

### Create MST instances

```
OS10(config)# spanning-tree mst configuration
OS10(conf-mst)# name Dell
OS10(conf-mst)# revision 100
OS10(conf-mst)# instance 1 vlan 2-10
OS10(conf-mst)# instance 2 vlan 11-20
OS10(conf-mst)# instance 3 vlan 21-30
```

### View VLAN instance mapping

```
OS10# show spanning-tree mst configuration
Region Name: Dell
Revision: 100
MSTI VID
0 1,31-4093
1 2-10
2 11-20
3 21-30
```

### View port forwarding/discarding state

```
os10# show spanning-tree msti 0 brief
Spanning tree enabled protocol msti with force-version mst
MSTI 0 VLANs mapped 1-3999,4091-4093
Executing IEEE compatible Spanning Tree Protocol
Root ID Priority 32768, Address 90b1.1cf4.a625
Root Bridge hello time 1, max age 20, forward delay 4, max hops 20
Bridge ID Priority 32768, Address 90b1.1cf4.a625
We are the root of MSTI 0
Configured hello time 1, max age 20, forward delay 4, max hops 20
CIST regional root ID Priority 32768, Address 90b1.1cf4.a625
CIST external path cost 0
Flush Interval 200 centi-sec, Flush Invocations 12
Flush Indication threshold 5
Interface
Name PortID Prio Cost Sts Cost Designated
PortID

ethernet1/1/1 128.8 128 200000000 BLK 0 32768 90b1.1cf4.a625
128.8
ethernet1/1/2:1 128.16 128 2000 BLK 0 32768 90b1.1cf4.a625
128.16
ethernet1/1/2:2 128.17 128 2000 BLK 0 32768 90b1.1cf4.a625
128.17
ethernet1/1/2:3 128.18 128 2000 BLK 0 32768 90b1.1cf4.a625
128.18
ethernet1/1/2:4 128.19 128 2000 BLK 0 32768 90b1.1cf4.a625
128.19
ethernet1/1/3 128.24 128 200000000 BLK 0 32768 90b1.1cf4.a625
128.24
ethernet1/1/4:1 128.32 128 2000 FWD 0 32768 90b1.1cf4.a625
128.32
ethernet1/1/4:2 128.33 128 2000 FWD 0 32768 90b1.1cf4.a625
128.33
ethernet1/1/4:3 128.34 128 200000000 BLK 0 32768 90b1.1cf4.a625
128.34
```

|                 |         |        |           |           |     |       |                |
|-----------------|---------|--------|-----------|-----------|-----|-------|----------------|
| ethernet1/1/4:4 | 128.35  | 128    | 200000000 | BLK       | 0   | 32768 | 90b1.1cf4.a625 |
| 128.35          |         |        |           |           |     |       |                |
| ethernet1/1/5   | 128.40  | 128    | 200000000 | BLK       | 0   | 32768 | 90b1.1cf4.a625 |
| 128.40          |         |        |           |           |     |       |                |
| ethernet1/1/6   | 128.48  | 128    | 200000000 | BLK       | 0   | 32768 | 90b1.1cf4.a625 |
| 128.48          |         |        |           |           |     |       |                |
| ethernet1/1/7   | 128.56  | 128    | 200000000 | BLK       | 0   | 32768 | 90b1.1cf4.a625 |
| 128.56          |         |        |           |           |     |       |                |
| ethernet1/1/8   | 128.64  | 128    | 200000000 | BLK       | 0   | 32768 | 90b1.1cf4.a625 |
| 128.64          |         |        |           |           |     |       |                |
| ethernet1/1/9   | 128.72  | 128    | 200000000 | BLK       | 0   | 32768 | 90b1.1cf4.a625 |
| 128.72          |         |        |           |           |     |       |                |
| ethernet1/1/10  | 128.80  | 128    | 200000000 | BLK       | 0   | 32768 | 90b1.1cf4.a625 |
| 128.80          |         |        |           |           |     |       |                |
| ethernet1/1/11  | 128.88  | 128    | 200000000 | BLK       | 0   | 32768 | 90b1.1cf4.a625 |
| 128.88          |         |        |           |           |     |       |                |
| ethernet1/1/12  | 128.96  | 128    | 200000000 | BLK       | 0   | 32768 | 90b1.1cf4.a625 |
| 128.96          |         |        |           |           |     |       |                |
| ethernet1/1/13  | 128.104 | 128    | 200000000 | BLK       | 0   | 32768 | 90b1.1cf4.a625 |
| 128.104         |         |        |           |           |     |       |                |
| ethernet1/1/14  | 128.112 | 128    | 200000000 | BLK       | 0   | 32768 | 90b1.1cf4.a625 |
| 128.112         |         |        |           |           |     |       |                |
| ethernet1/1/15  | 128.120 | 128    | 200000000 | BLK       | 0   | 32768 | 90b1.1cf4.a625 |
| 128.120         |         |        |           |           |     |       |                |
| ethernet1/1/16  | 128.128 | 128    | 200000000 | BLK       | 0   | 32768 | 90b1.1cf4.a625 |
| 128.128         |         |        |           |           |     |       |                |
| ethernet1/1/17  | 128.136 | 128    | 200000000 | BLK       | 0   | 32768 | 90b1.1cf4.a625 |
| 128.136         |         |        |           |           |     |       |                |
| ethernet1/1/18  | 128.144 | 128    | 200000000 | BLK       | 0   | 32768 | 90b1.1cf4.a625 |
| 128.144         |         |        |           |           |     |       |                |
| ethernet1/1/19  | 128.152 | 128    | 200000000 | BLK       | 0   | 32768 | 90b1.1cf4.a625 |
| 128.152         |         |        |           |           |     |       |                |
| ethernet1/1/20  | 128.160 | 128    | 200000000 | BLK       | 0   | 32768 | 90b1.1cf4.a625 |
| 128.160         |         |        |           |           |     |       |                |
| ethernet1/1/21  | 128.168 | 128    | 200000000 | BLK       | 0   | 32768 | 90b1.1cf4.a625 |
| 128.168         |         |        |           |           |     |       |                |
| ethernet1/1/22  | 128.176 | 128    | 200000000 | BLK       | 0   | 32768 | 90b1.1cf4.a625 |
| 128.176         |         |        |           |           |     |       |                |
| ethernet1/1/23  | 128.184 | 128    | 200000000 | BLK       | 0   | 32768 | 90b1.1cf4.a625 |
| 128.184         |         |        |           |           |     |       |                |
| ethernet1/1/24  | 128.192 | 128    | 200000000 | BLK       | 0   | 32768 | 90b1.1cf4.a625 |
| 128.192         |         |        |           |           |     |       |                |
| ethernet1/1/25  | 128.200 | 128    | 200000000 | BLK       | 0   | 32768 | 90b1.1cf4.a625 |
| 128.200         |         |        |           |           |     |       |                |
| ethernet1/1/26  | 128.208 | 128    | 200000000 | BLK       | 0   | 32768 | 90b1.1cf4.a625 |
| 128.208         |         |        |           |           |     |       |                |
| ethernet1/1/27  | 128.216 | 128    | 200000000 | BLK       | 0   | 32768 | 90b1.1cf4.a625 |
| 128.216         |         |        |           |           |     |       |                |
| ethernet1/1/28  | 128.224 | 128    | 200000000 | BLK       | 0   | 32768 | 90b1.1cf4.a625 |
| 128.224         |         |        |           |           |     |       |                |
| ethernet1/1/29  | 128.232 | 128    | 200000000 | BLK       | 0   | 32768 | 90b1.1cf4.a625 |
| 128.232         |         |        |           |           |     |       |                |
| ethernet1/1/30  | 128.240 | 128    | 200000000 | BLK       | 0   | 32768 | 90b1.1cf4.a625 |
| 128.240         |         |        |           |           |     |       |                |
| ethernet1/1/31  | 128.248 | 128    | 200000000 | BLK       | 0   | 32768 | 90b1.1cf4.a625 |
| 128.248         |         |        |           |           |     |       |                |
| ethernet1/1/32  | 128.256 | 128    | 200000000 | BLK       | 0   | 32768 | 90b1.1cf4.a625 |
| 128.256         |         |        |           |           |     |       |                |
| Interface       |         |        |           |           |     |       |                |
| Name            | Role    | PortID | Prio      | Cost      | Sts | Cost  | Link-          |
| type            | Edge    |        |           |           |     |       |                |
| -----           |         |        |           |           |     |       |                |
| ethernet1/1/1   | Disb    | 128.8  | 128       | 200000000 | BLK | 0     |                |
| AUTO            | No      |        |           |           |     |       |                |
| ethernet1/1/2:1 | Disb    | 128.16 | 128       | 2000      | BLK | 0     |                |
| AUTO            | No      |        |           |           |     |       |                |
| ethernet1/1/2:2 | Disb    | 128.17 | 128       | 2000      | BLK | 0     |                |
| AUTO            | No      |        |           |           |     |       |                |
| ethernet1/1/2:3 | Disb    | 128.18 | 128       | 2000      | BLK | 0     |                |
| AUTO            | No      |        |           |           |     |       |                |
| ethernet1/1/2:4 | Disb    | 128.19 | 128       | 2000      | BLK | 0     |                |
| AUTO            | No      |        |           |           |     |       |                |



|                 |      |         |     |           |     |   |
|-----------------|------|---------|-----|-----------|-----|---|
| ethernet1/1/3   | Disb | 128.24  | 128 | 200000000 | BLK | 0 |
| AUTO            | No   |         |     |           |     |   |
| ethernet1/1/4:1 | Desg | 128.32  | 128 | 2000      | FWD | 0 |
| AUTO            | No   |         |     |           |     |   |
| ethernet1/1/4:2 | Desg | 128.33  | 128 | 2000      | FWD | 0 |
| AUTO            | No   |         |     |           |     |   |
| ethernet1/1/4:3 | Disb | 128.34  | 128 | 200000000 | BLK | 0 |
| AUTO            | No   |         |     |           |     |   |
| ethernet1/1/4:4 | Disb | 128.35  | 128 | 200000000 | BLK | 0 |
| AUTO            | No   |         |     |           |     |   |
| ethernet1/1/5   | Disb | 128.40  | 128 | 200000000 | BLK | 0 |
| AUTO            | No   |         |     |           |     |   |
| ethernet1/1/6   | Disb | 128.48  | 128 | 200000000 | BLK | 0 |
| AUTO            | No   |         |     |           |     |   |
| ethernet1/1/7   | Disb | 128.56  | 128 | 200000000 | BLK | 0 |
| AUTO            | No   |         |     |           |     |   |
| ethernet1/1/8   | Disb | 128.64  | 128 | 200000000 | BLK | 0 |
| AUTO            | No   |         |     |           |     |   |
| ethernet1/1/9   | Disb | 128.72  | 128 | 200000000 | BLK | 0 |
| AUTO            | No   |         |     |           |     |   |
| ethernet1/1/10  | Disb | 128.80  | 128 | 200000000 | BLK | 0 |
| AUTO            | No   |         |     |           |     |   |
| ethernet1/1/11  | Disb | 128.88  | 128 | 200000000 | BLK | 0 |
| AUTO            | No   |         |     |           |     |   |
| ethernet1/1/12  | Disb | 128.96  | 128 | 200000000 | BLK | 0 |
| AUTO            | No   |         |     |           |     |   |
| ethernet1/1/13  | Disb | 128.104 | 128 | 200000000 | BLK | 0 |
| AUTO            | No   |         |     |           |     |   |
| ethernet1/1/14  | Disb | 128.112 | 128 | 200000000 | BLK | 0 |
| AUTO            | No   |         |     |           |     |   |
| ethernet1/1/15  | Disb | 128.120 | 128 | 200000000 | BLK | 0 |
| AUTO            | No   |         |     |           |     |   |
| ethernet1/1/16  | Disb | 128.128 | 128 | 200000000 | BLK | 0 |
| AUTO            | No   |         |     |           |     |   |
| ethernet1/1/17  | Disb | 128.136 | 128 | 200000000 | BLK | 0 |
| AUTO            | No   |         |     |           |     |   |
| ethernet1/1/18  | Disb | 128.144 | 128 | 200000000 | BLK | 0 |
| AUTO            | No   |         |     |           |     |   |
| ethernet1/1/19  | Disb | 128.152 | 128 | 200000000 | BLK | 0 |
| AUTO            | No   |         |     |           |     |   |
| ethernet1/1/20  | Disb | 128.160 | 128 | 200000000 | BLK | 0 |
| AUTO            | No   |         |     |           |     |   |
| ethernet1/1/21  | Disb | 128.168 | 128 | 200000000 | BLK | 0 |
| AUTO            | No   |         |     |           |     |   |
| ethernet1/1/22  | Disb | 128.176 | 128 | 200000000 | BLK | 0 |
| AUTO            | No   |         |     |           |     |   |
| ethernet1/1/23  | Disb | 128.184 | 128 | 200000000 | BLK | 0 |
| AUTO            | No   |         |     |           |     |   |
| ethernet1/1/24  | Disb | 128.192 | 128 | 200000000 | BLK | 0 |
| AUTO            | No   |         |     |           |     |   |
| ethernet1/1/25  | Disb | 128.200 | 128 | 200000000 | BLK | 0 |
| AUTO            | No   |         |     |           |     |   |
| ethernet1/1/26  | Disb | 128.208 | 128 | 200000000 | BLK | 0 |
| AUTO            | No   |         |     |           |     |   |
| ethernet1/1/27  | Disb | 128.216 | 128 | 200000000 | BLK | 0 |
| AUTO            | No   |         |     |           |     |   |
| ethernet1/1/28  | Disb | 128.224 | 128 | 200000000 | BLK | 0 |
| AUTO            | No   |         |     |           |     |   |
| ethernet1/1/29  | Disb | 128.232 | 128 | 200000000 | BLK | 0 |
| AUTO            | No   |         |     |           |     |   |
| ethernet1/1/30  | Disb | 128.240 | 128 | 200000000 | BLK | 0 |
| AUTO            | No   |         |     |           |     |   |
| ethernet1/1/31  | Disb | 128.248 | 128 | 200000000 | BLK | 0 |
| AUTO            | No   |         |     |           |     |   |
| ethernet1/1/32  | Disb | 128.256 | 128 | 200000000 | BLK | 0 |
| AUTO            | No   |         |     |           |     |   |

## Root selection

MSTP determines the root bridge according to the lowest bridge ID. To increase the likelihood of a bridge to be selected as a root bridge, assign a lower bridge priority numerical value to that bridge.

You can set the priority value to 0 to force a switch to become the root switch. Value 0 is the highest priority.

- Assign a bridge priority number to a specific instance in CONFIGURATION mode, from 0 to 61440 in increments of 4096, default 32768.

```
spanning-tree mst instance-number priority priority
```

### Assign root bridge priority

```
OS10(config)# spanning-tree mst 0 priority 32768
```

### Verify root bridge priority

```
OS10# show spanning-tree active
Spanning tree enabled protocol msti with force-version mst
MSTI 0 VLANs mapped 1,31-4093
Executing IEEE compatible Spanning Tree Protocol
Root ID Priority 32768, Address 3417.4455.667f
Root Bridge hello time 2, max age 20, forward delay 15, max hops 20
Bridge ID Priority 32768, Address 90b1.1cf4.a523
Configured hello time 2, max age 20, forward delay 15, max hops 20
CIST regional root ID Priority 32768, Address 90b1.1cf4.a523
CIST external path cost 500
Interface Designated
Name PortID Prio Cost Sts Cost Bridge ID PortID

ethernet1/1/5 128.276 128 500 FWD 0 32768 3417.4455.667f 128.146
ethernet1/1/6 128.280 128 500 BLK 0 32768 3417.4455.667f 128.150
Interface
Name Role PortID Prio Cost Sts Cost Link-type Edge

ethernet1/1/5 Root 128.276 128 500 FWD 0 AUTO No
ethernet1/1/6 Altr 128.280 128 500 BLK 0 AUTO No
```

## Non-Dell EMC hardware

OS10 supports only one MST region. For a bridge to be in the same MST region as another, the following attributes must match the unique name, revision, and VLAN mapping. The default value for name is system mac. In case of Dell EMC, the user has to manually configure an unique name in all the nodes to be in a single region. If you have non-Dell EMC hardware that participates in MST, ensure these values match on all devices.

A region is a combination of three unique attributes:

- Name — A mnemonic string you assign to the region. The default is the system MAC address.
- Revision — A 2-byte number. The default is 0.
- VLAN-to-instance mapping — Placement of a VLAN in an MSTI.

## Region name or revision

You can change the MSTP region name or revision.

- Change the region name in MULTIPLE-SPANNING-TREE mode. A maximum of 32 characters.

```
name name
```

- Change the region revision number in MULTIPLE-SPANNING-TREE mode, from 0 to 65535, default 0.

```
revision number
```

### Configure and verify region name

```
OS10(conf-mstp)# name my-mstp-region
OS10(conf-mstp)# do show spanning-tree mst config
MST region name: my-mstp-region
Revision: 0
MSTI VID
```

```
1 100
2 200-300
```

## Modify parameters

The root bridge sets the values for forward-delay, hello-time, max-age, and max-hops and overwrites the values set on other MST bridges.

- Forward-time** Time an interface waits in the Discarding state and Learning state before it transitions to the Forwarding state.
- Hello-time** Interval in which the bridge sends MST BPDUs.
- Max-age** Length of time the bridge maintains configuration information before it refreshes that information by recomputing the MST topology.
- Max-hops** A maximum number of hops a BPDU travels before a receiving device discards it.

**NOTE:** Dell EMC recommends that only experienced network administrators change MST parameters. Poorly planned modification of MST parameters can negatively affect network performance.

1. Change the forward-time parameter in CONFIGURATION mode, from 4 to 30, default 15.

```
spanning-tree mst forward-time seconds
```

2. Change the hello-time parameter in CONFIGURATION mode, from 1 to 10, default 2. Dell EMC recommends increasing the hello-time for large configurations, especially configurations with more ports.

```
spanning-tree mst hello-time seconds
```

3. Change the max-age parameter in CONFIGURATION mode, from 6 to 40, default 20.

```
spanning-tree mst max-age seconds
```

4. Change the max-hops parameter in CONFIGURATION mode, from 1 to 40, default 20.

```
spanning-tree mst max-hops number
```

## MST configuration

```
OS10(config)# spanning-tree mst
OS10(config)# spanning-tree mst forward-time 16
OS10(config)# spanning-tree mst hello-time 5
OS10(config)# spanning-tree mst max-age 10
OS10(config)# spanning-tree mst max-hops 30
```

## View MSTP parameter values

```
OS10# show spanning-tree active
Spanning tree enabled protocol msti with force-version mst
MSTI 0 VLANs mapped 1,31-4093
Executing IEEE compatible Spanning Tree Protocol
Root ID Priority 32768, Address 3417.4455.667f
Root Bridge hello time 2, max age 20, forward delay 15, max hops 20
Bridge ID Priority 32768, Address 90b1.1cf4.a523
Configured hello time 10, max age 40, forward delay 30, max hops 40
CIST regional root ID Priority 32768, Address 90b1.1cf4.a523
CIST external path cost 500
```

| Interface Name | PortID  | Prio | Cost | Sts | Cost | Bridge ID | Designated PortID      |
|----------------|---------|------|------|-----|------|-----------|------------------------|
| ethernet1/1/5  | 128.276 | 128  | 500  | FWD | 0    | 32768     | 3417.4455.667f 128.146 |
| ethernet1/1/6  | 128.280 | 128  | 500  | BLK | 0    | 32768     | 3417.4455.667f 128.150 |

```
Interface Name
```

| Interface Name | Role | PortID  | Prio | Cost | Sts | Cost | Link-type | Edge |
|----------------|------|---------|------|------|-----|------|-----------|------|
| ethernet1/1/5  | Root | 128.276 | 128  | 500  | FWD | 0    | AUTO      | No   |
| ethernet1/1/6  | Altr | 128.280 | 128  | 500  | BLK | 0    | AUTO      | No   |

## Interface parameters

Adjust two interface parameters to increase or decrease the likelihood that a port becomes a forwarding port.

- Port cost** Interface type value. The greater the port cost, the less likely the port is a forwarding port.
- Port priority** Influences the likelihood that a port is selected as a forwarding port if several ports have the same port cost.

Default values for the port cost by interface:

- 100-Mb/s Ethernet interfaces — 200000
  - 1-Gigabit Ethernet interfaces — 20000
  - 10-Gigabit Ethernet interfaces — 2000
  - Port-channel with 100 Mb/s Ethernet interfaces — 180000
  - Port-channel with 1-Gigabit Ethernet interfaces — 18000
  - Port-channel with 10-Gigabit Ethernet interfaces — 1800
1. Change the port cost of an interface in INTERFACE mode, from 1 to 200000000.

```
spanning-tree msti number cost 1
```

2. Change the port priority of an interface in INTERFACE mode, from 0 to 240 in increments of 16, default 128.

```
spanning-tree msti number priority 32
```

### View MSTi interface configuration

```
OS10(conf-if-eth1/1/7)# do show spanning-tree msti 0 interface ethernet 1/1/7
ethernet1/1/7 of MSTI 0 is Designated Forwarding
Edge port: No (default)
Link type: point-to-point (auto)
Boundary: Yes, Bpdu-filter: Disable, Bpdu-Guard: Disable, Shutdown-on-Bpdu-Guard-
violation: No
Root-Guard: Disable, Loop-Guard: Disable
Bpdus (MRecords) Sent: 69, Received: 0
Interface
Name PortID Prio Cost Sts Cost Designated Bridge ID PortID

ethernet1/1/7 0.284 0 1 FWD 0 32768 90b1.1cf4.9b8a 0.284
```

## MST commands

### instance

Configures MST instances and one or multiple VLANs mapped to the MST instance.

- Syntax** `instance instance-number {vlan vlan-range}`
- Parameters**
- *instance* — Enter a MST instance value, from 0 to 63. For Z9332F-ON platform, enter a MST instance value from 0 to 61.
  - *vlan range* — Enter a VLAN range value, from 1 to 4093.
- Default** Not configured
- Command Mode** MULTIPLE-SPANNING-TREE
- Usage Information** By default, all VLANs map to MST instance zero (0) unless you are using the *vlan range* command to map the VLANs to a non-zero instance. The *no* version of this command removes the instance-related configuration.

### Example

```
OS10(conf-mst)# instance 1 vlan 2-10
OS10(conf-mst)# instance 2 vlan 11-20
OS10(conf-mst)# instance 3 vlan 21-30
```

**Supported Releases** 10.2.0E or later

## name

Assigns a name to the MST region.

**Syntax** name **region-name**

**Parameters** **region-name** — Enter a name for an MST region. A maximum of 32 characters.

**Default** System MAC address

**Command Mode** MULTIPLE-SPANNING-TREE

**Usage Information** By default, the MST protocol assigns the system MAC address as the region name. Two MST devices within the same region must share the same region name, including matching case.

### Example

```
OS10(conf-mst)# name my-mst-region
```

**Supported Releases** 10.2.0E or later

## revision

Configures a revision number for the MSTP configuration.

**Syntax** revision *number*

**Parameters** *number* — Enter a revision number for the MSTP configuration, from 0 to 65535.

**Default** 0

**Command Mode** MULTIPLE-SPANNING-TREE

**Usage Information** To have a bridge in the same MST region as another, the default values for the revision number must match on all Dell EMC hardware devices. If there are non-Dell EMC devices, ensure the revision number value matches on all the devices. For more information, see [Non-Dell Hardware](#).

### Example

```
OS10(conf-mst)# revision 10
```

**Supported Releases** 10.2.0E or later

## spanning-tree mst

Configures an MST instance and determines root and bridge priorities.

**Syntax** spanning-tree mst *instance number* priority | root {primary | secondary}

**Parameters**

- *instance number* — Enter an MST instance number, from 0 to 63. For Z9332F-ON platform, enter a MST instance value from 0 to 61.
- *priority priority value* — Set a bridge priority value in increments of 4096, from 0 to 61440. Valid priority values are: 0, 4096, 8192, 12288, 16384, 20480, 24576, 28672, 32768, 36864, 40960, 45056, 49152, 53248, 57344, and 61440. All other values are rejected.
- *root* — Enter a primary or secondary root.
- *primary* — Enter a device as a primary root.
- *secondary* — Enter a device as a secondary root.

**Default** Not configured

**Command Mode** CONFIGURATION

**Usage Information** The MSTP determines the root bridge but you can assign one bridge a lower priority to increase the probability it being the root bridge. A lower *priority-value* increases the probability of the bridge becoming a root bridge. The `no` version of this command resets the value to the default.

**Example**

```
OS10(config)# spanning-tree mst 0 priority 0
OS10(config)# spanning-tree mst 2 root primary
```

**Supported Releases** 10.2.0E or later

## spanning-tree msti

Configures the MSTI, cost, and priority values for an interface.

**Syntax** `spanning-tree msti instance {cost cost | priority value}`

**Parameters**

- `msti instance` — Enter the MST instance number, from 0 to 63. For Z9332F-ON platform, enter a MST instance value from 0 to 61.
- `cost cost` — (Optional) Enter a port cost value, from 1 to 200000000. Default values:
  - 100 Mb/s Ethernet interface = 200000
  - 1-Gigabit Ethernet interface = 20000
  - 10-Gigabit Ethernet interface = 2000
  - Port-channel interface with one 100 Mb/s Ethernet = 200000
  - Port-channel interface with one 1 Gigabit Ethernet = 20000
  - Port-channel interface with one 10 Gigabit Ethernet = 2000
  - Port-channel with two 1 Gigabit Ethernet = 18000
  - Port-channel with two 10 Gigabit Ethernet = 1800
  - Port-channel with two 100 Mbps Ethernet = 180000
- `priority value` — Enter a value in increments of 16 as the priority, from 0 to 240, default 128.

**Default** Priority value is 128

**Command Mode** INTERFACE

**Usage Information** The `cost` value is based on the interface type. The greater the `cost` value, the less likely the port is selected to be a forwarding port. The `priority` influences the likelihood that a port is selected to be a forwarding port if several ports have the same cost value.

**Example**

```
OS10(conf-if-eth1/1/1)# spanning-tree msti 1 priority 0
OS10(conf-if-eth1/1/1)# spanning-tree msti 1 cost 3
```

**Supported Releases** 10.2.0E or later

## spanning-tree mst configuration

Enters MST mode to configure MSTP from Configuration mode.

**Syntax** `spanning-tree mst configuration`

**Parameters** None

**Default** Disabled

**Command Mode** CONFIGURATION

**Usage Information** Use this command to enter STP MST configuration mode.

**Example**

```
OS10(config)# spanning-tree mst configuration
OS10(conf-mst)#
```

**Supported Releases** 10.2.0E or later

## spanning-tree mst disable

Disables spanning tree on the specified MST instance.

|                           |                                                                                                                                  |
|---------------------------|----------------------------------------------------------------------------------------------------------------------------------|
| <b>Syntax</b>             | <code>spanning-tree mst <i>instance-number</i> disable</code>                                                                    |
| <b>Parameters</b>         | <i>instance-number</i> —Enter the instance number, from 0 to 63.For Z9332F-ON platform, enter a MST instance value from 0 to 61. |
| <b>Default</b>            | Enabled                                                                                                                          |
| <b>Command Mode</b>       | CONFIGURATION                                                                                                                    |
| <b>Usage Information</b>  | The <code>no</code> version of this command enables spanning tree on the specified MST instance.                                 |
| <b>Example</b>            | <pre>OS10(config)# spanning-tree mst 10 disable</pre>                                                                            |
| <b>Supported Releases</b> | 10.4.0E(R1) or later                                                                                                             |

## spanning-tree mst force-version

Configures a forced version of STP to transmit BPDUs.

|                           |                                                                                                                                                                                                                             |
|---------------------------|-----------------------------------------------------------------------------------------------------------------------------------------------------------------------------------------------------------------------------|
| <b>Syntax</b>             | <code>spanning-tree mst force-version {stp   rstp}</code>                                                                                                                                                                   |
| <b>Parameters</b>         | <ul style="list-style-type: none"><li>• <code>stp</code> — Forces the version for the BPDUs transmitted by MST to STP.</li><li>• <code>rstp</code> — Forces the version for the BPDUs transmitted by MST to RSTP.</li></ul> |
| <b>Default</b>            | Not configured                                                                                                                                                                                                              |
| <b>Command Mode</b>       | CONFIGURATION                                                                                                                                                                                                               |
| <b>Usage Information</b>  | Forces a bridge that supports MST to operate in a STP-compatible mode.                                                                                                                                                      |
| <b>Example</b>            | <pre>OS10(config)# spanning-tree mst force-version stp OS10(config)# spanning-tree mst force-version rstp</pre>                                                                                                             |
| <b>Supported Releases</b> | 10.2.0E or later                                                                                                                                                                                                            |

## spanning-tree mst forward-time

Configures a time interval for the interface to wait in the Blocking state or the Learning state before moving to the Forwarding state.

|                          |                                                                                                                                                         |
|--------------------------|---------------------------------------------------------------------------------------------------------------------------------------------------------|
| <b>Syntax</b>            | <code>spanning-tree mst forward-time <i>seconds</i></code>                                                                                              |
| <b>Parameters</b>        | <i>seconds</i> — Enter the number of seconds an interface waits in the Blocking or Learning States before moving to the Forwarding state, from 4 to 30. |
| <b>Default</b>           | 15 seconds                                                                                                                                              |
| <b>Command Mode</b>      | CONFIGURATION                                                                                                                                           |
| <b>Usage Information</b> | The <code>no</code> version of this command resets the value to the default.                                                                            |
| <b>Example</b>           | <pre>OS10(config)# spanning-tree mst forward-time 16</pre>                                                                                              |

**Supported Releases** 10.2.0E or later

## spanning-tree mst hello-time

Sets the time interval between generation and transmission of MSTP BPDUs.

**Syntax** `spanning-tree mst hello-time seconds`

**Parameters** `seconds` — Enter a hello-time interval value in seconds, from 1 to 10.

**Default** 2 seconds

**Command Mode** CONFIGURATION

**Usage Information** Dell EMC recommends increasing the hello-time for large configurations, especially configurations with multiple ports. The `no` version of this command resets the value to the default.

**Example**

```
OS10(config)# spanning-tree mst hello-time 5
```

**Supported Releases** 10.2.0E or later

## spanning-tree mst mac-flush-threshold

Configures the mac-flush threshold value for a specific instance.

**Syntax** `spanning-tree mst instance-number mac-flush-threshold threshold-value`

**Parameters**

- `instance-number`—Enter the instance number, from 0 to 4094.
- `threshold-value`—Enter the threshold value for the number of flushes, from 0 to 65535. The default value is 5.

**Default** 5

**Command Mode** CONFIGURATION

**Usage Information** This threshold indicates the number of port-based flush requests allowed to be invoked before starting the flush optimization. When the flush interval value is non-zero, port-and-instance-based flushing is triggered until the threshold is reached. Once the threshold is reached the MAC flush timer starts. On timer expiry, the system triggers instance-based flushing. When the timer is running, all port-and-instance-based flushing is suppressed. The `no` form of the command sets the flush indication threshold of the specific instance to its default value.

**Example**

```
OS10(config)# spanning-tree mst 10 mac-flush-threshold 255
```

**Supported Releases** 10.4.0E(R1) or later

## spanning-tree mst max-age

Configures the time period the bridge maintains configuration information before refreshing the information by recomputing the MST topology.

**Syntax** `max-age seconds`

**Parameters** `seconds` — Enter a maximum age value in seconds, from 6 to 40.

**Default** 20 seconds

**Command Mode** CONFIGURATION

**Usage Information** The `no` version of this command resets the value to the default.



**Example**

```
OS10(config)# spanning-tree mst max-age 10
```

**Supported Releases**

10.2.0E or later

## spanning-tree mst max-hops

Configures the maximum hop count for a BPDU to travel before it is discarded.

**Syntax** `spanning-tree mst max-hops number`

**Parameters** *number* — Enter a maximum hop value, from 6 to 40.

**Default** 20

**Command Mode** CONFIGURATION

**Usage Information** A device receiving BPDUs waits until the `max-hops` value expires before discarding it. When a device receives the BPDUs, it decrements the received value of the remaining hops and uses the resulting value as remaining-hops in the BPDUs. If the remaining MSTP 1333 hops reach zero, the device discards the BPDU and ages out any information that it holds for the port. The command configuration applies to all common IST (CIST) in the MST region.

**Example**

```
OS10(config)# spanning-tree mst max-hops 30
```

**Supported Releases**

10.2.0E or later

## show spanning-tree mst

Displays MST configuration information.

**Syntax** `show spanning-tree mst configuration`

**Parameters** None

**Default** Not configured

**Command Mode** EXEC

**Usage Information** Enable MSTI before using this command.

**Example**

```
OS10# show spanning-tree mst configuration
Region Name: asia
Revision: 0
MSTI VID
0 1,7-4093
1 2
2 3
3 4
4 5
5 6
```

**Supported Releases**

10.2.0E or later

## show spanning-tree msti

Displays MST instance information.

**Syntax** `show spanning-tree msti [instance-number [brief | guard | virtual-interface | interface interface]]`

## Parameters

- *instance-number* — (Optional) Displays MST instance information, from 0 to 63. For Z9332F-ON platform, enter a MST instance value from 0 to 61.
- *brief* — (Optional) Displays MST instance summary information.
- *guard* — (Optional) Displays which guard is enabled and the current port state.
- *virtual-interface*—(Optional) Displays MST information specific to VLT.
- *interface interface*—(Optional) Displays interface type information:
  - *ethernet node/slot/port[:subport]* — Enter the Ethernet port information, from 1 to 48.
  - *port-channel* — Enter the port-channel interface information, from 1 to 128.

## Default

Not configured

## Command Mode

EXEC

## Usage

View the MST instance information for a specific MST instance number in detail or brief, or view physical Ethernet ports or port-channel information.

## Example (Brief)

```
OS10# show spanning-tree msti 0 brief
Spanning tree enabled protocol msti with force-version mst
MSTI 0 VLANs mapped 1-99,101-199,301-4093
Executing IEEE compatible Spanning Tree Protocol
Root ID Priority 32768, Address 90b1.1cf4.9b8a
Root Bridge hello time 2, max age 20, forward delay 15, max hops 20
Bridge ID Priority 32768, Address 90b1.1cf4.9b8a
We are the root of MSTI 0
Configured hello time 2, max age 20, forward delay 15, max hops 20
Interface Designated
Name PortID Prio Cost Sts Cost Bridge ID PortID

ethernet1/1/1 132.128 128 200000000 BLK 0 32768 90b1.1cf4.9b8a 128.132
ethernet1/1/2 136.128 128 200000000 BLK 0 32768 90b1.1cf4.9b8a 128.136
ethernet1/1/3 140.128 128 200000000 BLK 0 32768 90b1.1cf4.9b8a 128.140
ethernet1/1/4 144.128 128 200000000 BLK 0 32768 90b1.1cf4.9b8a 128.144
ethernet1/1/5 148.128 128 200000000 BLK 0 32768 90b1.1cf4.9b8a 128.148
ethernet1/1/6 152.128 128 200000000 BLK 0 32768 90b1.1cf4.9b8a 128.152
ethernet1/1/7 156.128 128 200000000 BLK 0 32768 90b1.1cf4.9b8a 128.156
...
Interface
Name Role PortID Prio Cost Sts Cost Link-type Edge

ethernet1/1/1 Disb 128.132 128 200000000 BLK 0 SHARED No
ethernet1/1/2 Disb 128.136 128 200000000 BLK 0 SHARED No
ethernet1/1/3 Disb 128.140 128 200000000 BLK 0 SHARED No
ethernet1/1/4 Disb 128.144 128 200000000 BLK 0 SHARED No
ethernet1/1/5 Disb 128.148 128 200000000 BLK 0 SHARED No
ethernet1/1/6 Disb 128.152 128 200000000 BLK 0 SHARED No
ethernet1/1/7 Disb 128.156 128 200000000 BLK 0 SHARED No
ethernet1/1/8 Disb 128.160 128 200000000 BLK 0 SHARED No
ethernet1/1/9 Disb 128.164 128 200000000 BLK 0 SHARED No
```

## Example (Interface)

```
OS10# show spanning-tree msti 1 interface ethernet 1/1/1
ethernet1/1/1 of vlan1 is root Forwarding
Edge port:no (default) port guard :none (default)
Link type is point-to-point (auto)
Boundary :internal bpdu filter : bpdu guard : bpduguard shutdown-on-
violation :disable RootGuard: disable LoopGuard disable
Bpdus (MRecords) sent 3779, received 7
Interface Designated
Name PortID Prio Cost Sts Cost Bridge ID PortID

ethernet1/1/1 128.132 128 20000 FWD 0 32768 74e6.e2f5.dd80 128.132
```

## Example (Guard)

```
OS10# show spanning-tree msti 1 guard
Interface
Name Instance Sts Guard Type

ethernet1/1/1 MSTI 1 FWD root
```

```

ethernet1/1/2 MSTI 1 FWD loop
ethernet1/1/3 MSTI 1 BLK none
ethernet1/1/4 MSTI 1 FWD none
ethernet1/1/5 MSTI 1 BLK none
ethernet1/1/6 MSTI 1 BLK none
ethernet1/1/7 MSTI 1 BLK none
ethernet1/1/8 MSTI 1 BLK none
...

```

### Example (virtual-interface)

```

agg-6146 # show spanning-tree msti 0 virtual-interface
VFP(VirtualFabricPort) of MSTI 0 is Designated Forwarding
Edge port: No (default)
Link type: point-to-point (auto)
Boundary: No, Bpdu-filter: Disable, Bpdu-Guard: Disable, Shutdown-on-Bpdu-Guard-violation: No
Root-Guard: Disable, Loop-Guard: Disable
Bpdus (MRecords) Sent: 250, Received: 240
Interface

Name PortID Prio Cost Sts Cost Designated

VFP(VirtualFabricPort) 0.1 0 1 FWD 0 32768 3417.ebf2.a8c4 0.1

```

**Command** 10.2.0E or later  
**History**

## Virtual LANs

VLANs segment a single flat L2 broadcast domain into multiple logical L2 networks. Each VLAN is uniquely identified by a VLAN ID or tag consisting of 12 bits in the Ethernet frame. VLAN IDs range from 1 to 4093 and provide a total of 4093 logical networks.

You can assign ports on a single physical device to one or more VLANs creating multiple logical instances on a single physical device. The virtual logical switches spanning across different physical devices emulate multiple logically segmented L2 networks on a single physical network.

Each VLAN has its own broadcast domain. The unicast, multicast, and broadcast network traffic from ports that belong to a VLAN forwards or floods to ports in the same VLAN only. Traffic between VLANs routes from one VLAN to another. You can also assign each VLAN an IP address to group all the ports within a single IP subnet.

In SmartFabric Services mode, you can configure up to a maximum of 256 uplink VLANs including the default VLAN given the limited hardware capability. For each of the uplink VLAN interface, the system creates an ACL entry to classify the traffic. This ACL entry maps the traffic from the VLAN to the corresponding traffic-class (TC) queue. If you create more than 256 VLANs, ACL table creation fails when the uplinks are created in the Fiber Channel Gateway or the Fiber Channel Direct Attach mode.

In SmartFabric mode, although you can use the CLI to create VLANs 1 to 4000 and 4021 to 4094, you cannot assign interfaces to them. For this reason, do not use the CLI to create VLANs in SmartFabric mode.

Segment a L2 network using VLANs to:

- Minimize broadcast and multicast traffic in the L2 network
- Increase security by isolating ports into different VLANs
- Ease network management

### Configuration notes

All Dell EMC PowerSwitches except MX-Series, S4200-Series, S5200 Series, and Z9332F-ON:

The valid VLAN ID range displays as 1-4093. VLAN IDs 4094 and 4095 are reserved for internal use.

## Default VLAN

All interface ports are administratively up in L2 mode and are automatically placed in the default VLAN as untagged interfaces.

When you assign a port to a non-default VLAN in Trunk mode, the interface remains an untagged member of the default VLAN and a tagged member of the new VLAN. When you assign a port to a non-default VLAN in Access mode, it removes from the default VLAN and is assigned to the new VLAN as an untagged member of the new VLAN.

- VLAN 1 is the default VLAN.
- You cannot delete the default VLAN. However, you can change the default VLAN ID number using the `default vlan-id` command.

**NOTE:** The IOM cluster running 10.5.x and 10.4.x does not work as expected when the untagged VLAN is not VLAN1 on the server ports.

Use the `show vlan` command to verify that the interface is part of the default VLAN (VLAN 1).

### Default VLAN configuration

```
OS10# show vlan

Codes: * - Default VLAN, G-GVRP VLANs, R-Remote Port Mirroring VLANs, P-Primary, C-
Community, I-Isolated
Q: A-Access (Untagged), T-Tagged
 x-Dot1x untagged, X-Dot1x tagged
 G-GVRP tagged, M-Vlan-stack, H-VSN tagged
 i-Internal untagged, I-Internal tagged, v-VLT untagged, V-VLT tagged
 NUM Status Description Q Ports
* 1 up A Eth1/1/1-1/1/54
```

## Create or remove VLANs

You can create VLANs and add physical interfaces or port-channel LAG interfaces to the VLAN as tagged or untagged members. You can add an Ethernet interface as a trunk port or as an access port, but it cannot be added as both simultaneously.

### Multiple non-default vlans with physical and port channel ports in Access and Trunk modes

```
OS10# show vlan

Codes: * - Default VLAN, G-GVRP VLANs, R-Remote Port Mirroring VLANs, P-Primary, C-
Community, I-Isolated
Q: A-Access (Untagged), T-Tagged
 x-Dot1x untagged, X-Dot1x tagged
 G-GVRP tagged, M-Vlan-stack, H-VSN tagged
 i-Internal untagged, I-Internal tagged, v-VLT untagged, V-VLT tagged
 NUM Status Description Q Ports
* 1 up A Eth1/1/2 1/1/3:2 1/1/3:3 1/1/3:4
1/1/4
1/1/5 1/1/6 1/1/7 1/1/8 1/1/9 1/1/10 1/1/11 1/1/12 1/1/13 1/1/14 1/1/15 1/1/16 1/1/17
1/1/18
1/1/19 1/1/20 1/1/21 1/1/22 1/1/23 1/1/24 1/1/25:1 1/1/25:2 1/1/25:3 1/1/25:4 1/1/26
1/1/27
1/1/28 1/1/30 1/1/32
 A Po40
 T Eth1/1/3:2
 T Po40
 A Eth1/1/31
 T Eth1/1/25:4 1/1/32
 T Po40
 A Eth1/1/3:1
49 1/1/50 1/1/51 1/1/52 1/1/53 1/1/54
```

The `shutdown` command stops L3-routed traffic only. L2 traffic continues to pass through the VLAN. If the VLAN is not a routed VLAN configured with an IP address, the `shutdown` command has no effect on VLAN traffic.

When you delete a VLAN using the `no interface vlan vlan-id` command, any interfaces that are assigned to that VLAN are assigned to the default VLAN as untagged interfaces.

To configure a port-based VLAN, enter INTERFACE-VLAN mode for VLAN-related configuration tasks and create a VLAN. To enable the VLAN, assign member interfaces in L2 mode.

1. Create a VLAN and enter the VLAN number in INTERFACE mode, from 1 to 4093.

```
interface vlan vlan-id
```

2. Delete a VLAN in CONFIGURATION mode.

```
no interface vlan vlan-id
```

## Create VLAN

```
OS10(config)# interface vlan 108
```

## Delete VLAN

```
OS10(config)# no interface vlan 108
```

## View configured VLANs

```
OS10# show interface vlan

Vlan 1 is up, line protocol is up
Address is , Current address is
Interface index is 69208865
Internet address is not set
MTU 1532 bytes
LineSpeed auto
Flowcontrol rx off tx off
ARP type: ARPA, ARP Timeout: 240
Last clearing of "show interface" counters Queueing strategy: fifo Time since last
interface status change:

Vlan 200 is up, line protocol is up
Address is , Current address is
Interface index is 69209064
Internet address is not set
MTU 1532 bytes
LineSpeed auto
Flowcontrol rx off tx off
ARP type: ARPA, ARP Timeout: 240
Last clearing of "show interface" counters Queueing strategy: fifo Time since last
interface status change:

Vlan 320 is up, line protocol is up
Address is , Current address is
Interface index is 69209184
Internet address is not set
MTU 1532 bytes
LineSpeed auto
Flowcontrol rx off tx off
ARP type: ARPA, ARP Timeout: 240
Last clearing of "show interface" counters Queueing strategy: fifo Time since last
interface status change:
```

## Access mode

An access port is an untagged member of only one VLAN. Configure a port in Access mode and configure which VLAN carries the traffic for that interface. If you do not configure the VLAN for a port in Access mode, or an access port, the interface carries traffic for VLAN 1, the default VLAN.

Change the access port membership in a VLAN by specifying the new VLAN. You must create the VLAN before you can assign the port in Access mode to that VLAN. Use the `no switchport access vlan` command to reset to default VLAN.

1. Configure a port in CONFIGURATION mode.

```
interface ethernet node/slot/port[:subport]
```

2. Set the interface to Switchport mode as access in INTERFACE mode.

```
switchport mode access
```

3. Enter the VLAN number for the untagged port in INTERFACE mode.

```
switchport access vlan vlan-id
```

## Configure port in Access mode

```
OS10(config)# interface ethernet 1/1/9
OS10(config-if-eth1/1/9)# switchport mode access
OS10(config-if-eth1/1/9)# switchport access vlan 604
```

## Show running configuration

```
OS10# show running-configuration
...
!
interface ethernet1/1/5
...
switchport access vlan 604
no shutdown
!
interface vlan1
no shutdown
...
```

## Trunk mode

A trunk port can be a member of multiple VLANs set up on an interface. A trunk port transmits traffic for all VLANs. To transmit traffic on a trunk port with multiple VLANs, OS10 uses tagging or the 802.1q encapsulation method.

1. Configure a port in CONFIGURATION mode.

```
interface ethernet node/slot/port[:subport]
```

2. Change Switchport mode to Trunk mode in INTERFACE mode.

```
switchport mode trunk
```

3. Enter the allowed VLANs on the trunk port in INTERFACE mode.

```
switchport trunk allowed vlan vlan-id
```

## Configure port in Trunk mode

```
OS10(config)# interface ethernet 1/1/6
OS10(conf-if-eth1/1/6)# switchport mode trunk
OS10(conf-if-eth1/1/6)# switchport trunk allowed vlan 108
```

## View running configuration

```
OS10# show running-configuration
...
!
interface ethernet1/1/8
switchport mode trunk
switchport trunk allowed vlan 108
no shutdown
!
interface vlan1
no shutdown
!
...
```

## Assign IP address

You can assign an IP address to each VLAN to make it a L3 VLAN. All the ports in that VLAN belong to that particular IP subnet.

The traffic between the ports in different VLANs route using the IP address. Configure the L3 VLAN interface to remain administratively UP or DOWN using the `shutdown` and `no shutdown` commands. This provisioning only affects the L3 traffic across the members of a VLAN and does not affect the L2 traffic.

Do not assign an IP address to the default VLAN (VLAN 1).

**i** **NOTE:** However, the zero-touch deployment (ZTD) application requires this functionality. While ZTD is in progress, the system assigns an IP address to the default VLAN to establish connectivity. After ZTD is complete, the system removes the IP address that is assigned to the default VLAN.

You can place VLANs and other logical interfaces in L3 mode to receive and send routed traffic.

1. Create a VLAN in CONFIGURATION mode, from 1 to 4093.

```
interface vlan vlan-id
```

2. Assign an IP address and mask to the VLAN in INTERFACE-VLAN mode.

```
ip address ip-address/prefix-length [secondary]
```

- *ip-address/prefix-length*—Enter the IP address in dotted-decimal A.B.C.D/x format.
- *secondary*—Enter the interface backup IP address.

### Assign IP address to VLAN

```
OS10(config)# interface vlan 200
OS10(conf-if-vl-200)# ip address 10.1.15.1/8
```

### View VLAN configuration

```
OS10# show interface vlan

Vlan 1 is up, line protocol is up
Address is , Current address is
Interface index is 69208865
Internet address is not set
MTU 1532 bytes
LineSpeed auto
Flowcontrol rx off tx off
ARP type: ARPA, ARP Timeout: 240
Last clearing of "show interface" counters Queueing strategy: fifo Time since last
interface status change:

Vlan 200 is up, line protocol is up
Address is , Current address is
Interface index is 69209064
Internet address is not set
MTU 1532 bytes
LineSpeed auto
Flowcontrol rx off tx off
ARP type: ARPA, ARP Timeout: 240
Last clearing of "show interface" counters Queueing strategy: fifo Time since last
interface status change:

Vlan 320 is up, line protocol is up
Address is , Current address is
Interface index is 69209184
Internet address is 20.2.11.1/24
MTU 1532 bytes
LineSpeed auto
Flowcontrol rx off tx off
ARP type: ARPA, ARP Timeout: 240
Last clearing of "show interface" counters Queueing strategy: fifo Time since last
interface status change:
```

## View VLAN configuration

You can view configuration information related to VLANs using `show` commands.

- View the VLAN status and configuration information in EXEC mode.

```
show vlan
```

- View the VLAN interface configuration in EXEC mode.

```
show interface vlan
```

- View the VLAN interface configuration for a specific VLAN ID in EXEC mode.

```
show interface vlan vlan-id
```

### View VLAN configuration

```
OS10# show vlan

Codes: * - Default VLAN, G-GVRP VLANs, R-Remote Port Mirroring VLANs, P-Primary, C-
Community, I-Isolated
Q: A-Access (Untagged), T-Tagged
 x-Dot1x untagged, X-Dot1x tagged
 G-GVRP tagged, M-Vlan-stack, H-VSN tagged
 i-Internal untagged, I-Internal tagged, v-VLT untagged, V-VLT tagged
NUM Status Description Q Ports
* 1 up A Eth1/1/1-1/1/32
 A Po40
 200 up T Eth1/1/3:2
 T Po40
 A Eth1/1/31
 320 up T Eth1/1/25:4 1/1/32
 T Po40
 A Eth1/1/3:1
```

### View interface VLAN configuration

```
OS10# show interface vlan
Vlan 1 is up, line protocol is up
Address is , Current address is
Interface index is 69208865
Internet address is not set
MTU 1532 bytes
LineSpeed auto
Flowcontrol rx off tx off
ARP type: ARPA, ARP Timeout: 240
Last clearing of "show interface" counters Queueing strategy: fifo Time since last
interface status change:

Vlan 200 is up, line protocol is up
Address is , Current address is
Interface index is 69209064
Internet address is not set
MTU 1532 bytes
LineSpeed auto
Flowcontrol rx off tx off
ARP type: ARPA, ARP Timeout: 240
Last clearing of "show interface" counters Queueing strategy: fifo Time since last
interface status change:

Vlan 320 is up, line protocol is up
Address is , Current address is
Interface index is 69209184
Internet address is not set
MTU 1532 bytes
LineSpeed auto
Flowcontrol rx off tx off
ARP type: ARPA, ARP Timeout: 240
Last clearing of "show interface" counters Queueing strategy: fifo Time since last
interface status change:
```



## View interface configuration for specific VLAN

```
OS10# show interface vlan 320
Vlan 320 is up, line protocol is up
Address is , Current address is
Interface index is 69209184
Internet address is not set
MTU 1532 bytes
LineSpeed auto
Flowcontrol rx off tx off
ARP type: ARPA, ARP Timeout: 240
Last clearing of "show interface" counters Queueing strategy: fifo Time since last
interface status change:
```

## VLAN Scaling

When VLANs are created, traffic class is specified for each VLAN that maps the VLAN traffic to a specific queue on the egress port. Class-maps are created for each VLAN matching and the action is specified in the policymap that maps it to a specific traffic class. Using traffic class-to-queue mapping, the traffic gets mapped to the corresponding queue.

Since ACL rules are created on a per VLAN basis, the scale of VLANs is dependent on the number of ACL rules available. The ACL space is also shared by other applications such as FCoE. When more VLANs are created, the L2 QoS ACL space for the VLAN ACLs get exhausted. If the VLAN ACL creation fails, it results in VLAN creation failure. As a result, there cannot be more than 256 VLANs in Fabric mode.

When a VLAN is created with the uplink ports, a traffic class such as gold, silver, or platinum is assigned to the traffic on the VLAN. On receiving the configuration from GUI through DNV, the Fabric agent creates a classmap of type qos with the name CM<vlanid> which matches the same <vlanid>. For example when vlanid 100 with a traffic class of type 4 the classmap created will be:

```
classmap type qos CM100
match vlan 100
```

A single policymap is created to hold all the VLAN classmaps and its applied at the system qos level which gets applied to all the interfaces.

```
policymap type qos PM_VLAN
class CM100
set qos-group 4
```

Any addition, deletion, or modification to the VLAN or the traffic class happens within the same policymap.

In the NPU, each classmap maps to an ACL entry in the L2QOS region matching the vlanid in the classmap.

### Constraints

VLAN scaling is limited to the Fabric mode.

Currently Dynamic ARP Inspection (DAI) uses the vlan-group id. NAS implicitly programs the VLAN-group id in the Vlan table. But DAI feature is not enabled in Fabric mode.

Use of vlan-group id is limited only to applications which require grouping for the purpose of using ACLs.

## VLAN commands

### description (VLAN)

Adds a description to the selected VLAN.

|                     |                                                                                                          |
|---------------------|----------------------------------------------------------------------------------------------------------|
| <b>Syntax</b>       | <code>description <i>description</i></code>                                                              |
| <b>Parameters</b>   | <code><i>description</i></code> — Enter a text string to identify the VLAN. A maximum of 240 characters. |
| <b>Default</b>      | Not configured                                                                                           |
| <b>Command Mode</b> | INTERFACE-VLAN                                                                                           |

**Usage Information**

- To use special characters as a part of the description string, enclose the string in double quotes.
- To use comma as a part of the description string add double back slash before the comma.

**Example**

```
OS10(config)# interface vlan 3
OS10(conf-if-vl-3)# description vlan3
```

**Supported Releases**

10.2.0E or later

## interface vlan

Creates a VLAN interface.

**Syntax**

`interface vlan vlan-id`

**Parameters**

*vlan-id* — Enter the VLAN ID number, from 1 to 4093.

**Default**

VLAN 1

**Command Mode**

CONFIGURATION

**Usage Information**

FTP, TFTP, MAC ACLs, and SNMP operations are not supported. IP ACLs are supported on VLANs only. The `no` version of this command deletes the interface.

**Example**

```
OS10(config)# interface vlan 10
OS10(conf-if-vl-10)#
```

**Supported Releases**

10.2.0E or later

## show vlan

Displays VLAN configurations.

**Syntax**

`show vlan [vlan-id | private-vlan]`

**Parameters**

- *vlan-id*—(Optional) Enter a VLAN ID number, from 1 to 4093.
- *private-vlan*—(Optional) Displays configuration details of private VLAN.

**Default**

Not configured

**Command Mode**

EXEC

**Usage Information**

Use this command to view VLAN configuration information for a specific VLAN ID.

**Example**

```
OS10# show vlan
Codes: * - Default VLAN, M - Management VLAN, R - Remote Port Mirroring
VLANs
Q: A - Access (Untagged), T - Tagged
 NUM Status Description Q Ports
* 1 Active
 A Eth1/1/15
 A Po100
 2101 Active
 T Eth1/1/1,1/1/3
 T Po100
 2102 Active
 T Eth1/1/1,1/1/3
```

**Supported Releases**

10.2.0E or later

# Port monitoring

Port monitoring monitors ingress or egress traffic of one port to another for analysis. A monitoring port (MG) or destination port is the port where the monitored traffic is sent for analysis. A monitored port (MD) or source port is the source interface that is monitored for traffic analysis.

 **NOTE:** This feature is not supported on the Z9332F-ON platform.

The different types of port monitoring are:

- **Local port monitoring**—Port monitoring is done in the same switch. The switch forwards a copy of incoming and outgoing traffic from one port to another port for further analysis.
- **Remote port monitoring (RPM)**—Port monitoring is done on traffic running across a remote device in the same network. The L2 network carries the monitored traffic.
- **Encapsulated remote port monitoring (ERPM)**—Port monitoring is done on the L3 network. The traffic from the source port is encapsulated and forwards to the destination port in another switch.

## Configuration notes

All Dell EMC PowerSwitches except MX-Series, S4200-Series, S5200 Series, and Z9332F-ON:

- When you configure a port as a source interface, and add the same port to the remote VLAN used for monitoring traffic, the configuration fails and the system does not display an error message. Dell EMC recommends adding the ports to the destination remote VLAN first and then configuring the source interface. In this case, when you configure the destination port as source, the system displays an error message.
- When you configure remote port mirroring and overwrite the transport VLAN by re-entering the destination `remotevlan vlan-id` command with a different VLAN ID, an error message displays. The new remote VLAN configuration is not accepted. You must first remove the configured remote VLAN using the `no` version of the command, and then re-enter the command with the new remote VLAN ID.
- VLAN statistics on the remote port mirroring (RPM) VLAN interface are not incremented on the following switches: S4048-ON, S4048T-ON, S4100-ON, S6010-ON, and Z9264F-ON. For these switches, the `show interface vlan rpm_vlanid` command does not display statistics for the mirrored traffic.

## Local port monitoring

For local port monitoring, the monitored source ports and monitoring destination ports are on the same device.

## Configure local monitoring session

1. Verify that the intended monitoring port has no configuration other than `no shutdown` and `no switchport`.

```
show running-configuration
```

2. Create a monitoring session in CONFIGURATION mode.

```
monitor session session-id [local]
```

3. Enter the source and direction of the monitored traffic in MONITOR-SESSION mode.

```
source interface interface-type {both | rx | tx}
```

4. Enter the destination of traffic in MONITOR-SESSION mode.

```
destination interface interface-type
```

## Create monitoring session

```
OS10(config)# monitor session 1
OS10(conf-mon-local-1)#
```

### Configure source and destination port, and traffic direction

```
OS10(conf-mon-local-1)# source interface ethernet 1/1/7-1/1/8 rx
OS10(conf-mon-local-1)# destination interface ethernet1/1/1
OS10(conf-mon-local-1)# no shut
```

### View configured monitoring sessions

In the State field, true indicates that the port is enabled. In the Reason field, Is UP indicates that hardware resources are allocated.

```
OS10# show monitor session all
S.Id Source Destination Dir SrcIP DstIP DSCP TTL State Reason

1 ethernet1/1/7 ethernet1/1/1 rx N/A N/A N/A N/A true Is UP
```

## Remote port monitoring

Remote port monitoring monitors ingress traffic, egress traffic, or both, on multiple source ports of multiple devices. It forwards the monitored traffic to multiple destination ports on different remote devices. Remote port monitoring helps network administrators monitor and analyze traffic to troubleshoot network problems.

In a remote port monitoring session, monitored traffic is tagged with a VLAN ID and switched on a user-defined, nonroutable L2 VLAN. The VLAN is reserved to carry only monitored traffic, which is forwarded on all egress ports of the VLAN. You must configure each intermediate switch that participates in transporting monitored traffic with the reserved L2 VLAN. Remote port monitoring supports monitoring sessions where multiple source and destination ports distribute across multiple network devices.

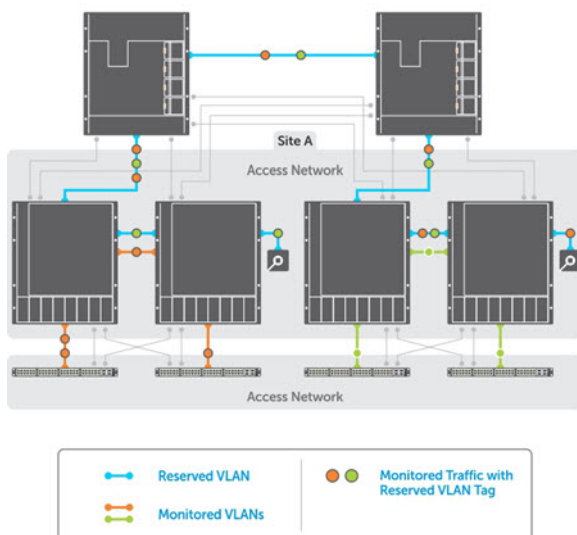

## Session and VLAN requirements

RPM requires the following:

- Source session, such as monitored ports on different source devices.
- Reserved tagged VLAN for transporting monitored traffic configured on source, intermediate, and destination devices.
- Destination session, where destination ports connect to analyzers on destination devices.

Configure any network device with source and destination ports. Enable the network device to function in an intermediate transport session for a reserved VLAN for multiple remote port monitoring sessions. You can enable and disable individual monitoring sessions.

Consider the following when configuring an RPM session:

- A remote port monitoring session mirrors monitored traffic by prefixing the reserved VLAN tag to monitored packets to transmit using the reserved VLAN.
- The source address, destination address, and original VLAN ID of the mirrored packet are prefixed with the tagged VLAN header. Untagged source packets are tagged with the reserved VLAN ID.

- The member port of the reserved VLAN must have the MTU and IPMTU value as `MAX+4` to hold the VLAN tag parameter.
- To associate with the source session, the reserved VLAN can have up to four member ports.
- To associate with the destination session, the reserved VLAN can have multiple member ports.
- The reserved VLAN cannot have untagged ports.

## Reserved L2 VLAN

- MAC address learning in the reserved VLAN is automatically disabled.
- There is no restriction on the VLAN IDs used for the reserved remote monitoring VLAN. Valid VLAN IDs are from 2 to 4093. The default VLAN ID is not supported.
- In monitored traffic, if the device has an L3 VLAN configured, packets that have the same destination MAC address as an intermediate or destination device in the path the reserved VLAN uses to transport the mirrored traffic are dropped by the device that receives the traffic .

## Source session

- Configure physical ports and port channels as sources in remote port monitoring and use them in the same source session. You can use both L2, configured with the `switchport` command, and L3 ports as source ports. Optionally, to configure the VLAN traffic to be monitored on source ports, configure one or more source VLANs.
- Use the default VLAN and native VLANs as a source VLAN.
- You cannot configure the dedicated VLAN used to transport mirrored traffic as a source VLAN.

## Restrictions

- When you use a source VLAN, enable flow-based monitoring using the `flow-based enable` command.
- In a source VLAN, only received (`rx`) traffic is monitored.
- If the port channel or VLAN has a member port configured as a destination port in a remote port monitoring session, you cannot configure a source port channel or source VLAN in a source session.
- You cannot use a destination port for remote port monitoring as a source port, including the session the port functions as the destination port.
- The reserved VLAN used to transport mirrored traffic must be an L2 VLAN. L3 VLANs are not supported.

## Configure remote port monitoring

Remote port monitoring requires the following for transporting mirrored traffic configured on the source, intermediate, and destination devices:

- A source interface
  - Monitored ports on different source network devices
  - A reserved tagged VLAN
1. Create a remote monitoring session in CONFIGURATION mode.

```
monitor session session-id type rpm-source
```

2. Enter the source to monitor traffic in MONITOR-SESSION mode.

```
source interface interface-range direction
```

3. Enter the destination to send the traffic to in MONITOR-SESSION mode.

```
destination remote-vlan vlan-id
```

4. Enable the monitoring interface in MONITOR-SESSION mode.

```
no shut
```

### Create remote monitoring session

```
OS10(config)# monitor session 10 type rpm-source
OS10(config-mon-rpm-source-10)#
```

### Configure source and destination port, and traffic direction

```
OS10(config-mon-rpm-source-10)# source interface vlan 10 rx
OS10(config-mon-rpm-source-10)# destination remote-vlan 100
OS10(config-mon-rpm-source-10)# no shut
```

### View monitoring session

```
OS10(config-mon-rpm-source-10)# do show monitor session all
S.Id Source Destination Dir SrcIP DstIP DSCP TTL State Reason

1 vlan10 vlan 100 rx N/A N/A N/A N/A true Is UP
```

## Encapsulated remote port monitoring

You can also have the monitored traffic transmitted over an L3 network to a remote analyzer. The encapsulated remote port monitoring (ERPM) session mirrors traffic from the source ports, LAGs, or source VLANs. It forwards the traffic using routable GRE-encapsulated packets to the destination IP address specified in the session.

Consider the following when configuring an ERPM session:

- OS10 supports only the ERPM source session. The encapsulated packets terminate at the destination IP address, the remote analyzer.
- The source IP address must be a valid local IP address for the session.
- The destination IP address must be on a remote L3 node that supports standard GRE decapsulation.
- If the destination IP address is not reachable, the session goes down.
- OS10 does not support an ERPM destination session and decapsulation of ERPM packets at the destination switch.
- You can configure a maximum of four ERPM sessions with a maximum of 128 source ports in each session. You can configure these four ERPM sessions in one of the following methods:
  - Single directional with either four ingress or four egress sessions.
  - Bi-directional with two ingress and two egress sessions.
- You can monitor a source VLAN only through flow-based monitoring. Only ingress is supported in flow-based source VLAN monitoring.
- You cannot configure an interface with ERPM traffic as a source for an ERPM session.
- You cannot monitor an RPM VLAN as a source.
- You cannot configure the same destination IP address for two sessions.
- You cannot configure an interface that serves as egress for a GRE tunnel as a source interface.
- ERPM supports only GRE-over-IPv4 tunneling.
- ERPM does not support Equal Cost Multi Path (ECMP).
- You can use third-party devices as only tunnel-transit devices.
- OS10 does not support monitoring VLAN subinterfaces and CPU-generated packets.

## Configure encapsulated remote port monitoring

Encapsulated remote port monitoring requires valid source and destination IP addresses. Ensure that the source IP address is local and destination IP address is remote. You can also configure the time-to-live (TTL) and differentiated services code point (DSCP) values.

1. Create monitoring session in CONFIGURATION mode.

```
monitor session session-id type erpm-source
```

2. Configure source port in MONITOR-SESSION mode.

```
source interface interface-type {both | rx | tx}
```

3. Configure source and destination IP addresses, and protocol type in MONITOR-SESSION mode.

```
source-ip source ip-address destination-ip destination ip-address [gre-protocol
protocol-value]
```

4. Configure TTL and DSCP values in MONITOR-SESSION mode.

```
ip {ttl ttl-number | dscp dscp-number}
```

5. Enable the monitoring interface in MONITOR-SESSION mode.

```
no shut
```

### Create monitoring session

```
OS10(config)# monitor session 10 type erpm-source
OS10(conf-mon-erpm-source-10)#
```

### Configure source port, source and destination IP addresses, and protocol type

```
OS10(conf-mon-erpm-source-10)# source interface ethernet 1/1/2
OS10(conf-mon-erpm-source-10)# source-ip 1.1.1.1 destination-ip 3.3.3.3 gre-protocol
35006
OS10(conf-mon-erpm-source-10)# ip ttl 16
OS10(conf-mon-erpm-source-10)# ip dscp 63
OS10(conf-mon-erpm-source-10)# no shut
```

### View configured ERPM session

```
OS10(conf-mon-erpm-source-6)# do show monitor session all
```

| S.Id | Source        | Destination | Dir  | Mode | Source IP | Dest IP | DSCP | TTL | Gre-Protocol |
|------|---------------|-------------|------|------|-----------|---------|------|-----|--------------|
| 6    | ethernet1/1/2 | remote-ip   | both | port | 1.1.1.1   | 3.3.3.3 | 63   | 16  | 35006        |

```
true Is UP
```

### View running configuration of monitor session

```
OS10# show running-configuration monitor
!
monitor session 10 type erpm-source
source-ip 1.1.1.1 destination-ip 3.3.3.3
source interface ethernet1/1/2
no shut
```

## Flow-based monitoring

Flow-based monitoring conserves bandwidth by inspecting only specified traffic instead of all interface traffic. Using flow-based monitoring, you can monitor only traffic received by the source port that matches criteria in ingress access-lists (ACLs). IPv4 ACLs, IPv6 ACLs, and MAC ACLs support flow-based monitoring.

1. Enable flow-based monitoring for a monitoring session in MONITOR-SESSION mode.

```
flow-based enable
```

2. Return to CONFIGURATION mode.

```
exit
```

3. Create an access list in CONFIGURATION mode.

```
ip access-list access-list-name
```

- Define access-list rules using `seq`, `permit`, and `deny` statements in CONFIG-ACL mode. ACL rules describe the traffic to monitor.

```
seq sequence-number {deny | permit} {source [mask] | any | host ip-address} [count
[byte]] [fragments] [threshold-in-msgs count] [capture session session-id]
```

- Return to CONFIGURATION mode.

```
exit
```

- Apply the flow-based monitoring ACL to the monitored source port in CONFIGURATION mode. The access list name can have a maximum of 140 characters.

```
ip access-group access-list-name {in | out}
```

### Enable flow-based monitoring

```
OS10(config)# monitor session 1
OS10(conf-mon-local-1)# flow-based enable
OS10(conf-mon-local-1)# exit
OS10(config)# ip access-list ipacl1
OS10(conf-ipv4-acl)# deny ip host 1.1.1.23 any capture session 1 count
OS10(conf-ipv4-acl)# exit
OS10(config)# mac access-list mac1
OS10(conf-mac-acl)# deny any any capture session 1
OS10(conf-mac-acl)# exit
OS10(config)# interface ethernet 1/1/9
OS10(conf-if-eth1/1/9)# mac access-group mac1 in
OS10(conf-if-eth1/1/9)# end
OS10# show mac access-lists in
Ingress MAC access-list mac1
Active on interfaces :
 ethernet1/1/9
seq 10 deny any any capture session 1 count (0 packets)
```

## Remote port monitoring on VLT

In a network, devices you configure with peer VLT nodes are considered as a single device. You can apply remote port monitoring (RPM) on the VLT devices in a network.

In a failover case, the monitored traffic reaches the packet analyzer connected to the top-of-rack (ToR) through the VLT interconnect link.

### NOTE:

- In VLT devices configured with RPM, when the VLT link is down, the monitored packets might drop for some time. The time is equivalent to the VLT failover recovery time, the delay restore.
- ERPM does not work on VLT devices.

### RPM on VLT scenarios

Consider a simple VLT setup where two VLT devices are connected using VLTi and a top-of-rack switch is connected to both the VLT peers using VLT LAGs in a ring topology. In this setup, the following table describes the possible scenarios when you use RPM to mirror traffic.

 NOTE: Ports that connect to the VLT domain, but not part of the VLT-LAG, are called orphan ports.

**Table 36. RPM on VLT scenarios**

| Scenario                                                                                                           | Recommendation                                                                                                                                               |
|--------------------------------------------------------------------------------------------------------------------|--------------------------------------------------------------------------------------------------------------------------------------------------------------|
| Mirror an orphan port or VLT LAG or VLTi member port to a VLT LAG. The packet analyzer connects to the ToR switch. | The recommended configuration on the peer VLT device: <ol style="list-style-type: none"> <li>Create an RPM VLAN. <pre>! interface vlan 100</pre> </li> </ol> |



**Table 36. RPM on VLT scenarios (continued)**

| Scenario                                                                                                                                                                | Recommendation                                                                                                                                                                                                                                                                                                                                                                                                                                                                                                                                                                                                   |
|-------------------------------------------------------------------------------------------------------------------------------------------------------------------------|------------------------------------------------------------------------------------------------------------------------------------------------------------------------------------------------------------------------------------------------------------------------------------------------------------------------------------------------------------------------------------------------------------------------------------------------------------------------------------------------------------------------------------------------------------------------------------------------------------------|
|                                                                                                                                                                         | <pre> no shutdown remote-span !</pre> <p>2. Create an L2 ACL for the RPM VLAN - RPM session and attach it to VLTi LAG interface.</p> <pre> ! mac access-list rpm seq 10 permit any any capture session 10 vlan 100 !</pre> <pre> interface ethernet 1/1/1 no shutdown switchport access vlan 1 mac access-group rpm in !</pre> <p>3. Create a flow-based RPM session on the peer VLT device to monitor the VLTi LAG interface as the source.</p> <pre> ! monitor session 10 type rpm-source destination remote-vlan 100 flow-based enable source interface ethernet1/1/1 (ICL lag member) !</pre>                |
| <p>Mirror a VLAN with VLTi LAG as a member to any orphan port on the same VLT device. The packet analyzer connects to the local VLT device through the orphan port.</p> | <p>The recommended configuration on the VLT device:</p> <p>1. Create an L2 ACL for the local session and attach it to the VLTi LAG interface.</p> <pre> ! mac access-list local seq 10 permit any any capture session 10 !</pre> <pre> interface ethernet 1/1/1 no shutdown switchport access vlan 1 mac access-group local in !</pre> <p>2. Create a flow-based local session on the VLT device to monitor the VLTi LAG interface member (Ethernet 1/1/1) as source.</p> <pre> ! monitor session 10 type destination interface ethernet 1/1/10 flow-based enable source interface ethernet1/1/1 no shut !</pre> |
| <p>Mirror a VLAN with a VLTi LAG as the member to the VLT LAG on the same VLT device. The packet analyzer connects to the ToR switch.</p>                               | <p>—</p>                                                                                                                                                                                                                                                                                                                                                                                                                                                                                                                                                                                                         |
| <p>Mirror a VLT LAG of the ToR, or any port in the ToR to any orphan port in the VLT device. Configure VLT nodes as</p>                                                 | <p>—</p>                                                                                                                                                                                                                                                                                                                                                                                                                                                                                                                                                                                                         |

**Table 36. RPM on VLT scenarios (continued)**

| Scenario                                                                                                                                                                                                                                        | Recommendation                                                                                                                                    |
|-------------------------------------------------------------------------------------------------------------------------------------------------------------------------------------------------------------------------------------------------|---------------------------------------------------------------------------------------------------------------------------------------------------|
| intermediate devices. The packet analyzer connects to the ToR switch.                                                                                                                                                                           |                                                                                                                                                   |
| Mirror a VLT LAG to any orphan port on the same VLT device. The packet analyzer connects to the local VLT device through the orphan port.                                                                                                       | If the packet analyzer directly connects to the VLT peer where the source session is configured, use local port monitoring instead of RPM.        |
| Mirror an orphan port in the primary VLT device to any orphan port on a secondary VLT device through the VLTi. The packet analyzer connects to the secondary VLT device through the orphan port. In this case, the mirroring packets duplicate. | —                                                                                                                                                 |
| Mirror a VLT LAG of the primary VLT device to any orphan port on a secondary VLT device through the VLTi. The packet analyzer connects to the secondary VLT device through the orphan port.                                                     | —                                                                                                                                                 |
| Mirror a member port of the VLTi LAG or VLT LAG to any orphan port in the same device. The packet analyzer connects to the local VLT device through the orphan port.                                                                            | If the packet analyzer is directly connected to the VLT peer in which the source session is configured, use local port monitoring instead of RPM. |
| Mirror a member port of VLTi LAG to the VLT LAG on the same VLT device. The packet analyzer connects to the ToR switch.                                                                                                                         | —                                                                                                                                                 |
| Mirror a VLT LAG or VLT member port as part of the source VLAN and destination VLAN. The packet analyzer connects to the ToR switch.                                                                                                            | —                                                                                                                                                 |

## Port monitoring commands

### description

Configures a description for the port monitoring session. The monitoring session can be: local, RPM, or ERPM.

|                     |                                                                                                  |
|---------------------|--------------------------------------------------------------------------------------------------|
| <b>Syntax</b>       | <code>description string</code>                                                                  |
| <b>Parameters</b>   | <code>string</code> —Enter a description of the monitoring session. A maximum of 255 characters. |
| <b>Default</b>      | Not configured                                                                                   |
| <b>Command Mode</b> | MONITOR-SESSION                                                                                  |

- Usage Information**
- To use special characters as a part of the description string, enclose the string in double quotes.
  - To use comma as a part of the description string add double back slash before the comma.
  - The `no` version of this command removes the description text.

This command is introduced on the MX9116n and MX5108n with support for full-switch mode from the Dell EMC SmartFabric OS release 10.4.0(R3S). Also supported in SmartFabric Services mode on the MX9116n and MX5108n from the Dell EMC SmartFabric OS release 10.5.1.

#### Example

```
OS10(conf-mon-local-1)# description remote
```

```
OS10(conf-mon-rpm-source-5)# description "RPM Sesssion"
```

```
OS10(conf-mon-erpm-source-10)# description "ERPM Session"
```

|                           |                  |
|---------------------------|------------------|
| <b>Supported Releases</b> | 10.2.0E or later |
|---------------------------|------------------|

## destination

Sets the destination where monitored traffic is sent to. The monitoring session can be local or RPM.

|                           |                                                                                                                                                                                                                                                                                                                                                                                                                                                                                                                                                                                                                              |
|---------------------------|------------------------------------------------------------------------------------------------------------------------------------------------------------------------------------------------------------------------------------------------------------------------------------------------------------------------------------------------------------------------------------------------------------------------------------------------------------------------------------------------------------------------------------------------------------------------------------------------------------------------------|
| <b>Syntax</b>             | <code>destination {interface <i>interface-type</i>   remote-vlan <i>vlan-id</i>}</code>                                                                                                                                                                                                                                                                                                                                                                                                                                                                                                                                      |
| <b>Parameters</b>         | <p><code>interface-type</code>—Enter the interface type for a local monitoring session.</p> <ul style="list-style-type: none"><li>• <code>ethernet <i>node/slot/port[:subport]</i></code>—Enter the Ethernet interface information as the destination.</li><li>• <code>port-channel <i>id-number</i></code>—Enter a port-channel number as the destination, from 1 to 128.</li><li>• <code>vlan <i>vlan-id</i></code>—Enter a VLAN ID as the destination, from 1 to 4093.</li></ul> <p><code>remote-vlan <i>vlan-id</i></code>—Enter a remote VLAN ID as the destination for the RPM monitoring session, from 1 to 4093.</p> |
| <b>Default</b>            | Not configured                                                                                                                                                                                                                                                                                                                                                                                                                                                                                                                                                                                                               |
| <b>Command Mode</b>       | MONITOR-SESSION                                                                                                                                                                                                                                                                                                                                                                                                                                                                                                                                                                                                              |
| <b>Usage Information</b>  | <p>The <code>no</code> version of this command resets the value to the default.</p> <p>This command is introduced on the MX9116n and MX5108n with support for <i>full-switch</i> mode from the Dell EMC SmartFabric OS release 10.4.0(R3S). Also supported in SmartFabric Services mode on the MX9116n and MX5108n from the Dell EMC SmartFabric OS release 10.5.1.</p>                                                                                                                                                                                                                                                      |
| <b>Example</b>            | <pre>OS10(conf-mon-local-10)# destination interface port-channel 10</pre> <pre>OS10(conf-mon-rpm-source-3)# destination remote-vlan 20</pre>                                                                                                                                                                                                                                                                                                                                                                                                                                                                                 |
| <b>Supported Releases</b> | 10.2.0E or later                                                                                                                                                                                                                                                                                                                                                                                                                                                                                                                                                                                                             |

## flow-based

Enables flow-based monitoring. The monitoring session can be: local, RPM, or ERPM.

|                           |                                                                                                                                                                                                                                                                                                                                                                            |
|---------------------------|----------------------------------------------------------------------------------------------------------------------------------------------------------------------------------------------------------------------------------------------------------------------------------------------------------------------------------------------------------------------------|
| <b>Syntax</b>             | <code>flow-based enable</code>                                                                                                                                                                                                                                                                                                                                             |
| <b>Parameters</b>         | None                                                                                                                                                                                                                                                                                                                                                                       |
| <b>Default</b>            | Disabled                                                                                                                                                                                                                                                                                                                                                                   |
| <b>Command Mode</b>       | MONITOR-SESSION                                                                                                                                                                                                                                                                                                                                                            |
| <b>Usage Information</b>  | <p>The <code>no</code> version of this command disables the flow-based monitoring.</p> <p>This command is introduced on the MX9116n and MX5108n with support for <i>full-switch</i> mode from the Dell EMC SmartFabric OS release 10.4.0(R3S). Also supported in SmartFabric Services mode on the MX9116n and MX5108n from the Dell EMC SmartFabric OS release 10.5.1.</p> |
| <b>Example</b>            | <pre>OS10(conf-mon-local-1)# flow-based enable</pre> <pre>OS10(conf-mon-rpm-source-2)# flow-based enable</pre> <pre>OS10(conf-mon-erpm-source-3)# flow-based enable</pre>                                                                                                                                                                                                  |
| <b>Supported Releases</b> | 10.2.0E or later                                                                                                                                                                                                                                                                                                                                                           |

## ip

Configures the IP time-to-live (TTL) value and the differentiated services code point (DSCP) value for the ERPM traffic.

**Syntax** `ip {ttl ttn-number | dscp dscp-number}`

- Parameters**
- *ttn-number*—Enter the TTL value, from 1 to 255.
  - *dscp-number*—Enter the DSCP value, from 0 to 63.

- Default**
- TTL: 255
  - DSCP: 0

**Command Mode** MONITOR-SESSION (ERPM)

**Usage Information** The `no` version of this command removes the configured TTL and DSCP values.

This command is introduced on the MX9116n and MX5108n with support for *full-switch* mode from the Dell EMC SmartFabric OS release 10.4.0(R3S). Also supported in SmartFabric Services mode on the MX9116n and MX5108n from the Dell EMC SmartFabric OS release 10.5.1.

**Example**

```
OS10(conf-mon-erpm-source-10)# ip ttl 16
OS10(conf-mon-erpm-source-10)# ip DSCP 63
```

**Supported Releases** 10.4.0E(R1) or later

## monitor session

Creates a session for monitoring traffic with port monitoring.

**Syntax** `monitor session session-id type [local | rpm-source | erpm-source]`

- Parameters**
- *session-id*—Enter a monitor session ID, from 1 to 18.
  - *local*—(Optional) Enter a local monitoring session.
  - *rpm-source*—(Optional) Enter a remote monitoring session.
  - *erpm-source*—(Optional) Enter an encapsulated remote monitoring session.

**Default** local

**Command Mode** CONFIGURATION

**Usage Information** The `no` version of this command removes the monitor session.

This command is introduced on the MX9116n and MX5108n with support for *full-switch* mode from the Dell EMC SmartFabric OS release 10.4.0(R3S). Also supported in SmartFabric Services mode on the MX9116n and MX5108n from the Dell EMC SmartFabric OS release 10.5.1.

**Example**

```
OS10(config)# monitor session 1
OS10(conf-mon-local-1)#
```

**Example (RPM)**

```
OS10(config)# monitor session 5 type rpm-source
OS10(conf-mon-rpm-source-5)#
```

**Example (ERPM)**

```
OS10(config)# monitor session 10 type erpm-source
OS10(conf-mon-erpm-source-10)#
```

**Supported Releases** 10.2.0E or later

## show monitor session

Displays information about a monitoring session.

**Syntax** `show monitor session {session-id | all}`

- Parameters**
- `session-id`—Enter the session ID number, from 1 to 18.
  - `all`—View all monitoring sessions.

**Default** All

**Command Mode** EXEC

**Usage Information** In the State field, `true` indicates that the port is enabled. In the Reason field, `Is UP` indicates that hardware resources are available.

This command is introduced on the MX9116n and MX5108n with support for *full-switch* mode from the Dell EMC SmartFabric OS release 10.4.0(R3S). Also supported in SmartFabric Services mode on the MX9116n and MX5108n from the Dell EMC SmartFabric OS release 10.5.1.

### Example (specific session)

```
OS10# show monitor session 1
S.Id Source Destination Dir Mode Source IP Dest IP DSCP TTL Gre-Pri

1 ethernet1/1/1 remote-ip both port 11.11.11.1 11.11.11.11 0 255 35006
```

### Example (all sessions)

```
OS10# show monitor session all
S.Id Source Destination Dir Mode Source IP Dest IP DSCP TTL Gre-Pri

1 ethernet1/1/1 remote-ip both port 11.11.11.1 11.11.11.11 0 255 35006
9 ethernet1/1/9 remote-ip both port N/A N/A N/A N/A N/A
7 ethernet1/1/9 vlan40 both port N/A N/A N/A N/A N/A
4 ethernet1/1/1 remote-ip both port N/A N/A 0 255 35006
Destination is not resolved
6 ethernet1/1/2 remote-ip both port 11.11.11.1 2.2.2.1 0 255 35006
session does not exist
```

**Supported Releases** 10.2.0E or later

## shut

Disables the monitoring session. The monitoring session can be: local, RPM, or ERPM.

**Syntax** `shut`

**Parameters** None

**Default** Disabled

**Command Mode** MONITOR-SESSION

**Usage Information** The `no` version of this command enables the monitoring session.

This command is introduced on the MX9116n and MX5108n with support for *full-switch* mode from the Dell EMC SmartFabric OS release 10.4.0(R3S). Also supported in SmartFabric Services mode on the MX9116n and MX5108n from the Dell EMC SmartFabric OS release 10.5.1.

### Example

```
OS10(config)# monitor session 1
OS10(conf-mon-local-1)# no shut
```

```
OS10(config)# monitor session 5 type rpm-source
OS10(conf-mon-rpm-source-5)# no shut
```

```
OS10(config)# monitor session 10 type erpm-source
OS10(conf-mon-erpm-source-10)# no shut
```

**Supported Releases** 10.2.0E or later

## source

Configures a source for port monitoring. The monitoring session can be: local, RPM, or ERPM.

**Syntax** `source interface interface-type {both | rx | tx}`

- Parameters**
- `interface-type`—Enter the interface type:
    - `ethernet node/slot/port[:subport]`—Enter the Ethernet interface information as the monitored source.
    - `port-channel id-number`—Enter the port-channel interface number as the monitored source, from 1 to 128.
    - `vlan vlan-id`—Enter the VLAN identifier as the monitored source, from 1 to 4093.
  - `both`—Monitor both receiving and transmitting packets. This option is not supported on VLAN interfaces.
  - `rx`—Monitor only received packets.
  - `tx`—Monitor only transmitted packets. This option is not supported on VLAN interfaces.

**Default** Not configured

**Command Mode** MONITOR-SESSION

**Usage Information** This command is introduced on the MX9116n and MX5108n with support for *full-switch* mode from the Dell EMC SmartFabric OS release 10.4.0(R3S). Also supported in SmartFabric Services mode on the MX9116n and MX5108n from the Dell EMC SmartFabric OS release 10.5.1.

### Example

```
OS10(config)# monitor session 1
OS10(conf-mon-local-1)# source interface ethernet 1/1/7 rx
```

```
OS10(config)# monitor session 5 type rpm-source
OS10(conf-mon-rpm-source-5)# source interface ethernet 1/1/10 rx
```

```
OS10(config)# monitor session 10 type erpm-source
OS10(conf-mon-erpm-source-10)# source interface ethernet 1/1/5 rx
```

**Supported Releases** 10.2.0E or later

## source-ip

Configures the source, destination, and protocol type of the monitored port for an ERPM monitoring session.

**Syntax** `source-ip source ip-address destination-ip destination ip-address [gre-protocol protocol-value]`

- Parameters**
- `source ip-address`—Enter the source IP address.
  - `destination ip-address`—Enter the destination IP address.
  - `protocol-value`—Enter the GRE protocol value, from 1 to 65535, default: 35006.

**Default** Not configured

**Command Mode** MONITOR-SESSION

**Usage Information** This command is introduced on the MX9116n and MX5108n with support for *full-switch* mode from the Dell EMC SmartFabric OS release 10.4.0(R3S). Also supported in SmartFabric Services mode on the MX9116n and MX5108n from the Dell EMC SmartFabric OS release 10.5.1.

**Example**

```
OS10(config)# monitor session 10
OS10(conf-mon-erpm-source-10)# source-ip 10.16.132.181 destination-ip
172.16.10.11 gre-protocol 35006
```

**Supported  
Releases**

10.4.0E(R1) or later

## Layer 3

|                                                  |                                                                                                                                                                                                                                                                                                                                            |
|--------------------------------------------------|--------------------------------------------------------------------------------------------------------------------------------------------------------------------------------------------------------------------------------------------------------------------------------------------------------------------------------------------|
| <b>Bidirectional forwarding detection (BFD)</b>  | Provides rapid failure detection in links with adjacent routers (see <a href="#">BFD commands</a> ).                                                                                                                                                                                                                                       |
| <b>Border Gateway Protocol (BGP)</b>             | Provides an external gateway protocol that transmits inter-domain routing information within and between autonomous systems (see <a href="#">BGP Commands</a> ).                                                                                                                                                                           |
| <b>Equal Cost Multi-Path (ECMP)</b>              | Provides next-hop packet forwarding to a single destination over multiple best paths (see <a href="#">ECMP Commands</a> ).                                                                                                                                                                                                                 |
| <b>IPv4 Routing</b>                              | Provides forwarding of packets to a destination IP address, based on a routing table. This routing table defines how packets are routed — dynamically, broadcasted directly to, using proxy ARP, as well as what type of information is included with the packets (see <a href="#">IPv4 Routing Commands</a> ).                            |
| <b>IPv6 Routing</b>                              | Provides routing for the IPv6 address space, stateless auto-configuration, header format simplifications, and improved support for options and extensions (see <a href="#">IPv6 Routing Commands</a> ).                                                                                                                                    |
| <b>Open Shortest Path First (OSPF)</b>           | Provides a link-state routing protocol that communicates with all other devices in the same autonomous system area using link-state advertisements (LSAs). OS10 supports up to 10,000 OSPF routes for OSPFv2 to designate up to 8,000 routes as external, and up to 2,000 as inter/intra area routes (see <a href="#">OSPF Commands</a> ). |
| <b>Virtual Router Redundancy Protocol (VRRP)</b> | Provides a mechanism to eliminate a single point of failure in a statically routed network (see <a href="#">VRRP Commands</a> ).                                                                                                                                                                                                           |
| <b>Virtual Routing and Forwarding (VRF)</b>      | Provides a mechanism to partition a physical router into multiple virtual routers (see <a href="#">VRF Commands</a> ).                                                                                                                                                                                                                     |

### Configuration notes

Dell EMC PowerSwitch S4200-ON Series:

Though it is possible to configure more VRIDs in VRRP, the S4200-ON Series switches support only up to 16 VRIDs. This number decreases when VLT peer routing is enabled.

## Virtual routing and forwarding

VRF partitions a physical router into multiple virtual routers (VRs). The control and data plane are isolated in each VR; traffic does not flow across VRs. VRF allows multiple instances of routing tables to co-exist within the same router simultaneously.

OS10 supports a management VRF instance, a default VRF instance, and a maximum of 512 non-default VRF instances. Use the default and non-default VRF instances to configure routing.

You can move the management interface from the default to management VRF instance. You need not create the management VRF instance as it already exists in the system by default.

By default, OS10 initially assigns all physical interfaces and all logical interfaces to the default VRF instance.

## Configure management VRF

You can assign only management interfaces to the management VRF instance.

Before you assign the management interface to the management VRF instance, delete all the configured settings, including the IP address, on the management interface.

1. Enter the `ip vrf management` command in CONFIGURATION mode. Use Non-Transaction-Based Configuration mode only. Do not use Transaction-Based mode.



2. Add the management interface using the `interface management` command in VRF CONFIGURATION mode.

### Configure management VRF

```
OS10(config)# ip vrf management
OS10(conf-vrf)# interface management
```

You can enable various services in both management or default VRF instances. The services that are supported in the management and default VRF instances are:

**Table 37. Services supported**

| Application     | Management VRF | Default VRF | Non-default VRF |
|-----------------|----------------|-------------|-----------------|
| BGP             | No             | Yes         | Yes             |
| COPP ACL        | Yes            | Yes         | No              |
| DHCP client     | Yes            | Yes         | Yes             |
| DHCP relay      | No             | Yes         | Yes             |
| DHCP server     | No             | Yes         | No              |
| DNS client      | Yes            | Yes         | Yes             |
| FTP client      | Yes            | Yes         | Yes             |
| HTTP client     | Yes            | Yes         | Yes             |
| ICMP/Ping       | Yes            | Yes         | Yes             |
| NTP client      | Yes            | Yes         | Yes             |
| NTP server      | Yes            | Yes         | Yes             |
| OSPFV2 /OSPFV3  | No             | Yes         | Yes             |
| RADIUS server   | Yes            | Yes         | Yes             |
| SCP client      | Yes            | Yes         | Yes             |
| sFlow           | Yes            | Yes         | Yes             |
| SFTP            | Yes            | Yes         | Yes             |
| SNMP traps      | Yes            | Yes         | No              |
| SSH server`     | Yes            | Yes         | Yes             |
| Syslog          | Yes            | Yes         | Yes             |
| TACACS+ server  | Yes            | Yes         | Yes             |
| Telnet server   | Yes            | Yes         | Yes             |
| TFTP client     | Yes            | Yes         | Yes             |
| Traceroute      | Yes            | Yes         | Yes             |
| VLT backup link | Yes            | Yes         | No              |
| VRRP            | Yes            | Yes         | Yes             |

## Configuration notes

All Dell EMC PowerSwitches except MX-Series, S4200-Series, S5200 Series, and Z9332F-ON:

Before you assign the management port to the management VRF instance, you must remove all configured settings on the management port, including the IP address. Perform this action from the console. Removing the IP address disconnects all existing SSH and Telnet sessions on the switch.

The following example shows removing IP address, configuring management VRF, and then adding IP address:

```
OS10(conf-if-ma-1/1/1)# do show version
Dell EMC Networking OS10 Enterprise
Copyright (c) 1999-2020 by Dell Inc. All Rights Reserved.
OS Version: 10.5.2.0
Build Version: 10.5.2.0.99999
Build Time: 2020-08-21T05:54:18+0000
System Type: S5248F-VM
Architecture: x86_64
Up Time: 4 days 03:46:41
OS10(conf-if-ma-1/1/1)#

OS10(config)# ip vrf management
OS10(conf-vrf)# interface management
% Error: Configurations are existing in interface mgmt1/1/1
OS10(conf-vrf)# exit
OS10(config)# interface mgmt 1/1/1
OS10(conf-if-ma-1/1/1)# show configuration
!
interface mgmt1/1/1
no shutdown
no ip address dhcp
ip address 100.104.34.30/24
ipv6 address autoconfig
OS10(conf-if-ma-1/1/1)# no ip address
OS10(conf-if-ma-1/1/1)# no ipv6 address autoconfig
OS10(conf-if-ma-1/1/1)# exit
OS10(config)# ip vrf management
OS10(conf-vrf)# interface management
OS10(conf-vrf)# exit
OS10(config)# interface mgmt 1/1/1
OS10(conf-if-ma-1/1/1)# ip address 100.104.34.30/24
OS10(conf-if-ma-1/1/1)# show configuration
!
interface mgmt1/1/1
no shutdown
no ip address dhcp
ip address 100.104.34.30/24
OS10(conf-if-ma-1/1/1)# do show ip vrf management
VRF-Name Interfaces
management Mgmt1/1/1

OS10(conf-if-ma-1/1/1)#
```

## Configure a static route for a management VRF instance

Configure a static route that directs traffic to the management interface:

```
management route ip-address mask managementethernet
```

Or

```
management route ipv6-address prefix-length managementethernet
```

You can also configure the management route to direct traffic to a physical interface. For example:

```
management route 10.1.1.0/24 managementethernet
```

Or

```
management route 2::/64 managementethernet
```

## Configure non-default VRF instances

In addition to a management VRF instance and default VRF, OS10 also supports non-default VRF instances. You can create a maximum of 512 non-default VRF instances.

While you can assign management interfaces only to the management VRF instance, you can assign any physical or logical interface – VLAN, port channel, or loopback, to a non-default VRF instance.

When you create a new non-default VRF instance, OS10 does not assign any interface to it. You can assign the new VRF instance to any of the existing physical or logical interfaces, provided they are not already assigned to another non-default VRF.

**NOTE:** When you create a new logical interface, OS10 assigns it automatically to the default VRF instance. In addition, OS10 initially assigns all physical Layer 3 interfaces to the default VRF instance.

You can reassign any interface that is assigned to a non-default VRF instance back to the default VRF instance.

- To create a non-default VRF instance, from the CONFIGURATION mode, specify a name and enter the VRF configuration mode:

```
CONFIGURATION
ip vrf vrf-name
```

## Assign an interface to a non-default VRF instance

After creating a non-default VRF instance, you can associate an interface to the VRF instance that you created.

To assign an interface to a non-default VRF, perform the following steps:

1. Enter the interface that you want to assign to a non-default VRF instance.

```
CONFIGURATION
interface ethernet 1/1/1
```

2. Remove the interface from L2 switching.

```
INTERFACE
no switchport
```

3. Assign the interface to a non-default VRF.

```
INTERFACE CONFIGURATION
ip vrf forwarding vrf-test
```

Before assigning an interface to a VRF instance, ensure that no IP address is configured on the interface.

4. Assign an IPv4 address to the interface.

```
INTERFACE CONFIGURATION
ip address 10.1.1.1/24
```

5. Assign an IPv6 address to the interface.

```
INTERFACE CONFIGURATION
ipv6 address 1::1/64
```

You can also auto configure an IPv6 address using the `ipv6 address autoconfig` command.

**NOTE:** Before configuring any routing protocol in a VRF instance, you must first assign an IP address to at least one of the interfaces assigned to the VRF instance on which you want to configure routing protocols.

## Assigning a loopback interface to a non-default VRF instance

After creating a non-default VRF instance you can associate a loopback interface to the VRF instance that you created.

To assign a loopback interface to a non-default VRF, perform the following steps:

1. Enter the loopback interface that you want to assign to a non-default VRF instance.

```
CONFIGURATION
interface loopback 5
```

2. Assign the interface to a non-default VRF.

## INTERFACE CONFIGURATION

```
ip vrf forwarding vrf-test
```

Before assigning an interface to a VRF instance, ensure that no IP address is configured on the interface.

3. Assign an IPv4 address to the interface.

## INTERFACE CONFIGURATION

```
ip address 10.1.1.1/24
```

4. Assign an IPv6 address to the interface.

## INTERFACE CONFIGURATION

```
ipv6 address 1::1/64
```

You can also auto configure an IPv6 address using the `ipv6 address autoconfig` command.

## Assign an interface back to the default VRF instance

**Table 38. Configurations to be deleted**

| CONFIGURATION                                                                                                                     | MODE                    | COMMAND                                                                                            |
|-----------------------------------------------------------------------------------------------------------------------------------|-------------------------|----------------------------------------------------------------------------------------------------|
| IP address—In interface configuration mode, undo the IP address configuration.                                                    | INTERFACE CONFIGURATION | OS10(conf-if-eth1/1/10:1)#no ip address <i>ipv4-address</i> or no ipv6 address <i>ipv6-address</i> |
| Port—In interface configuration mode, delete the interface association corresponding to the VRF instance that you want to delete. | INTERFACE CONFIGURATION | OS10(conf-if-eth1/1/10:1)#no ip vrf forwarding                                                     |

To assign an interface back to the default VRF, perform the following steps:

1. Enter the interface that you want to assign back to the default VRF instance.

## CONFIGURATION

```
interface ethernet 1/1/1
```

2. Remove the IPv4 address associated with the interface.

## INTERFACE CONFIGURATION

```
no ip address
```

3. Remove the IPv6 address associated with the interface.

## INTERFACE CONFIGURATION

```
no ipv6 address
```

4. Assign the interface back to the default VRF instance.

## INTERFACE CONFIGURATION

```
no ip vrf forwarding
```

## Assigning the management interface back to the default VRF instance

To assign the management interface back to the default VRF, perform the following steps:

1. Enter the management VRF instance.

## CONFIGURATION

```
ip vrf management
```

2. Remove the IPv4 address associated with the interface.

## INTERFACE CONFIGURATION

```
no ip address
```

3. Remove the IPv6 address associated with the interface.

## INTERFACE CONFIGURATION

```
no ipv6 address
```

4. Assign the management interface back to the default VRF instance.

```
CONFIGURATION VRF
```

```
no interface management
```

## Deleting a non-default VRF instance

Before deleting a non-default VRF instance, ensure all the dependencies and associations corresponding to that VRF instance are first deleted or disabled. The following procedure describes how to delete a non-default VRF instance:

After deleting all dependencies, you can delete the non-default VRF instances that you have created.

- Delete a non-default VRF instance using the following command:

```
CONFIGURATION
```

```
no ip vrf vrf-name
```

 **NOTE:** You cannot delete the default VRF instance.

## Configure a static route for a non-default VRF instance

- Configure a static route in a non-default VRF instance. Static routes contain IP addresses of the next-hop neighbors that are reachable through the non-default VRF. These IP addresses could also belong to the interfaces that are part of the non-default VRF instance.

```
CONFIGURATION
```

```
ip route vrf vrf-name ip-address mask next-hop-ip-address or ipv6 route vrf vrf-name ipv6-address prefix-length next-hp[=ipv6-address
```

For example: `ip route vrf red 10.1.1.0/24 20.1.1.6` or `ipv6 route vrf red 2::/64 3::1`

- Configure the route to direct traffic to a front-panel port in case of a non-default VRF instance.

```
CONFIGURATION
```

```
ip route ip-address-mask ethernet interface-type or ipv6 route ipv6-address-mask ethernet interface-type
```

For example: `ip route 10.1.1.0/24 ethernet 1/1/1` or `ipv6 route 2::/64 ethernet 1/1/1`. Where ethernet 1/1/1 is part of the non-default VRF.

## Configuring static entry in IPv6 neighbor

- Configure a static entry in the IPv6 neighbor discovery.

```
CONFIGURATION
```

```
ipv6 neighbor vrf vrf-test 1::1 ethernet 1/1/1 xx:xx:xx:xx:xx:xx
```

## VRF configuration

The following configuration illustrates a typical VRF setup:

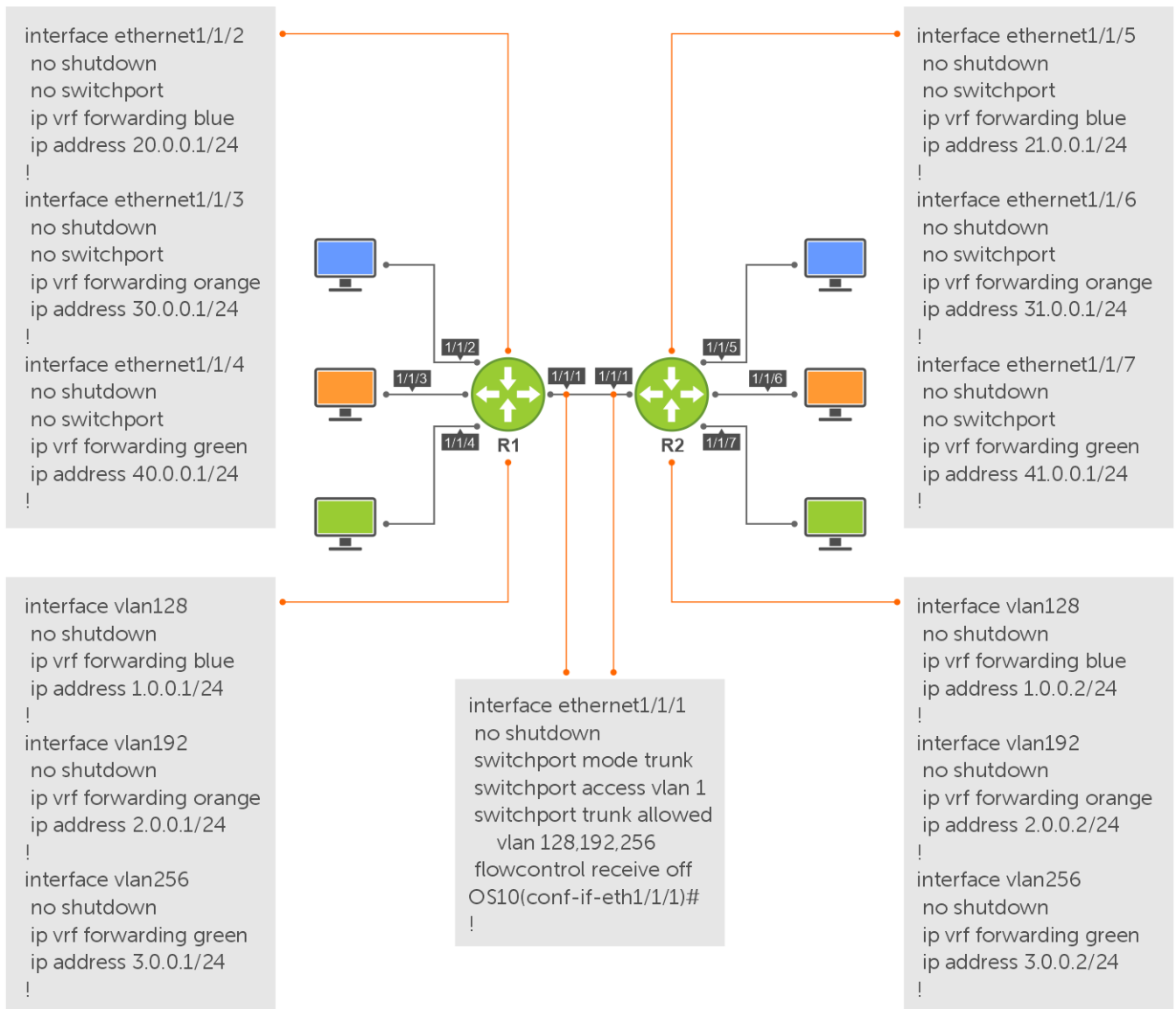

Figure 7. Setup VRF Interfaces

### Router 1

```
ip vrf blue
!
ip vrf orange
!
ip vrf green
!
interface ethernet 1/1/1
 no shutdown
 switchport mode trunk
 switchport access vlan 1
 switchport trunk allowed vlan 128,192,256
 flowcontrol receive off
!
interface ethernet1/1/2
 no shutdown
 no switchport
 ip vrf forwarding blue
 ip address 20.0.0.1/24
!
interface ethernet1/1/3
```

```

no switchport
ip vrf forwarding orange
ip address 30.0.0.1/24
!
interface ethernet1/1/4
no shutdown
no switchport
ip vrf forwarding green
ip address 40.0.0.1/24
!
interface vlan128
mode L3
no shutdown
ip vrf forwarding blue
ip address 1.0.0.1/24
!
interface vlan192
mode L3
no shutdown
ip vrf forwarding orange
ip address 2.0.0.1/24
!
!
interface vlan256
mode L3
no shutdown
ip vrf forwarding green
ip address 3.0.0.1/24
!
ip route vrf green 31.0.0.0/24 3.0.0.1

```

## Router 2

```

ip vrf blue
!
ip vrf orange
!
ip vrf green
!
interface ethernet 1/1/1
no shutdown
switchport mode trunk
switchport access vlan 1
switchport trunk allowed vlan 128,192,256
flowcontrol receive off
!
interface ethernet1/1/5
no shutdown
no switchport
ip vrf forwarding blue
ip address 21.0.0.1/24
!
interface ethernet1/1/6
no shutdown
no switchport
ip vrf forwarding orange
ip address 31.0.0.1/24
!
interface ethernet1/1/7
no shutdown
no switchport
ip vrf forwarding green
ip address 41.0.0.1/24
!
interface vlan128
mode L3
no shutdown
ip vrf forwarding blue
ip address 1.0.0.2/24
!
interface vlan192
mode L3
no shutdown

```

```

ip vrf forwarding orange
ip address 2.0.0.2/24
!
interface vlan256
mode L3
no shutdown
ip vrf forwarding green
ip address 3.0.0.2/24
!
ip route vrf green 30.0.0.0/24 3.0.0.2

```

### Router 1 show command output

```

OS10# show ip vrf
VRF-Name Interfaces
blue Eth1/1/2
 Vlan128

default Mgmt1/1/1
 Vlan1,24-25,200

green Eth1/1/4
 Vlan256

orange Eth1/1/3
 Vlan192

OS10# show ip route vrf blue
Codes: C - connected
 S - static
 B - BGP, IN - internal BGP, EX - external BGP
 O - OSPF, IA - OSPF inter area, N1 - OSPF NSSA external type 1,
 N2 - OSPF NSSA external type 2, E1 - OSPF external type 1,
 E2 - OSPF external type 2, * - candidate default,
 + - summary route, > - non-active route
Gateway of last resort is not set

```

| Destination   | Gateway      |               | Dist/Metric | Last Change |
|---------------|--------------|---------------|-------------|-------------|
| C 20.0.0.0/24 | via 20.0.0.1 | ethernet1/1/2 | 0/0         | 01:46:41    |
| C 1.0.0.0/24  | via 1.0.0.1  | vlan128       | 0/0         | 01:04:23    |

```

OS10# show ip route vrf orange
Codes: C - connected
 S - static
 B - BGP, IN - internal BGP, EX - external BGP
 O - OSPF, IA - OSPF inter area, N1 - OSPF NSSA external type 1,
 N2 - OSPF NSSA external type 2, E1 - OSPF external type 1,
 E2 - OSPF external type 2, * - candidate default,
 + - summary route, > - non-active route
Gateway of last resort is not set

```

| Destination   | Gateway      |               | Dist/Metric | Last Change |
|---------------|--------------|---------------|-------------|-------------|
| C 30.0.0.0/24 | via 30.0.0.1 | ethernet1/1/3 | 0/0         | 01:55:00    |
| C 2.0.0.0/24  | via 2.0.0.1  | vlan192       | 0/0         | 01:04:14    |

```

OS10# show ip route vrf green
Codes: C - connected
 S - static
 B - BGP, IN - internal BGP, EX - external BGP
 O - OSPF, IA - OSPF inter area, N1 - OSPF NSSA external type 1,
 N2 - OSPF NSSA external type 2, E1 - OSPF external type 1,
 E2 - OSPF external type 2, * - candidate default,
 + - summary route, > - non-active route
Gateway of last resort is not set

```

| Destination   | Gateway      |               | Dist/Metric | Last Change |
|---------------|--------------|---------------|-------------|-------------|
| C 40.0.0.0/24 | via 40.0.0.1 | ethernet1/1/4 | 0/0         | 02:01:15    |
| C 3.0.0.0/24  | via 3.0.0.1  | vlan256       | 0/0         | 01:04:03    |

```

=====

```



## Router 2 show command output

```
OS10# show ip vrf
VRF-Name Interfaces
blue Eth1/1/5
 Vlan128

default Mgmt1/1/1
 Vlan1,24-25,200

green Eth1/1/7
 Vlan256

orange Eth1/1/6
 Vlan192

OS10# show ip route vrf blue
Codes: C - connected
 S - static
 B - BGP, IN - internal BGP, EX - external BGP
 O - OSPF, IA - OSPF inter area, N1 - OSPF NSSA external type 1,
 N2 - OSPF NSSA external type 2, E1 - OSPF external type 1,
 E2 - OSPF external type 2, * - candidate default,
 + - summary route, > - non-active route
Gateway of last resort is not set
 Destination Gateway Dist/Metric Last Change

 C 21.0.0.0/24 via 21.0.0.1 ethernet1/1/5 0/0 02:05:00
 C 1.0.0.0/24 via 1.0.0.2 vlan128 0/0 01:04:47

OS10# show ip route vrf orange
Codes: C - connected
 S - static
 B - BGP, IN - internal BGP, EX - external BGP
 O - OSPF, IA - OSPF inter area, N1 - OSPF NSSA external type 1,
 N2 - OSPF NSSA external type 2, E1 - OSPF external type 1,
 E2 - OSPF external type 2, * - candidate default,
 + - summary route, > - non-active route
Gateway of last resort is not set
 Destination Gateway Dist/Metric Last Change

 C 31.0.0.0/24 via 31.0.0.1 ethernet1/1/6 0/0 02:09:19
 C 2.0.0.0/24 via 2.0.0.2 vlan192 0/0 01:04:36

OS10# show ip route vrf green
Codes: C - connected
 S - static
 B - BGP, IN - internal BGP, EX - external BGP
 O - OSPF, IA - OSPF inter area, N1 - OSPF NSSA external type 1,
 N2 - OSPF NSSA external type 2, E1 - OSPF external type 1,
 E2 - OSPF external type 2, * - candidate default,
 + - summary route, > - non-active route
Gateway of last resort is not set
 Destination Gateway Dist/Metric Last Change

 C 41.0.0.0/24 via 41.0.0.1 ethernet1/1/7 0/0 02:45:16
 C 3.0.0.0/24 via 3.0.0.2 vlan256 0/0 01:04:52
=====
```

## View VRF instance information

To display information about a VRF configuration, use the `show ip vrf` command. To display information about all VRF instances including the default VRF 0, do not enter a value for `vrf-name`.

- Display the VRF instance interfaces.

```
EXEC
```

```
show ip vrf [vrf-name]
```

## Static route leaking

Route leaking enables routes that are configured in a default or non-default VRF instance to be made available to another VRF instance. You can leak routes from a source VRF instance to a destination VRF instance.

The routes need to be leaked in both source and destination VRFs to achieve end-to-end traffic flow.

If there are any connected routes in the same subnet as statically leaked routes, then the connected routes take precedence.

In static route leaking, DHCP functionality does not work for overlapping subnets. For example, if two interfaces on different VRFs are on the same subnet and are configured with the same DHCP server, then only one of those interfaces gets an IP address. The other interface does not get an IP address because the client requests from the two interfaces have the same MAC and subnet addresses. The server does not have any unique parameter to differentiate that the request is from two different clients.

### Limitations

- In VLT scenarios, the resolved ARP entry for the leaked route is not synchronized between the VLT peers. The ARP entry resolved in the source VRF is programmed into the leaked VRF when the leaked route configuration is active.
- During downgrade from 10.4.2, the leaked route configuration is restored. However, the routes remain inactive in the destination VRF instance.
- During downgrade from 10.4.2, the `update-source-ip` command is not restored.

## Configuring static route leaking

To configure static route leaking:

1. Enter the interface in the source VRF instance that contains the static routes that you want to leak.  
`interface interface-name`  
CONFIGURATION Mode
2. In INTERFACE CONFIGURATION Mode, assign the interface to the source VRF instance.  
`ip vrf forwarding vrf1`  
INTERFACE CONFIGURATION Mode
3. Assign an IP address to the interface.  
`ip address ip-address`  
VRF CONFIGURATION Mode
4. Enter the interface of the VRF instance to which you want to leak the static routes.  
`interface interface-name`  
CONFIGURATION Mode
5. In INTERFACE CONFIGURATION Mode, assign the interface to the destination VRF instance.  
`ip vrf forwarding vrf2`  
INTERFACE CONFIGURATION Mode
6. Configure the static route that you want to leak on the destination VRF instance.  
`ip route vrf dest-vrf-name route nexthop-interface`
7. Configure the static route that you have configured earlier in the source VRF instance to be available in the destination VRF instance also.  
`ip route vrf src-vrf-name route nexthop-interface`

```
OS10(config)#interface ethernet 1/1/1
OS10(conf-if-eth1/1/1)# ip vrf forwarding VRF1
OS10(conf-if-eth1/1/1)# ip address 120.0.0.1/24
OS10(config)#interface ethernet 1/1/2
OS10(conf-if-eth1/1/1)# ip vrf forwarding VRF2
OS10(conf-if-eth1/1/1)# ip address 140.0.0.1/24
OS10(config)#ip route vrf VRF1 140.0.0.0/24 interface ethernet 1/1/2
OS10(config)#ip route vrf VRF2 120.0.0.0/24 interface ethernet 1/1/1
```

The following example shows the show output:

```

OS10(config)# do show ip route vrf VRF1
Codes: C - connected
S - static
B - BGP, IN - internal BGP, EX - external BGP
O - OSPF, IA - OSPF inter area, N1 - OSPF NSSA external type 1,
N2 - OSPF NSSA external type 2, E1 - OSPF external type 1,
E2 - OSPF external type 2, * - candidate default,
+ - summary route, > - non-active route
Gateway of last resort is not set
Destination Gateway Dist/Metric Last Change

C 120.0.0.0/24 via 120.0.0.1 ethernet1/1/1 0/0 00:00:57
S 140.0.0.0/24 Direct,VRF2 ethernet1/1/2 1/0 00:00:04

OS10(config)# do show ip route vrf VRF2
Codes: C - connected
S - static
B - BGP, IN - internal BGP, EX - external BGP
O - OSPF, IA - OSPF inter area, N1 - OSPF NSSA external type 1,
N2 - OSPF NSSA external type 2, E1 - OSPF external type 1,
E2 - OSPF external type 2, * - candidate default,
+ - summary route, > - non-active route
Gateway of last resort is not set
Destination Gateway Dist/Metric Last Change

S 120.0.0.0/24 Direct,VRF1 ethernet1/1/1 1/0 00:00:05
C 140.0.0.0/24 via 140.0.0.1 ethernet1/1/2 0/0 00:01:54

```

## Configuring source IP address for a leaked route

If the source IP is not mentioned explicitly for any self-originating packet (for example, ping or traceroute) to the leaked route destined through the parent VRF, the system chooses a source based on its source selection algorithm.

 **NOTE:** For end-to-end traffic to flow, you must specify the source for self-originating packets and leak the same into the destination VRF.

To mitigate this issue and have control over the source IP address for leaked routes, you can create a loopback interface and associate it with the leaked VRF.

To explicitly mention the source interface for the leaked VRF:

Enter the following command:

```
update-source-ip
```

VRF CONFIGURATION Mode

After you configure the source IP address in a leaked VRF, if ping is initiated without -l option, then the source IP address will be that of the loopback interface.

## Route leaking using route targets

You can leak routes in one VRF instance to another using route targets.

 **NOTE:** You can leak routes using route targets only on the default and non-default VRF instance. You cannot leak routes using route targets on the management VRF instance.

To leak routes in one VRF instance using route targets:

1. Enter the VRF from which you want to leak routes using route targets.  
CONFIGURATION  
`ip vrf source-vrf-name`
2. Export the route that belongs to one VRF instance.  
VRF CONFIGURATION  
`ip route-export 1:1`
3. Enter the non-default VRF instance to which you want to leak the route.

## CONFIGURATION

```
ip vrf destination-vrf-name
ip route-import 1:1
```

The routes that you exported from the source VRF instance are now available in the destination VRF instance.

## Route leaking using route maps

You can leak routes in one VRF instance to another VRF instance using route maps.

To leak routes in one VRF instance using route maps:

1. Enter the VRF from which you want to leak routes using route targets.

### CONFIGURATION

```
ip vrf source-vrf-name
```

```
ip vrf VRF-A
```

2. Configure the IP prefix.

### CONFIGURATION

```
ip prefix-list prefix-list-name {permit | deny} ip-address
```

```
ip prefix-list abc permit 20.0.0.0/24
or
ip prefix-list abc deny 20.0.0.0/24
```

3. Configure the route-map.

### CONFIGURATION

```
route-map route-map-name
```

```
route-map xyz
```

4. Associate the prefix list to the route-map.

### CONFIGURATION

```
route-map route-map-name {permit | deny} rule
match ip address prefix-list prefix-list-name
```

```
route-map xyz permit 10
match ip address prefix-list abc
or
route-map xyz deny 10
match ip address prefix-list abc
```

5. Export the routes from a VRF instance using route maps.

### VRF CONFIGURATION

```
ip route-export route-target route-map-name route-map-name
```

```
ip route-export 1:1 route-map xyz
```

6. Enter the destination VRF instance into which you want to leak the routes using route maps.

### CONFIGURATION

```
ip vrf destination-vrf-name
```

```
ip vrf VRF-B
```

7. Import these leaked routes into another VRF instance.

### VRF CONFIGURATION

```
ip route-import route-target
```

```
ip route-import 1:1
```

```
OS10(config)#interface ethernet 1/1/1
OS10(conf-if-eth1/1/1)# ip vrf forwarding VRF1
OS10(conf-if-eth1/1/1)# ip address 120.0.0.1/24

OS10(config)#interface ethernet 1/1/2
OS10(conf-if-eth1/1/2)# ip vrf forwarding VRF2
OS10(conf-if-eth1/1/2)# ip address 140.0.0.1/24
OS10(config)#ip route vrf VRF1 160.0.0.0/24 120.0.0.2
OS10(config)# ip vrf VRF1
OS10(conf-vrf)# ip route-export 1:1
OS10(config)# ip vrf VRF2
OS10(conf-vrf)# ip route-import 1:1
```

## Example: Route leaking between VRFs with asymmetric IRB routing

With asymmetric IRB routing, the virtual networks that you configure are present in all the VXLAN tunnel endpoints (VTEPs). If the DHCP server and client reside in different VRFs within the same or different VTEPs, request from the client does not reach the server.

In this scenario, the server network must be leaked to the client VRF for the client request to reach the server. The client network must be leaked to the server VRF for the server reply to reach the client.

In this example, the DHCP client is connected to GREEN VRF in VTEP1 and the server is connected to RED VRF in VTEP 2. The client is not able to reach the server. The client and server connected networks from the GREEN and RED VRFs must be leaked to the other tenant VRFs respectively. Route leaking enables server connectivity for hosts connected to different VRFs.

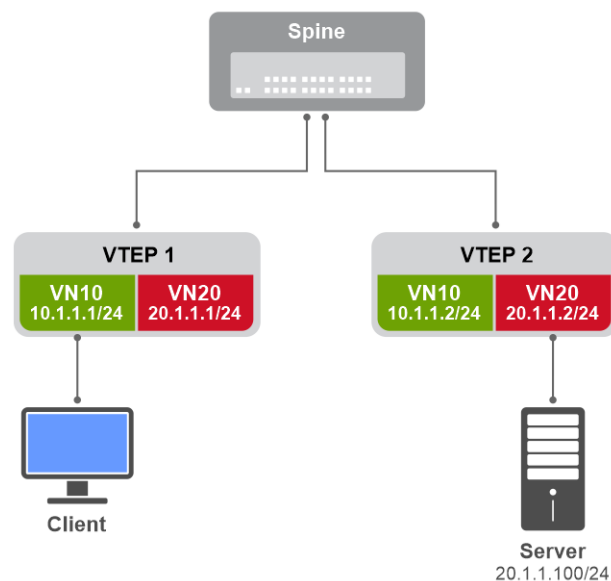

**Figure 8. Route leaking between VRFs with asymmetric IRB routing**

For VXLAN-related configurations, see [Configure VXLAN](#). To configure route leaking between VRFs with asymmetric IRB routing:

### VTEP1

1. Configure IP helper address specifying the DHCP server ip address in the client-connected virtual networks with the client-connected VRF name. For IPv6 DHCP helper address, specify the server VRF in the `helper-address` command.

```
VTEP1(config)# interface virtual-network 10
VTEP1(conf-if-vn-10)# ip helper-address 20.1.1.100 vrf GREEN
```

2. Configure loopback interfaces. Assign the loopback interfaces as source interfaces for the VRF.

```
VTEP1(config)# interface loopback 2
VTEP1(conf-if-lo-2)# ip vrf forwarding GREEN
VTEP1(conf-if-lo-2)# ip address 51.1.1.1/32
VTEP1(conf-if-lo-2)# exit

VTEP1(config)# interface loopback 3
VTEP1(conf-if-lo-3)# ip vrf forwarding RED
VTEP1(conf-if-lo-3)# ip address 52.1.1.1/32
VTEP1(conf-if-lo-3)# exit

VTEP1(config)# ip vrf GREEN
VTEP1(conf-vrf)# update-source-ip loopback 2
VTEP1(conf-vrf)# exit

VTEP1(config)# ip vrf RED
VTEP1(conf-vrf)# update-source-ip loopback 3
VTEP1(conf-vrf)# exit
```

3. Leak the server-connected networks to the tenant VRF to which the client is connected.

```
VTEP1(config)# ip route vrf GREEN 20.1.1.0/24 interface virtual-network 20
VTEP1(config)# ip route vrf GREEN 52.1.1.1/32 interface loopback 3
```

4. Leak the client-connected networks to the tenant VRF to which the server is connected.

```
VTEP1(config)# ip route vrf RED 10.1.1.0/24 interface virtual-network 10
VTEP1(config)# ip route vrf RED 51.1.1.1/32 interface loopback 2
```

## VTEP2

1. Configure IP helper address specifying the DHCP server ip address in the client-connected virtual networks with the client-connected VRF name. For IPv6 DHCP helper address, specify the server VRF in the helper-address command.

```
VTEP2(config)# interface virtual-network 10
VTEP2(conf-if-vn-10)# ip helper-address 20.1.1.100 vrf GREEN
```

2. Configure loopback interfaces. Assign the loopback interfaces as source interfaces for the VRF.

```
VTEP2(config)# interface loopback 2
VTEP2(conf-if-lo-2)# ip vrf forwarding GREEN
VTEP2(conf-if-lo-2)# ip address 51.1.1.2/32
VTEP2(conf-if-lo-2)# exit

VTEP2(config)# interface loopback 3
VTEP2(conf-if-lo-3)# ip vrf forwarding RED
VTEP2(conf-if-lo-3)# ip address 52.1.1.2/32
VTEP2(conf-if-lo-3)# exit

VTEP2(config)# ip vrf GREEN
VTEP2(conf-vrf)# update-source-ip loopback 2
VTEP2(conf-vrf)# exit

VTEP2(config)# ip vrf RED
VTEP2(conf-vrf)# update-source-ip loopback 3
VTEP2(conf-vrf)# exit
```

3. Leak the server-connected networks to the tenant VRF to which the client is connected.

```
VTEP2(config)# ip route vrf GREEN 20.1.1.0/24 interface virtual-network 20
VTEP2(config)# ip route vrf GREEN 52.1.1.2/32 interface loopback 3
```

4. Leak the client-connected networks to the tenant VRF to which the server is connected.

```
VTEP2(config)# ip route vrf RED 10.1.1.0/24 interface virtual-network 10
VTEP2(config)# ip route vrf RED 51.1.1.2/32 interface loopback 2
```

## Example: Route leaking between VRFs with symmetric IRB routing

With symmetric IRB routing, the virtual networks to which the hosts are connected might be disjoint or stretched virtual networks. A disjoint virtual network does not span across VTEPs whereas a stretched virtual network spans across VTEPs.

In this example, the virtual networks are disjoint.

- VTEP1 has virtual network 10 configured in tenant VRF GREEN.
- VTEP2 has virtual network 20 configured in tenant VRF RED.
- The client is connected to virtual network 10 in VTEP1.
- The server is connected to virtual network 20 in VTEP2.

In this case, request from the client does not reach the server as they are part of different tenant VRFs. Connected route leaking cannot be configured in VTEP1 because the server-connected network is not present in VTEP1. The server-connected network must be leaked to the client VRF in VTEP2. This leaked route must be advertised as EVPN type-5 route in the client VRF to VTEP1.

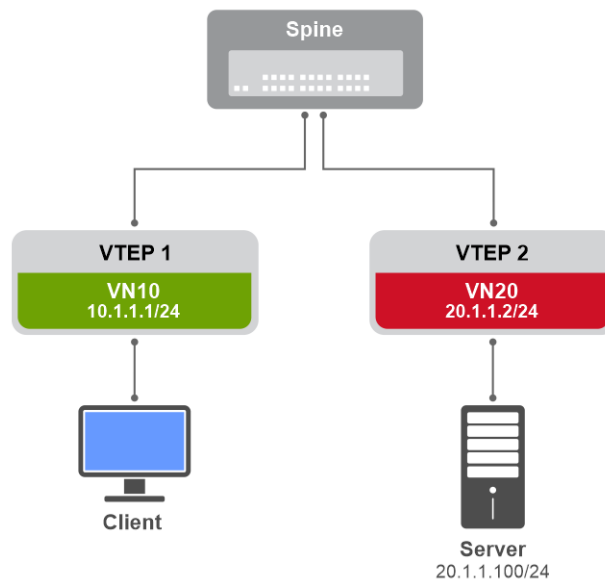

Figure 9. Route leaking between VRFs with symmetric IRB routing

For VXLAN-related configurations, see [Configure VXLAN](#). To configure route leaking between VRFs with symmetric IRB routing:

### VTEP1

1. Configure IP helper address specifying the DHCP server ip address in the client-connected virtual networks with the client-connected VRF name. For IPv6 DHCP helper address, specify the server VRF in the `helper-address` command.

```
VTEP1(config)# interface virtual-network 10
VTEP1(conf-if-vn-10)# ip helper-address 20.1.1.100 vrf GREEN
VTEP1(conf-if-vn-10)# exit
```

2. Configure loopback interfaces. Assign the loopback interfaces as source interfaces for the VRF.

```
VTEP1(config)# interface loopback 2
VTEP1(conf-if-lo-2)# ip vrf forwarding GREEN
VTEP1(conf-if-lo-2)# ip address 51.1.1.1/32
VTEP1(conf-if-lo-2)# exit

VTEP1(config)# interface loopback 3
VTEP1(conf-if-lo-3)# ip vrf forwarding RED
VTEP1(conf-if-lo-3)# ip address 52.1.1.1/32
VTEP1(conf-if-lo-3)# exit

VTEP1(config)# ip vrf GREEN
VTEP1(conf-vrf)# update-source-ip loopback 2
VTEP1(conf-vrf)# exit
```

```
VTEP1(config)# ip vrf RED
VTEP1(conf-vrf)# update-source-ip loopback 3
VTEP1(conf-vrf)# exit
```

3. Leak the client-connected networks to the tenant VRF to which the client is connected.

```
VTEP1(config)# ip route vrf RED 10.1.1.0/24 interface virtual-network 10
VTEP1(config)# ip route vrf RED 51.1.1.2/32 interface loopback 2
```

4. Advertise the client network-leaked routes through EVPN type-5 routes to the server-connected VRF.

```
VTEP1(config)# evpn
VTEP1(config-evpn)# vrf RED
VTEP1(config-evpn-vrf-RED)# advertise ipv4 static
VTEP1(config-evpn-vrf-RED)# advertise ipv4 connected
VTEP1(config-evpn-vrf-RED)# exit
VTEP1(config-evpn)# exit
```

## VTEP2

1. Configure IP helper address specifying the DHCP server ip address in the client-connected virtual networks with the client-connected VRF name. For IPv6 DHCP helper address, specify the server VRF in the helper-address command.

```
VTEP2(config)# interface virtual-network 10
VTEP2(conf-if-vn-10)# ip helper-address 20.1.1.100 vrf GREEN
```

2. Configure loopback interfaces. Assign the loopback interfaces as source interfaces for the VRF.

```
VTEP2(config)# interface loopback 2
VTEP2(conf-if-lo-2)# ip vrf forwarding GREEN
VTEP2(conf-if-lo-2)# ip address 51.1.1.1/32
VTEP2(conf-if-lo-2)# exit
```

```
VTEP2(config)# interface loopback 3
VTEP2(conf-if-lo-3)# ip vrf forwarding RED
VTEP2(conf-if-lo-3)# ip address 52.1.1.1/32
VTEP2(conf-if-lo-3)# exit
```

```
VTEP2(config)# ip vrf GREEN
VTEP2(conf-vrf)# update-source-ip loopback 2
VTEP2(conf-vrf)# exit
```

```
VTEP2(config)# ip vrf RED
VTEP2(conf-vrf)# update-source-ip loopback 3
VTEP2(conf-vrf)# exit
```

3. Leak the server-connected networks to the tenant VRF to which the client is connected.

```
VTEP2(config)# ip route vrf GREEN 20.1.1.0/24 interface virtual-network 20
VTEP2(config)# ip route vrf GREEN 52.1.1.2/32 interface loopback 3
```

4. Advertise the client network-leaked routes through EVPN type-5 routes to the client-connected VRF.

```
VTEP2(config)# evpn
VTEP2(config-evpn)# vrf GREEN
VTEP2(config-evpn-vrf-GREEN)# advertise ipv4 static
VTEP2(config-evpn-vrf-GREEN)# advertise ipv4 connected
VTEP2(config-evpn-vrf-GREEN)# exit
VTEP2(config-evpn)# exit
```



# VRF commands

## interface management

Adds a management interface to the management VRF instance.

|                           |                                                                                                                |
|---------------------------|----------------------------------------------------------------------------------------------------------------|
| <b>Syntax</b>             | <code>interface management</code>                                                                              |
| <b>Parameters</b>         | None                                                                                                           |
| <b>Default</b>            | Not configured                                                                                                 |
| <b>Command Mode</b>       | VRF CONFIGURATION                                                                                              |
| <b>Usage Information</b>  | The <code>no</code> version of this command removes the management interface from the management VRF instance. |
| <b>Example</b>            | <pre>OS10(config)# ip vrf management OS10(conf-vrf)# interface management</pre>                                |
| <b>Supported Releases</b> | 10.4.0E(R1) or later                                                                                           |

## ip domain-list vrf

Configures a domain list for the management VRF instance or any non-default VRF instance that you create.

|                           |                                                                                                                                                                                                                                                                                                                                                                                                  |
|---------------------------|--------------------------------------------------------------------------------------------------------------------------------------------------------------------------------------------------------------------------------------------------------------------------------------------------------------------------------------------------------------------------------------------------|
| <b>Syntax</b>             | <code>ip domain-list vrf {management   vrf-name} domain-names</code>                                                                                                                                                                                                                                                                                                                             |
| <b>Parameters</b>         | <ul style="list-style-type: none"><li>• <code>management</code>—Enter the keyword <code>management</code> to configure a domain list for the management VRF instance.</li><li>• <code>vrf-name</code>—Enter the name of the non-default VRF instance to configure a domain list for that non-default VRF instance.</li><li>• <code>domain-names</code>—Enter the list of domain names.</li></ul> |
| <b>Default</b>            | Not configured                                                                                                                                                                                                                                                                                                                                                                                   |
| <b>Command Mode</b>       | CONFIGURATION                                                                                                                                                                                                                                                                                                                                                                                    |
| <b>Usage Information</b>  | The <code>no</code> version of this command removes the domain list configuration from the management or the non-default VRF instance.                                                                                                                                                                                                                                                           |
| <b>Example</b>            | <pre>OS10(config)# ip domain-list vrf management dns1 dell.com or OS10(config)# ip domain-list vrf blue dns1 dell.com</pre>                                                                                                                                                                                                                                                                      |
| <b>Supported Releases</b> | 10.4.0E(R1) or later                                                                                                                                                                                                                                                                                                                                                                             |

## ip domain-name vrf

Configures a domain name for the management VRF instance or any non-default VRF instance that you create.

|                   |                                                                                                                                                                                                                                                                                                                                                                            |
|-------------------|----------------------------------------------------------------------------------------------------------------------------------------------------------------------------------------------------------------------------------------------------------------------------------------------------------------------------------------------------------------------------|
| <b>Syntax</b>     | <code>ip domain-name vrf {management   vrf-name} domain-name</code>                                                                                                                                                                                                                                                                                                        |
| <b>Parameters</b> | <ul style="list-style-type: none"><li>• <code>management</code>—Enter the keyword <code>management</code> to configure a domain name for the management VRF instance.</li><li>• <code>vrf-name</code>—Enter the name of the non-default VRF instance to configure a domain name for that VRF instance.</li><li>• <code>domain-name</code>—Enter the domain name.</li></ul> |
| <b>Default</b>    | Not configured                                                                                                                                                                                                                                                                                                                                                             |

|                           |                                                                                                                      |
|---------------------------|----------------------------------------------------------------------------------------------------------------------|
| <b>Command Mode</b>       | CONFIGURATION                                                                                                        |
| <b>Usage Information</b>  | The <code>no</code> version of this command removes the domain name from the management or non-default VRF instance. |
| <b>Example</b>            | <pre>OS10(config)# ip domain-name vrf management dell.com or OS10(config)# ip domain-name vrf blue dell.com</pre>    |
| <b>Supported Releases</b> | 10.4.0E(R1) or later                                                                                                 |

## ip vrf

Create a non-default VRF instance.

|                           |                                                                                                                                                                                                                                                                                                         |
|---------------------------|---------------------------------------------------------------------------------------------------------------------------------------------------------------------------------------------------------------------------------------------------------------------------------------------------------|
| <b>Syntax</b>             | <code>ip vrf vrf-name</code>                                                                                                                                                                                                                                                                            |
| <b>Parameters</b>         | <ul style="list-style-type: none"> <li>• <code>vrf-name</code>—Enter the name of the non-default VRF that you want to create. Enter a VRF name that is not greater than 32 characters in length.</li> </ul>                                                                                             |
| <b>Default</b>            | Not configured                                                                                                                                                                                                                                                                                          |
| <b>Command Mode</b>       | CONFIGURATION                                                                                                                                                                                                                                                                                           |
| <b>Usage Information</b>  | Enter the <code>ip vrf vrf-name</code> command only in non-transaction-based configuration mode. Do not use transaction-based mode. You can create up to a maximum of 128 non-default VRF instances. The <code>no ip vrf vrf-name</code> command removes the non-default VRF instance that you specify. |
| <b>Example</b>            | <pre>OS10(config)# ip vrf vrf-test OS10(conf-vrf-test)#</pre>                                                                                                                                                                                                                                           |
| <b>Supported Releases</b> | 10.4.1.0 or later                                                                                                                                                                                                                                                                                       |

## ip ftp vrf

Configures an FTP client for the management or non-default VRF instance.

|                           |                                                                                                                                                                                                                                                                                                           |
|---------------------------|-----------------------------------------------------------------------------------------------------------------------------------------------------------------------------------------------------------------------------------------------------------------------------------------------------------|
| <b>Syntax</b>             | <code>ip ftp vrf {management   vrf vrf-name}</code>                                                                                                                                                                                                                                                       |
| <b>Parameters</b>         | <ul style="list-style-type: none"> <li>• <code>management</code> — Enter the keyword to configure an FTP client on the management VRF instance.</li> <li>• <code>vrf vrf-name</code> — Enter the keyword then the name of the VRF to configure an FTP client on that non-default VRF instance.</li> </ul> |
| <b>Default</b>            | Not configured                                                                                                                                                                                                                                                                                            |
| <b>Command Mode</b>       | CONFIGURATION                                                                                                                                                                                                                                                                                             |
| <b>Usage Information</b>  | The <code>no</code> version of this command removes the management VRF instance configuration from the FTP client.                                                                                                                                                                                        |
| <b>Example</b>            | <pre>OS10(config)# ip ftp vrf management OS10(config)# ip ftp vrf vrf-blue</pre>                                                                                                                                                                                                                          |
| <b>Supported Releases</b> | 10.4.0E(R1) or later                                                                                                                                                                                                                                                                                      |

## ip host vrf

Configures a hostname for the management VRF instance or a non-default VRF instance and maps the hostname to an IPv4 or IPv6 address.

|                           |                                                                                                                                                                                                                                                                                                                                                                                                                                                      |
|---------------------------|------------------------------------------------------------------------------------------------------------------------------------------------------------------------------------------------------------------------------------------------------------------------------------------------------------------------------------------------------------------------------------------------------------------------------------------------------|
| <b>Syntax</b>             | <code>ip host vrf {management   vrf-name} hostname {IP-address   Ipv6-address}</code>                                                                                                                                                                                                                                                                                                                                                                |
| <b>Parameters</b>         | <ul style="list-style-type: none"><li>• <code>management</code>—Enter the keyword <code>management</code> to configure a hostname for the management VRF instance.</li><li>• <code>vrf-name</code>—Enter the name of the non-default VRF instance to configure a hostname for that VRF instance.</li><li>• <code>hostname</code>—Enter the hostname.</li><li>• <code>IP-address   Ipv6-address</code>—Enter the host IPv4 or IPv6 address.</li></ul> |
| <b>Default</b>            | Not configured                                                                                                                                                                                                                                                                                                                                                                                                                                       |
| <b>Command Mode</b>       | CONFIGURATION                                                                                                                                                                                                                                                                                                                                                                                                                                        |
| <b>Usage Information</b>  | The <code>no</code> version of this command removes the hostname from the management or non-default VRF instance.                                                                                                                                                                                                                                                                                                                                    |
| <b>Example</b>            | <pre>OS10(config)# ip host vrf management dell 10.1.1.1 or OS10(config)# ip host vrf blue dell 10.1.1.1</pre>                                                                                                                                                                                                                                                                                                                                        |
| <b>Supported Releases</b> | 10.4.0E(R1) or later                                                                                                                                                                                                                                                                                                                                                                                                                                 |

## ip http vrf

Configures an HTTP client for the management or non-default VRF instance.

|                           |                                                                                                                                                                                                                                                                                                            |
|---------------------------|------------------------------------------------------------------------------------------------------------------------------------------------------------------------------------------------------------------------------------------------------------------------------------------------------------|
| <b>Syntax</b>             | <code>ip http vrf {management   vrf vrf-name}</code>                                                                                                                                                                                                                                                       |
| <b>Parameters</b>         | <ul style="list-style-type: none"><li>• <code>management</code> — Enter the keyword to configure an HTTP client for the management VRF instance.</li><li>• <code>vrf vrf-name</code> — Enter the keyword then the name of the VRF to configure an HTTP client for that non-default VRF instance.</li></ul> |
| <b>Default</b>            | Not configured                                                                                                                                                                                                                                                                                             |
| <b>Command Mode</b>       | CONFIGURATION                                                                                                                                                                                                                                                                                              |
| <b>Usage Information</b>  | The <code>no</code> version of this command removes the management VRF instance configuration from the HTTP client.                                                                                                                                                                                        |
| <b>Example</b>            | <pre>OS10(config)# ip http vrf management OS10(config)# ip http vrf vrf-blue</pre>                                                                                                                                                                                                                         |
| <b>Supported Releases</b> | 10.4.0E(R1) or later                                                                                                                                                                                                                                                                                       |

## ip name-server vrf

Configures a DNS name server for the management VRF instance or a non-default VRF instance.

|                   |                                                                                                                                                                                                                                                                                                                          |
|-------------------|--------------------------------------------------------------------------------------------------------------------------------------------------------------------------------------------------------------------------------------------------------------------------------------------------------------------------|
| <b>Syntax</b>     | <code>ip name-server vrf {management   vrf-name}</code>                                                                                                                                                                                                                                                                  |
| <b>Parameters</b> | <ul style="list-style-type: none"><li>• <code>management</code>—Enter the keyword <code>management</code> to configure a DNS name server for the management VRF instance.</li><li>• <code>vrf-name</code>—Enter the name of the non-default VRF instance to configure a DNS name server for that VRF instance.</li></ul> |
| <b>Default</b>    | Not configured                                                                                                                                                                                                                                                                                                           |

|                           |                                                                                                                      |
|---------------------------|----------------------------------------------------------------------------------------------------------------------|
| <b>Command Mode</b>       | CONFIGURATION                                                                                                        |
| <b>Usage Information</b>  | The <code>no</code> version of this command removes the name server from the management or non-default VRF instance. |
| <b>Example</b>            | <pre>OS10(config)# ip name-server vrf management or OS10(config)# ip name-server vrf blue</pre>                      |
| <b>Supported Releases</b> | 10.4.0E(R1) or later                                                                                                 |

## ip route-import

Imports an IPv4 route into a VRF instance from another VRF instance.

|                           |                                                                                                                                                                                                                                                                            |
|---------------------------|----------------------------------------------------------------------------------------------------------------------------------------------------------------------------------------------------------------------------------------------------------------------------|
| <b>Syntax</b>             | <code>[no] ip route-import route-target</code>                                                                                                                                                                                                                             |
| <b>Parameters</b>         | <ul style="list-style-type: none"> <li><code>route-target</code>—Enter the <code>route-target</code> of the nondefault VRF instance, from 1 to 65535.</li> </ul>                                                                                                           |
| <b>Default</b>            | Not configured                                                                                                                                                                                                                                                             |
| <b>Command Mode</b>       | VRF CONFIG                                                                                                                                                                                                                                                                 |
| <b>Usage Information</b>  | <p>You can import routes corresponding only to a nondefault or a default VRF instance. You cannot import routes that belong to a management VRF instance into another VRF instance.</p> <p>Use the <code>no</code> form of this command to remove the imported routes.</p> |
| <b>Example</b>            | <pre>OS10(conf-vrf)# ip route-import 1:1 ==&gt; No route-map attached</pre>                                                                                                                                                                                                |
| <b>Supported Releases</b> | 10.4.3.0 or later                                                                                                                                                                                                                                                          |

## ip route-export

Exports an IPv4 route from one VRF instance to another.

|                           |                                                                                                                                                                                                                                                   |
|---------------------------|---------------------------------------------------------------------------------------------------------------------------------------------------------------------------------------------------------------------------------------------------|
| <b>Syntax</b>             | <code>[no] ip route-export route-target [route-map route-map-name]</code>                                                                                                                                                                         |
| <b>Parameters</b>         | <ul style="list-style-type: none"> <li><code>route-target</code>—Enter the <code>route-target</code> of the VRF instance.</li> <li><code>route-map route-map-name</code>—(Optional) Enter the route-map name to specify the route-map.</li> </ul> |
| <b>Default</b>            | Not configured                                                                                                                                                                                                                                    |
| <b>Command Mode</b>       | VRF CONFIG                                                                                                                                                                                                                                        |
| <b>Usage Information</b>  | <p>You can export routes corresponding only to a nondefault or a default VRF instance. You cannot export routes that belong to a management VRF instance.</p> <p>Use the <code>no</code> form of this command to undo the configuration.</p>      |
| <b>Example</b>            | <pre>OS10(config-vrf)# ip route-export 1:1 ==&gt; No route-map attached OS10(config-vrf)# ip route-export 1:1 route-map abc ==&gt; Route-map abc attached to filter export routes</pre>                                                           |
| <b>Supported Releases</b> | 10.4.3.0 or later                                                                                                                                                                                                                                 |

## ipv6 route-import

Imports an IPv6 route into a VRF instance from another VRF instance.

**Syntax** [no] ipv6 route-import route-target

**Parameters**

- *route-target*—Enter the *route-target* of the VRF instance.

**Default** Not configured

**Command Mode** VRF CONFIG

**Usage Information** You can import IPv6 routes corresponding only to a nondefault or a default VRF instance. You cannot import IPv6 routes that belong to a management VRF instance into another VRF instance.

Use the `no` form of this command to remove the imported routes.

### Example

```
OS10(conf-vrf)# ipv6 route-import 1:1 ==> No route-map attached
```

**Supported Releases** 10.4.3.0 or later

## ipv6 route-export

Exports an IPv6 route from a VRF instance to another VRF instance.

**Syntax** [no] ipv6 route-export route-target [route-map route-map-name]

**Parameters**

- *route-target*—Enter the *route-target* of the VRF instance.
- *route-map route-map-name*—(Optional) Enter the route-map name to specify the route-map.

**Default** Not configured

**Command Mode** VRF CONFIG

**Usage Information** You can export IPv6 routes corresponding only to a nondefault or a default VRF instance. You cannot export IPv6 routes that belong to a management VRF instance into another VRF instance.

Use the `no` form of this command to undo the configuration.

### Example

```
OS10(conf-vrf)# ipv6 route-export 1:1 ==> No route-map attached
OS10(conf-vrf)# ipv6 route-export 1:1 route-map abc ==> Route-map abc
attached to filter export routes
```

**Supported Releases** 10.4.3.0 or later

## ip scp vrf

Configures an SCP connection for the management or non-default VRF instance.

**Syntax** ip scp vrf {management | vrf vrf-name}

**Parameters**

- *management* — Enter the keyword to configure an SCP connection for the management VRF instance.
- *vrf vrf-name* — Enter the keyword then the name of the VRF to configure an SCP connection for that VRF instance.

**Default** Not configured

**Command Mode** CONFIGURATION

**Usage Information** The `no` version of this command removes the management VRF instance configuration from the SCP client.

**Example**

```
OS10(config)# ip scp vrf management
OS10(config)# ip scp vrf vrf-blue
```

**Supported Releases**

10.4.0E(R1) or later

## ip sftp vrf

Configures an SFTP client for the management or non-default VRF instance.

**Syntax** `ip sftp vrf {management | vrf vrf-name}`

**Parameters**

- `management` — Enter the keyword to configure an SFTP client for a management VRF instance.
- `vrf vrf-name` — Enter the keyword then the name of the VRF to configure an SFTP client for that non-default VRF instance.

**Default** Not configured

**Command Mode** CONFIGURATION

**Usage Information** The `no` version of this command removes the management VRF instance configuration from the SFTP client.

**Example**

```
OS10(config)# ip sftp vrf management
OS10(config)# ip sftp vrf vrf-blue
```

**Supported Releases**

10.4.0E(R1) or later

## ip tftp vrf

Configures a TFTP client for the management or non-default VRF instance.

**Syntax** `ip tftp vrf {management | vrf vrf-name}`

**Parameters**

- `management` — Enter the keyword to configure a TFTP client for the management VRF instance.
- `vrf vrf-name` — Enter the keyword then the name of the VRF to configure a TFTP client for that non-default VRF instance.

**Default** Not configured

**Command Mode** CONFIGURATION

**Usage Information** The `no` version of this command removes the management VRF instance configuration from the TFTP client.

**Example**

```
OS10(config)# ip tftp vrf management
OS10(config)# ip tftp vrf vrf-blue
```

**Supported Releases**

10.4.0E(R1) or later

## ip vrf management

Configures the management VRF instance.

**Syntax** `ip vrf management`

**Parameters** None

**Default** Not configured

**Command Mode** CONFIGURATION

**Usage Information** Enter the `ip vrf management` command only in non-transaction-based configuration mode. Do not use transaction-based mode. The `no` version of this command removes the management VRF instance configuration.

**Example**

```
OS10(config)# ip vrf management
OS10(conf-vrf)#
```

**Supported Releases** 10.4.0E(R1) or later

## show hosts vrf

Displays the host table in the management or non-default VRF instance.

**Syntax** `show hosts vrf {management | vrf-name}`

**Parameters**

- `management`—Enter the keyword `management` to display the host table in the management VRF instance.
- `vrf-name`—Enter the name of the non-default VRF instance to display the host table in that VRF instance.

**Default** Not configured

**Command Mode** EXEC

**Usage Information** None

**Example**

```
OS10# show hosts vrf management
Default Domain Name : dell.com
Domain List : abc.com xyz.net
Name Servers : 10.16.126.1
=====
 Static Host to IP mapping Table
=====
Host IP-Address

google.com 172.217.160.142
yahoo.com 98.139.180.180
```

**Supported Releases** 10.4.0E(R1) or later

## show ip vrf

Displays the VRF instance information.

**Syntax** `show ip vrf [management | vrf-name]`

**Parameters**

- `management`—Enter the keyword `management` to display information corresponding to the management VRF instance.
- `vrf-name`—Enter the name of the non-default VRF instance to display information corresponding to that VRF instance.

**Default** Not configured

**Command Mode** EXEC

**Usage Information** None

## Example

```
OS10# show ip vrf
VRF-Name Interfaces
default Mgmt1/1/1
 Eth1/1/1-1/1/2
 Vlan1

management
```

```
OS10# show ip vrf management
VRF-Name Interfaces
management
```

**Supported Releases** 10.4.0E(R1) or later

## update-source-ip

Configures a source IP interface for any leaked route in a VRF instance.

**Syntax** `update-source-ip interface interface-id`  
To undo this configuration, use the `no update-source-ip` command.

**Parameters**

- `interface interface-id` — Enter the loopback interface identifier. The range is from 0 to 16383.

**Default** Not configured

**Command Mode** VRF CONFIGURATION

## Example

```
OS10(conf-vrf) # update-source-ip loopback 1
```

**Supported Releases** 10.4.2E or later.

# Bidirectional Forwarding Detection

The Bidirectional Forwarding Detection (BFD) protocol rapidly detects communication failures between two adjacent routers. BFD replaces link-state detection mechanisms in existing routing protocols. It also provides a failure detection solution for links with no routing protocols.

BFD provides forwarding-path failure detection in milliseconds instead of seconds. Because BFD is independent of routing protocols, it provides consistent network failure detection. BFD eliminates multiple protocol-dependent timers and methods. Networks converge is faster because BFD triggers link-state changes in the routing protocol sooner and more consistently.

BFD is a simple hello mechanism. Two neighboring routers running BFD establish a session using a three-way handshake. After the session is established, the routers exchange periodic control packets at sub-second intervals. If a router does not receive a hello packet within the specified time, routing protocols are notified that the forwarding path is down.

In addition, BFD sends a control packet when there is a state change or change in a session parameter. These control packets are sent without regard to transmit and receive intervals in a routing protocol.

BFD is an independent and generic protocol, which all media, topologies, and routing protocols can support using any encapsulation. OS10 implements BFD at Layer 3 (L3) and with User Datagram Protocol (UDP) encapsulation. BFD is supported on static and dynamic routing protocols, such as VRRP, OSPF, OSPFv3, IS-IS, and BGP.

The system displays BFD state change notifications.

 **NOTE:** BFD is only supported for the border gateway protocol (BGP).

## Configuration notes

All Dell EMC PowerSwitches except MX-Series, S4200-Series, S5200 Series, and Z9332F-ON:



Bidirectional forwarding detection (BFD) is not supported on the S5148F-ON switch.

## BFD session states

To establish a BFD session between two routers, enable BFD on both sides of the link. BFD routers can operate in both active and passive roles.

- The active router starts the BFD session. Both routers can be active in the same session.
- The passive router does not start a session. It only responds to a request for session initialization from the active router.

A BFD session can occur in Asynchronous and Demand modes. However, OS10 BFD supports only Asynchronous mode.

- In Asynchronous mode, both systems send periodic control messages at a specified interval to indicate that their session status is Up.
- In Demand mode, if one router requests Demand mode, the other router stops sending periodic control packets; it only sends a response to status inquiries from the Demand mode initiator. Either peer router, but not both, can request Demand mode at any time.

A BFD session can have four states: Administratively Down, Down, Init, and Up. The default BFD session state is Down.

- Administratively Down — The local BFD router does not participate in the session.
- Down — The remote BFD router is not sending control packets or does not send them within the detection time for the session.
- Init — The local BFD router is communicating to the remote router in the session.
- Up — Both BFD routers are sending control packets.

A BFD session's state changes to Down if:

- A control packet is not received within the detection time.
- Demand mode is active and a control packet is not received in response to a poll packet.

### BFD session state changes example

The session state on a router changes according to the status notification it receives from the peer router. For example, if the current session state is Down and the router receives a Down status notification from the remote router, the session state on the local router changes to Init.

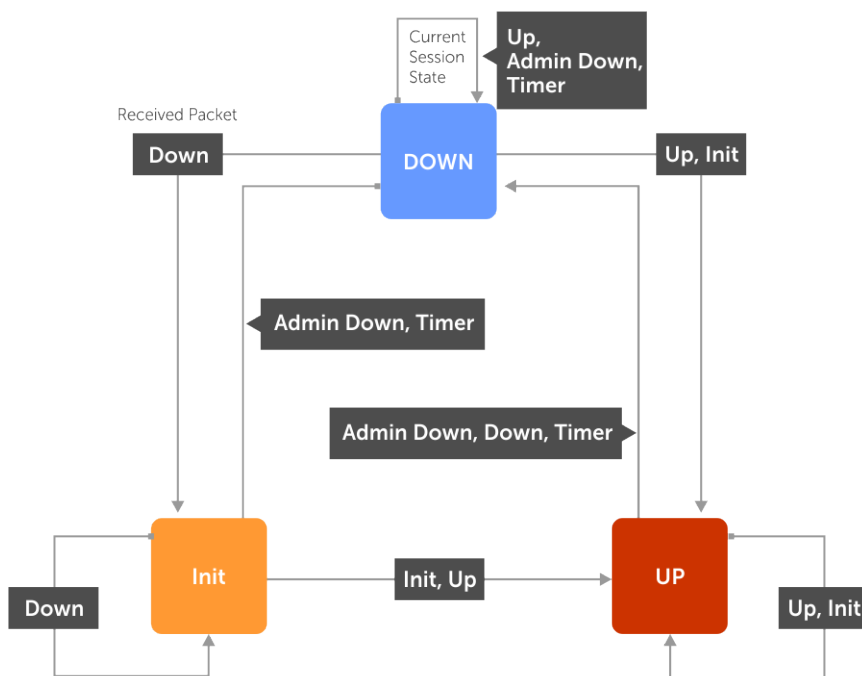

## BFD three-way handshake

A BFD session requires a three-way handshake between neighboring routers. In the following example, the handshake assumes:

- One router is active, and the other router is passive.
  - This is the first session established on this link.
  - The default session state on both ports is `Down`.
1. The active system sends a steady stream of control packets to indicate that its session state is `Down` until the passive system responds. These packets are sent at the desired transmit interval of the Active system. The `Your Discriminator` field is set to zero.
  2. When the passive system receives a control packet, it changes its session state to `Init` and sends a response to indicate its state change. The response includes its session ID in the `My Discriminator` field and the session ID of the remote system in the `Your Discriminator` field.
  3. The active system receives the response from the passive system and changes its session state to `Up`. It then sends a control packet to indicate this state change. Discriminator values exchange, and transmit intervals negotiate.
  4. The passive system receives the control packet and changes its state to `Up`. Both systems agree that a session is established. However, because both members must send a control packet, which requires a response, whenever there is a state change or change in a session parameter, the passive system sends a final response indicating the state change. After this, periodic control packets exchange.

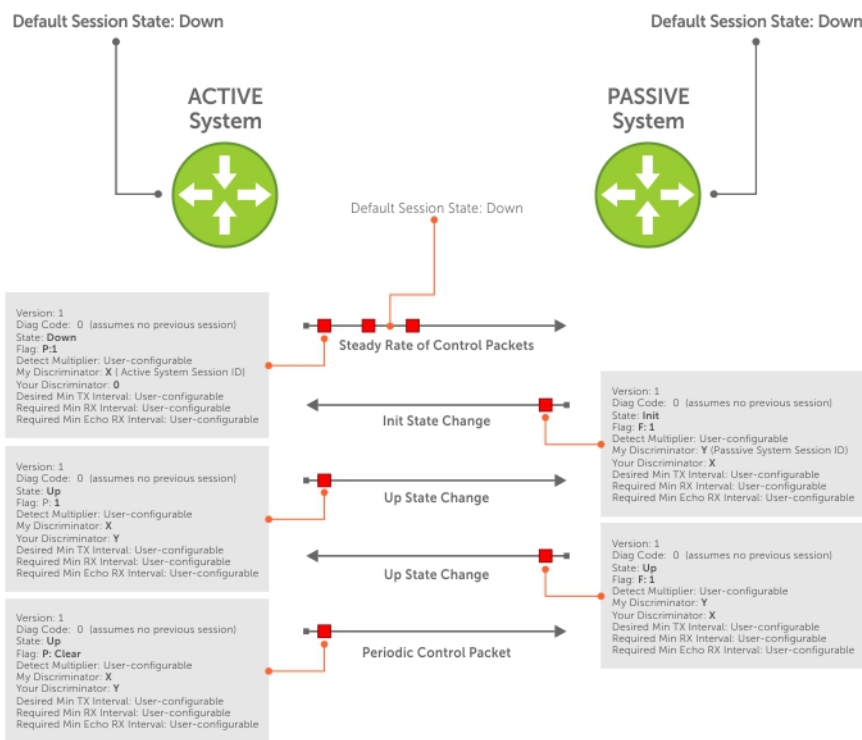

## BFD configuration

Before you configure BFD for a routing protocol, first enable BFD globally on both routers in the link. BFD is disabled by default.

- OS10 does not support Demand mode, authentication, and Echo function.
- OS10 does not support BFD on multi-hop and virtual links.
- OS10 supports protocol liveness only for routing protocols.
- OS10 BFD supports only the BGP routing protocol. For IPv4 and IPv6 BGP, OS10 supports only the default virtual routing and forwarding (VRF).

**NOTE:** Dell EMC recommends that:

- For the S4100-ON series platform, you configure a BFD interval of 500 ms with multiplier of 3 or higher for multidimensional scaled configurations.
- For other series switches, you configure a BFD interval of 200 ms with a multiplier of 4 or higher for multidimensional scaled configurations.

## Configure BFD globally

Before you configure BFD for static routing or a routing protocol, configure BFD globally on each router, including the global BFD session settings. BFD is disabled by default.

1. Configure the global BFD session parameters in CONFIGURATION mode.

```
bfd interval milliseconds min_rx milliseconds multiplier number role {active | passive}
```

- *interval milliseconds* — Enter the time interval for sending control packets to BFD peers, from 50 to 1000. The default is 200. Dell EMC recommends using more than 100 milliseconds.
- *min\_rx milliseconds* — Enter the maximum waiting time for receiving control packets from BFD peers, from 50 to 1000. The default is 200. Dell EMC recommends using more than 100 milliseconds.
- *multiplier number* — Enter the number of consecutive packets that must not be received from a BFD peer before the session state changes to Down, from 3 to 50. The default is 3.
- *role {active | passive}* — Enter *active* if the router initiates BFD sessions. Both BFD peers can be active at the same time. Enter *passive* if the router does not initiate BFD sessions, and only responds to a request from an active BFD to initialize a session. The default is *active*.

2. Enable BFD globally in CONFIGURATION mode.

```
bfd enable
```

To verify that BFD is globally enabled, use the `show running-config bfd` command.

### BFD global configuration

```
OS10(config)# bfd interval 250 min_rx 300 multiplier 4 role passive
OS10(config)# bfd enable
OS10(config)# do show running-config bfd
!
bfd enable
bfd interval 250 min_rx 300 multiplier 4 role passive
```

### View information about active BFD neighbors

```
OS10#show bfd neighbors active
* - Active session role

--
 LocalAddr RemoteAddr Interface State RxInt TxInt Mult VRF
Clients

--
* 100.100.1.1 100.100.1.2 ethernet1/1/26:1 up 200 200 3 red ospfv2
* 100.100.3.1 100.100.3.2 ethernet1/1/26:3 up 200 200 3 default ospfv2
* 200.1.1.2 200.1.1.1 vlan102 up 200 200 3 black bgp
* 200.1.5.2 200.1.5.1 vlan105 up 200 200 3 default ospfv2
* 200.1.11.2 200.1.11.1 vlan111 up 200 200 3 green rtmv4
* 200.1.12.2 200.1.12.1 vlan112 up 200 200 3 default rtmv4
* 201.1.1.2 201.1.1.1 vlan101 up 200 200 3 green ospfv2
```

## BFD for BGP

In a BGP core network, BFD enables faster network reconvergence. BFD rapidly detects communication failures in BGP fast-forwarding paths between internal BGP (iBGP) and external BGP (eBGP) peers. BFD for BGP is supported on physical, port-channel, and VLAN interfaces. BFD for BGP does not support the BGP multihop feature.

Before configuring BFD for BGP, first configure BGP on the interconnecting routers. For more information, see [Border Gateway Protocol](#).

### BFD for BGP example

In this BFD for BGP configuration example, Router 1 and Router 2 use eBGP in a transit network to interconnect AS1 and AS2. The eBGP routers exchange information with each other and with iBGP routers to maintain connectivity and accessibility within each autonomous system.

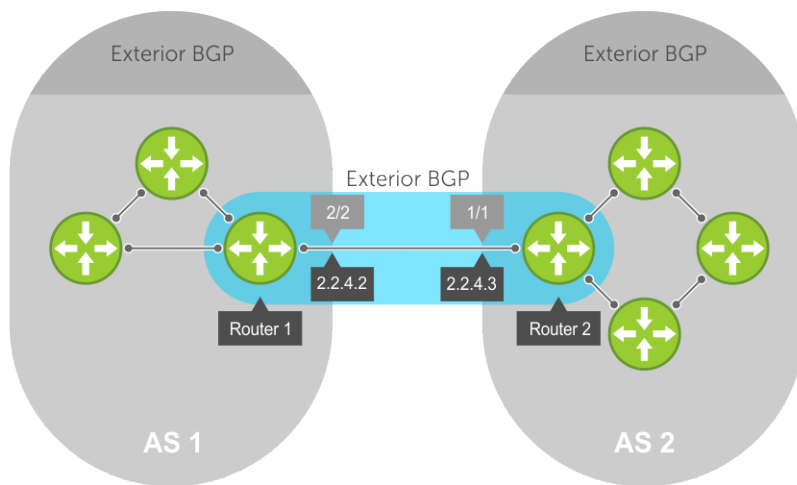

When you configure a BFD session with a BGP neighbor, you can:

- Establish a BFD session with a specified BGP neighbor using the `neighbor ip-address` and `bfd` commands.
- Establish BFD sessions with all neighbors discovered by BGP using the `bfd all-neighbors` command.

For example:

#### Router 1

```
OS10(conf)# bfd enable
OS10(conf)# router bgp 1
OS10(config-router-bgp-1)# neighbor 2.2.4.3
OS10(config-router-neighbor)# bfd
OS10(config-router-neighbor)# no shutdown
OR
OS10(conf)# bfd enable
OS10(conf)# router bgp 1
OS10(config-router-bgp-1)# bfd all-neighbors interval 200 min_rx 200 multiplier 6 role active
```

#### Router 2

```
OS10(conf)# bfd enable
OS10(conf)# router bgp 2
OS10(config-router-bgp-2)# neighbor 2.2.4.2
OS10(config-router-neighbor)# bfd
OS10(config-router-neighbor)# no shutdown
OR
OS10(conf)# bfd enable
OS10(conf)# router bgp 2
```

```
OS10(conf-router-bgp-2)# bfd all-neighbors interval 200 min_rx 200 multiplier 6 role active
```

BFD packets originating from a router are assigned to the highest priority egress queue to minimize transmission delays. Incoming BFD control packets received from the BGP neighbor are assigned to the highest priority queue within the control plane policing (CoPP) framework to avoid BFD packets drops due to queue congestion.

BFD notifies BGP of any failure conditions that it detects on the link. BGP initiates recovery actions.

BFD for BGP is supported only on directly connected BGP neighbors and in both BGP IPv4 and IPV6 networks. A maximum of 100 simultaneous BFD sessions are supported.

If each BFD for BGP neighbor receives a BFD control packet within the configured BFD interval for failure detection, the BFD session remains up and BGP maintains its adjacencies. If a BFD for BGP neighbor does not receive a control packet within the detection interval, the router informs any clients of the BFD session, and other routing protocols, about the failure. It then depends on the routing protocol that uses the BGP link to determine the appropriate response to the failure condition. The normal response is to terminate the peering session for the routing protocol and reconverge by bypassing the failed neighboring router. A log message generates whenever BFD detects a failure condition.

## Configure BFD for BGP

OS10 supports BFD sessions with IPv4 or IPv6 BGP neighbors using the default VRF. When you configure BFD for BGP, you can enable BFD sessions with all BGP neighbors discovered by BGP or with a specified neighbor.

1. Configure BFD session parameters and enable BFD globally on all interfaces in CONFIGURATION mode as described in [Configure BFD globally](#).

```
bfd interval milliseconds min_rx milliseconds multiplier number role {active | passive}
bfd enable
```

2. Enter the AS number of a remote BFD peer in CONFIGURATION mode, from 1 to 65535 for a 2-byte AS number and from 1 to 4294967295 for a 4-byte AS number. Only one AS number is supported per system. If you enter a 4-byte AS number, 4-byte AS support enables automatically.

```
router bgp as-number
```

3. Enter the IP address of a BFD peer in ROUTER-BGP mode. Enable a BFD session and the BGP link in ROUTER-NEIGHBOR mode. The global BFD session parameters configured in Step 1 are used.

```
neighbor ip-address
 bfd
 no shutdown
```

OR

Configure BFD sessions with all neighbors discovered by the BGP in ROUTER-BGP mode. The BFD session parameters you configure override the global session parameters configured in Step 1.

```
bfd all-neighbors [interval milliseconds min_rx milliseconds multiplier number role {active | passive}]
```

- *interval milliseconds* — Enter the time interval for sending control packets to BFD peers, from 100 to 1000; default 200. Dell EMC recommends using more than 100 milliseconds.
- *min\_rx milliseconds* — Enter the maximum waiting time for receiving control packets from BFD peers, from 100 to 1000; default 200. Dell EMC recommends using more than 100 milliseconds.
- *multiplier number* — Enter the maximum number of consecutive packets that are not received from a BFD peer before the session state changes to Down, from 3 to 50; default 3.
- *role {active | passive}* — Enter *active* if the router initiates BFD sessions. Both BFD peers can be active at the same time. Enter *passive* if the router does not initiate BFD sessions, and only responds to a request from an active BFD to initialize a session. The default is *active*.

To ignore the configured `bfd all-neighbors` settings for a specified neighbor, enter the `bfd disable` command in ROUTER-NEIGHBOR mode.

OR

Enter a BGP template with neighborhood name in ROUTER-BGP mode. Configure BFD sessions with all neighbors which inherit the template in ROUTER-TEMPLATE mode. For more information on how to use BGP templates, see [Peer templates](#). The global BFD session parameters configured in Step 1 are used.

```
template template-name
 bfd
 no shutdown
```

4. Verify the BFD for BGP configuration in EXEC mode.

```
show bfd neighbors [detail]
```

#### BFD for BGP all-neighbors configuration

```
OS10(conf)# bfd interval 200 min_rx 200 multiplier 6 role active
OS10(conf)# bfd enable
OS10(conf)# router bgp 4
OS10(config-router-bgp-4)# bfd all-neighbors interval 200 min_rx 200 multiplier 6 role active
```

#### BFD for BGP single-neighbor configuration

```
OS10(conf)# bfd interval 200 min_rx 200 multiplier 6 role active
OS10(conf)# bfd enable
OS10(conf)# router bgp 1
OS10(config-router-bgp-1)# neighbor 150.150.1.1
OS10(config-router-neighbor)# bfd
OS10(config-router-neighbor)# no shutdown
```

#### BFD for BGP template configuration

```
OS10(config)# router bgp 300
OS10(config-router-bgp-300)# template ebgppg
OS10(config-router-template)# bfd
OS10(config-router-template)# exit
OS10(config-router-bgp-300)# neighbor 3.1.1.1
OS10(config-router-neighbor)# inherit template ebgppg
OS10(config-router-neighbor)# no shutdown
```

#### Display BFD operation

```
OS10# show bfd neighbors
* - Active session role

LocalAddr RemoteAddr Interface State Rx-int Tx-int Mult VRF Clients

* 150.150.1.2 150.150.1.1 vlan10 up 1000 1000 5 default bgp
```

```
OS10# show bfd neighbors detail
Session Discriminator: 1
Neighbor Discriminator: 2
Local Addr: 150.150.1.2
Local MAC Addr: 90:b1:1c:f4:ab:fd
Remote Addr: 150.150.1.1
Remote MAC Addr: 90:b1:1c:f4:a4:d4
Interface: vlan10
State: up
Configured parameters:
TX: 1000ms, RX: 1000ms, Multiplier: 5
Actual parameters:
TX: 1000ms, RX: 1000ms, Multiplier: 5
Neighbor parameters:
TX: 200ms, RX: 200ms, Multiplier: 49
Role: active
VRF: default
Client Registered: bgp
Uptime: 01:58:09
Statistics:
```

```
Number of packets received from neighbor: 7138
Number of packets sent to neighbor: 7138
```

## Verify BFD for BGP

```
OS10(config-router-bgp-101)# show ip bgp summary
BGP router identifier 30.1.1.2 local AS number 101
Global BFD is enabled
Neighbor AS MsgRcvd MsgSent Up/Down State/Pfx
20.1.1.1 101 781 777 11:16:13 0
30.1.1.1 101 787 779 11:15:35 0
```

```
OS10(config-router-bgp-101)# show ip bgp neighbors
BGP neighbor is 20.1.1.1, remote AS 101, local AS 101 internal link
```

```
BGP version 4, remote router ID 30.1.1.1
BGP state ESTABLISHED, in this state for 11:19:01
Last read 00:24:31 seconds
Hold time is 180, keepalive interval is 60 seconds
Configured hold time is 180, keepalive interval is 60 seconds
Fall-over disabled
```

### Neighbor is using Global level BFD Configuration

```
Received 784 messages
 1 opens, 0 notifications, 0 updates
 783 keepalives, 0 route refresh requests
Sent 780 messages
 2 opens, 0 notifications, 0 updates
 778 keepalives, 0 route refresh requests
Minimum time between advertisement runs is 30 seconds
Minimum time before advertisements start is 0 seconds
Capabilities received from neighbor for IPv4 Unicast:
MULTIPROTO_EXT(1)
ROUTE_REFRESH(2)
CISCO_ROUTE_REFRESH(128)
4_OCTET_AS(65)
Capabilities advertised to neighbor for IPv4 Unicast:
MULTIPROTO_EXT(1)
ROUTE_REFRESH(2)
CISCO_ROUTE_REFRESH(128)
4_OCTET_AS(65)
Prefixes accepted 0, Prefixes advertised 0
Connections established 1; dropped 0
Last reset never
For address family: IPv4 Unicast
 Allow local AS number 0 times in AS-PATH attribute
Prefixes ignored due to:
 Martian address 0, Our own AS in AS-PATH 0
 Invalid Nexthop 0, Invalid AS-PATH length 0
 Wellknown community 0, Locally originated 0

Local host: 20.1.1.2, Local port: 179
Foreign host: 20.1.1.1, Foreign port: 58248
```

## BFD for OSPF

You can configure BFD to monitor and notify reachability status between OSPF neighbors. When you use BFD with OSPF, BFD sessions are established between all neighboring interfaces participating with OSPF full state. If a neighboring interface fails, BFD notifies OSPF protocol that a link state change has occurred.

To configure BFD for OSPF:

1. Enable BFD Globally.
2. Configure OSPF on the interconnecting routers. For more information, see [Open Shortest Path First \(OSPFv2 and OSPFv3\)](#).

## Enable BFD Globally

To enable BFD globally:

Enable BFD globally.

```
bfd enable
```

CONFIGURATION Mode

## Establishing BFD sessions with OSPFv2 neighbors

You can establish BFD sessions with all OSPF neighbors at one go. Alternatively, you can also establish BFD sessions with OSPF neighbors corresponding to a single OSPF interface.

To establish BFD sessions with OSPFv2 neighbors:

1. Enable BFD globally

```
bfd enable
```

CONFIGURATION Mode

2. Enter ROUTER-OSPF mode

```
router ospf ospf-instance
```

CONFIGURATION Mode

3. Establish sessions with all OSPFv2 neighbors.

```
bfd all-neighbors
```

ROUTER-OSPF Mode

4. Enter INTERFACE CONFIGURATION mode.

```
interface interface-name
```

CONFIGURATION Mode

5. Establish BFD sessions with OSPFv2 neighbors corresponding to a single OSPF interface.

```
ip ospf bfd all-neighbors
```

INTERFACE CONFIGURATION Mode

## Establishing BFD sessions with OSPFv2 neighbors in a non-default VRF instance

To establish BFD sessions with OSPFv2 neighbors in a non-default VRF instance:

1. Enable BFD globally

```
bfd enable
```

CONFIGURATION Mode

2. Enter INTERFACE CONFIGURATION mode

```
interface interface-name
```

CONFIGURATION Mode

3. Associate a non-default VRF with the interface you have entered.

```
ip vrf forwarding vrf1
```

INTERFACE CONFIGURATION Mode

4. Assign an IP address to the VRF.

```
ip address ip-address
```

VRF CONFIGURATION Mode

5. Attach the interface to an OSPF area.

```
ip ospf ospf-instance area area-address
```

VRF CONFIGURATION Mode



6. Establish BFD session with OSPFv2 neighbors in a single OSPF interface in a non-default VRF instance.

```
ip ospf bfd all-neighbors
VRF CONFIGURATION Mode
```

7. Enter ROUTER-OSPF mode in a non-default VRF instance.

```
router ospf ospf-instance vrf vrf-name
```

8. Establish BFD sessions with all OSPFv2 instances in a non-default VRF.

```
bfd all-neighbors
```

```
OS10# show running-configuration ospf
!
interface vlan200
no shutdown
ip vrf forwarding red
ip address 20.1.1.1/24
ip ospf 200 area 0.0.0.0
ip ospf bfd all-neighbors disable
!
interface vlan300
no shutdown
ip vrf forwarding red
ip address 30.1.1.1/24
ip ospf 200 area 0.0.0.0
!
router ospf 200 vrf red
bfd all-neighbors
log-adjacency-changes
router-id 2.3.3.1
!
```

In this example OSPF is enabled in non-default VRF red. BFD is enabled globally at the router OSPF level and all the interfaces associated with this VRF OSPF instance inherit the global BFD configuration. However, this global BFD configuration does not apply to interfaces in which the interface level BFD configuration is already present. Also, VLAN 200 takes the interface level BFD configuration as interface-level BFD configuration takes precedent over the global OSPF-level BFD configuration.

## Changing OSPFv2 BFD session parameters

Configure BFD sessions with default intervals and a default role.

The parameters that you can configure are: desired tx interval, required min rx interval, detection multiplier, and system role. Configure these parameters for all OSPF sessions or all OSPF sessions on a particular interface. If you change a parameter globally, the change affects all OSPF neighbors sessions. If you change a parameter at the interface level, the change affects all OSPF sessions on that interface.

**i** **NOTE:** By default, OSPF uses the following BFD parameters for it's neighbors: min\_tx = 200 msec, min\_rx = 200 msec, multiplier = 3, role = active. If BFD is configured under interface context, that will be given high priority.

To change parameters for all OSPFv2 sessions or for OSPF sessions on a single interface, use the following commands:

1. Change parameters for OSPF sessions.

```
bfd all-neighbors interval milliseconds min_rx milliseconds multiplier value role [active
| passive]
ROUTER-OSPF Mode
```

2. Change parameters for all OSPF sessions on an interface.

```
ip ospf bfd all-neighbors interval milliseconds min_rx milliseconds multiplier value role
[active | passive]
INTERFACE CONFIGURATION Mode
```

## Disabling BFD for OSPFv2

If you disable BFD globally, all sessions are torn down and sessions on the remote system are placed in a Down state. If you disable BFD on an interface, sessions on the interface are torn down and sessions on the remote system are placed in a Down

state. Disabling BFD does not trigger a change in BFD clients; a final Admin Down packet is sent before the session is terminated.

To disable BFD sessions, use the following commands:

1. Disable BFD sessions with all OSPF neighbors.  
`no bfd all-neighbors`  
ROUTER-OSPF Mode
2. Disable OSPFv2 at interface level using the following command:  
`ip ospf bfd all-neighbors disable`  
INTERFACE CONFIGURATION Mode

To re-enable BFD, disabled the interface alone using the following commands:

- `no ip ospf bfd all-neighbors command`
- `ip ospf bfd all-neighbors`

## Configure BFD for OSPFv3

BFD for OSPFv3 provides support for IPv6:

1. Enable BFD Globally.
2. Establish sessions with OSPFv3 neighbors.

### Establishing BFD sessions with OSPFv3 neighbors

To establish BFD sessions with OSPFv3 neighbors:

1. Enable BFD globally  
`bfd enable`  
CONFIGURATION Mode
2. Enter ROUTER-OSPF mode  
`router ospfv3 ospfv3-instance`  
CONFIGURATION
3. Establish sessions with all OSPFv3 neighbors.  
`bfd all-neighbors`  
ROUTER-OSPFv3 Mode
4. Enter INTERFACE CONFIGURATION mode.  
`interface interface-name`  
CONFIGURATION Mode
5. Establish BFD sessions with OSPFv3 neighbors corresponding to a single OSPF interface.  
`ipv6 ospf bfd all-neighbors`  
INTERFACE CONFIGURATION Mode

### Establishing BFD sessions with OSPFv3 neighbors in a non-default VRF instance

To establish BFD sessions with OSPFv3 neighbors in a non-default VRF instance:

1. Enable BFD globally  
`bfd enable`  
CONFIGURATION Mode
2. Enter INTERFACE CONFIGURATION mode  
`interface interface-name`  
CONFIGURATION Mode

3. Associate a non-default VRF with the interface you have entered.

```
ip vrf forwarding vrf1
INTERFACE CONFIGURATION Mode
```

4. Assign an IP address to the VRF.

```
ip address ip-address
VRF CONFIGURATION Mode
```

5. Attach the interface to an OSPF area.

```
ipv6 ospf ospf-instance area area-address
VRF CONFIGURATION Mode
```

6. Establish BFD session with OSPFv3 neighbors in a single OSPF interface in a non-default VRF instance.

```
ipv6 ospf bfd all-neighbors
VRF CONFIGURATION Mode
```

7. Enter ROUTER-OSPF mode in a non-default VRF instance.

```
router ospf ospf-instance vrf vrf-name
CONFIGURATION Mode
```

8. Establish BFD sessions with all OSPFv2 instances in a non-default VRF.

```
bfd all-neighbors
```

## Changing OSPFv3 session parameters

Configure BFD sessions with default intervals and a default role.

The parameters that you can configure are: desired tx interval, required min rx interval, detection multiplier, and system role. Configure these parameters for all OSPFv3 sessions or all OSPFv3 sessions on a particular interface. If you change a parameter globally, the change affects all OSPFv3 neighbors sessions. If you change a parameter at the interface level, the change affects all OSPF sessions on that interface.

**i** **NOTE:** By default, OSPF uses the following BFD parameters for its neighbors: min\_tx = 200 msec, min\_rx = 200 msec, multiplier = 3, role = active. If BFD is configured under interface context, that will be given high priority.

To change parameters for all OSPFv3 sessions or for OSPF sessions on a single interface, use the following commands:

1. Change parameters for OSPF sessions.

```
bfd all-neighbors interval milliseconds min_rx milliseconds multiplier value role [active
| passive]
ROUTER-OSPFv3 Mode
```

2. Change parameters for all OSPF sessions on an interface.

```
ipv6 ospf bfd all-neighbors interval milliseconds min_rx milliseconds multiplier value
role [active | passive]
INTERFACE CONFIGURATION Mode
```

## Disabling BFD for OSPFv3

If you disable BFD globally, all sessions are torn down and sessions on the remote system are placed in a Down state. If you disable BFD on an interface, sessions on the interface are torn down and sessions on the remote system are placed in a Down state. Disabling BFD does not trigger a change in BFD clients; a final Admin Down packet is sent before the session is terminated.

To disable BFD sessions, use the following commands:

1. Disable BFD sessions with all OSPF neighbors.

```
no bfd all-neighbors
ROUTER-OSPFv3 Mode
```

2. Disable BFD sessions with all OSPF neighbors on an interface.

```
ipv6 ospf bfd all-neighbors disable
INTERFACE CONFIGURATION Mode
```

To re-enable BFD, disabled the interface alone using the following commands:

- `no ipv6 ospf bfd all-neighbors` command
- `ipv6 ospf bfd all-neighbors`

## BFD for Static routes

The static route BFD feature enables association of static routes with a BFD session to monitor the static route reachability. Depending on the status of the BFD session, the static routes are added to or deleted from the Routing Information Base (RIB). When you configure BFD, next-hop reachability depends on the BFD state of the BFD session corresponding to the specified next hop. If the BFD session of the configured next hop is down, the static route is not installed in the RIB.

The BFD session must be up for the static route. You must configure BFD on both the peers pointing to its neighbor as the next hop. There is no dependency on the configuration order of the static route and BFD configuration. You can configure BFD for all static routes or for specific static routes. OS10 supports BFD for both IPv4 and IPv6 static routes.

### Enable BFD for all static routes

Configuring BFD for static routes is a three-step process:

1. Enable BFD globally.
2. Configure static routes on both routers on the system (either local or remote). Configure the static route in such a way that the next-hop interfaces point to each other.
3. Configure BFD for static route using the `ip route bfd` command.

### Establishing BFD Sessions for IPv4 Static Routes

Sessions are established for all neighbors that are the next hop of a static route.

To establish a BFD session, use the following command.

Establish BFD sessions for all neighbors that are the next hop of a static route.

```
ip route bfd [interval interval min_rx min_rx multiplier value role {active | passive}]
```

CONFIGURATION Mode

Enter the time interval for sending and receiving BFD control packets from 50 to 1000.

### Establishing BFD Sessions for IPv4 Static Routes in a non-default VRF instance

To establish a BFD session for IPv4 static routes in a non-default VRF instance, use the following command.

Establish BFD sessions for all neighbors that are the next hop of a static route.

```
ip route bfd [vrf vrf-name] [interval interval min_rx min_rx multiplier value role {active | passive}]
```

CONFIGURATION Mode

Enter the time interval for sending and receiving BFD control packets from 50 to 1000.

### Changing IPv4 static route session parameters

Configure BFD sessions with default intervals and a default role.

Configure the following for all static routes:

- Desired TX Interval
- Required Min RX Interval
- Detection Multiplier
- system role

These parameters are configured for all static routes. If you change a parameter, the change affects all sessions for static routes. To change parameters for static route sessions, use the following command.

- Change the parameters for all static route sessions in CONFIGURATION mode.

```
ip route bfd interval milliseconds min_rx milliseconds multiplier value role [active | passive]
```

Enter the time interval for sending and receiving BFD control packets; from 50 to 1000.

**NOTE:** By default, OSPF uses the following BFD parameters for its neighbors: min\_tx = 200 msec, min\_rx = 200 msec, multiplier = 3, role = active.

## Disabling BFD for IPv4 Static Routes

If you disable BFD, all static route BFD sessions are torn down.

A final Admin Down packet is sent to all neighbors on the remote systems, and those neighbors change to the Down state. To disable BFD for IPv4 static routes, use the following command.

Disable BFD for static routes.

```
no ip route bfd
```

CONFIGURATION Mode

## Establishing BFD Sessions for IPv6 Static Routes

To establish a BFD session for IPv6 static routes, use the following command.

Establish BFD sessions for all neighbors that are the next hop of a static route.

```
ipv6 route bfd [interval interval min_rx min_rx multiplier value role {active | passive}]
```

CONFIGURATION Mode

Enter the time interval for sending and receiving BFD control packets from 50 to 1000.

**NOTE:** By default, OSPF uses the following BFD parameters for its neighbors: min\_tx = 200 msec, min\_rx = 200 msec, multiplier = 3, role = active. The values are configured in milliseconds

## Establishing BFD Sessions for IPv6 Static Routes in a non-default VRF instance

To establish a BFD session for IPv6 static routes in a non-default VRF instance, use the following command.

Establish BFD sessions for all neighbors that are the next hop of a static route.

```
ipv6 route bfd [vrf vrf-name] [interval interval min_rx min_rx multiplier value role {active | passive}]
```

CONFIGURATION Mode

Enter the time interval for sending and receiving BFD control packets from 50 to 1000.

**NOTE:** By default, OSPF uses the following BFD parameters for its neighbors: min\_tx = 200 msec, min\_rx = 200 msec, multiplier = 3, role = active. The values are configured in milliseconds

## Changing IPv6 static route session parameters

To change parameters for IPv6 static route sessions:

- Change the parameters for all static route sessions in CONFIGURATION mode.

```
ipv6 route bfd interval milliseconds min_rx milliseconds multiplier value role [active | passive]
```

Enter the time interval for sending and receiving BFD control packets; from 50 to 1000.

**NOTE:** By default, OSPF uses the following BFD parameters for its neighbors: min\_tx = 200 msec, min\_rx = 200 msec, multiplier = 3, role = active.

## Enable BFD for specific static routes

To enable BFD for specific static routes:

- Configure static routes on both local and remote routers. Configure static route in such a way that the next-hop interfaces point to each other.
- Configure BFD for a specific IPv4 static route using the following command in CONFIGURATION mode:

```
ip route [vrf vrf-name] dest-ip-prefix mask {next-hop [interface interface-type]
[route-preference]} bfd
```

- Configure BFD for a specific IPv6 static route using the following command in CONFIGURATION mode:

```
ipv6 route [vrf vrf-name] dest-ipv6-prefix mask {next-hop [interface interface-type]
[route-preference]} bfd
```

The following is an example configuration for enabling BFD for specific static routes on the default VRF:

```
OS10(config)#ip route 10.2.2.0/24 10.1.1.1 bfd
```

The following example enables BFD for specific static routes on a nondefault VRF:

```
OS10(config)#ip route vrf LAN2 10.2.2.0/24 10.1.1.1 bfd
```

The following example enables BFD for specific IPv6 static routes on the default VRF:

```
OS10(config)# ipv6 route 2111:dddd:0eee::22/128 2001:db86:0fff::2 bfd
```

The following example enables BFD for specific IPv6 static routes on a nondefault VRF:

```
OS10(config)# ipv6 route vrf LAN2 2111:dddd:0eee::22/128 2001:db86:0fff::2 bfd
```

## Change the BFD session parameters for static routes

To change BFD session parameters for IPv4 or IPv6 static routes, use the following command in CONFIGURATION mode:

```
bfd interval milliseconds min_rx milliseconds multiplier number role {active | passive}
```

The following example changes the BFD session parameters for static routes:

```
OS10(config)# bfd interval 250 min_rx 300 multiplier 4 role passive
```

## Disabling BFD for IPv6 Static Routes

To disable BFD for IPv6 static routes, use the following command.

Disable BFD for static routes.

```
no ipv6 route bfd
```

CONFIGURATION Mode

# BFD commands

## bfd

Enables BFD sessions with specified neighbors.

|                     |                                    |
|---------------------|------------------------------------|
| <b>Syntax</b>       | bfd                                |
| <b>Parameters</b>   | None                               |
| <b>Default</b>      | Not configured                     |
| <b>Command Mode</b> | ROUTER-NEIGHBOR<br>ROUTER-TEMPLATE |

### Usage Information

- Use the `bfd` command to configure BFD sessions with a specified neighbor or neighbors which inherit a BGP template. Use the `neighbor {ip-address | ipv6-address}` command in ROUTER-BGP mode to specify the neighbor. Use the `template template-name` command in ROUTER-BGP mode to specify a BGP template. Use the `no bfd` command in ROUTER-NEIGHBOR mode to disable BFD sessions with a neighbor.
- Use the `bfd all-neighbors` command to configure L3 protocol-specific BFD parameters for all BFD sessions between discovered neighbors. The BFD parameters you configure override the global session parameters configured with the `bfd interval` command.

### Example

```
OS10(conf)# router bgp 1
OS10(config-router-bgp-1)# neighbor 10.1.1.1
OS10(config-router-neighbor)# bfd
OS10(config-router-neighbor)# no shutdown
```

```
OS10(config)# router bgp 300
OS10(config-router-bgp-300)# template ebgppg
OS10(config-router-template)# bfd
OS10(config-router-template)# exit
OS10(config-router-bgp-300)# neighbor 3.1.1.1
OS10(config-router-neighbor)# inherit template ebgppg
OS10(config-router-neighbor)# no shutdown
```

**Supported releases** 10.4.1.0 or later

## bfd all-neighbors

Configures parameters of BFD sessions that are established between neighbors discovered by an L3 protocol.

**Syntax** `bfd all-neighbors [interval milliseconds min_rx milliseconds multiplier number role {active | passive}]`

### Parameters

- `interval milliseconds` — Enter the time interval for sending control packets to BFD peers; from 50 to 1000. Dell EMC recommends using more than 100 milliseconds.
- `min_rx milliseconds` — Enter the maximum waiting time for receiving control packets from BFD peers; from 50 to 1000. Dell EMC recommends using more than 100 milliseconds.
- `multiplier number` — Enter the maximum number of consecutive packets that must not be received from a BFD peer before the session state changes to Down; from 3 to 50.
- `role {active | passive}` — Enter `active` if the router initiates BFD sessions. Both BFD peers can be active at the same time. Enter `passive` if the router does not initiate BFD sessions, and only responds to a request from an active BFD to initialize a session.

### Default

The time interval for sending control packets to BFD peers is 200 milliseconds.

The maximum waiting time for receiving control packets from BFD peers is 200 milliseconds.

The number of consecutive packets that must be received from a BFD peer before BFD considers it as down is 3.

The BFD role is `active`.

- Command Mode**
- ROUTER-BGP
  - ROUTER-OSPF
  - ROUTER-OSPFv3
- Usage Information**
- Use this command to configure BFD sessions between discovered neighbors. The BFD session parameters you configure override the global session parameters configured with the `bfd interval` command. To disable BFD and ignore the configured `bfd all-neighbors` settings for a specified neighbor, use the `bfd disable` command in ROUTER-NEIGHBOR mode.
  - To remove the configured all-neighbors settings for all BGP neighbors, enter the `no` version of the command. To return to the default values, use the `bfd all-neighbors` command.

**Example**

```
OS10(conf-router-bgp)# bfd all-neighbors interval 250 min_rx 300 multiplier 4 role passive
```

**Supported releases** 10.4.1.0 or later

## bfd disable

Ignores the configured `bfd all-neighbors` settings and disables BFD for a specified neighbor.

- Syntax** `bfd disable`
- Parameters** None
- Default** Not configured
- Command Mode** ROUTER-NEIGHBOR
- Usage Information** Use the `neighbor ip-address` command in ROUTER-BGP mode to specify a neighbor. Use the `bfd disable` command to disable BFD sessions with the neighbor.

**Example**

```
OS10(conf)# router bgp 1
OS10(config-router-bgp-1)# neighbor 10.1.1.1
OS10(config-router-neighbor)# bfd disable
```

**Supported releases** 10.4.1.0 or later

## bfd enable

Enables BFD on all interfaces on the switch.

- Syntax** `bfd enable`
- Parameters** None
- Default** BFD is disabled.
- Command Mode** CONFIGURATION
- Usage Information** Before you configure BFD for static routing or a routing protocol, enable BFD globally on each router in a BFD session. To globally disable BFD on all interfaces, enter the `no bfd enable` command.

**Example**

```
OS10(config)# bfd enable
```

**Supported releases** 10.4.1.0 or later



## bfd interval

Configures parameters for all BFD sessions on the switch.

|                           |                                                                                                                                                                                                                                                                                                                                                                                                                                                                                                                                                                                                                                                                                                                                                                                                                                                                                                                                                                      |
|---------------------------|----------------------------------------------------------------------------------------------------------------------------------------------------------------------------------------------------------------------------------------------------------------------------------------------------------------------------------------------------------------------------------------------------------------------------------------------------------------------------------------------------------------------------------------------------------------------------------------------------------------------------------------------------------------------------------------------------------------------------------------------------------------------------------------------------------------------------------------------------------------------------------------------------------------------------------------------------------------------|
| <b>Syntax</b>             | <code>bfd interval <i>milliseconds</i> min_rx <i>milliseconds</i> multiplier <i>number</i> role {active   passive}</code>                                                                                                                                                                                                                                                                                                                                                                                                                                                                                                                                                                                                                                                                                                                                                                                                                                            |
| <b>Parameters</b>         | <ul style="list-style-type: none"><li>• <code>interval <i>milliseconds</i></code> — Enter the time interval for sending control packets to BFD peers; from 50 to 1000. Dell EMC recommends using more than 100 milliseconds.</li><li>• <code>min_rx <i>milliseconds</i></code> — Enter the maximum waiting time for receiving control packets from BFD peers, from 50 to 1000. Dell EMC recommends using more than 100 milliseconds.</li><li>• <code>multiplier <i>number</i></code> — Enter the number of consecutive packets that can be missed from a BFD peer before the session state changes to <code>Down</code>, from 3 to 50.</li><li>• <code>role {active   passive}</code> — Enter <code>active</code> if the router initiates BFD sessions. Both BFD peers can be active at the same time. Enter <code>passive</code> if the router does not initiate BFD sessions, and only responds to a request from an active BFD to initialize a session.</li></ul> |
| <b>Default</b>            | The time interval for sending control packets to BFD peers is 200 milliseconds.<br>The maximum waiting time for receiving control packets from BFD peers is 200 milliseconds.<br>The number of consecutive packets that must be received from a BFD peer is 3.<br>The BFD role is <code>active</code> .                                                                                                                                                                                                                                                                                                                                                                                                                                                                                                                                                                                                                                                              |
| <b>Command Mode</b>       | CONFIGURATION                                                                                                                                                                                                                                                                                                                                                                                                                                                                                                                                                                                                                                                                                                                                                                                                                                                                                                                                                        |
| <b>Usage Information</b>  | Use this command to configure global BFD session settings. To configure the BFD parameters used in sessions established with neighbors discovered by an L3 protocol, use the <code>bfd all-neighbors</code> command. The <code>no</code> version of this command deletes the configured global settings and returns to the default values.<br><br>If you enable BFD on a specific static route, use the <code>bfd interval</code> command to configure the BFD parameters for that specific static route.                                                                                                                                                                                                                                                                                                                                                                                                                                                            |
| <b>Example</b>            | <pre>OS10(config)# bfd interval 250 min_rx 300 multiplier 4 role passive</pre>                                                                                                                                                                                                                                                                                                                                                                                                                                                                                                                                                                                                                                                                                                                                                                                                                                                                                       |
| <b>Supported releases</b> | 10.4.1.0 or later                                                                                                                                                                                                                                                                                                                                                                                                                                                                                                                                                                                                                                                                                                                                                                                                                                                                                                                                                    |

## ip ospf bfd all-neighbors

Enables and configures the default BFD parameters for all OSPFv2 neighbors in this interface.

|                   |                                                                                                                                                                                                                                                                                                                                                                                                                                                                                                                                                                                                                                                                                                                                                                                                                                                                                                                                                                                                                                                                        |
|-------------------|------------------------------------------------------------------------------------------------------------------------------------------------------------------------------------------------------------------------------------------------------------------------------------------------------------------------------------------------------------------------------------------------------------------------------------------------------------------------------------------------------------------------------------------------------------------------------------------------------------------------------------------------------------------------------------------------------------------------------------------------------------------------------------------------------------------------------------------------------------------------------------------------------------------------------------------------------------------------------------------------------------------------------------------------------------------------|
| <b>Syntax</b>     | <code>ip ospf bfd all-neighbors [disable [interval <i>millisec</i> min_rx <i>min_rx</i> multiplier role {active   passive}]]</code>                                                                                                                                                                                                                                                                                                                                                                                                                                                                                                                                                                                                                                                                                                                                                                                                                                                                                                                                    |
| <b>Parameters</b> | <ul style="list-style-type: none"><li>• <code>disable</code> — Disables the BFD session on an interface alone.</li><li>• <code>interval <i>milliseconds</i></code> — Enter the time interval for sending control packets to BFD peers, from 100 to 1000. Dell EMC recommends using more than 100 milliseconds.</li><li>• <code>min_rx <i>milliseconds</i></code> — Enter the maximum waiting time for receiving control packets from BFD peers, from 100 to 1000. Dell EMC recommends using more than 100 milliseconds.</li><li>• <code>multiplier <i>number</i></code> — Enter the maximum number of consecutive packets that must not be received from a BFD peer before the session state changes to <code>Down</code>, from 3 to 50.</li><li>• <code>role {active   passive}</code> — Enter <code>active</code> if the router initiates BFD sessions. Both BFD peers can be active at the same time. Enter <code>passive</code> if the router does not initiate BFD sessions, and only responds to a request from an active BFD to initialize a session.</li></ul> |
| <b>Default</b>    | The time interval for sending control packets to BFD peers is 200 milliseconds.<br>The maximum waiting time for receiving control packets from BFD peers is 200 milliseconds.<br>The number of consecutive packets that must be received from a BFD peer is 3.                                                                                                                                                                                                                                                                                                                                                                                                                                                                                                                                                                                                                                                                                                                                                                                                         |

The BFD role is `active`

**Command Mode** CONFIG-INTERFACE

**Usage Information**

- This command can be used to enable or disable BFD for an interface associated with OSPFv2. Interface level BFD configuration takes precedent over the OSPF global level BFD configuration. If there is no BFD configuration present at the interface level global OSPF BFD configuration will be inherited.

**Example**

```
(conf-if-eth1/1/1)#ip ospf bfd all-neighbors
```

**Supported releases** 10.4.2E or later

## ipv6 ospf bfd all-neighbors

Enables and configures the default BFD parameters for all OSPFv3 neighbors in this interface.

**Syntax** `ipv6 ospf bfd all-neighbors [disable|[interval millisec min_rx min_rx multiplier role {active | passive}]]`

To disable default BFD parameters for all OSPFv3 neighbors using the `no ipv6 ospf bfd all-neighbors`.

**Parameters**

- `disable` — Disables the BFD session on an interface alone.
- `interval milliseconds` — Enter the time interval for sending control packets to BFD peers, from 100 to 1000. You cannot configure a value that is less than 100 milliseconds.
- `min_rx milliseconds` — Enter the maximum waiting time for receiving control packets from BFD peers, from 100 to 1000. Dell EMC recommends using more than 100 milliseconds.
- `multiplier number` — Enter the maximum number of consecutive packets that must not be received from a BFD peer before the session state changes to Down, from 3 to 50.
- `role {active | passive}` — Enter `active` if the router initiates BFD sessions. Both BFD peers can be active at the same time. Enter `passive` if the router does not initiate BFD sessions, and only responds to a request from an active BFD to initialize a session.

**Default**

The time interval for sending control packets to BFD peers is 200 milliseconds.

The maximum waiting time for receiving control packets from BFD peers is 200 milliseconds.

The number of consecutive packets that must be received from a BFD peer is 3.

The BFD role is `active`

**Command Mode** CONFIG-INTERFACE

**Usage Information**

- This command can be used to enable or disable BFD for an interface associated with OSPFv3. Interface level BFD configuration takes precedent over the OSPF global level BFD configuration. If there is no BFD configuration present at the interface level global OSPF BFD configuration will be inherited. All types of interfaces are supported.

**Example**

```
(conf-if-eth1/1/1)#ipv6 ospf bfd all-neighbors
```

**Supported releases** 10.4.2E or later

## ip route bfd

Enables or disables BFD on static routes.

**Syntax** `ip route[vrf vrf-name] bfd [interval interval min_rx wait-time multiplier number role {active | passive}]`

**Parameters**

- `vrf vrf-name` — Enter `vrf` and then the name of the VRF to configure static route in that VRF.
- `interval milliseconds` — Enter the time interval for sending control packets to BFD peers; from 50 to 1000. Dell EMC recommends using more than 100 milliseconds.
- `min_rx milliseconds` — Enter the minimum waiting time for receiving control packets from BFD peers, from 50 to 1000. Dell EMC recommends using more than 100 milliseconds.
- `multiplier number` — Enter the maximum number of consecutive packets that must not be received from a BFD peer before the session state changes to `Down`; from 3 to 50.
- `role {active | passive}` — Enter `active` if the router initiates BFD sessions. Both BFD peers can be active simultaneously. Enter `passive` if the router does not initiate BFD sessions, and only responds to a request from an active BFD to initialize a session.

**Default**

The time interval for sending control packets to BFD peers is 200 milliseconds.

The maximum waiting time for receiving control packets from BFD peers is 200 milliseconds.

The number of consecutive packets that must be received from a BFD peer is 3.

The BFD role is `active`.

**Command Mode** CONFIG

**Usage Information**

Use this command to enable or disable BFD for all the configured IPv4 static routes for the specified VRF. If you do not specify a VRF name, the command is applicable for the default VRF.

The no version of this command disables BFD on a static route

**Example**

```
OS10(config)# ip route bfd interval 250 min_rx 250 multiplier 4 role active
```

**Supported releases**

10.4.2E or later

## ipv6 route bfd

Enables or disables BFD on IPv6 static routes.

**Syntax**

```
ipv6 route [vrf vrf-name] bfd [interval millisec min_rx min_rx multiplier role {active | passive}]
```

**Parameters**

- `vrf vrf-name` — Enter the keyword VRF and then the name of the VRF to configure static route in that VRF.
- `interval milliseconds` — Enter the time interval for sending control packets to BFD peers, from 50 to 1000.
- `min_rx milliseconds` — Enter the maximum waiting time for receiving control packets from BFD peers, from 50 to 1000. Dell EMC recommends using more than 100 milliseconds.
- `multiplier number` — Enter the maximum number of consecutive packets that must not be received from a BFD peer before the session state changes to `Down`, from 3 to 50.
- `role {active | passive}` — Enter `active` if the router initiates BFD sessions. Both BFD peers can be active simultaneously. Enter `passive` if the router does not initiate BFD sessions, and only responds to a request from an active BFD to initialize a session.

**Default**

The time interval for sending control packets to BFD peers is 200 milliseconds.

The maximum waiting time for receiving control packets from BFD peers is 200 milliseconds.

The number of consecutive packets that must be received from a BFD peer is 3.

The BFD role is `active`.

**Command Mode** CONFIG

**Usage Information**

- Use this command to enable or disable BFD for all the configured IPv6 static routes for the specified VRF. If you do not specify a VRF name, the command is applicable for the default VRF.

The no version of this command disables BFD on an IPv6 static route.

## Example

```
OS10(config)# ipv6 route bfd interval 250 min_rx 250 multiplier 4 role active
```

## Supported releases

10.4.2E or later

## show bfd neighbors

Displays information about BFD neighbors from all interfaces using the default VRF.

### Syntax

```
show bfd neighbors [active | detail | interface]
```

### Parameters

- **detail** — (Optional) View detailed information about BFD neighbors.
- **active** — (Optional) View information about the active BFD neighbors whose state is up.
- **interface *interface-type*** — (Optional) Enter one of the following interface types:
  - **ethernet *node/slot/port[:subport]*** — Displays Ethernet interface information.
  - **port-channel *id-number*** — Display port channel interface IDs, from 1 to 128.
  - **vlan *vlan-id*** — Displays the VLAN interface number, from 1 to 4093.

### Default

Not configured

### Command Mode

EXEC

### Usage Information

Use this command to verify that a BFD session between neighbors is up using the default VRF instance. Use the `detail` keyword to view the BFD session parameters.

## Example

```
OS10# show bfd neighbors
* - Active session role

```

| LocalAddr     | RemoteAddr  | Interface        | State | RxInt | TxInt | Mult | VR |
|---------------|-------------|------------------|-------|-------|-------|------|----|
| * 100.100.1.1 | 100.100.1.2 | ethernet1/1/26:1 | up    | 200   | 200   | 3    | re |
| * 100.100.3.1 | 100.100.3.2 | ethernet1/1/26:3 | up    | 200   | 200   | 3    | de |
| * 200.1.1.2   | 200.1.1.1   | vlan102          | up    | 200   | 200   | 3    | bi |
| * 200.1.5.2   | 200.1.5.1   | vlan105          | up    | 200   | 200   | 3    | de |
| * 200.1.11.2  | 200.1.11.1  | vlan111          | up    | 200   | 200   | 3    | gr |
| * 200.1.12.2  | 200.1.12.1  | vlan112          | up    | 200   | 200   | 3    | de |
| * 201.1.1.2   | 201.1.1.1   | vlan101          | up    | 200   | 200   | 3    | gr |
| * 201.1.1.2   | 201.1.1.1   | vlan301          | down  | 1000  | 1000  | 3    | de |
| * 201.1.2.2   | 201.1.2.1   | vlan302          | down  | 1000  | 1000  | 3    | de |
| * 201.1.3.2   | 201.1.3.1   | vlan303          | down  | 1000  | 1000  | 3    | de |
| * 201.1.4.2   | 201.1.4.1   | vlan304          | down  | 1000  | 1000  | 3    | de |
| * 201.1.5.2   | 201.1.5.1   | vlan305          | down  | 1000  | 1000  | 3    | de |
| * 201.1.6.2   | 201.1.6.1   | vlan306          | down  | 1000  | 1000  | 3    | de |

```
OS10# show bfd neighbors detail
Session Discriminator: 1
Neighbor Discriminator: 2
Local Addr: 150.150.1.2
Local MAC Addr: 90:b1:1c:f4:ab:fd
Remote Addr: 150.150.1.1
Remote MAC Addr: 90:b1:1c:f4:a4:d4
Interface: vlan10
State: up
Configured parameters:
TX: 1000ms, RX: 1000ms, Multiplier: 5
Actual parameters:
TX: 1000ms, RX: 1000ms, Multiplier: 5
Neighbor parameters:
TX: 200ms, RX: 200ms, Multiplier: 49
Role: active
VRF: default
Client Registered: bgp
Uptime: 01:58:09
Statistics:
```

```
Number of packets received from neighbor: 7138
Number of packets sent to neighbor: 7138
```

```
OS10#show bfd neighbors active
* - Active session role
```

| LocalAddr     | RemoteAddr  | Interface        | State | RxInt | TxInt | Mult | VF |
|---------------|-------------|------------------|-------|-------|-------|------|----|
| * 100.100.1.1 | 100.100.1.2 | ethernet1/1/26:1 | up    | 200   | 200   | 3    | re |
| * 100.100.3.1 | 100.100.3.2 | ethernet1/1/26:3 | up    | 200   | 200   | 3    | de |
| * 200.1.1.2   | 200.1.1.1   | vlan102          | up    | 200   | 200   | 3    | bl |
| * 200.1.5.2   | 200.1.5.1   | vlan105          | up    | 200   | 200   | 3    | de |
| * 200.1.11.2  | 200.1.11.1  | vlan111          | up    | 200   | 200   | 3    | gr |
| * 200.1.12.2  | 200.1.12.1  | vlan112          | up    | 200   | 200   | 3    | de |
| * 201.1.1.2   | 201.1.1.1   | vlan101          | up    | 200   | 200   | 3    | gr |

**Supported releases** 10.4.1.0 or later

## Border Gateway Protocol

Border Gateway Protocol (BGP) is an interautonomous system routing protocol that transmits interdomain routing information within and between autonomous systems (AS). BGP exchanges network reachability information with other BGP systems. BGP adds reliability to network connections by using multiple paths from one router to another. Unlike most routing protocols, BGP uses TCP as its transport protocol.

### Autonomous systems

BGP autonomous systems are a collection of nodes under a single administration with shared network routing policies. Each AS has a number, which an Internet authority assigns—you do not assign the BGP number.

The Internet Assigned Numbers Authority (IANA) identifies each network with a unique AS number (ASN). AS numbers 64512 through 65534 are reserved for private purposes. AS numbers 0 and 65535 cannot be used in a live environment. IANA assigns valid AS numbers in the range of 1 to 64511.

**Multihomed AS** Maintains connections to more than one other AS. This group allows the AS to remain connected to the Internet if a complete failure occurs to one of their connections. This type of AS does not allow traffic from one AS to pass through on its way to another AS.

**Stub AS** Connected to only one AS.

**Transit AS** Provides connections through itself to separate networks. For example, Router 1 uses Router 2—the transit AS, to connect to Router 4. Internet service providers (ISPs) are always a transit AS because they provide connections from one network to another. An ISP uses a transit AS to sell transit service to a customer network.

When BGP operates inside an AS - AS1 **or** AS2, it functions as an Internal Border Gateway Protocol (IBGP). When BGP operates between AS endpoints - AS1 **and** AS2, it functions as an External Border Gateway Protocol (EBGP). IBGP provides routers inside the AS with the path to reach a router external to the AS. EBGP routers exchange information with other EBGP routers and IBGP routers to maintain connectivity and accessibility.

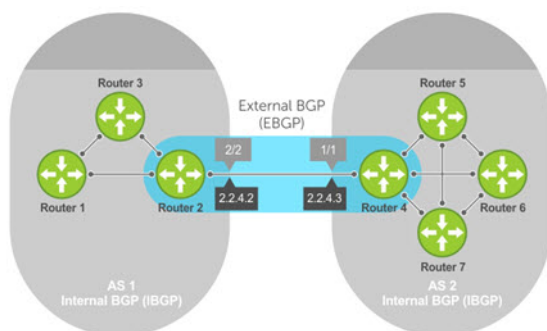

### Classless interdomain routing

BGPv4 supports classless interdomain routing (CIDR) with aggregate routes and AS paths. CIDR defines a network using a prefix consisting of an IP address and mask, resulting in efficient use of the IPv4 address space. Using aggregate routes reduces the size of routing tables.

### Path-vector routing

BGP uses a path-vector protocol that maintains dynamically updated path information. Path information updates which return to the originating node are detected and discarded. BGP does not use a traditional Internal Gateway Protocol (IGP) matrix but makes routing decisions based on path, network policies, and/or rule sets.

### Full-mesh topology

In an AS, a BGP network must be in `full mesh` for routes received from an internal BGP peer to send to another IBGP peer. Each BGP router talks to all other BGP routers in a session. For example, in an AS with four BGP routers, each router has three peers; in an AS with six routers, each router has five peers.

### Configuration notes

All Dell EMC PowerSwitches except MX-Series, S4200-Series, S5200 Series, and Z9332F-ON:

- If you use eBGP to exchange routes with switches in an SFS environment, the router must directly connect to the switch or switches present. You must use the interface IP to set up BGP peering.  
**i** **NOTE:** This behavior is applicable only to the S4100-ON series of switches.
- By default, routes that are learned on multiple paths to eBGP peers are advertised to IBGP peers with the next-hop local IP address. This behavior allows for local repair of atomic failure of any external peers.
- Fast external failover is enabled by default. To disable or re-enable fast external failover, use the `[no] fast-external-fallover` command. For the fast-external-fallover command to take effect on an established BGP session, you must reset the session using the `clear ip bgp {* | peer-ipv4-address | peer-ipv6-address}` command.
- Enabling the BGP add-paths globally for all BGP neighbors is not supported (the `add-path` command in `ROUTER-BGPv4-AF` or `ROUTER-BGPv6-AF` mode). To enable the BGP add-path for one neighbor, use the `add-path` command in `ROUTERBGP-NEIGHBOR-AF` mode.
- When you redistribute OSPFv3 routes to BGP, including External Type-2 routes, the multi-exit discriminator (MED) attribute is set to the OSPF route metric plus one instead of the OSPF route metric value.
- When you configure the `bgp bestpath router-id ignore` command, for non-best paths, the `show ip bgp` output displays `Inactive reason: Router ID`.
- Do not configure the IP address of the router as a BGP neighbor. This action causes the address being accepted as an invalid neighbor address.

## Sessions and peers

A BGP session starts with two routers communicating using the BGP. The two end-points of the session are called *peers*. A peer is also called a *neighbor*. Events and timers determine the information exchange between peers. BGP focuses on traffic routing policies.

### Sessions

In operations with other BGP peers, a BGP process uses a simple finite state machine consisting of six states—`Idle`, `Connect`, `Active`, `OpenSent`, `OpenConfirm`, and `Established`. For each peer-to-peer session, a BGP implementation tracks the state of the session. The BGP defines the messages that each peer exchanges to change the session from one state to another.

|                    |                                                                                                                                                                                                                                                                                 |
|--------------------|---------------------------------------------------------------------------------------------------------------------------------------------------------------------------------------------------------------------------------------------------------------------------------|
| <b>Idle</b>        | BGP initializes all resources, refuses all inbound BGP connection attempts, and starts a TCP connection to the peer.                                                                                                                                                            |
| <b>Connect</b>     | Router waits for the TCP connection to complete and transitions to the <code>OpenSent</code> state if successful. If that transition is not successful, BGP resets the <code>ConnectRetry</code> timer and transitions to the <code>Active</code> state when the timer expires. |
| <b>Active</b>      | Router resets the <code>ConnectRetry</code> timer to zero and returns to the <code>Connect</code> state.                                                                                                                                                                        |
| <b>OpenSent</b>    | Router sends an <code>Open</code> message and waits for one in return after a successful <code>OpenSent</code> transition.                                                                                                                                                      |
| <b>OpenConfirm</b> | Neighbor relation establishes and is in the <code>OpenConfirm</code> state after the <code>Open</code> message parameters are agreed on between peers. The router then receives and checks for agreement on the parameters of the open messages to establish a session.         |

**Established** Keepalive messages exchange, and after a successful receipt, the router is in the `Established` state. Keepalive messages continue to send at regular periods. The keepalive timer establishes the state to verify connections.

After the connection is established, the router sends and receives keepalive, update, and notification messages to and from its peer.

### Peer templates

Peer templates allow BGP neighbors to inherit the same outbound policies. Instead of manually configuring each neighbor with the same policy, you can create a peer group with a shared policy that applies to individual peers. A peer template provides efficient update calculation with a simplified configuration.

Peer templates also aid in convergence speed. When a BGP process sends the same information to many peers, a long output queue may be set up to distribute the information. For peers that are members of a peer template, the information is sent to one place then passed on to the peers within the template.

## Martian addresses

Martian addresses are invalid networks on the Internet.

Martian addresses are special IPv4 and IPv6 addresses which are not routed by routing devices on the Internet. OS10 considers the following as Martian prefixes:

- 0.0.0.0/8
- 127.0.0.0/8
- 224.0.0.0/4
- :: / 128
- FF00::/8
- FE80::/16
- ::0002-::FFFF- all prefixes

## Route reflectors

Route reflectors (RRs) reorganize the IBGP core into a hierarchy and allow route advertisement rules. Route reflection divides IBGP peers into two groups — client peers and nonclient peers.

- If a route is received from a nonclient peer, it reflects the route to all client peers
- If a route is received from a client peer, it reflects the route to all nonclient and client peers

An RR and its client peers form a *route reflection cluster*. BGP speakers announce only the best route for a given prefix. RR rules apply after the router makes its best path decision.

**NOTE:** Do not use RRs in forwarding paths — hierarchal RRs that maintain forwarding plane RRs could create route loops.

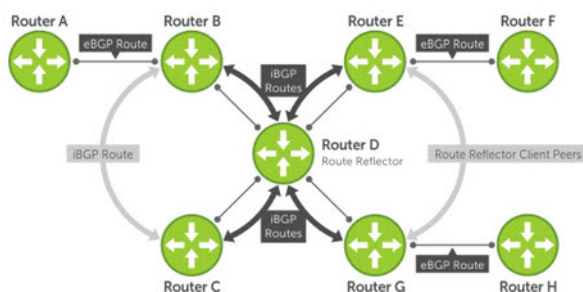

Routers B, C, D, E, and G are members of the same AS—AS100. These routers are also in the same route reflection cluster, where Router D is the route reflector. Routers E and G are client peers of Router D, and Routers B and C are nonclient peers of Router D.

1. Router B receives an advertisement from Router A through EBGP. Because the route is learned through EBGP, Router B advertises it to all its IBGP peers — Routers C and D.
2. Router C receives the advertisement but does not advertise it to any peer because its only other peer is Router D (an IBGP peer) and Router D has already learned it through IBGP from Router B.
3. Router D does not advertise the route to Router C because Router C is a nonclient peer. The route advertisement came from Router B which is also a nonclient peer.
4. Router D does reflect the advertisement to Routers E and G because they are client peers of Router D.
5. Routers E and G advertise this IBGP learned route to their EBGP peers — Routers F and H.

## Multiprotocol BGP

Multiprotocol BGP (MBGP) is an extension to BGP that supports multiple address families—IPv4 and IPv6. MBGP carries multiple sets of unicast and multicast routes depending on the address family.

You can enable the MBGP feature on a per router, per template, and/or a per peer basis. The default is the IPv4 unicast routes.

BGP session supports multiple address family interface (AFI) and sub address family interface (SAFI) combinations, BGP uses OPEN message to convey this information to the peers. As a result, the IPv6 routing information is exchanged over the IPv4 peers and vice versa.

BGP routers that support IPv6 can set up BGP sessions using IPv6 peers. If the existing BGP-v4 session is capable of exchanging ipv6 prefixes, the same is used to carry ipv4 as well as ipv6 prefixes. If the BGP-v4 neighbor goes down, it also impacts the IPv6 route exchange. If BGP-v6 session exists, it continues to operate independently from BGP-v4.

Multiprotocol BGPv6 supports many of the same features and functionality as BGPv4. IPv6 enhancements to MBGP include support for an IPv6 address family and Network Layer Reachability Information (NLRI) and next hop attributes that use the IPv6 addresses.

## Attributes

Routes learned using BGP have associated properties that are used to determine the best route to a destination when multiple paths exist to a particular destination. These properties are called *BGP attributes* which influence route selection for designing robust networks. There are no hard coded limits on the number of supported BGP attributes.

BGP attributes for route selection:

- Weight
- Local preference
- Multiexit discriminators
- Origin
- AS path
- Next-hop

## Communities

BGP communities are sets of routes with one or more common attributes. Communities assign common attributes to multiple routes simultaneously. Duplicate communities are not rejected.

## Disable announcement of ASN values

Modify the AS\_PATH attribute of the received routes.

- Disable prepending the local AS number in CONFIG-ROUTER-NEIGHBOR mode.

```
local-as as-number no-prepend
```

- Disable prepending the globally-configured AS number in CONFIG-ROUTER-NEIGHBOR mode.

```
local-as as-number no-prepend replace-as
```



## Selection criteria

Best path selection criteria for BGP attributes:

1. Prefer the path with the largest WEIGHT attribute, and prefer the path with the largest LOCAL\_PREF attribute.
2. Prefer the path that is locally originated using the `network` command, `redistribute` command, or `aggregate-address` command. Routes originated using a `network` or `redistribute` command are preferred over routes that originate with the `aggregate-address` command.
3. (Optional) If you configure the `bgp bestpath as-path ignore` command, skip this step because AS\_PATH is not considered. Prefer the path with the shortest AS\_PATH:
  - An AS\_SET has a path length of 1 no matter how many are in the set
  - A path with no AS\_PATH configured has a path length of 0
  - AS\_CONFED\_SET is not included in the AS\_PATH length
  - AS\_CONFED\_SEQUENCE has a path length of 1 no matter how many ASs are in the AS\_CONFED\_SEQUENCE
4. Prefer the path with the lowest ORIGIN type—IIGP is lower than EGP and EGP is lower than INCOMPLETE.
5. Prefer the path with the lowest multiexit discriminator (MED) attribute:
  - This comparison is only done if the first neighboring AS is the same in the two paths. The MEDs compare only if the first AS in the AS\_SEQUENCE is the same for both paths.
  - Configure the `bgp always-compare-med` command to compare MEDs for all paths.
  - Paths with no MED are treated as “worst” and assigned a MED of 4294967295.
6. Prefer external (EBGP) to internal (IBGP) paths or confederation EBGP paths, and prefer the path with the lowest IGP metric to the BGP next-hop.
7. The system deems the paths as equal and only performs the following steps if the criteria are not met:
  - Configure the IBGP multipath or EBGP multipath using the `maximum-path` command.
  - The paths being compared were received from the same AS with the same number of AS in the AS Path but with different next-hops.
  - The paths were received from IBGP or EBGP neighbor, respectively.
8. If you enable the `bgp bestpath router-id ignore` command and:
  - If the Router-ID is the same for multiple paths because the routes were received from the same route—skip this step.
  - If the Router-ID is **not** the same for multiple paths, prefer the path that was first received as the Best Path. The path selection algorithm returns without performing any of the checks detailed.
9. Prefer the external path originated from the BGP router with the lowest router ID. If both paths are external, prefer the oldest path—first received path. For paths containing an RR attribute, the originator ID is substituted for the router ID. If two paths have the same router ID, prefer the path with the lowest cluster ID length. Paths without a cluster ID length are set to a 0 cluster ID length.
10. Prefer the path originated from the neighbor with the lowest address. The neighbor address is used in the BGP neighbor configuration and corresponds to the remote peer used in the TCP connection with the local router.

In Non-Deterministic mode, the `bgp non-deterministic-med` command applies. Paths compare in the order they arrive. This method leads to system selection of different best paths from a set of paths. Depending on the order they were received from the neighbors, MED may or may not get compared between the adjacent paths. In Deterministic mode, the system compares MED. MED is compared between the adjacent paths within an AS group because all paths in the AS group are from the same AS.

## Weight and local preference

The weight attribute is local to the router and does not advertise to neighboring routers. If the router learns about more than one route to the same destination, the route with the highest weight is preferred. The route with the highest weight is installed in the IP routing table.

The local preference — LOCAL\_PREF represents the degree of preference within the entire AS. The higher the number, the greater the preference for the route.

LOCAL\_PREF is one of the criteria that determines the best path — other criteria may impact selection, see [Best path selection](#). Assume that LOCAL\_PREF is the only attribute applied and AS 100 has two possible paths to AS 200. Although the path through Router A is shorter, the LOCAL\_PREF settings have the preferred path going through Router B and AS 300. This advertises to all routers within AS 100, causing all BGP speakers to prefer the path through Router B.

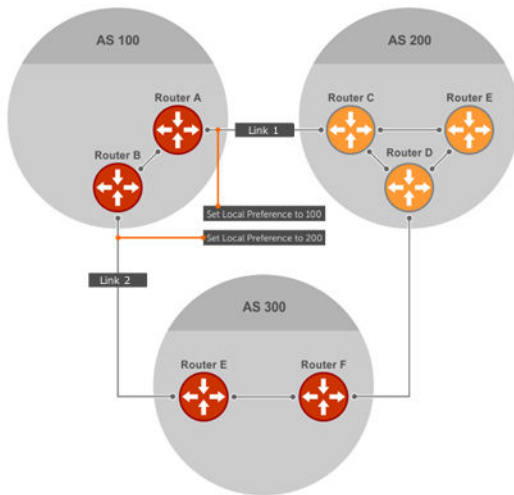

## Multixit discriminators

If two autonomous systems connect in more than one place, use a multixit discriminator (MED) to assign a preference to a preferred path. MED is one of the criteria used to determine best path—other criteria may also impact selection.

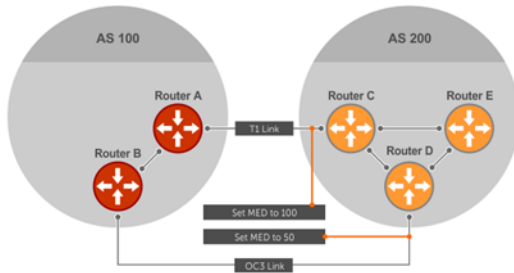

One AS assigns the MED a value. Other AS uses that value to decide the preferred path. Assume that the MED is the only attribute applied and there are two connections between AS 100 and AS 200. Each connection is a BGP session. AS 200 sets the MED for its Link 1 exit point to 100 and the MED for its Link 2 exit point to 50. This sets up a path preference through Link 2. The MEDs advertise to AS 100 routers so they know which is the preferred path.

MEDs are nontransitive attributes. If AS 100 sends the MED to AS 200, AS 200 does not pass it on to AS 300 or AS 400. The MED is a locally relevant attribute to the two participating AS — AS 100 and AS 200. The MEDs advertise across both links—if a link goes down, AS 100 has connectivity to AS 300 and AS 400.

## Origin

The origin indicates how the prefix came into BGP. There are three origin codes—IGP, EGP, and INCOMPLETE.

- IGP** Prefix originated from information learned through an IGP.
- EGP** Prefix originated from information learned from an EGP, which Next Generation Protocol (NGP) replaced.
- INCOMPLETE** Prefix originated from an unknown source.

An IGP indicator means that the route was derived inside the originating AS. EGP means that a route was learned from an external gateway protocol. An INCOMPLETE origin code results from aggregation, redistribution, or other indirect ways of installing routes into BGP.

The question mark (?) indicates an origin code of INCOMPLETE, and the lower case letter (i) indicates an origin code of IGP.

### Origin configuration

```
OS10# show ip bgp
BGP local RIB : Routes to be Added , Replaced , Withdrawn
BGP local router ID is 30.1.1.1
Status codes: s suppressed, S stale, d dampened, h history, * valid, > best
```

```

Path source: I - internal, a - aggregate, c - confed-external, r - redistributed
n - network S - stale
Origin codes: i - IGP, e - EGP, ? - incomplete

```

|     | Network    | Next Hop | Metric | LocPrf | Weight | Path |
|-----|------------|----------|--------|--------|--------|------|
| *>I | 1.1.1.0/24 | 17.1.1.2 | 0      | 0      | 0      | i    |
| *>I | 2.2.2.0/24 | 17.1.1.2 | 0      | 0      | 0      | ?    |
| *>I | 3.3.3.0/24 | 17.1.1.2 | 0      | 0      | 0      | e    |

## AS path and next-hop

The AS path is the AS list that all the prefixes that are listed in the update have passed through. The BGP speaker adds the local AS number when advertising to an EBGp neighbor. Any update that contains the AS path number 0 is valid.

The next-hop is the IP address that is used to reach the advertising router:

- For EBGp neighbors, the next-hop address is the IP address of the connection between neighbors.
- For IBGP neighbors, the EBGp next-hop address is carried into the local AS. A next hop attribute sets when a BGP speaker advertises itself to another BGP speaker outside the local AS and when advertising routes within an AS.

For EBGp neighbors, the next-hop address corresponding to a BGP route does not resolve if the next-hop address is not the same as the neighbor IP address. The next-hop attribute also serves as a way to direct traffic to another BGP speaker, instead of waiting for a speaker to advertise. When a next-hop BGP neighbor is unreachable, the connection to that BGP neighbor goes down after the hold-down timer expires.

When you enable `fast-external-fallover` and if the router has learned the routes from the BGP neighbor, the BGP session terminates immediately if the next-hop becomes unreachable, without waiting for the hold-down time.

## Best path selection

Best path selection selects the best route out of all paths available for each destination, and records each selected route in the IP routing table for traffic forwarding. Only valid routes are considered for best path selection. BGP compares all paths, in the order in which they arrive, and selects the best paths. Paths for active routes are grouped in ascending order according to their neighboring external AS number.

OS10 follows *deterministic* MED to select different best paths from a set of paths. This may depend on the order the different best paths are received from the neighbors — MED may or may not get compared between adjacent paths. BGP best path selection is deterministic by default.

The best path in each group is selected based on specific criteria—only one best path is selected at a time. If BGP receives more than one best path, it moves on to the next list of valid paths, and continues until it reaches the end of the list.

When you configure the `non-deterministic-med` command, paths are compared in the order they arrive. OS10 follows this method to select different best paths from a set of paths, depending on the order they were received from the neighbors—MED may or may not get compared between the adjacent paths.

By default, the `bestpath as-path multipath-relax` command is disabled. This prevents BGP from load-balancing a learned route across two or more EBGp peers. To enable load-balancing across different EBGp peers, enter the `bestpath as-path multipath-relax` command.

If you configure the `bgp bestpath as-path ignore` command and the `bestpath as-path multipath-relax` command simultaneously, an error message displays—only enable one command at a time.

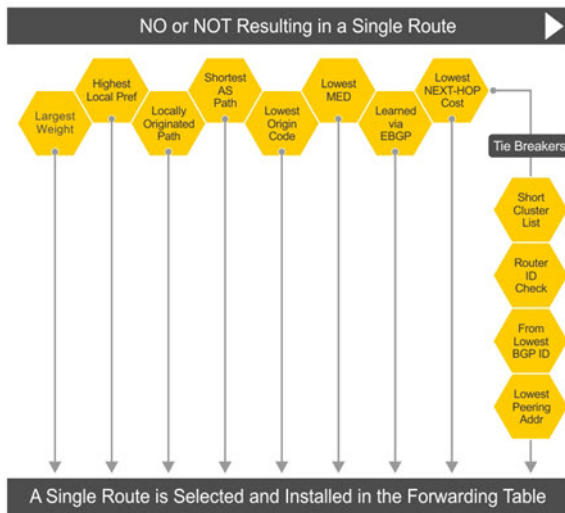

## More path support

More path (Add-Path) reduces convergence times by advertising multiple paths to its peers for the same address prefix without replacing existing paths with new ones. By default, a BGP speaker advertises only the best path to its peers for a given address prefix.

If the best path becomes unavailable, the BGP speaker withdraws its path from its local router information base (RIB) and recalculates a new best path. This situation requires both IGP and BGP convergence and is a lengthy process. BGP add-path also helps switch over to the next new best path when the current best path is unavailable.

The Add-Path capability to advertise more paths is supported only on IBGP peers—it is not supported on EBGP peers or BGP peer groups.

### Ignore router ID calculations

Avoid unnecessary BGP best path transitions between external paths under certain conditions. The `bestpath router-id ignore` command reduces network disruption that is caused by routing and forwarding plane changes and allows for faster convergence.

## Advertise cost

As the default process for redistributed routes, OS10 supports IGP cost as MED. Both autosummarization and synchronization are disabled by default.

### BGPv4 and BGPv6 support

- Deterministic MED, default
- A path with a missing MED is treated as worst path and assigned an `0xffffffff` MED value.
- Delayed configuration at system boot—OS10 reads the entire configuration file BEFORE sending messages to start BGP peer sessions.

## 4-Byte AS numbers

OS10 supports 4-byte AS number configurations by default. The 4-byte support is advertised as a new BGP capability - `4-BYTE-AS`, in the OPEN message. A BGP speaker that advertises 4-Byte-AS capability to a peer, and receives the same from that peer must encode AS numbers as 4-octet entities in all messages.

If the AS number of the peer is different, the 4-byte speaker brings up the neighbor session using a reserved 2-byte ASN, 23456 called `AS_TRANS`. The `AS_TRANS` is used to interop between a 2-byte and 4-byte AS number.

Where the 2-byte format is 1 to 65535, the 4-byte format is 1 to 4294967295. You can also enter AS numbers using the dotted decimal format. For example, you can enter 0.123.

## AS number migration

You can transparently change the AS number of an entire BGP network. Changing the AS number ensures that the routes propagate throughout the network while migration is in progress. When migrating one AS to another and combining multiple AS, an EBGP network may lose its routing to an IBGP if the AS number changes.

Migration is difficult as all IBGP and EBGP peers of the migrating network must be updated to maintain network reachability. Local-AS allows the BGP speaker to operate as if it belongs to a virtual AS network besides its physical AS network.

Disable the `local-as` command after migration. Failure to disable the `local-as` command after migration causes the `local-as` command to replace the original AS number of the system. Reconfigure the system with a new AS number.

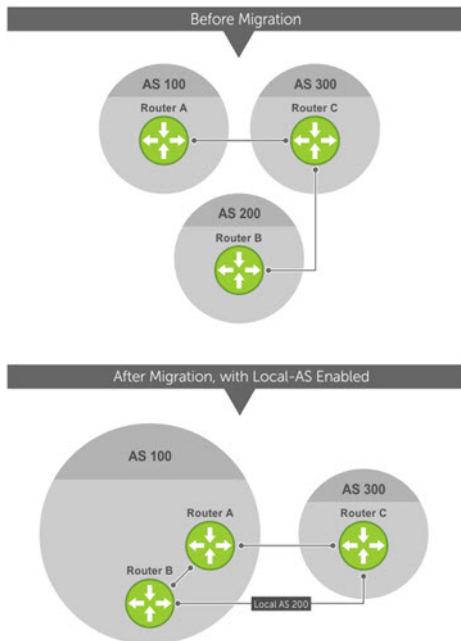

Router A, Router B, and Router C belong to AS 100, 200, and 300, respectively. Router A acquired Router B — Router B has Router C as its client. When Router B is migrating to Router A, it must maintain the connection with Router C without immediately updating Router C's configuration. Local-AS allows Router B to appear as if it still belongs to Router B's old network, AS 200, to communicate with Router C.

The Local-AS does not prepend the updates with the AS number received from the EBGP peer if you use the `no prepend` command. If you do not select `no prepend`, the default, the Local-AS adds to the first AS segment in the AS-PATH. If you use an inbound route-map to prepend the AS-PATH to the update from the peer, the Local-AS adds first.

If Router B has an inbound route-map applied on Router C to prepend `65001 65002` to the AS-PATH, these events take place on Router B:

- Receive and validate the update.
- Prepend `local-as 200` to AS-PATH.
- Prepend `65001 65002` to AS-PATH.

Local-AS prepends before the route map to give the appearance that the update passed through a router in AS 200 before it reaches Router B.

## Graceful restart

OS10 offers graceful restart capability for BGP in helper mode only.

A BGP router whose neighbor is restarting is called a "helper."

If graceful restart is enabled on the restarting router, during restart, the helper maintains the routes that it has learned from its neighbor.

After the switch over, the graceful restart operation begins. Both routers reestablish their neighbor relationship and exchange their BGP routes again. The helper continues to forward prefixes pointing to the restarting peer, and the restarting router continues to forward traffic to its peers even though those neighbor relationships are restarting. When the restarting router

receives all route updates from all BGP peers that are graceful restart capable, the graceful restart is complete. BGP sessions become operational again.

## Configure Border Gateway Protocol

BGP is disabled by default. To enable the BGP process and start to exchange information, assign an AS number and use commands in ROUTER-BGP mode to configure a BGP neighbor.

|                                        |                                                                                                                                                                   |
|----------------------------------------|-------------------------------------------------------------------------------------------------------------------------------------------------------------------|
| <b>BGP neighbor adjacency changes</b>  | All BGP neighbor changes are logged                                                                                                                               |
| <b>Fast external fallover</b>          | Enabled                                                                                                                                                           |
| <b>Graceful restart</b>                | Disabled                                                                                                                                                          |
| <b>Local preference</b>                | 100                                                                                                                                                               |
| <b>4-byte AS</b>                       | Enabled                                                                                                                                                           |
| <b>MED</b>                             | 0                                                                                                                                                                 |
| <b>Route flap dampening parameters</b> | <ul style="list-style-type: none"><li>• half-life = 15 minutes</li><li>• max-suppress-time = 60 minutes</li><li>• reuse = 750</li><li>• suppress = 2000</li></ul> |
| <b>Timers</b>                          | <ul style="list-style-type: none"><li>• keepalive = 60 seconds</li><li>• holdtime = 180 seconds</li></ul>                                                         |
| <b>Add-path</b>                        | Disabled                                                                                                                                                          |

## Enable BGP

Before enabling BGP, assign a BGP router ID to the switch using the following command:

- In the ROUTER BGP mode, enter the `router-id ip-address` command. Where in, `ip-address` is the IP address corresponding to a configured L3 interface (physical, loopback, or LAG).

BGP is disabled by default. The system supports one AS number — you must assign an AS number to your device. To establish BGP sessions and route traffic, configure at least one BGP neighbor or peer. In BGP, routers with an established TCP connection are called *neighbors* or *peers*. After a connection establishes, the neighbors exchange full BGP routing tables with incremental updates afterward. Neighbors also exchange the KEEPALIVE messages to maintain the connection.

You can classify BGP neighbor routers or peers as internal or external. Connect EBGp peers directly, unless you enable EBGp multihop — IBGP peers do not need direct connection. The IP address of an EBGp neighbor is usually the IP address of the interface directly connected to the router. The BGP process first determines if all internal BGP peers are reachable, then it determines which peers outside the AS are reachable.

1. Assign an AS number, and enter ROUTER-BGP mode from CONFIGURATION mode, from 1 to 65535 for 2-byte, 1 to 4294967295 for 4-byte. Only one AS number is supported per system. If you enter a 4-byte AS number, 4-byte AS support is enabled automatically.

```
router bgp as-number
```

2. Enter a neighbor in ROUTER-BGP mode.

```
neighbor ip-address
```

3. Add a remote AS in ROUTER-NEIGHBOR mode, from 1 to 65535 for 2-byte or 1 to 4294967295 for 4-byte.

```
remote-as as-number
```

4. Enable the BGP neighbor in ROUTER-NEIGHBOR mode.

```
no shutdown
```

5. (Optional) Add a description text for the neighbor in ROUTER-NEIGHBOR mode.

```
description text
```

To reset the configuration when you change the configuration of a BGP neighbor, use the `clear ip bgp *` command. To view the BGP status, use the `show ip bgp summary` command.

### Configure BGP

```
OS10# configure terminal
OS10(config)# router bgp 100
OS10(config-router-bgp-100)# neighbor 5.1.1.1
OS10(config-router-neighbor)# remote-as 1
OS10(config-router-neighbor)# no shutdown
OS10(config-router-neighbor)# description n1_abcd
OS10(config-router-neighbor)# exit
OS10(config-router-bgp-100)# template t1
OS10(config-router-template)# description peer_template_1_abcd
```

### View BGP summary with 2-byte AS number

```
OS10# show ip bgp summary

BGP router identifier 202.236.164.86 local AS number 64901
Neighbor AS MsgRcvd MsgSent Up/Down State/Pfx
120.10.1.1 64701 664 662 04:47:52 established 12000
```

### View BGP summary with 4-byte AS number

```
OS10# show ip bgp summary
BGP router identifier 11.1.1.1, local AS number 4294967295
BGP local RIB : Routes to be Added 0, Replaced 0, Withdrawn 0
1 neighbor(s) using 8192 bytes of memory

Neighbor AS MsgRcvd MsgSent TblVer InQ OutQ Up/Down State/Pfx
5.1.1.2 4294967295 0 0 0 0 0 00:00:00 Active
```

For the router ID, the system selects the first configured IP address or a random number. To view the status of BGP neighbors, use the `show ip bgp neighbors` command. For BGP neighbor configuration information, use the `show running-config bgp` command.

The example shows two neighbors — one is an external BGP neighbor; and the other is an internal BGP neighbor. The first line of the output for each neighbor displays the AS number and states if the link is external or internal.

The third line of the `show ip bgp neighbors` output contains the BGP state. If anything other than *established* displays, the neighbor is not exchanging information and routes. For more information, see [IPv6 commands](#).

### View BGP neighbors

```
OS10# show ip bgp neighbors
BGP neighbor is 5.1.1.1, remote AS 1, internal link
BGP version 4, remote router ID 6.1.1.1
BGP state established, in this state for 00:03:11
Last read 01:08:40 seconds, hold time is 180, keepalive interval is 60 seconds
Received 11 messages
3 opens, 1 notifications, 3 updates
4 keepalives, 0 route refresh requests
Sent 14 messages
3 opens, 1 notifications, 0 updates
10 keepalives, 0 route refresh requests

Minimum time between advertisement runs is 0 seconds
Description: n1_abcd
```

```
Capabilities received from neighbor for IPv4 Unicast:
MULTIPROTO_EXT(1)ROUTE_REFRESH(2)CISCO_ROUTE_REFRESH(128)
Capabilities advertised to neighbor for IPv4 Unicast:
MULTIPROTO_EXT(1)ROUTE_REFRESH(2)CISCO_ROUTE_REFRESH(128)
```

```
Prefixes accepted 3, Prefixes advertised 0
```

```
Connections established 3; dropped 2
Closed by neighbor sent 00:03:26 ago
```

```
Local host: 5.1.1.2, Local port: 43115
Foreign host: 5.1.1.1, Foreign port: 179
```

### View BGP running configuration

```
OS10# show running-configuration bgp
!
router bgp 100
!
neighbor 5.1.1.1
description nl_abcd
```

## Configuring BGP in a non-default VRF instance

To configure BGP in a non-default VRF instance.

1. Assign an AS number, and enter ROUTER-BGP mode from CONFIGURATION mode (1 to 65535 for 2-byte, 1 to 4294967295 for 4-byte). Only one AS number is supported per system. If you enter a 4-byte AS number, 4-byte AS support is enabled automatically.

```
router bgp as-number
```

2. Enter ROUTER-BGP-VRF mode to configure BGP in a non-default VRF instance.

```
vrf vrf-name
```

3. Enter a neighbor in CONFIG-ROUTER-VRF mode.

```
neighbor ip-address
```

4. Add a remote AS in ROUTER-NEIGHBOR mode, from 1 to 65535 for 2-byte or 1 to 4294967295 for 4-byte.

```
remote-as as-number
```

5. Enable the BGP neighbor in ROUTER-NEIGHBOR mode.

```
no shutdown
```

6. (Optional) Add a description text for the neighbor in ROUTER-NEIGHBOR mode.

```
description text
```

To reset the configuration when you change the configuration of a BGP neighbor, use the `clear ip bgp *` command. To view the BGP status, use the `show ip bgp summary` command.

### Configure BGP

```
OS10# configure terminal
OS10(config)# router bgp 100
OS10(config-router-bgp-100)# vrf blue
OS10(config-router-vrf)# neighbor 5.1.1.1
OS10(config-router-neighbor)# remote-as 1
OS10(config-router-neighbor)# description nl_abcd
OS10(config-router-neighbor)# exit
OS10(config-router-vrf)# template t1
OS10(config-router-template)# description peer_template_1_abcd
```



## BGP over unnumbered interfaces

As BGP relies on TCP for connection between peers, the interface that connects to the peer requires a unique IP address.

Assigning an IP address to every interface may exhaust the available pool of IP addresses and is error prone. Unnumbered interfaces are the interfaces without unique IP addresses. BGP unnumbered interfaces use the extended next hop encoding (ENHE) feature, which is defined by RFC 5549. BGP unnumbered interfaces can advertise IPv4 routes with an IPv6 next hop.

As IPv6 link-local addresses are automatically configured on connected interfaces, BGP uses these link-local addresses to form neighborhood. Unnumbered interfaces use IPv6 router advertisements to identify the address of the peer.

### Restrictions

- You cannot configure VRRP for IPv6 on an unnumbered interface. This configuration causes BGP session failure.
- You cannot use the default VLAN as the unnumbered VLAN.
- Route reflectors are not supported with unnumbered peers.
- Confederations are not supported with unnumbered peers.
- Dampening is not supported with unnumbered peers.

### Configure an unnumbered neighbor

To configure an unnumbered neighbor:

1. Create an interface, if required, in CONFIGURATION mode.

```
interface interface-type
```

`interface interface-type` — (Optional) Enter one of the following interface types:

- `ethernet node/slot/port[:subport]` — Display Ethernet interface information.
- `port-channel id-number` — Display port channel interface IDs, from 1 to 128.
- `vlan vlan-id` — Display the VLAN interface number, from 1 to 4093.

2. Enable RAs on the interface in INTERFACE mode.

```
ipv6 nd send-ra
```

3. Configure minimum and maximum RA intervals in INTERFACE mode.

```
ipv6 nd min-ra-interval 3
ipv6 nd max-ra-interval 4
```

4. Enable BGP on the device.

```
router bgp as-number
```

5. Enter an unnumbered neighbor in ROUTER-BGP mode.

```
neighbor interface interface-type
```

`interface interface-type` — (Optional) Enter one of the following interface types:

- `ethernet node/slot/port[:subport]` — Display Ethernet interface information.
- `port-channel id-number` — Display port channel interface IDs, from 1 to 128.
- `vlan vlan-id` — Display the VLAN interface number, from 1 to 4093.

6. Enable the BGP neighbor in ROUTER-NEIGHBOR mode.

```
no shutdown
```

### Example for configuring an unnumbered neighbor

```
OS10(config)# interface ethernet 1/1/1
OS10(conf-if-eth1/1/1)# ipv6 nd max-ra-interval 4
OS10(conf-if-eth1/1/1)# ipv6 nd min-ra-interval 3
OS10(conf-if-eth1/1/1)# ipv6 nd send-ra
OS10(conf-if-eth1/1/1)# no shutdown
OS10(conf-if-eth1/1/1)# exit
OS10(config)# router bgp 100
```

```
OS10(config-router-bgp-100)# neighbor interface ethernet 1/1/1
OS10(config-router-neighbor)# no shutdown
```

### Example outputs for viewing unnumbered BGP interfaces

```
OS10# show ip bgp
BGP local RIB : Routes to be Added , Replaced , Withdrawn
BGP local router ID is 14.233.209.106
Status codes: s suppressed, S stale, d dampened, h history, * valid, > best
Path source: I - internal, a - aggregate, c - confed-external,
r - redistributed/network, S - stale
Origin codes: i - IGP, e - EGP, ? - incomplete
 Network Next Hop Metric LocPrf Weight
Path
*>r 31.1.1.0/24 0.0.0.0 0 100
32768 ?
*> 41.1.1.0/24 ethernet 1/1/1 0 100
32768 ?
```

```
OS10# show ip bgp neighbors interface ethernet1/1/1

BGP neighbor is fe80::76e6:e2ff:fef6:b81 via ethernet1/1/1, remote AS 100, local AS 200
external link
 BGP version 4, remote router ID 125.12.57.117
 BGP state ESTABLISHED, in this state for 00:15:52
 Last read 00:21:08 seconds
 Hold time is 180, keepalive interval is 60 seconds
 Configured hold time is 180, keepalive interval is 60 seconds
 Fall-over disabled

Received 20 messages
 1 opens, 0 notifications, 0 updates
 19 keepalives, 0 route refresh requests
Sent 20 messages
 1 opens, 1 notifications, 0 updates
 18 keepalives, 0 route refresh requests
Minimum time between advertisement runs is 30 seconds
Minimum time before advertisements start is 0 seconds

Capabilities received from neighbor for IPv4 Unicast:
MULTIPROTO_EXT(1)
ROUTE_REFRESH(2)
CISCO_ROUTE_REFRESH(128)
4_OCTET_AS(65)
Extended Next Hop Encoding (5)
Capabilities advertised to neighbor for IPv4 Unicast:
MULTIPROTO_EXT(1)
ROUTE_REFRESH(2)
CISCO_ROUTE_REFRESH(128)
4_OCTET_AS(65)
Extended Next Hop Encoding (5)
Prefixes accepted 0, Prefixes advertised 0
Connections established 1; dropped 0
Last reset never
Prefixes ignored due to:
 Martian address 0, Our own AS in AS-PATH 0
 Invalid Nexthop 0, Invalid AS-PATH length 0
 Wellknown community 0, Locally originated 0

Local host: fe80::76e6:e2ff:fef5:b281, Local port: 45926
Foreign host: fe80::76e6:e2ff:fef6:b81, Foreign port: 179
```

## Configure Dual Stack

OS10 supports dual stack for BGPv4 and BGPv6. Dual stack BGP allows simultaneous exchange of the same IPv4 or IPv6 prefixes through different IPv4 and IPv6 peers. You can enable dual stack using the `activate` command in the corresponding address-family mode. By default, `activate` command is enabled for the IPv4 address family for all the neighbors.

If a BGP-v4 neighbor wants to carry ipv6 prefix information, it activates the IPv6 address-family. For a BGP-v6 neighbor to carry ipv4 prefix, it activates the IPv4 address-family.

1. Enable support for the IPv6 unicast family in CONFIG-ROUTER-BGP mode.

```
address family ipv6 unicast
```

2. Enable IPv6 unicast support on a BGP neighbor/template in CONFIG-ROUTER-BGP-AF mode.

```
activate
```

## Configure administrative distance

Routers use administrative distance to determine the best path between two or more routes to reach the same destination. Administrative distance indicates the reliability of the route; the lower the administrative distance, the more reliable the route. If the routing table manager (RTM) receives route updates from one or more routing protocols for a single destination, it chooses the best route based on the administrative distance.

You can assign an administrative distance for the following BGP routes using the `distance bgp` command:

- External BGP (eBGP) routes
- Internal BGP (iBGP) routes
- Local routes

If you do not configure the administrative distance for BGP routes, the following default values are used:

- eBGP—20
- iBGP—200
- local routes—200

To change the administrative distance for BGP, use the following command:

```
distance bgp external-distance internal-distance local-distance
```

### Configure administrative distance

1. Enable BGP and assign the AS number in CONFIGURATION mode, from 0.1 to 65535.65535 or 1 to 4294967295.

```
OS10# configure terminal
OS10(config)# router bgp 100
```

2. Use one of the following commands to enter the respective ADDRESS-FAMILY mode from ROUTER-BGP mode:

IPv4:

```
address-family ipv4 unicast
```

IPv6:

```
address-family ipv6 unicast
```

3. Change the administrative distance for BGP from the respective ADDRESS-FAMILY mode.

IPv4:

```
distance bgp 21 200 200
```

IPv6:

```
distance bgp 21 201 250
```

The following example provides the configuration for nondefault VRF:

```
OS10# configure terminal OS10(config)# router bgp 100
```

```
OS10(config-router-bgp-100)# vrf blue
OS10(config-router-bgp-100-vrf)# address-family ipv4 unicast
OS10(configure-router-bgpv4-vrf-af)# distance bgp 21 200 200
```

```
OS10(config-router-bgp-100-vrf)# address-family ipv6 unicast
OS10(configure-router-bgpv6-vrf-af)# distance bgp 21 201 250
```

## Peer templates

To configure multiple BGP neighbors at one time, create and populate a BGP peer template. An advantage of configuring peer templates is that members of a peer template inherit the configuration properties of the template and share the update policy. Always create a peer template and assign a name to it before adding members to the peer template. Create a peer template before configuring any route policies for the template.

1. Enable BGP, and assign the AS number to the local BGP speaker in CONFIGURATION mode, from 1 to 65535 for 2 bytes, 1 to 4294967295 | 0.1 to 65535.65535 for 4 bytes, or 0.1 to 65535.65535, in dotted format.

```
router bgp as-number
```

2. Create a peer template by assigning a neighborhood name to it in ROUTER-BGP mode.

```
template template-name
```

3. (Optional) Add a text description for the template in ROUTER-TEMPLATE mode.

```
description text
```

4. Enter Address Family mode in ROUTER-NEIGHBOR mode.

```
address-family {[ipv4 | ipv6] [unicast]}
```

5. Filter networks in routing updates, create a route-map, and assign a filtering criteria in ROUTER-BGP-NEIGHBOR-AF mode.

```
distribute-list prefix-list-name {in | out}
```

```
route-map map-name {in | out}
```

6. Add a neighbor as a remote AS in ROUTER-TEMPLATE mode, from 1 to 65535 for 2 bytes, 1 to 4294967295 | 0.1 to 65535.65535 for 4 byte, or 0.1 to 65535.65535, in dotted format.

```
neighbor ip-address
```

7. (Optional) Add a remote neighbor, and enter the AS number in ROUTER-TEMPLATE mode.

```
remote-as as-number
```

- To add an EBGp neighbor, configure the *as-number* parameter with a number different from the BGP *as-number* configured in the `router bgp as-number` command.
- To add an IBGP neighbor, configure the *as-number* parameter with the same BGP *as-number* configured in the `router bgp as-number` command.

**i** **NOTE:** When you configure an unnumbered interface, do not configure the remote AS number.

8. Assign a peer-template with a peer-group name from which to inherit to the neighbor in ROUTER-NEIGHBOR mode.

- For peers with an IP address:

```
inherit template template-name
```

- For peers with unnumbered interfaces:

```
inherit template template-name inherit-type {ebgp | ibgp}
```

9. Enable the neighbor in ROUTER-BGP mode.

```
no shutdown
```

A neighbor may keep its configuration after it is added to a peer group if the neighbor configuration is more specific than the peer group and if the neighbor configuration does not affect outgoing updates.

To display the peer-group configuration assigned to a BGP neighbor, use the `show ip bgp peer-group peer-group-name` command. The `show ip bgp neighbor` command output does not display peer-group configurations.

The following example shows a sample configuration:

### Configure peer templates

```
OS10# configure terminal
OS10(config)# router bgp 64601
OS10(config-router-bgp-64601)# template leaf_v4
OS10(config-router-template)# description peer_template_1_abcd
OS10(config-router-template)# address-family ipv4 unicast
OS10(config-router-bgp-template-af)# distribute-list leaf_v4_in in
OS10(config-router-bgp-template-af)# distribute-list leaf_v4_out out
OS10(config-router-bgp-template-af)# route-map set_aspath_prepend in
OS10(config-router-bgp-template-af)# exit
OS10(config-router-template)# exit
OS10(config-router-bgp-64601)# neighbor 100.5.1.1
OS10(config-router-neighbor)# inherit template leaf_v4
OS10(config-router-neighbor)# remote-as 64802
OS10(config-router-neighbor)# no shutdown
OS10(config-router-neighbor)# exit
OS10(config-router-bgp-64601)# neighbor 100.6.1.1
OS10(config-router-neighbor)# inherit template leaf_v4
OS10(config-router-neighbor)# remote-as 64802
OS10(config-router-neighbor)# no shutdown
```

### View peer group status

```
OS10# show ip bgp peer-group leaf_v4
Peer-group leaf_v4, remote AS 0
 BGP version 4
 Minimum time between advertisement runs is 30 seconds
 Description: peer_template_1_abcd
 For address family: Unicast
 BGP neighbor is leaf_v4, peer-group external
 Update packing has 4_OCTET_AS support enabled

Number of peers in this group 2
Peer-group members:
 100.5.1.1
 100.6.1.1
```

```
OS10# show ip bgp peer-group bg1
Peer-group bg1, remote AS 0
 BGP version 4
 Minimum time between advertisement runs is 30 seconds

For address family: Unicast
 BGP neighbor is bg1, peer-group external
 Update packing has 4_OCTET_AS support enabled

Number of peers in this group 2
Peer-group members:
 40.1.1.2

 ethernet 1/1/1
```

```
OS10# show ip bgp peer-group leaf_v4 summary
BGP router identifier 100.0.0.8 local AS number 64601
Neighbor AS MsgRcvd MsgSent Up/Down State/Pfx
100.5.1.1 64802 376 325 04:28:25 1251
100.6.1.1 64802 376 327 04:26:17 1251
```

```
OS10# show ip bgp peer-group bg1 summary
BGP router identifier 14.233.209.106 local AS number 10
Neighbor AS MsgRcvd MsgSent Up/Down State/Pfx
40.1.1.2 20 15 19 00:00:32 0
ethernet 1/1/1 20 15 19 00:00:32 0
```

## View running configuration

```
OS10# show running-configuration bgp
!
router bgp 64601
 bestpath as-path multipath-relax
 bestpath med missing-as-worst
 non-deterministic-med
 router-id 100.0.0.8
 !
 template leaf_v4
 description peer_template_1_abcd !
 address-family ipv4 unicast
 distribute-list leaf_v4_in in
 distribute-list leaf_v4_out out
 route-map set_aspath_prepend in
 !
 neighbor 100.5.1.1
 description leaf_connected_ebgp_neighbor
 bfd
 inherit template leaf_v4
 remote-as 64802
 no shutdown
 !
 neighbor 100.6.1.1
 description leaf_connected_ebgp_neighbor
 bfd
 inherit template leaf_v4
 remote-as 64802
 no shutdown
 !
```

## Peer templates for a nondefault VRF instance

You can create peer templates to add multiple neighbors at a time to the nondefault VRF instance that you create.

1. Enable BGP, and assign the AS number to the local BGP speaker in CONFIGURATION mode, from 1 to 65535 for 2 bytes, 1 to 4294967295 | 0.1 to 65535.65535 for 4 bytes, or 0.1 to 65535.65535, in dotted format.

```
router bgp as-number
```

2. Enter CONFIG-ROUTER-VRF mode to create a peer template for the nondefault VRF instance that you create.

```
vrf vrf-name
```

3. Create a peer template by assigning a neighborhood name to it in CONFIG-ROUTER-VRF mode.

```
template template-name
```

4. Add a neighbor as a remote AS in ROUTER-TEMPLATE mode, from 1 to 65535 for 2 bytes, 1 to 4294967295 | 0.1 to 65535.65535 for 4 bytes, or 0.1 to 65535.65535, in dotted format.

```
neighbor ip-address
```

5. Add a remote neighbor, and enter the AS number in ROUTER-TEMPLATE mode.

```
remote-as as-number
```

- To add an EBGP neighbor, configure the *as-number* parameter with a number different from the BGP *as-number* configured in the `router bgp as-number` command.
- To add an IBGP neighbor, configure the *as-number* parameter with the same BGP *as-number* configured in the `router bgp as-number` command.

6. (Optional) Add a text description for the template in ROUTER-TEMPLATE mode.

```
description text
```

7. Assign a peer-template with a peer-group name from which to inherit to the neighbor in ROUTER-NEIGHBOR mode.

- For peers with an IP address:

```
inherit template template-name
```

- For peers with unnumbered interfaces:

```
inherit template template-name inherit-type {ebgp | ibgp}
```

8. Enable the neighbor in ROUTER-BGP mode.

```
neighbor ip-address
```

9. Enable the peer-group in ROUTER-NEIGHBOR mode.

```
no shutdown
```

A neighbor may keep its configuration after it is added to a peer group if the neighbor configuration is more specific than the peer group and if the neighbor configuration does not affect outgoing updates.

To display the peer-group configuration that is assigned to a BGP neighbor, use the `show ip bgp peer-group peer-group-name` command. The `show ip bgp neighbor` command output does not display peer-group configurations.

### Configure peer templates

```
OS10(config)# router bgp 300
OS10(config-router-bgp-300) vrf blue
OS10(config-router-vrf)# template ebgppg
OS10(config-router-template)# remote-as 100
OS10(config-router-template)# description peer_template_1_abcd
OS10(config-router-template)# exit
OS10(config-router-vrf)# neighbor 3.1.1.1
OS10(config-router-neighbor)# inherit template ebgppg
OS10(config-router-neighbor)# no shutdown
```

## Neighbor fall-over

The BGP neighbor fall-over feature reduces the convergence time while maintaining stability. When you enable fall-over, BGP tracks IP reachability to the peer remote address and the peer local address.

When remote or peer local addresses become unreachable, BGP brings the session down with the peer. For example, if no active route exists in the routing table for peer IPv6 destinations/local address, BGP brings the session down.

By default, the hold time governs a BGP session. Configure BGP fast fall-over on a per-neighbor or peer-group basis. BGP routers typically carry large routing tables as frequent session resets are not desirable. If you enable fall-over, the connection to an internal BGP peer is immediately reset if the host route added to reach the internal peer fails.

1. Enter the neighbor IP address in ROUTER-BGP mode.

```
neighbor ip-address
```

2. Disable fast fall-over in ROUTER-NEIGHBOR mode.

```
no fall-over
```

3. Enter the neighbor IP address in ROUTER-BGP mode.

```
neighbor ip-address
```

4. Enable BGP fast fall-Over in ROUTER-NEIGHBOR mode.

```
fall-over
```

### Configure neighbor fall-over

```
OS10(config)# router bgp 100
OS10(config-router-bgp-100)# neighbor 3.1.1.1
OS10(config-router-neighbor)# remote-as 100
```

```
OS10(config-router-neighbor)# fall-over
OS10(config-router-neighbor)# no shutdown
```

### Verify neighbor fall-over on neighbor

```
OS10(config-router-neighbor)# do show ip bgp neighbors 3.1.1.1
BGP neighbor is 3.1.1.1, remote AS 100, local AS 100 internal link

BGP version 4, remote router ID 3.3.3.33
BGP state ESTABLISHED, in this state for 00:17:17
Last read 00:27:54 seconds
Hold time is 180, keepalive interval is 60 seconds
Configured hold time is 180, keepalive interval is 60 seconds
Fall-over enabled

Received 23 messages
 1 opens, 0 notifications, 1 updates
 21 keepalives, 0 route refresh requests
Sent 21 messages
 1 opens, 0 notifications, 0 updates
 20 keepalives, 0 route refresh requests
Minimum time between advertisement runs is 30 seconds
Minimum time before advertisements start is 0 seconds
Capabilities received from neighbor for IPv4 Unicast:
 MULTIPROTO_EXT(1)
 ROUTE_REFRESH(2)
 CISCO_ROUTE_REFRESH(128)
 4_OCTET_AS(65)
Capabilities advertised to neighbor for IPv4 Unicast:
 MULTIPROTO_EXT(1)
 ROUTE_REFRESH(2)
 CISCO_ROUTE_REFRESH(128)
 4_OCTET_AS(65)
Prefixes accepted 3, Prefixes advertised 0
Connections established 1; dropped 0
Last reset never
For address family: IPv4 Unicast
 Allow local AS number 0 times in AS-PATH attribute
 Prefixes ignored due to:
 Martian address 0, Our own AS in AS-PATH 0
 Invalid Nexthop 0, Invalid AS-PATH length 0
 Wellknown community 0, Locally originated 0

For address family: IPv6 Unicast
 Allow local AS number 0 times in AS-PATH attribute
Local host: 3.1.1.3, Local port: 58633
Foreign host: 3.1.1.1, Foreign port: 179
```

### Verify neighbor fall-over on peer-group

```
OS10# show running-configuration

!
router bgp 102
!
address-family ipv4 unicast
 aggregate-address 6.1.0.0/16
!
neighbor 40.1.1.2
 inherit template bgppg
 no shutdown
!
neighbor 60.1.1.2
 inherit template bgppg
 no shutdown
!
neighbor 32.1.1.2
 remote-as 100
 no shutdown
!
template bgppg
 fall-over
```



```
remote-as 102
!
```

## Configure password

You can enable message digest 5 (MD5) authentication with a password on the TCP connection between two BGP neighbors.

Configure the same password on both BGP peers. When you configure MD5 authentication between two BGP peers, each segment of the TCP connection is verified and the MD5 digest is checked on every segment sent on the TCP connection. Configuring a password for a neighbor establishes a new connection.

 **NOTE:** You can secure the VTEP neighbor communications as well using the MD5 authentication.

### Configure password

- Configure the password in both the BGP peers in ROUTER-NEIGHBOR CONFIGURATION or ROUTER-TEMPLATE CONFIGURATION mode. The password provided in ROUTER-NEIGHBOR mode takes preference over the password in ROUTER-TEMPLATE mode. Enter the password either as plain text or in encrypted format.

- `password {9 encrypted password-string|password-string}`

### View password configuration

- `show configuration`

#### Peer 1 in ROUTER-NEIGHBOR mode

```
OS10# configure terminal
OS10(config)# interface ethernet 1/1/5
OS10(conf-if-eth1/1/5)# no switchport
OS10(conf-if-eth1/1/5)# ip address 11.1.1.1/24
OS10(conf-if-eth1/1/5)# router bgp 10
OS10(config-router-bgp-10)# neighbor 11.1.1.2
OS10(config-router-neighbor)# no shutdown
OS10(config-router-neighbor)# remote-as 10
OS10(config-router-neighbor)# password abcdell
```

#### Peer 1 in ROUTER-TEMPLATE mode

```
OS10# configure terminal
OS10(config)# interface ethernet 1/1/5
OS10(conf-if-eth1/1/5)# no switchport
OS10(conf-if-eth1/1/5)# ip address 11.1.1.1/24
OS10(conf-if-eth1/1/5)# router bgp 10
OS10(config-router-bgp-10)# template pass
OS10(config-router-template)# password 9
f785498c228f365898c0efdc2f476b4b27c47d972c3cd8cd9b91f518c14ee42d
OS10(config-router-template)# exit
OS10(config-router-bgp-10)# neighbor 11.1.1.2
OS10(config-router-neighbor)# inherit template pass
```

### View password configuration in peer 1

```
OS10(config-router-neighbor)# show configuration
!
neighbor 11.1.1.2
password 9 0fbelad397712f74f4df903b4ff4b7b6e22cc377180432d7523a70d403d41565
remote-as 10
no shutdown
```

```
OS10(config-router-neighbor)# do show running-configuration bgp
!
router bgp 10
!
template pass
password 9 f785498c228f365898c0efdc2f476b4b27c47d972c3cd8cd9b91f518c14ee42d
!
neighbor 11.1.1.2
inherit template pass
```

```
password 9 01320afb39f49134882b0a9814fe6e8e228f616f60a35958844775314c00f0e5
remote-as 10
no shutdown
```

### Peer 2 in ROUTER-NEIGHBOR mode

```
OS10# configure terminal
OS10(config)# interface ethernet 1/1/5
OS10(config-if-eth1/1/5)# no switchport
ip OS10(config-if-eth1/1/5)# ip address 11.1.1.2/24
OS10(config-if-eth1/1/5)# router bgp 20
OS10(config-router-bgp-20)# neighbor 11.1.1.1
OS10(config-router-neighbor)# no shutdown
OS10(config-router-neighbor)# remote-as 20
OS10(config-router-neighbor)# password abcdell
```

### Peer 2 in ROUTER-TEMPLATE mode

```
OS10# configure terminal
OS10(config)# interface ethernet 1/1/5
OS10(config-if-eth1/1/5)# no switchport
OS10(config-if-eth1/1/5)# ip address 11.1.1.2/24
OS10(config-if-eth1/1/5)# router bgp 20
OS10(config-router-bgp-20)# template pass
OS10(config-router-template)# password 9
f785498c228f365898c0efdc2f476b4b27c47d972c3cd8cd9b91f518c14ee42d
OS10(config-router-template)# exit
OS10(config-router-bgp-20)# neighbor 11.1.1.1
OS10(config-router-neighbor)# inherit template pass
```

### View password configuration in peer 2

```
OS10(config-router-neighbor)# show configuration
!
neighbor 11.1.1.1
password 9 0fbc1ad397712f74f4df903b4fff4b7b6e22cc377180432d7523a70d403d41565
remote-as 20
no shutdown
```

```
OS10(config-router-neighbor)# do show running-configuration bgp
!
router bgp 20
neighbor 11.1.1.2
password 9 f785498c228f365898c0efdc2f476b4b27c47d972c3cd8cd9b91f518c14ee42d
remote-as 20
no shutdown
```

## Fast external fallover

Fast external fallover terminates EBGP sessions of any directly adjacent peer if the link used to reach the peer goes down. BGP does not wait for the hold-down timer to expire.

Fast external fallover is enabled by default. To disable or re-enable it, use the `[no] fast-external-fallover` command. For the `fast-external-fallover` command to take effect on an established BGP session, you must reset the session using the `clear ip bgp {* | peer-ipv4-address | peer-ipv6-address}` command.

### View fast external fallover configuration

```
OS10(config)# do show running-configuration bgp
!
router bgp 300
!
neighbor 3.1.1.1
remote-as 100
no shutdown
!
neighbor 3::1
remote-as 100
```

```

no shutdown
!
address-family ipv6 unicast
activate
OS10(config)# interface ethernet 1/1/1
OS10(conf-if-eth1/1/1)# show configuration
!
interface ethernet1/1/1
ip address 3.1.1.3/24
no switchport
no shutdown
ipv6 address 3::3/64
OS10(conf-if-eth1/1/1)# shutdown
OS10(conf-if-eth1/1/1)# do show ip bgp summary
BGP router identifier 11.11.11.11 local AS number 300
Neighbor AS MsgRcvd MsgSent Up/
Down State/Pfx
3.1.1.1 100 6 6
00:00:15 Active
3::1 100 8 11
00:00:15 Active
OS10(conf-if-eth1/1/1)#

```

### View fast external fallover unconfiguration

```

OS10(config-router-bgp-300)# do show running-configuration bgp
!
router bgp 300
no fast-external-fallover
!
neighbor 3.1.1.1
remote-as 100
no shutdown
!
neighbor 3::1
remote-as 100
no shutdown
!
address-family ipv6 unicast
activate
OS10(config-router-bgp-300)#
OS10(conf-if-eth1/1/1)# do clear ip bgp *
OS10# show ip bgp summary
BGP router identifier 11.11.11.11 local AS number 300
Neighbor AS MsgRcvd MsgSent Up/Down State/Pfx

3.1.1.1 100 7 4 00:00:08 3
3::1 100 9 5 00:00:08 4
OS10#
OS10(config)# interface ethernet 1/1/1
OS10(conf-if-eth1/1/1)# shutdown
OS10(conf-if-eth1/1/1)# do show ip bgp summary
BGP router identifier 11.11.11.11 local AS number 300
Neighbor AS MsgRcvd MsgSent Up/Down State/Pfx

3.1.1.1 100 7 4 00:00:29 3
3::1 100 9 5 00:00:29 4
OS10(conf-if-eth1/1/1)#
OS10(config-router-bgp-neighbor-af)# Apr 27 01:39:03 OS10 dn_sm[2065]: Node.1-
Unit.1:PRI:alert [os10:event],
%Dell EMC (OS10) %BGP_NBR_BKWD_STATE_CHG: Backward state change occurred Hold Time
expired for Nbr:3.1.1.3 VRF:default
Apr 27 01:39:03 OS10 dn_sm[2065]: Node.1-Unit.1:PRI:alert [os10:event], %Dell EMC
(OS10) %BGP_NBR_BKWD_STATE_CHG: Backward
state change occurred Hold Time expired for Nbr:3::3 VRF:default

```

## Passive peering

When you enable a peer-template, the system sends an OPEN message to initiate a TCP connection. If you enable passive peering for the peer template, the system does not send an OPEN message but responds to an OPEN message.

When a BGP neighbor connection with authentication rejects a passive peer-template, the system prevents another passive peer-template on the same subnet from connecting with the BGP neighbor. To work around this constraint, change the BGP configuration or change the order of the peer template configuration.

You can restrict the number of passive sessions the neighbor accepts using the `limit` command.

1. Enable BGP and assign the AS number to the local BGP speaker in CONFIGURATION mode (1 to 65535 for 2-byte, 1 to 4294967295 for 4-byte).

```
router bgp as-number
```

2. Configure a template that does not initiate TCP connections with other peers in ROUTER-BGP mode. A maximum of 16 characters.

```
template template-name
```

3. Create and enter the AS number for the remote neighbor in ROUTER-BGP-TEMPLATE mode (1 to 4294967295).

```
remote-as as-number
```

4. Enable peer listening and enter the maximum dynamic peers count in ROUTER-BGP-TEMPLATE mode (1 to 4294967295).

```
listen neighbor ip-address limit
```

Only after the peer template responds to an OPEN message sent on the subnet does the state of its BGP change to ESTABLISHED. After the peer template is ESTABLISHED, the peer template is the same as any other peer template, see [Peer templates](#).

If you do not configure a BGP device in Peer-Listening mode, a session with a dynamic peer comes up. Passwords are not supported on BGPv4/v6 dynamic peers.

### Configure passive peering

```
OS10(config)# router bgp 10
OS10(conf-router-bgp-10)# template bgppg
OS10(conf-router-template)# remote-as 100
OS10(conf-router-template)# listen 32.1.0.0/8 limit 10
```

## Local AS

During BGP network migration, you can maintain existing AS numbers. Reconfigure your routers with the new information to disable after the migration. Network migration is not supported on passive peer templates. You must configure [Peer templates](#) before assigning it to an AS.

The following options are available with the `local-as` command:

To append the `global-as` and `local-as` in the outbound AS\_PATH for the neighbor, use:

```
local-as as-number
```

To not add the `local-as` to prefixes received from the BGP neighbor, use:

```
local-as as-number no-prepend
```

To not add the `global AS number` in the outbound AS\_PATH for that neighbor, use:

```
local-as as-number no-prepend replace-as
```

1. Enter a neighbor IP address, A.B.C.D, in ROUTER-BGP mode.

```
neighbor ip-address
```

2. Enter a local-as number for the peer, and the AS values not prepended to announcements from the neighbors in ROUTER-NEIGHBOR mode (1 to 4294967295).

```
local-as as number [no prepend]
```

- Return to ROUTER-BGP mode.

```
exit
```

- Enter a template name to assign to the peer-groups in ROUTER-BGP mode. A maximum of 16 characters.

```
template template-name
```

- Enter a local-as number for the peer in ROUTER-TEMPLATE mode.

```
local-as as number [no prepend]
```

- Add a remote AS in ROUTER-TEMPLATE mode (1 to 65535 for 2 bytes, 1 to 4294967295 for 4 bytes).

```
remote-as as-number
```

### Allow external routes from neighbor

```
OS10(config)# router bgp 10
OS10(conf-router-bgp-10)# neighbor 32.1.1.2
OS10(conf-router-neighbor)# local-as 50
OS10(conf-router-neighbor)# exit
OS10(conf-router-bgp-10)# template bgppg1
OS10(conf-router-template)# fall-over
OS10(conf-router-template)# local-as 400
OS10(conf-router-template)# remote-as 102
```

### Local AS number disabled

```
OS10(config)# router bgp 102
OS10(conf-router-bgp-102)# neighbor 32.1.1.2
OS10(conf-router-neighbor)# no local-as 100
```

## AS number limit

Sets the number of times an AS number occurs in an AS path. The `allow-as` parameter permits a BGP speaker to allow the AS number for a configured number of times in the updates received from the peer.

The AS-PATH loop is detected if the local AS number is present more than the number of times in the command.

- Enter the neighbor IP address to use the AS path in ROUTER-BGP mode.

```
neighbor ip address
```

- Enter Address Family mode in ROUTER-NEIGHBOR mode.

```
address-family {{ipv4 | ipv6} unicast | l2vpn evpn}
```

- Allow the neighbor IP address to use the AS path the specified number of times in ROUTER-BGP-NEIGHBOR-AF mode (1 to 10).

```
allowas-in number
```

### Configure AS number appearance

```
OS10(config)# router bgp 10
OS10(conf-router-bgp-10)# neighbor 1.1.1.2
OS10(conf-router-neighbor)# address-family ipv4 unicast
OS10(conf-router-bgp-neighbor-af)# allowas-in 5
```

### View AS numbers in AS paths

```
OS10# show running-configuration bgp
!
router bgp 101
 no fast-external-fallover
!
address-family ipv4 unicast
```

```

dampening
!
neighbor 17.1.1.2
 remote-as 102
 no shutdown
!
address-family ipv4 unicast
 allowas-in 4

```

## Show IP BGP

```

OS10(config)# router bgp 100
OS10(config-router-bgp-100)# neighbor 172:16:1::2
OS10(config-router-neighbor)# remote-as 100
OS10(config-router-neighbor)# no shutdown
OS10(config-router-neighbor)# address-family ipv6 unicast
OS10(config-router-bgp-neighbor-af)# activate
OS10(config-router-bgp-neighbor-af)# allowas-in 1
OS10(config-router-bgp-neighbor-af)# end
OS10# show running-configuration bgp
!
router bgp 100
!
neighbor 172:16:1::2
 remote-as 100
 no shutdown
!
address-family ipv6 unicast
 activate
 allowas-in 1
OS10# show ip bgp
BGP local RIB : Routes to be Added , Replaced , Withdrawn
BGP local router ID is 100.1.1.1
Status codes: s suppressed, S stale, d dampened, h history, * valid, > best
Path source: I - internal, a - aggregate, c - confed-external,
r - redistributed/network, S - stale
Origin codes: i - IGP, e - EGP, ? - incomplete

```

|     | Network       | Next Hop    | Metric | LocPrf | Weight | Path            |
|-----|---------------|-------------|--------|--------|--------|-----------------|
| *>I | 55::/64       | 172:16:1::2 | 0      | 0      | 0      | 100 200 300 400 |
| i   |               |             |        |        |        |                 |
| *>I | 55:0:0:1::/64 | 172:16:1::2 | 0      | 0      | 0      | 100 200 300 400 |
| i   |               |             |        |        |        |                 |
| *>I | 55:0:0:2::/64 | 172:16:1::2 | 0      | 0      | 0      | 100 200 300 400 |
| i   |               |             |        |        |        |                 |

## Redistribute routes

Add routes from other routing instances or protocols to the BGP process. You can include OSPF, static, or directly connected routes in the BGP process with the `redistribute` command.

- Include directly connected or user-configured (static) routes in ROUTER-BGP-AF mode.

```
redistribute {connected | static}
```

- Include specific OSPF routes in IS-IS in ROUTER-BGP-AF mode (1 to 65535).

```
redistribute ospf process-id
```

### Disable redistributed routes

```
OS10(conf-router-bgp-af)# no redistribute ospf route-map ospf-to-bgp
```

### Redistribute routes - Example

```

OS10(config)# router bgp 102
OS10(config-router-bgp-102)# address-family ipv4 unicast
OS10(configure-router-bgpv4-af)# redistribute ospf 12

```

## Additional paths

The `add-path` command is disabled by default.

1. Assign an AS number in CONFIGURATION mode.

```
router bgp as-number
```

2. Enter a neighbor and IP address (A.B.C.D) in ROUTER-BGP mode.

```
neighbor ip-address
```

3. Enter Address Family mode in ROUTER-NEIGHBOR mode.

```
address-family {[ipv4 | ipv6] [unicast]}
```

4. Allow the specified neighbor to send or receive multiple path advertisements in ROUTER-BGP mode. The `count` parameter controls the number of paths that are advertised — not the number of paths received.

```
add-path [both | received | send] count
```

### Enable additional paths

```
OS10(config)# router bgp 102
OS10(config-router-bgp-102)# neighbor 32.1.1.2
OS10(config-router-neighbor)# address-family ipv4 unicast
OS10(config-router-bgp-neighbor-af)# add-path both 3
```

## MED attributes

OS10 uses the MULTI\_EXIT\_DISC or MED attribute when comparing EBGP paths from the same AS. MED comparison is not performed in paths from neighbors with different AS numbers.

1. Enable MED comparison in the paths from neighbors with different AS in ROUTER-BGP mode.

```
always-compare-med
```

2. Change the best path MED selection in ROUTER-BGP mode.

```
bestpath med {confed | missing-as-best}
```

- `confed`—Selects the best path MED comparison of paths learned from BGP confederations.
- `missing-as-best`—Treats a path missing an MED as the most preferred one.
- `missing-as-worst`—Treats a path missing an MED as the least preferred one.

### Modify MED attributes

```
OS10(config)# router bgp 100
OS10(config-router-bgp-100)# always-compare-med
OS10(config-router-bgp-100)# bestpath med confed
```

## Local preference attribute

You can change the value of the LOCAL\_PREFERENCE attributes for all routes the router receives. To change the LOCAL\_PREF value in ROUTER-BGP mode from 0 to 4294967295 with default 100, use the `default local preference value` command.

To view the BGP configuration, use the `show running-configuration` command. A more flexible method for manipulating the LOCAL\_PREF attribute value is to use a route-map.

1. Assign a name to a route map in CONFIGURATION mode.

```
route-map map-name {permit | deny | sequence-number}
```

2. Change the LOCAL\_PREF value for routes meeting the criteria of this route map in ROUTE-MAP mode, then return to CONFIGURATION mode.

```
set local-preference value
exit
```

3. Enter ROUTER-BGP mode.

```
router bgp as-number
```

4. Enter the neighbor to apply the route map configuration in ROUTER-BGP mode.

```
neighbor {ip-address}
```

5. Apply the route map to the neighbor's incoming or outgoing routes in ROUTER-BGP-NEIGHBOR-AF mode.

```
route-map map-name {in | out}
```

6. Enter the peer group to apply the route map configuration in ROUTER-BGP mode.

```
template template-name
```

7. Apply the route map to the peer group's incoming or outgoing routes in CONFIG-ROUTER-TEMPLATE-AF mode.

```
route-map map-name {in | out}
```

### Configure and view local preference attribute

```
OS10(config)# route-map bgproutemap 1
OS10(conf-route-map)# set local-preference 500
OS10(conf-route-map)# exit
OS10(config)# router bgp 10
OS10(conf-router-bgp-10)# neighbor 10.1.1.4
OS10(conf-router-neighbor)# address-family ipv4 unicast
OS10(conf-router-bgp-neighbor-af)# route-map bgproutemap in
```

```
OS10 configure terminal
OS10(config)# route-map bgproutemap 1
OS10(conf-route-map)# set local-preference 500
OS10(conf-route-map)# exit
OS10(config)# router bgp 64601
OS10(conf-router-bgp-64601)# template bgppg
OS10(conf-router-template)# address-family ipv4 unicast
OS10(conf-router-bgp-template-af)# route-map bgproutemap in
```

### View route-map

```
OS10(conf-route-map)# do show route-map
route-map bgproutemap, permit, sequence 1
Match clauses:
Set clauses:
 local-preference 500
 metric 400
 origin incomplete
```

## Weight attribute

You can influence the BGP routing based on the weight value. Routes with a higher weight value have preference when multiple routes to the same destination exist.

1. Assign a weight to the neighbor connection in ROUTER-BGP mode.

```
neighbor {ip-address}
```

2. Set a weight value for the route in ROUTER-NEIGHBOR mode (1 to 4294967295, default 0).

```
weight weight
```



- Return to ROUTER-BGP mode.

```
exit
```

- Assign a weight value to the peer-group in ROUTER-BGP mode.

```
template template name
```

- Set a weight value for the route in ROUTER-TEMPLATE mode.

```
weight weight
```

### Modify weight attribute

```
OS10(config)# router bgp 10
OS10(config-router-bgp-10)# neighbor 10.1.1.4
OS10(config-router-neighbor)# weight 400
OS10(config-router-neighbor)# exit
OS10(config-router-bgp-10)# template zanzibar
OS10(config-router-template)# weight 200
```

## Enable multipath

You can have one path to a destination by default, and enable multipath to allow up to 64 parallel paths to a destination. The `show ip bgp network` command includes multipath information for that network.

- Configure the number of ECMP groups in CONFIGURATION.

```
ip ecmp-group maximum-paths number
```

- Enable multiple parallel paths in ROUTER-BGP mode.

```
maximum-paths {ebgp | ibgp} number
```

### Enable multipath

```
OS10(config)# ip ecmp-group maximum-paths 12
OS10(config)# router bgp 10
OS10(conf-router-bgp-10)# maximum-paths ebgp 10
```

## Route-map filters

Filtering routes allows you to implement BGP policies. Use route-maps to control which routes the BGP neighbor or peer group accepts and advertises.

- Enter the neighbor IP address to filter routes in ROUTER-BGP mode.

```
neighbor ipv4-address
```

- Enter Address Family mode in ROUTER-NEIGHBOR mode.

```
address-family {[ipv4 | ipv6] [unicast]}
```

- Create a route-map and assign a filtering criteria in ROUTER-BGP-NEIGHBOR-AF mode, then return to CONFIG-ROUTER-BGP mode.

```
route-map map-name {in | out}
exit
```

- `in`—Enter a filter for incoming routing updates.
  - `out`—Enter a filter for outgoing routing updates.
- Enter a peer template name in ROUTER-BGP mode.

```
template template-name
```

5. Enter Address Family mode.

```
address-family {[ipv4 | ipv6] [unicast]}
```

6. Create a route-map, and assign a filtering criteria in ROUTER-BGP-TEMPLATE-AF mode.

```
route-map map-name {in | out}
```

### Filter BGP route

```
OS10(config)# router bgp 102
OS10(conf-router-bgp-102)# neighbor 40.1.1.2
OS10(conf-router-neighbor)# address-family ipv4 unicast
OS10(conf-router-bgp-neighbor-af)# route-map metro in
OS10(conf-router-bgp-neighbor-af)# exit
OS10(conf-router-bgp-102)# template ebgp
OS10(conf-router-template)# address-family ipv4 unicast
OS10(conf-router-bgp-template-af)# route-map metro in
```

## Route reflector clusters

BGP route reflectors are intended for ASs with a large mesh. They reduce the amount of BGP control traffic. With route reflection configured properly, IBGP routers are not fully meshed within a cluster but all receive routing information.

Configure clusters of routers where one router is a concentration router and the others are clients who receive their updates from the concentration router.

1. Assign an ID to a router reflector cluster in ROUTER-BGP mode. You can have multiple clusters in an AS.

```
cluster-id cluster-id
```

2. Assign a neighbor to the router reflector cluster in ROUTER-BGP mode.

```
neighbor {ip-address}
```

3. Configure the neighbor as a route-reflector client in ROUTER-NEIGHBOR mode, then return to ROUTER-BGP mode.

```
route-reflector-client
exit
```

4. Assign a peer group template as part of the route-reflector cluster in ROUTER-BGP mode.

```
template template-name
```

5. Configure the template as the route-reflector client in ROUTER-TEMPLATE mode.

```
route-reflector-client
```

When you enable a route reflector, the system automatically enables route reflection to all clients. To disable route reflection between all clients in this reflector, use the `no bgp client-to-client reflection` command in ROUTER-BGP mode. You must fully mesh all the clients before you disable route reflection.

### Configure BGP route reflector

```
OS10(config)# router bgp 102
OS10(conf-router-bgp-102)# cluster-id 4294967295
OS10(conf-router-bgp-102)# neighbor 32.1.1.2
OS10(conf-router-neighbor)# route-reflector-client
OS10(conf-router-neighbor)# exit
OS10(conf-router-bgp-102)# template zanzibar
OS10(conf-router-template)# route-reflector-client
```

## Aggregate routes

OS10 provides multiple ways to aggregate routes in the BGP routing table. At least one route of the aggregate must be in the routing table for the configured aggregate route to become active. AS\_SET includes AS\_PATH and community information from the routes that are included in the aggregated route.

1. Assign an AS number in CONFIGURATION mode.

```
router bgp as-number
```

2. Enter Address Family mode in ROUTER-BGP mode.

```
address-family {[ipv4 | ipv6] [unicast]}
```

3. Aggregate address in ROUTER-BGPv4-AF mode.

```
aggregate-address ip-address/mask
```

### Configure aggregate routes

```
OS10(config)# router bgp 105
OS10(conf-router-bgp-105)# address-family ipv4 unicast
OS10(conf-router-bgpv4-af)# aggregate-address 3.3.0.0/16
```

### View running configuration

```
OS10(conf-router-bgpv4-af)# do show running-configuration bgp
! Version
! Last configuration change at Jul 27 06:51:17 2016
!
!
router bgp 105
!
address-family ipv4 unicast
aggregate-address 3.3.0.0/16
!

neighbor 32.1.1.2
remote-as 104
no shutdown
!
address-family ipv4 unicast
```

## Confederations

Another way to organize routers within an AS and reduce the mesh for IBGP peers is to configure BGP confederations. As with route reflectors, Dell EMC recommends BGP confederations only for IBGP peering involving many IBGP peering sessions per router.

When you configure BGP confederations, you break the AS into smaller sub-ASs. To devices outside your network, the confederations appear as one AS. Within the confederation sub-AS, the IBGP neighbors are fully meshed and the MED, NEXT\_HOP, and LOCAL\_PREF attributes maintain between confederations.

1. Enter the confederation ID AS number in ROUTER-BGP mode (1 to 65535 for 2-byte, 1 to 4294967295 for 4-byte).

```
confederation identifier as-number
```

2. Enter which confederation sub-AS are peers in ROUTER-BGP mode, from 1 to 65535 for 2-byte, 1 to 4294967295 for 4-byte. All Confederation routers must be either 4 bytes or 2 bytes. You cannot have a mix of router ASN support.

```
confederation peers as-number [... as-number]
```

### Configure BGP confederations

```
OS10(config)# router bgp 65501
OS10(conf-router-bgp-65501)# confederation identifier 100
OS10(conf-router-bgp-65501)# confederation peers 65502 65503 65504
```

```

OS10(conf-router-bgp-65501)# neighbor 1.1.1.2
OS10(conf-router-neighbor)# remote-as 65502
OS10(conf-router-neighbor)# no shutdown
OS10(conf-router-neighbor)# exit
OS10(conf-router-bgp-65501)# neighbor 2.1.1.2
OS10(conf-router-neighbor)# remote-as 65503
OS10(conf-router-neighbor)# no shutdown
OS10(conf-router-neighbor)# exit
OS10(conf-router-bgp-65501)# neighbor 3.1.1.2
OS10(conf-router-neighbor)# remote-as 65504
OS10(conf-router-neighbor)# no shutdown
OS10(conf-router-neighbor)# exit
OS10(conf-router-bgp-65501)# end
OS10# show running-configuration bgp
!
router bgp 65501
 confederation identifier 100
 confederation peers 65502 65503 65504
 !
 neighbor 1.1.1.2
 remote-as 65502
 no shutdown
 !
 neighbor 2.1.1.2
 remote-as 65503
 no shutdown
 !
 neighbor 3.1.1.2
 remote-as 65504
 no shutdown

```

## Route dampening

When EBGP routes become unavailable, they “flap” and the router issues both WITHDRAWN and UPDATE notices. A flap occurs when a route is withdrawn, readvertised after being withdrawn, or has an attribute change.

The constant router reaction to the WITHDRAWN and UPDATE notices causes instability in the BGP process. To minimize this instability, configure penalties (a numeric value) for routes that flap. When that penalty value reaches a configured limit, the route is not advertised, even if the route is up, the penalty value is 1024.

As time passes and the route does not flap, the penalty value decrements or decays. If the route flaps again, it is assigned another penalty. The penalty value is cumulative and adds underwithdraw, readvertise, or attribute change.

When dampening applies to a route, its path is described by:

- History entry**      Entry that stores information about a downed route.
- Dampened path**     Path that is no longer advertised.
- Penalized path**    Path that is assigned a penalty.

1. Enable route dampening in ROUTER-BGP mode.

```
dampening [half-life | reuse | max-suppress-time]
```

- *half-life* — Number of minutes after which the penalty decreases (1 to 45, default 15). After the router assigns a penalty of 1024 to a route, the penalty decreases by half after the half-life period expires.
- *reuse* — Number compares to the flapping route’s penalty value. If the penalty value is less than the reuse value, the flapping route again advertises or is no longer suppressed (1 to 20000, default 750). Withdrawn routes are deleted from the history state.
- *suppress* — Number compares to the flapping route’s penalty value. If the penalty value is greater than the suppress value, the flapping route no longer advertises and is suppressed (1 to 20000, default 2000).
- *max-suppress-time* — Maximum number of minutes a route is suppressed (1 to 255, default is four times the half-life value or 60 minutes).

2. View all flap statistics or for specific routes meeting the criteria in EXEC mode.

```
show ip bgp flap-statistics [ip-address [mask]]
```

- `ip-address [mask]`— Enter the IP address and mask.
- `filter-list as-path-name` — Enter the name of an AS-PATH ACL.
- `regex regular-expression` — Enter a regular express to match on.

When you change the best path selection method, path selections for the existing paths remain unchanged until you reset it by using the `clear ip bgp` command in EXEC mode.

### Configure values to reuse or restart route

```
OS10(config)# router bgp 102
OS10(config-router-bgp-102)# address-family ipv4 unicast
OS10(config-router-bgpv4-af)# dampening 2 2000 3000 10
```

### View dampened (nonactive) routes

```
OS10# show ip bgp flap-statistics

BGP local router ID is 13.176.123.28
Status codes: s suppressed, S stale, d dampened, h history, * valid, > best
Origin codes: i - IGP, e - EGP, ? - incomplete
 Network
From Reuse Path
Total number of prefixes: 0
```

### View dampened paths

```
OS10# show ip bgp dampened-paths

BGP local router ID is 80.1.1.1
Status codes: s suppressed, S stale, d dampened, h history, * valid, > best
Origin codes: i - IGP, e - EGP, ? - incomplete
 Network From Reuse Path
d* 3.1.2.0/24 80.1.1.2 00:00:12 800 9 8 i
d* 3.1.3.0/24 80.1.1.2 00:00:12 800 9 8 i
d* 3.1.4.0/24 80.1.1.2 00:00:12 800 9 8 i
d* 3.1.5.0/24 80.1.1.2 00:00:12 800 9 8 i
d* 3.1.6.0/24 80.1.1.2 00:00:12 800 9 8 i
Total number of prefixes: 5
```

## Timers

To adjust the routing timers for all neighbors, configure the timer values using the `timers` command. If both the peers negotiate with different keepalive and hold time values, the final hold time value is the lowest values received. The new keepalive value is one-third of the accepted hold time value.

- Configure timer values for all neighbors in ROUTER-NEIGHBOR mode.

```
timers keepalive holdtime
```

- `keepalive` — Time interval in seconds, between keepalive messages sent to the neighbor routers (1 to 65535, default 60).
- `holdtime` — Time interval in seconds, between the last keepalive message and declaring the router dead (3 to 65535, default 180).

### Changing timers example

```
OS10(config)# router bgp 102
OS10(config-router-bgp-102)# neighbor 10.5.2.3
OS10(config-router-neighbor)# timers 120 200
```

### View nondefault values

```
OS10# show running-configuration
...
neighbor 32.1.1.2
remote-as 103
```

```
timers 120 200
no shutdown
```

## Neighbor soft-reconfiguration

BGP soft-reconfiguration allows for fast route changes. Changing routing policies requires a reset of BGP sessions or the TCP connection, for the policies to take effect.

Resets cause undue interruption to traffic due to the hard reset of the BGP cache, and the time it takes to reestablish the session. BGP soft-reconfiguration allows for policies to apply to a session without clearing the BGP session. You can perform a soft-reconfiguration on a per-neighbor basis, either inbound or outbound. BGP soft-reconfiguration clears the policies without resetting the TCP connection. After configuring soft-reconfiguration, use the `clear ip bgp` command to make the neighbor use soft reconfiguration.

When you enable soft-reconfiguration for a neighbor and you run the `clear ip bgp soft in` command, the update database that is stored in the router replays and updates are reevaluated. With this command, the replay and update process trigger only if a route-refresh request is not negotiated with the peer. If the request is negotiated after using the `clear ip bgp soft in` command, BGP sends a route-refresh request to the neighbor and receives all the updates of the peer.

To use soft reconfiguration, or soft reset without preconfiguration, both BGP peers must support soft route refresh. The soft route refresh advertises in the OPEN message sent when the peers establish a TCP session. To determine whether a BGP router supports this capability, use the `show ip bgp neighbors` command. If a router supports the route refresh capability, the `Received route refresh capability from peer` message displays.

1. Enable soft-reconfiguration for the BGP neighbor and BGP template in ROUTER-BGP mode. BGP stores all the updates that the neighbor receives but does not reset the peer-session. Using this command starts the storage of updates, which is required for inbound soft reconfiguration.

```
neighbor {ip-address} soft-reconfiguration inbound
```

2. Enter Address Family mode in ROUTER-NEIGHBOR mode.

```
address-family {[ipv4 | ipv6] [unicast]}
```

3. Configure soft-configuration for the neighbors belonging to the template.

```
soft-reconfiguration inbound
```

4. Clear all information or only specific details in EXEC mode.

```
clear ip bgp {neighbor-address | * | interface interface-type} [soft in]
```

- \* — Clears all peers.
- neighbor-address— Clears the neighbor with this IP address.
- interface interface-type— Clears an unnumbered neighbor.

### Soft-reconfiguration of IPv4 neighbor

```
OS10(conf-router-neighbor)# address-family ipv4 unicast
OS10(conf-router-bgp-neighbor-af)# soft-reconfiguration inbound
OS10(conf-router-bgp-neighbor-af)# end
OS10# clear ip bgp 10.2.1.2
```

### Soft-reconfiguration of IPv6 neighbor

```
OS10(conf-router-neighbor)# address-family ipv6 unicast
OS10(conf-router-bgp-neighbor-af)# soft-reconfiguration inbound
OS10(conf-router-bgp-neighbor-af)# end
OS10# clear ip bgp 2001:0000:3221:DFE8:63::FEAB
```

## Redistribute iBGP route to OSPF

When you configure the system redistribute BGP routes to OSPF, by default, the system redistributes only the eBGP routes. To redistribute iBGP routes to OSPF, configure a route-map and apply it to the `redistribute` command under the OSPF configuration.

### Sample configuration

The following sample topology has two switches, Core 1 and Core 2, that are connected to each other and share routes using OSPF. A border router BR is connected to Core 1 and shares routes using internal BGP. Core 1 redistributes the routes that are learned by iBGP to OSPF to Core 2.

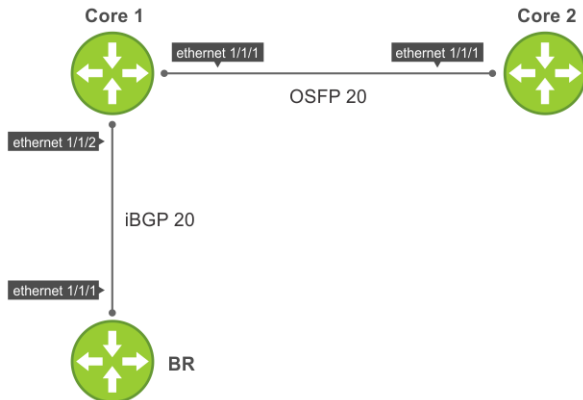

### Configuration on BR

BR has BGP configured which forms BGP neighbor adjacency with Core 1.

```
interface Loopback0
 ip address 192.168.100.1/24
!
interface ethernet1/1/1
 no shutdown
 no switchport
 ip address 10.10.9.1
!
router bgp 20
 network 192.168.100.0
 neighbor 10.10.9.2 remote-as 20
 address-family ipv4 unicast
```

### Configuration on Core 1

Core 1 has both OSPF and BGP configured. Core 1 has OSPF neighbor adjacency with Core 2 and BGP neighbor adjacency with BR. The `iBGPtoOSPF prefix-list` is configured and applied to a route-map. The `match ip address prefix-list iBGPtoOSPF` command processes the iBGP-learned routes.

```
ip prefix-list iBGPtoOSPF seq 15 permit 192.168.100.0/24
route-map iBGPtoOSPF permit 20
 match ip address prefix-list iBGPtoOSPF
!
interface ethernet1/1/1
 no shutdown
 no switchport
 ip address 10.10.30.2/24
 ip router ospf 10 area 0.0.0.0
!
interface ethernet1/1/2
 no shutdown
 no switchport
 ip address 10.10.9.2/24
!
router ospf 10
 router-id 2.2.2.2
 redistribute bgp 20 route-map iBGPtoOSPF
!
router bgp 20
```

```

neighbor 10.10.9.1
remote-as 20
address-family ipv4 unicast
allowas-in 1

```

### Configuration on Core 2

Core 2 has OSPF configured which forms neighbor adjacency with Core 1.

```

interface ethernet1/1/1
 no shutdown
 no switchport
 ip address 10.10.30.3/24
 ip router ospf 10 area 0.0.0.0
 no shutdown
!
!
router ospf 10
 router-id 3.3.3.3

```

### Sample IPv6 configuration

The following sample topology has two switches, Core 1 and Core 2, that are connected to each other and share routes using OSPF. A border router BR is connected to Core 1 and shares routes using BGP. Core 1 redistributes the routes that are learned by iBGP to OSPF and shares to other routers. This network uses IPv6 addressing.

### Configuration on BR

BR has BGP configured which forms BGP neighbor adjacency with Core 1.

```

interface Loopback0
 ipv6 address 2020::1/64
!
interface ethernet1/1/1
 no switchport
 ip address 2030::1/64
!
!
address-family ipv6 unicast
router bgp 20
 neighbor 2030::2 remote-as 20

```

### Configuration on Core 1

Core 1 has both OSPF and BGP configured. Core 1 has OSPF neighbor adjacency with Core 2 and BGP neighbor adjacency with BR. The iBGPtoOSPF prefix-list is configured and applied to a route-map. The match ip address prefix-list iBGPtoOSPF command processes the iBGP-learned routes.

```

ip prefix-list iBGPtoOSPF seq 15 permit 2020::1/64
route-map iBGPtoOSPF permit 20
 match ip address prefix-list iBGPtoOSPF
!
!
interface ethernet1/1/1
 no switchport
 ipv6 address 2035::1/64
 ipv6 ospf 10 area 0.0.0.0
 no shutdown
!
interface Ethernet1/1/2
 no switchport
 ipv6 address 2030::2/64
 no shutdown
!
router ospfv3 10
 router-id 2.2.2.2
 redistribute bgp 10 route-map iBGPtoOSPF
!
router bgp 20
neighbor 2030::1
remote-as 20
address-family ipv6 unicast

```



```
activate
allowas-in 1
```

### Configuration on Core 2

Core 2 has OSPF configured which forms neighbor adjacency with Core 1.

```
interface Ethernet 1/1/1
 no switchport
 ipv6 address 2035::2/64
 ipv6 ospf 10 area 0.0.0.0
 no shutdown
!
router ospfv3 10
router-id 3.3.3.3
```

## Example - BGP in a VLT topology

The following spine-leaf VLT topology runs BGP for Layer 3 communication.

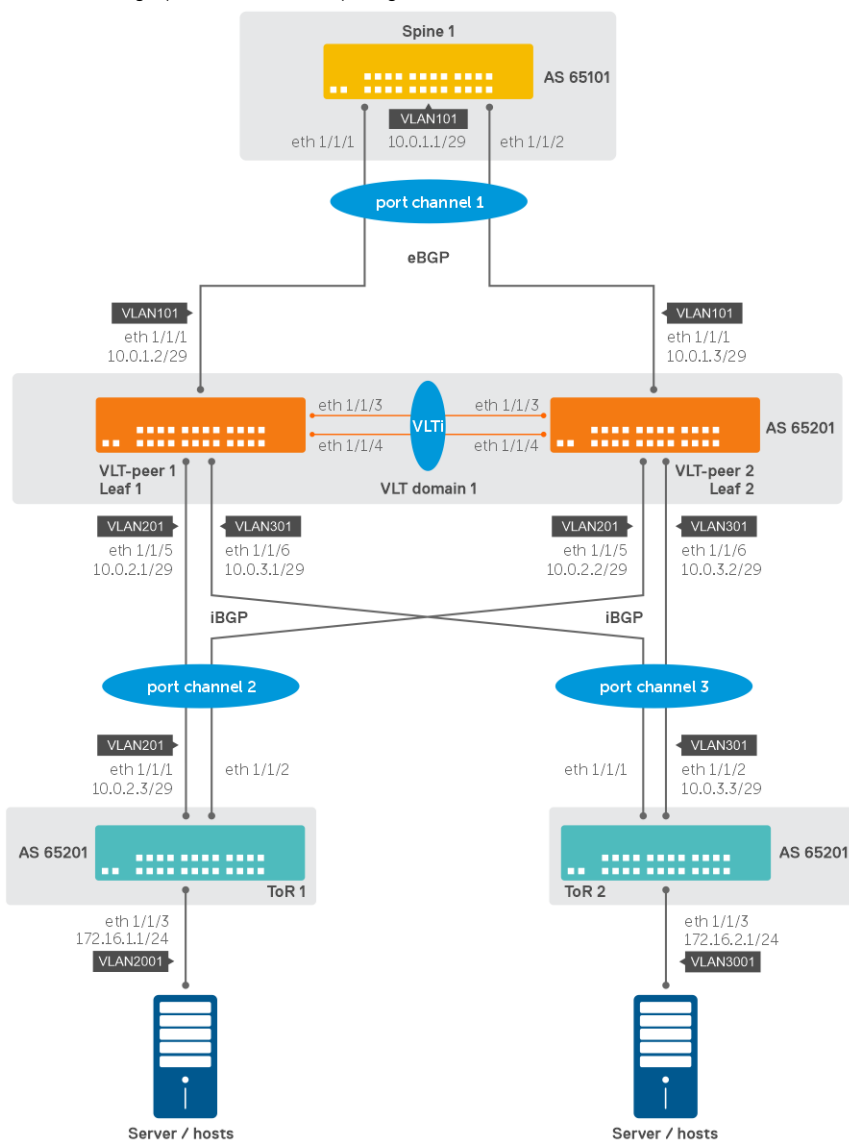

### Spine 1 configuration

1. Configure a VLAN interface on which the BGP session has to be formed with VLT peers.

```
Spine1(config)# interface vlan101
Spine1(conf-if-vl-101)# ip address 10.0.1.1/29
Spine1(conf-if-vl-101)# mtu 9216
Spine1(conf-if-vl-101)# exit
```

2. Configure port channel interfaces between Spine and VLT peers. Add it as part of the created VLAN.

```
Spine1(config)# interface port-channel1
Spine1(conf-if-po-1)# mtu 9216
Spine1(conf-if-po-1)# switchport mode trunk
Spine1(conf-if-po-1)# switchport trunk allowed vlan 101
Spine1(conf-if-po-1)# exit
Spine1(config)# interface ethernet1/1/1
Spine1(conf-if-eth1/1/1)# channel-group 1 mode active
Spine1(conf-if-eth1/1/1)# exit
Spine1(config)# interface ethernet1/1/2
Spine1(conf-if-eth1/1/2)# channel-group 1 mode active
Spine1(conf-if-eth1/1/2)# exit
```

3. Configure eBGP neighbor with VLT peer1 and VLT peer2.

```
Spine1(config)# router bgp 65101
Spine1(config-router-bgp-65101)# router-id 10.1.1.1
Spine1(config-router-bgp-65101)# neighbor 10.0.1.2
Spine1(config-router-neighbor)# remote-as 65201
Spine1(config-router-neighbor)# no shutdown
Spine1(config-router-neighbor)# exit
Spine1(config-router-bgp-65101)# neighbor 10.0.1.3
Spine1(config-router-neighbor)# remote-as 65201
Spine1(config-router-neighbor)# no shutdown
Spine1(config-router-neighbor)# exit
```

## Leaf 1 configuration

1. Configure VLT peering between VLT peer 1 and VLT peer 2.

```
Leaf1(config)# interface range ethernet1/1/3-1/1/4
Leaf1(conf-range-eth1/1/3-1/1/4)# no switchport
Leaf1(conf-range-eth1/1/3-1/1/4)# exit
Leaf1(config)# vlt-domain 1
Leaf1(conf-vlt-1)# backup destination 192.168.1.2
Leaf1(conf-vlt-1)# discovery-interface ethernet1/1/3-1/1/4
Leaf1(conf-vlt-1)# primary-priority 1
Leaf1(conf-vlt-1)# vlt-mac de:11:de:11:de:11
Leaf1(conf-vlt-1)# peer-routing
Leaf1(conf-vlt-1)# exit
```

2. Configure VLAN interfaces on which BGP sessions has to be formed with Spine and ToR switches.

```
Leaf1(config)# interface vlan101
Leaf1(conf-if-vl-101)# ip address 10.0.1.2/29
Leaf1(conf-if-vl-101)# mtu 9216
Leaf1(conf-if-vl-101)# exit
Leaf1(config)# interface vlan201
Leaf1(conf-if-vl-201)# ip address 10.0.2.1/29
Leaf1(conf-if-vl-201)# mtu 9216
Leaf1(conf-if-vl-201)# exit
Leaf1(config)# interface vlan301
Leaf1(conf-if-vl-301)# ip address 10.0.3.1/29
Leaf1(conf-if-vl-301)# mtu 9216
Leaf1(conf-if-vl-301)# exit
```

3. Configure VLT port-channel with Spine 1.

```
Leaf1(config)# interface port-channel1
Leaf1(conf-if-po-1)# mtu 9216
Leaf1(conf-if-po-1)# switchport mode trunk
Leaf1(conf-if-po-1)# switchport trunk allowed vlan 101
Leaf1(conf-if-po-1)# vlt-port-channel 1
Leaf1(conf-if-po-1)# exit
```

```
Leaf1(config)# interface ethernet1/1/1
Leaf1(conf-if-eth1/1/1)# channel-group 1 mode active
Leaf1(conf-if-eth1/1/1)# exit
```

4. Configure VLT port-channels with ToR 1 and ToR 2.

```
Leaf1(config)# interface port-channel2
Leaf1(conf-if-po-2)# mtu 9216
Leaf1(conf-if-po-2)# switchport mode trunk
Leaf1(conf-if-po-2)# switchport trunk allowed vlan 201
Leaf1(conf-if-po-2)# vlt-port-channel 2
Leaf1(conf-if-po-2)# exit
Leaf1(config)# interface ethernet1/1/5
Leaf1(conf-if-eth1/1/5)# channel-group 2 mode active
Leaf1(conf-if-eth1/1/5)# exit
Leaf1(config)# interface port-channel3
Leaf1(conf-if-po-3)# mtu 9216
Leaf1(conf-if-po-3)# switchport mode trunk
Leaf1(conf-if-po-3)# switchport trunk allowed vlan 301
Leaf1(conf-if-po-3)# vlt-port-channel 3
Leaf1(conf-if-po-3)# exit
Leaf1(config)# interface ethernet1/1/6
Leaf1(conf-if-eth1/1/6)# channel-group 3 mode active
Leaf1(conf-if-eth1/1/6)# exit
```

5. Configure the eBGP neighbor with Spine 1 and iBGP neighbor with ToR 1 and ToR 2.

```
Leaf1(config)# router bgp 65201
Leaf1(config-router-bgp-65201)# router-id 10.2.1.1
Leaf1(config-router-bgp-65201)# neighbor 10.0.1.1
Leaf1(config-router-neighbor)# remote-as 65101
Leaf1(config-router-neighbor)# no shutdown
Leaf1(config-router-neighbor)# exit
Leaf1(config-router-bgp-65201)# neighbor 10.0.2.3
Leaf1(config-router-neighbor)# remote-as 65201
Leaf1(config-router-neighbor)# route-reflector-client
Leaf1(config-router-neighbor)# no shutdown
Leaf1(config-router-neighbor)# address-family ipv4 unicast
Leaf1(config-router-bgp-neighbor-af)# next-hop-self
Leaf1(config-router-bgp-neighbor-af)# exit
Leaf1(config-router-neighbor)# exit
Leaf1(config-router-bgp-65201)# neighbor 10.0.3.3
Leaf1(config-router-neighbor)# remote-as 65201
Leaf1(config-router-neighbor)# route-reflector-client
Leaf1(config-router-neighbor)# no shutdown
Leaf1(config-router-neighbor)# address-family ipv4 unicast
Leaf1(config-router-bgp-neighbor-af)# next-hop-self
Leaf1(config-router-bgp-neighbor-af)# exit
Leaf1(config-router-neighbor)# exit
```

## Leaf 2 configuration

1. Configure VLT peering between VLT peer 1 and VLT peer 2.

```
Leaf2(config)# interface range ethernet1/1/3-1/1/4
Leaf2(conf-range-eth1/1/3-1/1/4)# no switchport
Leaf2(conf-range-eth1/1/3-1/1/4)# exit
Leaf2(config)# vlt-domain 1
Leaf2(conf-vlt-1)# backup destination 192.168.1.1
Leaf2(conf-vlt-1)# discovery-interface ethernet1/1/3-1/1/4
Leaf2(conf-vlt-1)# primary-priority 65535
Leaf2(conf-vlt-1)# vlt-mac de:11:de:11:de:11
Leaf2(conf-vlt-1)# peer-routing
Leaf2(conf-vlt-1)# exit
```

2. Configure VLAN interfaces on which BGP sessions has to be formed with Spine and ToR switches.

```
Leaf2(config)# interface vlan101
Leaf2(conf-if-vl-101)# ip address 10.0.1.3/29
Leaf2(conf-if-vl-101)# mtu 9216
Leaf2(conf-if-vl-101)# exit
Leaf2(config)# interface vlan201
Leaf2(conf-if-vl-201)# ip address 10.0.2.2/29
```

```

Leaf2(conf-if-vl-201)# mtu 9216
Leaf2(conf-if-vl-201)# exit
Leaf2(config)# interface vlan301
Leaf2(conf-if-vl-301)# ip address 10.0.3.2/29
Leaf2(conf-if-vl-301)# mtu 9216
Leaf2(conf-if-vl-301)# exit

```

### 3. Configure VLT port-channel with Spine 1.

```

Leaf2(config)# interface port-channel1
Leaf2(conf-if-po-1)# mtu 9216
Leaf2(conf-if-po-1)# switchport mode trunk
Leaf2(conf-if-po-1)# switchport trunk allowed vlan 101
Leaf2(conf-if-po-1)# vlt-port-channel 1
Leaf2(conf-if-po-1)# exit
Leaf2(config)# interface ethernet1/1/1
Leaf2(conf-if-eth1/1/1)# channel-group 1 mode active
Leaf2(conf-if-eth1/1/1)# exit

```

### 4. Configure VLT port-channels with ToR 1 and ToR 2.

```

Leaf2(config)# interface port-channel2
Leaf2(conf-if-po-2)# mtu 9216
Leaf2(conf-if-po-2)# switchport mode trunk
Leaf2(conf-if-po-2)# switchport trunk allowed vlan 201
Leaf2(conf-if-po-2)# vlt-port-channel 2
Leaf2(conf-if-po-2)# exit
Leaf2(config)# interface ethernet1/1/5
Leaf2(conf-if-eth1/1/5)# channel-group 2 mode active
Leaf2(conf-if-eth1/1/5)# exit
Leaf2(config)# interface port-channel3
Leaf2(conf-if-po-3)# mtu 9216
Leaf2(conf-if-po-3)# switchport mode trunk
Leaf2(conf-if-po-3)# switchport trunk allowed vlan 301
Leaf2(conf-if-po-3)# vlt-port-channel 3
Leaf2(conf-if-po-3)# exit
Leaf2(config)# interface ethernet1/1/6
Leaf2(conf-if-eth1/1/6)# channel-group 3 mode active
Leaf2(conf-if-eth1/1/6)# exit

```

### 5. Configure the eBGP neighbor with Spine 1 and iBGP neighbor with ToR 1 and ToR 2.

```

Leaf2(config)# router bgp 65201
Leaf2(config-router-bgp-65201)# router-id 10.2.1.2
Leaf2(config-router-bgp-65201)# neighbor 10.0.1.1
Leaf2(config-router-neighbor)# remote-as 65101
Leaf2(config-router-neighbor)# no shutdown
Leaf2(config-router-neighbor)# exit
Leaf2(config-router-bgp-65201)# neighbor 10.0.2.3
Leaf2(config-router-neighbor)# remote-as 65201
Leaf2(config-router-neighbor)# route-reflector-client
Leaf2(config-router-neighbor)# no shutdown
Leaf2(config-router-neighbor)# address-family ipv4 unicast
Leaf2(config-router-bgp-neighbor-af)# next-hop-self
Leaf2(config-router-bgp-neighbor-af)# exit
Leaf2(config-router-neighbor)# exit
Leaf2(config-router-bgp-65201)# neighbor 10.0.3.3
Leaf2(config-router-neighbor)# remote-as 65201
Leaf2(config-router-neighbor)# route-reflector-client
Leaf2(config-router-neighbor)# no shutdown
Leaf2(config-router-neighbor)# address-family ipv4 unicast
Leaf2(config-router-bgp-neighbor-af)# next-hop-self
Leaf2(config-router-bgp-neighbor-af)# exit
Leaf2(config-router-neighbor)# exit

```

## ToR 1 configuration

### 1. Configure VLAN interface on which the BGP session has to be formed with VLT peers.

```

ToR1(config)# interface vlan201
ToR1(conf-if-vl-201)# ip address 10.0.2.3/29

```

```
ToR1(config-if-vl-201)# mtu 9216
ToR1(config-if-vl-201)# exit
```

2. Configure a port channel interface between ToR1 and VLT peers. Add it as part of the above created VLAN.

```
ToR1(config)# interface port-channel2
ToR1(config-if-po-1)# mtu 9216
ToR1(config-if-po-1)# switchport mode trunk
ToR1(config-if-po-1)# switchport trunk allowed vlan 201
ToR1(config-if-po-1)# exit
ToR1(config)# interface ethernet1/1/1
ToR1(config-if-eth1/1/1)# channel-group 2 mode active
ToR1(config-if-eth1/1/1)# exit
ToR1(config)# interface ethernet1/1/2
ToR1(config-if-eth1/1/2)# channel-group 2 mode active
ToR1(config-if-eth1/1/2)# exit
```

3. Configure the host facing VLAN and add host connected interfaces to it.

```
ToR1(config)# interface vlan2001
ToR1(config-if-vl-2001)# ip address 172.16.1.1/24
ToR1(config-if-vl-2001)# mtu 9216
ToR1(config-if-vl-2001)# exit
ToR1(config)# interface ethernet1/1/3
ToR1(config-if-eth1/1/3)# mtu 9216
ToR1(config-if-eth1/1/3)# switchport mode trunk
ToR1(config-if-eth1/1/3)# switchport trunk allowed vlan 2001
ToR1(config-if-eth1/1/3)# exit
```

4. Configure the iBGP neighbor with VLT peers and advertise the host subnet.

```
ToR1(config)# router bgp 65201
ToR1(config-router-bgp-65201)# router-id 10.3.1.1
ToR1(config-router-bgp-65201)# address-family ipv4 unicast
ToR1(configure-router-bgpv4-af)# network 172.16.1.0/24
ToR1(configure-router-bgpv4-af)# exit
ToR1(config-router-bgp-65201)# neighbor 10.0.2.1
ToR1(config-router-neighbor)# remote-as 65201
ToR1(config-router-neighbor)# no shutdown
ToR1(config-router-neighbor)# exit
ToR1(config-router-bgp-65201)# neighbor 10.0.2.2
ToR1(config-router-neighbor)# remote-as 65201
ToR1(config-router-neighbor)# no shutdown
ToR1(config-router-neighbor)# exit
```

## ToR 2 configuration

1. Configure a VLAN interface on which the BGP session has to be formed with VLT peers.

```
ToR2(config)# interface vlan301
ToR2(config-if-vl-201)# mtu 9216
ToR2(config-if-vl-201)# ip address 10.0.3.3/29
ToR2(config-if-vl-201)# exit
```

2. Configure a port channel interface between ToR2 and VLT peers. Add it as part of the above created VLAN.

```
ToR2(config)# interface port-channel3
ToR2(config-if-po-1)# mtu 9216
ToR2(config-if-po-1)# switchport mode trunk
ToR2(config-if-po-1)# switchport trunk allowed vlan 301
ToR2(config-if-po-1)# exit
ToR2(config)# interface ethernet1/1/1
ToR2(config-if-eth1/1/1)# channel-group 3 mode active
ToR2(config-if-eth1/1/1)# exit
ToR2(config)# interface ethernet1/1/2
ToR2(config-if-eth1/1/2)# channel-group 3 mode active
ToR2(config-if-eth1/1/2)# exit
```

3. Configure the host facing VLAN and add host connected interfaces to it.

```
ToR2(config)# interface vlan3001
ToR2(config-if-vl-2001)# mtu 9216
```

```

ToR2(conf-if-vl-2001)# ip address 172.16.2.1/24
ToR2(conf-if-vl-2001)# exit
ToR2(config)# interface ethernet1/1/3
ToR2(conf-if-eth1/1/3)# mtu 9216
ToR2(conf-if-eth1/1/3)# switchport mode trunk
ToR2(conf-if-eth1/1/3)# switchport trunk allowed vlan 3001
ToR2(conf-if-eth1/1/3)# exit

```

- Configure the iBGP neighbor with VLT peers and advertise the host subnet.

```

ToR2(config)# router bgp 65201
ToR2(config-router-bgp-65201)# router-id 10.3.1.2
ToR2(config-router-bgp-65201)# address-family ipv4 unicast
ToR2(configure-router-bgpv4-af)# network 172.16.2.0/24
ToR2(configure-router-bgpv4-af)# exit
ToR2(config-router-bgp-65201)# neighbor 10.0.2.1
ToR2(config-router-neighbor)# remote-as 65201
ToR2(config-router-neighbor)# no shutdown
ToR2(config-router-neighbor)# exit
ToR2(config-router-bgp-65201)# neighbor 10.0.2.2
ToR2(config-router-neighbor)# remote-as 65201
ToR2(config-router-neighbor)# no shutdown
ToR2(config-router-neighbor)# exit

```

## Example - Three-tier CLOS topology with eBGP

This section provides a sample three-tier topology with external BGP.

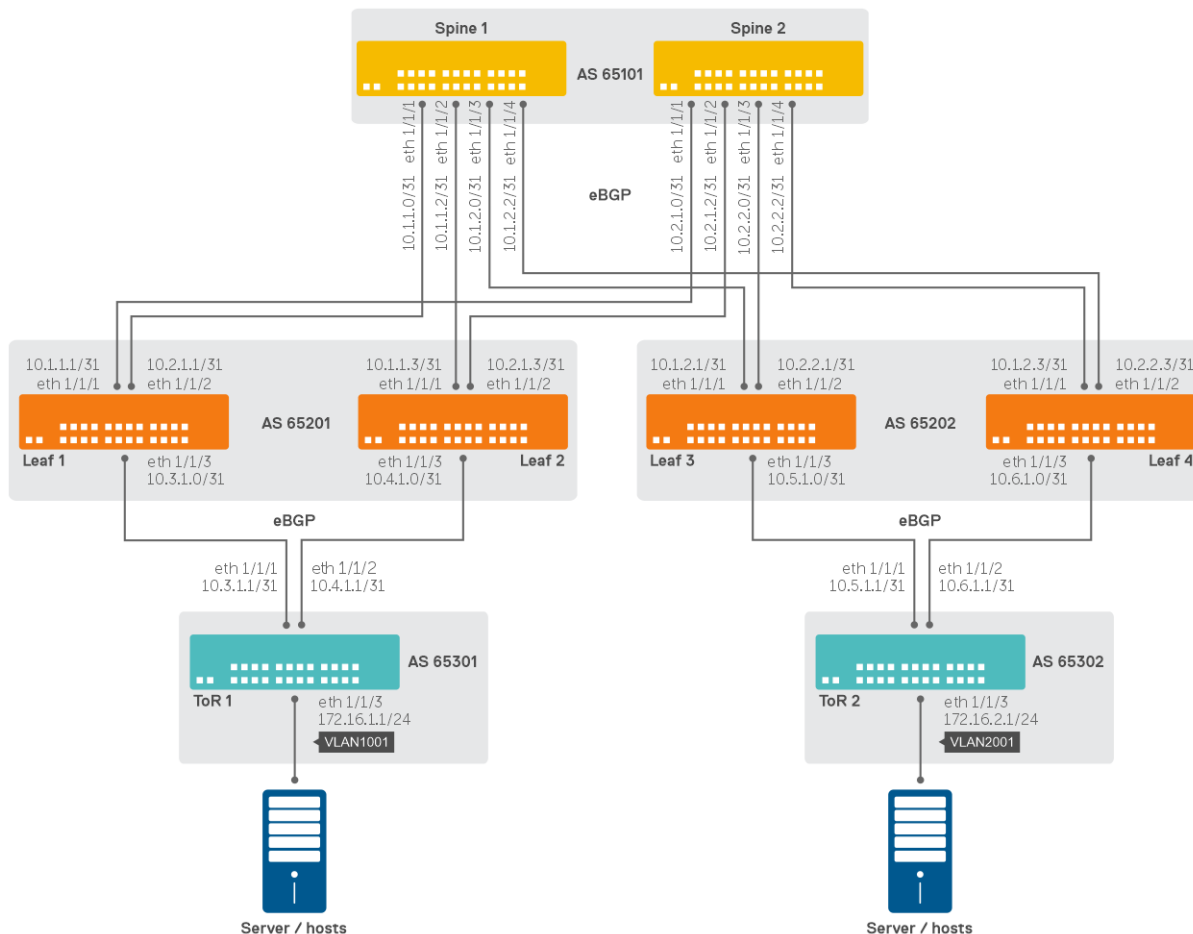

### Spine 1 configuration

1. Configure an IP address on leaf-facing interfaces.

```
Spine1(config)# interface ethernet1/1/1
Spine1(conf-if-eth1/1/1)# description Spine1-Leaf1
Spine1(conf-if-eth1/1/1)# no switchport
Spine1(conf-if-eth1/1/1)# mtu 9216
Spine1(conf-if-eth1/1/1)# ip address 10.1.1.0/31
Spine1(conf-if-eth1/1/1)# exit
Spine1(config)# interface ethernet1/1/2
Spine1(conf-if-eth1/1/2)# description Spine1-Leaf2
Spine1(conf-if-eth1/1/2)# no switchport
Spine1(conf-if-eth1/1/2)# mtu 9216
Spine1(conf-if-eth1/1/2)# ip address 10.1.1.2/31
Spine1(conf-if-eth1/1/2)# exit
Spine1(config)# interface ethernet1/1/3
Spine1(conf-if-eth1/1/3)# description Spine1-Leaf3
Spine1(conf-if-eth1/1/3)# no switchport
Spine1(conf-if-eth1/1/3)# mtu 9216
Spine1(conf-if-eth1/1/3)# ip address 10.1.2.0/31
Spine1(conf-if-eth1/1/3)# exit
Spine1(config)# interface ethernet1/1/4
Spine1(conf-if-eth1/1/4)# description Spine1-Leaf4
Spine1(conf-if-eth1/1/4)# no switchport
Spine1(conf-if-eth1/1/4)# mtu 9216
Spine1(conf-if-eth1/1/4)# ip address 10.1.2.2/31
Spine1(conf-if-eth1/1/4)# exit
```

2. Configure BGP neighbors. This example uses passive peering which simplifies neighbor configuration.

```
Spine1(config)# router bgp 65101
Spine1(config-router-bgp-65101)# router-id 10.0.0.1
Spine1(config-router-bgp-65101)# template passive_v4_pod1
Spine1(config-router-template)# remote-as 65201
Spine1(config-router-template)# listen 10.1.1.0/24
Spine1(config-router-template)# exit
Spine1(config-router-bgp-65101)# template passive_v4_pod2
Spine1(config-router-template)# remote-as 65202
Spine1(config-router-template)# listen 10.1.2.0/24
Spine1(config-router-template)# exit
```

## Spine 2 configuration

1. Configure an IP address on leaf-facing interfaces.

```
Spine2(config)# interface ethernet1/1/1
Spine2(conf-if-eth1/1/1)# description Spine2-Leaf1
Spine2(conf-if-eth1/1/1)# no switchport
Spine2(conf-if-eth1/1/1)# mtu 9216
Spine2(conf-if-eth1/1/1)# ip address 10.2.1.0/31
Spine2(conf-if-eth1/1/1)# exit
Spine2(config)# interface ethernet1/1/2
Spine2(conf-if-eth1/1/2)# description Spine2-Leaf2
Spine2(conf-if-eth1/1/2)# no switchport
Spine2(conf-if-eth1/1/2)# mtu 9216
Spine2(conf-if-eth1/1/2)# ip address 10.2.1.2/31
Spine2(conf-if-eth1/1/2)# exit
Spine2(config)# interface ethernet1/1/3
Spine2(conf-if-eth1/1/3)# description Spine2-Leaf3
Spine2(conf-if-eth1/1/3)# no switchport
Spine2(conf-if-eth1/1/3)# mtu 9216
Spine2(conf-if-eth1/1/3)# ip address 10.2.2.0/31
Spine2(conf-if-eth1/1/3)# exit
Spine2(config)# interface ethernet1/1/4
Spine2(conf-if-eth1/1/4)# description Spine2-Leaf4
Spine2(conf-if-eth1/1/4)# no switchport
Spine2(conf-if-eth1/1/4)# mtu 9216
Spine2(conf-if-eth1/1/4)# ip address 10.2.2.2/31
Spine2(conf-if-eth1/1/4)# exit
```

2. Configure BGP neighbors. This example uses passive peering which simplifies neighbor configuration.

```
Spine2(config)# router bgp 65101
Spine2(config-router-bgp-65101)# router-id 10.0.0.2
Spine2(config-router-bgp-65101)# template passive_v4_pod1
Spine2(config-router-template)# remote-as 65201
Spine2(config-router-template)# listen 10.2.1.0/24
Spine2(config-router-template)# exit
Spine2(config-router-bgp-65101)# template passive_v4_pod2
Spine2(config-router-template)# remote-as 65202
Spine2(config-router-template)# listen 10.2.2.0/24
Spine2(config-router-template)# exit
```

### Leaf 1 configuration

1. Configure an IP address on spine-facing interfaces.

```
Leaf1(config)# interface ethernet1/1/1
Leaf1(conf-if-eth1/1/1)# description Leaf1-Spine1
Leaf1(conf-if-eth1/1/1)# no switchport
Leaf1(conf-if-eth1/1/1)# mtu 9216
Leaf1(conf-if-eth1/1/1)# ip address 10.1.1.1/31
Leaf1(conf-if-eth1/1/1)# exit
Leaf1(config)# interface ethernet1/1/2
Leaf1(conf-if-eth1/1/2)# description Leaf1-Spine2
Leaf1(conf-if-eth1/1/2)# no switchport
Leaf1(conf-if-eth1/1/2)# mtu 9216
Leaf1(conf-if-eth1/1/2)# ip address 10.2.1.1/31
Leaf1(conf-if-eth1/1/2)# exit
```

2. Configure an IP address on ToR facing interfaces.

```
Leaf1(config)# interface ethernet1/1/3
Leaf1(conf-if-eth1/1/1)# description Leaf1-ToR1
Leaf1(conf-if-eth1/1/1)# no switchport
Leaf1(conf-if-eth1/1/1)# mtu 9216
Leaf1(conf-if-eth1/1/1)# ip address 10.3.1.0/31
Leaf1(conf-if-eth1/1/1)# exit
```

3. Configure BGP neighbors.

```
Leaf1(config)# router bgp 65201
Leaf1(config-router-bgp-65201)# router-id 10.0.1.1
Leaf1(config-router-bgp-65201)# neighbor 10.1.1.0
Leaf1(config-router-neighbor)# remote-as 65101
Leaf1(config-router-neighbor)# no shutdown
Leaf1(config-router-neighbor)# exit
Leaf1(config-router-bgp-65201)# neighbor 10.2.1.0
Leaf1(config-router-neighbor)# remote-as 65101
Leaf1(config-router-neighbor)# no shutdown
Leaf1(config-router-neighbor)# exit
Leaf1(config-router-bgp-65201)# neighbor 10.3.1.1
Leaf1(config-router-neighbor)# remote-as 65301
Leaf1(config-router-neighbor)# no shutdown
Leaf1(config-router-neighbor)# exit
```

### Leaf 2 configuration

1. Configure an IP address on spine-facing interfaces.

```
Leaf2(config)# interface ethernet1/1/1
Leaf2(conf-if-eth1/1/1)# description Leaf2-Spine1
Leaf2(conf-if-eth1/1/1)# no switchport
Leaf2(conf-if-eth1/1/1)# mtu 9216
Leaf2(conf-if-eth1/1/1)# ip address 10.1.1.3/31
Leaf2(conf-if-eth1/1/1)# exit
Leaf2(config)# interface ethernet1/1/2
Leaf2(conf-if-eth1/1/2)# description Leaf2-Spine2
Leaf2(conf-if-eth1/1/2)# no switchport
Leaf2(conf-if-eth1/1/2)# mtu 9216
Leaf2(conf-if-eth1/1/2)# ip address 10.2.1.3/31
Leaf2(conf-if-eth1/1/2)# exit
```



2. Configure an IP address on ToR-facing interfaces.

```
Leaf2(config)# interface ethernet1/1/3
Leaf2(conf-if-eth1/1/1)# description Leaf2-ToR1
Leaf2(conf-if-eth1/1/1)# no switchport
Leaf2(conf-if-eth1/1/1)# mtu 9216
Leaf2(conf-if-eth1/1/1)# ip address 10.4.1.0/31
Leaf2(conf-if-eth1/1/1)# exit
```

3. Configure BGP neighbors.

```
Leaf2(config)# router bgp 65201
Leaf2(config-router-bgp-65201)# router-id 10.0.1.2
Leaf2(config-router-bgp-65201)# neighbor 10.1.1.2
Leaf2(config-router-neighbor)# remote-as 65101
Leaf2(config-router-neighbor)# no shutdown
Leaf2(config-router-neighbor)# exit
Leaf2(config-router-bgp-65201)# neighbor 10.2.1.2
Leaf2(config-router-neighbor)# remote-as 65101
Leaf2(config-router-neighbor)# no shutdown
Leaf2(config-router-neighbor)# exit
Leaf2(config-router-bgp-65201)# neighbor 10.4.1.1
Leaf2(config-router-neighbor)# remote-as 65301
Leaf2(config-router-neighbor)# no shutdown
Leaf2(config-router-neighbor)# exit
```

### Leaf 3 configuration

1. Configure an IP address on spine-facing interfaces.

```
Leaf3(config)# interface ethernet1/1/1
Leaf3(conf-if-eth1/1/1)# description Leaf3-Spine1
Leaf3(conf-if-eth1/1/1)# no switchport
Leaf3(conf-if-eth1/1/1)# mtu 9216
Leaf3(conf-if-eth1/1/1)# ip address 10.1.2.1/31
Leaf3(conf-if-eth1/1/1)# exit
Leaf3(config)# interface ethernet1/1/2
Leaf3(conf-if-eth1/1/2)# description Leaf3-Spine2
Leaf3(conf-if-eth1/1/2)# no switchport
Leaf3(conf-if-eth1/1/2)# mtu 9216
Leaf3(conf-if-eth1/1/2)# ip address 10.2.2.1/31
Leaf3(conf-if-eth1/1/2)# exit
```

2. Configure an IP address on ToR-facing interfaces.

```
Leaf3(config)# interface ethernet1/1/3
Leaf3(conf-if-eth1/1/3)# description Leaf3-ToR2
Leaf3(conf-if-eth1/1/3)# no switchport
Leaf3(conf-if-eth1/1/3)# mtu 9216
Leaf3(conf-if-eth1/1/3)# ip address 10.5.1.0/31
Leaf3(conf-if-eth1/1/3)# exit
```

3. Configure BGP neighbors.

```
Leaf3(config)# router bgp 65202
Leaf3(config-router-bgp-65202)# router-id 10.0.1.3
Leaf3(config-router-bgp-65202)# neighbor 10.1.2.0
Leaf3(config-router-neighbor)# remote-as 65101
Leaf3(config-router-neighbor)# no shutdown
Leaf3(config-router-neighbor)# exit
Leaf3(config-router-bgp-65202)# neighbor 10.2.2.0
Leaf3(config-router-neighbor)# remote-as 65101
Leaf3(config-router-neighbor)# no shutdown
Leaf3(config-router-neighbor)# exit
Leaf3(config-router-bgp-65202)# neighbor 10.5.1.1
Leaf3(config-router-neighbor)# remote-as 65302
Leaf3(config-router-neighbor)# no shutdown
Leaf3(config-router-neighbor)# exit
```

### Leaf 4 configuration

1. Configure an IP address on spine-facing interfaces.

```
Leaf4(config)# interface ethernet1/1/1
Leaf4(conf-if-eth1/1/1)# description Leaf4-Spine1
Leaf4(conf-if-eth1/1/1)# no switchport
Leaf4(conf-if-eth1/1/1)# mtu 9216
Leaf4(conf-if-eth1/1/1)# ip address 10.1.2.3/31
Leaf4(conf-if-eth1/1/1)# exit
Leaf4(config)# interface ethernet1/1/2
Leaf4(conf-if-eth1/1/2)# description Leaf4-Spine2
Leaf4(conf-if-eth1/1/2)# no switchport
Leaf4(conf-if-eth1/1/2)# mtu 9216
Leaf4(conf-if-eth1/1/2)# ip address 10.2.2.3/31
Leaf4(conf-if-eth1/1/2)# exit
```

2. Configure an IP address on ToR-facing interfaces.

```
Leaf4(config)# interface ethernet1/1/3
Leaf4(conf-if-eth1/1/3)# description Leaf4-ToR2
Leaf4(conf-if-eth1/1/3)# no switchport
Leaf4(conf-if-eth1/1/3)# mtu 9216
Leaf4(conf-if-eth1/1/3)# ip address 10.6.1.0/31
Leaf4(conf-if-eth1/1/3)# exit
```

3. Configure BGP neighbors.

```
Leaf4(config)# router bgp 65202
Leaf4(config-router-bgp-65202)# router-id 10.0.1.4
Leaf4(config-router-bgp-65202)# neighbor 10.1.2.2
Leaf4(config-router-neighbor)# remote-as 65101
Leaf4(config-router-neighbor)# no shutdown
Leaf4(config-router-neighbor)# exit
Leaf4(config-router-bgp-65202)# neighbor 10.2.2.2
Leaf4(config-router-neighbor)# remote-as 65101
Leaf4(config-router-neighbor)# no shutdown
Leaf4(config-router-neighbor)# exit
Leaf4(config-router-bgp-65202)# neighbor 10.6.1.1
Leaf4(config-router-neighbor)# remote-as 65302
Leaf4(config-router-neighbor)# no shutdown
Leaf4(config-router-neighbor)# exit
```

## ToR 1 configuration

1. Configure an IP address on leaf-facing interfaces.

```
ToR1(config)# interface ethernet1/1/1
ToR1(conf-if-eth1/1/1)# description ToR1-Leaf1
ToR1(conf-if-eth1/1/1)# no switchport
ToR1(conf-if-eth1/1/1)# mtu 9216
ToR1(conf-if-eth1/1/1)# ip address 10.3.1.1/31
ToR1(conf-if-eth1/1/1)# exit
ToR1(config)# interface ethernet1/1/2
ToR1(conf-if-eth1/1/2)# description ToR1-Leaf2
ToR1(conf-if-eth1/1/2)# no switchport
ToR1(conf-if-eth1/1/2)# mtu 9216
ToR1(conf-if-eth1/1/2)# ip address 10.4.1.1/31
ToR1(conf-if-eth1/1/2)# exit
```

2. Configure a VLAN interface and a VLAN member for the end hosts.

```
ToR1(config)# interface vlan 1001
ToR1(conf-if-vl-1001)# ip address 172.16.1.1/24
ToR1(conf-if-vl-1001)# mtu 9216
ToR1(conf-if-vl-1001)# exit
ToR1(config)# interface ethernet1/1/3
ToR1(conf-if-eth1/1/3)# description ToR1-Hosts
ToR1(conf-if-eth1/1/3)# mtu 9216
ToR1(conf-if-eth1/1/3)# switchport mode trunk
ToR1(conf-if-eth1/1/3)# switchport trunk allowed vlan 1001
ToR1(conf-if-eth1/1/3)# exit
```

### 3. Configure BGP neighbors, and advertise the host subnet.

```
ToR1(config)# router bgp 65301
ToR1(config-router-bgp-65301)# router-id 10.0.2.1
ToR1(config-router-bgp-65301)# address-family ipv4 unicast
ToR1(configure-router-bgpv4-af)# network 172.16.1.0/24
ToR1(configure-router-bgpv4-af)# exit
ToR1(config-router-bgp-65301)# neighbor 10.3.1.0
ToR1(config-router-neighbor)# remote-as 65201
ToR1(config-router-neighbor)# no shutdown
ToR1(config-router-neighbor)# exit
ToR1(config-router-bgp-65301)# neighbor 10.4.1.0
ToR1(config-router-neighbor)# remote-as 65201
ToR1(config-router-neighbor)# no shutdown
ToR1(config-router-neighbor)# exit
```

## ToR 2 configuration

### 1. Configure an IP address on leaf-facing interfaces.

```
ToR2(config)# interface ethernet1/1/1
ToR2(conf-if-eth1/1/1)# description ToR2-Leaf3
ToR2(conf-if-eth1/1/1)# no switchport
ToR2(conf-if-eth1/1/1)# mtu 9216
ToR2(conf-if-eth1/1/1)# ip address 10.5.1.1/31
ToR2(conf-if-eth1/1/1)# exit
ToR2(config)# interface ethernet1/1/2
ToR2(conf-if-eth1/1/2)# description ToR2-Leaf4
ToR2(conf-if-eth1/1/2)# no switchport
ToR2(conf-if-eth1/1/2)# mtu 9216
ToR2(conf-if-eth1/1/2)# ip address 10.6.1.1/31
ToR2(conf-if-eth1/1/2)# exit
```

### 2. Configure a VLAN interface and a VLAN member for end devices.

```
ToR2(config)# interface vlan 2001
ToR2(conf-if-vl-2001)# ip address 172.16.2.1/24
ToR2(conf-if-vl-2001)# mtu 9216
ToR2(conf-if-vl-2001)# exit
ToR2(config)# interface ethernet1/1/3
ToR2(conf-if-eth1/1/3)# description ToR2-Hosts
ToR2(conf-if-eth1/1/3)# mtu 9216
ToR2(conf-if-eth1/1/3)# switchport mode trunk
ToR2(conf-if-eth1/1/3)# switchport trunk allowed vlan 2001
ToR2(conf-if-eth1/1/3)# exit
```

### 3. Configure BGP neighbors, and advertise the host subnet.

```
ToR2(config)# router bgp 65302
ToR2(config-router-bgp-65302)# router-id 10.0.2.2
ToR2(config-router-bgp-65302)# address-family ipv4 unicast
ToR2(configure-router-bgpv4-af)# network 172.16.2.0/24
ToR2(configure-router-bgpv4-af)# exit
ToR2(config-router-bgp-65302)# neighbor 10.5.1.0
ToR2(config-router-neighbor)# remote-as 65202
ToR2(config-router-neighbor)# no shutdown
ToR2(config-router-neighbor)# exit
ToR2(config-router-bgp-65302)# neighbor 10.6.1.0
ToR2(config-router-neighbor)# remote-as 65202
ToR2(config-router-neighbor)# no shutdown
ToR2(config-router-neighbor)# exit
```

## Debug BGP

Use the following procedure to debug BGP.

- To debug BGP:

```
debug ip bgp
```

## BGP commands

### activate

Enables the neighbor or peer group to be the current address-family identifier (AFI).

|                           |                                                                                                                                                                                                                                                                                                                                                    |
|---------------------------|----------------------------------------------------------------------------------------------------------------------------------------------------------------------------------------------------------------------------------------------------------------------------------------------------------------------------------------------------|
| <b>Syntax</b>             | <code>activate</code>                                                                                                                                                                                                                                                                                                                              |
| <b>Parameters</b>         | None                                                                                                                                                                                                                                                                                                                                               |
| <b>Default</b>            | Not configured                                                                                                                                                                                                                                                                                                                                     |
| <b>Command Mode</b>       | ROUTER-BGP-NEIGHBOR-AF                                                                                                                                                                                                                                                                                                                             |
| <b>Usage Information</b>  | This command exchanges IPv4 or IPv6 address family information with an IPv4, IPv6, and L2VPN neighbor. IPv4 unicast Address family is enabled by default. To activate IPv6 address family for IPv6 neighbor, use the <code>activate</code> command. To deactivate IPv4 address family for IPv6 neighbor, use the <code>no activate</code> command. |
| <b>Example</b>            | <pre>OS10(conf-router-neighbor)# address-family ipv4 unicast OS10(conf-router-bgp-neighbor-af)# activate</pre>                                                                                                                                                                                                                                     |
| <b>Supported Releases</b> | 10.2.0E or later                                                                                                                                                                                                                                                                                                                                   |

### add-path

Allows the system to advertise multiple paths for the same destination without replacing previous paths with new ones.

|                           |                                                                                                                                                                                                                                                                                                                                                                 |
|---------------------------|-----------------------------------------------------------------------------------------------------------------------------------------------------------------------------------------------------------------------------------------------------------------------------------------------------------------------------------------------------------------|
| <b>Syntax</b>             | <code>add-path {both <i>path count</i>   receive   send <i>path count</i>}</code>                                                                                                                                                                                                                                                                               |
| <b>Parameters</b>         | <ul style="list-style-type: none"><li>• <code>both <i>path count</i></code> — Enter the number of paths to advertise to the peer, from 2 to 64.</li><li>• <code>receive</code> — Receive multiple paths from the peer.</li><li>• <code>send <i>path count</i></code> — Enter the number of multiple paths to send multiple to the peer, from 2 to 64.</li></ul> |
| <b>Default</b>            | Not configured                                                                                                                                                                                                                                                                                                                                                  |
| <b>Command Mode</b>       | ROUTER-BGP-NEIGHBOR-AF                                                                                                                                                                                                                                                                                                                                          |
| <b>Usage Information</b>  | Advertising multiple paths to peers for the same address prefix without replacing the existing path with a new path reduces convergence times. The <code>no</code> version of this command disables the multiple path advertisements for the same destination.                                                                                                  |
| <b>Example (IPv4)</b>     | <pre>OS10(conf-router-bgp-af)# add-path both 64</pre>                                                                                                                                                                                                                                                                                                           |
| <b>Example (IPv6)</b>     | <pre>OS10(conf-router-bgpv6-af)# add-path both 64</pre>                                                                                                                                                                                                                                                                                                         |
| <b>Example (Receive)</b>  | <pre>OS10(conf-router-bgpv6-af)# add-path receive</pre>                                                                                                                                                                                                                                                                                                         |
| <b>Supported Releases</b> | 10.2.0E or later                                                                                                                                                                                                                                                                                                                                                |

### address-family

Enters Global Address Family Configuration mode for the IP address family.

|                   |                                                                                                                     |
|-------------------|---------------------------------------------------------------------------------------------------------------------|
| <b>Syntax</b>     | <code>address-family {[ipv4   ipv6] unicast}</code>                                                                 |
| <b>Parameters</b> | <ul style="list-style-type: none"><li>• <code>ipv4 unicast</code> — Enter an IPv4 unicast address family.</li></ul> |

- `ipv6 unicast` — Enter an IPv6 unicast address family.

|                               |                                                                                                                                                                                              |
|-------------------------------|----------------------------------------------------------------------------------------------------------------------------------------------------------------------------------------------|
| <b>Default</b>                | None                                                                                                                                                                                         |
| <b>Command Mode</b>           | ROUTER-BGP                                                                                                                                                                                   |
| <b>Usage Information</b>      | This command applies to all IPv4 or IPv6 peers belonging to the template or neighbors only. The <code>no</code> version of this command deletes the subsequent address-family configuration. |
| <b>Example (IPv4 Unicast)</b> | <pre>OS10(config)# router bgp 3 OS10(conf-router-bgp-3)# address-family ipv4 unicast OS10(conf-router-bgpv4-af)#</pre>                                                                       |
| <b>Example (IPv6 Unicast)</b> | <pre>OS10(config)# router bgp 4 OS10(conf-router-bgp-4)# address-family ipv6 unicast OS10(conf-router-bgpv6-af)#</pre>                                                                       |
| <b>Supported Releases</b>     | 10.3.0E or later                                                                                                                                                                             |

## advertisement-interval

Sets the minimum time interval for advertisement between the BGP neighbors or within a BGP peer group.

|                           |                                                                                                                                                                                                  |
|---------------------------|--------------------------------------------------------------------------------------------------------------------------------------------------------------------------------------------------|
| <b>Syntax</b>             | <code>advertisement-interval seconds</code>                                                                                                                                                      |
| <b>Parameters</b>         | <code>seconds</code> —Enter the time interval value in seconds between BGP advertisements, from 1 to 600.                                                                                        |
| <b>Default</b>            | EBGP 30 seconds, IBGP 5 seconds                                                                                                                                                                  |
| <b>Command Mode</b>       | ROUTER-NEIGHBOR                                                                                                                                                                                  |
| <b>Usage Information</b>  | The time interval applies to all peer group members of the template in ROUTER-TEMPLATE mode. The <code>no</code> version of this command resets the advertisement-interval value to the default. |
| <b>Example</b>            | <pre>OS10(conf-router-neighbor)# advertisement-interval 50</pre>                                                                                                                                 |
| <b>Supported Releases</b> | 10.3.0E or later                                                                                                                                                                                 |

## advertisement-start

Delays initiating the OPEN message for the specified time.

|                           |                                                                                                                                                                                              |
|---------------------------|----------------------------------------------------------------------------------------------------------------------------------------------------------------------------------------------|
| <b>Syntax</b>             | <code>advertisement-start seconds</code>                                                                                                                                                     |
| <b>Parameters</b>         | <code>seconds</code> —Enter the time interval value, in seconds, before starting to send the BGP OPEN message, from 0 to 240.                                                                |
| <b>Default</b>            | Not configured                                                                                                                                                                               |
| <b>Command Mode</b>       | ROUTER-NEIGHBOR                                                                                                                                                                              |
| <b>Usage Information</b>  | The time interval applies to all the peer group members of the template in ROUTER-TEMPLATE mode. The <code>no</code> version of this command disables the advertisement-start time interval. |
| <b>Example</b>            | <pre>OS10(conf-router-neighbor)# advertisement-start 30</pre>                                                                                                                                |
| <b>Supported Releases</b> | 10.3.0E or later                                                                                                                                                                             |

## aggregate-address

Summarizes a range of prefixes to minimize the number of entries in the routing table.

|                           |                                                                                                                                                                                                                                                                                                                                                                                                                                                                                                                                                                                                                                                          |
|---------------------------|----------------------------------------------------------------------------------------------------------------------------------------------------------------------------------------------------------------------------------------------------------------------------------------------------------------------------------------------------------------------------------------------------------------------------------------------------------------------------------------------------------------------------------------------------------------------------------------------------------------------------------------------------------|
| <b>Syntax</b>             | <code>aggregate-address address/mask [as-set] [summary-only] [advertise-map map-name] {attribute-map route-map-name} [suppress-map route-map-name]</code>                                                                                                                                                                                                                                                                                                                                                                                                                                                                                                |
| <b>Parameters</b>         | <ul style="list-style-type: none"><li>• <code>address/mask</code> — Enter the IP address and mask.</li><li>• <code>as-set</code> — (Optional) Generates AS set-path information.</li><li>• <code>summary-only</code> — (Optional) Filters more specific routes from updates.</li><li>• <code>advertise-map map-name</code> — (Optional) Enter the map name to advertise.</li><li>• <code>attribute-map route-map-name</code> — (Optional) Enter the route-map name to set aggregate attributes.</li><li>• <code>suppress-map route-map-name</code> — (Optional) Enter the route-map name to conditionally filter specific routes from updates.</li></ul> |
| <b>Default</b>            | None                                                                                                                                                                                                                                                                                                                                                                                                                                                                                                                                                                                                                                                     |
| <b>Command Mode</b>       | ROUTER-BGPv4-AF                                                                                                                                                                                                                                                                                                                                                                                                                                                                                                                                                                                                                                          |
| <b>Usage Information</b>  | At least one of the routes that is included in the aggregate address must be in the BGP routing table for the configured aggregate to become active. If routes within the aggregate are constantly changing, do not add the <code>as-set</code> parameter to the aggregate because the aggregate flaps to track changes in the AS_PATH. The <code>no</code> version of this command disables the aggregate-address configuration.                                                                                                                                                                                                                        |
| <b>Example</b>            | <pre>OS10(conf-router-bgpv4-af)# aggregate-address 6.1.0.0/16 summary-only</pre>                                                                                                                                                                                                                                                                                                                                                                                                                                                                                                                                                                         |
| <b>Supported Releases</b> | 10.3.0E or later                                                                                                                                                                                                                                                                                                                                                                                                                                                                                                                                                                                                                                         |

## allowas-in

Configures the number of times the local AS number can appear in the BGP AS\_PATH path attribute before the switch rejects the route.

|                           |                                                                                                                                                                                                                                       |
|---------------------------|---------------------------------------------------------------------------------------------------------------------------------------------------------------------------------------------------------------------------------------|
| <b>Syntax</b>             | <code>allowas-in as-number</code>                                                                                                                                                                                                     |
| <b>Parameters</b>         | <code>as-number</code> —Enter the number of occurrences for a local AS number, from 1 to 10.                                                                                                                                          |
| <b>Default</b>            | Disabled                                                                                                                                                                                                                              |
| <b>Command Mode</b>       | ROUTER-BPG-NEIGHBOR-AF                                                                                                                                                                                                                |
| <b>Usage Information</b>  | Use this command to enable the BGP speaker to accept a route with the local AS number in updates received from a peer for the specified number of times. The <code>no</code> version of this command resets the value to the default. |
| <b>Example (IPv4)</b>     | <pre>OS10(config-router-neighbor)# address-family ipv4 unicast OS10(conf-router-bgp-neighbor-af)# allowas-in 5</pre>                                                                                                                  |
| <b>Example (IPv6)</b>     | <pre>OS10(conf-router-template)# address-family ipv6 unicast OS10(conf-router-bgp-template-af)# allowas-in 5</pre>                                                                                                                    |
| <b>Example (I2vpn)</b>    | <pre>OS10(config-router-neighbor)# address-family l2vpn evpn OS10(config-router-bgp-neighbor-af)# allowas-in 3</pre>                                                                                                                  |
| <b>Supported Releases</b> | 10.3.0E or later                                                                                                                                                                                                                      |

## always-compare-med

Compares MULTI\_EXIT\_DISC (MED) attributes in the paths that are received from different neighbors.

**Syntax** `always-compare-med`

**Parameters** None

**Default** Disabled

**Command Mode** ROUTER-BGP

**Usage Information** After you use this command, use the `clear ip bgp *` command to recompute the best path. The no version of this command resets the value to the default.

**NOTE:** To configure these settings for a nondefault VRF instance, first enter the ROUTER-CONFIG-VRF sub mode using the following commands:

1. Enter the ROUTER BGP mode using the `router bgp as-number` command.
2. From the ROUTER BGP mode, enter ROUTER BGP VRF mode using the `vrf vrf-name` command.

### Example

```
OS10(conf-router-bgp-10)# always-compare-med
```

**Supported Releases** 10.2.0E or later

## as-notation

Changes the AS number notation format and requires four-octet-assupport.

**Syntax** `as-format {asdot | asdot+ | asplain}`

- Parameters**
- `asdot` — Specify the AS number notation in asdot format.
  - `asdot+` — Specify the AS number notation in asdot+ format.
  - `asplain` — Specify the AS number notation in asplain format.

**Defaults** `asplain`

**Command Modes** ROUTER-BGP

**Usage Information** **NOTE:** To configure these settings for a non-default VRF instance, first enter the ROUTER-CONFIG-VRF sub mode using the following commands:

1. Enter the ROUTER BGP mode using the `router bgp as-number` command.
2. From the ROUTER BGP mode, enter ROUTER BGP VRF mode using the `vrf vrf-name` command.

### Example

```
OS10(conf-router-bgp-2)# as-notation asdot
OS10(conf-router-bgp-2)# as-notation asdot+
OS10(conf-router-bgp-2)# as-notation asplain
```

**Supported Releases** 10.1.0E or later

## bestpath as-path

Configures the AS path selection criteria for best path computation.

**Syntax** `bestpath as-path {ignore | mutlipath-relax}`

- Parameters**
- `ignore` — Enter to ignore the AS PATH in BGP best path calculations.

- `mutlipath-relax` — Enter to include prefixes received from different AS paths during multipath calculation.

**Default** Enabled

**Command Mode** ROUTER-BGP

**Usage Information** To enable load-balancing across different EBGP peers, configure the `mutlipath-relax` option. If you configure both `ignore` or `mutlipath-relax` options simultaneously, a system-generated error message appears. The `no` version of this command disables configuration.

**NOTE:** To configure these settings for a nondefault VRF instance, first enter the `ROUTER-CONFIG-VRF` sub mode using the following commands:

1. Enter the ROUTER BGP mode using the `router bgp as-number` command.
2. From the ROUTER BGP mode, enter ROUTER BGP VRF mode using the `vrf vrf-name` command.

**Example**

```
OS10(conf-router-bgp-10)# bestpath as-path multipath-relax
```

**Supported Releases** 10.3.0E or later

## bestpath med

Changes the best path MED attributes during MED comparison for path selection.

**Syntax** `bestpath med {confed | missing-as-worst}`

- Parameters**
- `confed` — Compare MED among BGP confederation paths.
  - `missing-as-worst` — Treat missing MED as the least preferred path.

**Default** Disabled

**Command Mode** ROUTER-BGP

**Usage Information** Before you apply this command, use the `always-compare-med` command. The `no` version of this command resets the MED comparison influence.

**NOTE:** To configure these settings for a nondefault VRF instance, you must first enter the `ROUTER-CONFIG-VRF` sub mode using the following commands:

1. Enter the ROUTER BGP mode using the `router bgp as-number` command.
2. From the ROUTER BGP mode, enter the ROUTER BGP VRF mode using the `vrf vrf-name` command.

**Example**

```
OS10(conf-router-bgp-2)# bestpath med confed
```

**Supported Releases** 10.3.0E or later

## bestpath router-id

Ignores comparing router-id information for external paths during best-path selection.

**Syntax** `bestpath router-id {ignore}`

**Parameters** `ignore` — Enter to ignore AS path for best-path computation.

**Default** Enabled

**Command Mode** ROUTER-BGP



## Usage Information

If you do not receive the same router ID for multiple paths, select the path that you received first. If you received the same router ID for multiple paths, ignore the path information. The `no` version of this command resets the value to the default.

**NOTE:** To configure these settings for a nondefault VRF instance, first enter the `ROUTER-CONFIG-VRF` sub mode using the following commands:

1. Enter the ROUTER BGP mode using the `router bgp as-number` command.
2. From the ROUTER BGP mode, enter ROUTER BGP VRF mode using the `vrf vrf-name` command.

## Example

```
OS10(conf-router-bgp-2)# bestpath router-id ignore
```

## Supported Releases

10.3.0E or later

## clear ip bgp

Resets BGP IPv4 or IPv6 neighbor sessions.

### Syntax

```
clear ip bgp [vrf vrf-name] {ipv4-address | ipv6-address | * | interface interface-type} [ipv4 | ipv6 | soft in]
```

### Parameters

- `vrf vrf-name` — (OPTIONAL) Enter `vrf` then the name of the VRF to clear IPv4 or IPv6 BGP neighbor sessions corresponding to that VRF.
- `IPv4-address` — Enter an IPv4 address to clear a BGP neighbor configuration.
- `IPv6-address` — Enter an IPv6 address to clear a BGP neighbor configuration.
- `*` — Clears all BGP sessions.
- `interface interface-type` — Clears BGP information that is learned through an unnumbered neighbor. Enter one of the following interface types:
  - `ethernet node/slot/port[:subport]` — Display Ethernet interface information.
  - `port-channel id-number` — Display port channel interface IDs, from 1 to 128.
  - `vlan vlan-id` — Display the VLAN interface number, from 1 to 4093.
- `soft` — (Optional) Enter to configure and activate policies without resetting the BGP TCP session — BGP soft reconfiguration.
- `in` — (Optional) Enter to activate only ingress (inbound) policies.

### Default

Not configured

### Command Mode

EXEC

### Usage

None.

### Information

### Example

```
OS10# clear ip bgp 1.1.15.4
```

The following is an example to clear BGP information learned through an unnumbered neighbor:

```
OS10# clear ip bgp interface ethernet 1/1/1
```

## Supported Releases

10.3.0E or later

## clear ip bgp \*

Resets BGP sessions. The `soft` parameter, BGP soft reconfiguration, clears policies without resetting the TCP connection.

### Syntax

```
clear ip bgp * [soft in]
```

|                           |                                                                                                                                                                                                                                                                                                                                                       |
|---------------------------|-------------------------------------------------------------------------------------------------------------------------------------------------------------------------------------------------------------------------------------------------------------------------------------------------------------------------------------------------------|
| <b>Parameters</b>         | <ul style="list-style-type: none"> <li>• <code>*</code> — Enter to clear all BGP sessions.</li> <li>• <code>soft</code> — (Optional) Enter to configure and activate policies without resetting the BGP TCP session — BGP soft reconfiguration.</li> <li>• <code>in</code> — (Optional) Enter to activate only ingress (inbound) policies.</li> </ul> |
| <b>Default</b>            | Not configured                                                                                                                                                                                                                                                                                                                                        |
| <b>Command Mode</b>       | EXEC                                                                                                                                                                                                                                                                                                                                                  |
| <b>Usage Information</b>  | None                                                                                                                                                                                                                                                                                                                                                  |
| <b>Example</b>            | <pre>OS10# clear ip bgp *</pre>                                                                                                                                                                                                                                                                                                                       |
| <b>Supported Releases</b> | 10.3.0E or later                                                                                                                                                                                                                                                                                                                                      |

## clear ip bgp dampening

Clears the path information of the dampened and undampened prefixes.

|                           |                                                                                                                                                                                                                                                                                                                                                                         |
|---------------------------|-------------------------------------------------------------------------------------------------------------------------------------------------------------------------------------------------------------------------------------------------------------------------------------------------------------------------------------------------------------------------|
| <b>Syntax</b>             | <code>clear ip bgp dampening [vrf vrf-name] [ipv4-prefix   ipv6-prefix]</code>                                                                                                                                                                                                                                                                                          |
| <b>Parameters</b>         | <ul style="list-style-type: none"> <li>• <code>vrf vrf-name</code> — (OPTIONAL) Enter <code>vrf</code> then the name of the VRF to clear dampened paths information.</li> <li>• <code>ipv4-prefix</code> — (Optional) Enter an IPv4 prefix of the dampened path.</li> <li>• <code>ipv6-prefix</code> — (Optional) Enter an IPv6 prefix of the dampened path.</li> </ul> |
| <b>Default</b>            | Not configured                                                                                                                                                                                                                                                                                                                                                          |
| <b>Command Mode</b>       | EXEC                                                                                                                                                                                                                                                                                                                                                                    |
| <b>Usage Information</b>  | None                                                                                                                                                                                                                                                                                                                                                                    |
| <b>Example</b>            | <pre>OS10# clear ip bgp dampening 1.1.15.5</pre>                                                                                                                                                                                                                                                                                                                        |
| <b>Supported Releases</b> | 10.3.0E or later                                                                                                                                                                                                                                                                                                                                                        |

## clear ip bgp flap-statistics

Clears all or specific IPv4 or IPv6 flap counts of prefixes.

|                          |                                                                                                                                                                                                                                                                                                                                                                                                                                                                                                                                                                                                                                                                          |
|--------------------------|--------------------------------------------------------------------------------------------------------------------------------------------------------------------------------------------------------------------------------------------------------------------------------------------------------------------------------------------------------------------------------------------------------------------------------------------------------------------------------------------------------------------------------------------------------------------------------------------------------------------------------------------------------------------------|
| <b>Syntax</b>            | <code>clear ip bgp [vrf vrf-name] [ipv4-address   ipv6-address] flap-statistics [ipv4-prefix   ipv6-prefix]</code>                                                                                                                                                                                                                                                                                                                                                                                                                                                                                                                                                       |
| <b>Parameters</b>        | <ul style="list-style-type: none"> <li>• <code>vrf vrf-name</code> — (OPTIONAL) Enter <code>vrf</code> then the name of the VRF to clear flap statistics information.</li> <li>• <code>ipv4-address</code> — (Optional) Enter an IPv4 address to clear the flap counts of the prefixes learned from the given peer.</li> <li>• <code>ipv6-address</code> — (Optional) Enter an IPv6 address to clear the flap counts.</li> <li>• <code>ipv4-prefix</code> — (Optional) Enter an IPv4 prefix to clear the flap counts of the given prefix.</li> <li>• <code>ipv6-prefix</code> — (Optional) Enter an IPv6 prefix to clear the flap counts of the given prefix.</li> </ul> |
| <b>Default</b>           | Not configured                                                                                                                                                                                                                                                                                                                                                                                                                                                                                                                                                                                                                                                           |
| <b>Command Mode</b>      | EXEC                                                                                                                                                                                                                                                                                                                                                                                                                                                                                                                                                                                                                                                                     |
| <b>Usage Information</b> | None                                                                                                                                                                                                                                                                                                                                                                                                                                                                                                                                                                                                                                                                     |

|                               |                                                           |
|-------------------------------|-----------------------------------------------------------|
| <b>Example (All Prefixes)</b> | <pre>OS10# clear ip bgp flap-statistics</pre>             |
| <b>Example (IPv4)</b>         | <pre>OS10# clear ip bgp 1.1.15.4 flap-statistics</pre>    |
| <b>Example (Given Prefix)</b> | <pre>OS10# clear ip bgp flap-statistics 1.1.15.0/24</pre> |
| <b>Supported Releases</b>     | 10.3.0E or later                                          |

## connection-retry-timer

Configures the timer to retry the connection to BGP neighbor or peer group.

|                           |                                                                                                                               |
|---------------------------|-------------------------------------------------------------------------------------------------------------------------------|
| <b>Syntax</b>             | <code>connection-retry-timer <i>retry-timer-value</i></code>                                                                  |
| <b>Parameters</b>         | <i>retry-timer-value</i> — Enter the time interval in seconds, ranging from 10 to 65535.                                      |
| <b>Defaults</b>           | 60 seconds                                                                                                                    |
| <b>Command Modes</b>      | CONFIG-ROUTER-NEIGHBOR<br>CONFIG-ROUTER-TEMPLATE                                                                              |
| <b>Usage Information</b>  | The <code>no</code> version of this command resets the timer to default value..                                               |
| <b>Example</b>            | <pre>OS10(config-router-neighbor)# connection-retry-timer 1000 OS10(config-router-template)# connection-retry-timer 100</pre> |
| <b>Supported Releases</b> | 10.3.0E or later                                                                                                              |

## confederation

Configures an identifier for a BGP confederation.

|                          |                                                                                                                                                                                                                                                                                                                                                                                                                                                                                                                                                                                                                                                                                                                                                                          |
|--------------------------|--------------------------------------------------------------------------------------------------------------------------------------------------------------------------------------------------------------------------------------------------------------------------------------------------------------------------------------------------------------------------------------------------------------------------------------------------------------------------------------------------------------------------------------------------------------------------------------------------------------------------------------------------------------------------------------------------------------------------------------------------------------------------|
| <b>Syntax</b>            | <code>confederation {<i>identifier as-num</i>   <i>peers as-number</i>}</code>                                                                                                                                                                                                                                                                                                                                                                                                                                                                                                                                                                                                                                                                                           |
| <b>Parameters</b>        | <ul style="list-style-type: none"> <li><i>identifier as-num</i> —Enter an AS number, from 0 to 65535 for 2 bytes, 1 to 4294967295 for 4 bytes, or 0.1 to 65535.65535 for dotted format.</li> <li><i>peers as-number</i>—Enter an AS number for peers in the BGP confederation, from 1 to 4294967295.</li> </ul>                                                                                                                                                                                                                                                                                                                                                                                                                                                          |
| <b>Default</b>           | Not configured                                                                                                                                                                                                                                                                                                                                                                                                                                                                                                                                                                                                                                                                                                                                                           |
| <b>Command Mode</b>      | ROUTER-BGP                                                                                                                                                                                                                                                                                                                                                                                                                                                                                                                                                                                                                                                                                                                                                               |
| <b>Usage Information</b> | Configure your system to accept 4-byte formats before entering a 4-byte AS number. All routers in the Confederation must be 4-byte or 2-byte identified routers. You cannot have a mix of 2-byte and 4-byte identified routers. The autonomous system number that you configure in this command is visible to the EBGP neighbors. Each autonomous system is fully meshed and contains a few connections to other autonomous systems. The next-hop (MED) and local preference information is preserved throughout the confederation. The system accepts confederation EBGP peers without a LOCAL_PREF attribute. OS10 sends AS_CONFED_SET and accepts AS_CONFED_SET and AS_CONF_SEQ. The <code>no</code> version of this command deletes the confederation configuration. |

 **NOTE:** To configure these settings for a nondefault VRF instance, you must first enter the ROUTER-CONFIG-VRF sub mode using the following commands:

1. Enter the ROUTER BGP mode using the `router bgp as-number` command.

2. From the ROUTER BGP mode, enter the ROUTER BGP VRF mode using the `vrf vrf-name` command.

**Example (Identifier)**

```
OS10 (conf-router-bgp-2) # confederation identifier 1
```

**Example (Peers)**

```
OS10 (conf-router-bgp-2) # confederation peers 2
```

**Supported Releases** 10.3.0E or later

## client-to-client

Enables route reflection between clients in a cluster.

**Syntax** `client-to-client {reflection}`

**Parameters** `reflection` — Enter to enable reflection of routes allowed in a cluster.

**Default** Enabled

**Command Mode** ROUTER-BGP

**Usage Information** Configure the route reflector to enable route reflection between all clients. You must fully mesh all clients before you disable route reflection. The `no` version of this command disables route reflection in a cluster.

**NOTE:** To configure these settings for a nondefault VRF instance, you must first enter the ROUTER-CONFIG-VRF sub mode using the following commands:

1. Enter the ROUTER BGP mode using the `router bgp as-number` command.
2. From the ROUTER BGP mode, enter the ROUTER BGP VRF mode using the `vrf vrf-name` command.

**Example**

```
OS10 (conf-router-bgp-2) # client-to-client reflection
```

**Supported Releases** 10.2.0E or later

## cluster-id

Assigns a cluster ID to a BGP cluster with multiple route reflectors.

**Syntax** `cluster-id {number | ip-address}`

**Parameters**

- `number`—Enter a route reflector cluster ID as a 32-bit number, from 1 to 4294967295.
- `ip-address`—Enter an IP address as the route-reflector cluster ID.

**Default** Router ID

**Command Mode** ROUTER-BGP

**Usage Information** If a cluster contains only one route reflector, the cluster ID is the route reflector's router ID. For redundancy, a BGP cluster may contain two or more route reflectors. Without a cluster ID, the route reflector cannot recognize route updates from the other route reflectors within the cluster. The default format to display the cluster ID is A.B.C.D format. If you enter the cluster ID as an integer, an integer displays. The `no` version of this command resets the value to the default.

**NOTE:** To configure these settings for a nondefault VRF instance, you must first enter the ROUTER-CONFIG-VRF sub mode using the following commands:

1. Enter the ROUTER BGP mode using the `router bgp as-number` command.

- From the ROUTER BGP mode, enter the ROUTER BGP VRF mode using the `vrf vrf-name` command.

**Example**

```
OS10(conf-router-bgp-10)# cluster-id 3.3.3.3
```

**Supported Releases**

10.3.0E or later

## bgp dampening

Enables BGP route-flap dampening and configures the dampening parameters.

**Syntax**

```
bgp dampening [half-life | reuse-limit | suppress-limit | max-suppress-time | route-map-name]
```

**Parameters**

- half-life* — (Optional) Enter the half-life time, in minutes, after which the penalty decreases. After the router assigns a penalty of 1024 to a route, the penalty decreases by half after the half-life period expires, from 1 to 45.
- reuse-limit* — (Optional) Enter a reuse-limit value, which compares to the flapping route's penalty value. If the penalty value is less than the reuse value, the flapping route advertises again and is not suppressed, from 1 to 20000.
- suppress-limit* — (Optional) Enter a suppress-limit value, which compares to the flapping route's penalty value. If the penalty value is greater than the suppress value, the flapping route is no longer advertised, from 1 to 20000.
- max-suppress-time* — (Optional) Enter the maximum number of minutes a route is suppressed, from 1 to 255.
- route-map-name* — (Optional) Enter the name of the route-map.

**Defaults**

*half-life* 15; *reuse-limit* 750; *suppress-limit* 2000; *max-suppress-time* 60

**Command Mode**

ROUTER-BGP-AF

**Usage Information**

To reduce the instability of the BGP process, setup route flap dampening parameters. After setting up the dampening parameters, clear information about route dampening and return the suppressed routes to the Active state. You can also view statistics on route flapping or change the path selection from Default Deterministic mode to Non-Deterministic mode. The `no` version of this command resets the value to the default.

**Example**

```
OS10(conf-router-bgpv4-af)# dampening 2 751 2001 51 map1
```

**Supported Releases**

10.3.0E or later

## debug ip bgp

Enables Border Gateway Protocol (BGP) debugging and displays messages related to processing of BGP.

**Syntax**

```
debug ip bgp
```

**Parameters**

None

**Defaults**

None

**Command Modes**

EXEC

**Usage Information**

The `debug ip bgp` command does not display the logs on the console. they are saved in the journal log. The `no debug ip bgp` command stops displaying messages related to processing of BGP.

**Example**

```
OS10# debug ip bgp
```

**Supported Releases** OS10 legacy command.

## description

Configures a description for the BGP neighbor or for peer template.

**Syntax** `description text`

**Parameters** `text` — Enter a description for the BGP neighbor or peer template.

**Default** None

**Command Mode** ROUTER-BGP-NEIGHBOR  
ROUTER-BGP-TEMPLATE

**Usage Information**

- To use special characters as a part of the description string, enclose the string in double quotes.
- To use comma as a part of the description string add double back slash before the comma.
- The `no` version of this command removes the description.

### Example

```
OS10# configure terminal
OS10(config)# router bgp 100
OS10(config-router-bgp-100)# neighbor 8.8.8.8
OS10(config-router-neighbor)# description n1_abcd
OS10(config-router-neighbor)# exit
OS10(config-router-bgp-100)# template t1
OS10(config-router-template)# description peer_template_1_abcd
```

**Supported Releases** 10.4.1.0 or later

## default-metric

Assigns a default-metric of redistributed routes to locally originated routes.

**Syntax** `default-metric number`

**Parameters** `number` — Enter a number as the metric to assign to routes from other protocols, from 1 to 4294967295.

**Default** Disabled

**Command Mode** ROUTER-BGP

**Usage Information** Assigns a metric for locally-originated routes such as redistributed routes. After you redistribute routes in BGP, use this command to reset the metric value — the new metric does not immediately take effect. The new metric takes effect only after you disable and re-enable route redistribution for a specified protocol. To re-enable route distribution use the `redistribute {connected [route-map map-name] | ospf process-id | static [route-map map-name]}` command, or use the `clear ip bgp *` command after you reset BGP. The `no` version of this command removes the default metric value.

### Example (IPv4)

```
OS10(conf-router-bgpv4-af)# default-metric 60
```

### Example (IPv6)

```
OS10(conf-router-bgpv6-af)# default-metric 60
```

**Supported Releases** 10.3.0E or later

## default-originate

Configures the default route to a BGP peer or neighbor.

|                     |                                                                                                        |
|---------------------|--------------------------------------------------------------------------------------------------------|
| <b>Syntax</b>       | <code>default-originate [route-map route-map-name]</code>                                              |
| <b>Parameters</b>   | <code>route-map route-map-name</code> —(Optional) Enter a route-map name. A maximum of 140 characters. |
| <b>Default</b>      | Enabled                                                                                                |
| <b>Command Mode</b> | ROUTER-BGP-NEIGHBOR-AF<br>ROUTER-TEMPLATE-AF                                                           |

**Usage Information** The `no` version of this command removes the default route.

### Example

```
OS10(conf-router-bgp-10)# template lunar
OS10(conf-router-bgp-template)# address-family ipv6 unicast
OS10(conf-router-template-af)# default-originate route-map rmap-bgp
```

**Supported Releases** 10.4.1.0 or later

## distance bgp

Sets the administrative distance for BGP routes.

|                      |                                                                                                                                                                                                                                                                                                                                                                                                                                                                          |
|----------------------|--------------------------------------------------------------------------------------------------------------------------------------------------------------------------------------------------------------------------------------------------------------------------------------------------------------------------------------------------------------------------------------------------------------------------------------------------------------------------|
| <b>Syntax</b>        | <code>distance bgp external-distance internal-distance local-distance</code>                                                                                                                                                                                                                                                                                                                                                                                             |
| <b>Parameters</b>    | <ul style="list-style-type: none"><li>• <code>external-distance</code>—Enter a number to assign to routes learned from a neighbor external to the AS, from 1 to 255.</li><li>• <code>internal-distance</code>—Enter a number to assign to routes learned from a router within the AS, from 1 to 255.</li><li>• <code>local-distance</code>—Enter a number to assign to routes learned from networks listed in the <code>network</code> command, from 1 to 255.</li></ul> |
| <b>Defaults</b>      | <ul style="list-style-type: none"><li>• <code>external-distance</code>—20</li><li>• <code>internal-distance</code>—200</li><li>• <code>local-distance</code>—200</li></ul>                                                                                                                                                                                                                                                                                               |
| <b>Command Modes</b> | <ul style="list-style-type: none"><li>• CONFIG-ROUTER-BGP-ADDRESS-FAMILY</li><li>• CONFIG-ROUTER-BGP-VRF-ADDRESS-FAMILY</li></ul>                                                                                                                                                                                                                                                                                                                                        |

**Usage Information** This command is used to configure administrative distance for eBGP route, iBGP route, and local BGP route. Administrative distance indicates the reliability of the route; the lower the administrative distance, the more reliable the route is. Routes that are assigned an administrative distance of 255 are not installed in the routing table. Routes from confederations are treated as iBGP routes.

### Examples

Default VRF:

IPv4

```
OS10# configure terminal
OS10(config)# router bgp 100
OS10(config-router-bgp-100)# address-family ipv4 unicast
OS10(configure-router-bgpv4-af)# distance bgp 10 200 210
```

IPv6

```
OS10# configure terminal
OS10(config)# router bgp 100
OS10(config-router-bgp-100)# address-family ipv6 unicast
OS10(configure-router-bgpv6-af)# distance bgp 10 200 210
```

Non-default VRF

```
OS10(config-router-bgp-100)# vrf blue
OS10(config-router-bgp-100-vrf)# address-family ipv4 unicast
OS10(configure-router-bgpv4-vrf-af)# distance bgp 21 200 200
OS10(config-router-bgp-100-vrf)# address-family ipv6 unicast
OS10(configure-router-bgpv6-vrf-af)# distance bgp 21 201 250
```

**Supported Releases** 10.4.2.0 or later

## distribute-list

Distributes BGP information through an established prefix list.

**Syntax** `distribute-list prefix-list-name {in | out}`

**Parameters**

- *prefix-list-name*—Enter the name of established prefix list.
- *in*—Enter to distribute inbound traffic.
- *out*—Enter to distribute outbound traffic.

**Defaults** None

**Command Modes** ROUTER-BGP-NEIGHBOR-AF  
ROUTER-TEMPLATE-AF

**Usage Information** The `no` version of this command removes the `route-map`.

### Example

```
OS10(conf-router-neighbor)# address-family ipv4 unicast
OS10(conf-router-bgp-neighbor-af)# distribute-list inbgg in
```

```
OS10(conf-router-template)# address-family ipv4 unicast
OS10(conf-router-bgp-template-af)# distribute-list outbgg out
```

**Supported Releases** 10.4.1.0 or later

## bgp default local-preference

Changes the default local preference value for routes exchanged between internal BGP peers.

**Syntax** `default local-preference number`

**Parameters** *number* — Enter a number to assign to routes as the degree of preference for those routes. When routes compare, the route with the higher degree of preference or the local preference value is most preferred, from 1 to 4294967295.

**Default** 100

**Command Mode** ROUTER-BGP

**Usage Information** All routers apply this command setting within the AS. The `no` version of this command deletes local preference value.

### Example

```
OS10(conf-router-bgp-1)# default local-preference 200
```

**Supported Releases** 10.3.0E or later



## ebgp-multihop

Allows eBGP neighbors on indirectly connected networks.

|                           |                                                                                                                                                                                                                                                                                |
|---------------------------|--------------------------------------------------------------------------------------------------------------------------------------------------------------------------------------------------------------------------------------------------------------------------------|
| <b>Syntax</b>             | <code>ebgp-multihop hop count</code>                                                                                                                                                                                                                                           |
| <b>Parameters</b>         | <code>hop count</code> — Enter a value for the number of hops, from 1 to 255.                                                                                                                                                                                                  |
| <b>Default</b>            | 1 for eBGP. 255 for iBGP.                                                                                                                                                                                                                                                      |
| <b>Command Mode</b>       | ROUTER-NEIGHBOR                                                                                                                                                                                                                                                                |
| <b>Usage Information</b>  | This command avoids installation of default multihop peer routes to prevent loops and creates neighbor relationships between peers. Networks indirectly connected are not valid for best path selection. The <code>no</code> version of this command removes multihop session. |
| <b>Example</b>            | <pre>OS10(conf-router-neighbor)# ebgp-multihop 2</pre>                                                                                                                                                                                                                         |
| <b>Supported Releases</b> | 10.3.0E or later                                                                                                                                                                                                                                                               |

## enforce-first-as

Enforces the first AS in the AS path of the route received from an EBGP peer to be the same as the configured remote AS.

|                           |                                                                                                                                                                                                                                                                                                                                                                                                                                                                                                                                                                                                                                                                                                                                                                                                                                                                           |
|---------------------------|---------------------------------------------------------------------------------------------------------------------------------------------------------------------------------------------------------------------------------------------------------------------------------------------------------------------------------------------------------------------------------------------------------------------------------------------------------------------------------------------------------------------------------------------------------------------------------------------------------------------------------------------------------------------------------------------------------------------------------------------------------------------------------------------------------------------------------------------------------------------------|
| <b>Syntax</b>             | <code>enforce-first-as</code>                                                                                                                                                                                                                                                                                                                                                                                                                                                                                                                                                                                                                                                                                                                                                                                                                                             |
| <b>Parameters</b>         | None                                                                                                                                                                                                                                                                                                                                                                                                                                                                                                                                                                                                                                                                                                                                                                                                                                                                      |
| <b>Default</b>            | Enabled                                                                                                                                                                                                                                                                                                                                                                                                                                                                                                                                                                                                                                                                                                                                                                                                                                                                   |
| <b>Command Mode</b>       | ROUTER-BGP                                                                                                                                                                                                                                                                                                                                                                                                                                                                                                                                                                                                                                                                                                                                                                                                                                                                |
| <b>Usage Information</b>  | To verify statistics of routes rejected, use the <code>show ip bgp neighbors</code> command. If routes are rejected, the session is reset. In the event of a failure, the existing BGP sessions flap. For updates received from EBGP peers, BGP ensures that the first AS of the first AS segment is always the AS of the peer, otherwise the update drops and the counter increments. The <code>no</code> version of this command turns off the default.<br><b>NOTE:</b> To configure these settings for a non default VRF instance, you must first enter the ROUTER-CONFIG-VRF sub mode using the following commands: <ol style="list-style-type: none"><li>1. Enter the ROUTER BGP mode using the <code>router bgp as-number</code> command.</li><li>2. From the ROUTER BGP mode, enter the ROUTER BGP VRF mode using the <code>vrf vrf-name</code> command.</li></ol> |
| <b>Example</b>            | <pre>OS10(conf-router-bgp-1)# enforce-first-as</pre>                                                                                                                                                                                                                                                                                                                                                                                                                                                                                                                                                                                                                                                                                                                                                                                                                      |
| <b>Supported Releases</b> | 10.3.0E or later                                                                                                                                                                                                                                                                                                                                                                                                                                                                                                                                                                                                                                                                                                                                                                                                                                                          |

## fall-over

Enables or disables BGP session fast fall-over for BGP neighbors.

|                          |                                                                                                                                                                                                           |
|--------------------------|-----------------------------------------------------------------------------------------------------------------------------------------------------------------------------------------------------------|
| <b>Syntax</b>            | <code>fall-over</code>                                                                                                                                                                                    |
| <b>Parameters</b>        | None                                                                                                                                                                                                      |
| <b>Default</b>           | Disabled                                                                                                                                                                                                  |
| <b>Command Mode</b>      | ROUTER-NEIGHBOR                                                                                                                                                                                           |
| <b>Usage Information</b> | Configure the BGP fast fall-over on a per-neighbor or peer-group basis. When you enable this command on a template, it simultaneously enables on all peers that inherit the peer group template. When you |

enable fall-over, BGP tracks IP reachability to the peer remote address and the peer local address. Whenever either address becomes unreachable — no active route exists in the routing table for peer IPv6 destinations or local address — BGP brings down the session with the peer. The `no` version of this command disables fall-over.

#### Example

```
OS10 (conf-router-neighbor) # fall-over
```

#### Supported Releases

10.3.0E or later

## fast-external-fallover

Resets BGP sessions immediately when a link to a directly connected external peer fails.

**Syntax** `fast-external-fallover`

**Parameters** None

**Default** Not configured

**Command Mode** ROUTER-BGP

**Usage Information** Fast external fall-over terminates the EBGP session immediately after the IP unreachability or link failure is detected. This only applies after you manually reset all existing BGP sessions. For the configuration to take effect, use the `clear ip bgp` command. The `no` version of this command disables fast external fallover.

**NOTE:** To configure these settings for a non default VRF instance, you must first enter the ROUTER-CONFIG-VRF sub mode using the following commands:

1. Enter the ROUTER BGP mode using the `router bgp as-number` command.
2. From the ROUTER BGP mode, enter the ROUTER BGP VRF mode using the `vrf vrf-name` command.

#### Example

```
OS10 (conf-router-bgp-10) # fast-external-fallover
```

#### Supported Releases

10.3.0E or later

## graceful-restart

Enables graceful or hitless restart and configures the required parameters for the restart process.

**Syntax** `graceful-restart role receiver-only`

**Parameters**

- `role` — Sets the restart role of the local router
- `receiver-only` — Local router supports graceful restart as a receiver only

**Defaults** Disabled

**Command Mode** ROUTER BGP

**Usage Information** When you enable graceful restart on a node, its BGP neighbor acts as a helper by not dropping the sessions and maintaining the route information so that the traffic is not disturbed. The `no` version of this command disables graceful-restart helper mode.

**NOTE:** To configure these settings for a non-default VRF instance, you must first enter ROUTER-CONFIG-VRF sub mode using the following commands:

1. Enter the ROUTER BGP mode using the `router bgp as-number` command.
2. From the ROUTER BGP mode, enter the ROUTER BGP VRF mode using the `vrf vrf-name` command.

**Example**

```
OS10(config-router-bgp-10)# graceful-restart role receiver-only
```

**Supported Releases**

10.3.0E or later

## inherit template

Configures a peer group template name that the neighbors use to inherit peer-group configuration.

**Syntax** `inherit template template-name [inherit-type {ibgp | ebgp}]`

**Parameters**

- *template-name* — Enter a template name. A maximum of 16 characters.
- *inherit-type* {ibgp | ebgp} —To associate a template to an unnumbered peer, specify the inherit-type. The options are ibgp and ebgp.

**Default**

Not configured

**Command Mode**

ROUTER-NEIGHBOR

**Usage Information**

When network neighbors inherit a template, all that are enabled on the template are also supported on the neighbors. The no version of this command disables the peer group template configuration.

**Example**

```
OS10(config)# router bgp 100
OS10(config-router-bgp-100)# template Group
OS10(config-router-template)# weight 100
OS10(config-router-template)# exit
OS10(config)# interface ethernet 1/1/1
OS10(config-if-eth1/1/1)# no switchport
OS10(config-if-eth1/1/1)# exit
OS10(config)# router bgp 100
OS10(config-router-bgp-100)# neighbor interface ethernet 1/1/1
OS10(config-router-neighbor)# inherit template Group inherit-type ebgp
OS10(config-router-neighbor)# no shutdown
```

**Supported Releases**

10.2.0E or later

## listen

Enables peer listening and sets the prefix range for dynamic peers.

**Syntax** `listen ip-address [limit count]`

**Parameters**

- *ip-address*—Enter the BGP neighbor IP address.
- *limit count*—(Optional) Enter a maximum dynamic peer count, from 1 to 4294967295.

**Default**

Not configured

**Command Mode**

ROUTER-TEMPLATE

**Usage Information**

Enables a passive peering session for listening. The no version of this command disables a passive peering session.

**Example**

```
OS10(config-router-template)# listen 1.1.0.0/16 limit 4
```

**Supported Releases**

10.2.0E or later

## local-as

Configures a local AS number for a peer.

|                             |                                                                                                                                                                                                                                                                                                                                                                                                                                                                                                                                                              |
|-----------------------------|--------------------------------------------------------------------------------------------------------------------------------------------------------------------------------------------------------------------------------------------------------------------------------------------------------------------------------------------------------------------------------------------------------------------------------------------------------------------------------------------------------------------------------------------------------------|
| <b>Syntax</b>               | <code>local-as as-number [no-prepend] [replace-as]</code>                                                                                                                                                                                                                                                                                                                                                                                                                                                                                                    |
| <b>Parameters</b>           | <ul style="list-style-type: none"><li>• <code>as-number</code>—Enter the local AS number, from 1 to 4294967295.</li><li>• <code>no-prepend</code>—(Optional) Enter so that local AS values are not prepended to the AS_PATH attribute.</li><li>• <code>replace-as</code>—(Optional) Enter so that globally-configured AS values are not prepended to the AS_PATH attribute.</li></ul>                                                                                                                                                                        |
| <b>Default</b>              | Disabled                                                                                                                                                                                                                                                                                                                                                                                                                                                                                                                                                     |
| <b>Command Mode</b>         | ROUTER-NEIGHBOR or ROUTER-TEMPLATE                                                                                                                                                                                                                                                                                                                                                                                                                                                                                                                           |
| <b>Usage Information</b>    | <p>Facilitates the BGP network migration operation and allows you to maintain existing AS numbers. The <code>no</code> version of this command resets the value to the default.</p> <p>After configuring the <code>replace-as</code> option, clear the BGP session.</p> <p>The <code>no local-as</code> command deletes the local-as configuration. The <code>no local-as no-prepend</code> command removes both local and globally-configured AS numbers from the AS_PATH attribute and leaves the <code>local-as local-as</code> configuration intact.</p> |
| <b>Example (Neighbor)</b>   | <pre>OS10(conf-router-bgp-10)# neighbor lunar OS10(conf-router-neighbor)# local-as 20</pre>                                                                                                                                                                                                                                                                                                                                                                                                                                                                  |
| <b>Example (Template)</b>   | <pre>OS10(conf-router-bgp-10)# template solar OS10(conf-router-template)# local-as 20</pre>                                                                                                                                                                                                                                                                                                                                                                                                                                                                  |
| <b>Example (Replace AS)</b> | <pre>OS10(conf-router-bgp-10)# neighbor SJC OS10(conf-router-template)# local-as 20 no-prepend replace-as</pre>                                                                                                                                                                                                                                                                                                                                                                                                                                              |
| <b>Supported Releases</b>   | 10.3.0E or later                                                                                                                                                                                                                                                                                                                                                                                                                                                                                                                                             |

## log-neighbor-changes

Enables logging for changes in neighbor status.

|                           |                                                                                                                                                                                                                                                                                                                                                                                                                                                                                                                                                                                                                                                  |
|---------------------------|--------------------------------------------------------------------------------------------------------------------------------------------------------------------------------------------------------------------------------------------------------------------------------------------------------------------------------------------------------------------------------------------------------------------------------------------------------------------------------------------------------------------------------------------------------------------------------------------------------------------------------------------------|
| <b>Syntax</b>             | <code>log-neighbor-changes</code>                                                                                                                                                                                                                                                                                                                                                                                                                                                                                                                                                                                                                |
| <b>Parameters</b>         | None                                                                                                                                                                                                                                                                                                                                                                                                                                                                                                                                                                                                                                             |
| <b>Default</b>            | Enabled                                                                                                                                                                                                                                                                                                                                                                                                                                                                                                                                                                                                                                          |
| <b>Command Mode</b>       | ROUTER-BGP                                                                                                                                                                                                                                                                                                                                                                                                                                                                                                                                                                                                                                       |
| <b>Usage Information</b>  | <p>OS10 saves logs which includes the neighbor operational status and reset reasons. To view the logs, use the <code>show bgp config</code> command. The <code>no</code> version of this command disables the feature.</p> <p><b>i NOTE:</b> To configure these settings for a non default VRF instance, you must first enter the ROUTER-CONFIG-VRF sub mode using the following commands:</p> <ol style="list-style-type: none"><li>1. Enter the ROUTER BGP mode using the <code>router bgp as-number</code> command.</li><li>2. From the ROUTER BGP mode, enter the ROUTER BGP VRF mode using the <code>vrf vrf-name</code> command.</li></ol> |
| <b>Example</b>            | <pre>OS10(conf-router-bgp-10)# log-neighbor-changes</pre>                                                                                                                                                                                                                                                                                                                                                                                                                                                                                                                                                                                        |
| <b>Supported Releases</b> | 10.3.0E or later                                                                                                                                                                                                                                                                                                                                                                                                                                                                                                                                                                                                                                 |

## maximum-paths

Configures the maximum number of equal-cost paths for load sharing.

|                           |                                                                                                                                                                                                                                                                                                                                                                                                                                                                                                                                                                                                                                                                           |
|---------------------------|---------------------------------------------------------------------------------------------------------------------------------------------------------------------------------------------------------------------------------------------------------------------------------------------------------------------------------------------------------------------------------------------------------------------------------------------------------------------------------------------------------------------------------------------------------------------------------------------------------------------------------------------------------------------------|
| <b>Syntax</b>             | <code>maximum-paths [ebgp number   ibgp number] maxpaths</code>                                                                                                                                                                                                                                                                                                                                                                                                                                                                                                                                                                                                           |
| <b>Parameters</b>         | <ul style="list-style-type: none"><li>• <code>ebgp</code>—Enable multipath support for external BGP routes.</li><li>• <code>ibgp</code>—Enable multipath support for internal BGP routes.</li><li>• <code>number</code>—Enter the number of parallel paths, from 1 to 64.</li></ul>                                                                                                                                                                                                                                                                                                                                                                                       |
| <b>Default</b>            | 64 paths                                                                                                                                                                                                                                                                                                                                                                                                                                                                                                                                                                                                                                                                  |
| <b>Command Mode</b>       | ROUTER-BGP                                                                                                                                                                                                                                                                                                                                                                                                                                                                                                                                                                                                                                                                |
| <b>Usage Information</b>  | <p>Dell EMC recommends not using multipath and add path simultaneously in a route reflector. To recompute the best path, use the <code>clear ip bgp *</code> command. The <code>no</code> version of this command resets the value to the default</p> <p><b>NOTE:</b> To configure these settings for a non default VRF instance, you must first enter the ROUTER-CONFIG-VRF sub mode using the following commands:</p> <ol style="list-style-type: none"><li>1. Enter the ROUTER BGP mode using the <code>router bgp as-number</code> command.</li><li>2. From the ROUTER BGP mode, enter the ROUTER BGP VRF mode using the <code>vrf vrf-name</code> command.</li></ol> |
| <b>Example (EBGP)</b>     | <pre>OS10(conf-router-bgp-2)# maximum-paths ebgp 2 maxpaths</pre>                                                                                                                                                                                                                                                                                                                                                                                                                                                                                                                                                                                                         |
| <b>Example (IBGP)</b>     | <pre>OS10(conf-router-bgp-2)# maximum-paths ibgp 4 maxpaths</pre>                                                                                                                                                                                                                                                                                                                                                                                                                                                                                                                                                                                                         |
| <b>Supported Releases</b> | 10.3.0E or later                                                                                                                                                                                                                                                                                                                                                                                                                                                                                                                                                                                                                                                          |

## maximum-prefix

Configures the maximum number of prefixes allowed from a peer.

|                           |                                                                                                                                                                                                                                                                                                                                                                                                                                                                    |
|---------------------------|--------------------------------------------------------------------------------------------------------------------------------------------------------------------------------------------------------------------------------------------------------------------------------------------------------------------------------------------------------------------------------------------------------------------------------------------------------------------|
| <b>Syntax</b>             | <code>maximum-prefix {number [threshold] [warning]}</code>                                                                                                                                                                                                                                                                                                                                                                                                         |
| <b>Parameters</b>         | <ul style="list-style-type: none"><li>• <code>number</code>—Enter a maximum prefix number, from 1 to 4294967295.</li><li>• <code>threshold</code>—(Optional) Enter a threshold percentage, from 1 to 100.</li><li>• <code>warning-only</code> — (Optional) Enter to set the router to send a warning log message when the maximum limit is exceeded. If you do not set this parameter, the router stops peering when the maximum prefixes limit exceeds.</li></ul> |
| <b>Default</b>            | 75% threshold                                                                                                                                                                                                                                                                                                                                                                                                                                                      |
| <b>Command Mode</b>       | ROUTER-BGP-NEIGHBOR-AF                                                                                                                                                                                                                                                                                                                                                                                                                                             |
| <b>Usage Information</b>  | <p>If you configure this command and the neighbor receives more prefixes than the configuration allows, the neighbor goes down. To view the prefix information, use the <code>show ip bgp summary</code> command. The neighbor remains down until you use the <code>clear ip bgp</code> command for the neighbor or the peer group to which the neighbor belongs. The <code>no</code> version of this command resets the value to the default.</p>                 |
| <b>Example</b>            | <pre>OS10(conf-router-bgp-neighbor-af)# maximum-prefix 20 100 warning-only</pre>                                                                                                                                                                                                                                                                                                                                                                                   |
| <b>Supported Releases</b> | 10.3.0E or later                                                                                                                                                                                                                                                                                                                                                                                                                                                   |

## neighbor

Creates a remote IP or unnumbered peer and enters Neighbor Configuration mode.

**Syntax** `neighbor {ip-address | interface interface-type}`

- Parameters**
- `ip-address`—Enter the IPv4 or IPv6 address of the neighbor.
  - `interface interface-type`—Enter the interface that connects to an unnumbered neighbor.
  - `unnumbered-auto`—Configure one or more BGP auto unnumbered neighbors.

**Default** Not configured

**Command Mode** CONFIG-ROUTER-BGP

**Usage Information** Create a remote peer with the BGP neighbor.

If you configure an unnumbered interface using the `interface` option, ensure that the interface is in Layer 3 mode. Also, enable Router Advertisement on required interfaces using the `ipv6 nd send-ra` command. If you do not enable Router Advertisement, the BGP neighborship does not form. Dell EMC networking recommends configuring the minimum and maximum advertisement intervals as 3 s and 4 s, respectively.

**i** **NOTE:** You cannot configure the default VLAN as the connecting interface for an unnumbered neighbor.

**i** **NOTE:** To configure these settings for a nondefault VRF instance, you must first enter the ROUTER-CONFIG-VRF sub mode using the following commands:

1. Enter the ROUTER BGP mode using the `router bgp as-number` command.
2. From the ROUTER BGP mode, enter the ROUTER BGP VRF mode using the `vrf vrf-name` command.

The `no` version of this command disables the BGP neighbor configuration.

**Example** The following is an example for configuring an unnumbered BGP neighbor:

```
OS10(config)# interface vlan 100
OS10(conf-if-vl-100)# ipv6 nd max-ra-interval 4
OS10(conf-if-vl-100)# ipv6 nd min-ra-interval 3
OS10(conf-if-vl-100)# ipv6 nd send-ra
OS10(conf-if-vl-100)# exit
OS10(config)# interface ethernet 1/1/1
OS10(conf-if-eth1/1/1)# no shutdown
OS10(conf-if-eth1/1/1)# switchport mode trunk
OS10(conf-if-eth1/1/1)# switchport trunk allowed vlan 100
OS10(config)# router bgp 100
OS10(config-router-bgp-100)# neighbor interface vlan 100
OS10(config-router-neighbor)# no shutdown
```

**Supported Releases** 10.3.0E or later

## network

Configures a network as local to this AS and adds it to the BGP routing table.

**Syntax** `network ip-address/prefix [route-map map-name]`

- Parameters**
- `ip-address/prefix`—Enter the IPv4 or IPv6 address and the prefix number to the network.
  - `route-map map-name`—(Optional) Enter the name of an established route-map.

**Defaults** None

**Command Modes** ROUTER-AF

**Usage Information** The no version of this command removes the network.

**Example**

```
OS10 (conf-router-bgpv4-af) #
OS10 (config-router-bgp-64601) # address-family ipv4 unicast
OS10 (configure-router-bgpv4-af) # network 192.168.1.0/24
OS10 (configure-router-bgpv4-af) # do commit
```

**Supported Releases** 10.3.0E or later

## next-hop-self

Disables the next-hop calculation for a neighbor.

**Syntax** next-hop-self

**Parameters** None

**Default** Enabled

**Command Mode** ROUTER-NEIGHBOR-AF

**Usage Information** Influences next-hop processing of EBGP routes to IBGP peers. The no version of this command disables the next-hop calculation.

**Example**

```
OS10 (conf-router-neighbor-af) # next-hop-self
```

**Supported Releases** 10.3.0E or later

## non-deterministic-med

Compares paths in the order they arrive.

**Syntax** non-deterministic-med

**Parameters** None

**Default** Disabled

**Command Mode** ROUTER-BGP

**Usage Information** Paths compare in the order they arrive. OS10 uses this method to choose different best paths from a set of paths, depending on the order they are received from the neighbors. MED may or may not be compared between adjacent paths. When you change the path selection from deterministic to nondeterministic, the path selection for the existing paths remains deterministic until you use the `clear ip bgp` command to clear the existing paths. The no version of this command configures BGP bestpath selection as non-deterministic.

**NOTE:** To configure these settings for a nondefault VRF instance, you must first enter the ROUTER-CONFIG-VRF sub mode using the following commands:

1. Enter the ROUTER BGP mode using the `router bgp as-number` command.
2. From the ROUTER BGP mode, enter the ROUTER BGP VRF mode using the `vrf vrf-name` command.

**Example**

```
OS10 (conf-router-bgp-10) # non-deterministic-med
```

**Supported Releases** 10.2.0E or later

## outbound-optimization

Enables outbound optimization for IBGP peer-group members.

**Syntax** `outbound-optimization`

**Parameters** None

**Default** Not configured

**Command Mode** ROUTER-BGP

**Usage Information** Enable or disable outbound optimization dynamically to reset all neighbor sessions. When you enable outbound optimization, all peers receive the same update packets. The next-hop address chosen as one of the addresses of neighbor's reachable interfaces is also the same for the peers. The `no` version of this command disables outbound optimization.

**NOTE:** To configure these settings for a nondefault VRF instance, you must first enter the `ROUTER-CONFIG-VRF` sub mode using the following commands:

1. Enter the ROUTER BGP mode using the `router bgp as-number` command.
2. From the ROUTER BGP mode, enter the ROUTER BGP VRF mode using the `vrf vrf-name` command.

### Example

```
OS10(conf-router-bgp-10)# outbound-optimization
```

**Supported Releases** 10.3.0E or later

## password

Configures a password for message digest 5 (MD5) authentication on the TCP connection between two neighbors.

**Syntax** `password {9 encrypted password-string| password-string}`

- Parameters**
- `9 encrypted password-string`—Enter 9 then the encrypted password.
  - `password-string`—Enter a password for authentication. A maximum of 128 characters.

**Default** Disabled

**Command Mode** ROUTER-NEIGHBOR  
ROUTER-TEMPLATE

**Usage Information** You can enter the password either as plain text or in encrypted format. The password that is provided in ROUTER-NEIGHBOR mode takes preference over the password in ROUTER-TEMPLATE mode. The `no` version of this command disables authentication.

### Example

```
OS10(conf-router-neighbor)# password abcde11
```

```
OS10(conf-router-neighbor)# password 9
f785498c228f365898c0efdc2f476b4b27c47d972c3cd8cd9b91f518c14ee42d
```

**Supported Releases** 10.3.0E or later

## redistribute

Redistributes connected, static, and OSPF routes in BGP.

**Syntax** `redistribute {connected [route-map map name] | imported-bgp-routes {vrf vrf-name} [route-map map-name] | ospf process-id [route-map map name] | static [route-map map name]}`



|                                |                                                                                                                                                                                                                                                                                                                                                                                                                                                                                                                                                               |
|--------------------------------|---------------------------------------------------------------------------------------------------------------------------------------------------------------------------------------------------------------------------------------------------------------------------------------------------------------------------------------------------------------------------------------------------------------------------------------------------------------------------------------------------------------------------------------------------------------|
| <b>Parameters</b>              | <ul style="list-style-type: none"> <li>• <code>connected</code> — Enter to redistribute routes from physically connected interfaces.</li> <li>• <code>imported-bgp-routes {vrf vrf-name} [route-map map-name]</code> — Enter to redistribute leaked BGPv4 routes.</li> <li>• <code>route-map map name</code> — (Optional) Enter the name of a configured route-map.</li> <li>• <code>ospf process-id</code> — Enter a number for the OSPF process (1 to 65535).</li> <li>• <code>static</code> — Enter to redistribute manually configured routes.</li> </ul> |
| <b>Default</b>                 | Disabled                                                                                                                                                                                                                                                                                                                                                                                                                                                                                                                                                      |
| <b>Command Mode</b>            | ROUTER-BGPv4-AF or ROUTER-BGPv6-AF                                                                                                                                                                                                                                                                                                                                                                                                                                                                                                                            |
| <b>Usage Information</b>       | Static routes are treated as incomplete routes. When you use the <code>redistribute ospf process-id</code> command without other parameters, the system redistributes all OSPF internal routes, external type 1 routes, and external type 2 routes. The <code>no</code> version of this command resets the value to the default.                                                                                                                                                                                                                              |
| <b>Example (Connected)</b>     | <pre>OS10(config-router-bgp-102)# address-family ipv4 unicast OS10(config-router-bgpv4-af)# redistribute connected route-map mapbgp1</pre>                                                                                                                                                                                                                                                                                                                                                                                                                    |
| <b>Example (Static — IPv4)</b> | <pre>OS10(config-router-bgp-102)# address-family ipv4 unicast OS10(config-router-bgpv4-af)# redistribute static route-map mapbgp2</pre>                                                                                                                                                                                                                                                                                                                                                                                                                       |
| <b>Example (Static — IPv6)</b> | <pre>OS10(config-router-bgp-102)# address-family ipv6 unicast OS10(config-router-bgpv6-af)# redistribute static</pre>                                                                                                                                                                                                                                                                                                                                                                                                                                         |
| <b>Example (OSPF — IPv4)</b>   | <pre>OS10(config-router-bgp-102)# address-family ipv4 unicast OS10(config-router-bgpv4-af)# redistribute ospf 1</pre>                                                                                                                                                                                                                                                                                                                                                                                                                                         |
| <b>Example (OSPF — IPv6)</b>   | <pre>OS10(config-router-bgp-102)# address-family ipv6 unicast OS10(config-router-bgpv6-af)# redistribute ospf 1</pre>                                                                                                                                                                                                                                                                                                                                                                                                                                         |
| <b>Supported Releases</b>      | 10.2.0E or later                                                                                                                                                                                                                                                                                                                                                                                                                                                                                                                                              |

## remote-as

Adds a remote AS to the specified BGP neighbor or peer group.

|                           |                                                                                                                                  |
|---------------------------|----------------------------------------------------------------------------------------------------------------------------------|
| <b>Syntax</b>             | <code>remote-as as-number</code>                                                                                                 |
| <b>Parameters</b>         | <code>as-number</code> — Specify AS number ranging from 1 to 65535 for 2 byte or 1 to 4294967295 for 4 byte.                     |
| <b>Defaults</b>           | None                                                                                                                             |
| <b>Command Modes</b>      | CONFIG-ROUTER-NEIGHBOR<br>CONFIG-ROUTER-TEMPLATE                                                                                 |
| <b>Usage Information</b>  | The <code>no</code> version of this command deletes the remote AS.                                                               |
| <b>Example</b>            | <pre>OS10(config)# router bgp 300 OS10(config-router-bgp-300)# template ebpppg OS10(config-router-template)# remote-as 100</pre> |
| <b>Supported Releases</b> | 10.4.1.0 or later                                                                                                                |

## remove-private-as

Removes private AS numbers from receiving outgoing updates.

|                     |                                                  |
|---------------------|--------------------------------------------------|
| <b>Syntax</b>       | <code>remove-private-as</code>                   |
| <b>Parameters</b>   | None                                             |
| <b>Defaults</b>     | Disabled                                         |
| <b>Command Mode</b> | CONFIG-ROUTER-NEIGHBOR<br>CONFIG-ROUTER-TEMPLATE |

**Usage Information** None

### Example

```
OS10(config)# router bgp 300
OS10(config-router-bgp-300)# template ebgppg
OS10(config-router-template)# remove-private-as
```

**Supported Releases** 10.4.1.0 or later

## route-map

Applies an established route-map to either incoming or outbound routes of a BGP neighbor or peer group.

|                   |                                                                                                                                                                                                                                                               |
|-------------------|---------------------------------------------------------------------------------------------------------------------------------------------------------------------------------------------------------------------------------------------------------------|
| <b>Syntax</b>     | <code>route-map <i>route-map-name</i> {in   out}</code>                                                                                                                                                                                                       |
| <b>Parameters</b> | <ul style="list-style-type: none"><li>• <i>route-map-name</i> — Enter the name of the configured route-map.</li><li>• <i>in</i> — attaches the route-map as the inbound policy</li><li>• <i>out</i> — attaches the route-map as the outbound policy</li></ul> |

**Defaults** None

**Command Modes** ROUTER-BGP-TEMPLATE-AF

**Usage Information** The `no` version of this command deletes the `route-map`.

### Example

```
OS10(conf-router-neighbor)# address-family ipv4 unicast
OS10(conf-router-bgp-neighbor-af)# route-map bgproutemap in
```

```
OS10(conf-router-template)# address-family ipv4 unicast
OS10(conf-router-bgp-template-af)# route-map bgproutemap in
```

**Supported Releases** 10.4.1.0 or later

## route-reflector-client

Configures a neighbor as a member of a route-reflector cluster.

|                     |                                     |
|---------------------|-------------------------------------|
| <b>Syntax</b>       | <code>route-reflector-client</code> |
| <b>Parameters</b>   | None                                |
| <b>Default</b>      | Not configured                      |
| <b>Command Mode</b> | ROUTER-TEMPLATE                     |

**Usage Information** The device configures as a route reflector, and the BGP neighbors configure as clients in the route-reflector cluster. The `no` version of this command deletes all clients of a route reflector—the router no longer functions as a route reflector.

**Example**

```
OS10 (conf-router-template) # route-reflector-client
```

**Supported Releases** 10.3.0E or later

## router bgp

Enables BGP and assigns an AS number to the local BGP speaker.

**Syntax** `router bgp as-number`

**Parameters** `as-number`—Enter the AS number range.

- 1 to 65535 in 2 byte
- 1 to 4294967295 in 4 byte

**Default** None

**Command Mode** CONFIGURATION

**Usage Information** The AS number can be a 16-bit integer. The `no` version of this command resets the value to the default.

**Example**

```
OS10 (config) # router bgp 3
OS10 (conf-router-bgp-3) #
```

**Supported Releases** 10.3.0E or later

## router-id

Assigns a user-given ID to a BGP router.

**Syntax** `router-id ip-address`

**Parameters** `ip-address` — Enter an IP address in dotted decimal format.

**Default** First configured IP address or random number

**Command Mode** ROUTER-BGP

**Usage Information** Change the router ID of a BGP router to reset peer-sessions. The `no` version of this command resets the value to the default.

By default, OS10 sets a loopback IP address as the router ID. If there is no loopback address, the software chooses the highest IP address that is configured to a physical interface.

**NOTE:** To configure these settings for a nondefault VRF instance, you must first enter the ROUTER-CONFIG-VRF sub mode using the following commands:

1. Enter the ROUTER BGP mode using the `router bgp as-number` command.
2. From the ROUTER BGP mode, enter the ROUTER BGP VRF mode using the `vrf vrf-name` command.

**Example**

```
OS10 (conf-router-bgp-10) # router-id 10.10.10.40
```

**Supported Releases** 10.3.0E or later

## send-community

Sends a community attribute to a BGP neighbor or peer group.

|                           |                                                                                                                                                                                                                                                                                                                                 |
|---------------------------|---------------------------------------------------------------------------------------------------------------------------------------------------------------------------------------------------------------------------------------------------------------------------------------------------------------------------------|
| <b>Syntax</b>             | <code>send-community {extended   standard}</code>                                                                                                                                                                                                                                                                               |
| <b>Parameters</b>         | <ul style="list-style-type: none"><li>• <code>extended</code> — Enter an extended community attribute.</li><li>• <code>standard</code> — Enter a started community attribute.</li></ul>                                                                                                                                         |
| <b>Default</b>            | Not configured                                                                                                                                                                                                                                                                                                                  |
| <b>Command Mode</b>       | ROUTER-NEIGHBOR                                                                                                                                                                                                                                                                                                                 |
| <b>Usage Information</b>  | A community attribute indicates that all routes with the same attributes belong to the same community grouping. All neighbors belonging to the template inherit the feature when configured for a template. The <code>no</code> version of this command disables sending a community attribute to a BGP neighbor or peer group. |
| <b>Example</b>            | <pre>OS10 (conf-router-neighbor)# send-community extended</pre>                                                                                                                                                                                                                                                                 |
| <b>Supported Releases</b> | 10.3.0E or later                                                                                                                                                                                                                                                                                                                |

## sender-side-loop-detection

Enables the sender-side loop detection process for a BGP neighbor.

|                           |                                                                                                                                                                                                                                                                                                  |
|---------------------------|--------------------------------------------------------------------------------------------------------------------------------------------------------------------------------------------------------------------------------------------------------------------------------------------------|
| <b>Syntax</b>             | <code>sender-side-loop-detection</code>                                                                                                                                                                                                                                                          |
| <b>Parameters</b>         | None                                                                                                                                                                                                                                                                                             |
| <b>Default</b>            | Enabled                                                                                                                                                                                                                                                                                          |
| <b>Command Mode</b>       | ROUTER-BGP-NEIGHBOR-AF                                                                                                                                                                                                                                                                           |
| <b>Usage Information</b>  | This command helps detect routing loops, based on the AS path before it starts advertising routes. To configure a neighbor to accept routes use the <code>neighbor allowas-in</code> command. The <code>no</code> version of this command disables sender-side loop detection for that neighbor. |
| <b>Example (IPv4)</b>     | <pre>OS10 (conf-router-bgp-102)# neighbor 3.3.3.1 OS10 (conf-router-neighbor)# address-family ipv4 unicast OS10 (conf-router-bgp-neighbor-af)# sender-side-loop-detection</pre>                                                                                                                  |
| <b>Example (IPv6)</b>     | <pre>OS10 (conf-router-bgp-102)# neighbor 32::1 OS10 (conf-router-neighbor)# address-family ipv6 unicast OS10 (conf-router-bgp-neighbor-af)# no sender-side-loop-detection</pre>                                                                                                                 |
| <b>Supported Releases</b> | 10.3.0E or later                                                                                                                                                                                                                                                                                 |

## show ip bgp

Displays information that BGP neighbors exchange.

|                     |                                                                                                                                                                                                                                                                                               |
|---------------------|-----------------------------------------------------------------------------------------------------------------------------------------------------------------------------------------------------------------------------------------------------------------------------------------------|
| <b>Syntax</b>       | <code>show ip bgp [vrf vrf-name] ip-address/mask</code>                                                                                                                                                                                                                                       |
| <b>Parameters</b>   | <ul style="list-style-type: none"><li>• <code>vrf vrf-name</code> — (OPTIONAL) Enter <code>vrf</code> and then the name of the VRF to view route information corresponding to that VRF.</li><li>• <code>ip-address/mask</code> — Enter the IP address and mask in A.B.C.D/x format.</li></ul> |
| <b>Default</b>      | Not configured                                                                                                                                                                                                                                                                                |
| <b>Command Mode</b> | EXEC                                                                                                                                                                                                                                                                                          |

**Usage Information**

None

**Example**

```
OS10# show ip bgp 1.1.1.0/24
BGP routing table entry for 1.1.1.0/24
Paths: (1 available, table Default-IP-Routing-Table.)

Received from :
3.1.1.1(3.3.3.33) Best

AS_PATH : 100
Next-Hop : 3.1.1.1, Cost : 0

Origin INCOMPLETE, Metric 0, LocalPref 100, Weight 0, confed-external
Route-reflector origin : 0.0.0.0
```

The following displays the next hop as an unnumbered neighbor with ethernet1/1/1 as the connected interface.

```
OS10# show ip bgp 31.1.1.0/24
BGP routing table entry for 31.1.1.0/24
Paths: (1 available, table Default-IP-Routing-Table.)

Received from :
fe80::3617:ebff:fef1:dc5e via ethernet1/1/1 (1.1.1.1) Best

AS_PATH :
Next-Hop : ethernet 1/1/1 , Cost : 0

Origin INCOMPLETE, Metric 0, LocalPref 100, Weight 32768,
Route-reflector origin : 0.0.0.0
```

The following displays the next hop as an unnumbered neighbor with ethernet1/1/1 as the connected interface.

```
OS10# show ip bgp
BGP local RIB : Routes to be Added , Replaced , Withdrawn
BGP local router ID is 14.233.209.106
Status codes: s suppressed, S stale, d dampened, h history, * valid, >
best
Path source: I - internal, a - aggregate, c - confed-external,
r - redistributed/network, S - stale
Origin codes: i - IGP, e - EGP, ? - incomplete

```

| Weight | Network     | Path | Next Hop       | Metric | LocPrf |
|--------|-------------|------|----------------|--------|--------|
| *>r    | 31.1.1.0/24 |      | 0.0.0.0        | 0      | 100    |
| 32768  |             | ?    |                |        |        |
| *>     | 41.1.1.0/24 |      | ethernet 1/1/1 | 0      | 100    |
| 32768  |             | ?    |                |        |        |

When you filter routes by IP addresses, if the system does not find a match, it displays the following error message:

```
OS10# show ip bgp 40.40.40.0/24
%Error: Prefix does not exist.
```

**Supported Releases**

10.3.0E or later

## show ip bgp dampened-paths

Displays BGP routes that are dampened or nonactive.

**Syntax** show ip bgp [vrf vrf-name] dampened-paths

**Parameters** None

**Default** Not configured

**Command Mode** EXEC

- Usage Information**
- `vrf vrf-name` — (OPTIONAL) Enter `vrf` and then the name of the VRF to view routes that are affected by a specific community list corresponding to that VRF.
  - `Network` — Displays the network ID where the route is dampened.
  - `From` — Displays the IP address of the neighbor advertising the dampened route.
  - `Reuse` — Displays the HH:MM:SS until the dampened route is available.
  - `Path` — Lists all AS the dampened route that is passed through to reach the destination network.

### Example

```
OS10# show ip bgp dampened-paths

BGP local router ID is 80.1.1.1
Status codes: s suppressed, S stale, d dampened, h history, * valid, >
best
Origin codes: i - IGP, e - EGP, ? - incomplete
 Network From Reuse Path
d* 3.1.2.0/24 80.1.1.2 00:00:12 800 9 8 i
d* 3.1.3.0/24 80.1.1.2 00:00:12 800 9 8 i
d* 3.1.4.0/24 80.1.1.2 00:00:12 800 9 8 i
d* 3.1.5.0/24 80.1.1.2 00:00:12 800 9 8 i
d* 3.1.6.0/24 80.1.1.2 00:00:12 800 9 8 i
Total number of prefixes: 5
```

**Supported Releases** 10.3.0E or later

## show ip bgp flap-statistics

Displays BGP flap statistics on BGP routes.

**Syntax** `show ip bgp [vrf vrf-name] flap-statistics`

**Parameters** None

**Default** Not configured

**Command Mode** EXEC

- Usage Information**
- `vrf vrf-name` — (OPTIONAL) Enter `vrf` and then the name of the VRF to view flap statistics on BGP routes corresponding to that VRF.
  - `Network` — Displays the network ID where the route is flapping.
  - `From` — Displays the IP address of the neighbor advertising the flapping route.
  - `Duration` — Displays the HH:MM:SS after the route first flapped.
  - `Flaps` — Displays the number of times the route flapped.
  - `Reuse` — Displays the HH:MM:SS until the flapped route is available.
  - `Path` — Lists all AS the flapping route passed through to reach the destination network.

### Example

```
OS10# show ip bgp flap-statistics
BGP local router ID is 80.1.1.1
Status codes: s suppressed, S stale, d dampened, h history, * valid, >
best
Origin codes: i - IGP, e - EGP, ? - incomplete
 Network From Flaps Duration Reuse Path
*> 3.1.2.0/24 80.1.1.2 1 00:00:11 00:00:00 800 9 8 i
*> 3.1.3.0/24 80.1.1.2 1 00:00:11 00:00:00 800 9 8 i
*> 3.1.4.0/24 80.1.1.2 1 00:00:11 00:00:00 800 9 8 i
*> 3.1.5.0/24 80.1.1.2 1 00:00:11 00:00:00 800 9 8 i
*> 3.1.6.0/24 80.1.1.2 1 00:00:11 00:00:00 800 9 8 i
Total number of prefixes: 5
```

**Supported Releases** 10.3.0E or later

## show ip bgp ipv4 unicast

Displays route information for BGP IPv4 routes.

**Syntax** `show ip bgp [vrf vrf-name] ipv4 unicast [summary | neighbors [ip-address | interface interface-type] [advertised-routes | dampened-paths | flap-statistics | denied-routes | routes]]`

- Parameters**
- `vrf vrf-name` — (OPTIONAL) Enter `vrf` then the name of the VRF to view IPv4 unicast summary information corresponding to that VRF.
  - `summary` — Displays IPv4 unicast summary information.
  - `neighbors` — Displays information about neighbors.
  - `ip-address` — Displays information about a specific neighbor.
  - `interface interface-type` — Displays BGP information that is learned through an unnumbered neighbor.
  - `advertised-routes` — Displays the routes that are advertised to a neighbor.
  - `dampened-paths` — Displays the suppressed routes that are received from a neighbor.
  - `flap-statistics` — Displays the flap statistics of the route that are received from a neighbor.
  - `received-routes` — Displays the routes that are received from a neighbor.
  - `denied-routes` — Displays the routes that are denied by a neighbor.
  - `routes` — Displays routes learned from a neighbor.

**Default** Not configured

**Command Mode** EXEC

**Usage Information** This command displays locally advertised BGPv4 routes configured using the `network` command. These routes show as `r` for redistributed/network-learned routes.

### Example

```
OS10# show ip bgp ipv4 unicast summary
BGP router identifier 80.1.1.1 local AS number 102
Neighbor AS MsgRcvd MsgSent Up/Down State/Pfx
80.1.1.2 800 8 4 00:01:10 5
```

```
OS10# show ip bgp ipv4 unicast neighbors interface ethernet 1/1/1
advertised-routes
BGP local router ID is 40.1.1.2
Status codes: s suppressed, S stale, d dampened, h history, * valid, >
best
Origin codes: i - IGP, e - EGP, ? - incomplete
 Network Next Hop Metric
LocPrf Weight Path
*> 41.1.1.0/24 fe80::3617:ebff:fe1:dc5e 0
0 0 10
```

```
OS10# show ip bgp ipv4 unicast neighbors interface ethernet 1/1/1 routes
BGP local router ID is 40.1.1.2
Status codes: s
suppressed, S stale, d dampened, h history, * valid, > best
Origin codes: i - IGP, e - EGP, ? - incomplete
 Network Next Hop Metric
LocPrf Weight Path
*> 31.1.1.0/24 fe80::3617:ebff:fed:dc5e 0
100 0 10
```

```
OS10# show ip bgp ipv4 unicast neighbors interface ethernet 1/1/1
received-routes
BGP local router ID is 40.1.1.2
Status codes: D denied
Origin codes: i - IGP, e - EGP, ? - incomplete
 Network Next Hop Metric
LocPrf Weight Path
```

```
*> 41.1.1.0/24 fe80::3617:ebff:fef1:dc5e 0
0 0 10
```

```
OS10# show ip bgp ipv4 unicast neighbors interface ethernet 1/1/1 denied-
routes
BGP local router ID is 40.1.1.2
Status codes: D denied
Origin codes: i - IGP, e - EGP, ? - incomplete
 Network Next Hop Metric
LocPrf
D 51.1.1.0/24 fe80::3617:ebff:fef1:dc5e 0
0 0 10
```

Summary information for unnumbered neighbors:

```
OS10# show ip bgp ipv4 unicast summary
BGP router identifier 89.101.17.125 local AS number 100
Neighbor AS
MsgRcvd MsgSent Up/Down State/Pfx
ethernet1/1/1 200
19 19 00:15:34 0
```

```
OS10# show ip bgp ipv4 unicast
BGP local RIB : Routes to be Added , Replaced , Withdrawn
BGP local router ID is 14.233.209.106
Status codes: s suppressed, S stale, d dampened, h history, * valid, >
best
Path source: I - internal, a - aggregate, c - confed-external,
r - redistributed/network, S - stale
Origin codes: i - IGP, e - EGP, ? - incomplete
 Network Next Hop Metric LocPrf
Weight
*>r 31.1.1.0/24 0.0.0.0 0 100
32768 ?
*> 41.1.1.0/24 ethernet 1/1/1 0 100
32768 ?
```

**Supported Releases** 10.3.0E or later

## show ip bgp ipv6 unicast

Displays route information for BGP IPv6 routes.

**Syntax** `show ip bgp [vrf vrf-name] ipv6 unicast [summary | neighbors [ip-address | interface interface-type] [advertised-routes | dampened-paths | flap-statistics | denied-routes | routes]]`

- Parameters**
- `vrf vrf-name` — (OPTIONAL) Enter `vrf` then the name of the VRF to view IPv6 unicast information corresponding to that VRF.
  - `neighbors` — Displays IPv6 neighbor information.
  - `ip-address` — Displays information about a specific neighbor.
  - `interface interface-type` — Displays BGP information that is learned through an unnumbered neighbor.
  - `summary` — Displays IPv6 unicast summary information.
  - `advertised-routes` — Displays the routes that are advertised to a neighbor.
  - `dampened-paths` — Displays the suppressed routes that are received from a neighbor.
  - `flap-statistics` — Displays the flap statistics of the route that are received from a neighbor.
  - `received-routes` — Displays the routes that are received from a neighbor.
  - `denied-routes` — Displays the routes that are denied by a neighbor.
  - `routes` — Displays routes learned from a neighbor.



**Default** Not configured

**Command Mode** EXEC

**Usage Information** None

**Example**

```
OS10# show ip bgp ipv6 unicast summary
BGP router identifier 80.1.1.1 local AS number 102
Neighbor AS MsgRcvd MsgSent Up/Down State/Pfx
80.1.1.2 800 8 4 00:01:10 5
```

```
OS10# show ip bgp ipv6 unicast neighbors interface ethernet 1/1/1
advertised-routes
BGP local router ID is 40.1.1.2
Status codes: s suppressed, S stale, d dampened, h history, * valid, >
best
Origin codes: i - IGP, e - EGP, ? - incomplete
Network Next Hop Metric
LocPrf Weight Path
*> 1000::/64 fe80::3617:ebff:fef1:dc5e 0
0 0 10
```

```
OS10# show ip bgp ipv6 unicast neighbors interface ethernet 1/1/1 routes
BGP local router ID is 40.1.1.2
Status codes: s suppressed, S stale, d dampened, h history, * valid, >
best
Origin codes: i - IGP, e - EGP, ? - incomplete
Network Next Hop Metric
LocPrf Weight Path
*> 1000::/64 fe80::3617:ebff:fe8d:dc5e 0
100 0 10
```

```
OS10# show ip bgp ipv6 unicast neighbors interface ethernet 1/1/1
received-routes
BGP local router ID is 40.1.1.2
Status codes: D denied
Origin codes: i - IGP, e - EGP, ? - incomplete
Network Next Hop Metric
LocPrf Weight Path
*> 1001::/64 fe80::3617:ebff:fef1:dc5e 0
0 0 10
```

```
OS10# show ip bgp ipv6 unicast neighbors interface ethernet 1/1/1 denied-
routes
BGP local router ID is 40.1.1.2
Status codes: D denied
Origin codes: i - IGP, e - EGP, ? - incomplete
Network Next Hop Metric
LocPrf Weight Path
D 1002::/64 fe80::3617:ebff:fef1:dc5e 0
0 0 10
```

Summary information for unnumbered neighbors:

```
OS10# show ip bgp ipv6 unicast summary
BGP router identifier 89.101.17.125 local AS number 100
Neighbor AS
MsgRcvd MsgSent Up/Down State/Pfx
ethernet1/1/1 200
19 19 00:15:34 0
```

```
OS10# show ip bgp ipv6 unicast
BGP local RIB : Routes to be Added , Replaced , Withdrawn
BGP local router ID is 14.233.209.106
Status codes: s suppressed, S stale, d dampened, h history, * valid, >
best
```

```

Path source: I - internal, a - aggregate, c - confed-external,
r - redistributed/network, S - stale
Origin codes: i - IGP, e - EGP, ? - incomplete
 Network Next Hop Metric LocPrf
Weight Path
*> 41::/64 ethernet 1/1/1 0 100
32768 ?

```

**Supported Releases** 10.3.0E or later

## show ip bgp neighbors

Displays information that BGP neighbors exchange.

**Syntax** `show ip bgp [vrf vrf-name] neighbors [ip-address | interface interface-type] [advertised-routes | dampened-routes | flap-statistics | denied-routes | routes]`

- Parameters**
- *vrf vrf-name* — Enter *vrf* and then the name of the VRF to view information that is exchanged between BGP neighbors corresponding to that VRF
  - *ip-address* — Enter the IPv4 or IPv6 address of a specific neighbor
  - interface *interface-type* — Displays BGP information that is learned through an unnumbered neighbor.
  - *denied-routes* — Displays the list of routes that are denied by policy
  - *advertised-routes* — Displays the routes that are advertised to a neighbor
  - *dampened-routes* — Displays the suppressed routes that are received from a neighbor
  - *flap-statistics* — Displays the flap statistics of routes that are received from a neighbor
  - *received-routes* — Displays the routes that are received from a neighbor.
  - *routes* — Displays routes learned from a neighbor

**Default** Not configured

**Command Mode** EXEC

- Usage Information**
- *BGP neighbor* — Displays the BGP neighbor address and its AS number. The last phrase in the line indicates whether the link between the BGP router and its neighbor is an external or internal one. If they are located in the same AS, the link is internal; otherwise the link is external.
  - *BGP version* — Displays the BGP version, always version 4, and the remote router ID.
  - *BGP state* — Displays the BGP state of the neighbor and the amount of time in hours:minutes:seconds it has been in that state.
  - *Last read* — Displays the information in the last read:
    - *Last read* is the time in hours:minutes:seconds that the router read a message from its neighbor.
    - *Hold time* is the number of seconds configured between messages from its neighbor.
    - *Keepalive interval* is the number of seconds between keepalive messages to help ensure that the TCP session is still alive.
  - *Received messages* — Displays the number of BGP messages received, the number of notifications or error messages, and the number of messages waiting in a queue for processing.
  - *Sent messages* — Displays the number of BGP messages sent, the number of notifications or error messages, and the number of messages waiting in a queue for processing.
  - *Description* — Displays the descriptive name that is configured for the BGP neighbor. This field is displayed only when the description is configured.
  - *Local host* — Displays the peering address of the local router and the TCP port number.
  - *Foreign host* — Displays the peering address of the neighbor and the TCP port number.

Although the status codes for routes that are received from a BGP neighbor may not display in the `show ip bgp neighbors ip-address received-routes` output, they display correctly in the `show ip bgp` output.

This command displays the route-maps for incoming and outgoing traffic.

## Example

```
OS10# show ip bgp neighbors
BGP neighbor is 2.2.2.2, remote AS 200, local AS 100 external link
Member of peer-group ebgppg for session parameters

BGP version 4, remote router ID 2.2.2.2
BGP state ESTABLISHED, in this state for 00:00:39
Last read 00:14:47 seconds
Hold time is 180, keepalive interval is 60 seconds
Configured hold time is 180, keepalive interval is 60 seconds
Fall-over disabled

Received 4 messages
1 opens, 0 notifications, 0 updates
1 keepalives, 2 route refresh requests
Sent 6 messages
2 opens, 0 notifications, 2 updates
1 keepalives, 1 route refresh requests
Minimum time between advertisement runs is 30 seconds
Minimum time before advertisements start is 0 seconds

Capabilities received from neighbor for IPv4 Unicast:
MULTIPROTO_EXT(1)
MULTIPROTO_EXT(1)
ROUTE_REFRESH(2)
CISCO_ROUTE_REFRESH(128)
4_OCTET_AS(65)
Capabilities advertised to neighbor for IPv4 Unicast:
MULTIPROTO_EXT(1)
MULTIPROTO_EXT(1)
ROUTE_REFRESH(2)
CISCO_ROUTE_REFRESH(128)
4_OCTET_AS(65)
Prefixes accepted 0, Prefixes advertised 2
Connections established 1; dropped 1
Closed by neighbor sent 00:00:54 ago
For address family: IPv4 Unicast
Default originate configured
Allow local AS number 4 times in AS-PATH attribute
Route map for incoming advertisements is filter_pg_ipv4_routes_in
Route map for outgoing advertisements is filter_ipv4_routes_out
Prefixes ignored due to:
Martian address 0, Our own AS in AS-PATH 0
Invalid Nexthop 0, Invalid AS-PATH length 0
Wellknown community 0, Locally originated 0

Local host: 2.2.2.1, Local port: 179
Foreign host: 2.2.2.2, Foreign port: 36656
```

```
OS10#show ip bgp neighbors interface ethernet 1/1/1
BGP neighbor is fe80::250:56ff:fe80:7f39 via ethernet1/1/1, remote AS
100, local AS 200 external link

BGP version 4, remote router ID 2.2.2.1
BGP state ESTABLISHED, in this state for 00:50:19
Last read 00:31:31 seconds
Hold time is 180, keepalive interval is 60 seconds
Configured hold time is 180, keepalive interval is 60 seconds
Fall-over disabled

Received 77 messages
1 opens, 0 notifications, 0 updates
58 keepalives, 18 route refresh requests
Sent 71 messages
1 opens, 3 notifications, 0 updates
58 keepalives, 9 route refresh requests
Minimum time between advertisement runs is 30 seconds
Minimum time before advertisements start is 0 seconds

Capabilities received from neighbor for IPv4 Unicast:
MULTIPROTO_EXT(1)
```

```

ROUTE_REFRESH(2)
CISCO_ROUTE_REFRESH(128)
4_OCTET_AS(65)
MP_L2VPN_EVPN(1) EXTENDED_NEXTHOP_ENCODING(5)
Capabilities received from neighbor for IPv6 Unicast:
MULTIPROTO_EXT(1)
ROUTE_REFRESH(2)
CISCO_ROUTE_REFRESH(128)
4_OCTET_AS(65)
MP_L2VPN_EVPN(1) EXTENDED_NEXTHOP_ENCODING(5)
Capabilities advertised to neighbor for IPv4 Unicast:
MULTIPROTO_EXT(1)
ROUTE_REFRESH(2)
CISCO_ROUTE_REFRESH(128)
4_OCTET_AS(65)
MP_L2VPN_EVPN(1) EXTENDED_NEXTHOP_ENCODING(5)

Capabilities advertised to neighbor for IPv6 Unicast:
MULTIPROTO_EXT(1)
ROUTE_REFRESH(2)
CISCO_ROUTE_REFRESH(128)
4_OCTET_AS(65)
MP_L2VPN_EVPN(1) EXTENDED_NEXTHOP_ENCODING(5)
Prefixes accepted 0, Prefixes advertised 0
Connections established 1; dropped 0
Last reset never
For address family: IPv4 Unicast
Next hop set to self
Allow local AS number 0 times in AS-PATH attribute
Route map for incoming advertisements is filter_ipv4_intf_in
Route map for outgoing advertisements is filter_ipv4_intf_out
Prefixes ignored due to:
Martian address 0, Our own AS in AS-PATH 0
Invalid Nexthop 0, Invalid AS-PATH length 0
Wellknown community 0, Locally originated 0

For address family: IPv6 Unicast
Next hop set to self
Allow local AS number 0 times in AS-PATH attribute
Route map for incoming advertisements is filter_ipv6_intf_in
Route map for outgoing advertisements is filter_ipv6_intf_out
Prefixes ignored due to:
Martian address 0, Our own AS in AS-PATH 0
Invalid Nexthop 0, Invalid AS-PATH length 0
Wellknown community 0, Locally originated 0

Local host: fe80::250:56ff:fe80:8d56, Local port: 39054
Foreign host: fe80::250:56ff:fe80:7f39, Foreign port: 179

```

### Example advertised-routes

```

OS10# show ip bgp ipv6 unicast neighbors 192:168:1::2 advertised-routes
BGP local router ID is 100.1.1.1
Status codes: s suppressed, S stale, d dampened, h history, * valid, >
best
Origin codes: i - IGP, e - EGP, ? - incomplete
Network Next Hop Metric LocPrf Weight
Path
*>55::/64 192:168:1::1 0 0 0
100i
*>55:0:0:1::/64 192:168:1::1 0 0 0
100i
*>55:0:0:2::/64 192:168:1::1 0 0 0
100i
*>55:0:0:3::/64 192:168:1::1 0 0 0
100i
*>55:0:0:4::/64 192:168:1::1 0 0 0
100i
*>55:0:0:5::/64 192:168:1::1 0 0 0
100i
*>55:0:0:6::/64 192:168:1::1 0 0 0
100i

```

```

*>55:0:0:7::/64 192:168:1::1 0 0 0
100i
*>55:0:0:8::/64 192:168:1::1 0 0 0
100i
*>55:0:0:9::/64 192:168:1::1 0 0 0
100i
*>172:16:1::/64 192:168:1::1 0 0 0
100?
Total number of prefixes: 11
OS10#

```

### Example received-routes

```

OS10# show ip bgp ipv6 unicast neighbors 172:16:1::2 received-routes
BGP local router ID is 100.1.1.1
Status codes: D denied
Origin codes: i - IGP, e - EGP, ? - incomplete

```

|   | Network       | Next Hop    | Metric | LocPrf | Path |
|---|---------------|-------------|--------|--------|------|
| D | 55::/64       | 172:16:1::2 | 0      | 0      | i    |
|   | 55:0:0:1::/64 | 172:16:1::2 | 0      | 0      | i    |
|   | 55:0:0:2::/64 | 172:16:1::2 | 0      | 0      | i    |
| D | 55:0:0:3::/64 | 172:16:1::2 | 0      | 0      | i    |
| D | 55:0:0:4::/64 | 172:16:1::2 | 0      | 0      | i    |
| D | 55:0:0:5::/64 | 172:16:1::2 | 0      | 0      | i    |
| D | 55:0:0:6::/64 | 172:16:1::2 | 0      | 0      | i    |
|   | 55:0:0:7::/64 | 172:16:1::2 | 0      | 0      | i    |
| D | 55:0:0:8::/64 | 172:16:1::2 | 0      | 0      | i    |
| D | 55:0:0:9::/64 | 172:16:1::2 | 0      | 0      | i    |

```

Total number of prefixes: 10
OS10#

```

### Example denied-routes

```

OS10# show ip bgp ipv6 unicast neighbors 172:16:1::2 denied-routes
BGP local router ID is 100.1.1.1
Status codes: D denied
Origin codes: i - IGP, e - EGP, ? - incomplete

```

|   | Network       | Next Hop    | Metric | LocPrf | Path             |
|---|---------------|-------------|--------|--------|------------------|
| D | 55::/64       | 172:16:1::2 | 0      | 0      | 100 200 300 400i |
| D | 55:0:0:1::/64 | 172:16:1::2 | 0      | 0      | 100 200 300 400i |
| D | 55:0:0:2::/64 | 172:16:1::2 | 0      | 0      | 100 200 300 400i |

```

Total number of prefixes: 3
OS10#

```

### Example routes

```

OS10# show ip bgp ipv6 unicast neighbors 172:16:1::2 routes
BGP local router ID is 100.1.1.1
Status codes: s suppressed, S stale, d dampened, h history, * valid, > best
Origin codes: i - IGP, e - EGP, ? - incomplete

```

|    | Network       | Next Hop    | Metric | LocPrf | Weight | Path |
|----|---------------|-------------|--------|--------|--------|------|
| *> | 55::/64       | 172:16:1::2 | 44     | 55     | 0      | i    |
| *> | 55:0:0:1::/64 | 172:16:1::2 | 44     | 55     | 0      | i    |
| *> | 55:0:0:2::/64 | 172:16:1::2 | 44     | 55     | 0      | i    |
| *> | 55:0:0:3::/64 | 172:16:1::2 | 44     | 55     | 0      | i    |
| *> | 55:0:0:4::/64 | 172:16:1::2 | 44     | 55     | 0      | i    |
| *> | 55:0:0:5::/64 | 172:16:1::2 | 44     | 55     | 0      | i    |
| *> | 55:0:0:6::/64 | 172:16:1::2 | 44     | 55     | 0      | i    |
| *> | 55:0:0:7::/64 | 172:16:1::2 | 44     | 55     | 0      | i    |
| *> | 55:0:0:8::/64 | 172:16:1::2 | 44     | 55     | 0      | i    |
| *> | 55:0:0:9::/64 | 172:16:1::2 | 44     | 55     | 0      | i    |

```

Total number of prefixes: 10
OS10#

```

### Example unnumbered neighbors

```

OS10# show ip bgp neighbors interface ethernet1/1/1

BGP neighbor is fe80::76e6:e2ff:fe6:b81 via ethernet1/1/1, remote AS 100, local AS 200 external link

BGP version 4, remote router ID 125.12.57.117
BGP state ESTABLISHED, in this state for 00:15:52

```

```

Last read 00:21:08 seconds
Hold time is 180, keepalive interval is 60 seconds
Configured hold time is 180, keepalive interval is 60 seconds
Fall-over disabled

Received 20 messages
 1 opens, 0 notifications, 0 updates
 19 keepalives, 0 route refresh requests
Sent 20 messages
 1 opens, 1 notifications, 0 updates
 18 keepalives, 0 route refresh requests
Minimum time between advertisement runs is 30 seconds
Minimum time before advertisements start is 0 seconds

Capabilities received from neighbor for IPv4 Unicast:
MULTIPROTO_EXT(1)
ROUTE_REFRESH(2)
CISCO_ROUTE_REFRESH(128)
4_OCTET_AS(65)
Extended Next Hop Encoding (5)
Capabilities advertised to neighbor for IPv4 Unicast:
MULTIPROTO_EXT(1)
ROUTE_REFRESH(2)
CISCO_ROUTE_REFRESH(128)
4_OCTET_AS(65)
Extended Next Hop Encoding (5)
Prefixes accepted 0, Prefixes advertised 0
Connections established 1; dropped 0
Last reset never
Prefixes ignored due to:
 Martian address 0, Our own AS in AS-PATH 0
 Invalid Nexthop 0, Invalid AS-PATH length 0
 Wellknown community 0, Locally originated 0

Local host: fe80::76e6:e2ff:fef5:b281, Local port: 45926
Foreign host: fe80::76e6:e2ff:fef6:b81, Foreign port: 179

```

**Example  
advertised-  
routes from  
unnumbered  
neighbors**

```

OS10# show ip bgp neighbors interface ethernet 1/1/1 advertised-routes
BGP local router ID is 40.1.1.2
Status codes: s suppressed, S stale, d dampened, h history, * valid, >
best
Origin codes: i - IGP, e - EGP, ? - incomplete

```

| Network        | Next Hop                  | Metric |
|----------------|---------------------------|--------|
| LocPrf         | Weight                    | Path   |
| *> 41.1.1.0/24 | fe80::3617:ebff:fef1:dc5e | 0      |
| 0              | 0                         | 10     |

**Example  
received-routes  
from  
unnumbered  
neighbors**

```

OS10# show ip bgp neighbors interface ethernet 1/1/1 received-routes
BGP local router ID is 40.1.1.2
Status codes: D denied
Origin codes: i - IGP, e - EGP, ? - incomplete

```

| Network        | Next Hop                  | Metric |
|----------------|---------------------------|--------|
| LocPrf         | Weight                    | Path   |
| *> 41.1.1.0/24 | fe80::3617:ebff:fef1:dc5e | 0      |
| 0              | 0                         | 10     |

**Example routes  
from  
unnumbered  
neighbors**

```

OS10# show ip bgp neighbors interface ethernet 1/1/1 routes
BGP local router ID is 40.1.1.2
Status codes: s suppressed, S stale, d dampened, h history, * valid, >
best
Origin codes: i - IGP, e - EGP, ? - incomplete

```

| Network        | Next Hop                 | Metric |
|----------------|--------------------------|--------|
| LocPrf         | Weight                   | Path   |
| *> 31.1.1.0/24 | fe80::3617:ebff:fed:dc5e | 0      |
| 100            | 0                        | 10     |

### Example denied-routes from unnumbered neighbors

```
OS10# show ip bgp neighbors interface ethernet 1/1/1 denied-routes
BGP local router ID is 40.1.1.2
Status codes: D denied
Origin codes: i - IGP, e - EGP, ? - incomplete
 Network Next Hop Metric
LocPrf Weight Path
D 51.1.1.0/24 fe80::3617:ebff:fe1:dc5e 0
0 0 10
```

### Example Global AS

```
OS10# show ip bgp neighbors 30.1.1.1
BGP neighbor is 30.1.1.1, remote AS 500, local AS 200 no-prepend
replace-as external link

BGP version 4, remote router ID 20.20.20.20
BGP state ESTABLISHED, in this state for 00:10:19
OS10#
```

### Supported Releases

10.3.0E or later

## show ip bgp peer-group

Displays information about BGP peers in a peer-group.

### Syntax

```
show ip bgp [vrf vrf-name] peer-group peer-group-name
```

### Parameters

- *vrf vrf-name* — (OPTIONAL) Enter *vrf* to view information about BGP peers in a peer group corresponding to that VRF.
- *peer-group-name* — (Optional) Enter the peer group name to view information about that peer-group only.

### Default

Not configured

### Command Mode

EXEC

### Usage Information

- *Peer-group* — Displays the peer group name. Minimum time displays the time interval between BGP advertisements.
- *Administratively shut* — Displays the status of the peer group if you do not enable the peer group. If you enable the peer group, this line does not display.
- *BGP version* — Displays the BGP version supported.
- *Description* — Displays the descriptive name that is configured for the BGP peer template. This field is displayed only when the description is configured.
- *For address family* — Displays IPv4 unicast as the address family.
- *BGP neighbor* — Displays the name of the BGP neighbor.
- *Number of peers*—Displays the number of peers that are configured for this peer group.
- *Peer-group members* — Lists the IP addresses of the peers in the peer group. If the address is outbound optimized, an \* displays next to the IP address.

### Example

```
OS10# show ip bgp peer-group bgppg
Peer-group bgppg, remote AS 103
BGP version 4
Minimum time between advertisement runs is 30 seconds
Description: peer_template_1_abcd
For address family: Unicast
BGP neighbor is bgppg, peer-group external
Update packing has 4_OCTET_AS support enabled
```

### Example (Summary)

```
OS10# show ip bgp peer-group ebgp summary
BGP router identifier 32.1.1.1 local AS number 6
```

| Neighbor | AS | MsgRcvd | MsgSent | Up/Down  | State/Pfx |
|----------|----|---------|---------|----------|-----------|
| 17.1.1.2 | 7  | 7       | 6       | 00:01:54 | 5         |

```
OS10# show ip bgp peer-group bg1
Peer-group bg1, remote AS 0
BGP version 4
Minimum time between advertisement runs is 30 seconds

For address family: Unicast
BGP neighbor is bg1, peer-group external
Update packing has 4_OCTET_AS support enabled

Number of peers in this group 2
Peer-group members:
40.1.1.2

ethernet 1/1/1
```

```
OS10# show ip bgp peer-group bg1 summary
BGP router identifier 14.233.209.106 local AS number 10
Neighbor AS MsgRcvd MsgSent Up/
Down State/Pfx
40.1.1.2 20 15 19
00:00:32 0
ethernet 1/1/1 20 15 19
00:00:32 0
```

**Supported Releases** 10.2.0E or later

## show ip bgp summary

Displays the status of all BGP connections.

**Syntax** `show ip bgp [vrf vrf-name] summary`

**Parameters** `vrf vrf-name` — (OPTIONAL) Enter `vrf` then the name of the VRF to view the status of all BGP connections corresponding to that VRF.

**Default** Not configured

**Command Mode** EXEC

### Usage Information

- **Neighbor**—Displays the BGP neighbor address.
- **AS**—Displays the AS number of the neighbor
- **MsgRcvd**—Displays the number of BGP messages that the neighbor received.
- **MsgSent**—Displays the number of BGP messages that the neighbor sent.
- **Up/Down**—Displays the amount of time that the neighbor is in the `Established` stage. If the neighbor has never moved into the `Established` stage, the word `never` displays. The output format is:

```
1 day = 00:12:23 (hours:minutes:seconds), 1 week = 1d21h (DaysHours),
1 week + 11w2d (WeeksDays)
```

- **State/Pfxrcd**—If the neighbor is in the `Established` stage, this is the number of network prefixes received. If you configured a maximum limit using the `neighbor maximum-prefix` command, `prfxd` appears in this column. If the neighbor is not in the `Established` stage, the current stage - `Idle`, `Connect`, `Active`, `OpenSent`, `OpenConfirm` displays. When the peer is transitioning between states and clearing the routes received, the phrase `Purging` may appear in this column. If the neighbor is disabled, the phrase `Admin shut` appears in this column.

The suppressed status of aggregate routes may not display in the command output.



## Example

```
OS10# show ip bgp summary
BGP router identifier 80.1.1.1 local AS number 102
Neighbor AS MsgRcvd MsgSent Up/Down State/Pfx
80.1.1.2 800 24 23 00:09:15 5
```

Example for unnumbered peer:

```
OS10# show ip bgp summary
BGP router identifier 89.101.17.125 local AS number 100
Neighbor AS
MsgRcvd MsgSent Up/Down State/Pfx
ethernet1/1/1
19 19 00:15:34 200
0
```

## Supported Releases

10.2.0E or later

## show ip route

Displays information about IPv4 BGP routing table entries.

### Syntax

```
show ip route [vrf vrf-name] bgp
```

### Parameters

- *vrf vrf-name* — Enter *vrf* and then the name of the VRF to view information that is exchanged between BGP neighbors corresponding to that VRF

### Default

Not configured

### Command Mode

EXEC

### Usage Information

This command displays information about IPv4 BGP routing table entries.

### Example

```
OS10# show ip route
Codes: C - connected
 S - static
 B - BGP, IN - internal BGP, EX - external BGP
 O - OSPF, IA - OSPF inter area, N1 - OSPF NSSA external type 1,
 N2 - OSPF NSSA external type 2, E1 - OSPF external type 1,
 E2 - OSPF external type 2, * - candidate default,
 + - summary route, > - non-active route
Gateway of last resort is not set

Destination Gateway Dist/Metric Last Change

C 10.1.1.0/24 via 10.1.1.1 ethernet1/1/17 0/0 01:18:34
B IN 100.1.1.0/24 via 10.1.1.2 200/0 00:03:46
B IN 101.1.1.0/24 via 10.1.1.2 200/0 00:03:46
B IN 102.1.1.0/24 via 10.1.1.2 200/0 00:03:46
B IN 103.1.1.0/24 via 10.1.1.2 200/0 00:03:46
B IN 104.1.1.0/24 via 10.1.1.2 200/0 00:03:46
```

```
OS10# show ip route bgp
Codes: C - connected
 S - static
 B - BGP, IN - internal BGP, EX - external BGP
 O - OSPF, IA - OSPF inter area, N1 - OSPF NSSA external type 1,
 N2 - OSPF NSSA external type 2, E1 - OSPF external type 1,
 E2 - OSPF external type 2, * - candidate default,
 + - summary route, > - non-active route
Gateway of last resort is not set

Destination Gateway Dist/Metric Last Change

B IN 1.1.1.0/24 via 169.254.0.1 vlan100 200/0 00:17:34
```

## Supported Releases

10.4.2.0 or later

## show ipv6 route

Displays information about IPv6 BGP routing table entries.

|                          |                                                                                                                                                                                                                       |
|--------------------------|-----------------------------------------------------------------------------------------------------------------------------------------------------------------------------------------------------------------------|
| <b>Syntax</b>            | <code>show ipv6 route [vrf vrf-name] bgp</code>                                                                                                                                                                       |
| <b>Parameters</b>        | <ul style="list-style-type: none"><li><code>vrf vrf-name</code> — Enter <code>vrf</code> and then the name of the VRF to view information that is exchanged between BGP neighbors corresponding to that VRF</li></ul> |
| <b>Default</b>           | Not configured                                                                                                                                                                                                        |
| <b>Command Mode</b>      | EXEC                                                                                                                                                                                                                  |
| <b>Usage Information</b> | This command displays information about IPv6 BGP routing table entries.                                                                                                                                               |
| <b>Example</b>           |                                                                                                                                                                                                                       |

```
OS10# show ipv6 route
```

```
OS10# show ipv6 route bgp
```

```
Codes: C - connected
```

```
S - static
```

```
B - BGP, IN - internal BGP, EX - external BGP
```

```
O - OSPF, IA - OSPF inter area, N1 - OSPF NSSA external type 1,
```

```
N2 - OSPF NSSA external type 2, E1 - OSPF external type 1,
```

```
E2 - OSPF external type 2, * - candidate default,
```

```
+ - summary route, > - non-active route
```

```
Gateway of last resort is not set
```

| Destination | Gateway                      |         | Dist/Metric | Last O    |
|-------------|------------------------------|---------|-------------|-----------|
| B IN 1::/64 | via fe80::250:56ff:fe80:1815 | vlan100 | 200/0       | 00:17:... |

|                           |                   |
|---------------------------|-------------------|
| <b>Supported Releases</b> | 10.4.2.0 or later |
|---------------------------|-------------------|

## soft-reconfiguration inbound

Enables soft-reconfiguration for a neighbor.

|                          |                                                                                                                                                                                                                                                                                                                                                                                                                                                                                                                                          |
|--------------------------|------------------------------------------------------------------------------------------------------------------------------------------------------------------------------------------------------------------------------------------------------------------------------------------------------------------------------------------------------------------------------------------------------------------------------------------------------------------------------------------------------------------------------------------|
| <b>Syntax</b>            | <code>soft-reconfiguration inbound</code>                                                                                                                                                                                                                                                                                                                                                                                                                                                                                                |
| <b>Parameters</b>        | None                                                                                                                                                                                                                                                                                                                                                                                                                                                                                                                                     |
| <b>Default</b>           | Not configured                                                                                                                                                                                                                                                                                                                                                                                                                                                                                                                           |
| <b>Command Modes</b>     | ROUTER-BGP-NEIGHBOR-AF                                                                                                                                                                                                                                                                                                                                                                                                                                                                                                                   |
| <b>Usage Information</b> | This command is not supported on a peer-group level. To enable soft-reconfiguration for peers in a peer-group, you must enable this command at a per-peer level. With soft-reconfiguration inbound, all updates that are received from this neighbor are stored unmodified, regardless of the inbound policy. When inbound soft-reconfiguration is performed later, the stored information generates a new set of inbound updates. The <code>no</code> version of this command disables soft-reconfiguration inbound for a BGP neighbor. |

### Example (IPv4)

```
OS10(conf-router-neighbor)# address-family ipv4 unicast
OS10(conf-router-bgp-neighbor-af)# soft-reconfiguration inbound
```

### Example (IPv6)

```
OS10(conf-router-neighbor)# address-family ipv6 unicast
OS10(conf-router-bgp-neighbor-af)# soft-reconfiguration inbound
```

|                           |                  |
|---------------------------|------------------|
| <b>Supported Releases</b> | 10.3.0E or later |
|---------------------------|------------------|

## template

Creates a peer-group template to assign it to BGP neighbors.

|                          |                                                                                                                                                                                                                                                                                                                                                                                                                                                                                                                                                                                                                                         |
|--------------------------|-----------------------------------------------------------------------------------------------------------------------------------------------------------------------------------------------------------------------------------------------------------------------------------------------------------------------------------------------------------------------------------------------------------------------------------------------------------------------------------------------------------------------------------------------------------------------------------------------------------------------------------------|
| <b>Syntax</b>            | <code>template <i>template-name</i></code>                                                                                                                                                                                                                                                                                                                                                                                                                                                                                                                                                                                              |
| <b>Parameters</b>        | <code>template-name</code> — Enter a peer-group template name. A maximum of 16 characters.                                                                                                                                                                                                                                                                                                                                                                                                                                                                                                                                              |
| <b>Default</b>           | Not configured                                                                                                                                                                                                                                                                                                                                                                                                                                                                                                                                                                                                                          |
| <b>Command Mode</b>      | CONFIG-ROUTER-BGP                                                                                                                                                                                                                                                                                                                                                                                                                                                                                                                                                                                                                       |
| <b>Usage Information</b> | Members of a peer-group template inherit the configuration properties of the template and share the same update policy. The <code>no</code> version of this command deletes a peer-template configuration.<br><b>NOTE:</b> To configure these settings for a nondefault VRF instance, you must first enter the ROUTER-CONFIG-VRF sub mode using the following commands: <ol style="list-style-type: none"><li>1. Enter the ROUTER BGP mode using the <code>router bgp <i>as-number</i></code> command.</li><li>2. From the ROUTER BGP mode, enter the ROUTER BGP VRF mode using the <code>vrf <i>vrf-name</i></code> command.</li></ol> |

### Example

```
OS10(conf-router-bgp-10)# template solar
OS10(conf-router-bgp-template) #
```

**Supported Releases** 10.3.0E or later

## timers

Adjusts BGP keepalive and holdtime timers.

|                           |                                                                                                                                                                                                                                                                                                                                               |
|---------------------------|-----------------------------------------------------------------------------------------------------------------------------------------------------------------------------------------------------------------------------------------------------------------------------------------------------------------------------------------------|
| <b>Syntax</b>             | <code>timers <i>keepalive holdtime</i></code>                                                                                                                                                                                                                                                                                                 |
| <b>Parameters</b>         | <ul style="list-style-type: none"><li>• <code>keepalive</code>—Enter the time interval, in seconds, between keepalive messages sent to the neighbor routers, from 1 to 65535.</li><li>• <code>holdtime</code>—Enter the time interval, in seconds, between the last keepalive message and declaring a router dead, from 3 to 65535.</li></ul> |
| <b>Default</b>            | <code>keepalive 60 seconds; holdtime 180 seconds</code>                                                                                                                                                                                                                                                                                       |
| <b>Command Mode</b>       | ROUTER-BGP                                                                                                                                                                                                                                                                                                                                    |
| <b>Usage Information</b>  | The configured timer value becomes effective after a BGP hard reset. The timer values negotiate from peers. The <code>no</code> version of this command resets the value to the default.                                                                                                                                                      |
| <b>Example</b>            | <pre>OS10(conf-router-bgp)# timers 30 90</pre>                                                                                                                                                                                                                                                                                                |
| <b>Supported Releases</b> | 10.3.0E or later                                                                                                                                                                                                                                                                                                                              |

## update-source

Enables using Loopback interfaces for TCP connections to stabilize BGP sessions.

|                      |                                                                                                           |
|----------------------|-----------------------------------------------------------------------------------------------------------|
| <b>Syntax</b>        | <code>update-source loopback <i>interface-id</i></code>                                                   |
| <b>Parameters</b>    | <code>loopback <i>interface-id</i></code> — Specify a Loopback interface ID, from 0 to 16383.             |
| <b>Defaults</b>      | None                                                                                                      |
| <b>Command Modes</b> | <ul style="list-style-type: none"><li>• CONFIG-ROUTER-NEIGHBOR</li><li>• CONFIG-ROUTER-TEMPLATE</li></ul> |

**Usage Information** When you configure the `update-source loopback` command for a template, all the neighbors belonging to the template inherit the feature.

**Example**

```
OS10(config)# router bgp 10
OS10(conf-router-bgp-10)# neighbor
OS10(conf-router-bgp-10)# neighbor 1.1.15.4
OS10(conf-router-neighbor)# update-source Loopback 1
```

**Supported Releases** 10.3.0E or later

## vrf

Enters the CONFIG-ROUTER-VRF command mode.

**Syntax** `vrf vrf-name`

**Parameters** None

**Default** None

**Command Mode** ROUTER-BGP

**Usage Information** This mode allows you to apply BGP configurations to nondefault VRFs.

**Example**

```
OS10(config)#router bgp 100
OS10(config-router-bgp-100)#
OS10(config-router-bgp-100)#vrf vrf_test1

OS10(config-router-bgp-100-vrf)#
```

**Supported Releases** 10.3.0E or later

## weight

Assigns a default weight for routes from the neighbor interfaces.

**Syntax** `weight number`

**Parameters** *number*—Enter a number as the weight for routes, from 1 to 4294967295.

**Default** 0

**Command Mode** ROUTER-BGP-NEIGHBOR

**Usage Information** The path with the highest weight value is preferred in the best-path selection process. The `no` version of this command resets the value to the default.

**Example**

```
OS10(conf-router-bgp-neighbor)# weight 4096
```

**Supported Releases** 10.3.0E or later

## Equal cost multi-path

ECMP is a routing technique where next-hop packet forwarding to a single destination occurs over multiple best paths. When you enable ECMP, OS10 uses a hash algorithm to determine the next-hop. The hash algorithm makes hashing decisions based on values in various packet fields and internal values.

Configure the hash algorithm in CONFIGURATION mode.

```
hash-algorithm ecmp {crc | crc16cc | crc32LSB | crc32MSB | xor | xor1 | xor2 | xor4 | xor8 | random}
```

### Change hash algorithm

```
OS10(config)# hash-algorithm ecmp crc
```

## Restrictions on ECMP Static Routes

When you configure static route leaking, all the Equal-cost multipath (ECMP) static routes from the source do not leak to the destination VRF instance. Only a single ECMP route, normally the best ECMP route, leaks to the destination VRF instance.

## Load balancing

To increase bandwidth, traffic is balanced across member links. RTAG7 is a hash algorithm that load balances traffic within a trunk group in a controlled manner. RTAG7 balances traffic to more effectively use member links as traffic gets more diverse.

RTAG7 generates a hash that consists of two parts:

- The first part generates from packet headers to identify micro-flows in traffic. By default, all listed parameters are enabled for load balancing except the ingress port.

```
OS10# show load-balance

Load-Balancing Configuration For LAG and ECMP:

IPV4 Load Balancing : Enabled
IPV6 Load Balancing : Enabled
MAC Load Balancing : Enabled
TCP-UDP Load Balancing : Enabled
Ingress Port Load Balancing : Disabled
IPV4 FIELDS : source-ip destination-ip protocol vlan-id l4-destination-port l4-
source-port
IPV6 FIELDS : source-ip destination-ip protocol vlan-id l4-destination-port l4-
source-port
MAC FIELDS : source-mac destination-mac ethertype vlan-id
TCP-UDP FIELDS: l4-destination-port l4-source-port
```

- The second part generates from the static physical configuration such as the ingress and egress port numbers.

To generate load balancing based on any parameters, change the hash field using the `load-balance` command. The example shows how to enable the ingress port to generate load balancing based on the ingress parameter.

```
OS10(config)# load-balancing ingress-port enable
OS10(config)# do show load-balance
Load-Balancing Configuration For LAG and ECMP:

IPV4 Load Balancing : Enabled
IPV6 Load Balancing : Enabled
MAC Load Balancing : Enabled
TCP-UDP Load Balancing : Enabled
Ingress Port Load Balancing : Enabled
IPV4 FIELDS : source-ip destination-ip protocol vlan-id l4-destination-port l4-source-
port
IPV6 FIELDS : source-ip destination-ip protocol vlan-id l4-destination-port l4-source-
port
MAC FIELDS : source-mac destination-mac ethertype vlan-id
TCP-UDP FIELDS: l4-destination-port l4-source-port
```

### Configuration notes

Dell EMC PowerSwitch S4200-ON Series:

The `load-balancing` command does not work with the `tcp-udp-selection` parameter.

## Resilient hashing

To increase bandwidth and for load balancing, traffic distributes across the next hops of an ECMP group or member ports of a port channel. OS10 uses a hash algorithm to determine a hash key. The egress port in a port channel or the next hop in an ECMP group is selected based on the hash key modulo the number of ports in a port channel or next hops in an ECMP group, respectively. When a member link goes down or a new member link is added, the traffic flows remap based on the new hash result.

In this section, the term, "member link" refers to either a member physical port, in the case of port channels or next hop in the case of ECMP groups.

With resilient hashing, when a member link goes down, the existing flows are not affected; they do not remap. Resilient hashing reassigns the traffic from the failed link to another member link without remapping the other existing flows. However, minimal re-mapping occurs when a new member link is added.

Resilient hashing is supported both for Port Channels and Equal Cost MultiPath Groups (ECMP). Resilient hashing is a global configuration. You can configure resilient hashing for both port channels and ECMP independently.

### NOTE:

- Resilient hashing is not supported on the S4200-ON and Z9332F-ON platforms.
- The flow-map table always has an even number of entries.

To enable resilient hashing for Port Channels or ECMP groups, use the following commands in CONFIGURATION mode:

```
OS10(config)# enhanced-hashing resilient-hashing ecmp
```

```
OS10(config)# enhanced-hashing resilient-hashing lag
```

### Configuration notes

Dell EMC PowerSwitch S4200-ON Series:

Resilient hashing is not supported on the S4200-ON Series switches.

## Supported platforms

The following table lists the platforms that support resilient hashing.

**Table 39. Supported platforms for resilient hashing feature**

| Platform                                                         | Resilient hashing on ECMP | Resilient hashing on Port Channels |
|------------------------------------------------------------------|---------------------------|------------------------------------|
| S6000-ON, S6010-ON, S4048T-ON, S4100-ON Series, S5200F-ON Series | Y                         | Y                                  |
| Z9100-ON Series, Z9200-ON Series                                 | Y                         | N                                  |
| S3000-ON, S4200-ON Series                                        | N                         | N                                  |

## Examples

### Normal traffic flow without resilient hashing

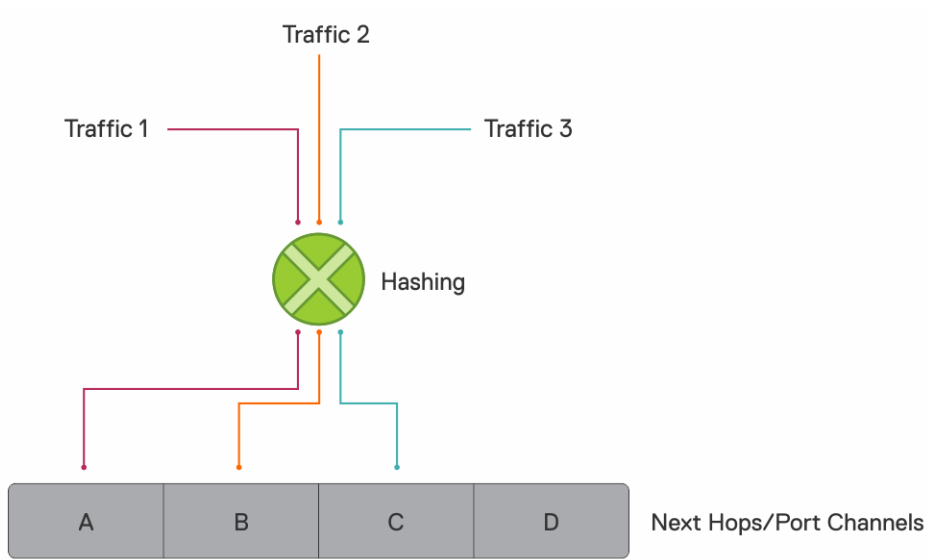

### Traffic flow with resilient hashing enabled

When you enable resilient hashing for ECMP groups, the flow-map table is created with 64 paths (the OS10 default maximum number of ECMP paths) and traffic is equally distributed. In the following example, traffic 1 maps to next hop 'A'; traffic 2 maps to next hop 'C'; and traffic 3 maps to next hop 'B.'

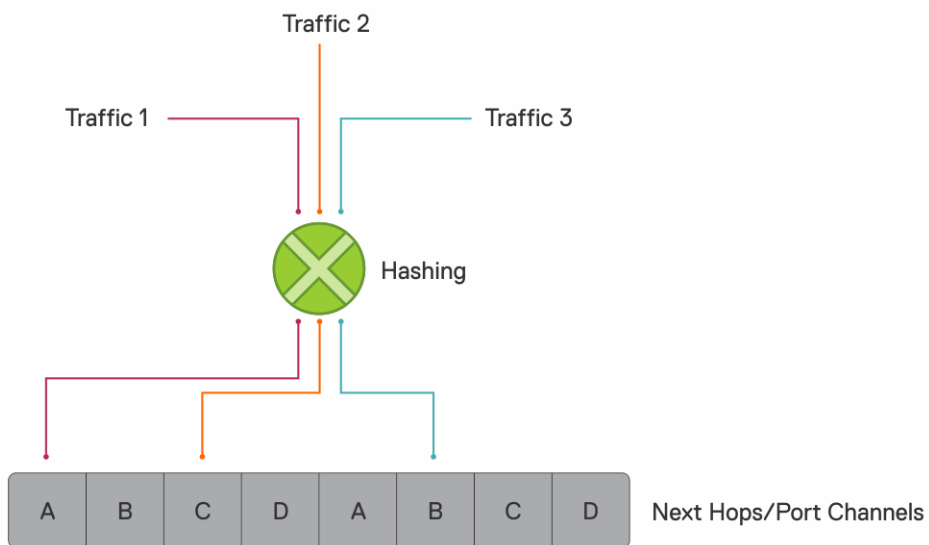

### Member link goes down

In the following example, if member link D goes down, resilient hashing distributes the traffic intended for member link D to A and B. The existing 1, 2, and 3 traffic is not disturbed.

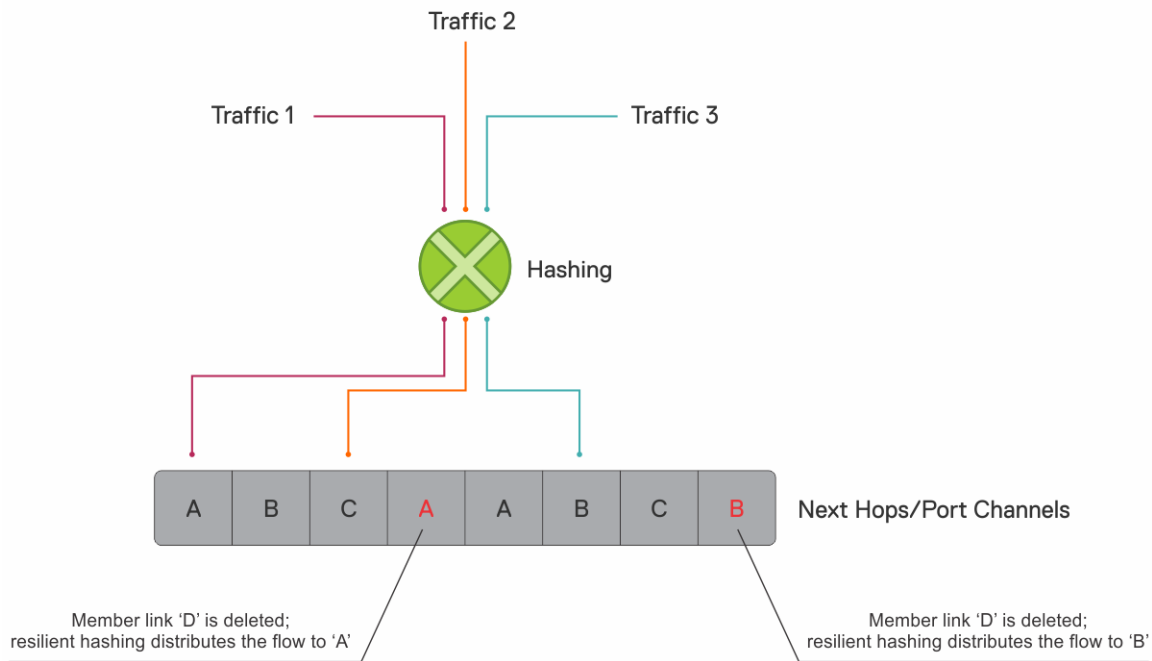

### Member link is added

However, when a new member link is added, resilient hashing completes minimal remapping for better load balancing, as shown:

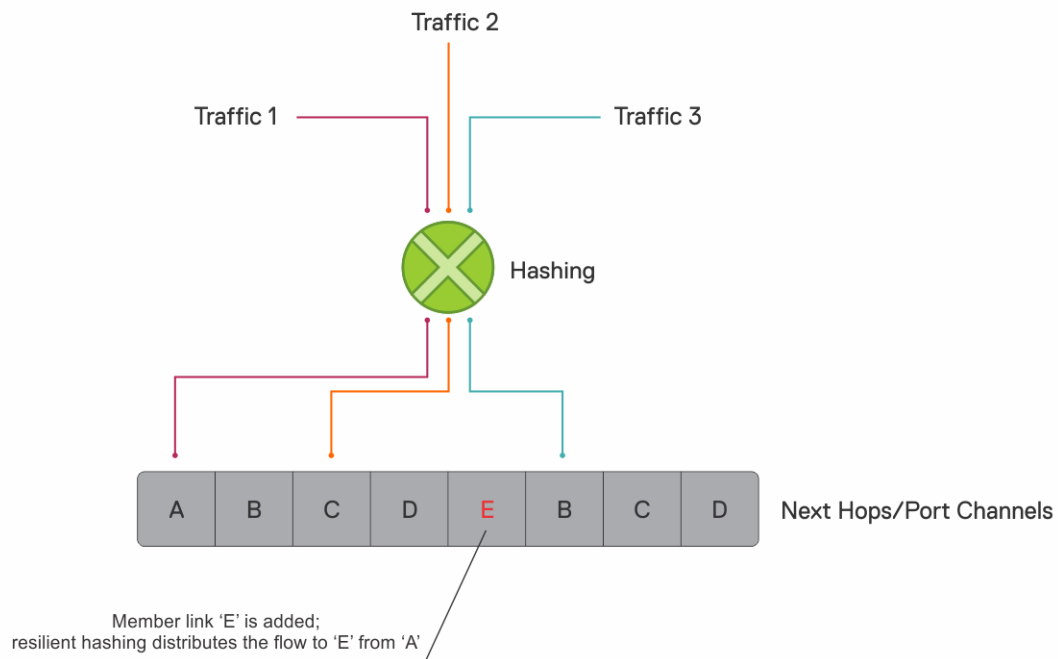

## Important notes

- Resilient hashing on port channels applies only for unicast traffic.
- For resilient hashing on ECMP groups, the ECMP path must be in multiples of 64. Before you enable resilient hashing, ensure that the maximum ECMP path is set to a multiple of 64. You can configure this value using the `ip ecmp-group maximum-paths` command.



## Maximum ECMP groups and paths

The maximum number of ECMP groups supported on the switch depends on the maximum ECMP paths configured on the switch. To view the maximum number of ECMP groups and paths, use the `show ip ecmp-group details` command.

```
OS10# show ip ecmp-group details
Maximum Number of ECMP Groups : 256
Maximum ECMP Path per Group : 64
Next boot configured Maximum ECMP Path per Group : 64
```

The default value for the maximum number of ECMP paths per group is 64. This value is configurable and you can configure a maximum of up to 128 ECMP paths per group.

The `Maximum ECMP Path per Group` is the current value configured in the hardware. The `Next boot configured Maximum ECMP Path per Group` is the value that is configured for maximum ECMP path and will take effect after the next reboot.

You can increase or decrease the maximum number of ECMP groups using the `ip ecmp-group maximum-paths number` command. The number of ECMP groups is inversely proportional to the number of ECMP paths.

To configure maximum paths per ECMP route:

```
OS10# configure terminal
OS10(config)# ip ecmp-group maximum-paths 10
OS10(config)# exit
OS10# write memory
OS10# reload
```

## ECMP commands

### enhanced-hashing

Ensures that existing traffic flows are not remapped when a member link goes down.

**Syntax** `enhanced-hashing resilient-hashing {lag | ecmp}`

- Parameters**
- `resilient-hashing`—Enter the keyword to enable enhanced-hashing.
  - `{ecmp | lag}`—Enter the keyword to enable resilient hashing for a port channel or ECMP group.

**Defaults** Disabled

**Command Mode** CONFIGURATION

**Usage Information** The `no` version of this command disables resilient hashing. For supported platforms, see [Supported platforms](#).

**Example**

```
OS10(config)# enhanced-hashing resilient-hashing ecmp
```

```
OS10(config)# enhanced-hashing resilient-hashing lag
```

**Supported Releases** 10.4.3.0 or later

### hash-algorithm

Changes the hash algorithm that distributes traffic flows across ECMP paths and the link aggregation group (LAG).

**Syntax** `hash-algorithm {ecmp | lag | seed {seed-value}} {crc | crc16cc | crc32LSB | crc32MSB | xor | xor1 | xor2 | xor4 | xor8 | random}`

**Parameters**

- `ecmp`—Enables the ECMP hash configuration.
- `lag`—Enables the LAG hash configuration for Layer 2 (L2) only.
- `seed`—Changes the hash algorithm seed value to get a better hash value.
- `seed-value`—Enter a hash algorithm seed value, from 0 to 4294967295.
- `crc`—Enables the cyclic redundancy check (CRC) polynomial for hash computation.
- `crc16cc`—16 bit CRC16 using CRC16-CCITT polynomial
- `crc32LSB`—LSB 16 bits of computed CRC32(default)
- `crc32MSB`—MSB 16 bits of computed CRC32
- `xor` — Enables upper 8 bits of CRC and lower 8 bits of XOR value for computation.
- `xor1`—Enables upper 8 bits of CRC16-BISYNC and lower 8 bits of xor1
- `xor2`—Enables upper 8 bits of CRC16-BISYNC and lower 8 bits of xor2
- `xor4`—Enables upper 8 bits of CRC16-BISYNC and lower 8 bits of xor4
- `xor8`—Enables upper 8 bits of CRC16-BISYNC and lower 8 bits of xor8
- `random` — Enables a hash algorithm random seed value for ECMP or LAG hash computation.

**Default**`crc`**Command Mode**

CONFIGURATION

**Usage Information**

The hash value calculated with this command is unique to the entire system. Different hash algorithms are based on the number of port-channel members and packet values. The default hash algorithm yields the most balanced results in various test scenarios, but if the default algorithm does not provide a satisfactory distribution of traffic, use this command to designate another algorithm.

When a port-channel member leaves or is added to the port-channel, the hash algorithm recalculates to balance traffic across the members. The `no` version of this command returns the value to the default.

**Example**

```
OS10(config)# hash-algorithm lag crc
```

**Supported Releases**

10.3.0E or later

## ip ecmp-group maximum-paths

Configures the maximum number of ECMP paths per route.

**Syntax**`ip ecmp-group maximum-paths number`**Parameters**

*number* — Enter the maximum number of ECMP paths, from 2 to 128.

**Default**

64

**Command Mode**

CONFIGURATION

**Usage Information**

To save the new ECMP settings, use the `write memory` command, then reload the system for the new settings to take effect. The `no` version of this command returns the value to the default.

**Example**

```
OS10# configure terminal
OS10(config)# ip ecmp-group maximum-paths 2
OS10(config)# exit
OS10# write memory
OS10# reload
```

**Supported Releases**

10.4.3.0 or later

## link-bundle-utilization trigger-threshold

Configures a threshold value to trigger traffic monitoring distribution on an ECMP link bundle.

**Syntax**`link-bundle-utilization trigger-threshold value`

**Parameters** *value* — Enter a link bundle trigger threshold value, from 0 to 100.

**Defaults** Not configured

**Command Mode** CONFIGURATION

**Usage Information** The no version of this command disables the configuration.

**Example**

```
OS10(config)# link-bundle-utilization trigger-threshold 80
```

**Supported Releases** 10.2.0E or later

## load-balancing

Distributes or load balances incoming traffic using the default parameters in the hash algorithm.

**Syntax** `load-balancing {ingress-port enable | [tcp-udp-selection l4-destination-port | l4-source-port] | [ip-selection destination-ip | source-ip | protocol | vlan-id | l4-destination-port | l4-source-port] | [ipv6-selection destination-ip | source-ip | protocol | vlan-id | l4-destination-port | l4-source-port] | [mac-selection destination-mac | source-mac | ethertype | vlan-id]}`

- Parameters**
- `ingress-port enable` — Enables load-balancing on ingress ports.
  - `tcp-udp-selection` — Enables the TCP UDP port for the load-balancing configuration.
  - `ip-selection` — Enables IPv4 key parameters to use in the hash computation.
  - `ipv6-selection` — Enables IPv6 key parameters to use in hash computation.
  - `destination-ip` — Enables the destination IP address in the hash calculation.
  - `source-ip` — Enables the source IP address in the hash calculation.
  - `protocol` — Enables protocol information in the hash calculation.
  - `vlan-id` — Enables VLAN ID information in the hash calculation.
  - `l4-destination-port` — Enables Layer 4 (L4) destination port information in the hash calculation.
  - `l4-source-port` — Enables L4 source port information in the hash calculation.
  - `mac-selection` — Enables MAC load-balancing configurations.
  - `destination-mac` — Enables destination MAC information in the hash calculation.
  - `source-mac` — Enables source MAC information in the hash calculation.
  - `ethertype` — Enables Ethernet type information in the hash calculation.

- Default**
- `ip-selelection-source-ip dest-ip vlan-id l4-source-port l4-dest-port ipv4 protocol`
  - `ipv6-selection-source-ipv6 dest-ipv6 vlan-id l4-source-port l4-dest-port ipv6 protocol`
  - `mac-selection-source-mac destination-mac vlan-id ethertype`
  - `tcp-udp-selection-l4-source-port l4-dest-port`

**Command Mode** CONFIGURATION

- Usage Information**
- IPv4- selection: `source-ip destination-ip protocol vlan-id l4-destination-port l4-source-port`
  - IPv6 destination address: `source-ip destination-ip protocol vlan-id l4-destination-port l4-source-port`
  - MAC parameters: `source-mac destination-mac ethertype vlan-id`
  - TCP/UDP parameters: `l4-destination-port l4-source-port`

The no version of this command resets the value to the default.

**Example (Ingress)**

```
OS10(config)# load-balancing ingress-port enable
```

**Example (IP Selection)**

```
OS10(config)# load-balancing ip-selection destination-ip source-ip
```

**Supported Releases**

10.2.0E or later

## show enhanced-hashing resilient-hashing

Displays the status of the enhanced-hashing command.

**Syntax**

```
show enhanced-hashing resilient-hashing {lag | ecmp}
```

**Parameters**

lag | ecmp—Enter the keyword to view enhanced-hashing for a port channel or ECMP group.

**Default**

Disabled

**Command Mode**

EXEC

**Usage**

None

**Information****Example**

```
OS10# show enhanced-hashing resilient-hashing lag
Resilient Hashing Configuration For LAG:

LAG Resilient hashing : Disabled
```

```
OS10# show enhanced-hashing resilient-hashing ECMP
Resilient Hashing Configuration For ECMP:

ECMP Resilient hashing : Disabled
```

**Supported Releases**

10.4.3.0 or later

## show hash-algorithm

Displays hash-algorithm information.

**Syntax**

```
show hash-algorithm
```

**Parameters**

None

**Default**

Not configured

**Command Mode**

EXEC

**Usage**

None

**Information****Example**

```
OS10# show hash-algorithm
EcmpAlgo - crc LabAlgo - crc
```

**Supported Releases**

10.3.0E or later

## show ip ecmp-group details

Displays the number of ECMP groups and paths.

**Syntax**

```
show ip ecmp-group details
```

**Parameters**

None

**Default**

Not configured

**Command Mode** EXEC

**Usage Information** None

**Example**

```
OS10# show ip ecmp-group details
Maximum Number of ECMP Groups : 256
Maximum ECMP Path per Group : 64
Next boot configured Maximum ECMP Path per Group : 64
```

**Supported Releases** 10.4.3.0 or later

## show load-balance

Displays the global traffic load-balance configuration.

**Syntax** show load-balance

**Parameters** None

**Default** Not configured

**Command Mode** EXEC

**Usage Information** None

**Example**

```
OS10# show load-balance

Load-Balancing Configuration For LAG & ECMP:

IPV4 Load Balancing Enabled
IPV4 FIELDS : source-ipv4 dest-ipv4 vlan protocol L4-source-port L4-dest-
port

IPV6 Load Balancing Enabled
IPV6 FIELDS : source-ipv6 dest-ipv6 vlan protocol L4-source-port L4-dest-
port

Mac Load Balancing Enabled
MAC FIELDS : source-mac dest-mac vlan ethertype

mac-in-mac header based hashing is disabled
TcpUdp Load Balancing Enabled
```

**Supported Releases** 10.3.0E or later

## IPv4 routing

OS10 supports IPv4 addressing including variable-length subnetting mask (VLSM), Address Resolution Protocol (ARP), static routing, and routing protocols. With VLSM, you can configure one network with different masks. You can also use supernetting, which increases the number of subnets. You can add a mask to the IP address to separate the network and host portions of the IP address to add a subnet.

You need to configure IPv4 routing for IP hosts to communicate with one another in the same network, or in different networks.

### Assign interface IP address

You can assign primary and secondary IP addresses to a physical or logical interface to enable IP communication between the system and hosts connected to a specific interface. Assign one primary address and secondary IP addresses to each interface. By default, all ports are in the default VLAN—VLAN 1.

1. Enter the interface type information to assign an IP address in CONFIGURATION mode.

```
interface interface
```

- ethernet—Physical interface
- port-channel—Port-channel ID number
- vlan—VLAN ID number
- loopback—Loopback interface ID
- mgmt—Management interface

2. Enable the interface in INTERFACE mode.

```
no shutdown
```

3. Remove the interface from the default VLAN in INTERFACE mode.

```
no switchport
```

4. Configure a primary IP address and mask on the interface in INTERFACE mode.

```
ip address ip-address mask [secondary]
```

- *ip-address mask*—Enter the IP address in dotted decimal format—A.B.C.D. and mask in slash prefix-length format (/24).
- *secondary*—Enter a secondary backup IP address for the interface.

### Assign interface IP address to interface

```
OS10(config)# interface ethernet 1/1/1
OS10(conf-if-eth1/1/4)# no shutdown
OS10(conf-if-eth1/1/4)# no switchport
OS10(conf-if-eth1/1/4)# ip address 10.10.1.4/8
```

### View interface configuration

```
OS10# show interface ethernet 1/1/1
Ethernet 1/1/1 is up, line protocol is up
Hardware is Dell EMC Eth, address is 00:0c:29:98:1b:79
 Current address is 00:0c:29:98:1b:79
Pluggable media present, QSFP+ type is QSFP+ 40GBASE CR 1.0M
 Wavelength is 64
 SFP receive power reading is 0.0
Interface index is 16866084
Internet address is not set
Mode of IPv4 Address Assignment: not set
MTU 1532 bytes
LineSpeed 40G, Auto-Negotiation on
Flowcontrol rx off tx off
ARP type: ARPA, ARP Timeout: 60
Last clearing of "show interface" counters: 3 weeks 1 day 23:12:50
Queuing strategy: fifo
Input statistics:
 0 packets, 0 octets
 0 64-byte pkts, 0 over 64-byte pkts, 0 over 127-byte pkts
 0 over 255-byte pkts, 0 over 511-byte pkts, 0 over 1023-byte pkts
 0 Multicasts, 0 Broadcasts, 0 Unicasts
 0 runts, 0 giants, 0 throttles
 0 CRC, 0 overrun, 0 discarded
Output statistics:
 0 packets, 0 octets
 0 64-byte pkts, 0 over 64-byte pkts, 0 over 127-byte pkts
 0 over 255-byte pkts, 0 over 511-byte pkts, 0 over 1023-byte pkts
 0 Multicasts, 0 Broadcasts, 0 Unicasts
 0 throttles, 0 discarded, 0 Collisions, 0 wredrops
Rate Info(interval 299 seconds):
 Input 0 Mbits/sec, 0 packets/sec, 0% of line rate
 Output 0 Mbits/sec, 0 packets/sec, 0% of line rate
Time since last interface status change: 3 weeks 1 day 20:54:37
```

## Configure static routing

You can configure a manual or static route for open shortest path first (OSPF).

- Configure a static route in CONFIGURATION mode.

```
ip route ip-prefix/mask {next-hop | interface interface [route-preference]}
```

- *ip-prefix*—IPv4 address in dotted decimal in A.B.C.D format.
- *mask*—Mask in slash prefix-length format (/X).
- *next-hop*—Next-hop IP address in dotted decimal in A.B.C.D format.
- *interface*—Interface type with the node/slot/port information
- *route-preference*—(Optional) Route-preference range, from 1 to 255.

### Configure static routes

```
OS10(config)# ip route 200.200.200.0/24 10.1.1.2
```

### View configured static routes

```
OS10# show ip route static
Codes: C - connected
 S - static
 B - BGP, IN - internal BGP, EX - external BGP
 O - OSPF, IA - OSPF inter area, N1 - OSPF NSSA external type 1,
 N2 - OSPF NSSA external type 2, E1 - OSPF external type 1,
 E2 - OSPF external type 2, > - non-active route
Gateway of last resort is not set
Destination Gateway Dist/Metric Last Change

S 200.200.200.0/24 via 10.1.1.2 ethernet1/1/1 0/0 00:00:03
```

OS10 installs a static route if the next hop is on a directly connected subnet. A next-hop that is not on the directly connected subnet which recursively resolves to a next-hop on the interface's configured subnet also automatically configures. For example, if interface `ethernet 1/1/5` has IP address on subnet `100.0.0.0/8`, and if `10.1.1.0/24` recursively resolves to `100.1.1.1`, the system installs the static route:

- When the interface goes down, OS10 withdraws the route.
- When the interface comes up, OS10 reinstalls the route.
- When the recursive resolution is *broken*, OS10 withdraws the route.
- When the recursive resolution is satisfied, OS10 reinstalls the route.

 **NOTE:** The recursive next-hop resolution does not work when the interface involved is null 0.

## Address Resolution Protocol

Address Resolution Protocol (ARP) runs over Ethernet and enables end stations to learn the MAC addresses of neighbors on an IP network. Using ARP, OS10 automatically updates the *ARP cache* table that maps the MAC addresses to their corresponding IP addresses. The *ARP cache* enables dynamically learned addresses to be removed after a time period you configure.

### Configure static ARP entries

You can manually configure static entries in the ARP mapping table. Dynamic ARP is vulnerable to spoofing. To avoid spoofing, configure static entries. Static entries take precedence over dynamic ARP entries.

 **NOTE:** In the default forwarding-table mode, the maximum number of ARP entries that are learnt over Layer3 port-channels is limited to 32000. This restriction is applicable only to the Z9100 and S5200.

1. Configure an IP address and MAC address mapping for an interface in INTERFACE mode.

```
ip arp ip-address mac address
```

- *ip-address*—IP address in dotted decimal format in A.B.C.D format.
- *mac address*—MAC address in nnnn.nnnn.nnnn format

These entries do not age, and you can only remove them manually. To remove a static ARP entry, use the `no arp ip-address` command.

### Configure static ARP entries

```
OS10(config)# interface ethernet 1/1/6
OS10(conf-if-eth1/1/6)# ip arp 10.1.1.5 08:00:20:b7:bd:32
```

### View ARP entries

```
OS10# show ip arp interface ethernet 1/1/6
Address Hardware address Interface Egress Interface

10.1.1.5 08:00:20:b7:bd:32 ethernet1/1/6 ethernet1/1/6
```

## IPv4 routing commands

### clear ip arp

Clears the dynamic ARP entries from a specific interface or optionally delete (no-refresh) ARP entries from the content addressable memory (CAM).

**Syntax** `clear ip arp [vrf vrf-name] [interface interface | ip ip-address] [no-refresh]`

- Parameters**
- `vrf vrf-name` — (Optional) Enter `vrf` then the name of the VRF to clear ARP entries corresponding to that VRF.
  - `interface interface` — (Optional) Specify an interface type:
    - `ethernet` — Physical interface.
    - `port-channel` — Port-channel identifier.
    - `vlan` — VLAN identifier.
    - `loopback` — Loopback interface identifier.
    - `virtual-network vn-id` — Virtual network ID.
  - `ip ip-address` — (Optional) Specify the IP address of the ARP entry to clear.
  - `no-refresh` — (Optional) Delete the ARP entry from CAM. You can also use this option with `interface` or `ip ip-address` to specify which dynamic ARP entries to delete.

**Default** Not configured

**Command Mode** EXEC

**Usage Information** Transit traffic may not forward during the period when deleted ARP entries resolve again and re-install in CAM.

 **NOTE:** Use this option with extreme caution.

### Example

```
OS10# clear ip arp interface ethernet 1/1/5
```

**Supported Releases** 10.2.0E or later

### clear ip route

Clears the specified routes from the IP routing table.

**Syntax** `clear ip route [vrf vrf-name] {* | A.B.C.D/mask}`

- Parameters**
- `vrf vrf-name` — (Optional) Enter the keyword `vrf` and then the name of the VRF to clear the routes corresponding to that VRF.



- \*—Clear the entire IP routing table. This option refreshes all the routes in the routing table. Traffic flow is affected for all the routes in the switch.
- *A.B.C.D/mask* —Specify the IP route to remove from the IP routing table. This option refreshes all the routes in the routing table. Traffic flow is affected only for the specified route in the switch.

**Default** Not configured

**Command Mode** EXEC

**Usage Information** This command does not remove the static routes from the routing table.

**Example**

```
OS10# clear ipv6 route 10.1.1.0/24
```

**Supported Releases** 10.3.0E or later

## ip address

Configure the IP address to an interface.

**Syntax** `ip address ip-address/mask`

**Parameters** *ip-address/mask* — Enter the IP address.

**Defaults** None

**Command Mode** INTERFACE

**Usage Information** The `no` version of this command removes the IP address set for the interface.

**Example**

```
OS10(config)# interface ethernet 1/1/1
OS10(conf-if-eth1/1/1)# ip address 10.1.1.0/24
```

**Supported Releases** 10.3.0E or later

## ip address dhcp

Enables DHCP client operations on the interface.

**Syntax** `ip address dhcp`

**Parameters** None

**Defaults** None

**Command Mode** INTERFACE

**Usage Information** The `no` version of this command disables DHCP operations on the interface.

**Example**

```
OS10(config)# interface mgmt 1/1/1
OS10(conf-if-ma-1/1/1)# ip address dhcp
```

**Supported Releases** 10.3.0E or later

## ip arp

Configures static ARP and maps the IP address of the neighbor to a MAC address.

|                           |                                                                                                                                                                                                       |
|---------------------------|-------------------------------------------------------------------------------------------------------------------------------------------------------------------------------------------------------|
| <b>Syntax</b>             | <code>ip arp mac-address</code>                                                                                                                                                                       |
| <b>Parameters</b>         | <code>mac-address</code> — Enter the MAC address of the IP neighbor in A.B.C.D format.                                                                                                                |
| <b>Default</b>            | Not configured                                                                                                                                                                                        |
| <b>Command Mode</b>       | INTERFACE                                                                                                                                                                                             |
| <b>Usage Information</b>  | Do not use Class D (multicast) or Class E (reserved) IP addresses. Zero MAC addresses (00:00:00:00:00:00) are invalid. The <code>no</code> version of this command disables the IP ARP configuration. |
| <b>Example</b>            | <pre>OS10(conf-if-eth1/1/6)# ip arp 10.1.1.5 08:00:20:b7:bd:32</pre>                                                                                                                                  |
| <b>Supported Releases</b> | 10.2.0E or later                                                                                                                                                                                      |

## ip arp gratuitous

Enables an interface to receive or send gratuitous ARP requests and updates.

|                           |                                                                                                                                                                                                                                                                              |
|---------------------------|------------------------------------------------------------------------------------------------------------------------------------------------------------------------------------------------------------------------------------------------------------------------------|
| <b>Syntax</b>             | <code>ip arp gratuitous {update   request}</code>                                                                                                                                                                                                                            |
| <b>Parameters</b>         | <ul style="list-style-type: none"><li>• <code>update</code> — Specify to enable or disable ARP cache updates for gratuitous ARP.</li><li>• <code>request</code> — Specify to enable or disable sending gratuitous ARP requests when duplicate address is detected.</li></ul> |
| <b>Default</b>            | Not configured                                                                                                                                                                                                                                                               |
| <b>Command Mode</b>       | CONFIG-INTERFACE                                                                                                                                                                                                                                                             |
| <b>Usage Information</b>  | When a reply to a gratuitous ARP request is received, it indicates an IP address conflict in the network. The <code>no</code> version of this command disables the ARP cache updates for gratuitous ARP.                                                                     |
| <b>Example</b>            | <pre>OS10(conf-if-eth1/1/6)# ip arp gratuitous update OS10(conf-if-eth1/1/6)# ip arp gratuitous request</pre>                                                                                                                                                                |
| <b>Supported Releases</b> | 10.2.0E or later                                                                                                                                                                                                                                                             |

## ip proxy-arp

Enables proxy ARP on an interface.

|                           |                                                                                                                                 |
|---------------------------|---------------------------------------------------------------------------------------------------------------------------------|
| <b>Syntax</b>             | <code>ip proxy-arp enable</code>                                                                                                |
| <b>Parameters</b>         | <code>enable</code> —Enable proxy ARP.                                                                                          |
| <b>Defaults</b>           | Disabled                                                                                                                        |
| <b>Command Mode</b>       | INTERFACE                                                                                                                       |
| <b>Usage Information</b>  | OS10 does not support proxy ARP in a VLT setup.<br>The <code>no</code> version of this command resets the value to the default. |
| <b>Example</b>            | <pre>OS10(config)# interface ethernet 1/1/1 OS10(conf-if-eth1/1/1)# ip proxy-arp</pre>                                          |
| <b>Supported Releases</b> | OS10 legacy command.                                                                                                            |

## ip route

Assigns a static route on the network device.

|                   |                                                                                                                                                                                                                                                                                                                                                                                                                                                                                                                                                                                                                                                                                                                                                                                                                                                                                                                                                                   |
|-------------------|-------------------------------------------------------------------------------------------------------------------------------------------------------------------------------------------------------------------------------------------------------------------------------------------------------------------------------------------------------------------------------------------------------------------------------------------------------------------------------------------------------------------------------------------------------------------------------------------------------------------------------------------------------------------------------------------------------------------------------------------------------------------------------------------------------------------------------------------------------------------------------------------------------------------------------------------------------------------|
| <b>Syntax</b>     | <code>ip route [vrf <b>vrf-name</b>] dest-ip-prefix mask {next-hop [ interface interface-type] [route-preference]} [bfd]</code>                                                                                                                                                                                                                                                                                                                                                                                                                                                                                                                                                                                                                                                                                                                                                                                                                                   |
| <b>Parameters</b> | <ul style="list-style-type: none"><li>• <code>vrf vrf-name</code> — (Optional) Enter <code>vrf</code> and then the name of the VRF to configure a static route corresponding to that VRF. Use this VRF option after the <code>ip route</code> keyword to configure a static route on that specific VRF.</li><li>• <code>dest-ip-prefix</code> — Enter the destination IP prefix in dotted decimal A.B.C.D format.</li><li>• <code>mask</code> — Enter the mask in slash prefix-length /x format.</li><li>• <code>next-hop</code> — Enter the next-hop IP address in dotted decimal A.B.C.D format.</li><li>• <code>interface interface-type</code> — Enter the interface type and interface information. The interface types supported are: Ethernet, port-channel, VLAN, and Null.</li><li>• <code>route-preference</code> — (Optional) Enter the range, from 1 to 255.</li><li>• <code>bfd</code> — (Optional) Enable BFD on a specific static route.</li></ul> |

**Default** Not configured

**Command Mode** CONFIGURATION

**Usage Information** The `no` version of this command deletes a static route configuration.

Use the `bfd` option to enable Bidirectional Forwarding detection (BFD) on a specific static route.

### Example

```
OS10(config)# ip route 200.200.200.0/24 10.1.1.2
```

```
OS10(config)# ip route 200.200.200.0/24 interface null 0
```

The following is a sample configuration for enabling BFD on a specific static route:

```
OS10(config)# ip route 10.10.200.0/24 10.1.1.2 bfd
```

**Supported Releases** 10.2.0E or later

## show ip arp

Displays the ARP table entries for a specific IP address or MAC address, static, dynamic, and a summary of all ARP entries.

**Syntax** `show ip arp [vrf vrf-name] [interface [ethernet | vlan | port-channel] | ip-address | mac-address | static | dynamic | summary]`

**Parameters**

- `vrf vrf-name` — Enter `vrf` then the name of the VRF to display ARP entries corresponding to that VRF.
- `interface` — (Optional) Enter the keyword and interface information:
  - `ethernet` — Enter the node/slot/port[:subport] information.
  - `vlan` — Enter the VLAN ID number, from 1 to 4093.
  - `port-channel` — Enter the port-channel ID number, from 1 to 128.
- `ip-address` — (Optional) Enter the IP address for the ARP entry in A.B.C.D format.
- `mac-address` — (Optional) Enter the MAC address in nn:nn:nn:nn:nn:nn format.
- `static` — (Optional) Enter the keyword to display static ARP entries.
- `dynamic` — (Optional) Enter the keyword to display dynamic ARP entries.
- `summary` — (Optional) Enter the keyword to display a summary of all ARP entries.

**Default** Not configured

**Command Mode** EXEC

**Usage Information** This command shows both static and dynamic ARP entries.

### Example (IP Address)

```
OS10# show ip arp 192.168.2.2
Address Hardware address Interface Egress Interface

192.168.2.2 90:b1:1c:f4:a6:e6 ethernet1/1/49:1 ethernet1/1/49:1
```

### Example (Static)

```
OS10# show ip arp summary
Total Entries Static Entries Dynamic Entries

3994 0 3994
```

```
OS10# show ip arp 192.168.2.2
Address Hardware address Interface Egress Interface

192.168.2.2 90:b1:1c:f4:a6:e6 ethernet1/1/49:1 ethernet1/1/49:1
```

```
OS10# show ip arp
Address Hardware address Interface Egress Interface

192.168.2.2 90:b1:1c:f4:a6:e6 ethernet1/1/49:1 ethernet1/1/49:1
193.168.2.3 54:bf:64:e6:d4:c5 vlan4000 port-channel1000
```

### Example (Dynamic)

```
OS10# show ip arp dynamic
Address Hardware address Interface Egress Interface

192.168.2.2 90:b1:1c:f4:a6:e6 ethernet1/1/49:1 ethernet1/1/49:1
193.168.2.3 54:bf:64:e6:d4:c5 vlan4000 port-channel1000
```

### Supported Releases

10.2.0E or later

## show ip route

Displays IP route information.

### Syntax

```
show ip route [vrf vrf-name] [all | bgp | connected | ospf process-id | static | ip
summary] load-balancing {ingress-port enable | [tcp-udp-selection l4-destination-po
port] | [ip-selection destination-ip | source-ip | protocol | vlan-id | l4-destinat
source-port] | [ipv6-selection destination-ip | source-ip | protocol | vlan-id | l4
l4-source-port] | [mac-selection destination-mac | source-mac | ethertype | vlan-id
```

### Parameters

- *vrf vrf-name* — (Optional) Enter *vrf* and then the VRF name to list the routes in the route table of a specific VRF.
- *all* — (Optional) Displays both active and non-active IP routes.
- *bgp* — (Optional) Displays BGP route information.
- *connected* — (Optional) Displays only the directly connected routes.
- *ospf process-id* — (Optional) Displays route information for the OSPF process, from 1 to 65535.
- *static* — (Optional) Displays static route information.
- *ip-prefix/mask* — (Optional) Displays routes for the destination prefix list.  
 **NOTE:** This option works only for the exact prefix and the mask length.
- *summary* — (Optional) Displays an IP route summary.

### Default

Not configured

### Command Mode

EXEC

### Usage Information

None

### Example

```
OS10# show ip route
Codes: C - connected
 S - static
```

```

B - BGP, IN - internal BGP, EX - external BGP
O - OSPF, IA - OSPF inter area, N1 - OSPF NSSA external type 1,
N2 - OSPF NSSA external type 2, E1 - OSPF external type 1,
E2 - OSPF external type 2, > - non-active route
Gateway of last resort is not set
Destination Gateway Dist/Metric Last Change

C 10.1.1.0/24 via 10.1.1.1 vlan100 0/0 01:16:56
B EX 10.1.2.0/24 via 10.1.2.1 vlan101 20/0 01:16:56
O 10.1.3.0/24 via 10.1.3.1 vlan102 110/2 01:16:56
B IN 10.1.4.0/24 via 10.1.4.1 vlan103 200/0 01:16:56

OS10(config)# do show ip route vrf VRF1
Codes: C - connected
S - static
B - BGP, IN - internal BGP, EX - external BGP
O - OSPF, IA - OSPF inter area, N1 - OSPF NSSA external type 1,
N2 - OSPF NSSA external type 2, E1 - OSPF external type 1,
E2 - OSPF external type 2, * - candidate default,
+ - summary route, > - non-active route
Gateway of last resort is not set
Destination Gateway Dist/Metric Last Change

C 120.0.0.0/24 via 120.0.0.1 ethernet1/1/1 0/0 00:00:57
S 160.0.0.0/24 via 120.0.0.2 ethernet1/1/1 1/0 00:00:04
OS10(config)# do show ip route vrf VRF2
Codes: C - connected
S - static
B - BGP, IN - internal BGP, EX - external BGP
O - OSPF, IA - OSPF inter area, N1 - OSPF NSSA external type 1,
N2 - OSPF NSSA external type 2, E1 - OSPF external type 1,
E2 - OSPF external type 2, * - candidate default,
+ - summary route, > - non-active route
Gateway of last resort is not set
Destination Gateway Dist/Metric Last Change

C 140.0.0.0/24 via 140.0.0.1 ethernet1/1/2 0/0 00:01:54
B IN 160.0.0.0/24 via 120.0.0.2 200/0 00:00:02

```

**Supported Releases** 10.2.0E or later

## IPv6 routing

OS10 supports IPv6 routing and addressing, including the Neighbor Discovery Protocol (NDP), stateless IPv6 address autoconfiguration, and stateful IPv6 address configuration. Configure IPv6 routing for IP hosts to communicate with one another in the same network, or in different networks.

 **NOTE:** OS10 does not support Routing Information Protocol Next Generation (RIPNG).

### Configuration notes

IPv6 processing is supported according to the OS10 interface type. The following interface-specific IPv6 settings apply:

- Physical port and port-channel (LAG) interfaces are in L2 mode by default. IPv6 capability and forwarding are disabled in L2 mode. To enable IPv6 forwarding, set the interface in L3 mode using the `no switchport` and `commit` commands.
- VLAN and Loopback interfaces come up in L3 mode with IPv6 capability and forwarding enabled by default.
- On the management interface, IPv6 is enabled by default. IPv6 forwarding is disabled so that the interface operates in Host mode without routing traffic.
- IPv6 stateless auto-configuration is disabled by default, except on the management interface. To enable autoconfiguration, use the `ipv6 address autoconfig` command in Interface mode. Autoconfiguration acquires a global IPv6 address using the network prefix in Router Advertisements. When IPv6 auto-configuration is enabled, IPv6 forwarding is disabled on the interface.

To disable auto-configuration, use the `no ipv6 address autoconfig` command. IPv6 forwarding remains enabled.

## Enable or disable IPv6

By default:

- IPv6 forwarding is enabled on physical Ethernet interfaces, VLANs, and port groups. IPv6 forwarding is disabled only when you enable IPv6 address autoconfiguration on an interface and set it in host mode using the `ipv6 address autoconfig` command.
- IPv6 forwarding is permanently disabled on the management Ethernet interface so that it remains in Host mode and does not operate as a router regardless of the `ipv6 address autoconfig` setting.

If necessary, you can manually disable IPv6 processing on an interface so that the configured IPv6 addresses do not take effect. The IPv6 addresses take effect again when you re-enable IPv6.

If you disable IPv6 and configure a Layer (L2) interface in Layer (L3) mode, IPv6 is not automatically re-enabled on the interface. You must manually re-enable it.

A link-local address automatically generates when you re-enable IPv6 on an interface with the `ipv6 enable` command.

### Disable and enable IPv6

```
OS10(config)# interface ethernet 1/1/8
OS10(conf-if-eth1/1/8)# ipv6 address 2111:dddd:0eee::22/64
OS10(conf-if-eth1/1/8)# no ipv6 address autoconfig
OS10(conf-if-eth1/1/8)# no ipv6 enable
OS10(conf-if-eth1/1/8)# ipv6 enable
```

### Display IPv6 status

```
OS10# show interface ethernet 1/1/20
Ethernet 1/1/20 is up, line protocol is up
Hardware is Dell EMC Eth, address is ec:f4:bb:fb:fa:30
 Current address is ec:f4:bb:fb:fa:30
Pluggable media present, QSFP+ type is QSFP+ 40GBASE CR 1.0M
 Wavelength is 850
 Receive power reading is 0.0
Interface index is 17305562
Internet address is 20.20.20.1/24
Mode of IPv4 Address Assignment: MANUAL
Interface IPv6 oper status: Enabled
Link local IPv6 address: fe80::eef4:bbff:febf:fa30/64
Global IPv6 address: 2020::1/64
...
```

```
OS10# show ipv6 interface brief
Interface Name admin/protocol IPv6 Address/Link-Local Address IPv6 Oper Status
=====
Ethernet 1/1/1:1 up / up fe80::eef4:bbff:febf:f9f0/64
 2017::1/64 Enabled
Ethernet 1/1/20 up / up fe80::eef4:bbff:febf:fa30/64
 2020::1/64 Enabled
Management 1/1/1 up / up fe80::eef4:bbff:febf:f9ef/64
 Enabled
Vlan 1 up / up fe80::eef4:bbff:febf:fa59/64
 Enabled
```

## IPv6 addresses

An IPv6 address consists of a 48-bit global routing prefix, optional 16-bit subnet ID, and a 64-bit interface identifier in the extended universal identifier (EUI)-64 format.

IPv6 128-bit addresses are represented as a series of eight 16-bit hexadecimal fields separated by colons: x:x:x:x:x:x:x.

```
2001:0db8:0000:0000:0000:0000:1428:57a
```

Leading zeros in each field are optional. You can also use two colons (::) to represent successive hexadecimal fields of zeros, but you can use this short version only one time in each address:

```
2001:db8::1428:57ab
```

In the following example, all the addresses are valid and equivalent:

- 2001:0db8:0000:0000:0000:0000:1428:57ab
- 2001:0db8:0000:0000:0000::1428:57ab
- 2001:0db8:0:0:0:0:1428:57ab
- 2001:0db8:0:0::1428:57ab
- 2001:0db8::1428:57ab
- 2001:db8::1428:57ab

Write IPv6 networks using CIDR notation. An IPv6 network or subnet is a contiguous group of IPv6 addresses which must be a power of two. The initial bits of addresses, which are identical for all hosts in the network, are the network's prefix.

A network is denoted by the first address in the network and the size in bits of the prefix in decimal, separated with a slash. Because a single host is seen as a network with a 128-bit prefix, host addresses may be written with a following /128.

For example, 2001:0db8:1234::/48 stands for the network with addresses

2001:0db8:1234:0000:0000:0000:0000 through 2001:0db8:1234:ffff:ffff:ffff:ffff:ffff.

As soon as you assign an IPv6 address, IPv6 packet processing is enabled on an interface. You can manually disable and re-enable IPv6 processing on an interface configured with an IPv6 address using the `no ipv6 enable` and `ipv6 enable` commands.

To remove all IPv6 addresses from an interface, use the `no ipv6 address` command. To remove a specific IPv6 address, use the `ipv6 address ipv6-address/mask` command.

### Link-local addresses

When an OS10 switch boots up, an IPv6 unicast link-local address automatically assigns to an interface using stateless configuration. A link-local address allows IPv6 devices on a local link to communicate without requiring a globally unique address. IPv6 reserves the address block FE80::/10 for link-local unicast addressing.

### Global addresses

To enable stateless autoconfiguration of an IPv6 global address and set the interface to Host mode, use the `ipv6 address autoconfig` command. The router receives network prefixes in IPv6 router advertisements (RAs). An interface ID appends to the prefix. In Host mode, IPv6 forwarding is disabled.

The `no ipv6 address autoconfig` command disables IPv6 global address autoconfiguration, and sets the interface to Router mode with IPv6 forwarding enabled.

### DHCP-assigned addresses

As an alternative to stateless autoconfiguration, you can enable a network host to obtain IPv6 addresses using a DHCP server via stateful autoconfiguration using the `ipv6 address dhcp` command. A DHCPv6 server uses a prefix pool to configure a network address on an interface. The interface ID automatically generates.

**NOTE:** On the management interfaces or management VLANs, when the IP address is acquired using DHCPv6, the IPv6 address with a /128 prefix-mask is assigned to the interface. However, to preserve backward compatibility and allow reachability, a static route with a /64 prefix-mask is also made available.

### Manally configured addresses

An interface can have multiple IPv6 addresses. To configure an IPv6 address in addition to the link-local address, use the `ipv6 address ipv6-address/mask` command. Enter the full 128-bit IPv6 address, including the network prefix and a 64-bit interface ID.

**NOTE:** Dell EMC Networking does not recommend configuring both a static IPv6 address and DHCPv6 on the same interface.

You can also manually configure an IPv6 address by assigning:

- A network prefix with the EUI-64 parameter using the `ipv6 address ipv6-prefix eui64` command. A 64-bit interface ID automatically generates based on the MAC address.
- A link-local address to use instead of the link-local address that automatically configures when you enable IPv6 using the `ipv6 address link-local` command.

### Configure IPv6 address

```
OS10(config)# interface ethernet 1/1/8
OS10(conf-if-eth1/1/8)# ipv6 address 2001:dddd:0eee::4/64
```

## Configure network prefix

```
OS10(config)# interface ethernet 1/1/8
OS10(conf-if-eth1/1/8)# ipv6 address 2001:FF21:1:1::/64 eui64
```

## Configure link-local address

```
OS10(config)# interface ethernet 1/1/8
OS10(conf-if-eth1/1/8)# ipv6 address FE80::1/64 link-local
```

# Stateless autoconfiguration

When an interface comes up, OS10 uses stateless autoconfiguration to generate a unique link-local IPv6 address with a FE80::/64 prefix and an interface ID generated from the MAC address. To use stateless autoconfiguration to assign a globally unique address using a prefix received in router advertisements, use the `ipv6 address autoconfig` command.

Stateless autoconfiguration sets an interface in Host mode, and allows the interface connected to an IPv6 network to autoconfigure IPv6 addresses and communicate with other IPv6 devices on local links. A DHCP server is not required for automatic IPv6 interface configuration. IPv6 devices on a local link send router advertisement (RA) messages in response to solicitation messages received at startup.

Perform stateless autoconfiguration of IPv6 addresses using:

|                                    |                                                                                                                                                                  |
|------------------------------------|------------------------------------------------------------------------------------------------------------------------------------------------------------------|
| <b>Prefix advertisement</b>        | Routers use router advertisement messages to advertise the network prefix. Hosts append their interface-identifier MAC address to generate a valid IPv6 address. |
| <b>Duplicate address detection</b> | An IPv6 host node checks whether that address is used anywhere on the network using this mechanism before configuring its IPv6 address.                          |
| <b>Prefix renumbering</b>          | Transparent renumbering of hosts in the network when an organization changes its service provider.                                                               |

IPv6 provides the flexibility to add prefixes on RAs in response to a router solicitation (RS). By default, RA response messages are sent when an RS message is received. The system manipulation of IPv6 stateless autoconfiguration supports the router side only. Neighbor Discovery (ND) messages advertise so the neighbor can use the information to auto-configure its address. Received ND messages are not used to create an IPv6 address.

Inconsistencies in RA values between routers are logged. The values checked for consistency include:

- Current hop limit
- M and O flags
- Reachable time
- Retransmission timer
- MTU options
- Preferred and valid lifetime values for the same prefix

The router redirect functionality in the NDP is similar to IPv4 router redirect messages. NDP uses ICMPv6 redirect messages (Type 137) to inform nodes that a better router exists on the link.

## Neighbor Discovery

The IPv6 NDP determines if neighboring IPv6 devices are reachable and receives the IPv6 addresses of IPv6 devices on local links. Using the link-layer and global prefixes of neighbor addresses, OS10 performs stateless autoconfiguration of IPv6 addresses on interfaces.

ICMPv6 RA messages advertise the IPv6 addresses of IPv6-enabled interfaces and allow a router to learn of any address changes in IPv6 neighbors. By default, RAs are disabled on an interface.

### Prerequisites

To enable RA messages, the switch must be in Router mode with IPv6 forwarding enabled and stateless autoconfiguration disabled using the `no ipv6 address autoconfig` command.

### Enable router advertisement messages



1. Enable IPv6 neighbor discovery and sending ICMPv6 RA messages in Interface mode.

```
ipv6 nd send-ra
```

2. (Optional) Configure IPv6 neighbor discovery options in Interface mode.

- `ipv6 nd hop-limit hops` — (Optional) Sets the hop limit advertised in RA messages and included in IPv6 data packets sent by the router, from 0 to 255; default 64. 0 indicates that no hop limit is specified by the router.
- `ipv6 nd managed-config-flag` — (Optional) Sent in RA messages to tell hosts to use stateful address autoconfiguration, such as DHCPv6, to obtain IPv6 addresses.
- `ipv6 nd max-ra-interval seconds` — (Optional) Sets the maximum time interval for sending RA messages, from 4 to 1800 seconds; default 600.
- `ipv6 nd mtu number` — (Optional) Sets the maximum transmission unit (MTU) used in RA messages on the link, from 1280 to 65535 bytes; default 1500. By default, no MTU setting is included in RA messages.
- `ipv6 nd other-config-flag` — (Optional) Tells hosts to use stateful autoconfiguration to obtain nonaddress-related information.
- `ipv6 nd ra-lifetime seconds` — (Optional) Sets the lifetime of a default router in RA messages, from 0 to 9000 milliseconds; default 3 times the `max-ra-interval` setting. 0 indicates that this router is not used as a default router.
- `ipv6 nd reachable-time milliseconds` — (Optional) Sets the advertised time the router sees that a neighbor is up after it receives neighbor reachability confirmation, from 0 to 3600000 milliseconds; default 0. 0 indicates that no reachable time is sent in RA messages.
- `ipv6 nd retrans-timer seconds` — (Optional) Sets the time between retransmitting neighbor solicitation messages, from 100 to 4292967295 milliseconds. By default, no retransmit timer is configured.

3. Configure the IPv6 prefixes that are advertised by IPv6 neighbor discovery in Interface mode.

```
ipv6 nd prefix {ipv6-prefix | default} [no-advertise] [no-autoconfig] [no-rtr-address]
[off-link] [lifetime {valid-lifetime seconds | infinite}
{preferred-lifetime seconds | infinite}]
```

- `ipv6-prefix` — Enter an IPv6 prefix in `x:x:y/mask` format to include the prefix in RA messages. Include prefixes that are not already in the subnets configured on the interface.
- `default` — Configure the prefix parameters advertised in all subnets configured on the interface.
- `no-advertise` — (Optional) Do not advertise the specified prefix. By default, all prefixes in configured subnets are advertised.
- `no-autoconfig` — (Optional) Sets `AdvAutonomous` to `Off` for the specified prefix in the `radvd.conf` file. This setting tells hosts to not use this prefix for address autoconfiguration. By default, `AdvAutonomous` is `On`.
- `no-rtr-address` — (Optional) Sets `AdvRouterAddr` to `Off` for the prefix in the `radvd.conf` file. The `Off` setting tells hosts to not use the advertising router address for on-link determination. By default, `AdvRouterAddr` is `On`.
- `off-link` — (Optional) Sets `AdvOnLink` to `Off` for the prefix in the `radvd.conf` file. The `Off` setting tells hosts to not use this prefix for on-link determination. By default, `AdvOnLink` is `On`.
- `lifetime {valid-lifetime seconds | infinite}` — (Optional) Sets `AdvValidLifetime` in seconds for the prefix in the `radvd.conf` file. The prefix is valid for on-link determination only for the specified lifetime. The default is 86400 seconds (1 day). The `infinite` setting allows the prefix to be valid for on-link determination with no time limit.
- `lifetime {preferred-lifetime seconds | infinite}` — (Optional) Sets `AdvPreferredLifetime` in seconds for the prefix in the `radvd.conf` file. IPv6 addresses generated from the prefix using stateless autoconfiguration remain preferred for the configured lifetime. The default is 14400 seconds (4 hours). The `infinite` setting allows addresses that are autoconfigured using the prefix to be preferred with no time limit.

By default, all prefixes configured in IPv6 addresses on an interface are advertised. To modify the default values advertised for interface subnet prefixes, use the `ipv6 nd prefix default` command and specify new default settings.

On-link determination is the process used to forward IPv6 packets to a destination IPv6 address.

### Configure neighbor discovery

```
OS10(config)# interface ethernet 1/1/1
OS10(conf-if-eth1/1/1)# ipv6 nd mtu 1500
OS10(conf-if-eth1/1/1)# ipv6 nd send-ra
```

## Configure advertised IPv6 prefixes

```
OS10(config)# interface ethernet 1/1/1
OS10(conf-if-eth1/1/1)# ipv6 nd prefix default lifetime infinite infinite
OS10(conf-if-eth1/1/1)# ipv6 nd prefix 2002::/64
```

## Duplicate address discovery

To determine if an IPv6 unicast address is unique before assigning it to an interface, an OS10 switch sends a neighbor solicitation message. If the process of duplicate address discovery (DAD) detects a duplicate address in the network, the address does not configure on the interface. DAD is enabled by default.

By default, IPv6 is not disabled when a duplicate address is detected. Only the duplicate address is not applied. Other IPv6 addresses are still active on the interface.

To disable IPv6 on an interface when a duplicate link-local address is detected, use the `ipv6 nd dad disable-ipv6-on-failure` command. To re-enable IPv6 after you resolve a duplicate link-local address, enter `no ipv6 enable`, then the `ipv6 enable` command.

- Disable or re-enable IPv6 duplicate address discovery in Interface mode.

```
ipv6 nd dad {disable | enable}
```

- Disable IPv6 on an interface if a duplicate link-local address is discovered in Interface mode.

```
ipv6 nd dad disable-ipv6-on-dad-failure
```

### Disable duplicate address discovery

```
OS10(config)# interface ethernet 1/1/1
OS10(conf-if-eth1/1/1)# ipv6 nd dad disable
```

### Disable IPv6 for duplicate link-local address

```
OS10(config)# interface ethernet 1/1/1
OS10(conf-if-eth1/1/1)# ipv6 nd dad disable-ipv6-on-dad-failure
```

## Static IPv6 routing

To define an explicit route between two IPv6 networking devices, configure a static route on an interface. Static routing is useful for smaller networks with only one path to an outside network, or to provide security for certain traffic types in a larger network.

- Enter the static routing information including the IPv6 address and mask in `x:x:x:x` format in CONFIGURATION mode. The length is from 0 to 64.

```
ipv6 route ipv6-prefix/mask {next-hop | interface interface [route-preference]}
```

- *next-hop* — Enter the next-hop IPv6 address in `x:x:x:x` format.
- *interface interface* — Enter the interface type then the slot/port or number information.
- *route-preference* — (Optional) Enter a route-preference range, from 1 to 255.

After you configure a static IPv6 route, configure the forwarding router's address on the interface. The IPv6 neighbor interface must have an IPv6 address configured.

### Configure IPv6 static routing and view configuration

```
OS10(config)# ipv6 route 2111:dddd:0eee::22/128 2001:db86:0fff::2
OS10(config)# do show ipv6 route static
Codes: C - connected
 S - static
 B - BGP, IN - internal BGP, EX - external BGP
 O - OSPF, IA - OSPF inter area, N1 - OSPF NSSA external type 1,
 N2 - OSPF NSSA external type 2, E1 - OSPF external type 1,
 E2 - OSPF external type 2, > - non-active route
```

```

Gateway of last resort is not set
 Destination Gateway Dist/Metric Last Change

S 2111:dddd:eee::22/12via 2001:db86:fff::2 ethernet1/1/1 1/1 00:01:24

```

## IPv6 destination unreachable

By default, when no matching entry for an IPv6 route is found in the IPv6 routing table, a packet drops and no error message is sent. You can enable the capability to send an IPv6 `destination unreachable` error message to the source without dropping the packet.

### Enable IPv6 unreachable destination messaging

```

OS10(config)# interface ethernet 1/1/8
OS10(conf-if-eth1/1/8)# ipv6 unreachable

```

## IPv6 hop-by-hop options

A hop-by-hop header extension in an IPv6 packet contains options that are processed by all IPv6 routers in the packet's path. By default, hop-by-hop header options in an IPv6 packet do not process locally. To enable local processing of IPv6 hop-by-hop options on an interface, use the `ipv6 hop-by-hop` command.

### Enable IPv6 hop-by-hop options forwarding

```

OS10(config)# interface ethernet 1/1/8
OS10(conf-if-eth1/1/8)# ipv6 hop-by-hop

```

## View IPv6 information

To view IPv6 configuration information, use the `show ipv6 route` command. To view IPv6 address information, use the `show address ipv6` command.

### View IPv6 connected information

```

OS10# show ipv6 route connected
Codes: C - connected
 S - static
 B - BGP, IN - internal BGP, EX - external BGP
 O - OSPF, IA - OSPF inter area, N1 - OSPF NSSA external type 1,
 N2 - OSPF NSSA external type 2, E1 - OSPF external type 1,
 E2 - OSPF external type 2, > - non-active route
Gateway of last resort is not set
 Destination Gateway Dist/Metric Last Change

C 2001:db86::/32 via 2001:db86:fff::1 ethernet1/1/1 0/0 00:03:24

```

### View IPv6 static information

```

OS10# show ipv6 route static
Codes: C - connected
 S - static
 B - BGP, IN - internal BGP, EX - external BGP
 O - OSPF, IA - OSPF inter area, N1 - OSPF NSSA external type 1,
 N2 - OSPF NSSA external type 2, E1 - OSPF external type 1,
 E2 - OSPF external type 2, > - non-active route
Gateway of last resort is not set
 Destination Gateway Dist/Metric Last Change

S 2111:dddd:eee::22/12via 2001:db86:fff::2 ethernet1/1/1 1/1 00:01:24

```

## IPv6 commands

### clear ipv6 neighbors

Deletes all entries in the IPv6 neighbor discovery cache or neighbors of a specific interface. Static entries are not removed.

|                           |                                                                                                                                                                                                                                                                                                                                                                                                                                                                                                                                                                                                                                                                                                                                                                                                                                                                                                                                                                                                                                                                                                                                                                                                                                                                                                                                                        |
|---------------------------|--------------------------------------------------------------------------------------------------------------------------------------------------------------------------------------------------------------------------------------------------------------------------------------------------------------------------------------------------------------------------------------------------------------------------------------------------------------------------------------------------------------------------------------------------------------------------------------------------------------------------------------------------------------------------------------------------------------------------------------------------------------------------------------------------------------------------------------------------------------------------------------------------------------------------------------------------------------------------------------------------------------------------------------------------------------------------------------------------------------------------------------------------------------------------------------------------------------------------------------------------------------------------------------------------------------------------------------------------------|
| <b>Syntax</b>             | <code>clear ipv6 neighbors [vrf vrf-name] [ipv6-address   interface   virtual-network vn-id   all]</code>                                                                                                                                                                                                                                                                                                                                                                                                                                                                                                                                                                                                                                                                                                                                                                                                                                                                                                                                                                                                                                                                                                                                                                                                                                              |
| <b>Parameters</b>         | <ul style="list-style-type: none"><li>• <code>vrf vrf-name</code> — (Optional) Enter <code>vrf</code> then the name of the VRF to clear the neighbor corresponding to that VRF. If you do not specify this option, the neighbors in the default VRF clear.</li><li>• <code>ipv6-address</code> — Enter the IPv6 address of the neighbor in the <code>x:x:x:x</code> format to remove a specific IPv6 neighbor. The <code>::</code> notation specifies successive hexadecimal fields of zero.</li><li>• <code>interface interface</code> — To remove all neighbor entries learned on a specific interface, enter the keyword <code>interface</code> then the interface type and slot/port or number information of the interface:<ul style="list-style-type: none"><li>○ For a 10-Gigabit Ethernet interface, enter <code>TenGigabitEthernet</code> then the slot/port/subport[/subport] information.</li><li>○ For a 40-Gigabit Ethernet interface, enter <code>fortyGigE</code> then the slot/port information.</li><li>○ For a port channel interface, enter <code>port-channel</code> then a number.</li><li>○ For a VLAN interface, enter <code>vlan</code> then a number from 1 to 4093.</li><li>○ <code>virtual-network vn-id</code> — For a virtual network, enter <code>virtual-network</code> then the ID of the network.</li></ul></li></ul> |
| <b>Defaults</b>           | None.                                                                                                                                                                                                                                                                                                                                                                                                                                                                                                                                                                                                                                                                                                                                                                                                                                                                                                                                                                                                                                                                                                                                                                                                                                                                                                                                                  |
| <b>Command Mode</b>       | EXEC                                                                                                                                                                                                                                                                                                                                                                                                                                                                                                                                                                                                                                                                                                                                                                                                                                                                                                                                                                                                                                                                                                                                                                                                                                                                                                                                                   |
| <b>Usage Information</b>  | The <code>no</code> version of this command resets the value to the default.                                                                                                                                                                                                                                                                                                                                                                                                                                                                                                                                                                                                                                                                                                                                                                                                                                                                                                                                                                                                                                                                                                                                                                                                                                                                           |
| <b>Example</b>            |                                                                                                                                                                                                                                                                                                                                                                                                                                                                                                                                                                                                                                                                                                                                                                                                                                                                                                                                                                                                                                                                                                                                                                                                                                                                                                                                                        |
| <b>Supported Releases</b> | 10.4.1.0 or later or later                                                                                                                                                                                                                                                                                                                                                                                                                                                                                                                                                                                                                                                                                                                                                                                                                                                                                                                                                                                                                                                                                                                                                                                                                                                                                                                             |

### clear ipv6 route

Clears routes from the IPv6 routing table.

|                           |                                                                                                                                                                                                                                                                                                                                                                                                                                                                                                                 |
|---------------------------|-----------------------------------------------------------------------------------------------------------------------------------------------------------------------------------------------------------------------------------------------------------------------------------------------------------------------------------------------------------------------------------------------------------------------------------------------------------------------------------------------------------------|
| <b>Syntax</b>             | <code>clear ipv6 route [vrf vrf-name] {*   A::B/mask}</code>                                                                                                                                                                                                                                                                                                                                                                                                                                                    |
| <b>Parameters</b>         | <ul style="list-style-type: none"><li>• <code>vrf vrf-name</code> — (Optional) Enter <code>vrf</code> then the name of the VRF to clear the IPv6 routes corresponding to that VRF.</li><li>• <code>*</code> — Clears all routes and refreshes the IPv6 routing table. Traffic flow for all the routes in the switch is affected.</li><li>• <code>A::B/mask</code> — Removes the IPv6 route and refreshes the IPv6 routing table. Traffic flow in the switch is affected only for the specified route.</li></ul> |
| <b>Default</b>            | Not configured                                                                                                                                                                                                                                                                                                                                                                                                                                                                                                  |
| <b>Command Mode</b>       | EXEC                                                                                                                                                                                                                                                                                                                                                                                                                                                                                                            |
| <b>Usage Information</b>  | This command does not remove the static routes from the routing table.                                                                                                                                                                                                                                                                                                                                                                                                                                          |
| <b>Example</b>            | <pre>OS10# clear ipv6 route *</pre>                                                                                                                                                                                                                                                                                                                                                                                                                                                                             |
| <b>Supported Releases</b> | 10.3.0E or later                                                                                                                                                                                                                                                                                                                                                                                                                                                                                                |

## ipv6 address

Configures a global unicast IPv6 address on an interface.

|                     |                                                                                                                                                        |
|---------------------|--------------------------------------------------------------------------------------------------------------------------------------------------------|
| <b>Syntax</b>       | <code>ipv6 address ipv6-address/prefix-length</code>                                                                                                   |
| <b>Parameters</b>   | <code>ipv6-address/prefix-length</code> — Enter a full 128-bit IPv6 address with the network prefix length, including the 64-bit interface identifier. |
| <b>Defaults</b>     | None                                                                                                                                                   |
| <b>Command Mode</b> | INTERFACE                                                                                                                                              |

**Usage Information** An interface can have multiple IPv6 addresses. To configure an IPv6 address in addition to the link-local address, use the `ipv6 address ipv6-address/mask` command and specify the complete 128-bit IPv6 address. To configure a globally unique IPv6 address by entering only the network prefix and length, use the `ipv6 address ipv6-prefix/prefix-length eui-64` command.

The `no` version of this command removes the IPv6 address on the interface.

 **NOTE:** Dell Technologies does not recommend configuring both a static IPv6 address and DHCPv6 on the same interface.

### Example

```
OS10(config)# interface ethernet 1/1/1
OS10(conf-if-eth1/1/1)# ipv6 address 2111:dddd:0eee::22/64
```

**Supported Releases** 10.3.0E or later

## ipv6 address autoconfig

Acquires global IPv6 addresses by using the network prefix obtained from RAs.

|                     |                                             |
|---------------------|---------------------------------------------|
| <b>Syntax</b>       | <code>ipv6 address autoconfig</code>        |
| <b>Parameters</b>   | None                                        |
| <b>Defaults</b>     | Disabled except on the management interface |
| <b>Command Mode</b> | INTERFACE                                   |

**Usage Information**

- This command sets an interface in Host mode to perform IPv6 stateless auto-configuration by discovering prefixes on local links, and adding an EUI-64 based interface identifier to generate each IPv6 address. The command disables IPv6 forwarding. Addresses are configured depending on the prefixes received in RA messages.
- The `no` version of this command disables IPv6 address autoconfiguration, resets the interface in Router mode, and re-enables IPv6 forwarding.

### Example

```
OS10(config)# interface ethernet 1/1/1
OS10(conf-if-eth1/1/1)# no switchport
OS10(conf-if-eth1/1/1)# ipv6 address autoconfig
OS10(conf-if-eth1/1/1)#
```

**Supported Releases** 10.3.0E or later

## ipv6 address dhcp

Enables DHCP client operations on the interface.

|                   |                                |
|-------------------|--------------------------------|
| <b>Syntax</b>     | <code>ipv6 address dhcp</code> |
| <b>Parameters</b> | None                           |
| <b>Defaults</b>   | None                           |

**Command Mode** INTERFACE

**Usage Information** The `no` version of this command disables DHCP operations on the interface.

 **NOTE:** Dell EMC Networking does not recommend configuring both a static IPv6 address and DHCPv6 on the same interface.

**Example**

```
OS10(config)# interface mgmt 1/1/1
OS10(conf-if-ma-1/1/1)# ipv6 address dhcp
```

**Supported Releases** 10.3.0E or later

## ipv6 enable

Enables and disables IPv6 forwarding on an interface configured with an IPv6 address.

**Syntax** `ipv6 enable`

**Parameters** None

**Defaults** None

**Command Mode** INTERFACE

**Usage Information** Use this command to disable and re-enable IPv6 forwarding on an interface for security purposes or to recover from a duplicate address discovery (DAD) failure. The `no` version of this command disables IPv6 forwarding.

**Example**

```
OS10(config)# interface ethernet 1/1/1
OS10(conf-if-eth1/1/1)# ipv6 address 2111:dddd:0eee::22/128
OS10(conf-if-eth1/1/1)# no ipv6 enable
OS10(conf-if-eth1/1/1)# ipv6 enable
```

**Supported Releases** 10.3.0E or later

## ipv6 address eui-64

Configures a global IPv6 address on an interface by entering only the network prefix and length.

**Syntax** `ipv6 address ipv6-prefix/prefix-length eui-64`

**Parameters** *ipv6-prefix* — Enter an IPv6 prefix in `x::y/mask` format.

**Defaults** None

**Command Mode** INTERFACE

**Usage Information** Use this command to manually configure an IPv6 address in addition to the link-local address generated with stateless autoconfiguration. Specify only the network prefix and length. The 64-bit interface ID automatically computes from the MAC address. This command enables IPv6 processing on the interface. The `no` version of this command removes the IPv6 address configuration.

**Example**

```
OS10(config)# interface mgmt 1/1/1
OS10(conf-if-ma-1/1/1)# ipv6 address 2111:dddd:0eee::/64 eui-64
```

**Supported Releases** 10.4.0E(R1) or later

## ipv6 address link-local

Configures a link-local IPv6 address on the interface to use instead of the link-local address that is automatically configured with stateless autoconfiguration.

**Syntax** `ipv6 address ipv6-prefix link-local`

**Parameters** *ipv6-prefix* — Enter an IPv6 prefix in *x::y/mask* format.

**Defaults** None

**Command Mode** INTERFACE

**Usage Information**

- An interface can have only one link-local address. By default, an IPv6 link-local address automatically generates with a MAC-based EUI-64 interface ID when a router boots up and IPv6 is enabled. Use this command to manually configure a link-local address to replace the autoconfigured address. For example, to configure a more user-friendly link-local address, replace `fe80::eef4:bbff:feeb:fa30/64` with `fe80::1/64`.
- The `no` version of this command removes the specified link-local address.

### Example

```
OS10(config)# interface mgmt 1/1/1
OS10(conf-if-ma-1/1/1)# ipv6 address 2111:dddd:0eee::22/64 link-local
```

**Supported Releases** 10.4.0E(R1) or later

## ipv6 hop-by-hop

Enables and disables processing hop-by-hop options in IPv6 packet headers.

**Syntax** `ipv6 hop-by-hop`

**Parameters** None

**Defaults** Hop-by-hop header options in an IPv6 packet do not process on an interface.

**Command Mode** INTERFACE

**Usage Information**

- Use this command to enable local processing of IPv6 packets with hop-by-hop options in conformance with the RFC 8200, IPv6 Specification.
- The `no` version of this command disables IPv6 processing of hop-by-hop header options.

### Example: Disable hop-by-hop option processing

```
OS10(config)# interface ethernet 1/2/3
OS10(conf-if-eth1/2/3)# no ipv6 hop-by-hop
```

**Supported Releases** 10.4.0E(R1) or later

## ipv6 nd dad

Disables or re-enables IPv6 duplicate address discovery (DAD).

**Syntax** `ipv6 nd dad {disable | enable | disable-ipv6-on-dad-failure}`

**Parameters**

- `disable` — Disable duplicate address discovery on the interface.
- `enable` — Re-enable IPv6 duplicate address discovery if you have disabled it.
- `disable-ipv6-on-dad-failure` — Enable duplicate address discovery on the existing autoconfigured link-local address.

**Defaults** Duplicate address discovery is enabled on an interface.

**Command Mode** INTERFACE

- Usage Information**
- An OS10 switch sends a neighbor solicitation message to determine if an autoconfigured IPv6 unicast link-local address is unique before assigning it to an interface. If the process of duplicate address discovery (DAD) detects a duplicate address in the network, the link-local address does not configure. Other IPv6 addresses are still active on the interface.
  - By default, DAD does not disable IPv6 if a duplicate link-local address is detected in the network. To disable IPv6 on an interface when a duplicate link-local address is detected, use the `ipv6 nd dad disable-ipv6-on-failure` command.

**Example: Disable DAD**

```
OS10(config)# interface ethernet 1/1/1
OS10(conf-if-eth1/1/1)# ipv6 nd dad disable
```

**Example: Enable DAD on link-local address**

```
OS10(config)# interface ethernet 1/1/1
OS10(conf-if-eth1/1/1)# ipv6 nd dad disable-ipv6-on-dad-failure
```

**Supported Releases** 10.4.0E(R1) or later

## ipv6 nd hop-limit

Sets the hop limit advertised in RA messages and included in IPv6 data packets sent by the router.

**Syntax** `ipv6 nd hop-limit hops`

**Parameters**

- `hop-limit hops` — Enter the maximum number of hops allowed for RA messages, from 0 to 255.

**Defaults** 64 hops

**Command Mode** INTERFACE

**Usage Information** The configured hop limit is advertised in RA messages and included in IPv6 data packets sent by the router. 0 indicates that no hop limit is specified by the router.

**Example**

```
OS10(config)# interface ethernet 1/2/3
OS10(conf-if-eth1/2/3)# ipv6 nd hop-limit 100
```

**Supported Releases** 10.4.0E(R1) or later

## ipv6 nd managed-config-flag

Sends RA messages that tell hosts to use stateful address autoconfiguration, such as DHCPv6, to obtain IPv6 addresses.

**Syntax** `ipv6 nd managed-config-flag`

**Parameters** None

**Defaults** Not configured

**Command Mode** INTERFACE

**Usage Information** The no version of this command disables the `managed-config-flag` option in RA messages.

**Example**

```
OS10(config)# interface ethernet 1/2/3
OS10(conf-if-eth1/2/3)# ipv6 nd managed-config-flag
```

**Supported Releases** 10.4.0E(R1) or later



## ipv6 nd max-ra-interval

Sets the maximum time interval between sending RA messages.

**Syntax** `ipv6 nd max-ra-interval seconds`

**Parameters**

- `max-ra-interval seconds`—Enter a time interval in seconds, from 4 to 1800.

**Defaults** 600 seconds

**Command Mode** INTERFACE

**Usage Information** The `no` version of this command restores the default time interval that is used to send RA messages.

**Example**

```
OS10(config)# interface ethernet 1/2/3
OS10(conf-if-eth1/2/3)# ipv6 nd max-ra-interval 300
```

**Supported Releases** 10.4.0E(R1) or later

## ipv6 nd mtu

Sets the maximum transmission unit (MTU) used on a local link in RA messages.

**Syntax** `ipv6 nd mtu number`

**Parameters**

- `mtu number` — Enter the MTU size in bytes, from 1280 to 65535.

**Defaults** 1500 bytes

**Command Mode** INTERFACE

**Usage Information** The `no` version of this command restores the default MTU value advertised in RA messages.

**Example**

```
OS10(config)# interface ethernet 1/2/3
OS10(conf-if-eth1/2/3)# ipv6 nd mtu 2500
```

**Supported Releases** 10.4.0E(R1) or later

## ipv6 nd other-config-flag

Sends RA messages that tell hosts to use stateful autoconfiguration to obtain nonaddress-related information.

**Syntax** `ipv6 nd other-config-flag`

**Parameters** None

**Defaults** Not configured

**Command Mode** INTERFACE

**Usage Information** The `no` version of this command disables the `other-config-flag` option in RA messages.

**Example**

```
OS10(config)# interface ethernet 1/2/3
OS10(conf-if-eth1/2/3)# ipv6 nd other-config-flag
```

**Supported Releases** 10.4.0E(R1) or later

## ipv6 nd prefix

Configures the IPv6 prefixes that are included in messages to neighboring IPv6 routers.

|                           |                                                                                                                                                                                                                                                                                                                                                                                                                                                                                                                                                                                                                                                                                                                                                                                                                                                                                                                                                                                                                                                                                                                                                                                                                                                                                                                                                                                                                                                                                                                                                                                                                                                                                                                                                                                                                                                                                                                                                                                                                                                                                                                                                                                                                                                                                                                                                                                                                  |
|---------------------------|------------------------------------------------------------------------------------------------------------------------------------------------------------------------------------------------------------------------------------------------------------------------------------------------------------------------------------------------------------------------------------------------------------------------------------------------------------------------------------------------------------------------------------------------------------------------------------------------------------------------------------------------------------------------------------------------------------------------------------------------------------------------------------------------------------------------------------------------------------------------------------------------------------------------------------------------------------------------------------------------------------------------------------------------------------------------------------------------------------------------------------------------------------------------------------------------------------------------------------------------------------------------------------------------------------------------------------------------------------------------------------------------------------------------------------------------------------------------------------------------------------------------------------------------------------------------------------------------------------------------------------------------------------------------------------------------------------------------------------------------------------------------------------------------------------------------------------------------------------------------------------------------------------------------------------------------------------------------------------------------------------------------------------------------------------------------------------------------------------------------------------------------------------------------------------------------------------------------------------------------------------------------------------------------------------------------------------------------------------------------------------------------------------------|
| <b>Syntax</b>             | <code>ipv6 nd prefix {<i>ipv6-prefix</i>   default} [no-advertise] [no autoconfig] [no-rtr-address] [off-link] [lifetime {valid-lifetime <i>seconds</i>   infinite} {preferred-lifetime <i>seconds</i>   infinite}]</code>                                                                                                                                                                                                                                                                                                                                                                                                                                                                                                                                                                                                                                                                                                                                                                                                                                                                                                                                                                                                                                                                                                                                                                                                                                                                                                                                                                                                                                                                                                                                                                                                                                                                                                                                                                                                                                                                                                                                                                                                                                                                                                                                                                                       |
| <b>Parameters</b>         | <ul style="list-style-type: none"><li>• <code>ipv6-prefix</code> — Enter an IPv6 prefix in <code>x::y/mask</code> format to include the prefix in RA messages. Include prefixes that are not already in the subnets on the interface.</li><li>• <code>default</code> — Configure the prefix parameters advertised in all subnets configured on the interface.</li><li>• <code>no-advertise</code> — (Optional) Do not advertise the specified prefix. By default, all prefixes in configured subnets advertise.</li><li>• <code>no-autoconfig</code> — (Optional) Sets <code>AdvAutonomous</code> to <code>Off</code> for the specified prefix in the <code>radvd.conf</code> file. This setting tells hosts to not use this prefix for address autoconfiguration. By default, <code>AdvAutonomous</code> is <code>On</code>.</li><li>• <code>no-rtr-address</code> — (Optional) Sets <code>AdvRouterAddr</code> to <code>Off</code> for the prefix in the <code>radvd.conf</code> file. The <code>Off</code> setting tells hosts to not use the advertising router's address for on-link determination. By default, <code>AdvRouterAddr</code> is <code>On</code>.</li><li>• <code>off-link</code> — (Optional) Sets <code>AdvOnLink</code> to <code>Off</code> for the prefix in the <code>radvd.conf</code> file. The <code>Off</code> setting tells hosts to not use this prefix for on-link determination. By default, <code>AdvOnLink</code> is <code>On</code>.</li><li>• <code>lifetime {valid-lifetime <i>seconds</i>   infinite}</code> — (Optional) Sets <code>AdvValidLifetime</code> in seconds for the prefix in the <code>radvd.conf</code> file. The prefix is valid for on-link determination only for the specified lifetime. The default is 86400 seconds (1 day). The <code>infinite</code> setting allows the prefix to be valid for on-link determination with no time limit.</li><li>• <code>lifetime {preferred-lifetime <i>seconds</i>   infinite}</code> — (Optional) Sets <code>AdvPreferredLifetime</code> in seconds for the prefix in the <code>radvd.conf</code> file. IPv6 addresses generated from the prefix using stateless autoconfiguration remain preferred for the configured lifetime. The default is 14400 seconds (4 hours). The <code>infinite</code> setting allows addresses that are autoconfigured using the prefix to be preferred with no time limit.</li></ul> |
| <b>Defaults</b>           | All prefixes in IPv6 subnets configured on an interface advertise.                                                                                                                                                                                                                                                                                                                                                                                                                                                                                                                                                                                                                                                                                                                                                                                                                                                                                                                                                                                                                                                                                                                                                                                                                                                                                                                                                                                                                                                                                                                                                                                                                                                                                                                                                                                                                                                                                                                                                                                                                                                                                                                                                                                                                                                                                                                                               |
| <b>Command Mode</b>       | INTERFACE                                                                                                                                                                                                                                                                                                                                                                                                                                                                                                                                                                                                                                                                                                                                                                                                                                                                                                                                                                                                                                                                                                                                                                                                                                                                                                                                                                                                                                                                                                                                                                                                                                                                                                                                                                                                                                                                                                                                                                                                                                                                                                                                                                                                                                                                                                                                                                                                        |
| <b>Usage Information</b>  | <ul style="list-style-type: none"><li>• By default, all prefixes configured in IPv6 addresses on an interface advertise. To advertise all default parameters in the subnet prefixes on an interface, enter the <code>default</code> keyword.</li><li>• If you configure a prefix with valid or preferred lifetime values, the <code>ipv6 nd prefix default no autoconfig</code> command does not apply the default prefix values.</li><li>• On-link determination is used to forward IPv6 packets to a destination IPv6 address.</li></ul>                                                                                                                                                                                                                                                                                                                                                                                                                                                                                                                                                                                                                                                                                                                                                                                                                                                                                                                                                                                                                                                                                                                                                                                                                                                                                                                                                                                                                                                                                                                                                                                                                                                                                                                                                                                                                                                                       |
| <b>Examples</b>           | <p><b>Enable router advertisements</b></p> <pre>OS10(conf-if-eth1/1/1)# ipv6 address 2001:0db8:2000::1/64 OS10(conf-if-eth1/1/1)# ipv6 nd send-ra</pre> <p><b>Change default settings for interface subnet prefixes</b></p> <pre>OS10(conf-if-eth1/1/1)# ipv6 nd prefix default lifetime infinite infinite</pre> <p><b>Disable advertising an interface subnet prefix</b></p> <pre>OS10(conf-if-eth1/1/1)# ipv6 nd prefix 2001:0db8:2000::/64 no-advertise</pre> <p><b>Advertise prefix for which there is no interface address</b></p> <pre>OS10(conf-if-eth1/1/1)# ipv6 nd prefix 2001:0db8:3000::/64 no-autoconfig</pre>                                                                                                                                                                                                                                                                                                                                                                                                                                                                                                                                                                                                                                                                                                                                                                                                                                                                                                                                                                                                                                                                                                                                                                                                                                                                                                                                                                                                                                                                                                                                                                                                                                                                                                                                                                                      |
| <b>Supported Releases</b> | 10.4.0E(R1) or later                                                                                                                                                                                                                                                                                                                                                                                                                                                                                                                                                                                                                                                                                                                                                                                                                                                                                                                                                                                                                                                                                                                                                                                                                                                                                                                                                                                                                                                                                                                                                                                                                                                                                                                                                                                                                                                                                                                                                                                                                                                                                                                                                                                                                                                                                                                                                                                             |

## ipv6 nd ra-lifetime

Sets the lifetime of the default router in RA messages.

**Syntax** `ipv6 nd ra-lifetime seconds`

**Parameters**

- `ra-lifetime seconds` — Enter a lifetime value in milliseconds, from 0 to 9000 milliseconds.

**Defaults** Three times the `max-ra-interval` value

**Command Mode** INTERFACE

**Usage Information** The `no` version of this command restores the default lifetime value. 0 indicates that this router is not used as the default router.

**Example**

```
OS10(config)# interface ethernet 1/2/3
OS10(conf-if-eth1/2/3)# ipv6 nd max-ra-interval 300
```

**Supported Releases** 10.4.0E(R1) or later

## ipv6 nd reachable-time

Sets the advertised time the router sees a neighbor to be up after it receives a reachability confirmation.

**Syntax** `ipv6 nd reachable-time milliseconds`

**Parameters**

- `reachable-time milliseconds` — Enter the reachable time in milliseconds, from 0 to 3600000.

**Defaults** 0

**Command Mode** INTERFACE

**Usage Information** The `no` version of this command restores the default reachable time. 0 indicates that no reachable time is sent in RA messages.

**Example**

```
OS10(config)# interface ethernet 1/2/3
OS10(conf-if-eth1/2/3)# ipv6 nd reachable-time 1000
```

**Supported Releases** 10.4.0E(R1) or later

## ipv6 nd retrans-timer

Sets the time between retransmitting neighbor solicitation messages.

**Syntax** `ipv6 nd retrans-timer seconds`

**Parameters**

- `retrans-timer seconds` — Enter the retransmission time interval in milliseconds, from 100 to 4292967295.

**Defaults** Not configured

**Command Mode** INTERFACE

**Usage Information** The `no` version of this command disables the configured retransmission timer.

**Example**

```
OS10(config)# interface ethernet 1/2/3
OS10(conf-if-eth1/2/3)# ipv6 nd retrans-timer 1000
```

**Supported Releases** 10.4.0E(R1) or later

## ipv6 nd send-ra

Enables sending ICMPv6 RA messages.

**Syntax** `ipv6 nd send-ra`

**Parameters** None

**Defaults** RA messages are disabled.

**Command Mode** INTERFACE

**Usage Information**

- Using ICMPv6 RA messages, the Neighbor Discovery Protocol (NDP) advertises the IPv6 addresses of IPv6-enabled interfaces and learns of any address changes in IPv6 neighbors. Before you enable sending RA messages, the switch must be in Router mode with IPv6 forwarding enabled and stateless autoconfiguration disabled `no ipv6 address autoconfig` command.
- The `no` version command disables RA messages.

### Example

```
OS10(config)# interface ethernet 1/2/3
OS10(conf-if-eth1/2/3)# ipv6 nd send-ra
```

**Supported Releases** 10.4.0E(R1) or later

## ipv6 route

Configures a static IPv6 static route.

**Syntax** `ipv6 route [vrf vrf-name] dest-ipv6-prefix mask {next-hop | interface interface-type [route-preference]} [bfd]`

**Parameters**

- `vrf vrf-name` — (Optional) Enter `vrf` then the name of the VRF to install IPv6 routes in that VRF.
- `dest-ipv6-prefix` — Enter the destination IPv6 address in `x:x:x:x` format.
- `mask` — Enter the mask in slash prefix-length `/x` format.
- `next-hop` — Enter the next-hop IPv6 address in `x:x:x:x` format.
- `interface interface-type` — Enter the interface type then the slot/port or number information. The interface types supported are: Ethernet, port-channel, VLAN, and Null.
- `route-preference` — (Optional) Enter a route-preference range, from 1 to 255.
- `bfd` — (Optional) Enable BFD on a specific static route.

**Default** Not configured

**Command Mode** CONFIGURATION

**Usage Information**

When the interface fails, the system withdraws the route. The route reinstalls when the interface comes back up. When a recursive resolution breaks, the system withdraws the route. The route reinstalls when the recursive resolution is satisfied. After you create an IPv6 static route interface, if you do not assign an IP address to a peer interface, you must manually ping the peer to resolve the neighbor information.

The `no` version of this command deletes the IPv6 route configuration.

Use the `bfd` option to enable Bidirectional Forwarding detection (BFD) on a specific static route.

### Example

```
OS10(config)# ipv6 route 2111:dddd:0eee::22/128 2001:db86:0fff::2
```

```
OS10(config)# ipv6 route 2111:dddd:0eee::22/128 interface null 0
```

The following is a sample configuration for enabling BFD on a specific IPv6 static route:

```
OS10(config)# ipv6 route 2111:dddd:0eee::22/128 2001:db86:0fff::2 bfd
```

**Supported Releases** 10.2.0E or later

## ipv6 unreachable

Enables generating error messages on an interface for IPv6 packets with unreachable destinations.

|                     |                                           |
|---------------------|-------------------------------------------|
| <b>Syntax</b>       | <code>ipv6 unreachable</code>             |
| <b>Parameters</b>   | None                                      |
| <b>Defaults</b>     | ICMPv6 unreachable messages are not sent. |
| <b>Command Mode</b> | INTERFACE                                 |

- Usage Information**
- By default, when no matching entry for an IPv6 route is found in the IPv6 routing table, the packet drops and no error message is sent. Use this command to enable sending an `IPv6 destination unreachable` error message to the source without dropping the packet.
  - The `no` version of this command disables generating unreachable destination messages.

**Example**

```
OS10(config)# interface ethernet 1/2/3
OS10(conf-if-eth1/2/3)# ipv6 unreachable
```

**Supported Releases** 10.4.0E(R1) or later

## show ipv6 neighbors

Displays IPv6 discovery information. Entering the command without options shows all IPv6 neighbor addresses stored on the control processor (CP).

**Syntax** `show ipv6 neighbors [vrf vrf-name] [ipv6-address| interface interface]`

- Parameters**
- `vrf vrf-name` — (Optional) Enter `vrf` then the name of the VRF to display the neighbors corresponding to that VRF. If you do not specify this option, neighbors corresponding to the default VRF display.
  - `ipv6-address` — Enter the IPv6 address of the neighbor in the `x:x:x:x` format. The `::` notation specifies successive hexadecimal fields of zero.
  - `interface interface` — Enter `interface` then the interface type and slot/port or number information:
    - For a 10-Gigabit Ethernet interface, enter `TenGigabitEthernet` then the slot/port/subport[/subport] information.
    - For a 40-Gigabit Ethernet interface, enter `fortyGigE` then the slot/port information.
    - For a port channel interface, enter `port-channel` then a number.
    - For a VLAN interface, enter `vlan` then a number from 1 to 4093.

**Defaults** None.

**Command Mode** EXEC

**Usage Information** The `no` version of this command resets the value to the default.

**Example**

```
OS10# show ipv6 neighbors
IPv6 Address Hardware Address State Interface VLAN

1001:db8:a1::2 00:c5:05:02:12:91 REACH ethernet1/1/5 12
1001:db8:a1::f 00:f5:50:02:54:75 REACH port-channel5 12
200::2 00:c5:05:02:12:91 STALE ethernet1/1/10
400::f 00:f5:50:02:54:75 REACH port-channel20
```

**Supported Releases** 10.4.1.0 or later or later

## show ipv6 route

Displays IPv6 routes.

**Syntax** `show ipv6 route [vrf vrf-name] [all | bgp | connected | static | A::B/mask | summary]`

- Parameters**
- `vrf vrf-name` — (Optional) Enter `vrf` then the name of the VRF to display IPv6 routes corresponding to that VRF. If you do not specify this option, routes corresponding to the default VRF display.
  - `all`—(Optional) Displays all routes including nonactive routes.
  - `bgp`—(Optional) Displays BGP route information.
  - `connected`—(Optional) Displays only the directly connected routes.
  - `static`—(Optional) Displays all static routes.
  - `A::B/mask`—(Optional) Enter the IPv6 destination address and mask.  
 **NOTE:** This option works only for the exact prefix and the mask length.
  - `summary`—(Optional) Displays the IPv6 route summary.

**Default** Not configured

**Command Mode** EXEC

**Usage Information** None

### Example (All)

```
OS10# show ipv6 route all
Codes: C - connected
 S - static
 B - BGP, IN - internal BGP, EX - external BGP
 O - OSPF, IA - OSPF inter area, N1 - OSPF NSSA external type 1,
 N2 - OSPF NSSA external type 2, E1 - OSPF external type 1,
 E2 - OSPF external type 2, > - non-active route
Gateway of last resort is not set
 Destination Gateway Dist/Metric Last Change

```

### Example (Connected)

```
OS10# show ipv6 route connected
Codes: C - connected
 S - static
 B - BGP, IN - internal BGP, EX - external BGP
 O - OSPF, IA - OSPF inter area, N1 - OSPF NSSA external type 1,
 N2 - OSPF NSSA external type 2, E1 - OSPF external type 1,
 E2 - OSPF external type 2, > - non-active route
Gateway of last resort is not set
 Destination Gateway Dist/Metric Last Change

C 2001:db86::/32 via 2001:db86:fff::1 ethernet1/1/1 0/0 00:03:24
```

### Example (Summary)

```
OS10# show ipv6 route summary
Route Source Active Routes Non-Active Routes

Ospf 0 0
Bgp 0 0
Connected 0 0
Static 0 0
Ospf Inter-area 0 0
NSSA External-1 0 0
NSSA External-2 0 0
Ospf External-1 0 0
Ospf External-2 0 0
Bgp Internal 0 0
Bgp External 0 0
Ospf Intra-area 0 0
Total 0 0
```

**Supported Releases** 10.2.0E or later

## show ipv6 interface brief

Displays IPv6 interface information.

**Syntax** `show ipv6 interface brief`

**Parameters** `brief` — Displays a brief summary of IPv6 interface information.

**Defaults** None

**Command Mode** EXEC

**Usage Information** Use the `do show ipv6 interface brief` command to view IPv6 interface information in other modes.

### Example (Brief)

```
OS10# show ipv6 interface brief
```

| Interface Name    | admin/protocol | IPv6 Address/Link-Local Address  | IPv6 Oper Status |
|-------------------|----------------|----------------------------------|------------------|
| Management Vlan 1 | 1/1/1 up/up    | fe80::20c:29ff:fe54:c852/64      | Enabled          |
| Ethernet 1/1/2    | up/up          | fe80::20c:29ff:fe54:c853/64      | Enabled          |
| Ethernet 1/1/3    | up/up          | 1001:1:1:1:20c:29ff:fe54:c853/64 | Enabled          |
| Ethernet 1/1/4    | up/up          | fe80::4/64                       | Disabled         |
|                   |                | 3000::1/64                       |                  |
|                   |                | 4000::1/64                       | Disabled         |
|                   |                | 4::1/64                          |                  |
|                   |                | 5::1/64                          | Enabled          |

**Supported Releases** 10.2.0E or later or later

## Open shortest path first

OSPF routing is a link-state routing protocol that allows sending link-state advertisements (LSAs) to all other routers within the same autonomous system (AS) area. OSPF LSAs include information about attached interfaces, metrics used, and other attributes. OSPF routers accumulate link-state information, and use the shortest path first (SPF) algorithm to calculate the shortest path to each node.

## Autonomous system areas

OSPF operates in a hierarchy. The largest entity within the hierarchy is the autonomous system (AS). The AS is a collection of networks under a common administration that share a common routing strategy. OSPF is an intra-AS, Interior Gateway Routing Protocol (IGRP) that receives routes from and sends routes to other AS.

You can divide an AS into several areas, which are groups of contiguous networks and attached hosts administratively grouped. Routers with multiple interfaces can participate in multiple areas. These routers, called area border routers (ABRs), maintain separate databases for each area. Areas are a logical grouping of OSPF routers that an integer or dotted-decimal number identifies.

Areas allow you to further organize routers within the AS with one or more areas within the AS. Areas allow subnetworks to *hide* within the AS—minimizing the size of the routing tables on all routers. An area within the AS may not see the details of another area's topology. An area number or the router's IP address identifies AS areas.

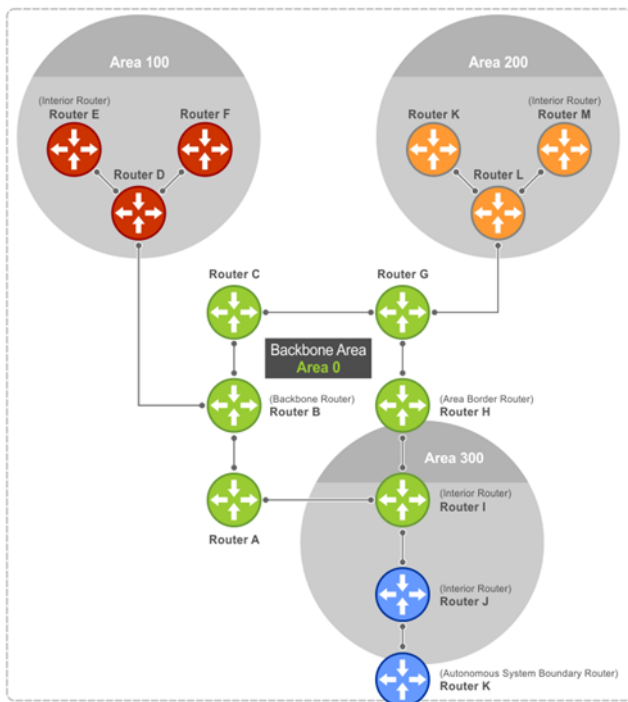

## Areas, networks, and neighbors

The backbone of the network is Area 0, also called Area 0.0.0.0, the core of any AS. All other areas must connect to Area 0. An OSPF backbone distributes routing information between areas. It consists of all area border routers and networks not wholly contained in any area and their attached routers.

The backbone is the only area with a default area number. You configure all other areas Area ID. If you configure two nonbackbone areas, you must enable the B bit in OSPF. Routers, A, B, C, G, H, and I are the backbone, see [Autonomous system areas](#).

- A stub area (SA) does not receive external route information, except for the default route. These areas do receive information from interarea (IA) routes.
- A not-so-stubby area (NSSA) can import AS external route information and send it to the backbone as type-7 LSA.
- Totally stubby areas are also known as no summary areas.

Configure all routers within an assigned stub area as stubby and do not generate LSAs that do not apply. For example, a Type 5 LSA is intended for external areas and the stubby area routers may not generate external LSAs. A virtual link cannot traverse stubby areas.

### Networks and neighbors

As a link-state protocol, OSPF sends routing information to other OSPF routers concerning the state of the links between them. The Up or Down state of those links is important. Routers that share a link become neighbors on that segment. OSPF uses the `hello` protocol as a neighbor discovery and `keepalive` mechanism. After two routers are neighbors, they may proceed to exchange and synchronize their databases, which creates an adjacency.

## Router types

Router types are attributes of the OSPF process—multiple OSPF processes may run on the same router. A router connected to more than one area, receiving routing from a BGP process connected to another AS, acts as both an area border router and an autonomous system border router.

Each router has a unique ID, written in decimal A.B.C.D format. You do not have to associate the router ID with a valid IP address. To make troubleshooting easier, ensure the router ID is identical to the router's IP address.



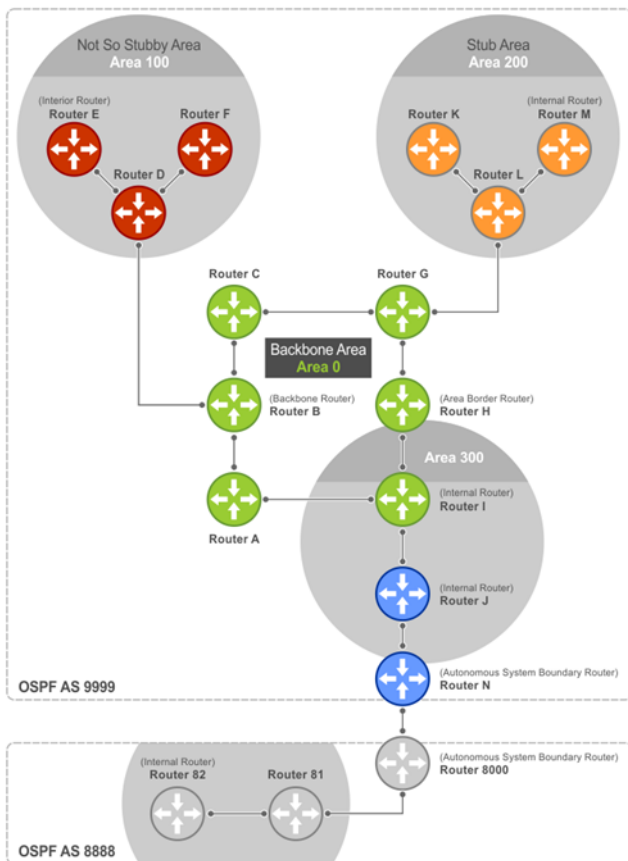

- Backbone router** A backbone router (BR) is part of the OSPF Backbone, Area 0, and includes all ABRs. The BR includes routers connected only to the backbone and another ABR, but are only part of Area 0—shown as Router I in the example.
- Area border router** Within an AS, an area border router (ABR) connects one or more areas to the backbone. The ABR keeps a copy of the link-state database for every area it connects to. It may keep multiple copies of the link state database. An ABR summarizes learned information from one of its attached areas before it is sent to other connected areas. An ABR can connect to many areas in an AS and is considered a member of each area it connects to—shown as Router H in the example.
- Autonomous system border router** The autonomous system border router (ASBR) connects to more than one AS and exchanges information with the routers in other ASs. The ASBR connects to a non-IGP such as BGP or uses static routes—shown as Router N in the example.
- Internal router** The internal router (IR) has adjacencies with ONLY routers in the same area—shown as Routers E, F, I, K, and M in the example.

## Designated and backup designated routers

OSPF elects a designated router (DR) and a backup designated router (BDR). The DR generates LSAs for the entire multiaccess network. Designated routers allow a reduction in network traffic and in the size of the topological database.

- Designated router** Maintains a complete topology table of the network and sends updates to the other routers via multicast. All routers in an area form a slave/master relationship with the DR. Every time a router sends an update, the router sends it to the DR and BDR. The DR sends the update to all other routers in the area.
- Backup designated router** Router that takes over if the DR fails.

Each router exchanges information with the DR and BDR. The DR and BDR relay information to other routers. On broadcast network segments, the number of OSPF packets reduces by the DR sending OSPF updates to a multicast IP address that all OSPF routers on the network segment are listening on.

DRs and BDRs are configurable. If you do not define the DR or BDR, OSPF assigns them per the protocol. To determine which routers are the DR and BDR, OSPF looks at the priority of the routers on the segment. The default router priority is 1. The router with the highest priority is elected DR. If there is a tie, the router with the higher router ID takes precedence. After the DR is elected, the BDR is elected the same way. A router with a router priority set to zero cannot become a DR or BDR.

## Link-state advertisements

A link-state advertisement (LSA) communicates the router's routing topology to all other routers in the network.

|                                                                                     |                                                                                                                                                                                                                                                                                                                                      |
|-------------------------------------------------------------------------------------|--------------------------------------------------------------------------------------------------------------------------------------------------------------------------------------------------------------------------------------------------------------------------------------------------------------------------------------|
| <b>Type 1—Router LSA</b>                                                            | Router lists links to other routers or networks in the same area. Type 1 LSAs flood across their own area only. The link-state ID of the Type 1 LSA is the originating router ID.                                                                                                                                                    |
| <b>Type 2—Network LSA</b>                                                           | DR in an area lists which routers are joined within the area. Type 2 LSAs flood across their own area only. The link-state ID of the Type 2 LSA is the IP interface address of the DR.                                                                                                                                               |
| <b>Type 3—Summary LSA (OSPFv2), Inter-Area Prefix LSA (OSPFv3)</b>                  | ABR takes information it has learned on one of its attached areas and summarizes it before sending it out on other areas it connects to. The link-state ID of the Type 3 LSA is the destination network's IP address.                                                                                                                |
| <b>Type 4—AS Border Router Summary LSA (OSPFv2), Inter-Area-Router LSA (OSPFv3)</b> | In some cases, Type 5 External LSAs flood to areas where the detailed next-hop information may not be available because it may be using a different routing protocol. The ABR floods the information for the router, the ASBR where the Type 5 originated. The link-state ID for Type 4 LSAs is the router ID of the described ASBR. |
| <b>Type 5—AS-External LSA</b>                                                       | LSAs contain information imported into OSPF from other routing processes. Type 5 LSAs flood to all areas except stub areas. The link-state ID of the Type 5 LSA is the external network number.                                                                                                                                      |
| <b>Type 7—NSSA-External LSA (OSPFv2), LSA (OSPFv3)</b>                              | Routers in an NSSA do not receive external LSAs from ABRs but send external routing information for redistribution. They use Type 7 LSAs to tell the ABRs about these external routes, which the ABR then translates to Type 5 external LSAs and floods as normal to the rest of the OSPF network.                                   |
| <b>Type 8—Link LSA (OSPFv3)</b>                                                     | Type 8 LSA carries the IPv6 address information of the local links.                                                                                                                                                                                                                                                                  |
| <b>Type 9—Link-Local Opaque LSA (OSPFv2), Intra-Area Prefix LSA (OSPFv3)</b>        | Link-local <i>opaque</i> LSA as defined by RFC2370 for OSPFv2. Intra-Area-Prefix LSA carries the IPv6 prefixes of the router and network links for OSPFv3.                                                                                                                                                                           |
| <b>Type 11—Grace LSA (OSPFv3)</b>                                                   | Link-local <i>opaque</i> LSA for OSPFv3 only is sent during a graceful restart by an OSPFv3 router.                                                                                                                                                                                                                                  |

The LSA header is common to LSA types. Its size is 20 bytes. One of the fields of the LSA header is the link-state ID. Each router link is defined as one of four types—type 1, 2, 3, or 4. The LSA includes a link ID field that identifies the object this link connects to, by the network number and mask. Depending on the type, the link ID has different meanings.

|          |                                                                   |
|----------|-------------------------------------------------------------------|
| <b>1</b> | Point-to-point connection to another router or neighboring router |
| <b>2</b> | Connection to a transit network IP address of the DR              |
| <b>3</b> | Connection to a stub network IP network or subnet number          |
| <b>4</b> | Virtual link neighboring router ID                                |

## Router priority

Router priority determines the designated router for the network. The default router priority is 1. When two routers attach to a network, both attempt to become the DR. The router with the higher router priority takes precedence. If there is a tie, the router with the higher router ID takes precedence. A router with a router priority set to zero cannot become the DR or BDR.

If not assigned, the system selects the router with the highest priority as the DR. The second highest priority is the BDR. Priority rates from 0 to 255, with 255 as the highest number with the highest priority.

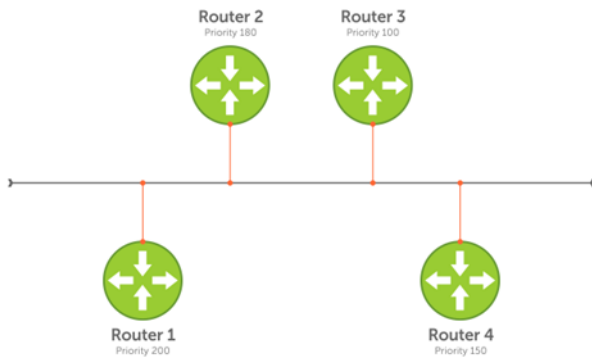

Router 1 selected by the system as DR.  
 Router 2 selected by the system as BDR.  
 If R1 fails, the BDR router becomes the DR. The new BDR election occurs according to router priority.  
 R4 becomes the BDR.

### OSPF route limit

OS10 supports up to 16,000 OSPF routes. Within this range, the only restriction is on intra-area routes that scale only up to 1000 routes. Other OSPF routes can scale up to 16 K.

## Shortest path first throttling

Use shortest path first (SPF) throttling to delay SPF calculations during periods of network instability. In an OSPF network, a topology change event triggers an SPF calculation that is performed after a start time. When the start timer finishes, a hold time can delay the next SPF calculation for an additional time.

When the hold timer is running:

- Each time a topology change occurs, the SPF calculation delays for double the configured hold time up to maximum wait time.
- If no topology change occurs, an SPF calculation is performed and the hold timer is reset to its configured value.

Set the start, hold, and wait timers according to the stability of the OSPF network topology. Enter the values in milliseconds (ms). If you do not specify a start-time, hold-time, or max-wait value, the default values are used.

OSPFv2 and OSPFv3 instances support SPF throttling. By default, SPF timers are disabled in an OSPF instance. Enter the `no` version of this command to remove the configured SPF timers and disable SPF throttling.

1. Configure an OSPF instance from CONFIGURATION mode, from 1 to 65535.

```
router {ospf | ospfv3} instance-number
```

2. Set OSPF throttling timers in OSPF INSTANCE mode.

```
timers spf [start-time [hold-time [max-wait]]]
```

- *start-time* — Configure the initial delay before performing an SPF calculation after a topology change, from 1 to 600000 milliseconds; default 1000.
- *hold-time* — Configure the additional delay before performing an SPF calculation when a new topology change occurs, from 1 to 600000 milliseconds; default 10000.
- *max-wait* — Configure the maximum amount of hold time that can delay an SPF calculation, from 1 to 600000 milliseconds; default 10000.

### Enable SPF throttling (OSPFv2)

```
OS10(config)# router ospf 100
OS10(config-router-ospf-100)# timers spf 1200 2300 3400
```

## Enable SPF throttling (OSPFv3)

```
OS10(config)# router ospfv3 10
OS10(config-router-ospfv3-10)# timers spf 2000 3000 4000
```

## View OSPFv2 SPF throttling

```
OS10(config-router-ospf-100)# do show ip ospf

Routing Process ospf 100 with ID 12.1.1.1
Supports only single TOS (TOS0) routes
It is Flooding according to RFC 2328
SPF schedule delay 1200 msecs, Hold time between two SPFs 2300 msecs
Convergence Level 0
Min LSA origination 0 msec, Min LSA arrival 1000 msec
Min LSA hold time 5000 msec, Max LSA wait time 5000 msec
Number of area in this router is 1, normal 1 stub 0 nssa 0
Area (0.0.0.1)
Number of interface in this area is 1
SPF algorithm executed 1 times
```

## View OSPFv3 SPF throttling

```
OS10(config-router-ospfv3-100)# timers spf 1345 2324 9234

OS10(config-router-ospfv3-100)# do show ipv6 ospf
Routing Process ospfv3 100 with ID 129.240.244.107
SPF schedule delay 1345 msecs, Hold time between two SPFs 2324 msecs
Min LSA origination 5000 msec, Min LSA arrival 1000 msec
Min LSA hold time 0 msec, Max LSA wait time 0 msec
Number of area in this router is 1, normal 1 stub 0 nssa
Area (0.0.0.1)
Number of interface in this area is 1
SPF algorithm executed 2 times
```

# OSPFv2

OSPFv2 supports IPv4 address families. OSPFv2 routers initially exchange `hello` messages to set up adjacencies with neighbor routers. The `hello` process establishes adjacencies between routers of the AS. It is not required that every router within the AS areas establish adjacencies. If two routers on the same subnet agree to become neighbors through this process, they begin to exchange network topology information in the form of LSAs.

In OSPFv2, neighbors on broadcast and non-broadcast multiple access (NBMA) network links are identified by their interface addresses, while neighbors on other types of links are identified by router-identifiers (RID).

## Enable OSPFv2

OSPFv2 is disabled by default. Configure at least one interface as either Physical or Loopback and assign an IP address to the interface. You can assign any area besides area 0 a number ID. The OSPFv2 process starts automatically when you configure it globally and you can enable it for one or more interfaces.

1. Enable OSPF globally and configure an OSPF instance in CONFIGURATION mode.

```
router ospf instance-number
```

2. Enter the interface information to configure the interface for OSPF in INTERFACE mode.

```
interface ethernet node/slot/port[:subport]
```

3. Enable the interface in INTERFACE mode.

```
no shutdown
```

4. Disable the default switchport configuration and remove it from an interface or a LAG port in INTERFACE mode.

```
no switchport
```

5. Assign an IP address to the interface in INTERFACE mode.

```
ip address ip-address/mask
```

6. Enable OSPFv2 on an interface in INTERFACE mode.

```
ip ospf process-id area area-id
```

- *process-id*—Enter the OSPFv2 process ID for a specific OSPF process, from 1 to 65535.
- *area-id*—Enter the OSPFv2 area ID as an IP address (A.B.C.D) or number, from 1 to 65535.

### Enable OSPFv2 configuration

```
OS10(config)# router ospf 100
OS10(config-router-ospf-100)# exit
OS10(config)# interface ethernet 1/1/1
OS10(config-if-eth1/1/1)# no shutdown
OS10(config-if-eth1/1/1)# no switchport
OS10(config-if-eth1/1/1)# ip address 11.1.1.1/24
OS10(config-if-eth1/1/1)# ip ospf 100 area 0.0.0.0
```

### View OSPFv2 configuration

```
OS10# show running-configuration ospf
!
interface ethernet1/1/1
 ip ospf 100 area 0.0.0.0
!
router ospf 100
...
```

## Enable OSPFv2 in a non-default VRF instance

To enable OSPFv2 in a non-default VRF instance:

1. Create a non-default VRF instance in which you want to enable OSPFv2:

```
ip vrf vrf-name
```

2. Enable OSPF and configure an OSPF instance in VRF CONFIGURATION mode.

```
router ospf instance-number vrf vrf-name
```

3. Enter the interface information to configure the interface for OSPF in INTERFACE mode.

```
interface ethernet node/slot/port[:subport]
```

4. Enable the interface in INTERFACE mode.

```
no shutdown
```

5. Disable the default switchport configuration and remove it from an interface or a LAG port in INTERFACE mode.

```
no switchport
```

6. Associate the interface with the non-default VRF instance that you created earlier.

```
ip vrf forwarding vrf-name
```

7. Assign an IP address to the interface.

```
ip address ip-address/mask
```

8. Enable OSPFv2 on the interface.

```
ip ospf process-id area area-id
```

- *process-id*—Enter the OSPFv2 process ID for a specific OSPF process, from 1 to 65535.

- *area-id*—Enter the OSPFv2 area ID as an IP address (A.B.C.D) or number, from 1 to 65535.

### Enable OSPFv2 configuration

```
OS10(config)# ip vrf vrf-blue
OS10(config-vrf-blue)# router ospf 100 vrf-blue
OS10(config-router-ospf-100)# exit
OS10(config)# interface ethernet 1/1/2
OS10(conf-if-eth1/1/2)# no shutdown
OS10(conf-if-eth1/1/2)# no switchport
OS10(conf-if-eth1/1/2)# ip vrf forwarding vrf-blue
OS10(conf-if-eth1/1/1)# ip address 11.1.1.1/24
OS10(conf-if-eth1/1/1)# ip ospf 100 area 0.0.0.0
```

#### NOTE:

If you want to move an interface associated with one VRF instance to another default or non-default VRF instance, you must first remove the OSPF or Layer3 configurations that already exist on the interface. If you move the interface from one VRF instance to another without removing these existing Layer3 or OSPF configurations, these configurations do not take effect in the new VRF instance.

Consider a scenario where the OSPF instance 100 is configured on the default VRF instance and the OSPF instance 200 is configured on the non-default VRF instance named VRF-Red. The interface eth1/1/1 on the default VRF instance is attached to an OSPF process 100 area 1. In this scenario, if you want to move eth1/1/1 from the default VRF instance to VRF-Red, you must first remove the OSPF area configuration to which the interface eth1/1/1 is currently attached to.

## Assign router identifier

For managing and troubleshooting purposes, you can assign a router ID for the OSPFv2 process. Use the router's IP address as the router ID.

- Assign the router ID for the OSPFv2 process in ROUTER-OSPF mode

```
router-id ip-address
```

### Assign router ID

```
OS10(config)# router ospf 10
OS10(conf-router-ospf-10)# router-id 10.10.1.5
```

### View OSPFv2 status

```
OS10# show ip ospf 10
Routing Process ospf 10 with ID 10.10.1.5
Supports only single TOS (TOS0) routes
It is an Autonomous System Boundary Router
It is Flooding according to RFC 2328
Convergence Level 0
Min LSA origination 0 msec, Min LSA arrival 1000 msec
Min LSA hold time 5000 msec, Max LSA wait time 5000 msec
Number of area in this router is 1, normal 1 stub 0 nssa 0
 Area (0.0.0.0)
 Number of interface in this area is 3
 SPF algorithm executed 38 times
 Area ranges are
```

## Stub areas

Type 5 LSAs are not flooded into stub areas. The ABR advertises a default route into the stub area where it is attached. Stub area routers use the default route to reach external destinations.

1. Enable OSPF routing and enter ROUTER-OSPF mode, from 1 to 65535.

```
router ospf instance number
```

2. Configure an area as a stub area in ROUTER-OSPF mode.

```
area area-id stub [no-summary]
```

- *area-id*—Enter the OSPF area ID as an IP address in A.B.C.D format or number, from 1 to 65535.
- *no-summary*—(Optional) Enter to prevent an ABR from sending summary LSA to the stub area.

### Configure stub area

```
OS10(config)# router ospf 10
OS10(conf-router-ospf-10)# area 10.10.5.1 stub
```

### View stub area configuration

```
OS10# show ip ospf
Routing Process ospf 10 with ID 130.6.196.14
Supports only single TOS (TOS0) routes
It is Flooding according to RFC 2328
SPF schedule delay 1000 msec, Hold time between two SPFs 10000 msec
Convergence Level 0
Min LSA origination 0 msec, Min LSA arrival 1000 msec
Min LSA hold time 5000 msec, Max LSA wait time 5000 msec
Number of area in this router is 1, normal 0 stub 1 nssa 0
Area (10.10.5.1)
 Number of interface in this area is 0
 SPF algorithm executed 1 times
Area ranges are
```

```
OS10# show running-configuration ospf
!
router ospf 10
area 10.10.5.1 stub
```

## Passive interfaces

A passive interface does not send or receive routing information. Configuring an interface as a passive interface suppresses both receiving and sending routing updates.

Although the passive interface does not send or receive routing updates, the network on that interface is included in OSPF updates sent through other interfaces.

1. Enter an interface type in INTERFACE mode.

```
interface ethernet node/slot/port[:subport]
```

2. Configure the interface as a passive interface in INTERFACE mode.

```
ip ospf passive
```

### Configure passive interfaces

```
OS10(config)# interface ethernet 1/1/6
OS10(conf-if-eth1/1/6)# ip ospf passive
```

### View passive interfaces

```
OS10# show running-configuration
!!!
!!
interface ethernet1/1/6
ip address 10.10.10.1/24
no switchport
no shutdown
ip ospf 100 area 0.0.0.0
ip ospf passive
!!
!
```

You can disable a passive interface using the `no ip ospf passive` command.

## Fast convergence

Fast convergence sets the minimum origination and arrival LSA parameters to zero (0), allowing rapid route calculation. A higher convergence level can result in occasional loss of OSPF adjacency.

Convergence level 1 meets most convergence requirements. The higher the number, the faster the convergence, and the more frequent the route calculations and updates. This impacts CPU utilization and may impact adjacency stability in larger topologies.

**NOTE:** Select higher convergence levels only after checking with Dell EMC Technical Support.

When you disable fast-convergence, origination and arrival LSA parameters are set to 0 msec and 1000 msec, respectively. Setting the convergence parameter from 1 to 4 indicates the actual convergence level. Each convergence setting adjusts the LSA parameters to zero, but the `convergence-level` parameter changes the convergence speed. The higher the number, the faster the convergence.

- Enable OSPFv2 fast-convergence and enter the convergence level in ROUTER-OSPF mode, from 1 to 4.

```
fast-converge convergence-level
```

### Configure fast convergence

```
OS10(config)# router ospf 65535
OS10(conf-router-ospf-65535)# fast-converge 1
```

### View fast convergence

```
OS10(conf-router-ospf-65535)# do show ip ospf

Routing Process ospf 65535 with ID 99.99.99.99
Supports only single TOS (TOS0) routes
It is an Autonomous System Border Router
It is an Area Border Router
It is Flooding according to RFC 2328
Convergence Level 1
Min LSA origination 0 msec, Min LSA arrival 0 msec
Min LSA hold time 0 msec, Max LSA wait time 0 msec
Number of area in this router is 3, normal 1 stub 1 nssa 1
 Area BACKBONE (0)
 Number of interface in this area is 1
 SPF algorithm executed 28 times
 Area ranges are

 Area (2)
 Number of interface in this area is 1
 SPF algorithm executed 28 times
 Area ranges are

 Area (3)
 Number of interface in this area is 1
 SPF algorithm executed 28 times
 Area ranges are
```

### Disable fast convergence

```
OS10(conf-router-ospf-65535)# no fast-converge
```

## Interface parameters

To avoid routing errors, interface parameter values must be consistent across all interfaces. For example, set the same time interval for the hello packets on all routers in the OSPF network to prevent misconfiguration of OSPF neighbors.

1. To change the OSPFv2 parameters in CONFIGURATION mode, enter the interface.

```
interface interface-name
```



2. Change the cost associated with OSPF traffic on the interface in INTERFACE mode, from 1 to 65535. The default depends on the interface speed.

```
ip ospf cost
```

3. Change the time interval, from 1 to 65535, that the router waits before declaring a neighbor dead in INTERFACE mode. The default time interval is 40. The dead interval must be four times the hello interval and must be the same on all routers in the OSPF network.

```
ip ospf dead-interval seconds
```

4. Change the time interval between hello-packet transmission in INTERFACE mode, from 1 to 65535. The default time interval is 10. The hello interval must be the same on all routers in the OSPF network.

```
ip ospf hello-interval seconds
```

5. Change the priority of the interface, which determines the DR for the OSPF broadcast network in INTERFACE mode, from 0 to 255. The default priority of the interface is 1.

```
ip ospf priority number
```

6. Change the retransmission interval time, in seconds, between LSAs in INTERFACE mode, from 1 to 3600. The default retransmission interval time is 5. The retransmit interval must be the same on all routers in the OSPF network.

```
ip ospf retransmit-interval seconds
```

7. Change the wait period between link state update packets sent out the interface in INTERFACE mode, from 1 to 3600. The default wait period is 1. The transmit delay must be the same on all routers in the OSPF network.

```
ip ospf transmit-delay seconds
```

### Change parameters and view interface status

```
OS10(conf-if-eth1/1/1)# ip ospf hello-interval 5
OS10(conf-if-eth1/1/1)# ip ospf dead-interval 20
OS10(conf-if-eth1/1/1)# ip ospf retransmit-interval 30
OS10(conf-if-eth1/1/1)# ip ospf transmit-delay 200
```

### View OSPF interface configuration

```
OS10(conf-if-eth1/1/1)# do show ip ospf interface

ethernet1/1/1 is up, line protocol is up
Internet Address 11.1.1.1/24, Area 0.0.0.0
Process ID 65535, Router ID 99.99.99.99, Network Type broadcast, Cost: 1
Transmit Delay is 200 sec, State BDR, Priority 1
Designated Router (ID) 150.1.1.1, Interface address 11.1.1.2
Backup Designated router (ID) 99.99.99.99, Interface address 11.1.1.1
Timer intervals configured, Hello 5, Dead 20, Wait 20, Retransmit 30
Neighbor Count is 1, Adjacent neighbor count is 1
 Adjacent with neighbor 150.1.1.1 (Designated Router)
```

## Redistribute routes

Add routes from other routing instances or protocols to the OSPFv2 process and include BGP, static, or connected routes in the OSPFv2 process. Do not route IBGP routes to OSPFv2 unless there are route-maps associated with the OSPFv2 redistribution.

**NOTE:** With the `redistribute static` command in the running configuration, if a static route is configured which is also learned through OSPF, the static route is installed in the routing table even if the static route preference is higher than OSPF.

- Enter which routes redistribute into the OSPFv2 process in ROUTER-OSPF mode.

```
redistribute {bgp as-number| connected | static} [route-map map-name]
```

- `bgp | connected | static`—Enter a keyword to redistribute those routes.

- `route-map map-name`—Enter the name of a configured route map.

### Configure redistribute routes

```
OS10(config-router-ospf-10)# redistribute bgp 4 route-map aloha
OS10(config-router-ospf-10)# redistribute connected route-map aloha
OS10(config-router-ospf-10)# redistribute static route-map aloha
```

### View OSPF configuration

```
OS10(config-router-ospf-10)# do show running-configuration ospf
!
router ospf 10
 redistribute bgp 4 route-map aloha
 redistribute connected route-map aloha
 redistribute static route-map aloha
!
```

## Default route

You can generate an external default route and distribute the default information to the OSPFv2 routing domain.

- Generate the default route using the `default-information originate [always]` command in ROUTER-OSPF mode.

### Configure default route

```
OS10(config)# router ospf 10
OS10(config-router-ospf-10)# default-information originate always
```

### View default route configuration

```
OS10(config-router-ospf-10)# show configuration
!
router ospf 10
 default-information originate always
```

## Summary address

You can configure a summary address for an ASBR to advertise one external route as an aggregate, for all redistributed routes that are covered by specified address range.

- Configure the summary address in ROUTER-OSPF mode.  
`summary-address ip-address/mask [not-advertise | tag tag-value]`

### Configure summary address

```
OS10(config)# router ospf 100
OS10(config-router-ospf-100)# summary-address 10.0.0.0/8 not-advertise
```

### View summary address

```
OS10(config-router-ospf-100)# show configuration
!
router ospf 100
 summary-address 10.0.0.0/8 not-advertise
```

## Graceful restart

When a networking device restarts, the adjacent neighbors and peers detect the condition. During a graceful restart, the restarting device and neighbors continue to forward the packets without interrupting network performance. The neighbors that help in the restart process are called helper routers.

When you enable graceful restart, the restarting device retains the routes learned by OSPF in the forwarding table. To re-establish OSPF adjacencies with neighbors, the restart OSPF process sends a grace LSA to all neighbors. In response, the helper router enters Helper mode and sends an acknowledgement back to the restarting device.

OS10 supports graceful restart Helper mode. Use the `graceful-restart role helper-only` command to enable Helper mode in ROUTER OSPF mode.

```
OS10(config)# router ospf 10
OS10(conf-router-ospf-10)# graceful-restart role helper-only
```

Use the `no` version of the command to disable Helper mode.

## OSPFv2 authentication

You can enable OSPF authentication either with clear text or MD5.

- Set a clear text authentication scheme on the interface in INTERFACE mode.  
`ip ospf authentication-key key`
- Set MD5 authentication in INTERFACE mode.  
`ip ospf message-digest-key keyid md5 key`

### Configure text authentication

```
OS10(config)# interface ethernet 1/1/1
OS10(conf-if-eth1/1/1)# ip ospf authentication-key sample
```

### View text authentication

```
OS10(conf-if-eth1/1/1)# show configuration
!
interface ethernet1/1/1
 ip address 10.10.10.2/24
 no switchport
 no shutdown
 ip ospf 100 area 0.0.0.0
 ip ospf authentication-key sample
```

### Configure MD5 authentication

```
OS10(config)# interface ethernet 1/1/1
OS10(conf-if-eth1/1/1)# ip ospf message-digest-key 2 md5 sample12345
```

### View MD5 authentication

```
OS10(conf-if-eth1/1/1)# show configuration
!
interface ethernet1/1/1
 ip address 10.10.10.2/24
 no switchport
 no shutdown
 ip ospf 100 area 0.0.0.0
 ip ospf message-digest-key 2 md5 sample12345
```

## Troubleshoot OSPFv2

You can troubleshoot OSPFv2 operations, and check questions for typical issues that interrupt a process.

- Is OSPF enabled globally?
- Is OSPF enabled on the interface?
- Are adjacencies established correctly?
- Are the interfaces configured for L3 correctly?
- Is the router in the correct area type?
- Are the OSPF routes included in the OSPF database?

- Are the OSPF routes included in the routing table in addition to the OSPF database?
- Are you able to ping the IPv4 address of adjacent router interface?

### Troubleshooting OSPF with show commands

- View a summary of all OSPF process IDs enabled in EXEC mode.

```
show running-configuration ospf
```

- View summary information of IP routes in EXEC mode.

```
show ip route summary
```

- View summary information for the OSPF database in EXEC mode.

```
show ip ospf database
```

- View the configuration of OSPF neighbors connected to the local router in EXEC mode.

```
show ip ospf neighbor
```

- View routes that OSPF calculates in EXEC mode.

```
show ip ospf routes
```

### View OSPF configuration

```
OS10# show running-configuration ospf
!
interface ethernet1/1/1
ip ospf 100 area 0.0.0.0
!
router ospf 100
log-adjacency-changes
```

## Debug OSPF

Use the following procedures to debug OSPFv2 and OSPFv3.

- To debug OSPFv2:

```
debug ip ospfv2
```

- To debug OSPFv3:

```
debug ip ospfv3
```

## OSPFv2 commands

### area default-cost

Sets the metric for the summary default route generated by the ABR and sends it to the stub area.

|                     |                                                                                                                                                                                                                                                                            |
|---------------------|----------------------------------------------------------------------------------------------------------------------------------------------------------------------------------------------------------------------------------------------------------------------------|
| <b>Syntax</b>       | <code>area <i>area-id</i> default-cost <i>cost</i></code>                                                                                                                                                                                                                  |
| <b>Parameters</b>   | <ul style="list-style-type: none"> <li>• <i>area-id</i> — Enter the OSPF area in dotted decimal A.B.C.D format or enter a number, from 0 to 65535.</li> <li>• <i>cost</i> — Enter a cost for the stub area's advertised external route metric, from 0 to 65535.</li> </ul> |
| <b>Default</b>      | Cost is 1                                                                                                                                                                                                                                                                  |
| <b>Command Mode</b> | ROUTER-OSPF                                                                                                                                                                                                                                                                |

**Usage Information** The cost is also referred as *reference-bandwidth* or *bandwidth*. Use the `area default-cost` command on the border routers at the edge of a stub area. The `no` version of this command resets the value to the default.

**Example**

```
OS10(conf-router-ospf-10)# area 10.10.1.5 default-cost 10
```

**Supported Releases** 10.2.0E or later

## area nssa

Defines an area as a NSSA.

**Syntax** `area area-id nssa [default-information-originate | no-redistribution | no-summary]`

- Parameters**
- `area-id` — Enter the OSPF area ID as an IP address in A.B.C.D format or number, from 1 to 65535.
  - `no-redistribution` — (Optional) Prevents the `redistribute` command from distributing routes into the NSSA. Use `no-redistribution` command only in an NSSA ABR.
  - `no-summary` — (Optional) Ensures that no summary LSAs are sent to the NSSA.

**Default** Not configured

**Command Mode** ROUTER-OSPF

**Usage Information** The `no` version of this command deletes an NSSA.

**Example**

```
OS10(conf-router-ospf-10)# area 10.10.1.5 nssa
```

**Supported Releases** 10.2.0E or later

## area range

Summarizes routes matching an address/mask at an area in ABRs.

**Syntax** `area area-id range ip-address [no-advertise]`

- Parameters**
- `area-id` — Set the OSPF area ID as an IP address in A.B.C.D format or number, from 1 to 65535.
  - `ip-address` — (Optional) Enter an IP address/mask in dotted decimal format.
  - `no-advertise` — (Optional) Set the status to *Do Not Advertise*. The Type 3 summary-LSA is suppressed and the component networks remain hidden from other areas.

**Default** Not configured

**Command Mode** ROUTER-OSPF

**Usage Information** The `no` version of this command disables the route summarizations.

**Example**

```
OS10(conf-router-ospf-10)# area 0 range 10.1.1.4/8 no-advertise
```

**Supported Releases** 10.2.0E or later

## area stub

Defines an area as the OSPF stub area.

**Syntax** `area area-id stub [no-summary]`

|                           |                                                                                                                                                                                                                                                             |
|---------------------------|-------------------------------------------------------------------------------------------------------------------------------------------------------------------------------------------------------------------------------------------------------------|
| <b>Parameters</b>         | <ul style="list-style-type: none"> <li>• <i>area-id</i>—Set the OSPF area ID as an IP address in A.B.C.D format or number, from 1 to 65535.</li> <li>• <i>no-summary</i>—(Optional) Prevents an ABR from sending summary LAs into the stub area.</li> </ul> |
| <b>Default</b>            | Not configured                                                                                                                                                                                                                                              |
| <b>Command Mode</b>       | ROUTER-OSPF                                                                                                                                                                                                                                                 |
| <b>Usage Information</b>  | The <i>no</i> version of this command deletes a stub area.                                                                                                                                                                                                  |
| <b>Example</b>            | <pre>OS10(config)# router ospf 10 OS10(conf-router-ospf-10)# area 10.10.1.5 stub</pre>                                                                                                                                                                      |
| <b>Supported Releases</b> | 10.2.0E or later                                                                                                                                                                                                                                            |

## auto-cost reference-bandwidth

Calculates default metrics for the interface based on the configured auto-cost reference bandwidth value.

|                           |                                                                                                                                                                                                                       |
|---------------------------|-----------------------------------------------------------------------------------------------------------------------------------------------------------------------------------------------------------------------|
| <b>Syntax</b>             | <code>auto-cost reference-bandwidth value</code>                                                                                                                                                                      |
| <b>Parameters</b>         | <i>value</i> — Enter the reference bandwidth value to calculate the OSPF interface cost in megabits per second, from 1 to 4294967.                                                                                    |
| <b>Default</b>            | 100000                                                                                                                                                                                                                |
| <b>Command Mode</b>       | ROUTER-OSPF                                                                                                                                                                                                           |
| <b>Usage Information</b>  | The value set by the <code>ip ospf cost</code> command in INTERFACE mode overrides the cost resulting from the <code>auto-cost</code> command. The <i>no</i> version of this command resets the value to the default. |
| <b>Example</b>            | <pre>OS10(config)# router ospf 10 OS10(conf-router-ospf-10)# auto-cost reference-bandwidth 150</pre>                                                                                                                  |
| <b>Supported Releases</b> | 10.2.0E or later                                                                                                                                                                                                      |

## clear ip ospf process

Clears all OSPF routing tables.

|                           |                                                                                                                                                                                                                                                                                    |
|---------------------------|------------------------------------------------------------------------------------------------------------------------------------------------------------------------------------------------------------------------------------------------------------------------------------|
| <b>Syntax</b>             | <code>clear ip ospf {instance-number} [vrf vrf-name] process</code>                                                                                                                                                                                                                |
| <b>Parameters</b>         | <ul style="list-style-type: none"> <li>• <i>instance-number</i> — Enter an OSPF instance number, from 1 to 65535.</li> <li>• <i>vrf vrf-name</i> — Enter the keyword <code>vrf</code> followed by the name of the VRF to reset the OSPF process configured in that VRF.</li> </ul> |
| <b>Default</b>            | Not configured                                                                                                                                                                                                                                                                     |
| <b>Command Mode</b>       | EXEC                                                                                                                                                                                                                                                                               |
| <b>Usage Information</b>  | This command clears all entries in the OSPF routing table.                                                                                                                                                                                                                         |
| <b>Example</b>            | <pre>OS10# clear ip ospf 3 vrf vrf-test process</pre>                                                                                                                                                                                                                              |
| <b>Supported Releases</b> | 10.2.0E or later                                                                                                                                                                                                                                                                   |

## clear ip ospf statistics

Clears OSPF traffic statistics.

|                           |                                                                                                                                                                                                                                                                                                        |
|---------------------------|--------------------------------------------------------------------------------------------------------------------------------------------------------------------------------------------------------------------------------------------------------------------------------------------------------|
| <b>Syntax</b>             | <code>clear ip ospf [<i>instance-number</i>] [<i>vrf vrf-name</i>] statistics</code>                                                                                                                                                                                                                   |
| <b>Parameters</b>         | <ul style="list-style-type: none"><li>• <i>instance-number</i> — (Optional) Enter an OSPF instance number, from 1 to 65535.</li><li>• <i>vrf vrf-name</i> — (Optional) Enter the keyword <i>vrf</i> followed by the name of the VRF to clear OSPF traffic statistics in that configured VRF.</li></ul> |
| <b>Default</b>            | Not configured                                                                                                                                                                                                                                                                                         |
| <b>Command Mode</b>       | EXEC                                                                                                                                                                                                                                                                                                   |
| <b>Usage Information</b>  | This command clears the OSPF traffic statistics in a specified instance or in all the configured OSPF instances, and resets them to zero.                                                                                                                                                              |
| <b>Example</b>            | <pre>OS10# clear ip ospf 10 vrf vrf-test statistics</pre>                                                                                                                                                                                                                                              |
| <b>Supported Releases</b> | 10.4.0E(R1) or later                                                                                                                                                                                                                                                                                   |

## debug ip ospfv2

Enables Open Shortest Path First version 2 (OSPFv2) debugging and displays messages related to processing of OSPFv2.

|                           |                                                                                                       |
|---------------------------|-------------------------------------------------------------------------------------------------------|
| <b>Syntax</b>             | <code>debug ip ospfv2</code>                                                                          |
| <b>Parameters</b>         | None                                                                                                  |
| <b>Defaults</b>           | None                                                                                                  |
| <b>Command Mode</b>       | EXEC                                                                                                  |
| <b>Usage Information</b>  | The <code>no debug ip ospfv2</code> command stops displaying messages related to processing of OSPFv2 |
| <b>Example</b>            | <pre>debug ip ospfv2</pre>                                                                            |
| <b>Supported Releases</b> | OS10 legacy command.                                                                                  |

## default-information originate

Generates and distributes a default external route information to the OSPF routing domain.

|                           |                                                                                                           |
|---------------------------|-----------------------------------------------------------------------------------------------------------|
| <b>Syntax</b>             | <code>default-information originate [<i>always</i>]</code>                                                |
| <b>Parameters</b>         | <i>always</i> — (Optional) Always advertise the default route.                                            |
| <b>Defaults</b>           | Disabled                                                                                                  |
| <b>Command Mode</b>       | ROUTER-OSPF                                                                                               |
| <b>Usage Information</b>  | The <code>no</code> version of this command disables the distribution of default route.                   |
| <b>Example</b>            | <pre>OS10(config)# router ospf 10 OS10(config-router-ospf-10)# default-information originate always</pre> |
| <b>Supported Releases</b> | 10.3.0E or later                                                                                          |

## default-metric

Assigns a metric value to redistributed routes for the OSPF process.

|                           |                                                                                        |
|---------------------------|----------------------------------------------------------------------------------------|
| <b>Syntax</b>             | <code>default-metric number</code>                                                     |
| <b>Parameters</b>         | <i>number</i> — Enter a default-metric value, from 1 to 16777214.                      |
| <b>Default</b>            | Not configured                                                                         |
| <b>Command Mode</b>       | ROUTER-OSPF                                                                            |
| <b>Usage Information</b>  | The <code>no</code> version of this command disables the default-metric configuration. |
| <b>Example</b>            | <pre>OS10(conf-router-ospf-10)# default-metric 2000</pre>                              |
| <b>Supported Releases</b> | 10.2.0E or later                                                                       |

## fast-converge

Sets the minimum LSA origination and arrival times to zero (0) allowing more rapid route computation so convergence takes less time.

|                           |                                                                                                                                                                                                                                                                                                                                                                  |
|---------------------------|------------------------------------------------------------------------------------------------------------------------------------------------------------------------------------------------------------------------------------------------------------------------------------------------------------------------------------------------------------------|
| <b>Syntax</b>             | <code>fast-converge convergence-level</code>                                                                                                                                                                                                                                                                                                                     |
| <b>Parameters</b>         | <i>convergence-level</i> — Enter a desired convergence level value, from 1 to 4.                                                                                                                                                                                                                                                                                 |
| <b>Default</b>            | Not configured                                                                                                                                                                                                                                                                                                                                                   |
| <b>Command Mode</b>       | ROUTER-OSPF                                                                                                                                                                                                                                                                                                                                                      |
| <b>Usage Information</b>  | Convergence level 1 (optimal) meets most convergence requirements.<br> <b>NOTE:</b> Only select higher convergence levels following consultation with Dell EMC Technical Support.<br>The <code>no</code> version of this command disables the fast-convergence configuration. |
| <b>Example</b>            | <pre>OS10(conf-router-ospf-10)# fast-converge 3</pre>                                                                                                                                                                                                                                                                                                            |
| <b>Supported Releases</b> | 10.2.0E or later                                                                                                                                                                                                                                                                                                                                                 |

## graceful-restart

Enables Helper mode during a graceful or hitless restart.

|                           |                                                                                                      |
|---------------------------|------------------------------------------------------------------------------------------------------|
| <b>Syntax</b>             | <code>graceful-restart role helper-only</code>                                                       |
| <b>Parameters</b>         | None                                                                                                 |
| <b>Defaults</b>           | Disabled                                                                                             |
| <b>Command Mode</b>       | ROUTER-OSPF                                                                                          |
| <b>Usage Information</b>  | The <code>no</code> version of this command disables Helper mode.                                    |
| <b>Example</b>            | <pre>OS10(config)# router ospf 10 OS10(conf-router-ospf-10)# graceful-restart role helper-only</pre> |
| <b>Supported Releases</b> | 10.3.0E or later                                                                                     |



## ip ospf area

Attaches an interface to an OSPF area.

**Syntax** `ip ospf process-id area area-id`

**Parameters**

- `process-id` — Set an OSPF process ID for a specific OSPF process, from 1 to 65535.
- `area area-id` — Enter the OSPF area ID in dotted decimal A.B.C.D format or enter an area ID number, from 1 to 65535.

**Default** Not configured

**Command Mode** INTERFACE

**Usage Information** The `no` version of this command removes an interface from an OSPF area.

**Example**

```
OS10(conf-if-vl-10)# ip ospf 10 area 5
```

**Supported Releases** 10.2.0E or later

## ip ospf authentication-key

Configures a text authentication key to enable OSPF traffic on an interface.

**Syntax** `ip ospf authentication-key key`

**Parameters** `key` — Enter an eight-character string for the authentication key.

**Defaults** Not configured

**Command Mode** INTERFACE

**Usage Information** To exchange OSPF information, all neighboring routers in the same network must use the same authentication key. The `no` version of this command deletes the authentication key.

**Example**

```
OS10(config)# interface ethernet 1/1/1
OS10(conf-if-eth1/1/1)# ip ospf authentication-key sample
```

**Supported Releases** 10.3.0E or later

## ip ospf cost

Changes the cost associated with the OSPF traffic on an interface.

**Syntax** `ip ospf cost cost`

**Parameters** `cost` — Enter a value as the OSPF cost for the interface, from 1 to 65535.

**Default** Based on bandwidth reference

**Command Mode** INTERFACE

**Usage Information** If not configured, interface cost is based on the `auto-cost` command. This command configures OSPF over multiple vendors to ensure that all routers use the same cost. If you manually configure the cost, the calculated cost based on the reference bandwidth does not apply to the interface. The `no` version of this command removes the IP OSPF cost configuration.

**Example**

```
OS10(config)# interface vlan 10
OS10(conf-if-vl-1)# ip ospf cost 10
```

**Supported Releases** 10.2.0E or later

## ip ospf dead-interval

Sets the time interval since the last hello-packet was received from a router. After the interval elapses, the neighboring routers declare the router dead.

|                           |                                                                                                                                                     |
|---------------------------|-----------------------------------------------------------------------------------------------------------------------------------------------------|
| <b>Syntax</b>             | <code>ip ospf dead-interval seconds</code>                                                                                                          |
| <b>Parameters</b>         | <i>seconds</i> — Enter the dead interval value in seconds, from 1 to 65535.                                                                         |
| <b>Default</b>            | 40 seconds                                                                                                                                          |
| <b>Command Mode</b>       | INTERFACE                                                                                                                                           |
| <b>Usage Information</b>  | The dead interval is four times the default hello-interval by default. The <code>no</code> version of this command resets the value to the default. |
| <b>Example</b>            | <pre>OS10(conf-if-vl-10)# ip ospf dead-interval 10</pre>                                                                                            |
| <b>Supported Releases</b> | 10.2.0E or later                                                                                                                                    |

## ip ospf hello-interval

Sets the time interval between the hello packets sent on the interface.

|                           |                                                                                                                                                                                                                                                                                                                                                                                                                                         |
|---------------------------|-----------------------------------------------------------------------------------------------------------------------------------------------------------------------------------------------------------------------------------------------------------------------------------------------------------------------------------------------------------------------------------------------------------------------------------------|
| <b>Syntax</b>             | <code>ip ospf hello-interval seconds</code>                                                                                                                                                                                                                                                                                                                                                                                             |
| <b>Parameters</b>         | <i>seconds</i> — Enter the hello-interval value in seconds, from 1 to 65535.                                                                                                                                                                                                                                                                                                                                                            |
| <b>Default</b>            | 10 seconds                                                                                                                                                                                                                                                                                                                                                                                                                              |
| <b>Command Mode</b>       | INTERFACE                                                                                                                                                                                                                                                                                                                                                                                                                               |
| <b>Usage Information</b>  | All routers in a network must have the same hello time interval between the hello packets. The <code>no</code> version of the this command resets the value to the default.<br> <b>NOTE:</b> When you configure hello-interval for OSPF, the OSPF dead-interval value is implicitly set to a value four times greater than the hello-interval value. |
| <b>Example</b>            | <pre>OS10(conf-if-vl-10)# ip ospf hello-interval 30</pre>                                                                                                                                                                                                                                                                                                                                                                               |
| <b>Supported Releases</b> | 10.2.0E or later                                                                                                                                                                                                                                                                                                                                                                                                                        |

## ip ospf message-digest-key

Enables OSPF MD5 authentication and sends an OSPF message digest key on the interface.

|                           |                                                                                                                                                                                                                     |
|---------------------------|---------------------------------------------------------------------------------------------------------------------------------------------------------------------------------------------------------------------|
| <b>Syntax</b>             | <code>ip ospf message-digest-key keyid md5 key</code>                                                                                                                                                               |
| <b>Parameters</b>         | <ul style="list-style-type: none"><li>• <i>keyid</i> — Enter an MD5 key ID for the interface, from 1 to 255.</li><li>• <i>key</i> — Enter a character string as the password. A maximum of 16 characters.</li></ul> |
| <b>Defaults</b>           | Not configured                                                                                                                                                                                                      |
| <b>Command Mode</b>       | INTERFACE                                                                                                                                                                                                           |
| <b>Usage Information</b>  | All neighboring routers in the same network must use the same key value to exchange OSPF information. The <code>no</code> version of this command deletes the authentication key.                                   |
| <b>Example</b>            | <pre>OS10(config)# interface ethernet 1/1/1 OS10(conf-if-eth1/1/1)# ip ospf message-digest-key 2 md5 sample12345</pre>                                                                                              |
| <b>Supported Releases</b> | 10.3.0E or later                                                                                                                                                                                                    |

## ip ospf mtu-ignore

Disables MTU size detection on received Database Descriptor (DBD) packets when forming OSPFv3 adjacency.

**Syntax** `ip ospf mtu-ignore`

**Parameters** None

**Default** Not configured

**Command Mode** INTERFACE

**Usage Information** If the MTU size of the peer interface is greater than the local interface, switches that run OSPF do not form adjacencies with neighbors. Use this command to override this behavior and form adjacency.

If you try to disable a neighborhood using the `no ip ospf mtu-ignore` command after a neighborhood is formed using the `ip ospf mtu-ignore` command, the neighborhood still continues. To remove a neighborhood after it is formed using the `ip ospf mtu-ignore` command, use the `clear ipv6 ospf process` command.

### Example

```
OS10(conf-if-vl-10)# ip ospf mtu-ignore
```

**Supported Releases** 10.2.0E or later

## ip ospf network

Sets the network type for the interface.

**Syntax** `ip ospf network {point-to-point | broadcast}`

**Parameters**

- `point-to-point` — Sets the interface as part of a point-to-point network.
- `broadcast` — Sets the interface as part of a broadcast network.

**Default** Broadcast

**Command Mode** INTERFACE

**Usage Information** The `no` version of this command resets the value to the default.

### Example

```
OS10(conf-if-eth1/1/1)# ip ospf network broadcast
```

**Supported Releases** 10.2.0E or later

## ip ospf passive

Configures an interface as a passive interface and suppresses both receiving and sending routing updates to the passive interface.

**Syntax** `ip ospf passive`

**Parameters** None

**Default** Not configured

**Command Mode** INTERFACE

**Usage Information** You must configure the interface before setting the interface to Passive mode. The `no` version of this command disables the passive interface configuration.

 **NOTE:** As loopback interfaces are implicitly passive, the configuration to suppress sending and receiving of OSPF routing updates does not take effect on the loopback interfaces. However,

network information corresponding to these loopback interfaces is still announced in OSPF LSAs that are sent through other interfaces configured for OSPF.

**Example**

```
OS10(conf-if-eth1/1/6)# ip ospf passive
```

**Supported Releases**

10.2.0E or later

## ip ospf priority

Sets the priority of the interface to determine the DR for the OSPF network.

**Syntax** `ip ospf priority number`

**Parameters** *number* — Enter a router priority number, from 0 to 255.

**Default** 1

**Command Mode** INTERFACE

**Usage Information** When two routers attached to a network attempt to become the DR, the one with the higher router priority takes precedence. The `no` version of this command resets the value to the default.

**Example**

```
OS10(conf-if-eth1/1/6)# ip ospf priority 4
```

**Supported Releases**

10.2.0E or later

## ip ospf retransmit-interval

Sets the retransmission time between lost LSAs for adjacencies belonging to the interface.

**Syntax** `ip ospf retransmit-interval seconds`

**Parameters** *seconds* — Enter a value in seconds as the interval between retransmission, from 1 to 3600.

**Default** 5 seconds

**Command Mode** INTERFACE

**Usage Information** Set the time interval to a number large enough to avoid unnecessary retransmission. The `no` version of this command resets the value to the default.

**Example**

```
OS10(conf-if-eth1/1/6)# ip ospf retransmit-interval 20
```

**Supported Releases**

10.2.0E or later

## ip ospf transmit-delay

Sets the estimated time required to send a link state update packet on the interface.

**Syntax** `ip ospf transmit-delay seconds`

**Parameters** *seconds* — Set the time in seconds required to send a link-state update, from 1 to 3600.

**Default** 1 second

**Command Mode** INTERFACE

**Usage Information** When you set the `ip ospf transmit-delay` value, take into account the transmission and propagation delays for the interface. The `no` version of this command resets the value to the default.

**Example**

```
OS10 (conf-if-eth1/1/4) # ip ospf transmit-delay 5
```

**Supported Releases** 10.2.0E or later

## log-adjacency-changes

Enables logging of syslog messages regarding changes in the OSPF adjacency state.

**Syntax** `log-adjacency-changes`

**Parameters** None

**Default** Disabled

**Command Mode** ROUTER-OSPF

**Usage Information** The `no` version of this command resets the value to the default.

**Example**

```
OS10 (config) # router ospf 10
OS10 (conf-router-ospf-10) # log-adjacency-changes
```

**Supported Releases** 10.2.0E or later

## max-metric router-lsa

Configures OSPF to advertise a maximum metric on a router so that it is not desired as an intermediate hop from other routers.

**Syntax** `max-metric router-lsa`

**Parameters** None

**Default** Not configured

**Command Mode** ROUTER-OSPF

**Usage Information** Routers in the network do not prefer other routers as the next intermediate hop after they calculate the shortest path. The `no` version of this command disables the maximum metric advertisement configuration.

**Example**

```
OS10 (conf-router-ospf-10) # max-metric router-lsa
```

**Supported Releases** 10.2.0E or later

## maximum-paths

Enables forwarding of packets over multiple paths.

**Syntax** `maximum-paths number`

**Parameters** *number* —Enter the number of paths for OSPF, from 1 to 128.

**Default** 64

**Command Mode** ROUTER-OSPF

**Usage Information** The `no` version of this command resets the value to the default.

**Example**

```
OS10 (config) # router ospf 10
OS10 (conf-router-ospf-10) # maximum-paths 1
```

**Supported Releases** 10.2.0E or later

## redistribute

Redistributes information from another routing protocol or routing instance to the OSPFv2 process.

**Syntax** `redistribute {bgp as-number | imported-ospf-routes | connected | static} [route-map map-name]`

- Parameters**
- *as-number* — Enter an autonomous number to redistribute BGP routing information throughout the OSPF instance, from 1 to 4294967295.
  - *connected* — Enter the information from the connected active routes on interfaces to redistribute.
  - *static* — Enter the information from static routes on interfaces to redistribute.
  - *route-map name* — Enter the name of a configured route-map.

**Defaults** Not configured

**Command Mode** ROUTER-OSPF

**Usage Information** When an OSPF redistributes, the process does not completely remove from the BGP configuration. The `no` version of this command disables the redistribute configuration.

**Example**

```
OS10(config)# router ospf 10
OS10(conf-router-ospf-10)# redistribute bgp 4 route-map dell1
```

**Example (Connected)**

```
OS10(config)# router ospf 10
OS10(conf-router-ospf-10)# redistribute connected route-map dell2
```

**Supported Releases** 10.2.0E or later

## router-id

Configures a fixed router ID for the OSPF process.

**Syntax** `router-id ip-address`

**Parameters** *ip-address* — Enter the IP address of the router as the router ID.

**Default** Not configured

**Command Mode** ROUTER-OSPF

**Usage Information** Configure an arbitrary value in the IP address format for each router. Each router ID must be unique. Use the fixed router ID for the active OSPF router process. Changing the router ID brings down the existing OSPF adjacency. The new router ID becomes effective immediately. The `no` version of this command disables the router ID configuration.

**Example**

```
OS10(config)# router ospf 10
OS10(conf-router-ospf-10)# router-id 10.10.1.5
```

**Supported Releases** 10.2.0E or later

## router ospf

Enters Router OSPF mode and configures an OSPF instance.

**Syntax** `router ospf instance-number [vrf vrf-name]`

|                           |                                                                                                                                                                                                                                                                           |
|---------------------------|---------------------------------------------------------------------------------------------------------------------------------------------------------------------------------------------------------------------------------------------------------------------------|
| <b>Parameters</b>         | <ul style="list-style-type: none"> <li>• <i>instance-number</i>—Enter a router OSPF instance number, from 1 to 65535.</li> <li>• <i>vrf vrf-name</i> — Enter the keyword <i>vrf</i> followed by the name of the VRF to configure an OSPF instance in that VRF.</li> </ul> |
| <b>Default</b>            | Not configured                                                                                                                                                                                                                                                            |
| <b>Command Mode</b>       | CONFIGURATION                                                                                                                                                                                                                                                             |
| <b>Usage Information</b>  | Assign an IP address to an interface before using this command. The <i>no</i> version of this command deletes an OSPF instance.                                                                                                                                           |
| <b>Example</b>            | <pre>OS10(config)# router ospf 10 vrf vrf-test</pre>                                                                                                                                                                                                                      |
| <b>Supported Releases</b> | 10.2.0E or later                                                                                                                                                                                                                                                          |

## show ip ospf

Displays OSPF instance configuration information.

|                           |                                                                                                                                                                                                                                                                                                                                                                                                                                                                                                                    |
|---------------------------|--------------------------------------------------------------------------------------------------------------------------------------------------------------------------------------------------------------------------------------------------------------------------------------------------------------------------------------------------------------------------------------------------------------------------------------------------------------------------------------------------------------------|
| <b>Syntax</b>             | <code>show ip ospf [<i>instance-number</i>] [<i>vrf vrf-name</i>]</code>                                                                                                                                                                                                                                                                                                                                                                                                                                           |
| <b>Parameters</b>         | <ul style="list-style-type: none"> <li>• <i>instance-number</i> — View OSPF information for a specified instance number from, 1 to 65535.</li> <li>• <i>vrf vrf-name</i> — Enter the keyword <i>vrf</i> followed by the name of the VRF to display OSPF configuration information corresponding to that VRF.</li> </ul>                                                                                                                                                                                            |
| <b>Default</b>            | Not configured                                                                                                                                                                                                                                                                                                                                                                                                                                                                                                     |
| <b>Command Mode</b>       | EXEC                                                                                                                                                                                                                                                                                                                                                                                                                                                                                                               |
| <b>Usage Information</b>  | None                                                                                                                                                                                                                                                                                                                                                                                                                                                                                                               |
| <b>Example</b>            | <pre>OS10# show ip ospf 10 Routing Process ospf 10 with ID 111.2.1.1 Supports only single TOS (TOS0) routes It is an Autonomous System Boundary Router It is Flooding according to RFC 2328 Convergence Level 0 Min LSA origination 0 msec, Min LSA arrival 1000 msec Min LSA hold time 5000 msec, Max LSA wait time 5000 msec Number of area in this router is 1, normal 1 stub 0 nssa 0   Area (0.0.0.0)     Number of interface in this area is 3     SPF algorithm executed 38 times     Area ranges are</pre> |
| <b>Supported Releases</b> | 10.2.0E or later                                                                                                                                                                                                                                                                                                                                                                                                                                                                                                   |

## show ip ospf asbr

Displays all the ASBR visible to OSPF.

|                     |                                                                                                                                                                                                                                                                  |
|---------------------|------------------------------------------------------------------------------------------------------------------------------------------------------------------------------------------------------------------------------------------------------------------|
| <b>Syntax</b>       | <code>show ip ospf [<i>process-id</i>] [<i>vrf vrf-name</i>] asbr</code>                                                                                                                                                                                         |
| <b>Parameters</b>   | <ul style="list-style-type: none"> <li>• <i>process-id</i>—(Optional) Displays information based on the process ID.</li> <li>• <i>vrf vrf-name</i> — (Optional) Displays the ASBR router visible to the OSPF process configured in the specified VRF.</li> </ul> |
| <b>Default</b>      | Not configured                                                                                                                                                                                                                                                   |
| <b>Command Mode</b> | EXEC                                                                                                                                                                                                                                                             |

**Usage Information**

You can isolate problems with external routes. External OSPF routes are calculated by adding the LSA cost to the cost of reaching the ASBR router. If an external route does not have the correct cost, this command determines if the path to the originating router is correct. ASBRs that are not in directly connected areas display. You can determine if an ASBR is in a directly connected area by the flags. For ASBRs in a directly connected area, E flags are set.

**Example**

```
OS10# show ip ospf 10 asbr

RouterID Flags Cost Nexthop Interface Area
112.2.1.1 E/-/-/ 1 110.1.1.2 vlan3050 0.0.0.0
111.2.1.1 E/-/-/ 0 0.0.0.0 - -
```

**Supported Releases**

10.2.0E or later

## show ip ospf database

Displays all LSA information. You must enable OSPF to generate output.

**Syntax**

```
show ip ospf [process-id] [vrf vrf-name] database
```

**Parameters**

- *process-id* — (Optional) View LSA information for a specific OSPF process ID. If you do not enter a process ID, the command applies to all the configured OSPF processes.
- *vrf vrf-name* — (Optional) Enter the keyword *vrf* followed by the name of the VRF to display LSA information for the OSPF process corresponding to that VRF.

**Default**

Not configured

**Command Mode**

EXEC

**Usage Information**

- *Link ID* — Identifies the router ID.
- *ADV Router* — Identifies the advertising router's ID.
- *Age* — Displays the LS age.
- *Seq#* — Identifies the LS sequence number. This identifies old or duplicate LSAs.
- *Checksum* — Displays the Fletcher checksum of an LSA's complete contents.
- *Link count* — Displays the number of interfaces for that router.

**Example**

```
OS10# show ip ospf 10 database
OSPF Router with ID (111.2.1.1) (Process ID 10)

 Router (Area 0.0.0.0)

Link ID ADV Router Age Seq# Checksum Link
count
111.2.1.1 111.2.1.1 1281 0x8000000d 0x9bf2 3
111.111.111.1 111.111.111.1 1430 0x8000021a 0x515a 1
111.111.111.2 111.111.111.2 1430 0x8000021a 0x5552 1
112.2.1.1 112.2.1.1 1282 0x8000000b 0x0485 3
112.112.112.1 112.112.112.1 1305 0x80000250 0xbab2 1
112.112.112.2 112.112.112.2 1305 0x80000250 0xbeaa 1

 Network (Area 0.0.0.0)

Link ID ADV Router Age Seq# Checksum
110.1.1.2 112.2.1.1 1287 0x80000008 0xd2b1
111.1.1.1 111.2.1.1 1458 0x80000008 0x1b8f
111.2.1.1 111.2.1.1 1458 0x80000008 0x198f
112.1.1.1 112.2.1.1 1372 0x80000008 0x287c
112.2.1.1 112.2.1.1 1372 0x80000008 0x267c

 Summary Network (Area 0.0.0.0)
```

**Supported Releases**

10.2.0E or later



## show ip ospf database asbr-summary

Displays information about AS boundary LSAs.

|                          |                                                                                                                                                                                                                                                                                                                                                                                                                                                                                                                                                                                                                                                                                                                                                                                                                    |
|--------------------------|--------------------------------------------------------------------------------------------------------------------------------------------------------------------------------------------------------------------------------------------------------------------------------------------------------------------------------------------------------------------------------------------------------------------------------------------------------------------------------------------------------------------------------------------------------------------------------------------------------------------------------------------------------------------------------------------------------------------------------------------------------------------------------------------------------------------|
| <b>Syntax</b>            | <code>show ip ospf [<i>process-id</i>] database asbr-summary</code>                                                                                                                                                                                                                                                                                                                                                                                                                                                                                                                                                                                                                                                                                                                                                |
| <b>Parameters</b>        | <ul style="list-style-type: none"><li>• <i>process-id</i>—(Optional) Displays the AS boundary LSA information for a specified OSPF process ID. If you do not enter a process ID, this applies only to the first OSPF process.</li><li>• <i>vrf vrf-name</i> — (Optional) Displays the AS boundary LSA information for a OSPF process ID corresponding to the specified VRF.</li></ul>                                                                                                                                                                                                                                                                                                                                                                                                                              |
| <b>Default</b>           | Not configured                                                                                                                                                                                                                                                                                                                                                                                                                                                                                                                                                                                                                                                                                                                                                                                                     |
| <b>Command Mode</b>      | EXEC                                                                                                                                                                                                                                                                                                                                                                                                                                                                                                                                                                                                                                                                                                                                                                                                               |
| <b>Usage Information</b> | <ul style="list-style-type: none"><li>• <i>LS Age</i>—Displays the LS age.</li><li>• <i>Options</i>—Displays optional capabilities.</li><li>• <i>LS Type</i>—Displays the LS type.</li><li>• <i>Link State ID</i>—Identifies the router ID.</li><li>• <i>Advertising Router</i>—Identifies the advertising router's ID.</li><li>• <i>LS Seq Number</i>—Identifies the LS sequence number. This identifies old or duplicate LSAs.</li><li>• <i>Checksum</i>—Displays the Fletcher checksum of an LSA's complete contents.</li><li>• <i>Length</i>—Displays the LSA length in bytes.</li><li>• <i>Network Mask</i>—Identifies the network mask implemented on the area.</li><li>• <i>TOS</i>—Displays the ToS options. The only option available is zero.</li><li>• <i>Metric</i>—Displays the LSA metric.</li></ul> |

### Example

```
OS10# show ip ospf 10 database asbr-summary

 OSPF Router with ID (1.1.1.1) (Process ID 100)

 Summary Asbr (Area 0.0.0.1)

 LS age: 32
 Options: (No TOS-Capability, No DC)
 LS type: Summary Asbr
 Link State ID: 8.1.1.1
 Advertising Router: 2.2.2.2
 LS Seq Number: 0x80000001
 Checksum: 0xB595
 Length: 28
 Network Mask: /0
 TOS: 0 Metric: 0
```

**Supported Releases** 10.2.0E or later

## show ip ospf database external

Displays information about the AS external Type 5 LSAs.

|                          |                                                                                                                                                                                                                                                                                                                                                                                                     |
|--------------------------|-----------------------------------------------------------------------------------------------------------------------------------------------------------------------------------------------------------------------------------------------------------------------------------------------------------------------------------------------------------------------------------------------------|
| <b>Syntax</b>            | <code>show ip ospf [<i>process-id</i>] [<i>vrf vrf-name</i>] database external</code>                                                                                                                                                                                                                                                                                                               |
| <b>Parameters</b>        | <ul style="list-style-type: none"><li>• <i>process-id</i>—(Optional) Displays AS external Type 5 LSA information for a specified OSPF process ID. If you do not enter a process ID, this command applies only to the first OSPF process.</li><li>• <i>vrf vrf-name</i> — (Optional) Displays AS external (Type 5) LSA information for a specified OSPF Process ID corresponding to a VRF.</li></ul> |
| <b>Default</b>           | Not configured                                                                                                                                                                                                                                                                                                                                                                                      |
| <b>Command Mode</b>      | EXEC                                                                                                                                                                                                                                                                                                                                                                                                |
| <b>Usage Information</b> | <ul style="list-style-type: none"><li>• <i>LS Age</i> — Displays the LS age.</li></ul>                                                                                                                                                                                                                                                                                                              |

- Options — Displays the optional capabilities available on the router.
- LS Type — Displays the LS type.
- Link State ID — Identifies the router ID.
- Advertising Router — Identifies the advertising router's ID.
- LS Seq Number — Identifies the LS sequence number. This identifies old or duplicate LSAs.
- Checksum — Displays the Fletcher checksum of an LSA's complete contents.
- Length — Displays the LSA length in bytes.
- Network Mask — Identifies the network mask implemented on the area.
- TOS — Displays the ToS options. The only option available is zero.
- Metric — Displays the LSA metric.

### Example

```
OS10# show ip ospf 10 database external

OSPF Router with ID (111.2.1.1) (Process ID 10)

 Type-5 AS External

LS age: 1424
Options: (No TOS-capability, No DC, E)
LS type: Type-5 AS External
Link State ID: 110.1.1.0
Advertising Router: 111.2.1.1
LS Seq Number: 0x80000009
Checksum: 0xc69a
Length: 36
Network Mask: /24
 Metric Type: 2
 TOS: 0
 Metric: 20
 Forward Address: 110.1.1.1
 External Route Tag: 0
```

**Supported Releases** 10.2.0E or later

## show ip ospf database network

Displays information about network Type 2 LSA information.

**Syntax** `show ip ospf [process-id] [vrf vrf-name] database network`

**Parameters**

- *process-id* — (Optional) Displays network Type2 LSA information for a specified OSPF process ID. If you do not enter a process ID, this command applies only to the first OSPF process.
- *vrf vrf-name* — (Optional) Displays network Type2 LSA information for a specified OSPF process ID corresponding to a VRF.

**Default** Not configured

**Command Mode** EXEC

**Usage Information**

- LS Age—Displays the LS age.
- Options—Displays optional capabilities.
- LS Type—Displays the LS type.
- Link State ID—Identifies the router ID.
- Advertising Router—Identifies the advertising router's ID.
- LS Seq Number—Identifies the LS sequence number. This identifies old or duplicate LSAs.
- Checksum—Displays the Fletcher checksum of an LSA's complete contents.
- Length—Displays the LSA length in bytes.
- Network Mask—Identifies the network mask implemented on the area.
- TOS—Displays the ToS options. The only option available is zero..
- Metric—Displays the LSA metric.

## Example

```
OS10# show ip ospf 10 database network
OSPF Router with ID (111.2.1.1) (Process ID 10)

 Network (Area 0.0.0.0)

LS age: 1356
Options: (No TOS-capability, No DC, E)
LS type: Network
Link State ID: 110.1.1.2
Advertising Router: 112.2.1.1
LS Seq Number: 0x80000008
Checksum: 0xd2b1
Length: 32
Network Mask: /24
 Attached Router: 111.2.1.1
 Attached Router: 112.2.1.1
```

**Supported Releases** 10.2.0E or later

## show ip ospf database nssa external

Displays information about the NSSA-External Type 7 LSA.

**Syntax** `show ip ospf [process-id] [vrf vrf-name] database nssa external`

**Parameters**

- *process-id* — (Optional) Displays NSSA-External Type7 LSA information for a specified OSPF process ID. If you do not enter a process ID, this command applies only to the first OSPF process.
- *vrf vrf-name* — (Optional) Displays NSSA-External Type7 LSA information for a specified OSPF process ID corresponding to a VRF.

**Default** Not configured

**Command Mode** EXEC

**Usage Information**

- **LS Age** — Displays the LS age.
- **Options** — Displays the optional capabilities available on the router.
- **LS Type** — Displays the LS type.
- **Link State ID** — Identifies the router ID.
- **Advertising Router** — Identifies the advertising router's ID.
- **LS Seq Number** — Identifies the LS sequence number. This identifies old or duplicate LSAs.
- **Checksum** — Displays the Fletcher checksum of an LSA's complete contents.
- **Length** — Displays the LSA length in bytes.
- **Network Mask**—Identifies the network mask implemented on the area.
- **TOS**—Displays the ToS options. The only option available is zero.
- **Metric**—Displays the LSA metric.

## Example

```
OS10# show ip ospf database nssa external

 OSPF Router with ID (2.2.2.2) (Process ID 100)

 NSSA External (Area 0.0.0.1)

LS age: 98
Options: (No TOS-Capability, No DC, No Type 7/5 translation)
LS type: NSSA External
Link State ID: 0.0.0.0
Advertising Router: 1.1.1.1
LS Seq Number: 0x80000001
Checksum: 0x430C
Length: 36
Network Mask: /0
 Metric Type: 1
```

```

TOS: 0
Metric: 16777215
Forward Address: 0.0.0.0
External Route Tag: 0

LS age: 70
Options: (No TOS-Capability, No DC, No Type 7/5 translation)
LS type: NSSA External
Link State ID: 0.0.0.0
Advertising Router: 2.2.2.2
LS Seq Number: 0x80000001
Checksum: 0x2526
Length: 36
Network Mask: /0
 Metric Type: 1
 TOS: 0
 Metric: 0
 Forward Address: 0.0.0.0
 External Route Tag: 0

LS age: 65
Options: (No TOS-Capability, No DC, No Type 7/5 translation)
LS type: NSSA External
Link State ID: 12.1.1.0
Advertising Router: 2.2.2.2
LS Seq Number: 0x80000001
Checksum: 0xBDEA
Length: 36
Network Mask: /24
 Metric Type: 2
 TOS: 0
 Metric: 20
 Forward Address: 0.0.0.0
 External Route Tag: 0

LS age: 65
Options: (No TOS-Capability, No DC, No Type 7/5 translation)
LS type: NSSA External
Link State ID: 13.1.1.0
Advertising Router: 2.2.2.2
LS Seq Number: 0x80000001
Checksum: 0xB0F6
Length: 36
Network Mask: /24
 Metric Type: 2
 TOS: 0
 Metric: 20
 Forward Address: 0.0.0.0
 External Route Tag: 0

LS age: 65
Options: (No TOS-Capability, No DC, No Type 7/5 translation)
LS type: NSSA External
Link State ID: 14.1.1.0
Advertising Router: 2.2.2.2
LS Seq Number: 0x80000001
Checksum: 0xA303
Length: 36
Network Mask: /24
 Metric Type: 2
 TOS: 0
 Metric: 20
 Forward Address: 0.0.0.0
 External Route Tag: 0

```

**Supported  
Releases**

10.2.0E or later

## show ip ospf database opaque-area

Displays information about the opaque-area Type 10 LSA.

|                          |                                                                                                                                                                                                                                                                                                                                                                                                                                                                                                                                                                                                                                                                                                                                                                                                                                                   |
|--------------------------|---------------------------------------------------------------------------------------------------------------------------------------------------------------------------------------------------------------------------------------------------------------------------------------------------------------------------------------------------------------------------------------------------------------------------------------------------------------------------------------------------------------------------------------------------------------------------------------------------------------------------------------------------------------------------------------------------------------------------------------------------------------------------------------------------------------------------------------------------|
| <b>Syntax</b>            | <code>show ip ospf [<i>process-id</i>] [<i>vrf vrf-name</i>] database opaque-area</code>                                                                                                                                                                                                                                                                                                                                                                                                                                                                                                                                                                                                                                                                                                                                                          |
| <b>Parameters</b>        | <ul style="list-style-type: none"><li>• <i>process-id</i> — (Optional) Displays the opaque-area Type 10 information for an OSPF process ID. If you do not enter a process ID, this command applies only to the first OSPF process.</li><li>• <i>vrf vrf-name</i> — (Optional) Displays the opaque-area Type 10 information for an OSPF process ID corresponding to a VRF.</li></ul>                                                                                                                                                                                                                                                                                                                                                                                                                                                               |
| <b>Default</b>           | Not configured                                                                                                                                                                                                                                                                                                                                                                                                                                                                                                                                                                                                                                                                                                                                                                                                                                    |
| <b>Command Mode</b>      | EXEC                                                                                                                                                                                                                                                                                                                                                                                                                                                                                                                                                                                                                                                                                                                                                                                                                                              |
| <b>Usage Information</b> | <ul style="list-style-type: none"><li>• <i>LS Age</i> — Displays the LS age.</li><li>• <i>Options</i> — Displays the optional capabilities available on the router.</li><li>• <i>LS Type</i> — Displays the LS type.</li><li>• <i>Link State ID</i> — Identifies the router ID.</li><li>• <i>Advertising Router</i> — Identifies the advertising router's ID.</li><li>• <i>LS Seq Number</i> — Identifies the LS sequence number. This identifies old or duplicate LSAs.</li><li>• <i>Checksum</i> — Displays the Fletcher checksum of an LSA's complete contents.</li><li>• <i>Length</i> — Displays the LSA length in bytes.</li><li>• <i>Opaque Type</i> — Identifies the Opaque type field, the first 8 bits of the LS ID.</li><li>• <i>Opaque ID</i> — Identifies the Opaque type-specific ID, the remaining 24 bits of the LS ID.</li></ul> |

### Example

```
OS10# show ip ospf database opaque-area
 OSPF Router with ID (1.1.1.1) (Process ID 100)

 Type-10 Area Local Opaque (Area 0.0.0.1)

LS age: 3600
Options: (No TOS-Capability, No DC)
LS type: Type-10 Area Local Opaque
Link State ID: 8.1.1.2
Advertising Router: 2.2.2.2
LS Seq Number: 0x80000008
Checksum: 0x83B8
Length: 28
Opaque Type: 8
Opaque ID: 65794
!!
!
```

|                           |                  |
|---------------------------|------------------|
| <b>Supported Releases</b> | 10.2.0E or later |
|---------------------------|------------------|

## show ip ospf database opaque-as

Displays information about the opaque-as Type 11 LSAs.

|                          |                                                                                                                                                                                                                                                                                           |
|--------------------------|-------------------------------------------------------------------------------------------------------------------------------------------------------------------------------------------------------------------------------------------------------------------------------------------|
| <b>Syntax</b>            | <code>show ip ospf [<i>process-id</i>] opaque-as</code>                                                                                                                                                                                                                                   |
| <b>Parameters</b>        | <i>process-id</i> — (Optional) Displays opaque-as Type 11 LSA information for a specified OSPF process ID. If you do not enter a process ID, this command applies only to the first OSPF process.                                                                                         |
| <b>Default</b>           | Not configured                                                                                                                                                                                                                                                                            |
| <b>Command Mode</b>      | EXEC                                                                                                                                                                                                                                                                                      |
| <b>Usage Information</b> | <ul style="list-style-type: none"><li>• <i>LS Age</i> — Displays the LS age.</li><li>• <i>Options</i> — Displays the optional capabilities available on the router.</li><li>• <i>LS Type</i> — Displays the LS type.</li><li>• <i>Link State ID</i> — Identifies the router ID.</li></ul> |

- Advertising Router — Identifies the advertising router's ID.
- LS Seq Number — Identifies the LS sequence number. This identifies old or duplicate LSAs.
- Checksum — Displays the Fletcher checksum of an LSA's complete contents.
- Length — Displays the LSA length in bytes.
- Opaque Type — Identifies the Opaque type field, the first 8 bits of the LS ID.
- Opaque ID — Identifies the Opaque type-specific ID, the remaining 24 bits of the LS ID.

### Example

```
OS10# show ip ospf 100 database opaque-as
 OSPF Router with ID (1.1.1.1) (Process ID 100)

 Type-11 AS Opaque

LS age: 3600
Options: (No TOS-Capability, No DC)
LS type: Type-11 AS Opaque
Link State ID: 8.1.1.3
Advertising Router: 2.2.2.2
LS Seq Number: 0x8000000D
Checksum: 0x61D3
Length: 36
Opaque Type: 8
Opaque ID: 65795
```

### Supported Releases

10.2.0E or later

## show ip ospf database opaque-link

Displays information about the opaque-link Type 9 LSA.

### Syntax

```
show ip ospf [process-id] [vrf vrf-name] database opaque-link
```

### Parameters

- *process-id* — (Optional) Displays the opaque-link Type 9 LSA information for an OSPF process ID. If you do not enter a process ID, this command applies only to the first OSPF process.
- *vrf vrf-name* — (Optional) Displays the opaque-link Type 9 LSA information for an OSPF process ID corresponding to a VRF.

### Default

Not configured

### Command Mode

EXEC

### Usage Information

- LS Age — Displays the LS age.
- Options — Displays the optional capabilities available on the router.
- LS Type — Displays the LS type.
- Link State ID — Identifies the router ID.
- Advertising Router — Identifies the advertising router's ID.
- LS Seq Number — Identifies the LS sequence number. This identifies old or duplicate LSAs.
- Checksum — Displays the Fletcher checksum of an LSA's complete contents.
- Length — Displays the LSA length in bytes.
- Opaque Type — Identifies the Opaque type field, the first 8 bits of the LS ID.
- Opaque ID — Identifies the Opaque type-specific ID, the remaining 24 bits of the LS ID.

### Example

```
OS10# show ip ospf 100 database opaque-link
 OSPF Router with ID (1.1.1.1) (Process ID 100)

 Type-9 Link Local Opaque (Area 0.0.0.1)

LS age: 3600
Options: (No TOS-Capability, No DC)
LS type: Type-9 Link Local Opaque
Link State ID: 8.1.1.1
```

```
Advertising Router: 2.2.2.2
LS Seq Number: 0x80000007
Checksum: 0x9DA1
Length: 28
Opaque Type: 8
Opaque ID: 65793
```

**Supported Releases** 10.2.0E or later

## show ip ospf database router

Displays information about the router Type 1 LSA.

**Syntax** `show ip ospf process-id [vrf vrf-name] database router`

**Parameters**

- *process-id* — (Optional) Displays the router Type 1 LSA for an OSPF process ID. If you do not enter a process ID, this command applies only to the first OSPF process.
- *vrf vrf-name* — (Optional) Displays the router Type 1 LSA for an OSPF process ID corresponding to a VRF.

**Default** Not configured

**Command Mode** EXEC

**Usage** Output:

**Information**

- *LS age*—Displays the LS age.
- *Options*—Displays optional capabilities.
- *LS Type*—Displays the LS type.
- *Link State ID*—Identifies the router ID.
- *Advertising Router*—Identifies the advertising router's ID.
- *LS Seq Number*—Identifies the LS sequence number. This identifies old or duplicate LSAs.
- *Checksum*—Displays the Fletcher checksum of an LSA's complete contents.
- *Length*—Displays the LSA length in bytes.
- *TOS*—Displays the ToS options. The only option available is zero.
- *Metric*—Displays the LSA metric.

### Example

```
OS10# show ip ospf 10 database router

 OSPF Router with ID (111.2.1.1) (Process ID 10)

 Router (Area 0.0.0.0)

LS age: 1419
Options: (No TOS-capability, No DC, E)
LS type: Router
Link State ID: 111.2.1.1
Advertising Router: 111.2.1.1
LS Seq Number: 0x8000000d
Checksum: 0x9bf2
Length: 60
AS Boundary Router
 Number of Links: 3

 Link connected to: a Transit Network
 (Link ID) Designated Router address: 110.1.1.2
 (Link Data) Router Interface address: 110.1.1.1
 Number of TOS metric: 0
 TOS 0 Metric: 1

 Link connected to: a Transit Network
 (Link ID) Designated Router address: 111.1.1.1
 (Link Data) Router Interface address: 111.1.1.1
 Number of TOS metric: 0
```

```

TOS 0 Metric: 1

Link connected to: a Transit Network
(Link ID) Designated Router address: 111.2.1.1
(Link Data) Router Interface address: 111.2.1.1
Number of TOS metric: 0
TOS 0 Metric: 1

```

**Supported Releases** 10.2.0E or later

## show ip ospf database summary

Displays the network summary Type 3 LSA routing information.

**Syntax** `show ip ospf [process-id] [vrf vrf-name] database summary`

**Parameters**

- *process-id*—(Optional) Displays LSA information for a specific OSPF process ID. If you do not enter a process ID, this command applies only to the first OSPF process.
- *vrf vrf-name* — (Optional) Displays LSA information for a specified OSPF process ID corresponding to a VRF.

**Default** Not configured

**Command Mode** EXEC

**Usage Information**

- *LS Age*—Displays the LS age.
- *Options*—Displays the optional capabilities available on the router.
- *LS Type*—Displays the LS type.
- *Link State ID*—Identifies the router ID.
- *Advertising Router*—Identifies the advertising router's ID.
- *LS Seq Number*—Identifies the LS sequence number. This identifies old or duplicate LSAs.
- *Checksum*—Displays the Fletcher checksum of an LSA's complete contents.
- *Length*—Displays the LSA length in bytes.
- *Network Mask*—Identifies the network mask implemented on the area.
- *TOS*—Displays the ToS options. The only option available is zero.
- *Metric*—Displays the LSA metric.

### Example

```

OS10# show ip ospf 10 database summary
 OSPF Router with ID (111.2.1.1) (Process ID 10)

 Summary Network (Area 0.0.0.0)

LS age: 623
Options: (No TOS-capability, No DC)
C: Summary Network
Link State ID: 115.1.1.0
Advertising Router: 111.111.111.1
LS Seq Number: 0x800001e8
Checksum: 0x4a67
Length: 28
Network Mask: /24
 TOS: 0 Metric: 0

```

**Supported Releases** 10.2.0E or later



## show ip ospf interface

Displays the configured OSPF interfaces. You must enable OSPF to display output.

**Syntax** `show ip ospf interface [process-id] [vrf vrf-name] interface` or `show ip ospf [process-id] [vrf vrf-name] interface [interface]`

- Parameters**
- *process-id* — (Optional) Displays information for an OSPF process ID. If you do not enter a process ID, this command applies only to the first OSPF process.
  - *vrf vrf-name* — (Optional) Displays information for an OSPF instance corresponding to a VRF.
  - *interface* — (Optional) Enter the interface information:
    - *ethernet* — Enter the Ethernet interface information, from 1 to 48.
    - *port channel* — Enter the port-channel interface number, from 1 to 128.
    - *vlan* — Enter the VLAN interface number, from 1 to 4093.

**Default** Not configured

**Command Mode** EXEC

**Example**

```
OS10# show ip ospf 10 interface
ethernet1/1/1 is up, line protocol is up
 Internet Address 110.1.1.1/24, Area 0.0.0.0
 Process ID 10, Router ID 1.1.1.1, Network Type broadcast, Cost: 10
 Transmit Delay is 1 sec, State WAIT, Priority 1
 BFD enabled(Interface level) Interval 300 Min_rx 300 Multiplier 3 Role
Active
 Designated Router (ID) , Interface address 0.0.0.0
 Backup Designated router (ID) , Interface address 0.0.0.0
 Timer intervals configured, Hello 10, Dead 40, Wait 40, Retransmit 5
 Neighbor Count is 0, Adjacent neighbor count is 0
```

**Supported Releases** 10.2.0E or later

## show ip ospf routes

Displays OSPF routes received from neighbors along with parameters such as cost, next-hop, area, interface, and type of route.

**Syntax** `show ip ospf [process-id] [vrf vrf-name] routes [prefix IP-prefix]`

- Parameters**
- *process-id* — (Optional) Enter OSPFv2 process ID to view information specific to the ID.
  - *vrf vrf-name* — (Optional) Enter the keyword vrf followed by the name of the VRF to display the routes calculated by OSPF in the configured VRF.
  - *IP-prefix* — (Optional) Specify an IP address to view information specific to the IP address.

**Default** None

**Command Mode** EXEC

**Usage Information** Displays the cost metric for each neighbor and interfaces.

**Example**

```
OS10# show ip ospf 10 routes
Prefix Cost Nexthop Interface Area Type
110.1.1.0 1 0.0.0.0 vlan3050 0.0.0.0 intra-area
111.1.1.0 1 0.0.0.0 vlan3051 0.0.0.0 intra-area
111.2.1.0 1 0.0.0.0 vlan3053 0.0.0.0 intra-area
```

**Supported Releases** 10.2.0E or later

## show ip ospf statistics

Displays OSPF traffic statistics.

- Syntax**
- `show ip ospf [instance-number] [vrf vrf-name] statistics [interface interface]`
- Parameters**
- `instance-number` — (Optional) Enter an OSPF instance number, from 1 to 65535.
  - `vrf vrf-name` — (Optional) Enter the keyword `vrf` followed by the name of the VRF to display OSPF traffic statistics corresponding to that VRF.
  - `interface interface` — (Optional) Enter the interface information:
    - `ethernet node/slot/port[:subport]` — Enter an Ethernet port interface.
    - `port-channel number` — Enter the port-channel interface number, from 1 to 128.
    - `vlan vlan-id` — Enter the VLAN ID number, from 1 to 4093.
- Default** Not configured
- Command Mode** EXEC
- Usage Information** This command displays OSPFv2 traffic statistics for a specified instance or interface, or for all OSPFv2 instances and interfaces.
- Example**

```
OS10# show ip ospf 10 statistics
Interface vlan3050
 Receive Statistics
 rx-invalid 0 rx-invalid-bytes 0
 rx-hello 0 rx-hello-bytes 0
 rx-db-des 0 rx-db-des-bytes 0
 rx-ls-req 0 rx-ls-req-bytes 0
 rx-ls-upd 0 rx-ls-upd-bytes 0
 rx-ls-ack 0 rx-ls-ack-bytes 0
 Transmit Statistics
 tx-failed 0 tx-failed-bytes 0
 tx-hello 0 tx-hello-bytes 0
 tx-db-des 0 tx-db-des-bytes 0
 tx-ls-req 0 tx-ls-req-bytes 0
 tx-ls-upd 0 tx-ls-upd-bytes 0
 tx-ls-ack 0 tx-ls-ack-bytes 0
 Error packets (Receive statistics)
 bad-src 0 dupe-id 0 hello-err
 mtu-mismatch 0 nbr-ignored 0 wrong-proto
 resource-err 0 bad-lsa-len 0 lsa-bad-type
 lsa-bad-len 0 lsa-bad-cksum 0 auth-fail
 netmask-mismatch 0 hello-tmr-mismatch 0 dead-ivl-mismatch
 options-mismatch 0 nbr-admin-down 0 own-hello-drop
 self-orig 0 wrong-length 0 checksum-error
 version-mismatch 0 area-mismatch 0
```

**Supported Releases** 10.2.0E or later

## show ip ospf topology

Displays routers that directly connect to OSPF areas.

**Syntax** `show ip ospf [process-id] [vrf vrf-name] topology`

- Parameters**
- *process-id* — (Optional) Displays OSPF process information. If you do not enter a process ID, this applies only to the first OSPF process.
  - *vrf vrf-name* — (Optional) Displays the routers in the directly connected OSPF areas in the configured VRF.

**Default** Not configured

**Command Mode** EXEC

**Usage Information** The “E” flag output indicates the router listed is an ASBR. The “B” flag indicates that the router listed is an ABR. If the Flag field shows both E and B, it indicates that the listed router is both an ASBR and an ABR.

**Example**

```
OS10# show ip ospf 10 topology

Router ID Flags Cost Nexthop Interface Area
111.111.111.1 -/B/-/ 1 111.1.1.2 V1 3051 0
111.111.111.2 -/B/-/ 1 111.2.1.2 V1 3053 0
112.2.1.1 E/-/-/ 1 110.1.1.2 V1 3050 0
112.112.112.1 -/B/-/ 2 110.1.1.2 V1 3050 0
112.112.112.2 -/B/-/ 2 110.1.1.2 V1 3050 0
```

**Supported Releases** 10.2.0E or later

## summary-address

Configures a summary address for an ASBR to advertise one external route as an aggregate for all redistributed routes covered by a specified address range.

**Syntax** `summary-address ip-address/mask [not-advertise | tag tag-value]`

- Parameters**
- *ip-address/mask*—Enter the IP address to summarize along with the mask.
  - *not-advertise*—(Optional) Suppresses IP addresses that do not match the network prefix/mask.
  - *tag-value*—(Optional) Enter a value to match the routes redistributed through a route map, from 1 to 65535.

**Default)** Not configured

**Command Mode** ROUTER-OSPF

**Usage Information** The no version of this command disables the summary address.

**Example**

```
OS10(config)# router ospf 100
OS10(config-router-ospf-100)# summary-address 10.0.0.0/8 not-advertise
```

**Supported Releases** 10.3.0E or later

## timers lsa arrival

Configures the LSA acceptance intervals.

**Syntax** `timers lsa arrival arrival-time`

**Parameters** *arrival-time* — Set the interval between receiving the LSA in milliseconds, from 0 to 600,000.

**Default** 1000 milliseconds

**Command Mode** ROUTER-OSPF

**Usage Information** Setting the LSA arrival time between receiving the LSA repeatedly ensures that the system gets enough time to accept the LSA. The no version of this command resets the value to the default.

## Example

```
OS10(config)# router ospf 10
OS10(conf-router-ospf-10)# timers lsa arrival 2000
```

## Supported Releases

10.2.0E or later

## timers spf

Enables shortest path first (SPF) throttling to delay an SPF calculation when a topology change occurs.

### Syntax

```
timers spf [start-time [hold-time [max-wait]]]
```

### Parameters

- *start-time* — Sets the initial SPF delay in milliseconds, from 1 to 600000; default 1000.
- *hold-time* — Sets the additional hold time between two SPF calculations in milliseconds, from 1 to 600000; default 10000.
- *max-wait* — Sets the maximum wait time between two SPF calculations in milliseconds, from 1 to 600000; default 10000.

### Default

- *start-time* — 1000 milliseconds
- *hold-time* — 10000 milliseconds
- *max-wait* — 10000 milliseconds

### Command Mode

ROUTER-OSPF

### Usage

By default, SPF timers are disabled in an OSPF instance.

### Information

Use SPF throttling to delay SPF calculations during periods of network instability. In an OSPF network, a topology change event triggers an SPF calculation after a start time. When the start timer finishes, a hold time may delay the next SPF calculation for an additional time. When the hold timer is running:

- Each time a topology change occurs, the SPF calculation delays for double the configured hold time up to maximum wait time.
- If no topology change occurs, an SPF calculation performs and the hold timer is reset to its configured value.

If you do not specify a start-time, hold-time, or max-wait value, the default values are used. The `no` version of this command removes the configured SPF timers and disables SPF throttling in an OSPF instance.

## Example

```
OS10(config)# router ospf 100
OS10(config-router-ospf-100)# timers spf 1200 2300 3400
OS10(config-router-ospf-100)# do show ip ospf

Routing Process ospf 100 with ID 12.1.1.1
Supports only single TOS (TOS0) routes
It is Flooding according to RFC 2328
SPF schedule delay 1200 msec, Hold time between two SPF's 2300 msec
Convergence Level 0
Min LSA origination 0 msec, Min LSA arrival 1000 msec
Min LSA hold time 5000 msec, Max LSA wait time 5000 msec
Number of area in this router is 1, normal 1 stub 0 nssa 0
Area (0.0.0.1)
Number of interface in this area is 1
SPF algorithm executed 1 times
```

## Supported Releases

10.4.0E(R1) or later

## timers throttle lsa all

Configures the LSA transmit intervals.

### Syntax

```
timers lsa all [start-interval | hold-interval | max-interval]
```

|                           |                                                                                                                                                                                                                                                                                                                                                                                                                                                                                                                                                   |
|---------------------------|---------------------------------------------------------------------------------------------------------------------------------------------------------------------------------------------------------------------------------------------------------------------------------------------------------------------------------------------------------------------------------------------------------------------------------------------------------------------------------------------------------------------------------------------------|
| <b>Parameters</b>         | <ul style="list-style-type: none"> <li>• <i>start-interval</i> — Sets the minimum interval between initial sending and re-sending the same LSA in milliseconds, from 0 to 600,000.</li> <li>• <i>hold-interval</i> — Sets the next interval to send the same LSA in milliseconds. This is the time between sending the same LSA after the start-interval is attempted, from 1 to 600,000.</li> <li>• <i>max-interval</i> — Sets the maximum amount of time the system waits before sending the LSA in milliseconds, from 1 to 600,000.</li> </ul> |
| <b>Default</b>            | <ul style="list-style-type: none"> <li>• start-interval — 0 milliseconds</li> <li>• hold-interval — 5000 milliseconds</li> <li>• max-interval — 5000 milliseconds</li> </ul>                                                                                                                                                                                                                                                                                                                                                                      |
| <b>Command Mode</b>       | ROUTER-OSPF                                                                                                                                                                                                                                                                                                                                                                                                                                                                                                                                       |
| <b>Usage Information</b>  | The no version of this command removes the LSA transmit timer.                                                                                                                                                                                                                                                                                                                                                                                                                                                                                    |
| <b>Example</b>            | <pre>OS10(config)# router ospf 10 OS10(conf-router-ospf-10)# timers throttle lsa all 100 300 1000</pre>                                                                                                                                                                                                                                                                                                                                                                                                                                           |
| <b>Supported Releases</b> | 10.2.0E or later                                                                                                                                                                                                                                                                                                                                                                                                                                                                                                                                  |

## OSPFv3

OSPFv3 is an IPv6 link-state routing protocol that supports IPv6 unicast address families (AFs). OSPFv3 is disabled by default. You must configure at least one interface, either physical or Loopback. The OSPF process automatically starts when OSPFv3 is enabled for one or more interfaces. Any area besides *area 0* can have any number ID assigned to it.

### Enable OSPFv3

1. Enable OSPFv3 globally and configure an OSPFv3 instance in CONFIGURATION mode.

```
router ospfv3 instance-number
```

2. Enter the interface information to configure the interface for OSPFv3 in INTERFACE mode.

```
interface ethernet node/slot/port[:subport]
```

3. Enable the interface in INTERFACE mode.

```
no shutdown
```

4. Disable the default switchport configuration and remove it from an interface or a LAG port in INTERFACE mode.

```
no switchport
```

5. Enable the OSPFv3 on an interface in INTERFACE mode.

```
ipv6 ospfv3 process-id area area-id
```

- *process-id* — Enter the OSPFv3 process ID for a specific OSPFv3 process, from 1 to 65535.
- *area-id* — Enter the OSPF area ID as an IP address in A.B.C.D format or number, from 1 to 65535.

### Enable OSPFv3

```
OS10(config)# router ospfv3 100
OS10(config-router-ospfv3-100)# exit
OS10(config)# interface ethernet 1/1/1
OS10(conf-if-eth1/1/1)# no shutdown
```

```
OS10(conf-if-eth1/1/1)# no switchport
OS10(conf-if-eth1/1/1)# ipv6 ospfv3 300 area 0.0.0.0
```

## Enable OSPFv3 in a non-default VRF instance

1. Create the non-default VRF instance in which you want to enable OSPFv3:

```
ip vrf vrf-name
CONFIGURATION Mode
```

2. Enable OSPFv3 in the non-default VRF instance that you created earlier and configure an OSPFv3 instance in VRF CONFIGURATION mode.

```
router ospfv3 instance-number vrf vrf-name
```

3. Enter the interface information to configure the interface for OSPFv3 in INTERFACE mode.

```
interface ethernet node/slot/port[:subport]
```

4. Enable the interface in INTERFACE mode.

```
no shutdown
```

5. Disable the default switchport configuration and remove it from an interface or a LAG port in INTERFACE mode.

```
no switchport
```

6. Associate the interface with the non-default VRF instance that you created earlier.

```
ip vrf forwarding vrf-name
```

7. Enable the OSPFv3 on an interface.

```
ipv6 ospfv3 process-id area area-id
```

- *process-id* — Enter the OSPFv3 process ID for a specific OSPFv3 process, from 1 to 65535.
- *area-id* — Enter the OSPF area ID as an IP address in A.B.C.D format or number, from 1 to 65535.

### Enable OSPFv3

```
OS10(config)# ip vrf vrf-blue
OS10(config-vrf-blue)# router ospfv3 100 vrf vrf-blue
OS10(config-router-ospfv3-100)# exit
OS10(config)# interface ethernet 1/1/2
OS10(conf-if-eth1/1/2)# no shutdown
OS10(conf-if-eth1/1/2)# no switchport
OS10(conf-if-eth1/1/2)# ip vrf forwarding vrf-blue
OS10(conf-if-eth1/1/1)# ipv6 ospfv3 300 area 0.0.0.0
```

#### NOTE:

If you want to move an interface associated with one VRF instance to another default or non-default VRF instance, you must first remove the OSPF or Layer3 configurations that already exist on the interface. If you move the interface from one VRF instance to another without removing these existing Layer3 or OSPF configurations, these configurations do not take effect in the new VRF instance.

Consider a scenario where the OSPF instance 100 is configured on the default VRF instance and the OSPF instance 200 is configured on the non-default VRF instance named VRF-Red. The interface eth1/1/1 on the default VRF instance is attached to an OSPF process 100 area 1. In this scenario, if you want to move eth1/1/1 from the default VRF instance to VRF-Red, you must first remove the OSPF area configuration to which the interface eth1/1/1 is currently attached to.

## Assign Router ID

You can assign a router ID for the OSPFv3 process. Configure an arbitrary value in the IP address format for each router. Each router ID must be unique. Use the fixed router ID for the active OSPFv3 router process. Changing the router ID brings down the existing OSPFv3 adjacency. The new router ID becomes effective immediately.

- Assign the router ID for the OSPFv3 process in ROUTER-OSPFv3 mode.

```
router-id ip-address
```

### Assign router ID

```
OS10(config)# router ospfv3 100
OS10(config-router-ospfv3-100)# router-id 10.10.1.5
```

### View OSPFv3 Status

```
OS10# show ipv6 ospf
Routing Process ospfv3 100 with ID 10.10.1.5
It is an Area Border Router
Min LSA origination 5000 msec, Min LSA arrival 1000 msec
Min LSA hold time 0 msec, Max LSA wait time 0 msec
Number of area in this router is 2, normal 2 stub 0 nssa
Area (0.0.0.0)
 Number of interface in this area is 1
 SPF algorithm executed 42 times
Area (0.0.0.1)
 Number of interface in this area is 1
 SPF algorithm executed 42 times
```

## Configure Stub Areas

Type 5 LSAs are not flooded into stub areas. The ABR advertises a default route into the stub area where it is attached. Stub area routers use the default route to reach external destinations.

1. Enable OSPFv3 routing and enter ROUTER-OSPFv3 mode, from 1 to 65535.

```
router ospfv3 instance number
```

2. Configure an area as a stub area in ROUTER-OSPFv3 mode.

```
area area-id stub [no-summary]
```

- *area-id* — Enter the OSPFv3 area ID as an IP address in A.B.C.D format or number, from 1 to 65535.
- *no-summary* — (Optional) Enter to prevent an ABR from sending summary LSAs into the stub area.

### Configure Stub Area

```
OS10(config)# router ospfv3 10
OS10(config-router-ospfv3-10)# area 10.10.5.1 stub no-summary
```

### View Stub Area Configuration

```
OS10# show running-configuration ospfv3
!
interface ethernet1/1/3
ipv6 ospf 65 area 0.0.0.2
!
router ospfv3 65
area 0.0.0.2 stub no-summary

OS10# show ipv6 ospf database
 OSPF Router with ID (199.205.134.103) (Process ID 65)

Router Link States (Area 0.0.0.2)
```

| ADV Router      | Age | Seq#       | Fragment ID | Link count | Bits |
|-----------------|-----|------------|-------------|------------|------|
| 199.205.134.103 | 32  | 0x80000002 | 0           | 1          |      |
| 202.254.156.15  | 33  | 0x80000002 | 0           | 1          | B    |

Net Link States (Area 0.0.0.2)

| ADV Router     | Age | Seq#       | Link ID | Rtr count |
|----------------|-----|------------|---------|-----------|
| 202.254.156.15 | 38  | 0x80000001 | 12      | 2         |

Inter Area Prefix Link States (Area 0.0.0.2)

| ADV Router     | Age | Seq#       | Prefix |
|----------------|-----|------------|--------|
| 202.254.156.15 | 93  | 0x80000001 | ::/0   |

Intra Area Prefix Link States (Area 0.0.0.2)

| ADV Router     | Age | Seq#       | Link ID | Ref-lstyp | Ref-LSID |
|----------------|-----|------------|---------|-----------|----------|
| 202.254.156.15 | 34  | 0x80000003 | 65536   | 0x2002    | 12       |

Link (Type-8) Link States (Area 0.0.0.2)

| ADV Router      | Age | Seq#       | Link ID | Interface     |
|-----------------|-----|------------|---------|---------------|
| 199.205.134.103 | 42  | 0x80000001 | 12      | ethernet1/1/3 |
| 202.254.156.15  | 54  | 0x80000001 | 12      | ethernet1/1/3 |

## Enable Passive Interfaces

A passive interface is one that does not send or receive routing information. Configuring an interface as a passive interface suppresses both the receiving and sending routing updates.

Although the passive interface does not send or receive routing updates, the network on that interface is included in OSPF updates sent through other interfaces. You can remove an interface from passive interfaces using the `no ipv6 ospf passive` command.

1. Enter an interface type in INTERFACE mode.

```
interface ethernet node/slot/port[:subport]
```

2. Configure the interface as a passive interface in INTERFACE mode.

```
ipv6 ospf passive
```

### Configure Passive Interfaces

```
OS10(config)# interface ethernet 1/1/6
OS10(conf-if-eth1/1/6)# ipv6 ospf passive
```

### View Passive Interfaces

```
OS10# show running-configuraiton
!!!
!!
interface ethernet1/1/1
 ip address 10.10.10.1/24
 no switchport
 no shutdown
 ipv6 ospf 100 area 0
 ipv6 ospf passive
!!
!
```



## Interface OSPFv3 Parameters

To avoid routing errors, interface parameter values must be consistent across all interfaces. For example, set the same time interval for the hello packets on all routers in the OSPF network to prevent misconfiguration of OSPF neighbors.

1. Enter the interface to change the OSPFv3 parameters in CONFIGURATION mode.

```
interface interface-name
```

2. Change the cost associated with OSPFv3 traffic on the interface in INTERFACE mode, from 1 to 65535. The default depends on the interface speed.

```
ipv6 ospf cost
```

3. Change the time interval the router waits before declaring a neighbor dead in INTERFACE mode, from 1 to 65535. The default is 40. The dead interval must be four times the hello interval. The dead interval must be the same on all routers in the OSPFv3 network.

```
ipv6 ospf dead-interval seconds
```

4. Change the time interval in seconds between hello-packet transmission in INTERFACE mode, from 1 to 65535. The default is 10. The hello interval must be the same on all routers in the OSPFv3 network.

```
ipv6 ospf hello-interval seconds
```

5. Change the priority of the interface, which determines the DR for the OSPFv3 broadcast network in INTERFACE mode, from 0 to 255. The default is 1.

```
ipv6 ospf priority number
```

6. Change the default setting to ignore the MTU mismatch with the peer, when the MTU size of the peer interface is higher than the local MTU size.

```
ipv6 ospf mtu-ignore
```

### Change the OSPFv3 interface parameters

```
OS10(config)# interface ethernet 1/1/1
OS10(conf-if-eth1/1/1)# ipv6 ospf hello-interval 5
OS10(conf-if-eth1/1/1)# ipv6 ospf dead-interval 20
OS10(conf-if-eth1/1/1)# ipv6 ospf priority 4
OS10(conf-if-eth1/1/1)# ipv6 ospf mtu-ignore
```

### View the OSPFv3 interface parameters

```
OS10# show ipv6 ospf interface
ethernet1/1/1 is up, line protocol is up
 Link Local Address fe80::20c:29ff:fe0a:d59/64, Interface ID 5
 Area 0.0.0.0, Process ID 200, Instance ID 0, Router ID 10.0.0.2
 Network Type broadcast, Cost: 1
 Transmit Delay is 1 sec, State BDR, Priority 1
 Designated Router on this network is 2.2.2.2
 Backup Designated router on this network is 10.0.0.2 (local)
 Timer intervals configured, Hello 10, Dead 40, Wait 40, Retransmit 5
 Neighbor Count is 1, Adjacent neighbor count is 1
 Adjacent with neighbor 2.2.2.2 (Designated Router)
OS10# do show running-configuration ospfv3
!
interface ethernet1/1/9
ipv6 ospf 1 area 0.0.0.0
ipv6 ospf dead-interval 20
ipv6 ospf hello-interval 5
ipv6 ospf mtu-ignore
```

## Default route

You can generate an external default route and distribute the default information to the OSPFv3 routing domain.

- Generate the default route, using the `default-information originate [always]` command in ROUTER-OSPFv3 mode.

### Configure default route

```
OS10(config)# router ospfv3 100
OS10(config-router-ospf-100)# default-information originate always
```

### View default route configuration

```
OS10(config-router-ospf-100)# show configuration
!
router ospfv3 100
 default-information originate always
```

## OSPFv3 IPsec authentication and encryption

Unlike OSPFv2, OSPFv3 does not have authentication fields in its protocol header to provide security. To provide authentication and confidentiality, OSPFv3 uses IP Security (IPsec) — a collection of security protocols for authenticating and encrypting data packets. OS10 OSPFv3 supports IPsec using the IPv6 authentication header (AH) or IPv6 encapsulating security payload (ESP).

- AH authentication verifies that data is not altered during transmission and ensures that users are communicating with the intended individual or organization. The authentication header is inserted after the IP header with a value of 51. MD5 and SHA1 authentication types are supported; encrypted and unencrypted keys are supported.
- ESP encryption encapsulates data, enabling data protection that follows in the datagram. The ESP extension header is inserted after the IP header and before the next layer protocol header. 3DES, DES, AES-CBC, and NULL encryption algorithms are supported; encrypted and unencrypted keys are supported.

Apply IPsec authentication or encryption on a physical, port-channel, or VLAN interface or in an OSPFv3 area. Each configuration consists of a security policy index (SPI) and the OSPFv3 packets validation key. After you configure an IPsec protocol for OSPFv3, IPsec operation is invisible to the user.

You can only enable one authentication or encryption security protocol at a time on an interface or for an area. Enable IPsec AH using the `ipv6 ospf authentication` command; enable IPsec ESP with the `ipv6 ospf encryption` command.

- A security policy configured for an area is inherited on all interfaces in the area by default.
- A security policy configured on an interface overrides any area-level configured security for the area where the interface is assigned.
- The configured authentication or encryption policy applies to all OSPFv3 packets transmitted on the interface or in the area. The IPsec security associations are the same on inbound and outbound traffic on an OSPFv3 interface.
- There is no maximum AH or ESP header length because the headers have fields with variable lengths.

## Configure IPsec authentication on interfaces

**Prerequisite:** Before you enable IPsec authentication on an OSPFv3 interface, first enable IPv6 unicast routing globally, then enable OSPFv3 on the interface, and assign it to an area.

The SPI value must be unique to one IPsec authentication or encryption security policy on the router. You cannot configure the same SPI value on another interface even if it uses the same authentication or encryption algorithm.

You cannot use an IPsec MD5 or SHA-1 authentication type and the `null` setting at same time on an interface. These settings are mutually exclusive.

- Enable IPsec authentication for OSPFv3 packets in Interface mode.

```
ipv6 ospf authentication {null | ipsec spi number {MD5 | SHA1} key}
```

- `null` — Prevent an authentication policy configured for the area to be inherited on the interface. Only use this parameter if you configure IPsec area authentication.
- `ipsec spi number` — Enter a unique security policy index (SPI) value, from 256 to 4294967295.
- `md5` — Enable message digest 5 (MD5) authentication.

- o `sha1` — Enable secure hash algorithm 1 (SHA-1) authentication.
- o `key` — Enter the text string used in the authentication type. All neighboring OSPFv3 routers must share the key to exchange information. Only a non-encrypted key is supported. For MD5 authentication, the non-encrypted key must be 32 plain hex digits. For SHA-1 authentication, the non-encrypted key must be 40 hex digits. An encrypted key is not supported.

To delete an IPsec authentication policy, use the `no ipv6 ospf authentication ipsec spi number` or `no ipv6 ospf authentication null` command.

### Configure IPsec authentication on interface

```
OS10(conf-if-eth1/1/1)# ipv6 ospf authentication ipsec spi 400 md5
12345678123456781234567812345678
OS10(conf-if-eth1/1/1)# show configuration
!
interface ethernet1/1/1
ipv6 ospf authentication ipsec spi 400 md5 12345678123456781234567812345678
no switchport
no shutdown
ipv6 address 1::1/64
```

## IPsec encryption on interfaces

**Prerequisite:** Before you enable IPsec encryption on an OSPFv3 interface, enable IPv6 unicast routing globally, enable OSPFv3 on the interface, and assign it to an area.

When you configure encryption on an interface, both IPsec encryption and authentication are enabled. You cannot configure encryption if you have already configured an interface for IPsec authentication using the `ipv6 ospf authentication ipsec` command. To configure encryption, you must first delete the authentication policy.

- Enable IPsec encryption for OSPFv3 packets in Interface mode.

```
ipv6 ospf encryption ipsec spi number esp encryption-type
key authentication-type key
```

- o `ipsec spi number` — Enter a unique security policy index (SPI) value, from 256 to 4294967295.
- o `esp encryption-type key` — Enter the encryption algorithm used with ESP (3DES, DES, AES-CBC, or NULL). For AES-CBC, only the AES-128 and AES-192 ciphers are supported.
- o `key` — Enter the text string used in the encryption algorithm. All neighboring OSPFv3 routers must share the key to decrypt information. Only a non-encrypted key is supported. Required lengths of the non-encrypted key are: 3DES — 48 hex digits; DES — 16 hex digits; AES-CBC — 32 hex digits for AES-128 and 48 hex digits for AES-192.
- o `authentication-type key` — Enter the encryption authentication MD5 or SHA1 algorithm to use.
- o `key` — Enter the text string used in the authentication algorithm. All neighboring OSPFv3 routers must share the key to exchange information. Only a non-encrypted key is supported. For MD5 authentication, the non-encrypted key must be 32 plain hex digits. For SHA1 authentication, the non-encrypted key must be 40 hex digits. An encrypted key is not supported.

To delete an IPsec encryption policy, use the `no ipv6 ospf encryption ipsec spi number` or `no ipv6 ospf encryption null` command.

### Configure IPsec encryption on interface

```
OS10(conf-if-eth1/1/1)# ipv6 ospf encryption ipsec spi 500 esp des 1234567812345678 md5
12345678123456781234567812345678
OS10(conf-if-eth1/1/1)# show configuration
!
interface ethernet1/1/1
ipv6 ospf encryption ipsec spi 500 esp des 1234567812345678 md5
12345678123456781234567812345678
no switchport
no shutdown
ipv6 address 1::1/64
```

## Configure IPsec authentication for OSPFv3 area

**Prerequisite:** Before you enable IPsec authentication for an OSPFv3 area, enable OSPFv3 globally on the router.

- Enable IPsec authentication for OSPFv3 packets in an area in Router-OSPFv3 mode.

```
area area-id authentication ipsec spi number {MD5 | SHA1} key
```

- `area area-id` — Enter an area ID as a number or IPv6 prefix.
- `ipsec spi number` — Enter a unique security policy index (SPI) value, from 256 to 4294967295.
- `md5` — Enable message digest 5 (MD5) authentication.
- `sha1` — Enable secure hash algorithm 1 (SHA1) authentication.
- `key` — Enter the text string used in the authentication type. All OSPFv3 routers in the area share the key to exchange information. Only a non-encrypted key is supported. For MD5 authentication, the non-encrypted key must be 32 plain hex digits. For SHA1 authentication, the non-encrypted key must be 40 hex digits. An encrypted key is not supported.

To delete an IPsec area authentication policy, use the `no area area-id authentication ipsec spi number` command.

### Configure IPsec authentication for an OSPFv3 area

```
OS10(config-router-ospfv3-100)# area 1 authentication ipsec spi 400 md5
12345678123456781234567812345678
OS10(config-router-ospfv3-100)# show configuration
!
router ospfv3 100
area 0.0.0.1 authentication ipsec spi 400 md5 12345678123456781234567812345678
```

## IPsec encryption for OSPFv3 area

**Prerequisite:** Before you enable IPsec encryption for an OSPFv3 area, first enable OSPFv3 globally on the router.

When you configure encryption at the area level, both IPsec encryption and authentication are enabled. You cannot configure encryption if you have already configured an IPsec area authentication using the `area ospf authentication ipsec` command. To configure encryption, you must first delete the authentication policy.

- Enable IPsec encryption for OSPFv3 packets in an area in Router-OSPFv3 mode.

```
area area-id encryption ipsec spi number esp encryption-type key
authentication-type key
```

- `area area-id` — Enter an area ID as a number or IPv6 prefix.
- `ipsec spi number` — Enter a unique security policy index (SPI) value, from 256 to 4294967295.
- `esp encryption-type` — Enter the encryption algorithm used with ESP (3DES, DES, AES-CBC, or NULL). For AES-CBC, only the AES-128 and AES-192 ciphers are supported.
- `key` — Enter the text string used in the encryption algorithm. All neighboring OSPFv3 routers must share the key to decrypt information. Only a non-encrypted key is supported. Required lengths of the non-encrypted key are: 3DES — 48 hex digits; DES — 16 hex digits; AES-CBC — 32 hex digits for AES-128 and 48 hex digits for AES-192.
- `authentication-type` — Enter the encryption authentication MD5 or SHA1 algorithm to use.
- `key` — Enter the text string used in the authentication algorithm. All neighboring OSPFv3 routers must share the key to exchange information. Only a non-encrypted key is supported. For MD5 authentication, the non-encrypted key must be 32 plain hex digits. For SHA1 authentication, the non-encrypted key must be 40 hex digits. An encrypted key is not supported.

To delete an IPsec encryption policy, use the `no area area-id encryption ipsec spi number` command.

### Configure IPsec encryption for OSPFv3 area

```
OS10(config-router-ospfv3-100)# area 1 encryption ipsec spi 401 esp des 1234567812345678
md5
12345678123456781234567812345678
OS10(config-router-ospfv3-100)# show configuration
!
router ospfv3 100
```

```
area 0.0.0.1 encryption ipsec spi 401 esp des 1234567812345678 md5
12345678123456781234567812345678
```

## Troubleshoot OSPFv3

You can troubleshoot OSPFv3 operations and check questions for typical issues that interrupt a process.

- Is OSPFv3 enabled globally?
- Is OSPFv3 enabled on the interface?
- Are adjacencies established correctly?
- Are the interfaces configured for L3 correctly?
- Is the router in the correct area type?
- Are the OSPF routes included in the OSPF database?
- Are the OSPF routes included in the routing table in addition to the OSPF database?
- Are you able to ping the link-local IPv6 address of adjacent router interface?

### Troubleshooting OSPFv3 with show Commands

- View a summary of all OSPF process IDs enabled in EXEC mode.

```
show running-configuration ospfv3
```

- View summary information of IP routes in EXEC mode.

```
show ipv6 route summary
```

- View summary information for the OSPF database in EXEC mode.

```
show ipv6 ospf database
```

- View the configuration of OSPF neighbors connected to the local router in EXEC mode.

```
show ipv6 ospf neighbor
```

### View OSPF Configuration

```
OS10# show running-configuration ospfv3
!
interface ethernet1/1/1
ip ospf 100 area 0.0.0.0
!
router ospf 100
log-adjacency-changes
```

## OSPFv3 Commands

### area authentication

Configures authentication for an OSPFv3 area.

**Syntax** `area area-id authentication ipsec spi number {MD5 | SHA1} key`

- Parameters**
- `area area-id` — Enter an area ID as a number or IPv6 prefix.
  - `ipsec spi number` — Enter a unique security policy index (SPI) value, from 256 to 4294967295.
  - `md5` — Enable MD5 authentication.
  - `sha1` — Enable SHA1 authentication.
  - `key` — Enter the text string used in the authentication type.

**Default** OSPFv3 area authentication is not configured.

**Command Mode** ROUTER-OSPFv3

## Usage Information

- Before you enable IPsec authentication for an OSPFv3 area, you must enable OSPFv3 globally on each router.
- All OSPFv3 routers in the area must share the same authentication key to exchange information. Only a non-encrypted key is supported. For MD5 authentication, the non-encrypted key must be 32 plain hex digits. For SHA1 authentication, the non-encrypted key must be 40 hex digits. An encrypted key is not supported.

## Example

```
OS10(config-router-ospfv3-100)# area 1 authentication ipsec spi 400 md5
12345678123456781234567812345678
```

## Supported Releases

10.4.0E(R1) or later

## area encryption

Configures encryption for an OSPFv3 area.

### Syntax

```
area area-id encryption ipsec spi number esp encryption-type key
authentication-type key
```

### Parameters

- *area area-id* — Enter an area ID as a number or IPv6 prefix.
- *ipsec spi number* — Enter a unique security policy index number, from 256 to 4294967295.
- *esp encryption-type* — Enter the encryption algorithm used with ESP (3DES, DES, AES-CBC, or NULL). For AES-CBC, only the AES-128 and AES-192 ciphers are supported.
- *key* — Enter the text string used in the encryption algorithm.
- *authentication-type* — Enter the encryption authentication MD5 or SHA1 algorithm to use.
- *key* — Enter the text string used in the authentication algorithm.

### Default

OSPFv3 area encryption is not configured.

### Command Mode

ROUTER-OSPFv3

## Usage Information

- Before you enable IPsec encryption for an OSPFv3 area, you must enable OSPFv3 globally on each router.
- When you configure encryption at the area level, both IPsec encryption and authentication are enabled. You cannot configure encryption if you have already configured an IPsec area authentication using the `area ospf authentication ipsec` command. To configure encryption, you must first delete the authentication policy.
- All OSPFv3 routers in the area must share the same encryption key to decrypt information. Only a non-encrypted key is supported. Required lengths of the non-encrypted key are: 3DES — 48 hex digits; DES — 16 hex digits; AES-CBC — 32 hex digits for AES-128 and 48 hex digits for AES-192.
- All OSPFv3 routers in the area must share the same authentication key to exchange information. Only a non-encrypted key is supported. For MD5 authentication, the non-encrypted key must be 32 plain hex digits. For SHA1 authentication, the non-encrypted key must be 40 hex digits. An encrypted key is not supported.

## Example

```
OS10(config-router-ospfv3-100)# area 1 encryption ipsec spi 401 esp des
1234567812345678 md5
12345678123456781234567812345678
```

## Supported Releases

10.4.0E(R1) or later

## area stub

Defines an area as the OSPF stub area.

### Syntax

```
area area-id stub [no-summary]
```

### Parameters

- *area-id*—Set the OSPFv3 area ID as an IP address in A.B.C.D format or number, from 1 to 65535.

- `no-summary`—(Optional) Prevents an ABR from sending summary LAs into the stub area.

**Default** Not configured

**Command Mode** ROUTER-OSPFv3

**Usage Information** The `no` version of this command deletes a stub area.

**Example**

```
OS10(config)# router ospfv3 10
OS10(conf-router-ospfv3-10)# area 10.10.1.5 stub
```

**Supported Releases** 10.3.0E or later

## auto-cost reference-bandwidth

Calculates default metrics for the interface based on the configured auto-cost reference bandwidth value.

**Syntax** `auto-cost reference-bandwidth value`

**Parameters** `value` — Enter the reference bandwidth value to calculate the OSPFv3 interface cost in megabits per second, from 1 to 4294967.

**Default** 100000

**Command Mode** ROUTER-OSPFv3

**Usage Information** The value set by the `ipv6 ospf cost` command in INTERFACE mode overrides the cost resulting from the `auto-cost` command. The `no` version of this command resets the value to the default.

**Example**

```
OS10(config)# router ospfv3 100
OS10(config-router-ospfv3-100)# auto-cost reference-bandwidth 150
```

**Supported Releases** 10.3.0E or later

## clear ipv6 ospf process

Clears all OSPFv3 routing tables.

**Syntax** `clear ipv6 ospf {instance-number} [vrf vrf-name] process`

**Parameters**

- `instance-number` — Enter an OSPFv3 instance number, from 1 to 65535.
- `vrf vrf-name` — (Optional) Enter the keyword `vrf` followed by the name of the VRF to clear OSPFv3 processes in that VRF.

**Default** Not configured

**Command Mode** EXEC

**Usage Information** None

**Example**

```
OS10# clear ipv6 ospf 3 process
```

**Supported Releases** 10.3.0E or later

## clear ipv6 ospf statistics

Clears OSPFv3 traffic statistics.

|                           |                                                                                                                                                                                                                                                                                  |
|---------------------------|----------------------------------------------------------------------------------------------------------------------------------------------------------------------------------------------------------------------------------------------------------------------------------|
| <b>Syntax</b>             | <code>clear ipv6 ospf [<i>instance-number</i>] [<i>vrf vrf-name</i>] statistics</code>                                                                                                                                                                                           |
| <b>Parameters</b>         | <ul style="list-style-type: none"><li>• <i>instance-number</i> — (Optional) Enter an OSPFv3 instance number, from 1 to 65535.</li><li>• <i>vrf vrf-name</i> — (Optional) Enter the keyword vrf followed by the name of the VRF to clear OSPFv3 statistics in that VRF.</li></ul> |
| <b>Default</b>            | Not configured                                                                                                                                                                                                                                                                   |
| <b>Command Mode</b>       | EXEC                                                                                                                                                                                                                                                                             |
| <b>Usage Information</b>  | This command clears the OSPFv3 traffic statistics in a specified instance or in all the configured OSPFv3 instances, and resets them to zero.                                                                                                                                    |
| <b>Example</b>            | <pre>OS10# clear ipv6 ospf 100 statistics</pre>                                                                                                                                                                                                                                  |
| <b>Supported Releases</b> | 10.4.0E(R1) or later                                                                                                                                                                                                                                                             |

## debug ip ospfv3

Enables Open Shortest Path First version 3(OSPFv3) debugging and displays messages related to processing of OSPFv3.

|                           |                                                                                                       |
|---------------------------|-------------------------------------------------------------------------------------------------------|
| <b>Syntax</b>             | <code>debug ip ospfv3</code>                                                                          |
| <b>Parameters</b>         | None                                                                                                  |
| <b>Defaults</b>           | None                                                                                                  |
| <b>Command Mode</b>       | EXEC                                                                                                  |
| <b>Usage Information</b>  | The <code>no debug ip ospfv3</code> command stops displaying messages related to processing of OSPFv3 |
| <b>Example</b>            | <pre>debug ip ospfv3</pre>                                                                            |
| <b>Supported Releases</b> | OS10 legacy command.                                                                                  |

## default-information originate

Generates and distributes a default external route information to the OSPFv3 routing domain.

|                           |                                                                                                                 |
|---------------------------|-----------------------------------------------------------------------------------------------------------------|
| <b>Syntax</b>             | <code>default-information originate [<i>always</i>]</code>                                                      |
| <b>Parameters</b>         | <i>always</i> — (Optional) Always advertise the default route.                                                  |
| <b>Defaults</b>           | Disabled                                                                                                        |
| <b>Command Mode</b>       | ROUTER-OSPFv3                                                                                                   |
| <b>Usage Information</b>  | The <code>no</code> version of this command disables the distribution of default route.                         |
| <b>Example</b>            | <pre>OS10(config)# router ospfv3 100 OS10(config-router-ospfv3-100)# default-information originate always</pre> |
| <b>Supported Releases</b> | 10.3.0E or later                                                                                                |



## ipv6 ospf area

Attaches an interface to an OSPF area.

|                           |                                                                                                                                                                                                                                                                                            |
|---------------------------|--------------------------------------------------------------------------------------------------------------------------------------------------------------------------------------------------------------------------------------------------------------------------------------------|
| <b>Syntax</b>             | <code>ipv6 ospf process-id area area-id</code>                                                                                                                                                                                                                                             |
| <b>Parameters</b>         | <ul style="list-style-type: none"><li>• <code>process-id</code>—Enter an OSPFv3 process ID for a specific OSPFv3 process, from 1 to 65535.</li><li>• <code>area-id</code>—Enter the OSPFv3 area ID in dotted decimal A.B.C.D format or enter an area ID number, from 1 to 65535.</li></ul> |
| <b>Default</b>            | Not configured                                                                                                                                                                                                                                                                             |
| <b>Command Mode</b>       | INTERFACE                                                                                                                                                                                                                                                                                  |
| <b>Usage Information</b>  | The <code>no</code> version of this command removes an interface from an OSPFv3 area.                                                                                                                                                                                                      |
| <b>Example</b>            | <pre>OS10(config)# interface vlan 10 OS10(conf-if-vl-10)# ipv6 ospf 10 area 1</pre>                                                                                                                                                                                                        |
| <b>Supported Releases</b> | 10.3.0E or later                                                                                                                                                                                                                                                                           |

## ipv6 ospf authentication

Configures OSPFv3 authentication on an IPv6 interface.

|                           |                                                                                                                                                                                                                                                                                                                                                                                                                                                                                                                                                                                                                                                                                                                                                                                                                                                                                                                                                                                                |
|---------------------------|------------------------------------------------------------------------------------------------------------------------------------------------------------------------------------------------------------------------------------------------------------------------------------------------------------------------------------------------------------------------------------------------------------------------------------------------------------------------------------------------------------------------------------------------------------------------------------------------------------------------------------------------------------------------------------------------------------------------------------------------------------------------------------------------------------------------------------------------------------------------------------------------------------------------------------------------------------------------------------------------|
| <b>Syntax</b>             | <code>ipv6 ospf authentication {null   ipsec spi number {MD5   SHA1} key}</code>                                                                                                                                                                                                                                                                                                                                                                                                                                                                                                                                                                                                                                                                                                                                                                                                                                                                                                               |
| <b>Parameters</b>         | <ul style="list-style-type: none"><li>• <code>null</code> — Prevents area authentication from being inherited on the interface.</li><li>• <code>ipsec spi number</code> — Enter a unique security policy index number, from 256 to 4294967295.</li><li>• <code>md5</code> — Enable MD5 authentication.</li><li>• <code>sha1</code> — Enable SHA1 authentication.</li><li>• <code>key</code> — Enter the text string used by the authentication type.</li></ul>                                                                                                                                                                                                                                                                                                                                                                                                                                                                                                                                 |
| <b>Default</b>            | IPv6 OSPF authentication is not configured on an interface.                                                                                                                                                                                                                                                                                                                                                                                                                                                                                                                                                                                                                                                                                                                                                                                                                                                                                                                                    |
| <b>Command Mode</b>       | INTERFACE                                                                                                                                                                                                                                                                                                                                                                                                                                                                                                                                                                                                                                                                                                                                                                                                                                                                                                                                                                                      |
| <b>Usage Information</b>  | <ul style="list-style-type: none"><li>• Before you enable IPsec authentication on an OSPFv3 interface, you must enable IPv6 unicast routing globally, configure an IPv6 address and enable OSPFv3 on the interface, and assign it to an area.</li><li>• The SPI value must be unique to one IPsec authentication or encryption security policy on the router. You cannot configure the same SPI value on another interface even if it uses the same authentication or encryption algorithm.</li><li>• You cannot use an IPsec MD5 or SHA1 authentication type and the <code>null</code> setting at same time on an interface. These settings are mutually exclusive.</li><li>• All neighboring OSPFv3 routers must share the key to exchange information. Only a non-encrypted key is supported. For MD5 authentication, the non-encrypted key must be 32 plain hex digits. For SHA1 authentication, the non-encrypted key must be 40 hex digits. An encrypted key is not supported.</li></ul> |
| <b>Example</b>            | <pre>OS10(config)# interface ethernet 1/1/6 OS10(conf-if-eth1/1/6)# ipv6 ospf authentication ipsec spi 400 md5 12345678123456781234567812345678</pre>                                                                                                                                                                                                                                                                                                                                                                                                                                                                                                                                                                                                                                                                                                                                                                                                                                          |
| <b>Supported Releases</b> | 10.4.0E(R1) or later                                                                                                                                                                                                                                                                                                                                                                                                                                                                                                                                                                                                                                                                                                                                                                                                                                                                                                                                                                           |

## ipv6 ospf cost

Changes the cost associated with the OSPFv3 traffic on an interface

|                           |                                                                                                                                                                                                                                                                                      |
|---------------------------|--------------------------------------------------------------------------------------------------------------------------------------------------------------------------------------------------------------------------------------------------------------------------------------|
| <b>Syntax</b>             | <code>ipv6 ospf cost <i>cost</i></code>                                                                                                                                                                                                                                              |
| <b>Parameters</b>         | <i>cost</i> — Enter a value as the OSPFv3 cost for the interface, from 1 to 65535.                                                                                                                                                                                                   |
| <b>Default</b>            | Based on bandwidth reference                                                                                                                                                                                                                                                         |
| <b>Command Mode</b>       | INTERFACE                                                                                                                                                                                                                                                                            |
| <b>Usage Information</b>  | If not configured, the interface cost is based on the <code>auto-cost</code> command. This command configures OSPFv3 over multiple vendors to ensure that all routers use the same cost value. The <code>no</code> version of this command removes the IPv6 OSPF cost configuration. |
| <b>Example</b>            | <pre>OS10(config)# interface vlan 10 OS10(conf-if-vl-10)# ipv6 ospf cost 10</pre>                                                                                                                                                                                                    |
| <b>Supported Releases</b> | 10.3.0E or later                                                                                                                                                                                                                                                                     |

## ipv6 ospf dead-interval

Sets the time interval since the last hello-packet was received from a router. After the interval elapses, the neighboring routers declare the router dead.

|                           |                                                                                                                                                     |
|---------------------------|-----------------------------------------------------------------------------------------------------------------------------------------------------|
| <b>Syntax</b>             | <code>ipv6 ospf dead-interval <i>seconds</i></code>                                                                                                 |
| <b>Parameters</b>         | <i>seconds</i> — Enter the dead interval value in seconds, from 1 to 65535.                                                                         |
| <b>Default</b>            | 40 seconds                                                                                                                                          |
| <b>Command Mode</b>       | INTERFACE                                                                                                                                           |
| <b>Usage Information</b>  | The dead interval is four times the default hello-interval by default. The <code>no</code> version of this command resets the value to the default. |
| <b>Example</b>            | <pre>OS10(config)# interface vlan 10 OS10(conf-if-vl-10)# ipv6 ospf dead-interval 10</pre>                                                          |
| <b>Supported Releases</b> | 10.3.0E or later                                                                                                                                    |

## ipv6 ospf encryption

Configures OSPFv3 encryption on an IPv6 interface.

|                     |                                                                                                                                                                                                                                                                                                                                                                                                                                                                                                                                                                                                                                                                                                  |
|---------------------|--------------------------------------------------------------------------------------------------------------------------------------------------------------------------------------------------------------------------------------------------------------------------------------------------------------------------------------------------------------------------------------------------------------------------------------------------------------------------------------------------------------------------------------------------------------------------------------------------------------------------------------------------------------------------------------------------|
| <b>Syntax</b>       | <code>ipv6 ospf encryption {ipsec spi <i>number</i> esp <i>encryption-type</i> <i>key</i> authentication-type <i>key</i>   null}</code>                                                                                                                                                                                                                                                                                                                                                                                                                                                                                                                                                          |
| <b>Parameters</b>   | <ul style="list-style-type: none"><li>• <i>ipsec spi number</i> — Enter a unique security policy index number, from 256 to 4294967295.</li><li>• <i>esp encryption-type</i> — Enter the encryption algorithm used with ESP (3DES, DES, AES-CBC, or NULL). For AES-CBC, only the AES-128 and AES-192 ciphers are supported.</li><li>• <i>key</i> — Enter the text string used in the encryption algorithm.</li><li>• <i>authentication-type</i> — Enter the encryption MD5 or SHA1 authentication algorithm to use.</li><li>• <i>key</i> — Enter the text string used in the authentication algorithm.</li><li>• <code>null</code> — Enter the keyword to not use the IPsec encryption.</li></ul> |
| <b>Default</b>      | IPv6 OSPF encryption is not configured on an interface.                                                                                                                                                                                                                                                                                                                                                                                                                                                                                                                                                                                                                                          |
| <b>Command Mode</b> | INTERFACE                                                                                                                                                                                                                                                                                                                                                                                                                                                                                                                                                                                                                                                                                        |

## Usage Information

- Before you enable IPsec authentication on an OSPFv3 interface, you must enable IPv6 unicast routing globally, configure an IPv6 address and enable OSPFv3 on the interface, and assign it to an area.
- When you configure encryption on an interface, both IPsec encryption and authentication are enabled. You cannot configure encryption if you have already configured an interface for IPsec authentication using the `ipv6 ospf authentication ipsec` command. To configure encryption, you must first delete the authentication policy.
- All neighboring OSPFv3 routers must share the same encryption key to decrypt information. Only a non-encrypted key is supported. Required lengths of the non-encrypted key are: 3DES — 48 hex digits; DES — 16 hex digits; AES-CBC — 32 hex digits for AES-128 and 48 hex digits for AES-192.
- All neighboring OSPFv3 routers must share the same authentication key to exchange information. Only a non-encrypted key is supported. For MD5 authentication, the non-encrypted key must be 32 plain hex digits. For SHA1 authentication, the non-encrypted key must be 40 hex digits. An encrypted key is not supported.

## Example

```
OS10(config)# interface ethernet 1/1/6
OS10(conf-if-eth1/1/6)# ipv6 ospf encryption ipsec spi 500 esp des
1234567812345678 md5 1234567812345678123456781234567812345678
```

```
OS10(config)# interface ethernet 1/1/5
OS10(conf-if-eth1/1/5)# ipv6 ospf encryption null
```

## Supported Releases

10.4.0E(R1) or later

## ipv6 ospf hello-interval

Sets the time interval between hello packets sent on an interface.

**Syntax** `ipv6 ospf hello-interval seconds`

**Parameters** *seconds* — Enter the hello-interval value in seconds, from 1 to 65535.

**Default** 10 seconds

**Command Mode** INTERFACE

**Usage Information** All routers in a network must have the same hello time interval between the hello packets. The `no` version of the this command resets the value to the default.

## Example

```
OS10(config)# interface vlan 10
OS10(conf-if-vl-10)# ipv6 ospf hello-interval 30
```

## Supported Releases

10.3.0E or later

## ipv6 ospf mtu-ignore

Disables MTU size detection on received Database Descriptor (DBD) packets when forming OSPFv3 adjacency.

**Syntax** `ipv6 ospf mtu-ignore`

**Parameters** None

**Default** Not configured

**Command Mode** INTERFACE

**Usage Information** If the MTU size of the peer interface is greater than the local interface, switches that run OSPFv3 do not form adjacencies with neighbors. Use this command to override this behavior and form adjacency.

If you try to disable a neighborhood using the `no ipv6 ospf mtu-ignore` command after a neighborhood is formed using the `ipv6 ospf mtu-ignore` command, the neighborhood still continues.

To remove a neighborhood after it is formed using the `ipv6 ospf mtu-ignore` command, use the `clear ipv6 ospf process` command.

#### Example

```
OS10(config-if-eth1/1/17)# ipv6 ospf mtu-ignore
```

#### Supported Releases

10.5.1.0 or later

## ipv6 ospf network

Sets the network type for the interface.

#### Syntax

```
ipv6 ospf network {point-to-point | broadcast}
```

#### Parameters

- `point-to-point` — Sets the interface as part of a point-to-point network.
- `broadcast` — Sets the interface as part of a broadcast network.

#### Default

Broadcast

#### Command Mode

INTERFACE

#### Usage Information

The `no` version of this command resets the value to the default.

#### Example

```
OS10(config)# interface ethernet 1/1/1
OS10(config-if-eth1/1/1)# ipv6 ospf network broadcast
```

#### Supported Releases

10.3.0E or later

## ipv6 ospf passive

Configures an interface as a passive interface and suppresses both receiving and sending routing updates to the passive interface.

#### Syntax

```
ipv6 ospf passive
```

#### Parameters

None

#### Default

Not configured

#### Command Mode

INTERFACE

#### Usage Information

You must configure the interface before setting the interface to passive mode. The `no` version of the this command disables Passive interface configuration.

**i** **NOTE:** As loopback interfaces are implicitly passive, the configuration to suppress sending and receiving of OSPF routing updates does not take effect on the loopback interfaces. However, network information corresponding to these loopback interfaces is still announced in OSPF LSAs that are sent through other interfaces configured for OSPF.

#### Example

```
OS10(config)# interface ethernet 1/1/6
OS10(config-if-eth1/1/6)# ipv6 ospf passive
```

#### Supported Releases

10.3.0E or later

## ipv6 ospf priority

Sets the priority of the interface to determine the DR for the OSPFv3 network.

#### Syntax

```
ipv6 ospf priority number
```

|                           |                                                                                                                                                                                                         |
|---------------------------|---------------------------------------------------------------------------------------------------------------------------------------------------------------------------------------------------------|
| <b>Parameters</b>         | <i>number</i> — Enter a router priority number, from 0 to 255.                                                                                                                                          |
| <b>Default</b>            | 1                                                                                                                                                                                                       |
| <b>Command Mode</b>       | INTERFACE                                                                                                                                                                                               |
| <b>Usage Information</b>  | When two routers attached to a network attempt to become the DR, the one with the higher router priority takes precedence. The <code>no</code> version of this command resets the value to the default. |
| <b>Example</b>            | <pre>OS10(config)# interface ethernet 1/1/6 OS10(conf-if-eth1/1/6)# ipv6 ospf priority 4</pre>                                                                                                          |
| <b>Supported Releases</b> | 10.3.0E or later                                                                                                                                                                                        |

## log-adjacency-changes

Enables logging of syslog messages about changes in the OSPFv3 adjacency state.

|                           |                                                                                                  |
|---------------------------|--------------------------------------------------------------------------------------------------|
| <b>Syntax</b>             | <code>log-adjacency-changes</code>                                                               |
| <b>Parameters</b>         | None                                                                                             |
| <b>Default</b>            | Disabled                                                                                         |
| <b>Command Mode</b>       | ROUTER-OSPFv3                                                                                    |
| <b>Usage Information</b>  | The <code>no</code> version of this command resets the value to the default.                     |
| <b>Example</b>            | <pre>OS10(config)# router ospfv3 100 OS10(config-router-ospfv3-100)# log-adjacency-changes</pre> |
| <b>Supported Releases</b> | 10.3.0E or later                                                                                 |

## maximum-paths

Enables forwarding of packets over multiple paths.

|                           |                                                                                        |
|---------------------------|----------------------------------------------------------------------------------------|
| <b>Syntax</b>             | <code>maximum-paths <i>number</i></code>                                               |
| <b>Parameters</b>         | <i>number</i> — Enter the number of paths for OSPFv3, from 1 to 128.                   |
| <b>Default</b>            | Disabled                                                                               |
| <b>Command Mode</b>       | ROUTER-OSPFv3                                                                          |
| <b>Usage Information</b>  | The <code>no</code> version of this command resets the value to the default.           |
| <b>Example</b>            | <pre>OS10(config)# router ospfv3 OS10(config-router-ospfv3-100)# maximum-paths 1</pre> |
| <b>Supported Releases</b> | 10.3.0E or later                                                                       |

## redistribute

Redistributes information from another routing protocol or routing instance to the OSPFv3 process.

|               |                                                                                                                       |
|---------------|-----------------------------------------------------------------------------------------------------------------------|
| <b>Syntax</b> | <code>redistribute {<i>bgp as-number</i>   <i>connected</i>   <i>static</i>} [<i>route-map route-map name</i>]</code> |
|---------------|-----------------------------------------------------------------------------------------------------------------------|

|                            |                                                                                                                                                                                                                                                                                                                                                                                                                                                                                                  |
|----------------------------|--------------------------------------------------------------------------------------------------------------------------------------------------------------------------------------------------------------------------------------------------------------------------------------------------------------------------------------------------------------------------------------------------------------------------------------------------------------------------------------------------|
| <b>Parameters</b>          | <ul style="list-style-type: none"> <li>• <i>as-number</i> — Enter an autonomous number to redistribute BGP routing information throughout the OSPFv3 instance, from 1 to 4294967295.</li> <li>• <i>route-map name</i> — Enter the name of a configured route-map.</li> <li>• <i>connected</i> — Enter the information from the connected active routes on interfaces to redistribute.</li> <li>• <i>static</i> — Enter the information from static routes on interfaces redistribute.</li> </ul> |
| <b>Defaults</b>            | Not configured                                                                                                                                                                                                                                                                                                                                                                                                                                                                                   |
| <b>Command Mode</b>        | ROUTER-OSPFv3                                                                                                                                                                                                                                                                                                                                                                                                                                                                                    |
| <b>Usage Information</b>   | When an OSPFv3 redistributes, the process is not completely removed from the BGP configuration. The <code>no</code> version of this command disables the redistribute configuration.                                                                                                                                                                                                                                                                                                             |
| <b>Example</b>             | <pre>OS10(config)# router ospfv3 100 OS10(config-router-ospfv3-100)# redistribute bgp 4 route-map dell1</pre>                                                                                                                                                                                                                                                                                                                                                                                    |
| <b>Example (Connected)</b> | <pre>OS10((config-router-ospfv3-100)# redistribute connected route-map dell2</pre>                                                                                                                                                                                                                                                                                                                                                                                                               |
| <b>Supported Releases</b>  | 10.3.0E or later                                                                                                                                                                                                                                                                                                                                                                                                                                                                                 |

## router-id

Configures a fixed router ID for the OSPFv3 process.

|                           |                                                                                                                                                                                                                                                                                                                                                                          |
|---------------------------|--------------------------------------------------------------------------------------------------------------------------------------------------------------------------------------------------------------------------------------------------------------------------------------------------------------------------------------------------------------------------|
| <b>Syntax</b>             | <code>router-id ip-address</code>                                                                                                                                                                                                                                                                                                                                        |
| <b>Parameters</b>         | <i>ip-address</i> — Enter the IP address of the router as the router ID.                                                                                                                                                                                                                                                                                                 |
| <b>Default</b>            | Not configured                                                                                                                                                                                                                                                                                                                                                           |
| <b>Command Mode</b>       | ROUTER-OSPFv3                                                                                                                                                                                                                                                                                                                                                            |
| <b>Usage Information</b>  | Configure an arbitrary value in the IP address format for each router. Each router ID must be unique. Use the fixed router ID for the active OSPFv3 router process. Changing the router ID brings down the existing OSPFv3 adjacency. The new router ID becomes effective immediately. The <code>no</code> version of this command disables the router ID configuration. |
| <b>Example</b>            | <pre>OS10(config)# router ospfv3 10 OS10(config-router-ospfv3-100)# router-id 10.10.1.5</pre>                                                                                                                                                                                                                                                                            |
| <b>Supported Releases</b> | 10.3.0E or later                                                                                                                                                                                                                                                                                                                                                         |

## router ospfv3

Enters Router OSPFv3 mode and configures an OSPFv3 instance.

|                          |                                                                                                                                                                                                                                                                                     |
|--------------------------|-------------------------------------------------------------------------------------------------------------------------------------------------------------------------------------------------------------------------------------------------------------------------------------|
| <b>Syntax</b>            | <code>router ospfv3 instance-number [vrf vrf-name]</code>                                                                                                                                                                                                                           |
| <b>Parameters</b>        | <ul style="list-style-type: none"> <li>• <i>instance-number</i>—Enter a router OSPFv3 instance number, from 1 to 65535.</li> <li>• <i>vrf vrf-name</i> — Enter the keyword <code>vrf</code> followed by the name of the VRF to configure an OSPFv3 instance in that VRF.</li> </ul> |
| <b>Default</b>           | Not configured                                                                                                                                                                                                                                                                      |
| <b>Command Mode</b>      | CONFIGURATION                                                                                                                                                                                                                                                                       |
| <b>Usage Information</b> | The <code>no</code> version of this command deletes an OSPFv3 instance.                                                                                                                                                                                                             |
| <b>Example</b>           | <pre>OS10(config)# router ospfv3 10 vrf vrf-test</pre>                                                                                                                                                                                                                              |

**Supported Releases** 10.3.0E or later

## show ipv6 ospf

Displays OSPFv3 instance configuration information.

**Syntax** `show ipv6 ospf [instance-number]`

**Parameters** *instance-number* — (Optional) View OSPFv3 information for a specified instance number, from 1 to 65535.

**Default** None

**Command Mode** EXEC

**Usage Information** None

### Example

```
OS10# show ipv6 ospf
Routing Process ospfv3 200 with ID 1.1.1.1
It is an Area Border Router
Min LSA origination 5000 msec, Min LSA arrival 1000 msec
Min LSA hold time 0 msec, Max LSA wait time 0 msec
Number of area in this router is 2, normal 2 stub 0 nssa
 Area (0.0.0.0)
 Number of interface in this area is 1
 SPF algorithm executed 42 times
 Area (0.0.0.1)
 Number of interface in this area is 1
 SPF algorithm executed 42 times
OS10# show ipv6 ospf 200
Routing Process ospfv3 200 with ID 10.0.0.2
Min LSA origination 5000 msec, Min LSA arrival 1000 msec
Min LSA hold time 0 msec, Max LSA wait time 0 msec
Number of area in this router is 1, normal 1 stub 0 nssa
 Area (0.0.0.0)
 Number of interface in this area is 1
 SPF algorithm executed 3 times
```

**Supported Releases** 10.3.0E or later

## show ipv6 ospf database

Displays all LSA information. You must enable OSPFv3 to generate output.

**Syntax** `show ipv6 ospf process-id [vrf vrf-name] database`

**Parameters**

- *process-id* — Enter the OSPFv3 process ID to view a specific process. If you do not enter a process ID, the command applies to all the configured OSPFv3 processes.
- *vrf vrf-name* — Enter the keyword `vrf` followed by the name of the VRF to display LSA information for that VRF.

**Default** Not configured

**Command Mode** EXEC

**Usage Information**

- `Link ID`—Identifies the router ID.
- `ADV Router`—Identifies the advertising router's ID.
- `Age`—Displays the LS age.
- `Seq#`—Identifies the LS sequence number. This identifies old or duplicate LSAs.
- `Checksum`—Displays the Fletcher checksum of an LSA's complete contents.
- `Link count`—Displays the number of interfaces for that router.

- Rtr Count—Displays the router count.
- Dest RtrID—Displays the destination router ID.
- Interface—Displays the interface type.
- Prefix—Displays the prefix details.

### Example

```
OS10# show ipv6 ospf database
 OSPF Router with ID (10.0.0.2) (Process ID 200)
Router Link States (Area 0.0.0.0)
ADV Router Age Seq# Fragment ID Link count Bits

1.1.1.1 1610 0x80000144 0 1 B
2.2.2.2 1040 0x8000013A 0 1
10.0.0.2 1039 0x80000002 0 1
Net Link States (Area 0.0.0.0)
ADV Router Age Seq# Link ID Rtr count

2.2.2.2 1045 0x80000001 5 2
Inter Area Router States (Area 0.0.0.0)
ADV Router Age Seq# Link ID Dest RtrID

1.1.1.1 1605 0x80000027 1 3.3.3.3
Link (Type-8) Link States (Area 0.0.0.0)
ADV Router Age Seq# Link ID Interface

1.1.1.1 1615 0x80000125 5 ethernet1/1/1
2.2.2.2 1369 0x8000011B 5 ethernet1/1/1
10.0.0.2 1044 0x80000001 5 ethernet1/1/1
Type-5 AS External Link States
ADV Router Age Seq# Prefix

3.3.3.3 3116 0x80000126 400::/64
3.3.3.3 3116 0x80000124 34::/64
```

### Supported Releases

10.3.0E or later

## show ipv6 ospf interface

Displays the configured OSPFv3 interfaces. You must enable OSPFv3 to display the output.

### Syntax

```
show ipv6 ospf interface interface [vrf vrf-name]
```

### Parameters

- *interface* — (Optional) Enter the interface information:
  - *ethernet* — Physical interface, from 1 to 48.
  - *port-channel* — Port-channel interface, from 1 to 128.
  - *vlan* — VLAN interface, from 1 to 4093.
- *vrf vrf-name* — (Optional) Enter the keyword *vrf* followed by the name of the VRF to display the configured OSPFv3 enabled interfaces in that VRF.

### Default

Not configured

### Command Mode

EXEC

### Example

```
OS10# show ipv6 ospf interface
ethernet1/1/1 is up, line protocol is up
 Link Local Address fe80::20c:29ff:fe0a:d59/64, Interface ID 5
 Area 0.0.0.0, Process ID 200, Instance ID 0, Router ID 10.0.0.2
 Network Type broadcast, Cost: 1
 Transmit Delay is 1 sec, State BDR, Priority 1
 BFD enabled(Interface level) Interval 300 Min_rx 300 Multiplier 3 Role
Active
 Designated Router on this network is 2.2.2.2
 Backup Designated router on this network is 10.0.0.2 (local)
 Timer intervals configured, Hello 10, Dead 40, Wait 40, Retransmit 5
```



```
Neighbor Count is 1, Adjacent neighbor count is 1
Adjacent with neighbor 2.2.2.2 (Designated Router)
```

**Supported Releases** 10.3.0E or later

## show ipv6 ospf neighbor

Displays a list of OSPFv3 neighbors connected to the local router.

**Syntax** `show ipv6 ospf [vrf vrf-name] neighbor`

**Parameters**

- `vrf vrf-name` — Enter the keyword `vrf` followed by the name of the VRF to display a list of OSPFv3 neighbors in that VRF.

**Default** Not configured

**Command Mode** EXEC

**Usage Information**

- `Neighbor ID`—Displays the neighbor router ID.
- `Pri`—Displays the priority assigned neighbor.
- `State`—Displays the OSPF state of the neighbor.
- `Dead Time`—Displays the expected time until the system declares the neighbor dead.
- `Interface ID`—Displays the neighbor interface ID
- `Interface`—Displays the interface type, node/slot/port or number information.

### Example

```
OS10(conf-if-eth1/1/1)# show ipv6 ospf neighbor
Neighbor ID Pri State Dead Time Interface ID Interface

2.2.2.2 1 Full/DR 00:00:30 5 ethernet1/1/1
```

**Supported Releases** 10.3.0E or later

## show ipv6 ospf statistics

Displays OSPFv3 traffic statistics.

**Syntax** `show ipv6 ospf [instance-number] statistics [interface interface]`

**Parameters**

- `instance-number` — (Optional) Enter an OSPFv3 instance number, from 1 to 65535.
- `interface interface` — (Optional) Enter the interface information:
  - `ethernet node/slot/port[:subport]` — Enter an Ethernet port interface.
  - `port-channel number` — Enter the port-channel interface number, from 1 to 128.
  - `vlan vlan-id` — Enter the VLAN ID number, from 1 to 4093.

**Default** Not configured

**Command Mode** EXEC

**Usage Information** This command displays OSPFv3 traffic statistics for a specified instance or interface, or for all OSPFv3 instances and interfaces.

### Example

```
OS10# show ipv6 ospf interface ethernet 1/1/1

Interface ethernet1/1/1
Receive Statistics
 rx-invalid 0 rx-invalid-bytes 0
 rx-hello 0 rx-hello-bytes 0
 rx-db-des 0 rx-db-des-bytes 0
 rx-ls-req 0 rx-ls-req-bytes 0
 rx-ls-upd 0 rx-ls-upd-bytes 0
```

```

rx-ls-ack 0 rx-ls-ack-bytes 0
Transmit Statistics
tx-hello 1054 tx-hello-bytes 37944
tx-db-des 0 tx-db-des-bytes 0
tx-ls-req 0 tx-ls-req-bytes 0
tx-ls-upd 0 tx-ls-upd-bytes 0
tx-ls-ack 0 tx-ls-ack-bytes 0
Error packets (Receive statistics)
bad-src 0 dupe-id 0 hello-err 0
mtu-mismatch 0 nbr-ignored 0
resource-err 0 bad-lsa-len 0 lsa-bad-type 0
lsa-bad-len 0 lsa-bad-cksum 0
hello-tmr-mismatch 0 dead-ivl-mismatch 0
options-mismatch 0 nbr-admin-down 0 own-hello-drop 0
self-orig 0 wrong-length 0
version-mismatch 0 area-mismatch 0

```

**Supported Releases** 10.4.0E(R1) or later

## timers spf (OSPFv3)

Enables shortest path first (SPF) throttling to delay an SPF calculation when a topology change occurs.

**Syntax** `timers spf [start-time [hold-time [max-wait]]]`

**Parameters**

- *start-time* — Sets the initial SPF delay in milliseconds, from 1 to 600000; default 1000.
- *hold-time* — Sets the additional hold time between two SPF calculations in milliseconds, from 1 to 600000; default 10000.
- *max-wait* — Sets the maximum wait time between two SPF calculations in milliseconds, from 1 to 600000; default 10000.

**Default**

- *start-time* — 1000 milliseconds
- *hold-time* — 10000 milliseconds
- *max-wait* — 10000 milliseconds

**Command Mode** ROUTER-OSPFv3

**Usage Information** OSPFv2 and OSPFv3 support SPF throttling. By default, SPF timers are disabled in an OSPF instance.

Use SPF throttling to delay SPF calculations during periods of network instability. In an OSPF network, a topology change event triggers an SPF calculation after a specified start time. When the start timer finishes, a hold time may delay the next SPF calculation for an additional time. When the hold timer is running:

- Each time a topology change occurs, the SPF calculation delays for double the configured hold time up to maximum wait time.
- If no topology change occur, an SPF calculation performs and the hold timer resets to its configured value.

If you do not specify a start-time, hold-time, or max-wait value, the default values are used. The `no` version of this command removes the configured SPF timers and disables SPF throttling in an OSPF instance.

### Example

```

OS10(config)# router ospfv3 100
OS10(config-router-ospfv3-100)# timers spf 1345 2324 9234

OS10(config-router-ospfv3-100)# do show ipv6 ospf
Routing Process ospfv3 100 with ID 129.240.244.107
SPF schedule delay 1345 msec, Hold time between two SPF's 2324 msec
Min LSA origination 5000 msec, Min LSA arrival 1000 msec
Min LSA hold time 0 msec, Max LSA wait time 0 msec
Number of area in this router is 1, normal 1 stub 0 nssa
Area (0.0.0.1)
Number of interface in this area is 1
SPF algorithm executed 2 times

```

## Object tracking manager

OTM allows you to track the link status of Layer 2 (L2) interfaces, and the reachability of IPv4 and IPv6 hosts. You can increase the availability of the network and shorten recovery time if an object state goes Down.

Object tracking monitors the status of tracked objects and communicates any changes made to interested client applications. OTM client applications are virtual router redundancy protocol (VRRP) and policy-based routing (PBR). Each tracked object has a unique identifying number that clients use to configure the action to take when a tracked object changes state. You can also optionally specify a time delay before changes in a tracked object's state report to a client application.

VRRP subscribes to a track object which tracks the interface line protocol state. It uses the tracked object status to determine the priority of the VRRP router in a VRRP group. If a tracked state or interface goes down, VRRP updates the priority based on how you configure the new priority for the tracked state. When the tracked state comes up, VRRP restores the original priority for the virtual router group.

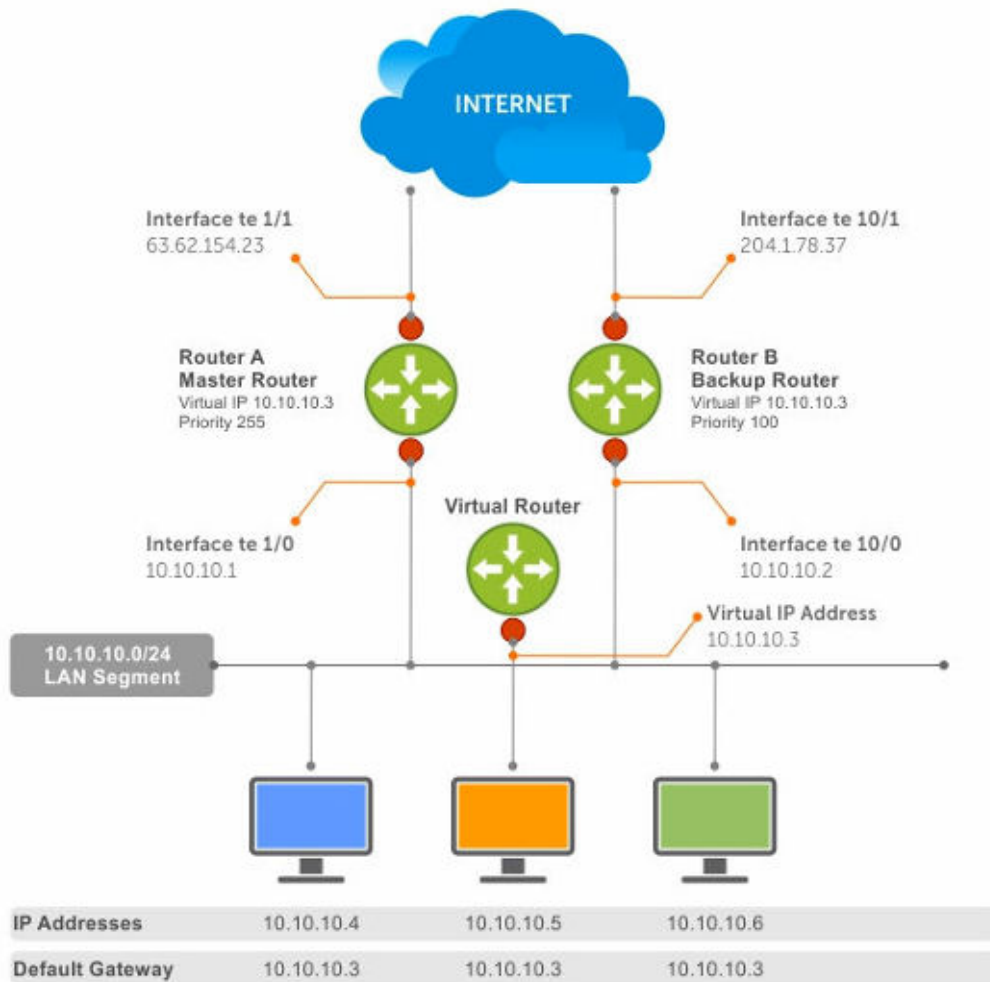

Figure 10. Object tracking

## Interface tracking

You can create an object that tracks the line-protocol state of an L2 interface, and monitors its operational up or down status. You can configure up to 500 objects. Each object is assigned a unique ID.

When the link-level status goes down, the tracked resource status is also considered Down. If the link-level status goes up, the tracked resource status is also considered Up. For logical interfaces such as port-channels or VLANs, the link-protocol status is considered Up if any physical interface under the logical interface is Up.

The list of available interfaces include:

- `ethernet` — Physical interface
- `port-channel` — Port-channel identifier
- `VLAN` — Virtual local area network (VLAN) identifier
- `Loopback` — Loopback interface identifier
- `mgmt` — Management interface

1. Configure object tracking in CONFIGURATION mode, from 1 to 500.

```
track object-id
```

2. (Optional) Enter interface object tracking on the line-protocol state of an L2 interface in OBJECT TRACKING mode.

```
interface interface line-protocol
```

3. (Optional) Configure the time delay used before communicating a change to the status of a tracked interface in OBJECT TRACKING mode, from 0 to 80 seconds; default 0.

```
delay [up seconds] [down seconds]
```

4. (Optional) View the tracked object information in EXEC mode.

```
show track object-id
```

5. (Optional) View all interface object information in EXEC mode.

```
show track interface
```

6. (Optional) View all IPv4 or IPv6 next-hop object information in EXEC mode.

```
show track [ip | ipv6]
```

7. (Optional) View brief status of object information in EXEC mode.

```
show track brief
```

### Configure object tracking

```
OS10(config)# track 1
OS10(conf-track-1)# interface ethernet 1/1/1 line-protocol
OS10(conf-track-1)# delay up 20
OS10(conf-track-1)# delay down 10
OS10(conf-track-1)# do show track 1
Interface ethernet1/1/1 line-protocol
Line protocol is UP
1 changes, Last change 2017-04-26T06:41:36Z
```

## Host tracking

If you configure an IP host as a tracked object, the entry or next-hop address in the ARP cache determines the Up or Down state of the route.

A tracked host is reachable if there is an ARP cache entry for the router's next-hop address. An attempt to regenerate the ARP cache entry occurs if the next-hop address appears before considering the route Down.

1. Configure object tracking in CONFIGURATION mode.

```
track object-id
```

2. Enter the host IP address for reachability of an IPv4 or IPv6 route in OBJECT TRACKING mode.

```
[ip | ipv6] host-ip-address reachability
```

3. Configure the time delay used before communicating a change in the status of a tracked route in OBJECT TRACKING mode.

```
delay [up seconds] [down seconds]
```

4. Track the host by checking the reachability periodically in OBJECT TRACKING mode.

```
reachability-refresh interval
```

5. View the tracking configuration and the tracked object status in EXEC mode.

```
show track object-id
```

### Configure IPv4 host tracking

```
OS10 (conf-track-1)# track 2
OS10 (conf-track-2)# ip 1.1.1.1 reachability
OS10 (conf-track-2)# do show track 2
IP Host 1.1.1.1 reachability
Reachability is DOWN
1 changes, Last change 2017-04-26T06:45:31Z
OS10 (conf-track-2)#
```

### Configure IPv6 host tracking

```
OS10 (conf-track-2)# track 3
OS10 (conf-track-3)# ipv6 20::20 reachability
OS10 (conf-track-3)# delay up 20
OS10 (conf-track-3)# do show track 3
IP Host 20::20 reachability
Reachability is DOWN
1 changes, Last change 2017-04-26T06:47:04Z
OS10 (conf-track-3)#
```

## Set tracking delays

You can configure an optional Up or Down timer for each tracked object. The timer allows you to set the time delay before a change in the state of a tracked object communicates to the clients. The time delay starts when the state changes from Up to Down or from Down to Up.

If the state of an object changes back to its former Up or Down state before the timer expires, the timer is canceled without notifying the client. If the timer expires and an object's state has changed, a notification is sent to the client. For example, if the Down timer is running and an interface goes down then comes back up, the Down timer is canceled. The client is not notified of the event.

If you do not configure a delay, a notification is sent when a change in the state of a tracked object is detected. The time delay in communicating a state change is specified in seconds.

## Object tracking

As a client, VRRP can track up to 20 interface objects plus 12 tracked interfaces supported for each VRRP group. You can assign a unique priority-cost value, from 1 to 254, to each tracked VRRP object or group interface.

If a tracked VRRP object is in a Down state, the priority cost is subtracted from the VRRP group priority. If a VRRP group router acts as owner-master, the run-time VRRP group priority remains fixed at 255. Changes in the state of a tracked object have no effect.

In VRRP object tracking, the sum of the priority costs for all tracked objects and interfaces cannot equal or exceed the priority of the VRRP group.

## View tracked objects

You can view the status of currently tracked L2 or L3 interfaces, or the IPv4 or IPv6 hosts.

### View brief object tracking information

```
OS10# show track brief
TrackID Resource Parameter Status LastChange

1 line-protocol ethernet1/1/1 DOWN
2017-02-03T08:41:25Z1
2 ipv4-reachablity 1.1.1.1 DOWN
2017-02-03T08:41:43Z1
3 ipv6-reachablity 10::10 DOWN
2017-02-03T08:41:55Z1
```

### View all object tracking information

```
OS10# show track
```

### View interface object tracking information

```
OS10# show track interface
TrackID Resource Parameter Status LastChange

1 line-protocol ethernet1/1/1 DOWN
2017-02-03T08:41:25Z1
OS10# show track ip
TrackID Resource Parameter Status LastChange

2 ipv4-reachablity 1.1.1.1 DOWN
2017-02-03T08:41:43Z1
OS10# show track ipv6
TrackID Resource Parameter Status LastChange

3 ipv6-reachablity 10::10 DOWN
2017-02-03T08:41:55Z1
```

### View IPv4 next-hop object tracking

```
OS10# show track ip
```

### View IPv6 next-hop object tracking

```
OS10# show track ipv6
```

### View running configuration

```
OS10# show running-configuration
```

## OTM commands

### delay

Configures the delay timers.

|                          |                                                                                      |
|--------------------------|--------------------------------------------------------------------------------------|
| <b>Syntax</b>            | <code>delay {up   down} seconds</code>                                               |
| <b>Parameters</b>        | <code>seconds</code> — Enter the delay time in seconds. A maximum of 180 characters. |
| <b>Defaults</b>          | Not configured                                                                       |
| <b>Command Mode</b>      | CONFIGURATION                                                                        |
| <b>Usage Information</b> | None                                                                                 |

**Example**

```
OS10(conf-track-100)# delay up 200 down 100
```

**Supported Releases**

10.3.0E or later

## interface line-protocol

Configures an object to track a specific interface's line-protocol status.

**Syntax** `interface interface line-protocol`

**Parameters** `interface` — Enter the interface information:

- `ethernet` — Physical interface.
- `port-channel` — Enter the port-channel identifier.
- `vlan` — Enter the VLAN identifier.
- `loopback` — Enter the Loopback interface identifier.
- `mgmt` — Enter the Management interface.

**Defaults** Not configured

**Command Mode** CONFIGURATION

**Usage Information** None

**Example**

```
OS10(conf-track-100)# interface ethernet line-protocol
```

**Supported Releases**

10.3.0E or later

## ip reachability

Configures an object to track a specific next-hop host's reachability.

**Syntax** `ip host-ip-address reachability`

**Parameters** `host-ip-address` — Enter the IPv4 host address.

**Defaults** Not configured

**Command Mode** CONFIGURATION

**Usage Information** None

**Example**

```
OS10(config)# track 100
OS10(conf-track-100)# ip 10.10.10.1 reachability
```

**Supported Releases**

10.3.0E or later

## ipv6 reachability

Configures an object to track a specific next-hop host's reachability.

**Syntax** `ipv6 host-ip-address reachability`

**Parameters** `host-ip-address` — Enter the IPv6 host address.

**Defaults** Not configured

**Command Mode** CONFIGURATION

**Usage Information** None

**Example**

```
OS10(config)# track 200
OS10(conf-track-200)# ipv6 10::1 reachability
```

**Supported Releases** 10.3.0E or later

## reachability-refresh

Configures a polling interval for reachability tracking.

**Syntax** `reachability-refresh interval`

**Parameters** `interval` — Enter the polling interval value. A maximum of 3600 seconds.

**Defaults** 0 seconds

**Command Mode** CONFIGURATION

**Usage Information** Set the interval to 0 to disable the refresh.

**Example**

```
OS10(conf-track-100)# reachability-refresh 600
```

**Supported Releases** 10.3.0E or later

## show track

Displays tracked object information.

**Syntax** `show track [brief] [object-id] [interface] [ip | ipv6]`

**Parameters**

- `brief` — (Optional) Displays brief tracked object information.
- `object-id` — (Optional) Displays tracked object information for a specific object ID.
- `interface` — (Optional) Displays all interface object information.
- `ip` — (Optional) Displays all IPv4 next-hop object information.
- `ipv6` — (Optional) Displays all IPv6 next-hop object information.

**Defaults** None

**Command Mode** CONFIGURATION

**Usage Information** None

**Example (Brief)**

```
OS10# show track brief
TrackID Resource Parameter Status LastChange

1 line-protocol ethernet1/1/1 DOWN
2017-02-03T08:41:25Z1
2 ipv4-reachablity 1.1.1.1 DOWN
2017-02-03T08:41:43Z1
3 ipv6-reachablity 10::10 DOWN
2017-02-03T08:41:55Z1
```

**Supported Releases** 10.3.0E or later



## track

Configures and manages tracked objects.

**Syntax** `track object-id`

**Parameters** `object-id` — Enter the object ID to track. A maximum of 500.

**Defaults** Not configured

**Command Mode** CONFIGURATION

**Usage Information** The `no` version of this command deletes the tracked object from an interface.

**Example**

```
OS10# track 100
```

**Supported Releases** 10.3.0E or later

## Policy-based routing

PBR provides a mechanism to redirect IPv4 and IPv6 data packets based on the policies defined to override the switch's forwarding decisions based on the routing table.

### Policy-based route-maps

A route-map is an ordered set of rules that controls the redistribution of IP routes into a protocol domain. When you enable PBR on an interface, all IPv4 or IPv6 data packets process based on the policies that you define in the route-maps. The rules defined in route-maps are based on access control lists (ACLs) and next-hop addresses, and only apply to ACLs used in policy-based routing.

You can create a route-map that specifies the match criteria and resulting action if all the match clauses are met. After you create the route-map, you can enable PBR for that route-map on a specific interface. Route-maps contain `match` and `set` statements that you can mark as *permit*.

### Access-list to match route-map

You can assign an IPv4 or IPv6 access-list to match a route-map. The IP access list contains the criteria to match the traffic content based on the header field, such as the destination IP or source IP.

When `permit` or `deny` is present in the `access-list`, it is omitted and the action present in the `route-map` command is used for policy-based routing. The `permit` keyword in the route-map statement indicates policy-based routing. The `deny` keyword in the route-map statement indicates a switch-based forwarding decision, a PBR exception. Only use access list for the packet match criteria in policy-based routing.

1. Assign an access-list to match the route-map in CONFIGURATION mode.

```
ip access-list access-list-name
```

2. Set the IP address to match the access-list in IP-ACL mode.

```
permit ip ip-address
```

#### Configure IPv4 access-list to match route-map

```
OS10(config)# ip access-list acl5
OS10(conf-ipv4-acl)# permit ip 10.10.10.0/24 any
```

### Configure IPv6 access-list to match route-map

```
OS10(config)# ipv6 access-list acl8
OS10(conf-ipv6-acl)# permit ipv6 10::10 any
```

## Set address to match route-map

You can set an IPv4 or IPv6 address to match a route-map.

1. Enter the IPv4 or IPv6 address to match and specify the access-list name in Route-Map mode.

```
match {ip | ipv6} address access-list-name
```

2. Set the next-hop IP address in Route-Map mode.

```
set {ip | ipv6} next-hop ip-address
```

### Apply match and set parameters to IPv4 route-map

```
OS10(conf-route-map)# route-map map1
OS10(conf-route-map)# match ip address acl5
OS10(conf-route-map)# set ip next-hop 10.10.10.10
```

### Apply match and set parameters to IPv6 route-map

```
OS10(conf-route-map)# route-map map1
OS10(conf-route-map)# match ipv6 address acl8
OS10(conf-route-map)# set ipv6 next-hop 20::20
```

## Assign route-map to interface

You can assign a route-map to an interface for IPv4 or IPv6 policy-based routing to an interface.

- Assign the IPv4 or IPv6 policy-based route-map to an interface in INTERFACE mode.

```
{ip | ipv6} policy route-map map-name
```

### Assign route-map to an IPv4 interface

```
OS10(config)# interface ethernet 1/1/5
OS10(conf-if-eth1/1/5)# ip policy route-map map1
```

### Assign route-map to an IPv6 interface

```
OS10(conf-if-eth1/1/5)# ipv6 policy route-map map2
```

## View PBR information

Display PBR information to verify IPv4 or IPv6 configuration and view statistics.

1. View IPv4 or IPv6 PBR policy information in EXEC mode.

```
show {ip | ipv6} policy name
```

2. View current PBR statistics in EXEC mode.

```
show route-map map-name pbr-statistics
```

3. Clear all policy statistics information in EXEC mode.

```
clear route-map map-name pbr-statistics
```

## Verify IPv4 PBR configuration

```
OS10# show ip policy abc
Interface Route-map

ethernet1/1/1 abc
ethernet1/1/3 abc
vlan100 abc
```

## Verify IPv6 PBR configuration

```
OS10# show ipv6 policy abc
Interface Route-map

ethernet1/1/1 abc
ethernet1/1/3 abc
vlan100 abc
```

## View current PBR statistics

```
show route-map pbr-sample pbr-statistics
route-map pbr-sample, permit, sequence 10

Policy routing matches: 84 packets
```

# Policy-based routing per VRF

Configure PBR per VRF instance for both IPv4 and IPv6 traffic flows.

Policy-based routing (PBR) enables packets with certain match criteria, such as packets from specific source and destination addresses, to be re-directed to a different next-hop.

You can also use PBR to re-direct packets arriving on a VRF instance to a next-hop that is reachable through a different VRF instance. You can re-direct packets arriving on any VRF instance to the default VRF instance or any other non-default VRF instance.

 **NOTE:** PBR is supported on the default and non-default VRF instances; however, PBR is not supported on the management VRF instance.

## Configuring PBR per VRF

For traffic arriving on a VRF instance, you can re-direct this traffic to a next-hop on another VRF instance using route-maps. In the route-map, set the next-hop IP address that is reachable through a different VRF instance. When traffic that matches certain criteria arrives on a VRF instance, the route-map configuration enables packets to be re-directed to a next-hop that is reachable over another VRF instance. To configure PBR per VRF:

1. Create the match ACL rule for IPv4 or IPv6 traffic.  
`{ip | ipv6} access-list access-list-name`
2. Permit or deny IPv4 or IPv6 traffic from any source with a specific destination.  
`permit {ip | ipv6} any ip-address`  
or  
`deny {ip | ipv6} any ip-address`
3. Configure a route-map to re-direct traffic arriving on a specific VRF instance.  
`route-map route-map-name`
4. Enter the IPv4 or IPv6 address to match and specify the access-list name.  
`match {ip | ipv6} address access-list-name`
5. In the route-map, set the IPv4 or IPv6 next-hop to be reached through a different VRF instance.  
`set {ip | ipv6} vrf vrf-name next-hop next-hop-ipv4address`  
This next-hop-address is reachable through a different VRF instance.

**NOTE:** If the next-hop is reachable on the specified VRF instance, the packet is redirected; otherwise, the packet follows the regular routing flow.

6. Apply the route-map to the interface.

```
interface interface-type
{ip | ipv6} policy route-map route-map-name
```

7. View the route-map information.

```
show route-map
```

```
OS10(conf-if-vl-40)# do show route-map
route-map test, permit, sequence 10
Match clauses:
ip address (access-lists): acl1
Set clauses:
ip vrf red next-hop 1.1.1.1 track-id 200
```

## PBR and VLT

When you configure PBR in a VLT setup, configure the same PBR rules on both VLT peers.

In the following example, traffic originates from A and is destined to B. The traffic is redirected to C using a PBR rule through the VLT port channel. When the VLT port channel interface goes down, the traffic still reaches C through VLTi.

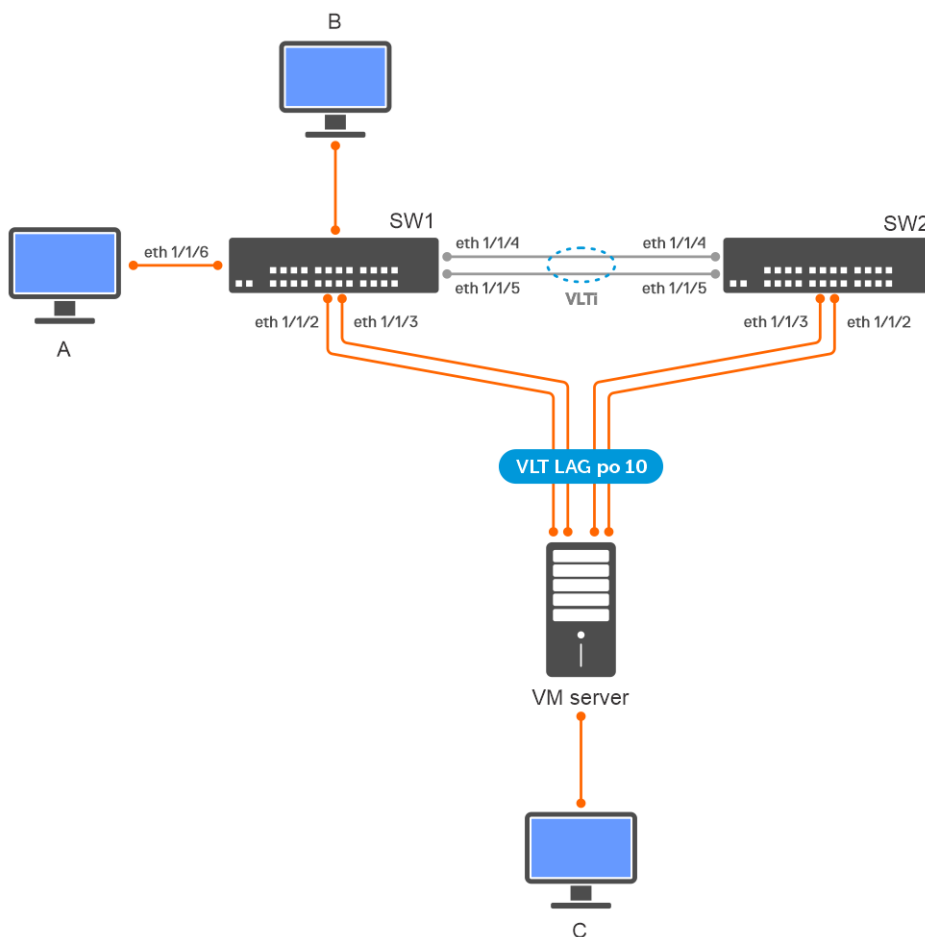

SW1

VLAN configuration

- Create a VLAN and assign an IP address to it which acts as the gateway for the hosts in the VM.

```
OS10# configure terminal
OS10(config)# interface vlan 100
OS10(config-if-vl-100)# no shutdown
OS10(config-if-vl-100)# ip address 10.1.1.1/24
OS10(config-if-vl-100)# exit
```

- Create another VLAN, and assign an IP address to it.

```
OS10# configure terminal
OS10(config)# interface vlan 200
OS10(config-if-vl-200)# no shutdown
OS10(config-if-vl-200)# ip address 10.2.1.1/24
OS10(config-if-vl-200)# exit
```

## VLT configuration

1. Create a VLT domain, and configure VLTi.

```
OS10(config)# interface range ethernet 1/1/4-1/1/5
OS10(config-range-eth1/1/4-1/1/5)# no switchport
OS10(config-range-eth1/1/4-1/1/5)# exit
OS10(config)# vlt-domain 1
OS10(config-vlt-1)# discovery-interface ethernet 1/1/4-1/1/5
```

2. Configure a VLT MAC address.

```
OS10(config-vlt-1)# vlt-mac 12:5e:23:2d:76:3e
```

3. Specify the management IP address of the VLT peer as a backup link.

```
OS10(config-vlt-1)# backup destination 10.10.10.2
```

4. Configure VLT port channels.

SW1-to-VM VLT port channel configuration

```
OS10(config)# interface port-channel 10
OS10(config-if-po-10)# description SW1ToVM
OS10(config-if-po-10)# vlt-port-channel 10
OS10(config-if-po-10)# switchport mode trunk
OS10(config-if-po-10)# switchport trunk allowed vlan 100,200
OS10(config-if-po-10)# exit
OS10(config)# interface range ethernet 1/1/2-1/1/3
OS10(config-if-eth1/1/2-1/1/3)# no shutdown
OS10(config-if-eth1/1/2-1/1/3)# channel-group 10
```

SW1-to-server configuration

```
OS10(config)# interface port-channel 20
OS10(config-if-po-20)# description SW1ToServer
OS10(config-if-po-20)# vlt-port-channel 20
OS10(config-if-po-20)# switchport mode trunk
OS10(config-if-po-20)# switchport trunk allowed vlan 100,200
OS10(config-if-po-20)# exit
OS10(config)# interface range ethernet 1/1/1,1/1/6
OS10(config-if-eth1/1/1,1/1/6)# no shutdown
OS10(config-if-eth1/1/1,1/1/6)# channel-group 20
```

## (Optional) Peer routing configuration

- Configure peer routing.

```
OS10(config)# vlt-domain 1
OS10(config-vlt-1)# peer-routing
```

## PBR configuration

Apply the policy on the traffic ingress interface and the VLTi interfaces of both VLT peers.

```
OS10(config)# ip access-list PBR-A2C
OS10(conf-ipv4-acl)# permit ip 10.10.10.0/24 any
OS10(conf-ipv4-acl)# exit
OS10(config)# route-map Map1
OS10(conf-route-map)# match ip address PBR-A2C
OS10(conf-route-map)# set ip next-hop 10.10.20.10
OS10(conf-route-map)# exit
OS10(config)# interface range ethernet 1/1/4-1/1/6
OS10(conf-if-eth1/1/4-1/1/6)# ip policy route-map Map1
```

## SW2

### VLAN configuration

- Create a VLAN and assign an IP address to it which acts as the gateway for the hosts in the VM.

```
OS10# configure terminal
OS10(config)# interface vlan 100
OS10(conf-if-vl-100)# no shutdown
OS10(conf-if-vl-100)# ip address
OS10(conf-if-vl-100)# ip address 10.1.1.2/24
OS10(conf-if-vl-100)# exit
```

- Create another VLAN, and assign an IP address to it.

```
OS10# configure terminal
OS10(config)# interface vlan 200
OS10(conf-if-vl-200)# no shutdown
OS10(conf-if-vl-200)# ip address
OS10(conf-if-vl-200)# ip address 10.2.1.3/24
OS10(conf-if-vl-200)# exit
```

### VLT configuration

1. Create a VLT domain, and configure VLTi.

```
OS10(config)# interface range ethernet 1/1/4-1/1/5
OS10(conf-range-eth1/1/4-1/1/5)# no switchport
OS10(conf-range-eth1/1/4-1/1/5)# exit
OS10(config)# vlt-domain 1
OS10(conf-vlt-1)# discovery-interface ethernet 1/1/4-1/1/5
```

2. Configure a VLT MAC address.

```
OS10(conf-vlt-1)# vlt-mac 12:5e:23:f4:23:54
```

3. Specify the management IP address of the VLT peer as a backup link.

```
OS10(conf-vlt-1)# backup destination 10.10.10.1
```

4. Configure VLT port channels.

SW2-to-VM VLT port channel configuration

```
OS10(config)# interface port-channel 10
OS10(conf-if-po-10)# description SW2ToVM
OS10(conf-if-po-10)# vlt-port-channel 10
OS10(conf-if-po-10)# switchport mode trunk
OS10(conf-if-po-10)# switchport trunk allowed vlan 100,200
OS10(conf-if-po-10)# exit
OS10(config)# interface range ethernet 1/1/2-1/1/3
OS10(conf-if-eth1/1/2-1/1/3)# no shutdown
OS10(conf-if-eth1/1/2-1/1/3)# channel-group 10
```

### ( Optional) Peer routing configuration

- Configure peer routing.

```
OS10(config)# vlt-domain 1
OS10(conf-vlt-1)# peer-routing
```

## PBR configuration

Apply the policy on the VLTi interfaces of both VLT peers.

```
OS10(config)# ip access-list PBR-A2C
OS10(conf-ipv4-acl)# permit ip 10.10.10.0/24 any
OS10(conf-route-map)# route-map Map1
OS10(conf-route-map)# match ip address PBR-A2C
OS10(conf-route-map)# set ip next-hop 10.10.20.10
OS10(conf-route-map)# exit
OS10(config)# interface ethernet 1/1/4-1/1/6
OS10(conf-if-eth1/1/4-1/1/6)# ip policy route-map Map1
```

## Sample configuration

Consider a scenario where traffic from source IP address 1.1.1.1 ingresses through VLAN40 that is part of VRF RED. The egress interface for this traffic is also on the same VRF RED with IP address 4.4.4.4, as shown.

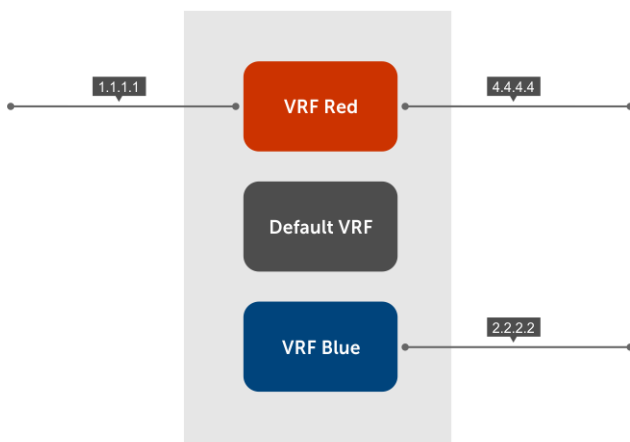

Using the following PBR configuration, you can re-direct traffic ingressing to VRF RED to a destination that is reachable through the next-hop IP address 2.2.2.2 in VRF BLUE:

1. Create a route-map.

```
OS10(config)# route-map test
```

2. Enter the IP address to match the specified access list.

```
OS10(config-route-map)# match ip 4.4.4.4 acl1
```

3. Set the next-hop address to 2.2.2.2, which is reachable through VRF BLUE.

```
OS10(config-route-map)#
 OS10(config-route-map)# set ip vrf BLUE next-hop 2.2.2.2
OS10(config-route-map)# exit
```

4. Apply this rule to the interface where the traffic ingresses, in this case VLAN40.

```
OS10(config)# interface vlan 40
OS10(conf-if-vl-40)#
OS10(conf-if-vl-40)# ip policy route-map test
```

5. (Optional) View the PBR configuration on the interface.

```
OS10(conf-if-vl-40)# show configuration
!
interface vlan40
no shutdown
ip policy route-map test
!
```

## Track route reachability

Track IPv4 or IPv6 reachability using object tracking. To configure tracking over the routes that are reachable through a VRF instance:

1. Configure object tracking.

```
track track-id
```

```
OS10(config)# track 200
```

2. Configure reachability of the next-hop address through the VRF instance.

```
ip ip-address reachablility vrf vrf-name
```

```
OS10(conf-track-200)#
OS10(conf-track-200)# ip 1.1.1.1 reachability vrf red
OS10(conf-track-200)#exit
```

3. Configure the route-map.

```
route-map route-map-name
```

```
OS10(config-route-map)#
OS10(config-route-map)# match ip address acl1
```

4. Set the track ID configured in step 1 to the route-map.

```
set ip vrf vrf-name nexy-hop next-hop-address track-id track-id-number
```

```
OS10(config-route-map)# set ip vrf red next-hop 1.1.1.1 track-id 200
```

5. Apply the route-map to the interface where traffic is ingressing on the VRF instance.

```
interface interface-type
```

```
ip policy route-map route-map-name
```

```
OS10(config)# interface vlan 40
OS10(conf-if-vl-40)#
OS10(conf-if-vl-40)# ip policy route-map test
OS10(conf-if-vl-40)# show configuration
!
```

**NOTE:** Ensure you configure next-hop IP address tracking and PBR next-hop with the same VRF instance. For next-hop reachability in the same VRF instance, you must configure both PBR per VRF and object tracking. Missing either the next-hop IP address tracking or PBR next-hop configuration in a VRF instance results in an erroneous configuration. However, the system does not display an error message indicating problems in the configuration.

## Use PBR to permit and block specific traffic

This section explains how to permit specific traffic through an interface using PBR.

### Configure the interface

1. Create a VLAN interface.

```
OS10(Config)# interface vlan999
```

2. Enable the interface.

```
OS10(Conf-if-999)# no shutdown
```

3. Enter an IP address to the interface.

```
OS10(Conf-if-999)# ip address 10.99.0.251/16
```

### Define the PBR parameters



- Create an ACL and define what should be enabled for PBR processing.

```
ip access-list TEST-ACL
seq 10 permit tcp any any eq 80
seq 20 permit tcp any any eq 443
seq 30 permit tcp any any eq 21
seq 40 permit icmp any any
```

- Create an ACL and define what should be excluded from PBR processing.

```
ip access-list TEST-ACL-DENY
seq 10 permit tcp 10.99.0.0/16 10.0.0.0/8 eq 80
seq 20 permit tcp 10.99.0.0/16 10.0.0.0/8 eq 443
seq 30 permit tcp 10.99.0.0/16 10.0.0.0/8 eq 21
seq 40 permit icmp 10.99.0.0/16 10.0.0.0/8
```

- Create a route-map to block specific traffic from PBR processing.

```
route-map TEST-RM deny 5
match ip address TEST-ACL-DENY
```

- Create a route-map to permit traffic for PBR processing.

```
route-map TEST-RM permit 10
match ip address TEST-ACL
set ip next-hop 10.0.40.235
```

- Apply the policy to the previously created interface.

```
ip policy route-map TEST-RM
```

**i** **NOTE:** In PBR, the permit or deny action specified in the access list does not determine whether the traffic is forwarded or dropped. The permit or deny action specified in the route-map configuration determines the results of PBR processing.

In this configuration, the `route-map TEST-RM deny 5` configuration blocks traffic that matches the `TEST-ACL-DENY` ACL from further PBR processing. This traffic is routed using the routing table. The `route-map TEST-RM permit 10` configuration sends traffic that matches the `TEST-ACL` ACL for PBR processing. Any packet that matches the `TEST-ACL` ACL is forwarded to 10.0.40.235.

## View PBR configuration

Use the `show configuration` command to view the configuration of the interface.

```
OS10(conf-if-vl-40)# show configuration
!
interface vlan40
no shutdown
ip policy route-map test
```

Use the `show route-map` command to view the route-map configuration.

```
OS10(config)# do show route-map
route-map map1, permit, sequence 10
Match clauses:
 ipv6 address (access-lists): acl1
Set clauses:
 ipv6 vrf {vrf-name} next-hop 5555::5556

OS10(conf-if-vl-40)# do show route-map
route-map test, permit, sequence 10
Match clauses:
 ip address (access-lists): acl1
Set clauses:
 ip next-hop 1.1.1.1 track-id 200

OS10(conf-if-vl-40)# do show route-map test
```

```
route-map test, permit, sequence 10
Match clauses:
ip address (access-lists): acl1
Set clauses:
ip vrf red next-hop 1.1.1.1 track-id 200
!
```

## PBR commands

### clear route-map pbr-statistics

Clears all PBR counters.

|                           |                                                                                         |
|---------------------------|-----------------------------------------------------------------------------------------|
| <b>Syntax</b>             | <code>clear route-map [map-name] pbr-statistics</code>                                  |
| <b>Parameters</b>         | <i>map-name</i> —Enter the name of a configured route-map. A maximum of 140 characters. |
| <b>Defaults</b>           | None                                                                                    |
| <b>Command Mode</b>       | EXEC                                                                                    |
| <b>Usage Information</b>  | None                                                                                    |
| <b>Example</b>            | <pre>OS10# clear route-map map1 pbr-statistics</pre>                                    |
| <b>Supported Releases</b> | 10.3.0E or later                                                                        |

### match address

Matches the access-list to the route-map.

|                           |                                                                             |
|---------------------------|-----------------------------------------------------------------------------|
| <b>Syntax</b>             | <code>match {ip   ipv6} address [name]</code>                               |
| <b>Parameters</b>         | <i>name</i> —Enter the name of an access-list. A maximum of 140 characters. |
| <b>Defaults</b>           | Not configured                                                              |
| <b>Command Mode</b>       | ROUTE-MAP                                                                   |
| <b>Usage Information</b>  | None                                                                        |
| <b>Example</b>            | <pre>OS10(conf-route-map)# match ip address acl1</pre>                      |
| <b>Supported Releases</b> | 10.3.0E or later                                                            |

### policy route-map

Assigns a route-map for IPv4 or IPv6 policy-based routing to the interface.

|                          |                                                                                         |
|--------------------------|-----------------------------------------------------------------------------------------|
| <b>Syntax</b>            | <code>{ip   ipv6} policy route-map [map-name]</code>                                    |
| <b>Parameters</b>        | <i>map-name</i> —Enter the name of a configured route-map. A maximum of 140 characters. |
| <b>Defaults</b>          | Not configured                                                                          |
| <b>Command Mode</b>      | INTERFACE                                                                               |
| <b>Usage Information</b> | None                                                                                    |

**Example**

```
OS10(config)# interface ethernet 1/1/1
OS10(conf-if-eth1/1/1)# ip policy route-map map1
```

**Supported Releases** 10.3.0E or later

## route-map pbr-statistics

Enables counters for PBR statistics.

**Syntax** `route-map [map-name] pbr-statistics`

**Parameters** `map-name`—Enter the name of a configured route-map. A maximum of 140 characters.

**Defaults** Not configured

**Command Mode** CONFIGURATION

**Usage Information** None

**Example**

```
OS10(config)# route-map map1 pbr-statistics
```

**Supported Releases** 10.3.0E or later

## set next-hop

Sets an IPv4 or IPv6 next-hop address for policy-based routing.

**Syntax** `set {ip | ipv6} vrf [vrf-name] next-hop address`

**Parameters**

- `vrf vrf-name` — Enter the keyword then the name of the VRF to make the next-hop reachable over that VRF.
- `address` — Enter the next-hop IPv4 or IPv6 address.

**Defaults** Not configured

**Command Mode** ROUTE-MAP

**Usage Information** You must configure next-hop IP address tracking and PBR next-hop with the same VRF instance. For next-hop reachability in the same VRF instance, you must configure both PBR per VRF and object tracking. Missing either the next-hop IP address tracking or PBR next-hop configuration in a VRF instance results in an erroneous configuration. However, the system does not display an error message indicating problems in the configuration.

The `set {ip | ipv6} next-hop` command supports multiple next-hop addresses for PBR route-map configuration. If you enter multiple next-hop entries for BGP route-map configuration or RTM route redistribution, the system uses only the first entry and ignores the rest of the entries.

**Example**

```
OS10(conf-route-map)# set ip next-hop 10.10.10.10
*Sets the next-hop IP address.
OS10(conf-route-map)#set ip vrf red next-hop 2.2.2.2
*The next-hop 2.2.2.2 should be reachable via interface over VRF "red".
```

**Supported Releases** 10.3.0E or later

## set next-hop track

Tracks the next-hop IPv4 or IPv6 address object.

|                           |                                                                                                                                                                                                                                                                                                                                                                                                                                                  |
|---------------------------|--------------------------------------------------------------------------------------------------------------------------------------------------------------------------------------------------------------------------------------------------------------------------------------------------------------------------------------------------------------------------------------------------------------------------------------------------|
| <b>Syntax</b>             | <code>set {ip   ipv6} vrf [vrf-name] next-hop address track track-id</code>                                                                                                                                                                                                                                                                                                                                                                      |
| <b>Parameters</b>         | <ul style="list-style-type: none"><li>• <code>address</code>—Enter an IPv4 or IPv6 address.</li><li>• <code>vrf vrf-name</code> — Enter the keyword then the name of the VRF to track the next-hop reachable through that VRF.</li><li>• <code>track-id</code>—(Optional) Enter the track ID of the PBR object.</li></ul>                                                                                                                        |
| <b>Defaults</b>           | Not configured                                                                                                                                                                                                                                                                                                                                                                                                                                   |
| <b>Command Mode</b>       | ROUTE-MAP                                                                                                                                                                                                                                                                                                                                                                                                                                        |
| <b>Usage Information</b>  | You must configure next-hop IP address tracking and PBR next-hop with the same VRF instance. For next-hop reachability in the same VRF instance, you must configure both PBR per VRF and object tracking. Missing either the next-hop IP address tracking or PBR next-hop configuration in a VRF instance results in an erroneous configuration. However, the system does not display an error message indicating problems in the configuration. |
| <b>Example</b>            | <pre>OS10(conf-route-map)# set ip next-hop 10.10.10.10 track-id 12 *Set the track ID configured to the route-map. OS10(conf-route-map)# set ip vrf red next-hop 1.1.1.1 track-id 200 *Sets the track ID configured to track the next-hop reachable through the VRF specified.</pre>                                                                                                                                                              |
| <b>Supported Releases</b> | 10.3.0E or later                                                                                                                                                                                                                                                                                                                                                                                                                                 |

## show policy

Displays policy information.

|                           |                                                                                                           |
|---------------------------|-----------------------------------------------------------------------------------------------------------|
| <b>Syntax</b>             | <code>show {ip   ipv6} policy [map-name]</code>                                                           |
| <b>Parameters</b>         | <code>map-name</code> — (Optional) Enter the name of a configured route map. A maximum of 140 characters. |
| <b>Defaults</b>           | None                                                                                                      |
| <b>Command Mode</b>       | EXEC                                                                                                      |
| <b>Usage Information</b>  | None                                                                                                      |
| <b>Example</b>            | <pre>OS10# show ip policy map-name</pre>                                                                  |
| <b>Supported Releases</b> | 10.3.0E or later                                                                                          |

## show route-map pbr-statistics

Displays the current PBR statistics.

|                          |                                                                                                           |
|--------------------------|-----------------------------------------------------------------------------------------------------------|
| <b>Syntax</b>            | <code>show route-map [map-name] pbr-statistics</code>                                                     |
| <b>Parameters</b>        | <code>map-name</code> — (Optional) Enter the name of a configured route map. A maximum of 140 characters. |
| <b>Defaults</b>          | None                                                                                                      |
| <b>Command Mode</b>      | EXEC                                                                                                      |
| <b>Usage Information</b> | None                                                                                                      |

## Example

```
OS10# show route-map map1 pbr-statistics
```

**Supported Releases** 10.3.0E or later

# Virtual Router Redundancy Protocol

VRRP allows you to form virtual routers from groups of physical routers on your local area network (LAN). These virtual routing platforms—master and backup pairs—provide redundancy during hardware failure. VRRP also allows you to easily configure a virtual router as the default gateway to all your hosts. It also avoids the single point of failure of a physical router.

VRRP:

- Provides a virtual default routing platform
- Provides load balancing
- Supports multiple logical IP subnets on a single LAN segment
- Enables simple traffic routing without the single point of failure of a static default route
- Avoids issues with dynamic routing and discovery protocols
- Takes over a failed default router:
  - Within a few seconds
  - With a minimum of VRRP traffic
  - Without any interaction from hosts

**NOTE:** The default behavior of VRRP is active-active. If you do not want the VRRP backup gateway to forward traffic on behalf of the active VRRP gateway in a non-VLT setup, use the `no vrrp mode active-active` command to disable the VRRP active-active feature.

**NOTE:** When an IPv6 VRRP group and OSPFv3 are configured on the same interface, OSPFv3 does not converge on that interface. For OSPFv3 convergence to happen on that interface, configure a static IPv6 neighbor entry on the VLAN interface with the peer link-local IPv6 address and MAC address. To configure a static IPv6 neighbor entry with the peer link-local IPv6 address and MAC address, use the `ipv6 neighbor` command.

## Configuration notes

All Dell EMC PowerSwitches except MX-Series, S4200-Series, S5200 Series, and Z9332F-ON:

Priority 255 is not supported.

## Configuration

VRRP specifies a master, or active, router that owns the next-hop IP and MAC address for end stations on a LAN. The master router is chosen from the virtual routers by an election process and forwards packets sent to the next-hop IP address. If the master router fails, VRRP begins the election process to choose a new master router which continues routing traffic.

VRRP packets transmit with the virtual router MAC address as the source MAC address. The virtual router MAC address associated with a virtual router is in `00:00:5E:00:01:{VRID}` format for IPv4 and `00:00:5E:00:02:{VRID}` format for IPv6. The VRID is the virtual router identifier that allows up to 255 IPv4 and IPv6 VRRP routers on a network. The first four octets are unquenchable, the last two octets are `01:{VRID}` for IPv4 and `02:{VRID}` for IPv6. The final octet changes depending on the VRRP virtual router identifier.

## Basic VRRP Configuration

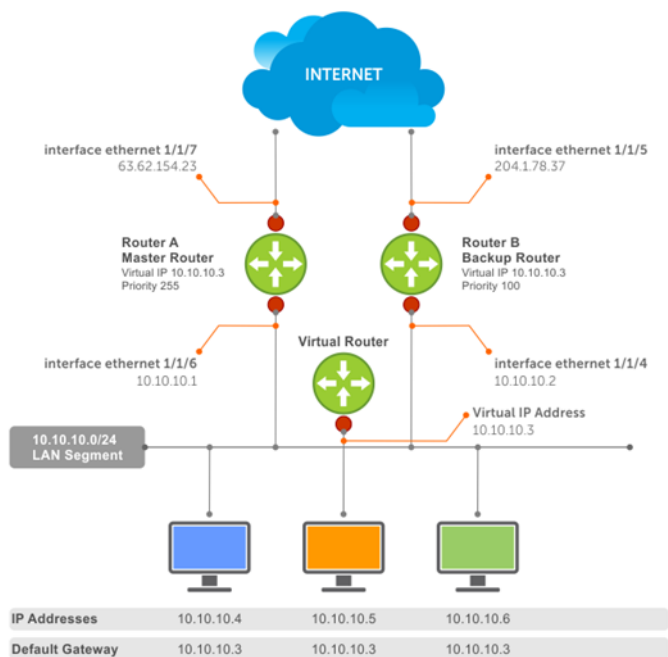

The example shows a typical network configuration using VRRP. Instead of configuring the hosts on network 10.10.10.0 with the IP address of either Router A or Router B as the default router, the default router of all hosts is set to the IP address of the virtual router. When any host on the LAN segment requests Internet access, it sends packets to the IP address of the virtual router.

Router A is configured as the master router with the virtual router IP address and sends any packets addressed to the virtual router to the Internet. Router B is the backup router and is also configured with the virtual router IP address.

If Router A, the master router, becomes unavailable (the connection between the LAN segment and Router A on ethernet 1/1/6 goes down), Router B, the backup router, automatically becomes the master router and responds to packets sent to the virtual IP address. All workstations continue to use the IP address of the virtual router to transmit packets destined to the Internet. Router B receives and forwards packets on interface ethernet 1/1/5. Until Router A resumes operation, VRRP allows Router B to provide uninterrupted service to the users on the LAN segment accessing the Internet.

When the interface that Router A uses to provide gateway services (ethernet 1/1/7) goes down, Router B does not take over automatically. For Router B to become the master router, you must configure interface tracking. When you configure tracking on the interface and the interface goes down, the VRRP group's priority decreases. The lowered priority of the VRRP group triggers an election and Router B becomes the master router. See [Interface/object tracking](#) for more information.

## Create virtual router

VRRP uses the VRID to identify each virtual router configured. Before using VRRP, you must configure the interface with the primary IP address and enable it.

- Create a virtual router for the interface with the VRRP identifier in INTERFACE mode, from 1 to 255.

```
vrrp-group vrrp-id
```

- Delete a VRRP group in INTERFACE mode.

```
no vrrp-group vrrp-id
```

### Configure VRRP

```
OS10(config)# interface ethernet 1/1/5
OS10(conf-if-eth1/1/5)# vrrp-group 254
```

### Verify VRRP

```
OS10(conf-eth1/1/5-vrid-254)# do show running-configuration
...
!
```

```
interface ethernet 1/1/5
ip address 10.10.10.1/24
!
vrrp-group 254
no shutdown
...
```

## Group version

Configure a VRRP version for the system. Define either VRRPv2 — `vrrp version 2` or VRRPv3 — `vrrp version 3`.

- Configure the VRRP version for IPv4 in INTERFACE mode.

```
vrrp version
```

### Configure VRRP version 3

```
OS10(config)# vrrp version 3
```

1. Set the switch with the lowest priority to `vrrp version 2`.
2. Set the switch with the highest priority to `vrrp version 3`.
3. Set all switches from `vrrp version 2` to `vrrp version 3`.

### Migrate IPv4 group from VRRPv2 to VRRPv3

```
OS10_backup_switch1(config)# vrrp version 2
OS10_backup_switch2(config)# vrrp version 2
```

### Set master switch to VRRPv3

```
OS10_master_switch(config)# vrrp version 3
```

### Set backup switches to VRRPv3

```
OS10_backup_switch1(config)# vrrp version 3
OS10_backup_switch2(config)# vrrp version 3
```

## Virtual IP addresses

Virtual routers contain virtual IP addresses configured for that VRRP group (VRID). A VRRP group does not transmit VRRP packets until you assign the virtual IP address to the VRRP group.

To activate a VRRP group on an interface, configure at least one virtual IP address for a VRRP group. The virtual IP address is the IP address of the virtual router and does not require an IP address mask. You can configure up to 10 virtual IP addresses on a single VRRP group (VRID).

These rules apply to virtual IP addresses:

- The virtual IP addresses must be in the same subnet as the primary or secondary IP addresses configured on the interface. Though a single VRRP group can contain virtual IP addresses belonging to multiple IP subnets configured on the interface, Dell EMC recommends configuring virtual IP addresses belonging to the same IP subnet for any one VRRP group. An interface on which you enable VRRP contains a primary IP address of 50.1.1.1/24 and a secondary IP address of 60.1.1.1/24. The VRRP group (VRID 1) must contain virtual addresses belonging to subnet 50.1.1.0/24 or subnet 60.1.1.0/24.
- If you configure multiple VRRP groups on an interface, only one of the VRRP groups can contain the interface primary or secondary IP address.

 **NOTE:** OS10 does not support configuring the virtual IP address to be the same as the primary or secondary IP address of the interface. Priority 255 is not supported.

## Configure virtual IP address

Configure the virtual IP address — the primary IP address and the virtual IP addresses must be on the same subnet.

1. Configure a VRRP group in INTERFACE mode, from 1 to 255.

```
vrrp-group vrrp-id
```

2. Configure virtual IP addresses for this VRRP ID in INTERFACE-VRRP mode. A maximum of 10 IP addresses.

```
virtual-address ip-address1 [...ip-address10]
```

### Configure virtual IP address

```
OS10(config)# interface ethernet 1/1/1
OS10(conf-if-eth1/1/1)# no switchport
OS10(conf-if-eth1/1/1)# ip address 10.1.1.1/24
OS10(conf-if-eth1/1/1)# vrrp-group 10
OS10(conf-eth1/1/1-vrid-10)# virtual-address 10.1.1.8
```

### Verify virtual IP address

```
OS10# show running-configuration
! Version 10.1.9999P.2281
! Last configuration change at Jul 26 12:01:58 2016
!
aaa authentication system:local
!
interface ethernet1/1/1
 ip address 10.1.1.1/24
 no switchport
 no shutdown
!
 vrrp-group 10
 virtual-address 10.1.1.8
!
interface ethernet1/1/2
 switchport access vlan 1
 no shutdown
!
interface ethernet1/1/3
 switchport access vlan 1
 no shutdown
!
interface ethernet1/1/4
 switchport access vlan 1
--more--
```

### View VRRP information

When the VRRP process completes initialization, the State field contains either `master` or `backup`.

```
OS10# show vrrp brief
Interface Group Priority Preemption State Master-addr Virtual addr(s)

ethernet1/1/1 IPv4 10 100 true master 10.1.1.8 10.1.1.8
```

### View VRRP group 1

```
OS10# show vrrp 1
Interface : ethernet1/1/1 IPv4 VRID : 1
Primary IP Address : 10.1.1.1 State : master-state
Virtual MAC Address : 00:00:5e:00:01:01
Version : version-3 Priority : 100
Preempt : Hold-time :
Authentication : no-authentication
Virtual IP address :
10.1.1.1
master-transitions : 1 advertise-rcvd : 0
advertise-interval-errors : 0 ip-ttl-errors : 0
priority-zero-pkts-rcvd : 0 priority-zero-pkts-sent : 0
invalid-type-pkts-rcvd : 0 address-list-errors : 0
pkt-length-errors : 0
```



## Configure virtual IP address in a VRF

You can configure a VRRP group in a non-default VRF instance and assign a virtual address to this group.

To configure VRRP under a specific VRF:

1. Create the non-default VRF in which you want to configure VRRP.

```
ip vrf vrf-name
CONFIGURATION Mode
```

2. In the VRF Configuration mode, enter the desired interface.

```
interface interface-id
VRF CONFIGURATION Mode
```

3. Remove the interface from L2 switching mode.

```
no switchport
INTERFACE CONFIGURATION Mode
```

4. Assign the interface to the non-default VRF that you have created.

```
ip vrf forwarding vrf-name
INTERFACE CONFIGURATION Mode
```

5. Assign an IP address to the interface.

```
ip address ip-address
INTERFACE CONFIGURATION Mode
```

6. Configure a VRRP group.

```
vrrp-group group-id
INTERFACE CONFIGURATION Mode
```

7. Configure virtual IP address for the VRRP ID.

```
virtual-address ip-address
INTERFACE VRRP Mode
```

```
OS10(config)# ip vrf vrf-test
OS10(config-vrf)# interface ethernet 1/1/1
OS10(conf-if-eth1/1/1)# no switchport
OS10(conf-if-eth1/1/1)# ip vrf forwarding vrf-test
OS10(conf-if-eth1/1/1)# ip address 10.1.1.1/24
OS10(conf-if-eth1/1/1)# vrrp-group 10
OS10(conf-eth1/1/1-vrid-10)# virtual-address 10.1.1.8
```

Before removing an interface from a VRF, delete the configured VRRP groups from the interface associated with the VRF. If you do not delete the configured VRRP groups, these groups remain active on the default VRF resulting in duplicate virtual IP address configurations.

## Set group priority

The router that has the highest primary IP address of the interface becomes the *master*. The default priority for a virtual router is 100. If the master router fails, VRRP begins the election process to choose a new master router based on the next-highest priority. The virtual router priority is automatically set to 255, if any of the configured virtual IP addresses matches the interface IP address.

1. Create a virtual router for the interface with the VRRP identifier in INTERFACE mode, from 1 to 255.

```
vrrp-group vrrp-id
```

2. Configure the priority number for the VRRP group in INTERFACE-VRRP mode, from 1 to 254, default 100.

```
priority number
```

## Set VRRP group priority

```
OS10(config)# interface ethernet 1/1/5
OS10(conf-if-eth1/1/5)# vrrp-group 254
OS10(conf-eth1/1/5-vrid-254)# priority 200
```

## Verify VRRP group priority

```
OS10(conf-eth1/1/5-vrid-254)# do show vrrp 254

Interface : ethernet1/1/5 IPv4 VRID : 254
Primary IP Address : 10.1.1.1 State : master-state
Virtual MAC Address : 00:00:5e:00:01:01
Version : version-3 Priority : 200
Preempt : Hold-time :
Authentication : no-authentication
Virtual IP address :
10.1.1.1
master-transitions : 1 advertise-rcvd : 0
advertise-interval-errors : 0 ip-ttl-errors : 0
priority-zero-pkts-rcvd : 0 priority-zero-pkts-sent : 0
invalid-type-pkts-rcvd : 0 address-list-errors : 0
pkt-length-errors : 0
```

## Authentication

Simple authentication of VRRP packets ensures that only trusted routers participate in VRRP processes. When you enable authentication, OS10 includes the password in its VRRP transmission. The receiving router uses that password to verify the transmission.

You must configure all virtual routers in the VRRP group with the same password. You must enable authentication with the same password or authentication is disabled. Authentication for VRRPv3 is not supported.

1. Create a virtual router for the interface with the VRRP identifier in INTERFACE mode, from 1 to 255.

```
vrrp-group vrrp-id
```

2. Configure a simple text password in INTERFACE-VRRP mode.

```
authentication-type simple-text text
```

`simple-text text` — Enter the keyword and a simple text password.

 **NOTE:** The system does not support a simple text password that begins with the ! or # character. Ensure that the password does not begin with either of these characters.

## Configure VRRP authentication

```
OS10(config)# interface ethernet 1/1/5
OS10(conf-if-eth1/1/5)# vrrp-group 250
OS10(conf-eth1/1/5-vrid-250)# authentication simple-text eureka
```

## Verify VRRP authentication configuration

```
OS10(config)# interface ethernet 1/1/1
OS10(conf-if-eth1/1/1)# vrrp-group 1
OS10(conf-eth1/1/1-vrid-1)# authentication simple-text dell
```

## Disable preempt

Prevent the Backup router with the higher priority from becoming the master router by disabling the preemption process. The `preempt` command is enabled by default. The command forces the system to change the master router if another router with a higher priority comes online.

You must configure all virtual routers in the VRRP group with the same settings. Configure all routers with preempt enabled or configure all with preempt disabled.

1. Create a virtual router for the interface with the VRRP identifier in INTERFACE mode, from 1 to 255.

```
vrrp-group vrrp-id
```

2. Prevent any backup router with a higher priority from becoming the Master router in INTERFACE-VRRP mode.

```
no preempt
```

### Disable preempt

```
OS10(config)# interface ethernet 1/1/5
OS10(conf-if-eth1/1/5)# vrrp-group 254
OS10(conf-eth1/1/5-vrid-254)# no preempt
```

### View running configuration

```
OS10(conf-eth1/1/5-vrid-254)# do show running-configuration
! Version 10.2.0E
! Last configuration change at Sep 24
07:17:45 2016
!
debug radius false
snmp-server contact http://www.dell.com/support/softwarecontacts
snmp-server location "United States"
username admin password 6q9QBeYjZ$jfzxVqGhkxX3smxJSH9DDz7/30Jc6m5wjF8nnLD7/
VKx8SloIhp4NoGZs0I/UNwh8WVuxwfd9q4pWIGNs5BKH.
aaa authentication system:local
!
interface ethernet1/1/5
 ip address 1.1.1.1/16
 no switchport
 no shutdown
!
vrrp-group 254
 priority 125
 virtual-address 1.1.1.3
 no preempt
!
```

## Advertisement interval

By default, the master router transmits a VRRP advertisement to all members of the VRRP group every one second, indicating it is operational and is the master router.

If the VRRP group misses three consecutive advertisements, the election process begins and the backup virtual router with the highest priority transitions to master. To avoid throttling VRRP advertisement packets, Dell EMC recommends increasing the VRRP advertisement interval to a value higher than the default value of one second. If you change the time interval between VRRP advertisements on one router, change it on all participating routers.

If you configure VRRP version 2, you must configure the timer values in multiple of whole seconds. For example, a timer value of 3 seconds or 300 centiseconds is valid and equivalent. A time value of 50 centiseconds is invalid because it not a multiple of 1 second. If you are using VRRP version 3, you must configure the timer values in multiples of 25 centiseconds. A centiseconds is 1/100 of a second.

- Create a virtual router for the interface with the VRRP identifier in INTERFACE mode, from 1 to 255.

```
vrrp-group vrrp-id
```

- For VRRPv2, change the advertisement interval setting in seconds in INTERFACE-VRRP mode, from 1 to 255, default 1.

```
advertise-interval seconds
```

- For VRRPv3, change the advertisement centiseconds interval setting INTERFACE-VRRP mode, from 25 to 4075, default 100.

```
advertise-interval centiseconds centiseconds
```

## Change advertisement interval

```
OS10(config)# interface ethernet 1/1/1
OS10(conf-if-eth1/1/1)# vrrp-group 1
OS10(conf-eth1/1/1-vrid-1)# advertise-interval centisecs 200
```

## View running configuration

```
OS10(conf-eth1/1/1-vrid-1)# do show running-configuration

! Version 10.1.9999P.2281
! Last configuration change at Jul 26 12:22:33 2016
!
aaa authentication system:local
!
interface ethernet1/1/1
 ip address 10.1.1.1/16
 no switchport
 no shutdown
!
vrrp-group 1
 advertisement-interval centisecs 200
 priority 200
 virtual-address 10.1.1.1
!
interface ethernet1/1/2
 switchport access vlan 1
 no shutdown
```

## Interface/object tracking

You can monitor the state of any interface according to the virtual group. OS10 supports a maximum of 10 track groups and each track group can track only one interface.

If the tracked interface goes down, the VRRP group's priority decreases by a default value of 10 — also known as *cost*. If the tracked interface's state goes up, the VRRP group's priority increases by the priority cost.

The lowered priority of the VRRP group may trigger an election. As the master/backup VRRP routers are selected based on the VRRP group's priority, tracking features ensure that the best VRRP router is the master for that group. The priority cost of the tracking group must be less than the configured priority of the VRRP group. If you configure the VRRP group as the owner router with a priority 255, tracking for that group is disabled, regardless of the state of the tracked interfaces. The priority of the owner group always remains 255.

For a virtual group, track the line-protocol state of any interface using the `interface` command. Enter an interface type and `node/slot/port[:subport]` information, or VLAN number:

- `ethernet` — Physical interface, from 1 to 48
- `vlan` — VLAN interface, from 1 to 4093

For a virtual group, track the status of a configured object using the `track` command and the object number. You can also configure a tracked object for a VRRP group with this command before you create the tracked object. No changes in the VRRP group's priority occur until the tracked object is determined to be down.

## Configure tracking

To track the object in a VRRP group, use the following commands:

1. Assign an object tracking unique ID number in CONFIGURATION mode, from 1 to 500.

```
track track-id
```

2. Monitor an interface in Track CONFIGURATION mode.

```
interface ethernet node/slot/port[:subport]
```

## Configure interface tracking

```
OS10(config)# track 10
OS10(conf-track-10)# interface ethernet 1/1/7 line-protocol
```

## View running configuration

```
OS10(conf-track-10)# do show running-configuration

! Version 10.1.9999P.2281
! Last configuration change at Jul 27 03:24:01 2016
!
aaa authentication system:local
!
interface ethernet1/1/1
 ip address 10.1.1.1/16
 no switchport
 no shutdown
!
 vrrp-group 1
 priority 200
 virtual-address 10.1.1.1
!
interface ethernet1/1/2
 switchport access vlan 1
 no shutdown
!
interface ethernet1/1/3
 switchport access vlan 1
 no shutdown
!
interface ethernet1/1/4
 switchport access vlan 1
 no shutdown
!
interface ethernet1/1/5
 switchport access vlan 1
 no shutdown
!
interface ethernet1/1/6
 switchport access vlan 1
 no shutdown
!
.....
.....
interface vlan1
 no shutdown
!
interface mgmt1/1/1
 no shutdown
!
support-assist
!
track 10
 interface ethernet1/1/7 line-protocol
```

To associate a track object with a VRRP group, use the `track` command inside VRRP GROUP CONFIGURATION mode.

## VRRP commands

### advertise-interval

Sets the time interval between VRRP advertisements.

**Syntax** `advertise-interval [seconds | centisecs centisecs]`

**Parameters**

- `seconds` — Set the advertise interval in seconds, from 1 to 255.

- `centisecs centisecs` — (Optional) Enter a value in multiples of 25, from 25 to 4075.

**Default** 1 second or 100 centisecs

**Command Mode** INTERFACE-VRRP

**Usage Information** Dell EMC recommends keeping the default setting for this command. If you change the time interval between VRRP advertisements on one router, change it on all routers. The `no` version of this command sets the VRRP advertisements timer interval back to its default value, 1 second or 100 centisecs.

**Example**

```
OS10(conf-eth1/1/6-vrid-250)# advertise-interval 120 centisecs 100
```

**Supported Releases** 10.2.0E or later

## authentication-type

Enables authentication of VRRP data exchanges.

**Syntax** `authentication-type simple-text password`

**Parameters** `simple-text password` — Enter a simple text password.

**Default** Disabled

**Command Mode** INTERFACE-VRRP

**Usage Information** With authentication enabled, OS10 ensures that only trusted routers participate in routing in an autonomous network. The `no` version of this command disables authentication of VRRP data exchanges.

**Example**

```
OS10(conf-ethernet1/1/6-vrid-250)# authentication simple-text eureka
```

**Supported Releases** 10.2.0E or later

## preempt

Permits or preempts a backup router with a higher priority value to become the master router.

**Syntax** `preempt`

**Parameters** None

**Default** Enabled

**Command Mode** INTERFACE-VRRP

**Usage Information** VRRP uses `preempt` to determine what happens after a VRRP backup router becomes the master. With `preempt` enabled by default, VRRP switches to a backup if that backup router comes online with a priority higher than the new master router. If you disable `preempt`, VRRP switches only if the master fails. The `no` version of this command disables preemption.

**Example**

```
OS10(conf-eth1/1/5-vrid-254)# preempt
```

**Supported Releases** 10.2.0E or later

## priority

Assigns a VRRP priority value for the VRRP group. The VRRP uses this value during the master election process.

**Syntax** `priority number`

|                           |                                                                                                                                                                                                                                                            |
|---------------------------|------------------------------------------------------------------------------------------------------------------------------------------------------------------------------------------------------------------------------------------------------------|
| <b>Parameters</b>         | <i>number</i> — Enter a priority value, from 1 to 254.                                                                                                                                                                                                     |
| <b>Default</b>            | 100                                                                                                                                                                                                                                                        |
| <b>Command Mode</b>       | INTERFACE-VRRP                                                                                                                                                                                                                                             |
| <b>Usage Information</b>  | To guarantee that a VRRP group becomes master, configure the priority of the VRRP group to the 254, which is the highest priority. OS10 does not support priority 255. The <code>no</code> version of this command resets the value to the default of 100. |
| <b>Example</b>            | <pre>OS10 (conf-eth1/1/5-vrid-254)# priority 200</pre>                                                                                                                                                                                                     |
| <b>Supported Releases</b> | 10.2.0E or later                                                                                                                                                                                                                                           |

## show vrrp

Displays VRRP group information.

|                           |                                                                                                                                                                                                                                                                                                                                                                                                                                                                                                                                                                                                    |
|---------------------------|----------------------------------------------------------------------------------------------------------------------------------------------------------------------------------------------------------------------------------------------------------------------------------------------------------------------------------------------------------------------------------------------------------------------------------------------------------------------------------------------------------------------------------------------------------------------------------------------------|
| <b>Syntax</b>             | <code>show vrrp [vrf <i>vrf-name</i>] {brief   <i>vrrp-id</i>   ipv6 <i>group-id</i>}</code>                                                                                                                                                                                                                                                                                                                                                                                                                                                                                                       |
| <b>Parameters</b>         | <ul style="list-style-type: none"> <li>• <code>vrf <i>vrf-name</i></code> — Displays the VRRP group information corresponding to the specified VRF.</li> <li>• <code>brief</code> — Displays the configuration information for all VRRP instances in the system.</li> <li>• <code><i>vrrp-id</i></code> — Enter a VRRP group ID number to view the VRRP IPv4 group operational status information, from 1 to 255.</li> <li>• <code>ipv6 <i>group-id</i></code> — (Optional) Enter a VRRP group ID number to view the specific IPv6 group operational status information, from 1 to 255.</li> </ul> |
| <b>Default</b>            | All IPv4 VRRP group configuration                                                                                                                                                                                                                                                                                                                                                                                                                                                                                                                                                                  |
| <b>Command Mode</b>       | EXEC                                                                                                                                                                                                                                                                                                                                                                                                                                                                                                                                                                                               |
| <b>Usage Information</b>  | Displays all active VRRP groups. If no VRRP groups are active, the system displays <code>No Active VRRP group</code> .                                                                                                                                                                                                                                                                                                                                                                                                                                                                             |
| <b>Example (Brief)</b>    | <pre>OS10 # show vrrp brief Interface      Group Priority Preemption State      Master-addr Virtual addr(s) ----- ethernet1/1/1 1      200      true      master-state 10.1.1.1  10.1.1.1</pre>                                                                                                                                                                                                                                                                                                                                                                                                    |
| <b>Example (IPv6)</b>     | <pre>OS10 # show vrrp ipv6 1 Interface : ethernet1/1/1      IPv6 VRID : 1 Primary IP Address : 10::1      State : master-state Virtual MAC Address : 00:00:5e:00:02:01 Version : version-3      Priority : 200 Preempt :      Hold-time : Authentication : no-authentication Virtual IP address : 10::1 master-transitions : 1      advertise-rcvd : 0 advertise-interval-errors : 0      ip-ttl-errors : 0 priority-zero-pkts-rcvd : 0      priority-zero-pkts-sent : 0 invalid-type-pkts-rcvd : 0      address-list-errors : 0 pkt-length-errors : 0</pre>                                       |
| <b>Supported Releases</b> | 10.2.0E or later                                                                                                                                                                                                                                                                                                                                                                                                                                                                                                                                                                                   |

## track

Assigns a unique identifier to track an object.

|                                |                                                                                                                                                                                                                                                                                                                                                                                     |
|--------------------------------|-------------------------------------------------------------------------------------------------------------------------------------------------------------------------------------------------------------------------------------------------------------------------------------------------------------------------------------------------------------------------------------|
| <b>Syntax</b>                  | <code>track track-id [priority cost [value]]</code>                                                                                                                                                                                                                                                                                                                                 |
| <b>Parameters</b>              | <ul style="list-style-type: none"><li>• <code>track-id</code> — Enter the object tracking resource ID number, from 1 to 500.</li><li>• <code>priority cost value</code> — (Optional) Enter a cost value to subtract from the priority value, from 1 to 254.</li></ul>                                                                                                               |
| <b>Default</b>                 | 10                                                                                                                                                                                                                                                                                                                                                                                  |
| <b>Command Mode</b>            | INTERFACE-VRRP                                                                                                                                                                                                                                                                                                                                                                      |
| <b>Usage Information</b>       | If you disable the interface, the cost value subtracts from the priority value and forces a new master election. This election process is applicable when the priority value is lower than the priority value in the backup virtual router. You can associate only one track object with a VRRP group. The <code>no</code> version of this command resets the value to the default. |
| <b>Example</b>                 | <pre>OS10(config-eth1/1/5-vrid-254)# track 400</pre>                                                                                                                                                                                                                                                                                                                                |
| <b>Example (Priority Cost)</b> | <pre>OS10(config-eth1/1/5-vrid-254)# track 400 priority-cost 20</pre>                                                                                                                                                                                                                                                                                                               |
| <b>Supported Releases</b>      | 10.2.0E or later                                                                                                                                                                                                                                                                                                                                                                    |

## track interface

Monitors an interface and lowers the priority value of the VRRP group on that interface, if disabled.

|                           |                                                                                                                                                                                                                                                                                  |
|---------------------------|----------------------------------------------------------------------------------------------------------------------------------------------------------------------------------------------------------------------------------------------------------------------------------|
| <b>Syntax</b>             | <code>interface {ethernet node/slot/port[:subport]} [line-protocol]</code>                                                                                                                                                                                                       |
| <b>Parameters</b>         | <ul style="list-style-type: none"><li>• <code>ethernet node/slot/port[:subport]</code> — (Optional) Enter the keyword and the interface information to track.</li><li>• <code>line-protocol</code> — (Optional) Tracks the interface line-protocol operational status.</li></ul> |
| <b>Default</b>            | Disabled                                                                                                                                                                                                                                                                         |
| <b>Command Mode</b>       | EXEC                                                                                                                                                                                                                                                                             |
| <b>Usage Information</b>  | Assign an object tracking unique ID number before tracking the interface. Use the <code>line-protocol</code> parameter to track for interface operational status information. The <code>no</code> version of this command resets the value to the default.                       |
| <b>Example</b>            | <pre>OS10(config)# track 10 OS10(config-track-10)# interface ethernet 1/1/5 line-protocol</pre>                                                                                                                                                                                  |
| <b>Supported Releases</b> | 10.2.0E or later                                                                                                                                                                                                                                                                 |

## virtual-address

Configures up to 10 virtual router IP addresses in the VRRP group. Set at least one virtual IP address for the VRRP group to start sending VRRP packets.

|                   |                                                                                                                                                                                                                           |
|-------------------|---------------------------------------------------------------------------------------------------------------------------------------------------------------------------------------------------------------------------|
| <b>Syntax</b>     | <code>virtual-address ip-address1 [ip-address2...ip-address10]</code>                                                                                                                                                     |
| <b>Parameters</b> | <ul style="list-style-type: none"><li>• <code>ip-address1</code> — Enter the IP address of a virtual router in A.B.C.D format. The IP address must be on the same subnet as the interface's primary IP address.</li></ul> |



- *ip-address2...ip-address10* — (Optional) Enter up to nine additional IP addresses of virtual routers, separated by a space. The IP addresses must be on the same subnet as the interface's primary IP address.

|                           |                                                                                                                                                                                                                                                                                                                                                                  |
|---------------------------|------------------------------------------------------------------------------------------------------------------------------------------------------------------------------------------------------------------------------------------------------------------------------------------------------------------------------------------------------------------|
| <b>Default</b>            | Enabled                                                                                                                                                                                                                                                                                                                                                          |
| <b>Command Mode</b>       | INTERFACE-VRRP                                                                                                                                                                                                                                                                                                                                                   |
| <b>Usage Information</b>  | The VRRP group only becomes active and sends VRRP packets when you configure a virtual IP address. When you delete the virtual address, the VRRP group stops sending VRRP packets. You can ping the virtual addresses configured in all VRRP groups. The <code>no</code> version of this command deletes one or more virtual-addresses configured in the system. |
| <b>Example</b>            | <pre>OS10(conf-eth1/1/5-vrid-254)# virtual address 10.1.1.15</pre>                                                                                                                                                                                                                                                                                               |
| <b>Supported Releases</b> | 10.2.0E or later                                                                                                                                                                                                                                                                                                                                                 |

## vrrp delay reload

Sets the delay time for VRRP initialization after a system reboot.

|                           |                                                                                                                                                                                                                    |
|---------------------------|--------------------------------------------------------------------------------------------------------------------------------------------------------------------------------------------------------------------|
| <b>Syntax</b>             | <code>vrrp delay reload seconds</code>                                                                                                                                                                             |
| <b>Parameters</b>         | <i>seconds</i> — Enter the number of seconds for the VRRP reload time, from 0 to 900.                                                                                                                              |
| <b>Default</b>            | 0                                                                                                                                                                                                                  |
| <b>Command Mode</b>       | CONFIGURATION                                                                                                                                                                                                      |
| <b>Usage Information</b>  | VRRP delay reload time of zero seconds indicates no delays. This command configuration applies to all the VRRP configured interfaces. The <code>no</code> version of this command resets the value to the default. |
| <b>Example</b>            | <pre>OS10(config)# vrrp delay reload 5</pre>                                                                                                                                                                       |
| <b>Supported Releases</b> | 10.4.0E(R1) or later                                                                                                                                                                                               |

## vrrp-group

Assigns a VRRP group identification number to an IPv4 interface or VLAN

|                           |                                                                                                                                                                                                                                                                                   |
|---------------------------|-----------------------------------------------------------------------------------------------------------------------------------------------------------------------------------------------------------------------------------------------------------------------------------|
| <b>Syntax</b>             | <code>vrrp-group vrrp-id</code>                                                                                                                                                                                                                                                   |
| <b>Parameters</b>         | <i>vrrp-id</i> — Enter a VRRP group identification number, from 1 to 255.                                                                                                                                                                                                         |
| <b>Default</b>            | Not configured                                                                                                                                                                                                                                                                    |
| <b>Command Mode</b>       | INTERFACE-VRRP                                                                                                                                                                                                                                                                    |
| <b>Usage Information</b>  | The VRRP group only becomes active and sends VRRP packets when you configure a virtual IP address. When you delete the virtual address, the VRRP group stops sending VRRP packets. The <code>no</code> version of this command removes the <code>vrrp-group</code> configuration. |
| <b>Example</b>            | <pre>OS10(conf-if-eth1/1/5)# vrrp-group 254</pre>                                                                                                                                                                                                                                 |
| <b>Example (VLAN)</b>     | <pre>OS10(conf-if-vl-10)# vrrp-group 5</pre>                                                                                                                                                                                                                                      |
| <b>Supported Releases</b> | 10.2.0E or later                                                                                                                                                                                                                                                                  |

## vrrp-ipv6-group

Assigns a VRRP group identification number to an IPv6 interface.

|                           |                                                                                                                                                                                                                                                                                        |
|---------------------------|----------------------------------------------------------------------------------------------------------------------------------------------------------------------------------------------------------------------------------------------------------------------------------------|
| <b>Syntax</b>             | <code>vrrp-ipv6-group vrrp-id</code>                                                                                                                                                                                                                                                   |
| <b>Parameters</b>         | <code>vrrp-id</code> — Enter a VRRP group identification number, from 1 to 255.                                                                                                                                                                                                        |
| <b>Default</b>            | Not configured                                                                                                                                                                                                                                                                         |
| <b>Command Mode</b>       | INTERFACE-VRRP                                                                                                                                                                                                                                                                         |
| <b>Usage Information</b>  | The VRRP group only becomes active and sends VRRP packets when you configure a virtual IP address. When you delete the virtual address, the VRRP group stops sending VRRP packets. The <code>no</code> version of this command removes the <code>vrrp-ipv6-group</code> configuration. |
| <b>Example</b>            | <pre>OS10(conf-if-eth1/1/7)# vrrp-ipv6-group 250</pre>                                                                                                                                                                                                                                 |
| <b>Supported Releases</b> | 10.2.0E or later                                                                                                                                                                                                                                                                       |

## vrrp version

Sets the VRRP version for the IPv4 group.

|                           |                                                                                                                   |
|---------------------------|-------------------------------------------------------------------------------------------------------------------|
| <b>Syntax</b>             | <code>vrrp version {2   3}</code>                                                                                 |
| <b>Parameters</b>         | <ul style="list-style-type: none"><li>• 2 — Set to VRRP version 2.</li><li>• 3 — Set to VRRP version 3.</li></ul> |
| <b>Default</b>            | Not configured                                                                                                    |
| <b>Command Mode</b>       | CONFIGURATION                                                                                                     |
| <b>Usage Information</b>  | The <code>no</code> version of this command disables the VRRP version for the IPv4 group.                         |
| <b>Example</b>            | <pre>OS10(config)# vrrp version 2</pre>                                                                           |
| <b>Supported Releases</b> | 10.2.0E or later                                                                                                  |

## Multicast

Multicast is a technique that allows networking devices to send data to a group of interested receivers in a single transmission. For instance, this technique is widely used for streaming videos. Multicast allows you to more efficiently use network resources, specifically for bandwidth-consuming services such as audio and video transmission.

OS10 supports the multicast feature in IPv4 networks and uses the following protocols for multicast distribution:

- Internet Group Management Protocol (IGMP)
- Protocol Independent Multicast (PIM)

### Configuration notes

All Dell EMC PowerSwitches except MX-Series:

When there is an exclude join, the show {ip | ipv6} {igmp | mld} snooping groups detail command lists the member port under both the wild-card (--) source, and sources that are listed in the report. The member port listed under the wild-card (--) source has the expiry timer running and indicates that the multicast data packets that do not match the excluded sources for this member port are forwarded to that port.

For example, the member port ethernet1/1/36, is listed under both the wildcard source (--) and the source (15.1.1.1) in the following show command output.

```
OS10# show ip igmp snooping groups detail
Interface vlan10
Group 234.1.1.1
Source List
--
Member Port Mode Uptime
Expires
ethernet1/1/36 Exclude 00:01:33
00:01:59
ethernet1/1/38 Exclude 00:01:33
00:01:54
15.1.1.1
Member Port Mode Uptime
Expires
ethernet1/1/36 Exclude 00:01:33
Never
21.1.1.1
Member Port Mode Uptime
Expires
ethernet1/1/38 Exclude 00:01:33 Never
```

## Important notes

- OS10 supports IGMP and IPv4 PIM for multicast routing. This release of OS10 does not support IPv6 PIM.
- OS10 supports PIM and IGMP on default and non-default VRFs.
- OS10 does not support multicast routing on S3048-ON platforms.
- Multicast flood control is not supported on S4248FB-ON and S4248FBL-ON platforms.
- OS10 supports MLD snooping for L2 IPv6 multicast.

The 10.5.1 release does not support the following:

- Fast leave support with a prefix list
- Anycast RP
- IGMPv2 SSM mapping
- Static multicast group configuration
- Simple Network Management Protocol (SNMP) MIB for Internet Group Management Protocol (IGMP) or Protocol Independent Multicast (PIM)

**NOTE:** Layer 3 (L3) PIM and IGMP multicast is not supported on the S3048-ON switch. IGMP and Multicast Listener Discovery (MLD) snooping is supported on all switches.

## Configure multicast routing

Configuring multicast routing is a two-step process that involves configuring multicast routing and enabling PIM sparse mode (PIM-SM) on a Layer 3 (L3) interface. The following procedure describes how to configure multicast routing.

For more information about IGMP and PIM feature configurations, see [Internet Group Management Protocol](#) and [Protocol Independent Multicast](#).

### **NOTE:**

Multicast flood restrict feature is enabled by default. To ensure that no traffic drops occur, Dell Technologies recommends that you do one of the following:

- Disable IGMP snooping on the VLAN between two PIM routers that do not have IGMP receivers on that VLAN.
- Configure the interface between the PIM routers as static mrouter port.

1. Enable multicast routing for IPv4 networks.

```
OS10# configure terminal
OS10(config)# ip multicast-routing
```

2. Configure an IP address to a VLAN interface.

```
OS10(config)# interface vlan 2
OS10(conf-if-vl-2)# ip address 1.1.1.2/24
```

3. Enable PIM sparse mode on an L3 interface.

```
OS10(config)# interface vlan 2
OS10(conf-if-vl-2) ip pim sparse-mode
```

4. From CONFIGURATION mode, configure the rendezvous point (RP) IP address statically and specify the multicast group address range. The RP IP address should be reachable across the PIM domain.

```
OS10(config)# ip pim rp-address 171.1.1.1 group-address 225.1.1.3/32
```

5. Configure the RP address and multicast group address on all nodes in your network.

## Unknown multicast flood control

The unknown multicast flood control feature enables the system to forward unknown multicast packets only to a multicast router (mrouter).

When you enable multicast snooping, OS10 forwards multicast frames, whose destination is already learned, to their intended recipients. When the system receives multicast frames whose destination is not known, it floods the frames for all ports on the specific VLAN. All hosts that receive these multicast frames must process them. With multicast flood control, the system forwards unknown multicast frames only to the interface that leads to the mrouter. The mrouter can then forward the traffic to the intended destinations.

For multicast flood control to work, you must enable both IGMP and MLD snooping on the system. By default, multicast flood control, IGMP snooping, and MLD snooping are enabled.

**NOTE:** The Multicast flood control feature is not supported on the S4248FB-ON and S4248FBL-ON switches.

The following describes a scenario where a multicast frame is flooded on all ports of all switches. The switches and hosts in the network need not receive these frames because they are not the intended destinations.

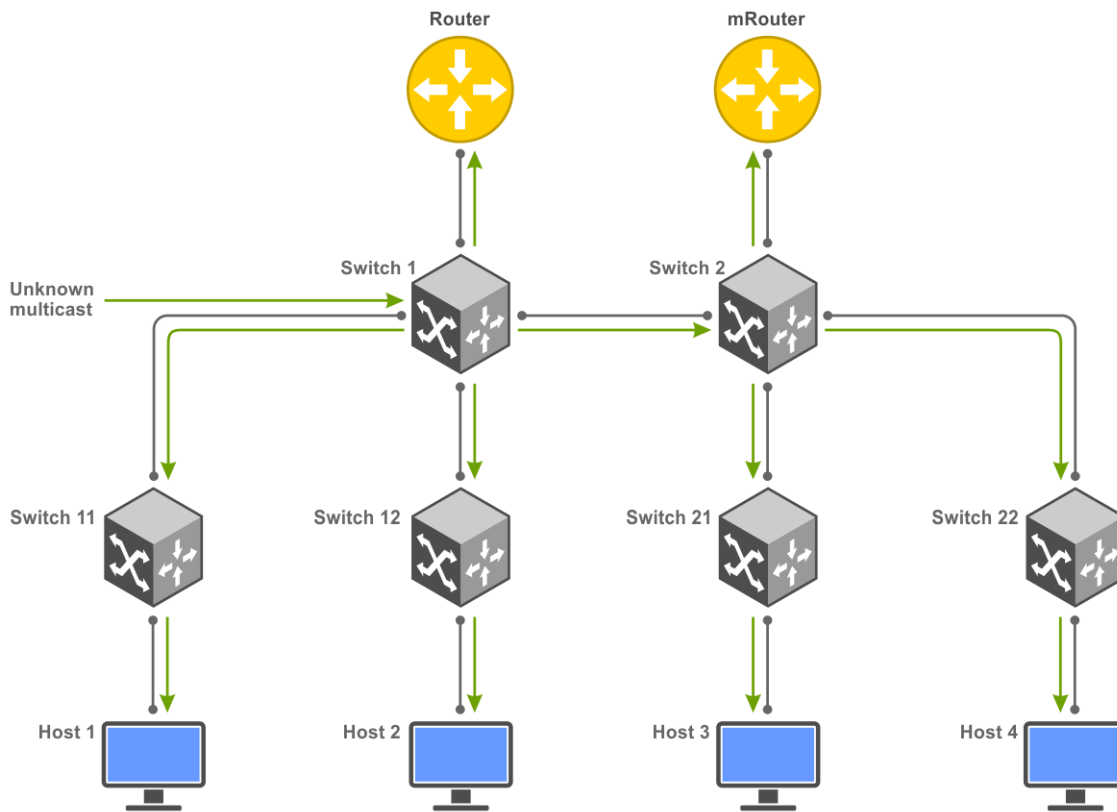

With multicast flood control, multicast frames, whose destination is not known, are forwarded only to the designated mrouter port. OS10 learns of the mrouter interface dynamically based on the interface where an IGMP membership query is received. You can also statically configure the mrouter interface using the `ip igmp snooping mrouter` and `ipv6 mld snooping mrouter` commands.

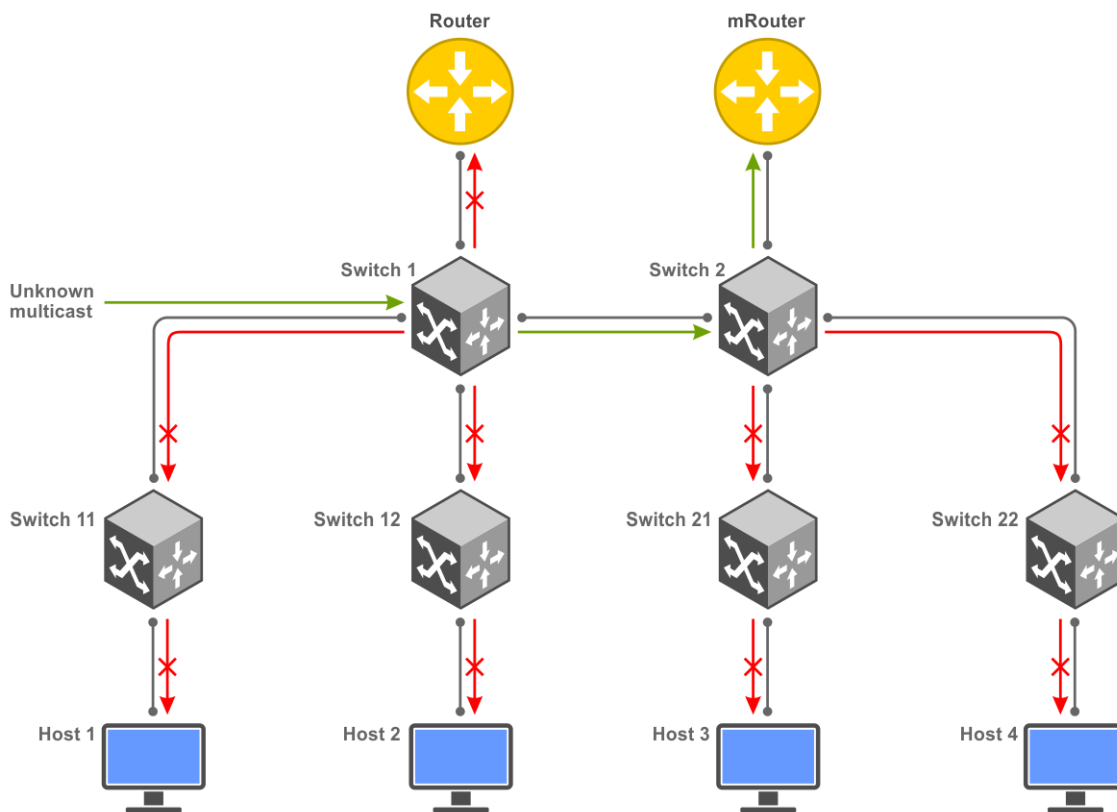

## Enable multicast flood control

Multicast flood control is enabled on OS10 by default. If it is disabled, use the following procedure to enable multicast flood control:

1. Configure IGMP snooping. To know how to configure IGMP snooping, see the [IGMP snooping](#) section.
2. Configure MLD snooping. To know how to configure MLD snooping, see the [MLD Snooping](#) section.
3. Enable the multicast flood control feature.

```
OS10(config)# multicast snooping flood-restrict
```

## Multicast Commands

### multicast snooping flood-restrict

Enables multicast snooping flood control for IGMP snooping and MLD snooping.

|                           |                                                                                                                                                                                                                                                                                                                                                        |
|---------------------------|--------------------------------------------------------------------------------------------------------------------------------------------------------------------------------------------------------------------------------------------------------------------------------------------------------------------------------------------------------|
| <b>Syntax</b>             | <code>multicast snooping flood-restrict</code><br>The <code>no</code> version of this command disables multicast flood control.                                                                                                                                                                                                                        |
| <b>Parameters</b>         | None                                                                                                                                                                                                                                                                                                                                                   |
| <b>Default</b>            | Enabled                                                                                                                                                                                                                                                                                                                                                |
| <b>Command Mode</b>       | CONFIGURATION                                                                                                                                                                                                                                                                                                                                          |
| <b>Usage Information</b>  | Multicast snooping flood control, IGMP snooping, and MLD snooping are enabled by default.<br>For multicast flood restrict to be effective on a VLAN, IGMP snooping and MLD snooping must be enabled at both global and VLAN levels.<br>To disable multicast snooping flood control, use the <code>no multicast snooping flood-restrict</code> command. |
| <b>Example</b>            | <pre>OS10(config)# multicast snooping flood-restrict</pre>                                                                                                                                                                                                                                                                                             |
| <b>Supported Releases</b> | 10.4.3.0 or later                                                                                                                                                                                                                                                                                                                                      |

## Internet Group Management Protocol

Internet Group Management Protocol (IGMP) is a communications protocol that establishes multicast group memberships using IPv4 networks. OS10 supports IGMPv1, IGMPv2, and IGMPv3 to manage the multicast group memberships on IPv4 networks.

The IGMP querier periodically (by default, every 60 seconds) sends out a membership query to all the hosts. The hosts, in response to the query, send a response back to the querier to report their multicast group memberships. The switch makes an entry to identify the corresponding port as a member of the particular multicast group..

 **NOTE:** A multicast router is a Layer 3 router or switch that has multicast features enabled.

When a host wants to join a multicast group, it sends an IGMP message to the multicast router.

Each network segment has an IGMP querier, which is a multicast router. The multicast router periodically sends IGMP queries to learn which multicast groups are active and have members on the network.

Multicast routers send the following types of queries:

- General query—To learn about listeners for multicast groups.
- Multicast address-specific query—To learn if a particular multicast address has listeners.

- Multicast address-and-source-specific query—To learn if any of the sources from the specified list for a multicast source has any listeners.

The hosts send the following messages to multicast routers:

- Version 1: Membership report
- Version 2:
  - Version 1 membership report for backward compatibility with version 1
  - Version 2 membership report
  - Leave group message
- Version 3:
  - Version 1 membership report for backward compatibility with version 1
  - Version 2 membership report for backward compatibility with version 2
  - Version 3 membership report
  - Version 2 leave group message

Version 3 provides support for source filtering. The system reports interest in receiving packets only from specific source addresses, or from all the sources except some specific source addresses, sent to a particular multicast address.

## Standards compliance

- OS10 complies to the RFCs 1112, 2236, and 3376 for IGMP versions 1, 2, and 3, respectively.
- OS10 uses version 3 as the default IGMP version. Version 3 is backwards compatible with versions 1 and 2.

## Important notes

- OS10 systems cannot serve as an IGMP host or an IGMP version 1 querier.
- OS10 automatically enables IGMP on interfaces where you enable PIM sparse mode.

## Supported IGMP versions

IGMP has three versions. Version 3 obsoletes and is backwards-compatible with version 2; version 2 obsoletes version 1.

OS10 supports the following IGMP versions:

- Router—IGMP versions 2 and 3. The default is version 3.
- Host—IGMP versions 1, 2, and 3.

In IGMP version 2, the host expresses interest in a particular group membership (\*, G). In IGMP version 3, the host expresses interest in a particular group membership, and specifies the source from which it wants the multicast traffic (S, G).

## Query interval

The IGMP querier periodically sends a general query to discover which multicast groups are active. A group must have at least one host to be active. By default, the periodic query messages are sent every 60 seconds. You can configure this value using the `ip igmp query-interval` command.

To configure a query interval:

```
OS10# configure terminal
OS10# interface vlan120
OS10(conf-if-vl-120)# ip igmp query-interval 60
```

## Last member query interval

When the IGMP querier receives a leave message, it sends a group-specific query message to ensure if any other host in the network is interested in the multicast flow. By default, the group-specific query messages are sent every 1000 milliseconds. You can configure this value using the `ip igmp last-member-query-interval` command.

To configure last member query interval:

```
OS10# configure terminal
OS10# interface vlan120
OS10(conf-if-vl-120)# ip igmp last-member-query-interval 200
```

## Maximum response time

The maximum response time is the amount of time that the querier waits for a response to a query before taking action.

When a host receives a query, it does not respond immediately, but rather starts a delay timer. The delay time is set to a random value between 0 and the maximum response time. The host sends a response when the timer expires; in IGMP version 2, if another host responds before the timer expires, the timer nullifies, and no response is sent.

The querier advertises the maximum response time in the query. Lowering this value decreases leave latency but increases response burstiness because all host membership reports are sent before the maximum response time expires. Inversely, increasing this value decreases burstiness, but increases leave latency.

To configure maximum response time:

```
OS10# configure terminal
OS10# interface vlan120
OS10(conf-if-vl-120)# ip igmp query-max-resp-time 20
```

## IGMP immediate leave

If the IGMP querier does not receive a response to a group-specific or group-and-source query, it sends another query based on the configured querier robustness value. This value determines the number of times the querier sends the message. If the querier does not receive a response, it removes the group from the outgoing interface for the subnet.

IGMP immediate leave reduces leave latency by enabling a router to immediately delete the group membership on an interface after receiving a *leave* message. Immediate leave does not send group-specific or group-and-source queries before deleting the entry.

To configure IGMP immediate leave:

```
OS10# configure terminal
OS10# interface vlan14
OS10(conf-if-vl-14)# ip igmp immediate-leave
```

## Select an IGMP version

OS10 enables IGMP version 3 by default.

If hosts require an IGMP version other than 3, use the following to select a different IGMP version:

```
OS10# configure terminal
OS10# interface vlan12
OS10(conf-if-vl-12)# ip igmp version 3
```

## View IGMP-enabled interfaces and groups

To view IGMP-enabled interfaces and groups, use the following `show` commands.



To view IGMP-enabled interfaces:

```
OS10# show ip igmp interface
Vlan103 is up, line protocol is up
Internet address is 2.1.1.2
IGMP is enabled on interface
IGMP version is 3
IGMP query interval is 60 seconds
IGMP querier timeout is 130 seconds
IGMP last member query response interval is 1000 ms
IGMP max response time is 10 seconds
IGMP immediate-leave is disabled on this interface
IGMP joins count: 0
IGMP querying router is 2.1.1.1

Vlan105 is up, line protocol is up
Internet address is 3.1.1.2
IGMP is enabled on interface
IGMP version is 3
IGMP query interval is 60 seconds
IGMP querier timeout is 130 seconds
IGMP last member query response interval is 1000 ms
IGMP max response time is 10 seconds
IGMP immediate-leave is disabled on this interface
IGMP joins count: 0
IGMP querying router is 3.1.1.1

Vlan121 is up, line protocol is up
Internet address is 121.1.1.2
IGMP is enabled on interface
IGMP version is 3
IGMP query interval is 60 seconds
IGMP querier timeout is 130 seconds
IGMP last member query response interval is 1000 ms
IGMP max response time is 10 seconds
IGMP immediate-leave is disabled on this interface
IGMP joins count: 100
IGMP querying router is 121.1.1.2
```

To view IGMP groups:

```
OS10# show ip igmp groups
Total Number of Groups: 100
IGMP Connected Group Membership
Group Address Interface Mode Uptime Expires Last Reporter
225.1.1.1 vlan121 IGMPv2-Compat 12:39:00 00:01:58 121.1.1.10
225.1.1.2 vlan121 IGMPv2-Compat 12:39:00 00:01:58 121.1.1.10
225.1.1.3 vlan121 IGMPv2-Compat 12:39:00 00:01:58 121.1.1.10
225.1.1.4 vlan121 IGMPv2-Compat 12:39:00 00:01:58 121.1.1.10
225.1.1.5 vlan121 IGMPv2-Compat 12:39:00 00:01:58 121.1.1.10
225.1.1.6 vlan121 IGMPv2-Compat 12:39:00 00:01:58 121.1.1.10
225.1.1.7 vlan121 IGMPv2-Compat 12:39:00 00:01:58 121.1.1.10
225.1.1.8 vlan121 IGMPv2-Compat 12:39:00 00:01:58 121.1.1.10
225.1.1.9 vlan121 IGMPv2-Compat 12:39:00 00:01:58 121.1.1.10
225.1.1.10 vlan121 IGMPv2-Compat 12:39:00 00:01:58 121.1.1.10
225.1.1.11 vlan121 IGMPv2-Compat 12:39:00 00:01:58 121.1.1.10
225.1.1.12 vlan121 IGMPv2-Compat 12:39:00 00:01:58 121.1.1.10
225.1.1.13 vlan121 IGMPv2-Compat 12:39:00 00:01:58 121.1.1.10
225.1.1.14 vlan121 IGMPv2-Compat 12:39:00 00:01:58 121.1.1.10
225.1.1.15 vlan121 IGMPv2-Compat 12:39:00 00:01:58 121.1.1.10
225.1.1.16 vlan121 IGMPv2-Compat 12:39:00 00:01:58 121.1.1.10
```

## IGMP snooping

IGMP snooping uses the information in IGMP packets to generate a forwarding table that associates ports with multicast groups. When switches receive multicast frames, they forward them to their intended receivers. OS10 supports IGMP snooping on virtual local area network (VLAN) interfaces.

Effective with OS10 release 10.4.3.0, IGMP snooping is enabled by default.

**NOTE:** OS10 supports IGMP snooping only with proxy reporting. OS10 does not relay the IGMP join packets received from hosts as is. Instead, OS10 generates, bundles, and sends IGMP join packets to mrouter port based on the version of IGMP queries received from IGMP routers. Proxy reporting reduces the number of IGMP control packets sent to the multicast router.

### Configuration notes

All Dell EMC PowerSwitches except MX-Series, S4200-Series, S5200 Series, and Z9332F-ON:

If you configure and unconfigure a static connection to a multicast router on an interface using the `ip igmp snooping mrouter interface` command in VLAN mode, the router port still appears in the `show ip igmp snooping mrouter vlan` output. To remove the VLAN port from the show output, configure the VLAN port again using the `ip igmp snooping mrouter interface` command, and then unconfigure it using the `no` version of the command.

### Configure IGMP snooping

- Enable IGMP snooping globally using the `ip igmp snooping enable` command in CONFIGURATION mode. This command enables IGMP snooping on all VLAN interfaces.
  - NOTE:** You cannot enable IGMP or MLD snooping when configuring VLAN scale profile. If you enable VLAN scale profile, OS10 disables IGMP and MLD snooping globally. When you disable VLAN scale profile configuration, you must explicitly enable IGMP and MLD snooping globally.
- (Optional) Disable IGMP snooping on specific VLAN interfaces using the `no ip igmp snooping` command in VLAN INTERFACE mode.
- (Optional) Multicast flood control is enabled by default. To disable the multicast flood restrict feature, use the `no multicast snooping flood-restrict` command in CONFIGURATION mode. To reenab the feature globally, use the `multicast snooping flood-restrict` command in CONFIGURATION mode.
- In a network, the snooping switch is connected to a multicast Router that sends IGMP queries. On a Layer 2 network that does not have a multicast router, you can configure the snooping switch to act as querier. Use the `ip igmp snooping querier` command in VLAN INTERFACE mode to send the queries.
- OS10 learns the multicast router interface dynamically based on the interface on which IGMP membership query is received. To assign a multicast router interface statically, use the `ip igmp snooping mrouter interface interface-type` command in VLAN INTERFACE mode.

#### **NOTE:**

IGMP snooping dynamically detects the mrouter interface based on IGMP queries that it receives. If there are more than one multicast routers connected to the snooping switch, one of them will send IGMP queries and the interface connected to that router is dynamically learnt as an mrouter port. You must configure the interfaces connected to other multicast routers as static mrouter port.

- (Optional) Configure the IGMP version using the `ip igmp version version-number` command in VLAN INTERFACE mode.
- (Optional) The fast leave option allows the IGMP snooping switch to remove an interface from the multicast group immediately on receiving the `leave` message. Enable fast leave with the `ip igmp snooping fast-leave` command in VLAN INTERFACE mode.
- (Optional) Configure the time interval for sending IGMP general queries with the `ip igmp snooping query-interval query-interval-time` command in VLAN INTERFACE mode.
- (Optional) Configure the maximum time for responding to a query advertised in IGMP queries using the `ip igmp snooping query-max-resp-time query-response-time` command in VLAN INTERFACE mode.
- (Optional) Configures the time interval between group-specific IGMP query messages with the `ip igmp snooping last-member-query-interval query-interval-time` command in VLAN INTERFACE mode.

### IGMP snooping configuration

```
OS10(config)# ip igmp snooping enable
OS10(config)# interface vlan 100
OS10(conf-if-vl-100)# ip igmp snooping mrouter interface ethernet 1/1/32
OS10(conf-if-vl-100)# ip igmp snooping querier
OS10(conf-if-vl-100)# ip igmp version 3
OS10(conf-if-vl-100)# ip igmp snooping fast-leave
OS10(conf-if-vl-100)# ip igmp snooping query-interval 60
OS10(conf-if-vl-100)# ip igmp snooping query-max-resp-time 10
OS10(conf-if-vl-100)# ip igmp snooping last-member-query-interval 1000
```

## View IGMP snooping information

```
OS10# show ip igmp snooping groups
Total Number of Groups: 480
IGMP Connected Group Membership
Group Address Interface Mode Expires
225.1.0.0 vlan3531 IGMPv2-Compat 00:01:35
 Member-ports :port-channel41,ethernet1/1/51,ethernet1/1/52
225.1.0.1 vlan3531 IGMPv2-Compat 00:01:35
 Member-ports :port-channel41,ethernet1/1/51,ethernet1/1/52
225.1.0.2 vlan3531 IGMPv2-Compat 00:01:35
 Member-ports :port-channel41,ethernet1/1/51,ethernet1/1/52
225.1.0.3 vlan3531 IGMPv2-Compat 00:01:35
 Member-ports :port-channel41,ethernet1/1/51,ethernet1/1/52
225.1.0.4 vlan3531 IGMPv2-Compat 00:01:35
 Member-ports :port-channel41,ethernet1/1/51,ethernet1/1/52
225.1.0.5 vlan3531 IGMPv2-Compat 00:01:35
 Member-ports :port-channel41,ethernet1/1/51,ethernet1/1/52
225.1.0.6 vlan3531 IGMPv2-Compat 00:01:35
 Member-ports :port-channel41,ethernet1/1/51,ethernet1/1/52
225.1.0.7 vlan3531 IGMPv2-Compat 00:01:35
 Member-ports :port-channel41,ethernet1/1/51,ethernet1/1/52
225.1.0.8 vlan3531 IGMPv2-Compat 00:01:35
 Member-ports :port-channel41,ethernet1/1/51,ethernet1/1/52
225.1.0.9 vlan3531 IGMPv2-Compat 00:01:35
 Member-ports :port-channel41,ethernet1/1/51,ethernet1/1/52
--more--

<<Output Truncated>>
```

```
OS10# show ip igmp snooping interface vlan 2
Vlan2 is up, line protocol is up
IGMP version is 3
IGMP snooping is enabled on interface
IGMP snooping query interval is 60 seconds
IGMP snooping querier timeout is 130 seconds
IGMP snooping last member query response interval is 1000 ms
IGMP Snooping max response time is 10 seconds
IGMP snooping fast-leave is disabled on this interface
IGMP snooping querier is disabled on this interface
Multicast flood-restrict is enabled on this interface
```

```
show ip igmp snooping mrouter
Interface Router Ports
Vlan 100 ethernet 1/1/32
```

## IGMP commands

### clear ip igmp groups

Clears entries from the group cache table.

|                          |                                                               |
|--------------------------|---------------------------------------------------------------|
| <b>Syntax</b>            | clear ip igmp [vrf vrf-name] groups                           |
| <b>Parameters</b>        | vrf vrf-name—Enter the keyword vrf, then the name of the VRF. |
| <b>Default</b>           | None                                                          |
| <b>Command Mode</b>      | EXEC                                                          |
| <b>Usage Information</b> | None                                                          |
| <b>Example</b>           | OS10# clear ip igmp groups                                    |

**Supported Releases** 10.4.3.0 or later

## ip igmp immediate-leave

Enables IGMP immediate leave.

**Syntax** `ip igmp immediate-leave`

**Parameters** None

**Default** None

**Command Mode** INTERFACE

**Usage Information** The querier sends some group-specific queries when it receives a leave message before deleting the group from the membership database. If you need to immediately delete a group from the membership database, use the `ip igmp immediate-leave` command. The `no` version of this command disables IGMP immediate leave.

### Example

```
OS10# configure terminal
OS10# interface vlan11
OS10(conf-if-vl-11)# ip igmp immediate-leave
```

**Supported Releases** 10.4.3.0 or later

## ip igmp last-member-query-interval

Changes the last member query interval, which is the maximum response time included in the group-specific queries sent in response to leave group messages. This last-member-query-interval is the interval between group-specific query messages.

**Syntax** `ip igmp last-member-query-interval milliseconds`

**Parameters** *milliseconds*—Enter the amount of time in milliseconds to configure the time interval between group-specific query messages. The range is from 100 to 65535.

**Default** 1000 milliseconds

**Command Mode** INTERFACE

**Usage Information** None

### Example

```
OS10# configure terminal
OS10# interface vlan11
OS10(conf-if-vl-11)# ip igmp last-member-query-interval 200
```

**Supported Releases** 10.4.3.0 or later

## ip igmp query-interval

Changes the frequency of IGMP general queries sent by the querier.

**Syntax** `ip igmp query-interval seconds`

**Parameters** *seconds*—Enter the amount of time in seconds to configure the time interval for IGMP general queries. The range is from 1 to 18000.

**Default** 60 seconds

**Command Mode** INTERFACE

**Usage Information** None

**Example**

```
OS10# configure terminal
OS10# interface vlan12
OS10(conf-if-vl-12)# ip igmp query-interval 60
```

**Supported Releases** 10.4.3.0 or later

## ip igmp query-max-resp-time

Configures the maximum query response time advertised in general queries.

**Syntax** `ip igmp query-max-resp-time seconds`

**Parameters** *seconds*—Enter the amount of time in seconds, from 1 to 25.

**Default** 10 seconds

**Command Mode** INTERFACE

**Usage Information** The IGMP query maximum response time value must be less than the IGMP query interval value. The no form of the command configures the default value.

**Example**

```
OS10# configure terminal
OS10# interface vlan14
OS10(conf-if-vl-14)# ip igmp query-max-resp-time 20
```

**Supported Releases** 10.4.3.0 or later

## ip igmp snooping enable

Enables IGMP snooping globally.

**Syntax** `ip igmp snooping enable`

**Parameters** None

**Default** Enabled

**Command Mode** CONFIGURATION

**Usage Information** The no version of this command disables IGMP snooping.

**Example**

```
OS10(config)# ip igmp snooping enable
```

**Supported Releases** 10.4.0E(R1) or later

## ip igmp snooping

Enables IGMP snooping on the specified VLAN interface.

**Syntax** `ip igmp snooping`

**Parameters** None

**Default** Depends on the global configuration.

**Command Mode** VLAN INTERFACE

**Usage Information** When you enable IGMP snooping globally, the configuration applies to all VLAN interfaces. You can disable IGMP snooping on specified VLAN interfaces. The `no` version of this command disables IGMP snooping on the specified VLAN interface.

**Example**

```
OS10(config)# interface vlan 100
OS10(conf-if-vl-100)# no ip igmp snooping
```

**Supported Releases** 10.4.0E(R1) or later

## ip igmp snooping fast-leave

Enables fast leave in IGMP snooping for specified VLAN.

**Syntax** `ip igmp snooping fast-leave`

**Parameters** None

**Default** Disabled

**Command Mode** VLAN INTERFACE

**Usage Information** The fast leave option allows the IGMP snooping switch to remove an interface from the multicast group immediately on receiving the *leave* message. The `no` version of this command disables the fast leave functionality.

**Example**

```
OS10(config)# interface vlan 100
OS10(conf-if-vl-100)# ip igmp snooping fast-leave
```

**Supported Releases** 10.4.1.0 or later

## ip igmp snooping last-member-query-interval

Configures the time interval between group-specific IGMP query messages.

**Syntax** `ip igmp snooping last-member-query-interval query-interval-time`

**Parameters** *query-interval-time*—Enter the query time interval in milliseconds, from 100 to 65535.

**Default** 1000 milliseconds

**Command Mode** VLAN INTERFACE

**Usage Information** The `no` version of this command resets the last member query interval time to the default value.

**Example**

```
OS10(config)# interface vlan 100
OS10(conf-if-vl-100)# ip igmp snooping last-member-query-interval 2500
```

**Supported Releases** 10.4.1.0 or later

## ip igmp snooping mrouter

Configures the multicast router port on the specified VLAN interface.

**Syntax** `ip igmp snooping mrouter interface interface-type`

**Parameters** *interface-type*—Enter the interface type details. The interface must be a member of the VLAN.

**Default** Not configured

**Command Mode** VLAN INTERFACE

|                           |                                                                                                                     |
|---------------------------|---------------------------------------------------------------------------------------------------------------------|
| <b>Usage Information</b>  | The no version of this command removes the multicast router configuration from the VLAN member port.                |
| <b>Example</b>            | <pre>OS10(config)# interface vlan 100 OS10(conf-if-vl-100)# ip igmp snooping mrouter interface ethernet 1/1/1</pre> |
| <b>Supported Releases</b> | 10.4.0E(R1) or later                                                                                                |

## ip igmp snooping querier

Enables IGMP querier processing for the specified VLAN interface.

|                           |                                                                                            |
|---------------------------|--------------------------------------------------------------------------------------------|
| <b>Syntax</b>             | <code>ip igmp snooping querier</code>                                                      |
| <b>Parameters</b>         | None                                                                                       |
| <b>Default</b>            | Not configured                                                                             |
| <b>Command Mode</b>       | VLAN INTERFACE                                                                             |
| <b>Usage Information</b>  | The no version of this command disables IGMP querier on the VLAN interface..               |
| <b>Example</b>            | <pre>OS10(config)# interface vlan 100 OS10(conf-if-vl-100)# ip igmp snooping querier</pre> |
| <b>Supported Releases</b> | 10.4.0E(R1) or later                                                                       |

## ip igmp snooping query-interval

Configures time interval for sending IGMP general queries.

|                           |                                                                                                       |
|---------------------------|-------------------------------------------------------------------------------------------------------|
| <b>Syntax</b>             | <code>ip igmp snooping query-interval <i>query-interval-time</i></code>                               |
| <b>Parameters</b>         | <i>query-interval-time</i> —Enter the interval time in seconds, from 2 to 18000.                      |
| <b>Default</b>            | 60 seconds                                                                                            |
| <b>Command Mode</b>       | VLAN INTERFACE                                                                                        |
| <b>Usage Information</b>  | The no version of this command resets the query interval to the default value.                        |
| <b>Example</b>            | <pre>OS10(config)# interface vlan 100 OS10(conf-if-vl-100)# ip igmp snooping query-interval 120</pre> |
| <b>Supported Releases</b> | 10.4.1.0 or later                                                                                     |

## ip igmp snooping query-max-resp-time

Configures the maximum time for responding to a query advertised in IGMP queries.

|                     |                                                                                             |
|---------------------|---------------------------------------------------------------------------------------------|
| <b>Syntax</b>       | <code>ip igmp snooping query-max-resp-time <i>query-response-time</i></code>                |
| <b>Parameters</b>   | <i>query-response-time</i> —Enter the query response time in seconds, ranging from 1 to 25. |
| <b>Default</b>      | 10 seconds                                                                                  |
| <b>Command Mode</b> | VLAN INTERFACE                                                                              |

**Usage Information** The no version of this command resets the query response time to default value.

**Example**

```
OS10(config)# interface vlan 100
OS10(conf-if-vl-100)# ip igmp snooping query-max-resp-time 15
```

**Supported Releases** 10.4.1.0 or later

## ip igmp version

Configures IGMP version.

**Syntax** `ip igmp version version-number`

**Parameters** *version-number*—Enter the version number as 2 or 3.

**Default** 3

**Command Mode** VLAN INTERFACE

**Usage Information** The no version of this command resets the version number to the default value.

**Example**

```
OS10(config)# interface vlan 100
OS10(conf-if-vl-100)# ip igmp version 2
```

**Supported Releases** 10.4.1.0 or later

## show ip igmp groups

Displays the IGMP groups.

**Syntax** `show ip igmp [vrf vrf-name] groups [group-address [detail] | detail | interface-name [group-address [detail]]]`

**Parameters**

- *vrf vrf-name*—Enter the keyword *vrf*, then the name of the VRF.
- *group-address*—Enter the group address in dotted decimal format to view specific group information.
- *interface-name*—Enter the interface name.

**Default** None

**Command Mode** EXEC

**Usage Information** The `show ip igmp groups` command displays the IGMP database, configured entries for all groups on all interfaces, all groups on specific interfaces, or specific groups on specific interfaces. This command displays the following:

- *Group address*—Lists the multicast address for the IGMP group.
- *Interface*—Lists the interface type, slot, and port number.
- *Mode*—Displays the IGMP version used.
- *Uptime*—Displays the amount of time the group has been operational.
- *Expires*—Displays the amount of time until the entry expires.
- *Last reporter*—Displays the IP address of the last host to be a member of the IGMP group.

**Example**

```
OS10# show ip igmp groups
Total Number of Groups: 100
IGMP Connected Group Membership
Group Address Interface Mode Uptime Expires Last
Reporter
```



|            |         |               |          |          |            |
|------------|---------|---------------|----------|----------|------------|
| 225.1.1.1  | vlan121 | IGMPv2-Compat | 12:39:00 | 00:01:58 | 121.1.1.10 |
| 225.1.1.2  | vlan121 | IGMPv2-Compat | 12:39:00 | 00:01:58 | 121.1.1.10 |
| 225.1.1.3  | vlan121 | IGMPv2-Compat | 12:39:00 | 00:01:58 | 121.1.1.10 |
| 225.1.1.4  | vlan121 | IGMPv2-Compat | 12:39:00 | 00:01:58 | 121.1.1.10 |
| 225.1.1.5  | vlan121 | IGMPv2-Compat | 12:39:00 | 00:01:58 | 121.1.1.10 |
| 225.1.1.6  | vlan121 | IGMPv2-Compat | 12:39:00 | 00:01:58 | 121.1.1.10 |
| 225.1.1.7  | vlan121 | IGMPv2-Compat | 12:39:00 | 00:01:58 | 121.1.1.10 |
| 225.1.1.8  | vlan121 | IGMPv2-Compat | 12:39:00 | 00:01:58 | 121.1.1.10 |
| 225.1.1.9  | vlan121 | IGMPv2-Compat | 12:39:00 | 00:01:58 | 121.1.1.10 |
| 225.1.1.10 | vlan121 | IGMPv2-Compat | 12:39:00 | 00:01:58 | 121.1.1.10 |
| 225.1.1.11 | vlan121 | IGMPv2-Compat | 12:39:00 | 00:01:58 | 121.1.1.10 |
| 225.1.1.12 | vlan121 | IGMPv2-Compat | 12:39:00 | 00:01:58 | 121.1.1.10 |
| 225.1.1.13 | vlan121 | IGMPv2-Compat | 12:39:00 | 00:01:58 | 121.1.1.10 |
| 225.1.1.14 | vlan121 | IGMPv2-Compat | 12:39:00 | 00:01:58 | 121.1.1.10 |
| 225.1.1.15 | vlan121 | IGMPv2-Compat | 12:39:00 | 00:01:58 | 121.1.1.10 |
| 225.1.1.16 | vlan121 | IGMPv2-Compat | 12:39:00 | 00:01:58 | 121.1.1.10 |

**Supported Releases** 10.4.3.0 or later

## show ip igmp interface

Displays information about all IGMP-enabled interfaces.

**Syntax** show ip igmp [*vrf vrf-name*] interface *name*

**Parameters**

- *vrf vrf-name*—Enter the keyword *vrf*, then the name of the VRF.
- interface *name*—Enter the keyword *interface*, then the interface name.

**Default** None

**Command Mode** EXEC

**Usage Information** None

### Example

```
OS10# show ip igmp interface
Vlan103 is up, line protocol is up
Internet address is 2.1.1.2
IGMP is enabled on interface
IGMP version is 3
IGMP query interval is 60 seconds
IGMP querier timeout is 130 seconds
IGMP last member query response interval is 1000 ms
IGMP max response time is 10 seconds
IGMP immediate-leave is disabled on this interface
IGMP joins count: 0
IGMP querying router is 2.1.1.1

Vlan121 is up, line protocol is up
Internet address is 121.1.1.2
IGMP is enabled on interface
IGMP version is 3
IGMP query interval is 60 seconds
IGMP querier timeout is 130 seconds
IGMP last member query response interval is 1000 ms
IGMP max response time is 10 seconds
IGMP immediate-leave is disabled on this interface
IGMP joins count: 100
IGMP querying router is 121.1.1.2
```

**Supported Releases** 10.4.3.0 or later

## show ip igmp snooping groups

Displays IGMP snooping group membership details.

**Syntax** `show ip igmp snooping groups [detail | [vlan vlan-id [detail | ip-address]]]`

- Parameters**
- *vlan-id*—(Optional) Enter the VLAN ID, from 1 to 4093.
  - *detail*—(Optional) Enter *detail* to display the IGMPv3 source information.
  - *ip-address*—(Optional) Enter the IP address of the multicast group.

**Default** Not configured

**Command Mode** EXEC

**Usage Information** None

### Example

```
OS10# show ip igmp snooping groups
Total Number of Groups: 480
IGMP Connected Group Membership
Group Address Interface Mode
Expires
225.1.0.0 vlan3031 IGMPv2-Compat
00:01:26
 Member-ports :port-channel51,ethernet1/1/51:1,ethernet1/1/52:1
225.1.0.1 vlan3031 IGMPv2-Compat
00:01:26
 Member-ports :port-channel51,ethernet1/1/51:1,ethernet1/1/52:1
225.1.0.2 vlan3031 IGMPv2-Compat
00:01:26
 Member-ports :port-channel51,ethernet1/1/51:1,ethernet1/1/52:1
225.1.0.3 vlan3031 IGMPv2-Compat
00:01:26
 Member-ports :port-channel51,ethernet1/1/51:1,ethernet1/1/52:1
225.1.0.4 vlan3031 IGMPv2-Compat
00:01:26
 Member-ports :port-channel51,ethernet1/1/51:1,ethernet1/1/52:1
225.1.0.5 vlan3031 IGMPv2-Compat
00:01:26
 Member-ports :port-channel51,ethernet1/1/51:1,ethernet1/1/52:1
225.1.0.6 vlan3031 IGMPv2-Compat
00:01:26
 Member-ports :port-channel51,ethernet1/1/51:1,ethernet1/1/52:1
225.1.0.7 vlan3031 IGMPv2-Compat
00:01:26
 Member-ports :port-channel51,ethernet1/1/51:1,ethernet1/1/52:1
225.1.0.8 vlan3031 IGMPv2-Compat
00:01:26
 Member-ports :port-channel51,ethernet1/1/51:1,ethernet1/1/52:1
225.1.0.9 vlan3031 IGMPv2-Compat
00:01:26
 Member-ports :port-channel51,ethernet1/1/51:1,ethernet1/1/52:1
225.1.0.10 vlan3031 IGMPv2-Compat
00:01:26
--more--
<<Output Truncated>>
```

### Example (with VLAN)

```
OS10# show ip igmp snooping groups vlan 3031
Total Number of Groups: 12
IGMP Connected Group Membership
Group Address Interface Mode
Expires
225.1.0.0 vlan3031 IGMPv2-Compat
00:01:30
 Member-ports :port-channel51,ethernet1/1/51:1,ethernet1/1/52:1
225.1.0.1 vlan3031 IGMPv2-Compat
00:01:30
 Member-ports :port-channel51,ethernet1/1/51:1,ethernet1/1/52:1
```

```

225.1.0.2 vlan3031 IGMPv2-Compat
00:01:30
 Member-ports :port-channel51,ethernet1/1/51:1,ethernet1/1/52:1
225.1.0.3 vlan3031 IGMPv2-Compat
00:01:30
 Member-ports :port-channel51,ethernet1/1/51:1,ethernet1/1/52:1
225.1.0.4 vlan3031 IGMPv2-Compat
00:01:30
 Member-ports :port-channel51,ethernet1/1/51:1,ethernet1/1/52:1
225.1.0.5 vlan3031 IGMPv2-Compat
00:01:30
 Member-ports :port-channel51,ethernet1/1/51:1,ethernet1/1/52:1
225.1.0.6 vlan3031 IGMPv2-Compat
00:01:30
 Member-ports :port-channel51,ethernet1/1/51:1,ethernet1/1/52:1
225.1.0.7 vlan3031 IGMPv2-Compat
00:01:30
 Member-ports :port-channel51,ethernet1/1/51:1,ethernet1/1/52:1
225.1.0.8 vlan3031 IGMPv2-Compat
00:01:30
 Member-ports :port-channel51,ethernet1/1/51:1,ethernet1/1/52:1
225.1.0.9 vlan3031 IGMPv2-Compat
00:01:30
 Member-ports :port-channel51,ethernet1/1/51:1,ethernet1/1/52:1
225.1.0.10 vlan3031 IGMPv2-Compat
00:01:30
--more--

```

**Example (with VLAN and multicast IP address)**

```

OS10# show ip igmp snooping groups vlan 3031 225.1.0.0
IGMP Connected Group Membership
Group Address Interface Mode
Expires
225.1.0.0 vlan3031 IGMPv2-Compat
00:01:44
 Member-ports :port-channel51,ethernet1/1/51:1,ethernet1/1/52:1

```

**Example (with detail)**

```

OS10# show ip igmp snooping groups detail
Interface vlan10
Group 234.1.1.1
Source List
--
 Member Port Mode Uptime Expires
 ethernet1/1/36 Exclude 00:01:33 00:01:59
 ethernet1/1/38 Exclude 00:01:33 00:01:54
15.1.1.1
 Member Port Mode Uptime Expires
 ethernet1/1/36 Exclude 00:01:33 Never
21.1.1.1
 Member Port Mode Uptime Expires
 ethernet1/1/38 Exclude 00:01:33 Never

```

**Example (with VLAN)**

```

OS10# show ip igmp snooping groups vlan 3041 detail
Interface vlan3041
Group 232.11.0.0
Source List
101.41.0.21
 Member Port Mode Uptime Expires
 port-channel51 Include 1d:20:26:07 00:01:41
 ethernet1/1/51:1 Include 1d:20:26:05 00:01:46
 ethernet1/1/52:1 Include 1d:20:26:08 00:01:46

Interface vlan3041
Group 232.11.0.1
Source List
101.41.0.21
 Member Port Mode Uptime Expires
 port-channel51 Include 1d:20:26:07 00:01:41
 ethernet1/1/51:1 Include 1d:20:26:05 00:01:46

```

```

 ethernet1/1/52:1 Include 1d:20:26:08 00:01:46
Interface vlan3041
Group 232.11.0.2
Source List
 101.41.0.21
 Member Port Mode Uptime Expires
 port-channel51 Include 1d:20:26:07 00:01:41
--more--

```

**Example (with VLAN and multicast IP address)**

```

OS10# show ip igmp snooping groups vlan 3041 232.11.0.0 detail
Interface vlan3041
Group 232.11.0.0
Source List
 101.41.0.21
 Member Port Mode Uptime Expires
 port-channel51 Include 1d:20:27:36 00:01:09
 ethernet1/1/51:1 Include 1d:20:27:34 00:01:07
 ethernet1/1/52:1 Include 1d:20:27:37 00:01:07

```

**Supported Releases** 10.4.0E(R1) or later

## show ip igmp snooping interface

Displays IGMP snooping interfaces details.

**Syntax** show ip igmp snooping interface [vlan *vlan-id*]

**Parameters** *vlan-id*—(Optional) Enter the VLAN ID, from 1 to 4093.

**Default** Not configured

**Command Mode** EXEC

**Usage Information** The multicast flood control feature is not available on the S4248FB-ON and S4248FBL-ON devices.

**Example**

```

OS10# show ip igmp snooping interface
Vlan3031 is up, line protocol is up
IGMP version is 3
IGMP snooping is enabled on interface
IGMP snooping query interval is 60 seconds
IGMP snooping querier timeout is 130 seconds
IGMP snooping last member query response interval is 1000 ms
IGMP Snooping max response time is 10 seconds
IGMP snooping fast-leave is disabled on this interface
IGMP snooping querier is enabled on this interface

Vlan3032 is up, line protocol is up
IGMP version is 3
IGMP snooping is enabled on interface
IGMP snooping query interval is 60 seconds
IGMP snooping querier timeout is 130 seconds
IGMP snooping last member query response interval is 1000 ms
IGMP Snooping max response time is 10 seconds
IGMP snooping fast-leave is disabled on this interface
IGMP snooping querier is enabled on this interface

Vlan3033 is up, line protocol is up
IGMP version is 3
--more--
<<Output Truncated>>

```

```

OS10# show ip igmp snooping interface
Vlan2 is up, line protocol is up
IGMP version is 3

```

```

IGMP snooping is enabled on interface
IGMP snooping query interval is 60 seconds
IGMP snooping querier timeout is 130 seconds
IGMP snooping last member query response interval is 1000 ms
IGMP Snooping max response time is 10 seconds
IGMP snooping fast-leave is disabled on this interface
IGMP snooping querier is disabled on this interface
Multicast snooping flood-restrict is enabled on this interface

```

```

Vlan3 is up, line protocol is up
IGMP version is 3
IGMP snooping is enabled on interface
IGMP snooping query interval is 60 seconds
IGMP snooping querier timeout is 130 seconds
IGMP snooping last member query response interval is 1000 ms
IGMP Snooping max response time is 10 seconds
IGMP snooping fast-leave is disabled on this interface
IGMP snooping querier is disabled on this interface
Multicast snooping flood-restrict is enabled on this interface

```

### Example (with VLAN)

```

OS10# show ip igmp snooping interface vlan 3031
Vlan3031 is up, line protocol is up
IGMP version is 3
IGMP snooping is enabled on interface
IGMP snooping query interval is 60 seconds
IGMP snooping querier timeout is 130 seconds
IGMP snooping last member query response interval is 1000 ms
IGMP Snooping max response time is 10 seconds
IGMP snooping fast-leave is disabled on this interface
IGMP snooping querier is enabled on this interface

```

```

OS10# show ip igmp snooping interface vlan 3031
Vlan3031 is up, line protocol is up
IGMP version is 3
IGMP snooping is enabled on interface
IGMP snooping query interval is 60 seconds
IGMP snooping querier timeout is 130 seconds
IGMP snooping last member query response interval is 1000 ms
IGMP Snooping max response time is 10 seconds
IGMP snooping fast-leave is disabled on this interface
IGMP snooping querier is enabled on this interface
Multicast snooping flood-restrict is enabled on this interface

```

### Supported Releases

10.4.0E(R1) or later Updated the command to display the multicast flood restrict status on 10.4.3.0 or later

## show ip igmp snooping mrouter

Displays the multicast router ports details.

**Syntax** `show ip igmp snooping mrouter [vlan vlan-id]`

**Parameters** *vlan-id*—(Optional) Enter the VLAN ID, from 1 to 4093.

**Default** Not configured

**Command Mode** EXEC

**Usage Information** None

### Example

```

OS10# show ip igmp snooping mrouter
Interface Router Ports
vlan3031 port-channel31
vlan3032 port-channel31
vlan3033 port-channel31
vlan3034 port-channel31

```

```

vlan3035 port-channel31
vlan3036 port-channel31
vlan3037 port-channel31
vlan3038 port-channel31
vlan3039 port-channel31
vlan3040 port-channel31
vlan3041 port-channel31
vlan3042 port-channel31
vlan3043 port-channel31
vlan3044 port-channel31
vlan3045 port-channel31
vlan3046 port-channel31
vlan3047 port-channel31
vlan3048 port-channel31
vlan3049 port-channel31
vlan3050 port-channel31
vlan3051 port-channel31
vlan3052 port-channel31
--more--

```

<<Output Truncated>>

#### Example (with VLAN)

```

OS10# show ip igmp snooping mrouter vlan 3031
Interface Router Ports
vlan3031 port-channel31

```

#### Supported Releases

10.4.0E(R1) or later

## Multicast Listener Discovery Protocol

IPv6 networks use Multicast Listener Discovery (MLD) Protocol to manage multicast groups.

OS10 supports MLDv1 and MLDv2 to manage the multicast group memberships on IPv6 networks.

### MLD snooping

MLD snooping enables switches to use the information in MLD packets and generate a forwarding table that associates ports with multicast groups. When switches receive multicast frames, they forward them to their intended receivers.

OS10 supports MLD snooping on VLAN interfaces. Effective with OS10 release 10.4.3.0, MLD snooping is enabled by default.

#### Configure MLD snooping

- Enable MLD snooping globally with the `ipv6 mld snooping enable` command in the CONFIGURATION mode. This command enables both MLDv2 and MLDv1 snooping on all VLAN interfaces.
- (Optional) You can disable MLD snooping on specific VLAN interfaces using the `no ipv6 mld snooping` command in the VLAN INTERFACE mode.
- (Optional) Multicast flood control is enabled by default. To disable the multicast flood restrict feature, use the `no multicast snooping flood-restrict` command in CONFIGURATION mode. To reenabling the feature globally, use the `ip igmp snooping enable` command in CONFIGURATION mode.
- In a network, the snooping switch is connected to a multicast Router that sends MLD queries. On a Layer 2 network that does not have a multicast router, you can configure the snooping switch to act as querier. Use the `ipv6 mld snooping querier` command in the VLAN INTERFACE mode to send the queries.
- OS10 learns the multicast router interface dynamically based on the interface on which MLD membership query is received. To assign a multicast router interface statically, use the `ipv6 mld snooping mrouter interface interface-type` command in VLAN INTERFACE mode.
- (Optional) Configure the MLD version using the `ipv6 mld version version-number` command in the VLAN INTERFACE mode.
- (Optional) The fast leave option allows the MLD snooping switch to remove an interface from the multicast group immediately on receiving the leave message. Enable fast leave with the `ipv6 mld snooping fast-leave` command in VLAN INTERFACE mode.

- (Optional) Configure the time interval for sending MLD general queries with the `ipv6 mld snooping query-interval query-interval-time` command in VLAN INTERFACE mode.
- (Optional) Configure the maximum time for responding to a query advertised in MLD queries using the `ipv6 mld snooping query-max-resp-time query-response-time` command in VLAN INTERFACE mode.
- (Optional) Configures the time interval between group-specific MLD query messages with the `ipv6 mld snooping last-member-query-interval query-interval-time` command in VLAN INTERFACE mode.

### MLD snooping configuration

```
OS10(config)# ipv6 mld snooping enable
OS10(config)# interface vlan 11
OS10(conf-if-vl-11)# ipv6 mld snooping mrouter interface ethernet 1/1/32
OS10(conf-if-vl-11)# ipv6 mld snooping querier
OS10(conf-if-vl-11)# ipv6 mld version 1
OS10(conf-if-vl-11)# ipv6 mld snooping fast-leave
OS10(conf-if-vl-11)# ipv6 mld snooping query-interval 60
OS10(conf-if-vl-11)# ipv6 mld snooping query-max-resp-time 10
OS10(conf-if-vl-11)# ipv6 mld snooping last-member-query-interval 1000
```

### View MLD snooping information

```
OS10# show ipv6 mld snooping groups
Total Number of Groups: 280
MLD Connected Group Membership
Group Address Interface
Mode Expires
ff02::2 vlan3531
Exclude 00:01:38
ff0e:225:1:: vlan3531 MLDv1-
Compat 00:01:52
 Member-ports :port-channel41,ethernet1/1/51,ethernet1/1/52
ff0e:225:1::1 vlan3531 MLDv1-
Compat 00:01:52
 Member-ports :port-channel41,ethernet1/1/51,ethernet1/1/52
ff0e:225:1::2 vlan3531 MLDv1-
Compat 00:01:52
 Member-ports :port-channel41,ethernet1/1/51,ethernet1/1/52
ff0e:225:1::3 vlan3531 MLDv1-
Compat 00:01:52
 Member-ports :port-channel41,ethernet1/1/51,ethernet1/1/52
ff0e:225:1::4 vlan3531 MLDv1-
Compat 00:01:52
 Member-ports :port-channel41,ethernet1/1/51,ethernet1/1/52
ff0e:225:1::5 vlan3531 MLDv1-
Compat 00:01:52
 Member-ports :port-channel41,ethernet1/1/51,ethernet1/1/52
ff02::2 vlan3532
Exclude 00:01:47
ff0e:225:2:: vlan3532 MLDv1-
Compat 00:01:56
 Member-ports :port-channel41,ethernet1/1/51,ethernet1/1/52
ff0e:225:2::1 vlan3532 MLDv1-
Compat 00:01:56
 Member-ports :port-channel41,ethernet1/1/51,ethernet1/1/52
ff0e:225:2::2 vlan3532 MLDv1-
Compat 00:01:56
 Member-ports :port-channel41,ethernet1/1/51,ethernet1/1/52
--more--
<<Output Truncated>>
```

```
OS10# show ipv6 mld snooping interface vlan 3031
Vlan3031 is up, line protocol is up
MLD version is 2
MLD snooping is enabled on interface
MLD snooping query interval is 60 seconds
MLD snooping querier timeout is 130 seconds
MLD snooping last member query response interval is 1000 ms
MLD snooping max response time is 10 seconds
```

```
MLD snooping fast-leave is disabled on this interface
MLD snooping querier is disabled on this interface
```

```
OS10# show ipv6 mld snooping interface vlan 2
Vlan2 is up, line protocol is up
MLD version is 2
MLD snooping is enabled on interface
MLD snooping query interval is 60 seconds
MLD snooping querier timeout is 130 seconds
MLD snooping last member query response interval is 1000 ms
MLD snooping max response time is 10 seconds
MLD snooping fast-leave is disabled on this interface
MLD snooping querier is disabled on this interface
Multicast flood-restrict is enabled on this interface
```

```
OS10# show ipv6 mld snooping mrouter vlan 11
Interface Router Ports
Vlan 11 ethernet 1/1/32
```

## MLD snooping commands

### ipv6 mld snooping

Enables MLD snooping on the specified VLAN interface.

**Syntax**            `ipv6 mld snooping`

**Parameters**        None

**Default**            Enabled

**Command Mode**     VLAN INTERFACE

**Usage Information**    When you enable MLD snooping globally, the configuration is applied to all the VLAN interfaces. You can disable the MLD snooping on specified VLAN interfaces. The `no` version of this command disables the MLD snooping on the specified VLAN interface.

**Example**

```
OS10(config)# interface vlan 100
OS10(conf-if-vl-100)# no ipv6 mld snooping
```

**Supported Releases**    10.4.1.0 or later

### ipv6 mld snooping enable

Enables MLD snooping globally.

**Syntax**            `ipv6 mld snooping enable`

**Parameters**        None

**Default**            Enabled

**Command Mode**     CONFIGURATION

**Usage Information**    The `no` version of this command disables the MLD snooping.

**Example**

```
OS10(config)# ipv6 mld snooping enable
```

**Supported Releases**    10.4.1.0 or later



## ipv6 mld snooping fast-leave

Enables fast leave in MLD snooping for specified VLAN.

**Syntax** `ipv6 mld snooping fast-leave`

**Parameters** None

**Default** Disabled

**Command Mode** VLAN INTERFACE

**Usage Information** The fast leave option allows the MLD snooping switch to remove an interface from the multicast group immediately on receiving the leave message. The `no` version of this command disables the fast leave functionality.

**Example**

```
OS10(config)# interface vlan 100
OS10(conf-if-vl-100)# ipv6 mld snooping fast-leave
```

**Supported Releases** 10.4.1.0 or later

## ipv6 mld snooping last-member-query-interval

Configures the time interval between group-specific MLD query messages.

**Syntax** `ipv6 mld snooping last-member-query-interval query-interval-time`

**Parameters** *query-interval-time*—Enter the query time interval in milliseconds, ranging from 100 to 65535.

**Default** 1000 milliseconds

**Command Mode** VLAN INTERFACE

**Usage Information** The `no` version of this command resets the last member query interval time to the default value.

**Example**

```
OS10(config)# interface vlan 100
OS10(conf-if-vl-100)# ipv6 mld snooping last-member-query-interval 2500
```

**Supported Releases** 10.4.1.0 or later

## ipv6 mld snooping mrouter

Configures the specified VLAN member port as a multicast router interface.

**Syntax** `ipv6 mld snooping mrouter interface interface-type`

**Parameters** *interface-type*—Enter the interface type details. The interface must be a member of the VLAN.

**Default** Not configured

**Command Mode** VLAN INTERFACE

**Usage Information** The `no` version of this command removes the multicast router configuration from the VLAN member port.

**Example**

```
OS10(config)# interface vlan 100
OS10(conf-if-vl-100)# ipv6 mld snooping mrouter interface ethernet 1/1/1
```

**Supported Releases** 10.4.1.0 or later

## ipv6 mld snooping querier

Enables MLD querier on the specified VLAN interface.

**Syntax** `ipv6 mld snooping querier`

**Parameters** None

**Default** Not configured

**Command Mode** VLAN INTERFACE

**Usage Information** The `no` version of this command disables the MLD querier on the VLAN interface.

### Example

```
OS10(config)# interface vlan 100
OS10(conf-if-vl-100)# ipv6 mld snooping querier
```

**Supported Releases** 10.4.1.0 or later

## ipv6 mld snooping query-interval

Configures the time interval for sending MLD general queries.

**Syntax** `ipv6 mld snooping query-interval query-interval-time`

**Parameters** *query-interval-time*—Enter the interval time in seconds, ranging from 2 to 18000.

**Default** 60 seconds

**Command Mode** VLAN INTERFACE

**Usage Information** The `no` version of this command resets the query interval to the default value.

### Example

```
OS10(config)# interface vlan 100
OS10(conf-if-vl-100)# ipv6 mld snooping query-interval 120
```

**Supported Releases** 10.4.1.0 or later

## ipv6 mld query-max-resp-time

Configures the maximum time for responding to a query advertised in MLD queries.

**Syntax** `ipv6 mld snooping query-max-resp-time query-response-time`

**Parameters** *query-response-time*—Enter the query response time in seconds, ranging from 1 to 25.

**Default** 10 seconds

**Command Mode** VLAN INTERFACE

**Usage Information** The `no` version of this command resets the query response time to default value.

### Example

```
OS10(config)# interface vlan 100
OS10(conf-if-vl-100)# ipv6 mld snooping query-max-resp-time 15
```

**Supported Releases** 10.4.1.0 or later

## ipv6 mld version

Configures the MLD version.

|                          |                                                                                |
|--------------------------|--------------------------------------------------------------------------------|
| <b>Syntax</b>            | <code>ipv6 mld version version-number</code>                                   |
| <b>Parameters</b>        | <code>version-number</code> —Enter the version number as 1 or 2.               |
| <b>Default</b>           | 2                                                                              |
| <b>Command Mode</b>      | VLAN INTERFACE                                                                 |
| <b>Usage Information</b> | The no version of this command resets the version number to the default value. |

### Example

```
OS10(config)# interface vlan 100
OS10(conf-if-vl-100)# ipv6 mld version 1
```

**Supported Releases** 10.4.1.0 or later

## show ipv6 mld snooping groups

Displays MLD snooping group membership details.

|                          |                                                                                                                                                                                                                |
|--------------------------|----------------------------------------------------------------------------------------------------------------------------------------------------------------------------------------------------------------|
| <b>Syntax</b>            | <code>show ipv6 mld snooping groups [vlan vlan-id] [ipv6-address]</code>                                                                                                                                       |
| <b>Parameters</b>        | <ul style="list-style-type: none"><li><code>vlan-id</code>—(Optional) Enter the VLAN ID, from 1 to 4093.</li><li><code>ipv6-address</code>—(Optional) Enter the IPv6 address of the multicast group.</li></ul> |
| <b>Default</b>           | Not configured                                                                                                                                                                                                 |
| <b>Command Mode</b>      | EXEC                                                                                                                                                                                                           |
| <b>Usage Information</b> | None                                                                                                                                                                                                           |

### Example

```
OS10# show ipv6 mld snooping groups
Total Number of Groups: 280
MLD Connected Group Membership
Group Address Interface
Mode Expires
ff02::2 vlan3531
Exclude 00:01:38
ff0e:225:1:: vlan3531 MLDv1-
Compat 00:01:52
 Member-ports :port-channel41,ethernet1/1/51,ethernet1/1/52
ff0e:225:1::1 vlan3531 MLDv1-
Compat 00:01:52
 Member-ports :port-channel41,ethernet1/1/51,ethernet1/1/52
ff0e:225:1::2 vlan3531 MLDv1-
Compat 00:01:52
 Member-ports :port-channel41,ethernet1/1/51,ethernet1/1/52
ff0e:225:1::3 vlan3531 MLDv1-
Compat 00:01:52
 Member-ports :port-channel41,ethernet1/1/51,ethernet1/1/52
ff0e:225:1::4 vlan3531 MLDv1-
Compat 00:01:52
 Member-ports :port-channel41,ethernet1/1/51,ethernet1/1/52
ff0e:225:1::5 vlan3531 MLDv1-
Compat 00:01:52
 Member-ports :port-channel41,ethernet1/1/51,ethernet1/1/52
ff02::2 vlan3532
Exclude 00:01:47
ff0e:225:2:: vlan3532 MLDv1-
Compat 00:01:56
 Member-ports :port-channel41,ethernet1/1/51,ethernet1/1/52
ff0e:225:2::1 vlan3532 MLDv1-
```

```

Compat 00:01:56
 Member-ports :port-channel41,ethernet1/1/51,ethernet1/1/52
ff0e:225:2::2 vlan3532 MLDv1-
Compat 00:01:56
 Member-ports :port-channel41,ethernet1/1/51,ethernet1/1/52
<Output Truncated>

```

### Example (with VLAN)

```

OS10# show ipv6 mld snooping groups vlan 3531
Total Number of Groups: 7
MLD Connected Group Membership
Group Address Interface Mode Expires
ff02::2 vlan3531 Exclude 00:02:08
ff0e:225:1:: vlan3531 MLDv1-Compat 00:02:12
 Member-ports :port-channel41,ethernet1/1/51,ethernet1/1/52
ff0e:225:1::1 vlan3531 MLDv1-Compat 00:02:12
 Member-ports :port-channel41,ethernet1/1/51,ethernet1/1/52
ff0e:225:1::2 vlan3531 MLDv1-Compat 00:02:12
 Member-ports :port-channel41,ethernet1/1/51,ethernet1/1/52
ff0e:225:1::3 vlan3531 MLDv1-Compat 00:02:12
 Member-ports :port-channel41,ethernet1/1/51,ethernet1/1/52
ff0e:225:1::4 vlan3531 MLDv1-Compat 00:02:12
 Member-ports :port-channel41,ethernet1/1/51,ethernet1/1/52
ff0e:225:1::5 vlan3531 MLDv1-Compat 00:02:12
 Member-ports :port-channel41,ethernet1/1/51,ethernet1/1/52

```

### Example (with VLAN and multicast IP address)

```

OS10# show ipv6 mld snooping groups vlan 3531 ff0e:225:1::
MLD Connected Group Membership
Group Address Interface Mode Expires
ff0e:225:1:: vlan3531 MLDv1-Compat 00:01:30
 Member-ports :port-channel41,ethernet1/1/51,ethernet1/1/52

```

### Supported Releases

10.4.0E(R1) or later

## show ipv6 mld snooping groups detail

Displays the MLD source information along with detailed member port information.

**Syntax** `show ipv6 mld snooping groups [vlan vlan-id] [group ipv6-address] detail`

- Parameters**
- *vlan-id*—(Optional) Enter the VLAN ID, from 1 to 4093.
  - *ipv6-address*—(Optional) Enter the IPv6 address of the multicast group.

**Default** Not configured

**Command Mode** EXEC

**Usage Information** None

### Example

```

OS10# show ipv6 mld snooping groups detail
Interface vlan3041
Group ff02::2
Source List
--
 Member Port Mode Uptime Expires
 port-channel31 Exclude 2d:11:57:08 00:01:44

Interface vlan3041
Group ff3e:232:b::
Source List
2001:101:29::1b
 Member Port Mode Uptime Expires
 port-channel31 Include 2d:11:50:17 00:01:42
 ethernet1/1/51:1 Include 2d:11:50:36 00:01:38

```

```

ethernet1/1/52:1 Include 2d:11:50:36 00:01:25
Interface vlan3041
Group ff3e:232:b::1
Source List
 2001:101:29::1b
 Member Port Mode Uptime Expires
 port-channel31 Include 2d:11:50:17 00:01:29
 ethernet1/1/51:1 Include 2d:11:50:36 00:01:25
 ethernet1/1/52:1 Include 2d:11:50:36 00:01:38
<Output Truncated>

```

### Example (with VLAN)

```

OS10# show ipv6 mld snooping groups vlan 3041 detail
Interface vlan3041
Group ff02::2
Source List
--
 Member Port Mode Uptime Expires
 port-channel31 Exclude 2d:11:57:08 00:01:44

Interface vlan3041
Group ff3e:232:b::
Source List
 2001:101:29::1b
 Member Port Mode Uptime Expires
 port-channel31 Include 2d:11:50:17 00:01:42
 ethernet1/1/51:1 Include 2d:11:50:36 00:01:38
 ethernet1/1/52:1 Include 2d:11:50:36 00:01:25

Interface vlan3041
Group ff3e:232:b::1
Source List
 2001:101:29::1b
 Member Port Mode Uptime Expires
 port-channel31 Include 2d:11:50:17 00:01:29
 ethernet1/1/51:1 Include 2d:11:50:36 00:01:25
 ethernet1/1/52:1 Include 2d:11:50:36 00:01:38
<Output Truncated>

```

### Example (with VLAN and multicast IP address)

```

OS10# show ipv6 mld snooping groups vlan 3041 ff3e:232:b:: detail
Interface vlan3041
Group ff3e:232:b::
Source List
 2001:101:29::1b
 Member Port Mode Uptime Expires
 port-channel31 Include 2d:11:50:53 00:02:01
 ethernet1/1/51:1 Include 2d:11:51:11 00:02:01
 ethernet1/1/52:1 Include 2d:11:51:12 00:01:52

```

**Supported Releases** 10.4.1.0 or later

## show ipv6 mld snooping interface

Displays the details of MLD snooping interfaces.

**Syntax** `show ipv6 mld snooping interface [vlan vlan-id]`

**Parameters** *vlan-id*—(Optional) Enter the VLAN ID, from 1 to 4093.

**Default** Not configured

**Command Mode** EXEC

**Usage Information** The multicast flood control feature is not available on the S4248FB-ON and S4248FBL-ON devices.

## Example

```
OS10# show ipv6 mld snooping interface vlan 3031
Vlan3031 is up, line protocol is up
MLD version is 2
MLD snooping is enabled on interface
MLD snooping query interval is 60 seconds
MLD snooping querier timeout is 130 seconds
MLD snooping last member query response interval is 1000 ms
MLD snooping max response time is 10 seconds
MLD snooping fast-leave is disabled on this interface
MLD snooping querier is disabled on this interface
```

```
OS10# show ipv6 mld snooping interface vlan 2
Vlan2 is up, line protocol is up
MLD version is 2
MLD snooping is enabled on interface
MLD snooping query interval is 60 seconds
MLD snooping querier timeout is 130 seconds
MLD snooping last member query response interval is 1000 ms
MLD snooping max response time is 10 seconds
MLD snooping fast-leave is disabled on this interface
MLD snooping querier is disabled on this interface
Multicast flood-restrict is enabled on this interface
```

**Supported Releases** 10.4.1.0 or later

## show ipv6 mld snooping mrouter

Displays the details of multicast router ports.

**Syntax** `show ipv6 mld snooping mrouter [vlan vlan-id]`

**Parameters** *vlan-id*—(Optional) Enter the VLAN ID, ranging from 1 to 4093.

**Default** Not configured

**Command Mode** EXEC

**Usage Information** None

### Example

```
OS10# show ipv6 mld snooping mrouter vlan 11
Interface Router Ports
Vlan 11 ethernet 1/1/32
```

**Supported Releases** 10.4.1.0 or later

## Protocol Independent Multicast

Protocol independent multicast (PIM) is a group of multicast routing protocols that provides one-to-many and many-to-many transmission of information. PIM uses routing information from other routing protocols and does not depend on any specific unicast routing protocol. PIM uses any unicast routing protocol that is deployed in the network. OS10 supports the following PIM modes:

- PIM sparse mode (PIM-SM)
- PIM source specific multicast (PIM-SSM)

# PIM terminology

Table 40. PIM terminology

| Terminology                   | Definition                                                                                                                                                                                |
|-------------------------------|-------------------------------------------------------------------------------------------------------------------------------------------------------------------------------------------|
| Rendezvous point (RP)         | The RP is a single root node that the shared tree uses, called the rendezvous point.                                                                                                      |
| (*, G)                        | (*, G) refers to an entry in the PIM table for a group.                                                                                                                                   |
| (S, G)                        | (S, G) refers to an entry in the PIM table for a source and group on the RP tree (RPT).                                                                                                   |
| (S, G, RPT)                   | (S, G, RPT) refers to an entry in the RP tree.                                                                                                                                            |
| First hop router (FHR)        | The FHR is the router that is directly connected to the multicast source.                                                                                                                 |
| Last hop router (LHR)         | The LHR is the last router in the multicast path and is directly connected to the multicast receiver.                                                                                     |
| Intermediate router           | A PIM router that is not an FHR, RP, or LHR.                                                                                                                                              |
| Shared tree (RPT)             | The RPT is an unidirectional multicast tree whose root node is the RP.                                                                                                                    |
| Shortest path tree (SPT)      | The root node of the SPT is the multicast source. The multicast traffic routes to the receiver on the shortest path. This setup reduces network latency and traffic congestion at the RP. |
| Outgoing interface (OIF)      | The OIF is the interface through which a multicast packet is sent out towards the receiver.                                                                                               |
| Incoming interface (IIF)      | The IIF is the interface through which a multicast packet is received towards the source or the RP.                                                                                       |
| Reverse path forwarding (RPF) | The RPF is the path the router uses to reach the RP or the multicast source.                                                                                                              |

## Standards compliance

OS10 complies to the following standards:

- RFC 4601 for PIM-SM
- RFC 3569 for PIM-SSM

## PIM-SM

PIM sparse mode (PIM-SM) is a multicast routing protocol for networks with receivers that are sparsely distributed. Receivers have to explicitly send a *join* message to join particular groups or sources. PIM join and prune messages are used to join and leave multicast distribution trees.

PIM-SM uses shared trees with the root node being the rendezvous point (RP). All multicast sources use the RP to route the traffic to the receiver. The last hop router (LHR) sends an (\*,G) join message towards the RP. The designated router connected to the first hop router (FHR) encapsulates multicast data that comes from the multicast source in PIM control messages and sends it via unicast to the RP as PIM register messages. The RP sends an (S, G) join towards the source. When the RP receives native data traffic from the source, it sends a register stop message to the FHR.

OS10 supports static and dynamic configuration of an RP address for a multicast group.

To keep the PIM-SM state alive, all PIM neighbors send periodic hello messages.

You must enable PIM-SM on each of the participating interfaces. Be sure to have multicast routing enabled on the system. To do this, use the `ip multicast-routing` command from CONFIGURATION mode.

```
OS10# configure terminal
OS10(config)# interface vlan 100
OS10(conf-if-vl-100)# ip pim sparse-mode
```

## PIM-SSM

PIM-SSM uses source-based trees. A separate multicast distribution tree is built for each multicast source that sends data to a multicast group. Each multicast distribution tree has as its root node a router near the source. Sources send data directly to the root of the tree. PIM-SSM enables receivers to specify the source from which to receive data and the multicast group they want to join. The receiver identifies a multicast data stream using the source and group address pair (S, G) instead of the group address alone (\*, G).

### NOTE:

- PIM-SSM requires receivers to support IGMP version 3.
- The default PIM-SSM range is 232.0.0.0/8. The default range is always supported and the range can never be smaller than the default.
- If the PIM-SSM group range overlaps with the multicast group range that the candidate RP advertises, the router chooses the RP learned from the BSR and creates (\*, G) entries instead of (S, G) entries.

## Advantages of PIM-SSM

Advantages of PIM-SSM include the following:

- PIM-SSM forwards multicast traffic from a single source to a subnet. Other versions of PIM requires the receiver to subscribe to a group. The receiver receives traffic not just from the source that it is interested in, but from all the sources that send to that group. PIM-SSM requires the receiver to specify the sources in which they are interested in to avoid receiving unnecessary traffic.
- PIM-SSM is more efficient than PIM-SM because it immediately creates shortest path trees (SPT) to the source rather than using shared trees. PIM-SM requires a shared tree rooted at the RP because IGMPv2 receivers do not express the source information in their membership reports. Multicast traffic passes from the source to the receiver through the RP, until the last hop router (LHR) learns the source address, at which point it switches to the SPT.
- PIM-SSM uses IGMPv3 because receivers subscribe to a source and group, the RP and shared tree are unnecessary; only SPTs are used. On OS10 systems, it is possible to use PIM-SM with IGMPv3 to achieve the same result, but PIM-SSM eliminates the unnecessary protocol overhead.

## Configure PIM-SSM

To configure a group range for PIM-SSM:

 **NOTE:** The IP range, 232.0.0.0/8 is reserved for SSM. You do not have to explicitly configure this range.

1. Create an ACL rule to specify the range of addresses that should use SSM.

```
OS10# configure terminal
OS10(config)# ip access-list ssm-1
OS10(config-ipv4-acl)# permit ip any 236.0.0.0/8
OS10(config-ipv4-acl)# exit
```

2. Enable PIM-SSM for the range of addresses using the `ip pim ssm-range` command.

```
OS10(config)# ip pim ssm-range ssm-1
```



You can use the `show ip pim ssm-range` command to view the groups added in PIM-SSM configuration.

```
OS10# show ip pim ssm-range
Group Address / MaskLen
236.0.0.0 / 8
```

## Configure expiry timers for S, G entries

You can configure expiry timers for S, G entries globally. The S, G entries expire in 210 seconds by default.

To configure the S, G expiry timer:

```
OS10# configure terminal
OS10(config)# ip pim sparse-mode sg-expiry-timer 500
```

## Configure static rendezvous point

The rendezvous point (RP) is an interface on a router that acts as the root to a group-specific tree; every group must have an RP. You must configure the RP on all nodes in your network.

To configure a static RP:

```
OS10# configure terminal
OS10(config)# ip pim rp-address 171.1.1.1 group-address 225.1.1.3/32
```

## Override bootstrap router updates

A bootstrap router (BSR) is a router in a PIM domain that helps to automatically discover the RP for a given multicast group in a multicast network. PIM routers use the BSR to obtain the RP IP address. You can also statically configure an IP address for the RP. If you configure a static RP for a group, to override BSR updates with the static RP configuration, use the `override` option in the `ip pim rp-address` command. If you do not explicitly use the `override` option and:

- The prefix length of the static RP is the same as the RP advertised in the BSR updates, the BSR RP takes precedence over the statically configured RP.
- If the prefix length of the static RP and the BSR RP does not match, OS10 selects the router having the longest-match prefix as the RP.

To override BSR updates:

```
OS10# configure terminal
OS10(config)# ip pim rp-address 20.1.1.1 255.1.2.3/24 override
```

**NOTE:** If you have enabled the `override` option, configuring static RP without using the `override` option does not remove the `override` configuration. You must delete the static RP configuration using the `override` option and then reconfigure static RP again.

To view the RP for a multicast group, use the `show ip pim rp` command.

```
OS10# show ip pim rp
Group RP

225.1.1.1 171.1.1.1
225.1.1.2 171.1.1.1
225.1.1.3 171.1.1.1
225.1.1.4 171.1.1.1
225.1.1.5 171.1.1.1
225.1.1.6 171.1.1.1
```

To view the RP for a multicast group range, use the `show ip pim rp mapping` command.

```
OS10# show ip pim rp mapping
PIM Group-to-RP Mappings
Group(s): 230.1.1.1/32
RP:14.1.1.1, v2
 Info source: 42.1.1.1, via bootstrap, priority 255
 expires: 00:01:53

Group(s): 231.1.1.1/32
RP: 9.1.1.1, v2
 Info source: 42.1.1.1, via bootstrap, priority 254
 expires: 00:01:54
```

## Configure dynamic RP using the BSR mechanism

You can configure a subset of PIM routers within the domain as candidate BSRs (C-BSRs). The C-BSRs exchange bootstrap messages (BSM) to elect the BSR. The BSR informs its status to all the routers.

Every PIM router within a domain must map a particular multicast group address to the same RP. With BSR, group-to-RP mapping is dynamic. You can configure a subset of routers within a domain as C-RPs. Each PIM router selects an RP for a multicast group from the list of group-to-RP mappings learnt from the BSR messages.

The RP election process is:

1. The C-BSRs announce their candidacy throughout the domain in BSMs. Each BSM contains a BSR priority. The C-BSR with the highest priority becomes the BSR.
2. Each C-RP unicasts periodic candidate RP advertisements to the BSR. Each message contains an RP priority value and the multicast group ranges for which the router is a C-RP.
3. The BSR determines the most efficient and stable group-to-RP mapping, which is called the RP-set formation.
4. The BSR sends the group-to-RP mapping sets to all the multicast routers. To select an RP from a set of RPs, multicast routers use the algorithm that is specified in RFC 4601.
5. The BSR sends the group range-to-RP mappings to all the routers in the domain.

## Configuration notes

- A PIM router supports only one candidate BSR per VRF instance.
- A PIM router supports only one candidate RP per VRF instance.
- You can configure a PIM BSR candidate and an RP candidate with Layer 3 (L3) VLAN, Loopback, physical, or port channel interface. The system derives the IP address from this interface to determine the BSR or RP address.
- PIM BSR and RP candidate configurations are not supported on VXLAN bridge interfaces.
- **Before you configure a candidate BSR:**
  - Enable multicast routing globally and establish PIM neighborship between routers. Ensure that the unicast routing table is populated.
  - Configure an IP address on the candidate BSR interface.
- **Before you configure a candidate RP:**
  - Enable multicast routing globally and establish PIM neighborship between routers. Ensure that the unicast routing table is populated.
  - Ensure that the candidate RP can reach all the nodes in your network.
  - (Optional) Configure an ACL with source as `any` and destination as a valid multicast group address. If you do not configure an ACL, the router advertises itself as the RP for the entire multicast range, which is 224.0.0.0/4.

### NOTE:

- When you associate an ACL without any rules to an RP candidate, the system behaves differently depending on the order of the configuration:
  - If you create the ACL without any rules first and then associate it with the RP candidate, the router denies all multicast groups.
  - If you associate an ACL to an RP candidate that is not yet created in the system, and then configure the ACL without any rules, the router advertises itself as the RP for the entire multicast range, 224.0.0.0/4.

- Do not use deny rules in the ACL that is used for RP candidate because it does not have any significance.

To configure dynamic RP using the BSR mechanism:

1. Configure a candidate BSR using the `ip pim bsr-candidate` command.

```
OS10# configure terminal
OS10(config)# interface ethernet 1/1/9
OS10(config-if-eth1/1/9)# ip address 10.1.1.8/24
OS10(config-if-eth1/1/9)# no shutdown
OS10(config-if-eth1/1/9)# exit
OS10(config)# ip pim bsr-candidate ethernet 1/1/9 hash-mask-len 31 priority 255
```

To view the PIM candidate and elected BSR:

```
OS10# show ip pim bsr-router

This system is the Bootstrap Router (v2)
BSR address: 10.1.1.8
BSR Priority: 255, Hash mask length: 31
Next bootstrap message in 00:00:57
This system is a candidate BSR
Candidate BSR address: 11.1.1.8, priority: 255, hash mask length: 31
```

2. (Optional) Configure the BSR timer.

```
OS10(config)# ip pim bsr-candidate-timers ethernet 1/1/9 advt-interval 40
```

To view the BSR timer value:

```
OS10# show ip pim bsr-router

This system is the Bootstrap Router (v2)
BSR address: 10.1.1.8
BSR Priority: 255, Hash mask length: 31
Next bootstrap message in 00:00:39
This system is a candidate BSR
Candidate BSR address: 11.1.1.8, priority: 255, hash mask length: 31
```

3. Configure candidate RP.

```
OS10# configure terminal
OS10(config)# interface loopback 10
OS10(config-if-lo-10)# ip address 10.1.2.8/24
OS10(config-if-lo-10)# no shutdown
OS10(config-if-lo-10)# exit

OS10(config)# ip access-list acl-rp
OS10(config-ipv4-acl)# permit ip any 225.1.1.0/24

OS10(config)# ip pim rp-candidate loopback 10 priority 23 acl acl-rp
```

**i** **NOTE:** The system does not overwrite the candidate RP configuration. You must delete the entry and reconfigure it. For example, after you configure the candidate RP with priority and associate an ACL with it, to reset the priority and dissociate the ACL from the candidate RP, or to reset the candidate RP to the default values, you must use the `no ip pim rp-candidate` command and reconfigure the candidate RP.

To view the candidate RP, candidate BSR, and elected BSR:

```
OS10# show ip pim bsr-router

This system is the Bootstrap Router (v2)
BSR address: 10.1.1.8
BSR Priority: 255, Hash mask length: 31
Next bootstrap message in 00:00:20
This system is a candidate BSR
Candidate BSR address: 10.1.1.8, priority: 255, hash mask length: 31
```

```
Next Cand_RP_advertisement in 00:00:50
RP: 10.1.2.8(loopback10)
```

To view RP-mapping details:

```
OS10# show ip pim rp mapping
Group(s) : 225.1.1.0/24
RP : 10.1.2.8, v2
Info source: 10.1.1.8, via bootstrap, priority 0
expires: 00:00:00
```

#### 4. (Optional) Configure the RP timers.

```
OS10(config)# ip pim rp-candidate-timers loopback 10 advt-interval 10 hold-time 25
```

To view candidate RP details:

```
OS10# show ip pim bsr-router

This system is the Bootstrap Router (v2)
BSR address: 10.1.1.8
BSR Priority: 255, Hash mask length: 31
Next bootstrap message in 00:00:00
This system is a candidate BSR
Candidate BSR address: 10.1.1.8, priority: 255, hash mask length: 31
Next Cand_RP_advertisement in 00:00:09
RP: 10.1.2.8(loopback10)
```

To view RP-mapping details:

```
OS10# show ip pim rp mapping
Group(s) : 225.1.1.0/24
RP : 10.1.2.8, v2
Info source: 10.1.1.8, via bootstrap, priority 23
expires: 00:01:04
```

## Configure designated router priority

Multiple PIM-SM routers can connect to a single local area network (LAN) segment. One of these routers is elected as the designated router (DR).

The DR is elected using hello messages. Each PIM router learns about its neighbors by periodically sending a hello message from each PIM-enabled interface. Hello messages contain the interface IP address from where it is sent and a DR priority value. The router with the highest priority value becomes the DR. If the priority value is the same for two routers, the router with the highest IP address is the DR. By default, the DR priority value is 1, so the IP address determines the DR.

To configure DR priority, use the following command:

```
OS10# configure terminal
OS10(config)# interface vlan 100
OS10(conf-if-vl-100)# ip pim dr-priority 200
```

## PIM commands

### clear ip pim tib

Clears PIM tree information from the PIM database.

|                   |                                                                                           |
|-------------------|-------------------------------------------------------------------------------------------|
| <b>Syntax</b>     | <code>clear ip pim [vrf vrf-name] tib</code>                                              |
| <b>Parameters</b> | <code>vrf vrf-name</code> —Enter the keyword <code>vrf</code> , then the name of the VRF. |
| <b>Default</b>    | None                                                                                      |

**Command Mode** EXEC PRIVILEGE

**Usage Information** When you run this command on a node, it deletes:

- All the multicast routes from the PIM tree information base (TIB)
- The entire multicast route table and all the entries in the data plane

With VLT multicast routing, when you run this command on a local VLT node, it deletes:

- All the multicast routes from the local PIM TIB
- All the local mroute entries in the data plane
- The synchronized mroute entries from the VLT peer node

**Example**

```
OS10# clear ip pim vrf vrf1 tib
```

**Supported Releases** 10.4.3.0 or later

## ip multicast-routing

Enables IP multicast forwarding.

**Syntax** ip multicast-routing [*vrf vrf-name*]

**Parameters** *vrf vrf-name*—Enter the keyword *vrf*, then the name of the VRF.

**Default** None

**Command Mode** CONFIGURATION

**Usage Information** After you enable IP multicast, enable IGMP and PIM on an interface. To do this, use the `ip pim sparse-mode` command in INTERFACE mode. The `no` form of the command disables IP multicast forwarding.

**Example**

```
OS10# configure terminal
OS10(config)# ip multicast-routing
```

**Supported Releases** 10.4.3.0 or later

## ip pim bsr-candidate

Configures the router as an IPv4 PIM BSR candidate.

**Syntax** ip pim [*vrf vrf-name*] bsr-candidate {*ethernet node/slot/port[:subport]* | *loopback loopback-interface-number* | *vlan vlan-number* | *port-channel port-channel-number*} [*hash-mask-len length*] [*priority priority-value*]  
no ip pim [*vrf vrf-name*] bsr-candidate

- Parameters**
- *vrf vrf-name*—Enter the keyword *vrf*, then the name of the VRF
  - *loopback-interface-number*—Enter a value from 0 to 16383
  - *vlan-number*—Enter a value from 1 to 4093
  - *port-channel-number*—Enter a value from 1 to 128
  - *length*—Enter a value from 0 to 32
  - *priority-value*—Enter a value from 0 to 255

- Default**
- Hash mask length is 30.
  - Priority is 64.

**Command Mode** CONFIGURATION

**Usage Information** The system advertises the IP address of the specified interface as the BSR IP address in BSR messages. The `no` form of the command removes the router from being the candidate BSR. Do not specify the parameters in the `no` form of the command.

**Example**

```
OS10# configure terminal
OS10(config)# ip pim vrf red bsr-candidate loopback 10 hash-mask-len 31
priority 11
```

**Supported Releases** 10.5.0 or later

## ip pim bsr-candidate-timers

Configures the time interval between candidate BSR advertisements.

**Syntax** `ip pim [vrf vrf-name] bsr-candidate-timers {ethernet node/slot/port[:subport] | loopback loopback-interface-number | vlan vlan-number | port-channel port-channel-number} advt-interval interval-value`

- Parameters**
- `vrf vrf-name`—Enter the keyword `vrf`, then the name of the VRF
  - `loopback-interface-number`—Enter a value from 0 to 16383
  - `vlan-number`—Enter a value from 1 to 4093
  - `port-channel-number`—Enter a value from 1 to 128
  - `interval-value`—Enter a value from 1 to 2147483

**Default** • Advertisement interval default is 60 s.

**Command Mode** CONFIGURATION

**Usage Information** Use this command to adjust the time interval between periodic BSR advertisements. The `no` form of the command resets the candidate BSR advertisement interval to the default value. Do not specify the parameters in the `no` form of the command.

**Example**

```
OS10(config)# ip pim vrf red bsr-candidate-timers loopback 10 advt-
interval 40
```

**Supported Releases** 10.5.0 or later

## ip pim bsr-timeout

Configures the BSR timeout value.

**Syntax** `ip pim [vrf vrf-name] bsr-timeout value`  
`no ip pim [vrf vrf-name] bsr-timeout`

- Parameters**
- `vrf vrf-name`—Enter the keyword `vrf`, then the name of the VRF
  - `value`—Enter a value from 0 to 2147483

**Default** 130 s

**Command Mode** CONFIGURATION

**Usage Information** The `no` form of the command resets the BSR timeout to its default value.

**Example**

```
OS10# configure terminal
OS10(config)# ip pim vrf red bsr-timeout 140
```

**Supported Releases** 10.5.0 or later

## ip pim dr-priority

Changes the designated router (DR) priority for the interface.

**Syntax** `ip pim dr-priority priority-value`

**Parameters** *priority-value*—Enter a number from 0 to 4294967295.

**Default** 1

**Command Mode** INTERFACE CONFIGURATION

**Usage Information** The router with the highest value assigned to an interface becomes the DR. If two interfaces have the same DR priority value, the interface with the highest IP address becomes the DR.

The `no` form of this command removes the DR priority value assigned to an interface.

### Example

```
OS10# configure terminal
OS10(config)# interface vlan 1
OS10(conf-if-vl-1)# ip pim dr-priority 200
```

**Supported Releases** 10.4.3.0 or later

## ip pim query-interval

Changes the frequency of PIM router query messages.

**Syntax** `ip pim query-interval seconds`

**Parameters** *seconds*—Enter the amount of time, in seconds, the router waits before sending a PIM hello packet out of each PIM-enabled interface, from 2 to 18000.

**Default** 30 seconds

**Command Mode** INTERFACE CONFIGURATION

**Usage Information** The `no` form of this command returns the frequency of PIM router query messages to the default value.

### Example

```
OS10# configure terminal
OS10(config)# interface vlan 1
OS10(conf-if-vl-1)# ip pim query-interval 20
```

**Supported Releases** 10.4.3.0 or later

## ip pim rp-address

Configures a static PIM RP address for a group.

**Syntax** `ip pim [vrf vrf-name] rp-address address {group-address group-address mask} [override]`

**Parameters**

- *vrf vrf-name*—Enter the keyword *vrf*, then the name of the VRF.
- *rp-address address*—Enter the keyword *address*, then the RP address in dotted-decimal format (A.B.C.D).
- *group-address group-address mask*—Enter the keyword *group-address*, then the group-address mask in dotted-decimal format (/xx) to assign the group address to the RP.

- `[override]`—Overrides BSR updates with static RP for groups with the same prefix length.

**Default** None

**Command Mode** CONFIGURATION

**Usage Information** First hop routers use this address to send register packets on behalf of the source multicast hosts. The RP addresses are stored in the order in which they are entered. The RP is chosen based on a longer prefix match for a group. You can specify the range of group addresses for which a given node is configured as an RP. The RP selection does not depend on static or dynamic RP assignments.

If you have configured a static RP for a group, use the `override` option to override BSR updates with static RP configuration.

If you do not explicitly use the `override` option and:

- The prefix length of the static RP is the same as the BSR RP, the BSR RP takes precedence over statically configured RP.
- If the prefix length of the static RP and the BSR RP does not match, OS10 selects the router having the longest-match prefix as the RP.

The `no` form of this command removes static RP configuration.

### Example

```
OS10# configure terminal
OS10(config)# ip pim rp-address 171.1.1.1 group-address 225.1.1.3/32
override
```

**Supported Releases** 10.4.3.0 or later

## ip pim rp-candidate

Configures the router as an IPv4 PIM RP candidate.

**Syntax** `ip pim [vrf vrf-name] rp-candidate {ethernet node/slot/port[:subport] | loopback loopback-interface-number | vlan vlan-number | port-channel port-channel-number} [priority priority-value] [acl acl-name]`

- Parameters**
- `vrf vrf-name`—Enter the keyword `vrf`, then the name of the VRF
  - `loopback-interface-number`—Enter a value from 0 to 16383
  - `vlan-number`—Enter a value from 1 to 4093
  - `port-channel-number`—Enter a value from 1 to 128
  - `priority-value`—Enter a value from 0 to 255
  - `acl-name`—Standard ACL name

**Default** Priority is 192.

**Command Mode** CONFIGURATION

**Usage Information** Specify the interface to obtain the candidate RP address. The access-list `acl-name` adds a range of group addresses that this candidate RP can serve.

If you do not specify an access list, the C-RP advertises itself to the entire multicast range, 224.0.0.0./4.

If you specify an access list, the C-RP advertises only the group range that the access list permits.

The `no` form of the command removes the router from being a C-RP. You must specify the parameters with the `no` form of this command.

### Example

```
OS10# configure terminal
OS10(config)# ip pim vrf red rp-candidate loopback 10 priority 11 acl rp-grp
```

**Supported Releases** 10.5.0 or later



## ip pim rp-candidate-timers

Configures the time interval between periodic candidate RP advertisements.

**Syntax** `ip pim [vrf vrf-name] rp-candidate-timers {ethernet node/slot/port[:subport] | loopback loopback-interface-number | vlan vlan-number | port-channel port-channel-number} {advt-interval interval-value} [hold-time hold-time-value]`

**Parameters**

- `vrf vrf-name`—Enter the keyword `vrf`, then the name of the VRF
- `loopback-interface-number`—Enter a value from 0 to 16383
- `vlan-number`—Enter a value from 1 to 4093
- `port-channel-number`—Enter a value from 1 to 128
- `interval-value`—Enter a value from 1 to 26214
- `hold-time-value`—Enter a value from 1 to 65535

 **NOTE:** The hold time must be greater than the advertisement interval.

**Default**

- Advertisement interval is 60 s.
- Hold time value is 150 s.

**Command Mode** CONFIGURATION

**Usage Information** Use this command to adjust the interval between candidate RP advertisements. The advertised RP entries remain in the node until the hold time value expires. Dell Technologies recommends configuring the hold time value to be 2.5 times the advertisement interval. The `no` form of the command resets the candidate RP timers to the default values.

**Example**

```
OS10# configure terminal
OS10(config)# ip pim vrf red rp-candidate-timers loopback 10 advt-
interval 30 hold-time 80
```

**Supported Releases** 10.5.0 or later

## ip pim sparse-mode

Enables PIM sparse mode and IGMP on the interface.

**Syntax** `ip pim sparse-mode`

**Parameters** None

**Default** Disabled

**Command Mode** INTERFACE CONFIGURATION

**Usage Information** Before you enable PIM sparse mode, ensure that:

- Multicast is enabled globally using the `ip multicast-routing` command.
- The interface is enabled. Use the `no shutdown` command to enable the interface.
- The interface is in Layer 3 mode. PIM-SM is enabled only on a Layer 3 interface. Before configuring PIM on the interface, use the `no switchport` command to change the interface from Layer 2 to Layer 3 mode.

Use the `no` form of the command to disable PIM sparse mode.

**Example**

```
OS10# configure terminal
OS10(config)# interface vlan 2
OS10(conf-if-vl-2)# ip address 1.1.1.2/24
OS10(conf-if-vl-2)# ip pim sparse-mode
```

**Supported Releases** 10.4.3.0 or later

## ip pim sparse-mode sg-expiry-timer

Enables expiry timers globally for all sources.

**Syntax** `ip pim [vrf vrf-name] sparse-mode sg-expiry-timer seconds`

**Parameters**

- `vrf vrf-name`—Enter the keyword `vrf`, then the name of the VRF.
- `seconds`—Enter the number of seconds the S, G entries are retained. The range is from 211 to 65535 seconds.

**Default** 210 seconds

**Command Mode** CONFIGURATION

**Usage Information** This command configures the expiry timers for all S, G entries.

**Example**

```
OS10# configure terminal
OS10(config)# ip pim sparse-mode sg-expiry-timer 500
```

**Supported Releases** 10.4.3.0 or later

## ip pim ssm-range

Specifies the SSM group range using an access list.

**Syntax** `ip pim [vrf vrf-name] ssm-range {access-list-name}`

**Parameters**

- `vrf vrf-name`—Enter the keyword `vrf`, then the name of the VRF.
- `access-list-name`—Enter the name of the access list.

**Default** 232.0.0.0/8

**Command Mode** CONFIGURATION

**Usage Information** When ACL rules change, the ACL and PIM modules apply the new rules automatically. When you remove the SSM ACL, PIM-SSM is supported only for the default SSM range.

**Example**

```
OS10# configure terminal
OS10(config)# ip pim ssm-range ssm
```

**Supported Releases** 10.4.3.0 or later

## show ip pim bsr-router

Displays information about the bootstrap router.

**Syntax** `show ip pim [vrf vrf-name] bsr-router`

**Parameters** `vrf vrf-name`—Enter the keyword `vrf`, then the name of the VRF.

**Default** None

**Command Mode** EXEC

**Usage Information** None

## Example

```
OS10# show ip pim bsr-router

PIMv2 Bootstrap information
 BSR address: 101.0.0.1
 BSR Priority: 199, Hash mask length: 31
 Expires: 00:00:24
 This system is a candidate BSR
 Candidate BSR address: 104.0.0.1, priority: 99, hash mask length: 31
 Next Cand_RP_advertisement in 00:00:15
 RP: 104.0.0.1(loopback101)
```

**Supported Releases** 10.5.0 or later

## show ip pim interface

Displays information about IP PIM-enabled interfaces.

**Syntax** `show ip pim [vrf vrf-name] interface`

**Parameters** `vrf vrf-name`—Enter the keyword `vrf`, then the name of the VRF.

**Default** None

**Command Mode** EXEC

**Usage Information** The `show ip pim interface` command displays the following:

- `Address`—IP addresses of the IP PIM-enabled interfaces
- `Interface`—Interface type with slot/port information or VLAN/Port Channel ID
- `Version/Mode`—PIM version number and mode; `v2` for PIM version 2 and `s` for PIM sparse mode
- `Nbr Count`—Active neighbor count on the PIM-enabled interface
- `Query interval`—Query interval for router query messages on that interface
- `DR priority`—Designated router priority value configured on that interface
- `DR`—IP address of the DR for that interface

## Example

```
OS10# show ip pim interface
Address Interface Ver/Mode Nbr Count Query Intvl DR Prio DR

2.2.2.2 vlan103 v2/S 1 30 1 2.2.2.2
3.3.3.2 vlan105 v2/S 1 30 1 3.3.3.2
122.1.1.2 vlan121 v2/S 0 30 1 122.1.1.2
```

**Supported Releases** 10.4.3.0 or later

## show ip pim mcache

Displays routes that are synchronized from VLT peer and local route information.

**Syntax** `show ip pim [vrf vrf-name] mcache [group-address [source-address]] [vlt]`

- Parameters**
- `vrf vrf-name`—Enter the keyword `vrf`, then the name of the VRF.
  - `group-address`—Enter the multicast group address in dotted-decimal format (A.B.C.D).
  - `source-address`—Enter the multicast source address in dotted-decimal format (A.B.C.D).

**Default** None

**Command Mode** EXEC

**Usage Information** This command provides details about the incoming and outgoing interfaces for multicast routes.

## Examples

```
OS10# show ip pim mcache vlt
PIM Multicast Routing Cache Table

Flags: S - Synced

(*, 225.1.1.1), flags: S
 Incoming interface: Vlan 502
 outgoing interface list:
 Vlan 2002 (S)

(2.2.2.2, 225.1.1.1), flags: S
 Incoming interface: Vlan 501
 outgoing interface list:
 Vlan 1000, Vlan 2003 (S)
```

```
OS10# show ip pim mcache
PIM Multicast Routing Cache Table

(*, 225.1.1.1)
 Incoming interface : vlan105
 Outgoing interface list :
 vlan121

(101.1.1.10,225.1.1.1)
 Incoming interface : vlan103
 Outgoing interface list :
 vlan121
```

**Supported Releases** 10.4.3.0 or later

## show ip pim neighbor

Displays PIM neighbors.

**Syntax** show ip pim [*vrf vrf-name*] neighbor

**Parameters** *vrf vrf-name*—Enter the keyword *vrf*, then the name of the VRF.

**Default** None

**Command Mode** EXEC

**Usage Information** This command displays the following:

- **Neighbor address**—IP addresses of the PIM neighbor
- **Interface**—Interface type with slot/port information or VLAN/Port Channel ID of the PIM neighbor
- **Uptime/expires**—Amount of time that the PIM neighbor has been up
- **Version**—PIM version number; v2 for PIM version 2
- **DR priority/Mode**—Designated router priority value and mode. The default designated router priority is 1 and S for sparse mode

### Example

```
OS10# show ip pim neighbor
Neighbor Address Interface Uptime/Expires Ver DR Priority/Mode

2.1.1.1 vlan103 13:05:58/00:01:19 v2 1 / S
3.1.1.1 vlan105 13:05:58/00:01:17 v2 1 / S
```

**Supported Releases** 10.4.3.0 or later

## show ip pim rp

Displays brief information about all multicast group to RP mappings.

- Syntax** `show ip pim [vrf vrf-name] rp [mapping | group-address]`
- Parameters**
- `vrf vrf-name`—Enter the keyword `vrf`, then the name of the VRF.
  - `mapping`—Enter the keyword `mapping` to display the multicast groups to RP mapping and information about how RP is learned.
  - `group-address`—Enter the multicast group address mask in dotted-decimal format to view the RP for a specific group (A.B.C.D).

**Default** None

**Command Mode** EXEC

**Usage Information** None

### Examples

```
OS10# show ip pim rp
Group RP

225.1.1.1 171.1.1.1
225.1.1.2 171.1.1.1
225.1.1.3 171.1.1.1
225.1.1.4 171.1.1.1
225.1.1.5 171.1.1.1
225.1.1.6 171.1.1.1
225.1.1.7 171.1.1.1
225.1.1.8 171.1.1.1
225.1.1.9 171.1.1.1
225.1.1.10 171.1.1.1
225.1.1.11 171.1.1.1
225.1.1.12 171.1.1.1
225.1.1.13 171.1.1.1
```

```
OS10# show ip pim rp mapping
PIM Group-to-RP Mappings

Group(s): 230.1.1.1/32
RP:14.1.1.1, v2
 Info source: 42.1.1.1, via bootstrap, priority 255
 expires: 00:01:53

Group(s): 231.1.1.1/32
RP: 9.1.1.1, v2
 Info source: 42.1.1.1, via bootstrap, priority 254
 expires: 00:01:54
```

**Supported Releases** 10.4.3.0 or later

## show ip pim ssm-range

Displays the non-default groups added using the SSM range feature.

**Syntax** `show ip pim [vrf vrf-name] ssm-range`

**Parameters** `vrf vrf-name`—Enter the keyword `vrf`, then the name of the VRF.

**Default** None

**Command Mode** EXEC

**Usage Information** None

## Example

```
OS10# show ip pim ssm-range
Group Address / MaskLen
224.1.1.1 / 32
```

**Supported Releases** 10.4.3.0 or later

## show ip pim summary

Displays PIM summary.

**Syntax** show ip pim [*vrf vrf-name*] summary

**Parameters** *vrf vrf-name*—Enter the keyword *vrf*, then the name of the VRF.

**Default** None

**Command Mode** EXEC

**Usage Information** None

### Examples

```
OS10# show ip pim summary

Entries in PIM-TIB/MFC : 250/150

Active Modes :
PIM-SM

TIB summary:
50/50 (*,G) entries in PIM-TIB/MFC
100/100 (S,G) entries in PIM-TIB/MFC
100/0 (S,G,Rpt) entries in PIM-TIB/MFC

Interface summary:

4 active PIM interfaces
1 active PIM neighbor

1 RPs
2 sources

Message summary:
150/50 Joins/Prunes sent/received
0/0 Candidate-RP advertisements sent/received
6/4 BSR messages sent/received
0 Null Register messages received
0/50 Register-stop messages sent/received

Data path event summary:
100 no-cache messages received
50 last-hop switchover messages received
0/0 pim-assert messages sent/received
0/0 register messages sent/received

VLT Multicast summary:
0(*,G) synced entries in MFC
281(S,G) synced entries in MFC
0(S,G,Rpt) synced entries in MFC
```

**Supported Releases** 10.4.3.0 or later

## show ip pim tib

Displays the PIM tree information base (TIB).

**Syntax** `show ip pim [vrf vrf-name] tib [group-address [source-address]]`

- Parameters**
- `vrf vrf-name`—Enter the keyword `vrf`, then the name of the VRF.
  - `group-address`—Enter the group address in dotted-decimal format (A.B.C.D).
  - `source-address`—Enter the source address in dotted-decimal format (A.B.C.D).

**Default** None

**Command Mode** EXEC

**Usage Information** This command displays the following:

- `S, G`—Displays the entry in the multicast PIM database
- `uptime`—Displays the amount of time the entry has been in the PIM route table
- `expires`—Displays the amount of time until the entry expires and is removed from the database
- `RP`—Displays the IP address of the RP or source for the entry
- `Incoming interface`—Displays the reverse path forwarding (RPF) interface towards the RP/source
- `RPF neighbor`—Displays the next hop IP address from this interface towards the RP/source
- `Outgoing interface list`—Lists the interfaces that meet one of the following criteria:
  - a directly connected member of the group
  - a statically connected member of the group
  - received an (\*, G) or (S, G) join message

### Example

```
OS10# show ip pim tib

PIM Multicast Routing Table
Flags: S - Sparse, C - Connected, L - Local, P - Pruned,
 R - RP-bit set, F - Register Flag, T - SPT-bit set, J - Join SPT,
 K - Ack-Pending state
Timers: Uptime/Expires
Interface state: Interface, next-Hop, State/Mode

(*, 225.1.1.1), uptime 13:08:24, expires 00:00:12, RP 171.1.1.1, flags:
SCJ
 Incoming interface: vlan105, RPF neighbor 3.1.1.1
 Outgoing interface list:
 vlan121 Forward/Sparse 13:07:53/Never

(101.1.1.10, 225.1.1.1), uptime 13:07:51, expires 00:06:09, flags: T
 Incoming interface: vlan103, RPF neighbor 2.1.1.1
 Outgoing interface list:
 vlan121 Forward/Sparse 13:07:50/Never
```

**Supported Releases** 10.4.3.0 or later

## show ip rpf

Displays reverse path forwarding (RPF) information.

**Syntax** `show ip rpf [vrf vrf-name] [summary]`

- Parameters**
- `vrf vrf-name`—Enter the keyword `vrf`, then the name of the VRF.
  - `summary`—RPF summary.

**Default** None

**Command Mode** EXEC

## Usage Information

PIM uses unicast routing to check the multicast source reachability. PIM examines the distance of each route. The route with the shortest distance is the one that PIM selects for reachability.

## Example

```
OS10# show ip rpf
RPF information for 101.1.1.10
 RPF interface: vlan103
 RPF neighbor: 2.1.1.1
 RPF route/mask: 101.1.1.0/255.255.255.0
 RPF type: Unicast
RPF information for 171.1.1.1
 RPF interface: vlan105
 RPF neighbor: 3.1.1.1
 RPF route/mask: 171.1.1.0/255.255.255.0
 RPF type: Unicast
```

## Supported Releases

10.4.3.0 or later

## PIM-SM sample configuration

This section describes how to enable PIM-SM in the FHR, RP, and LHR nodes using the topology show in the following illustration.

To enable PIM-SM, perform the following configurations on each of the nodes (FHR, RP, and LHR):

- Enable multicast routing on all the nodes using the `ip multicast-routing` command
- Enable PIM-SM on all the required Layer 3 interfaces of the nodes using the `ip pim sparse-mode` command
- Configure an RP address on every multicast enable node using the `ip pim rp-address` command
- Configure an IP address for each interface of the nodes in the PIM-SM topology
- Enable a routing protocol (OSPF) for route updates

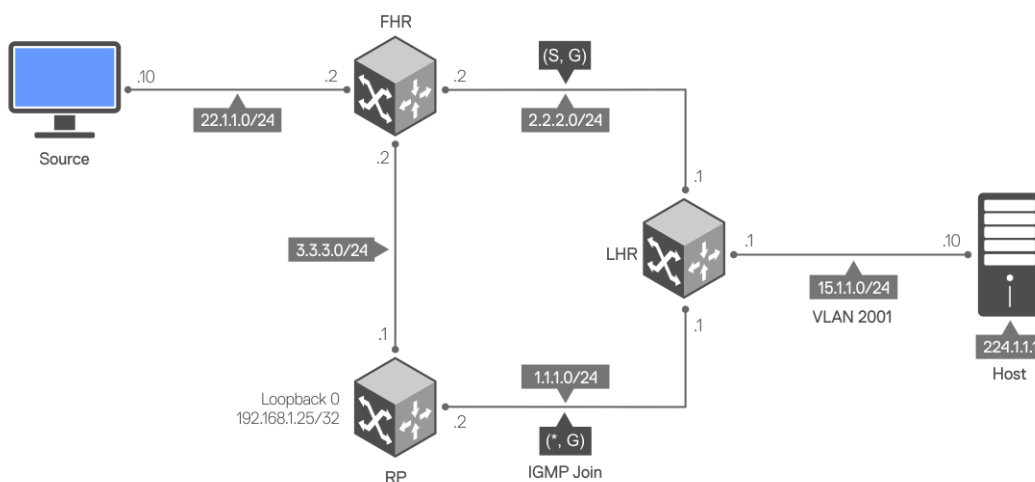

## Sample configuration in FHR node:

```
FHR# configure terminal
FHR(config)#
FHR(config)# ip multicast-routing
```



```

FHR(config)# interface ethernet 1/1/31
FHR(conf-if-eth1/1/31)# no switchport
FHR(conf-if-eth1/1/31)# ip address 3.3.3.2/24
FHR(conf-if-eth1/1/31)# ip pim sparse-mode
FHR(conf-if-eth1/1/31)# ip ospf 1 area 0
FHR(conf-if-eth1/1/31)# exit
FHR(config)#
FHR(config)# interface ethernet 1/1/17
FHR(conf-if-eth1/1/17)#
FHR(conf-if-eth1/1/17)# no switchport
FHR(conf-if-eth1/1/17)# ip address 2.2.2.2/24
FHR(conf-if-eth1/1/17)# ip pim sparse-mode
FHR(conf-if-eth1/1/17)# ip ospf 1 area 0
FHR(conf-if-eth1/1/17)# exit
FHR(config)# router ospf 1
FHR(config-router-ospf-1)# exit
FHR(config)# ip pim rp-address 192.168.1.25 group-address 224.0.0.0/4
FHR(config)#
FHR# configure terminal
FHR(config)# interface ethernet 1/1/48
FHR(conf-if-eth1/1/48)# no switchport
FHR(conf-if-eth1/1/48)# ip address 22.1.1.2/24
FHR(conf-if-eth1/1/48)# ip pim sparse-mode
FHR(conf-if-eth1/1/48)# ip ospf 1 area 0
FHR(conf-if-eth1/1/48)#

```

The `show ip pim interface` command displays the PIM-enabled interfaces in FHR.

```

FHR# show ip pim interface
Address Interface Ver/Mode Nbr Count Query Intvl DR Prio DR

2.2.2.2 ethernet1/1/17 v2/S 1 30 1 2.2.2.2
3.3.3.2 ethernet1/1/31 v2/S 1 30 1 3.3.3.2
22.1.1.2 ethernet1/1/48 v2/S 0 30 1 22.1.1.2
FHR#

```

The `show ip pim neighbor` command displays the PIM neighbor of FHR and the interface to reach the neighbor.

```

FHR# show ip pim neighbor
Neighbor Address Interface Uptime/Expires Ver DR
Priority/Mode

2.2.2.1 ethernet1/1/17 00:04:31/00:01:43 v2 1 /
S
3.3.3.1 ethernet1/1/31 00:05:45/00:01:31 v2 1 /
S
FHR#

```

The `show ip pim rp mapping` command displays the multicast groups to RP mapping and information about how RP is learned.

```

FHR# show ip pim rp mapping
Group(s) : 224.0.0.0/4, Static
RP : 192.168.1.25, v2

```

### Sample configuration in RP node:

```

RP# configure terminal
RP(config)# ip multicast-routing
RP(config)# interface ethernet 1/1/31
RP(conf-if-eth1/1/31)# no switchport
RP(conf-if-eth1/1/31)# ip address 3.3.3.1/24
RP(conf-if-eth1/1/31)# ip pim sparse-mode
RP(conf-if-eth1/1/31)# ip ospf 1 area 0
RP(conf-if-eth1/1/31)# exit
RP(config)#
RP(config)# interface ethernet 1/1/43
RP(conf-if-eth1/1/43)# no switchport
RP(conf-if-eth1/1/43)# ip address 1.1.1.2/24
RP(conf-if-eth1/1/43)# ip pim sparse-mode
RP(conf-if-eth1/1/43)# ip ospf 1 area 0

```

```

RP(config-if-eth1/1/43)# exit
RP(config)#
RP(config)# interface loopback 0
RP(config-if-lo-0)# ip address 192.168.1.25/32
RP(config-if-lo-0)# ip ospf 1 area 0
RP(config-if-lo-0)# exit
RP(config)# ip pim rp-address 192.168.1.25 group-address 224.0.0.0/4
RP(config)# end
RP#
RP# configure terminal
RP(config)# router ospf 1
RP(config-router-ospf-1)# end

```

The `show ip pim interface` command displays the PIM-enabled interfaces in RP.

```

RP# show ip pim interface
Address Interface Ver/Mode Nbr Count Query Intvl DR Prio DR

3.3.3.1 ethernet1/1/31 v2/S 1 30 1 3.3.3.2
1.1.1.2 ethernet1/1/43 v2/S 1 30 1 1.1.1.2
RP#

```

The `show ip pim neighbor` command displays the PIM neighbor of RP and the interface to reach the neighbor.

```

RP# show ip pim neighbor
Neighbor Address Interface Uptime/Expires Ver DR
Priority/Mode

3.3.3.2 ethernet1/1/31 00:02:57/00:01:17 v2 1 /
DR S
1.1.1.1 ethernet1/1/43 00:06:35/00:01:39 v2 1 /
S
RP#

```

#### Sample configuration in LHR node:

```

LHR# configure terminal
LHR(config)# ip multicast-routing
LHR(config)# interface ethernet 1/1/17
LHR(config-if-eth1/1/17)#
LHR(config-if-eth1/1/17)# no switchport
LHR(config-if-eth1/1/17)# ip address 1.1.1.1/24
LHR(config-if-eth1/1/17)# ip pim sparse-mode
LHR(config-if-eth1/1/17)# ip ospf 1 area 0
LHR(config-if-eth1/1/17)# exit
LHR(config)#
LHR(config)# interface ethernet 1/1/29
LHR(config-if-eth1/1/29)# no switchport
LHR(config-if-eth1/1/29)# ip address 2.2.2.1/24
LHR(config-if-eth1/1/29)# ip pim sparse-mode
LHR(config-if-eth1/1/29)# ip ospf 1 area 0
LHR(config-if-eth1/1/29)# exit
LHR(config)#
LHR(config)# ip pim rp-address 192.168.1.25 group-address 224.0.0.0/4
LHR(config)# end
LHR(config)# interface vlan 2001
LHR(config-if-vl-2001)# no shutdown
LHR(config-if-vl-2001)# ip address 15.1.1.1/24
LHR(config-if-vl-2001)# ip pim sparse-mode
LHR(config-if-vl-2001)# ip ospf 1 area 0
LHR(config-if-vl-2001)# exit
LHR(config)#
LHR(config)# interface ethernet 1/1/38
LHR(config-if-eth1/1/38)# switchport mode trunk
LHR(config-if-eth1/1/38)# no switchport access vlan
LHR(config-if-eth1/1/38)# switchport trunk allowed vlan 2001
LHR(config-if-eth1/1/38)# exit
LHR# configure terminal
LHR(config)# router ospf 1
LHR(config-router-ospf-1)# end

```

The show ip pim interface command displays the PIM-enabled interfaces in LHR.

```
LHR# show ip pim interface
Address Interface Ver/Mode Nbr Count Query Intvl DR Prio DR

2.2.2.1 ethernet1/1/1 v2/S 1 30 1 2.2.2.2
1.1.1.1 ethernet1/1/26:1 v2/S 1 30 1 1.1.1.2
15.1.1.1 vlan2001 v2/S 0 30 1 15.1.1.1
```

The show ip pim neighbor command displays the PIM neighbor of LHR and the interface to reach the neighbor.

```
LHR# show ip pim neighbor
Neighbor Address Interface Uptime/Expires Ver DR Priority/Mode

2.2.2.2 ethernet1/1/17 00:02:58/00:01:24 v2 1 / DR S
1.1.1.2 ethernet1/1/29 00:07:49/00:01:31 v2 1 / DR S
```

```
LHR# show ip pim rp mapping
Group(s) : 224.0.0.0/4, Static
RP : 192.168.1.25, v2
```

The following show command output examples display the PIM states across all nodes after IGMP join and multicast traffic is received.

### PIM states in FHR node

The show ip pim tib command output displays the PIM tree information base (TIB).

```
FHR# show ip pim tib

PIM Multicast Routing Table
Flags: S - Sparse, C - Connected, L - Local, P - Pruned,
 R - RP-bit set, F - Register Flag, T - SPT-bit set, J - Join SPT,
 K - Ack-Pending state
Timers: Uptime/Expires
Interface state: Interface, next-Hop, State/Mode

(22.1.1.10, 224.1.1.1), uptime 00:02:20, expires 00:01:09, flags: T
Incoming interface: ethernet1/1/48, RPF neighbor 0.0.0.0
Outgoing interface list:
 ethernet1/1/17 Forward/Sparse 00:00:19/00:03:10
```

The show ip pim mcache command output displays multicast route entries.

```
FHR# show ip pim mcache
PIM Multicast Routing Cache Table

(22.1.1.10,224.1.1.1)
Incoming interface : ethernet1/1/48
Outgoing interface list :
 ethernet1/1/17
```

### PIM states in RP node

```
RP# show ip pim tib

PIM Multicast Routing Table
Flags: S - Sparse, C - Connected, L - Local, P - Pruned,
 R - RP-bit set, F - Register Flag, T - SPT-bit set, J - Join SPT,
 K - Ack-Pending state
Timers: Uptime/Expires
Interface state: Interface, next-Hop, State/Mode

(*, 224.1.1.1), uptime 00:00:57, expires 00:00:00, RP 192.168.1.25, flags: S
Incoming interface: Null, RPF neighbor 0.0.0.0
Outgoing interface list:

(22.1.1.10, 224.1.1.1), uptime 00:02:58, expires 00:03:06, flags: P
```

```
Incoming interface: ethernet1/1/31, RPF neighbor 3.3.3.2
Outgoing interface list:
```

## IGMP and PIM states in LHR node

The `show ip igmp groups` command output displays the IGMP database.

```
LHR# show ip igmp groups
Total Number of Groups: 1
IGMP Connected Group Membership
Group Address Interface Mode
Uptime Expires Last Reporter
224.1.1.1 vlan2001 IGMPv2-Compat
00:00:01 00:01:59 15.1.1.10
LHR#
```

```
LHR# show ip pim tib

PIM Multicast Routing Table
Flags: S - Sparse, C - Connected, L - Local, P - Pruned,
 R - RP-bit set, F - Register Flag, T - SPT-bit set, J - Join SPT,
 K - Ack-Pending state
Timers: Uptime/Expires
Interface state: Interface, next-Hop, State/Mode

(*, 224.1.1.1), uptime 00:00:05, expires 00:00:54, RP 192.168.1.25, flags: SCJ
 Incoming interface: ethernet1/1/29, RPF neighbor 1.1.1.2
 Outgoing interface list:
 vlan2001 Forward/Sparse 00:00:05/Never

(22.1.1.10, 224.1.1.1), uptime 00:00:05, expires 00:03:24, flags: T
 Incoming interface: ethernet1/1/17, RPF neighbor 2.2.2.2
 Outgoing interface list:
 vlan2001 Forward/Sparse 00:00:05/Never
```

```
LHR# show ip pim mcache
PIM Multicast Routing Cache Table

(*, 224.1.1.1)
 Incoming interface : ethernet1/1/29
 Outgoing interface list :
 vlan2001

(22.1.1.10,224.1.1.1)
 Incoming interface : ethernet1/1/17
 Outgoing interface list :
 vlan2001
```

## PIM-SSM sample configuration

This section describes how to enable PIM-SSM using the topology show in the following illustration.

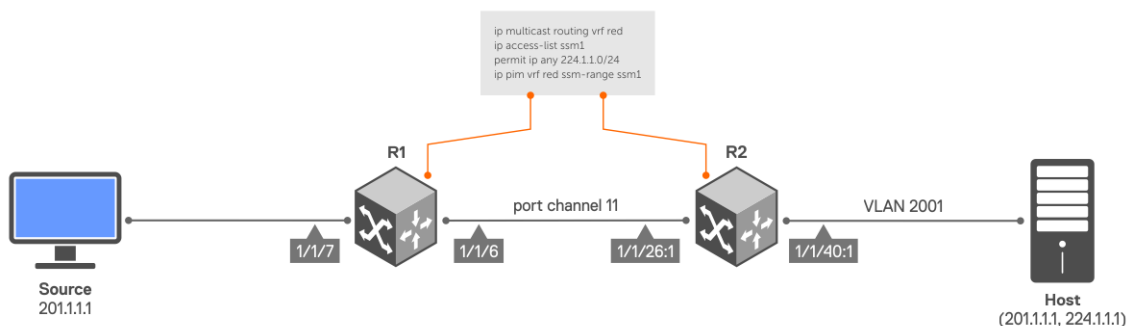

To enable PIM-SSM, perform the following configurations on R1 and R2:

## Sample configuration on R1:

```
R1# configure terminal
R1(config)# ip vrf red
R1(config-vrf)# end

R1# configure terminal
R1(config)# interface port-channel 11
R1(config-if-po-11)# no switchport
R1(config-if-po-11)# ip vrf forwarding red
R1(config-if-po-11)# end

R1# configure terminal
R1(config)# interface ethernet 1/1/6
R1(config-if-eth1/1/6)# no ip vrf forwarding
R1(config-if-eth1/1/6)# no switchport
R1(config-if-eth1/1/6)# channel-group 11
R1(config-if-eth1/1/6)# end

R1# configure terminal
R1(config)# interface ethernet 1/1/7
R1(config-if-eth1/1/7)# no switchport
R1(config-if-eth1/1/7)# interface ethernet 1/1/7
R1(config-if-eth1/1/7)# ip vrf forwarding red
R1(config-if-eth1/1/7)# ip address 201.1.1.2/24
R1(config-if-eth1/1/7)# ip pim sparse-mode
R1(config-if-eth1/1/7)# no shutdown
R1(config-if-eth1/1/7)# end

R1# configure terminal
R1(config)# interface port-channel 11
R1(config-if-po-11)# no switchport
R1(config-if-po-11)# interface port-channel 11
R1(config-if-po-11)# ip vrf forwarding red
R1(config-if-po-11)# ip address 193.1.1.1/24
R1(config-if-po-11)# ip pim sparse-mode
R1(config-if-po-11)# no shutdown
R1(config-if-po-11)# end

R1# configure terminal
R1(config)# interface Lo0
R1(config-if-lo-0)# ip vrf forwarding red
R1(config-if-lo-0)# ip address 2.2.2.2/32
R1(config-if-lo-0)# ip pim sparse-mode
R1(config-if-lo-0)# no shutdown
R1(config-if-lo-0)# end

R1# configure terminal
R1(config)# router ospf 100 vrf red
R1(config-router-ospf-100)# interface ethernet 1/1/7
R1(config-if-eth1/1/7)# ip ospf 100 area 0
R1(config-if-eth1/1/7)# end

R1# configure terminal
R1(config)# router ospf 100 vrf red
R1(config-router-ospf-100)# interface port-channel 11
R1(config-if-po-11)# ip ospf 100 area 0
R1(config-if-po-11)# end

R1# configure terminal
R1(config)# ip multicast-routing vrf red
R1(config)# end

R1# configure terminal
R1(config)# ip access-list test
R1(config-ipv4-acl)# permit ip any 224.1.1.0/24
R1(config-ipv4-acl)# exit

R1(config)# ip pim vrf red ssm-range test
R1(config)# end
```

## Sample configuration on R2:

```
R2# configure terminal
R2(config)# ip vrf red
R2(config-vrf)# end

R2# configure terminal
R2(config)# interface vlan 2001
R2(config-if-vl-2001)# ip vrf forwarding red
R2(config-if-vl-2001)# end

R2# configure terminal
R2(config)# interface ethernet 1/1/40:1
R2(config-if-eth1/1/40:1)# no ip vrf forwarding
R2(config-if-eth1/1/40:1)# switchport mode trunk
R2(config-if-eth1/1/40:1)# switchport trunk allowed vlan 2001
R2(config-if-eth1/1/40:1)# end

R2# configure terminal
R2(config)# interface port-channel 11
R2(config-if-po-11)# no switchport
R2(config-if-po-11)# ip vrf forwarding red
R2(config-if-po-11)# end

R2# configure terminal
R2(config)# interface ethernet 1/1/26:1
R2(config-if-eth1/1/26:1)# no ip vrf forwarding
R2(config-if-eth1/1/26:1)# no switchport
R2(config-if-eth1/1/26:1)# channel-group 11
R2(config-if-eth1/1/26:1)# end

R2# configure terminal
R2(config)# interface vlan 2001
R2(config-if-vl-2001)# ip vrf forwarding red
R2(config-if-vl-2001)# ip address 208.1.1.2/24
R2(config-if-vl-2001)# ip pim sparse-mode
R2(config-if-vl-2001)# no shutdown
R2(config-if-vl-2001)# end

R2# configure terminal
R2(config)# interface port-channel 11
R2(config-if-po-11)# no switchport
R2(config-if-po-11)# interface port-channel 11
R2(config-if-po-11)# ip vrf forwarding red
R2(config-if-po-11)# ip address 193.1.1.2/24
R2(config-if-po-11)# ip pim sparse-mode
R2(config-if-po-11)# no shutdown
R2(config-if-po-11)# end

R2# configure terminal
R2(config)# interface Lo0
R2(config-if-lo-0)# ip vrf forwarding red
R2(config-if-lo-0)# ip address 4.4.4.4/32
R2(config-if-lo-0)# ip pim sparse-mode
R2(config-if-lo-0)# no shutdown
R2(config-if-lo-0)# end

R2# configure terminal
R2(config)# router ospf 100 vrf red
R2(config-router-ospf-100)# interface vlan 2001
R2(config-if-vl-2001)# ip ospf 100 area 0
R2(config-if-vl-2001)# end

R2# configure terminal
R2(config)# router ospf 100 vrf red
R2(config-router-ospf-100)# interface port-channel 11
R2(config-if-po-11)# ip ospf 100 area 0
R2(config-if-po-11)# end

R2# configure terminal
R2(config)# ip multicast-routing vrf red
R2(config)# end
```

```
R2# configure terminal
R2(config)# ip access-list test
R2(config-ipv4-acl)# permit ip any 224.1.1.0/24
R2(config-ipv4-acl)# exit
R2(config)# ip pim vrf red ssm-range test
R2(config)# end
```

### Verify the configuration

To verify the configuration, use the following show commands on R1:

The show ip pim vrf red neighbor command displays the PIM neighbor of R1 and the interface through which the neighbor is reached.

```
R1# show ip pim vrf red neighbor
Neighbor Address Interface Uptime/Expires Ver DR Priority / Mode

193.1.1.2 port-channel11 02:34:33/00:01:17 v2 1 / DR S
```

The show ip pim vrf red ssm-range command displays the specified multicast address range.

```
R1# show ip pim vrf red ssm-range
Group Address / MaskLen
224.1.1.0 / 24
```

The show ip pim vrf red tib command output displays the PIM tree information base (TIB).

```
R1# show ip pim vrf red tib
PIM Multicast Routing Table
Flags: S - Sparse, C - Connected, L - Local, P - Pruned,
 R - RP-bit set, F - Register Flag, T - SPT-bit set, J - Join SPT,
 K - Ack-Pending state
Timers: Uptime/Expires
Interface state: Interface, next-Hop, State/Mode

(201.1.1.1, 224.1.1.1), uptime 00:19:42, expires 00:00:47, flags: T
Incoming interface: ethernet1/1/7, RPF neighbor 0.0.0.0
Outgoing interface list:
port-channel11 Forward/Sparse 00:00:37/00:02:52
```

The show ip pim vrf red mcache command output displays multicast route entries.

```
R1# show ip pim vrf red mcache
PIM Multicast Routing Cache Table
(201.1.1.1, 224.1.1.1)
Incoming interface : ethernet1/1/7
Outgoing interface list :
port-channel11
```

Use the following show commands on R2:

The show ip igmp vrf red groups command output displays the IGMP database.

```
R2# show ip igmp vrf red groups
Total Number of Groups: 1
IGMP Connected Group Membership
Group Address Interface Mode Uptime Expires Last Reporter
224.1.1.1 vlan2001 Include 00:00:03 Never 208.1.1.1
```

The show ip pim vrf red tib command output displays the PIM tree information base (TIB).

```
R2# show ip pim vrf red tib
PIM Multicast Routing Table
Flags: S - Sparse, C - Connected, L - Local, P - Pruned,
 R - RP-bit set, F - Register Flag, T - SPT-bit set, J - Join SPT,
 K - Ack-Pending state
Timers: Uptime/Expires
Interface state: Interface, next-Hop, State/Mode

(201.1.1.1, 224.1.1.1), uptime 00:00:06, expires 00:03:23, flags: CT
```

```
Incoming interface: port-channel11, RPF neighbor 193.1.1.1
Outgoing interface list:
 vlan2001 Forward/Sparse 00:00:06/Never
```

The `show ip pim vrf red neighbor` command displays the PIM neighbor of R2 and the interface through which the neighbor is reached.

```
R2# show ip pim vrf red neighbor
Neighbor Address Interface Uptime/Expires Ver DR Priority / Mode

193.1.1.1 port-channel11 02:34:15/00:01:29 v2 1/ S
```

The `show ip pim vrf red ssm-range` command displays the specified multicast address range.

```
R2# show ip pim vrf red ssm-range
Group Address / MaskLen
224.1.1.0 / 24
```

The `show ip pim vrf red mcache` command output displays multicast route entries.

```
R2# show ip pim vrf red mcache
PIM Multicast Routing Cache Table

(201.1.1.1, 224.1.1.1)
 Incoming interface : port-channel11
 Outgoing interface list :
 vlan2001
```



# Multicast VRF sample configuration

This section describes how to configure IPv4 multicast in a non-default VRF instance using the topology shown in the following illustration.

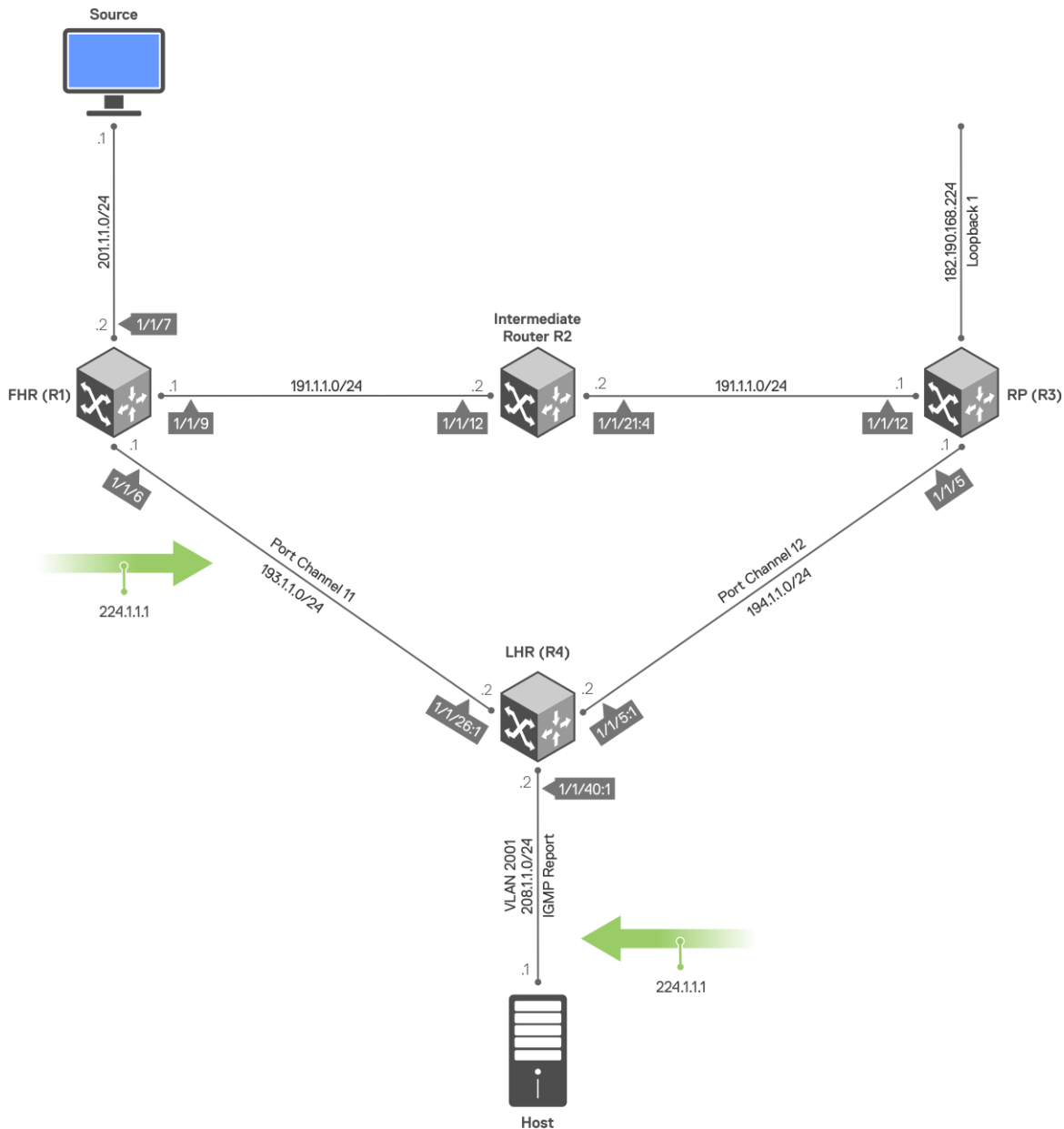

Perform the following configuration on each of the nodes, R1, R2, R3, and R4.

## Sample configuration on R1:

```
R1# configure terminal
R1(config)# ip vrf red
R1(conf-vrf)# end

R1# configure terminal
R1(config)# interface port-channel 11
R1(conf-if-po-11)# no switchport
R1(conf-if-po-11)# ip vrf forwarding red
R1(conf-if-po-11)# end

R1# configure terminal
R1(config)# interface ethernet 1/1/6
```

```

R1(conf-if-eth1/1/6)# no ip vrf forwarding
R1(conf-if-eth1/1/6)# no switchport
R1(conf-if-eth1/1/6)# channel-group 11
R1(conf-if-eth1/1/6)# end

R1# configure terminal
R1(config)# interface ethernet 1/1/7
R1(conf-if-eth1/1/7)# no switchport
R1(conf-if-eth1/1/7)# interface ethernet 1/1/7
R1(conf-if-eth1/1/7)# ip vrf forwarding red
R1(conf-if-eth1/1/7)# ip address 201.1.1.2/24
R1(conf-if-eth1/1/7)# ip pim sparse-mode
R1(conf-if-eth1/1/7)# no shutdown
R1(conf-if-eth1/1/7)# end

R1# configure terminal
R1(config)# interface ethernet 1/1/9
R1(conf-if-eth1/1/9)# no switchport
R1(conf-if-eth1/1/9)# interface ethernet 1/1/9
R1(conf-if-eth1/1/9)# ip vrf forwarding red
R1(conf-if-eth1/1/9)# ip address 191.1.1.1/24
R1(conf-if-eth1/1/9)# ip pim sparse-mode
R1(conf-if-eth1/1/9)# no shutdown
R1(conf-if-eth1/1/9)# end

R1# configure terminal
R1(config)# interface port-channel 11
R1(conf-if-po-11)# no switchport
R1(conf-if-po-11)# interface port-channel 11
R1(conf-if-po-11)# ip vrf forwarding red
R1(conf-if-po-11)# ip address 193.1.1.1/24
R1(conf-if-po-11)# ip pim sparse-mode
R1(conf-if-po-11)# no shutdown
R1(conf-if-po-11)# end

R1# configure terminal
R1(config)# interface Lo0
R1(conf-if-lo-0)# ip vrf forwarding red
R1(conf-if-lo-0)# ip address 2.2.2.2/32
R1(conf-if-lo-0)# ip pim sparse-mode
R1(conf-if-lo-0)# no shutdown
R1(conf-if-lo-0)# end

R1# configure terminal
R1(config)# router ospf 100 vrf red
R1(config-router-ospf-100)# interface ethernet 1/1/7
R1(conf-if-eth1/1/7)# ip ospf 100 area 0
R1(conf-if-eth1/1/7)# end

R1# configure terminal
R1(config)# router ospf 100 vrf red
R1(config-router-ospf-100)# interface ethernet 1/1/9
R1(conf-if-eth1/1/9)# ip ospf 100 area 0
R1(conf-if-eth1/1/9)# end

R1# configure terminal
R1(config)# router ospf 100 vrf red
R1(config-router-ospf-100)# interface port-channel 11
R1(conf-if-po-11)# ip ospf 100 area 0
R1(conf-if-po-11)# end

R1# configure terminal
R1(config)# ip multicast-routing vrf red
R1(config)# end

R1# configure terminal
R1(config)# ip pim vrf red rp-address 182.190.168.224 group-address 224.0.0.0/4
R1(config)# end

```

### Sample configuration on R2:

```

R2# configure terminal
R2(config)# ip vrf red

```

```

R2(conf-vrf)# end

R2# configure terminal
R2(config)# interface vlan 1001
R2(conf-if-vl-1001)# ip vrf forwarding red
R2(conf-if-vl-1001)# end

R2# configure terminal
R2(config)# interface ethernet 1/1/21:4
R2(conf-if-eth1/1/21:4)# switchport mode trunk
R2(conf-if-eth1/1/21:4)# switchport trunk allowed vlan 1001
R2(conf-if-eth1/1/21:4)# end

R2# configure terminal
R2(config)# interface ethernet 1/1/12:1
R2(conf-if-eth1/1/12:1)# no switchport
R2(conf-if-eth1/1/12:1)# ip vrf forwarding red
R2(conf-if-eth1/1/12:1)# ip address 191.1.1.2/24
R2(conf-if-eth1/1/12:1)# ip pim sparse-mode
R2(conf-if-eth1/1/12:1)# no shutdown
R2(conf-if-eth1/1/12:1)# end

R2# configure terminal
R2(config)# interface vlan 1001
R2(conf-if-vl-1001)# ip vrf forwarding red
R2(conf-if-vl-1001)# ip address 192.1.1.2/24
R2(conf-if-vl-1001)# ip pim sparse-mode
R2(conf-if-vl-1001)# no shutdown
R2(conf-if-vl-1001)# end

R2# configure terminal
R2(config)# interface Lo0
R2(conf-if-lo-0)# ip vrf forwarding red
R2(conf-if-lo-0)# ip address 1.1.1.1/32
R2(conf-if-lo-0)# ip pim sparse-mode
R2(conf-if-lo-0)# no shutdown
R2(conf-if-lo-0)# end

R2# configure terminal
R2(config)# router ospf 100 vrf red
R2(config-router-ospf-100)# interface ethernet 1/1/12:1
R2(conf-if-eth1/1/12:1)# ip ospf 100 area 0
R2(conf-if-eth1/1/12:1)# end

R2# configure terminal
R2(config)# router ospf 100 vrf red
R2(config-router-ospf-100)# interface vlan 1001
R2(conf-if-vl-1001)# ip ospf 100 area 0
R2(conf-if-vl-1001)# end

R2# configure terminal
R2(config)# ip multicast-routing vrf red
R2(config)# end

R2# configure terminal
R2(config)# ip pim vrf red rp-address 182.190.168.224 group-address 224.0.0.0/4
R2(config)# end

```

### Sample configuration on R3:

```

R3# configure terminal
R3(config)# ip vrf red
R3(conf-vrf)# end

R3# configure terminal
R3(config)# interface vlan 1001
R3(conf-if-vl-1001)# ip vrf forwarding red
R3(conf-if-vl-1001)# end

R3# configure terminal
R3(config)# interface ethernet 1/1/12
R3(conf-if-eth1/1/12)# no ip vrf forwarding
R3(conf-if-eth1/1/12)# switchport mode trunk

```

```

R3(conf-if-eth1/1/12)# switchport trunk allowed vlan 1001
R3(conf-if-eth1/1/12)# end

R3# configure terminal
R3(config)# interface port-channel 12
R3(conf-if-po-12)# no switchport
R3(conf-if-po-12)# ip vrf forwarding red
R3(conf-if-po-12)# end
R3# configure terminal
R3(config)# interface ethernet 1/1/5
R3(conf-if-eth1/1/5)# no ip vrf forwarding
R3(conf-if-eth1/1/5)# no switchport
R3(conf-if-eth1/1/5)# channel-group 12
R3(conf-if-eth1/1/5)# end

R3# configure terminal
R3(config)# interface vlan 1001
R3(conf-if-vl-1001)# ip vrf forwarding red
R3(conf-if-vl-1001)# ip address 192.1.1.1/24
R3(conf-if-vl-1001)# ip pim sparse-mode
R3(conf-if-vl-1001)# no shutdown
R3(conf-if-vl-1001)# end

R3# configure terminal
R3(config)# interface port-channel 12
R3(conf-if-po-12)# no switchport
R3(conf-if-po-12)# interface port-channel 12
R3(conf-if-po-12)# ip vrf forwarding red
R3(conf-if-po-12)# ip address 194.1.1.1/24
R3(conf-if-po-12)# ip pim sparse-mode
R3(conf-if-po-12)# no shutdown
R3(conf-if-po-12)# end

R3# configure terminal
R3(config)# interface Lo0
R3(conf-if-lo-0)# ip vrf forwarding red
R3(conf-if-lo-0)# ip address 3.3.3.3/32
R3(conf-if-lo-0)# ip pim sparse-mode
R3(conf-if-lo-0)# no shutdown
R3(conf-if-lo-0)# end

R3# configure terminal
R3(config)# router ospf 100 vrf red
R3(config-router-ospf-100)# interface vlan 1001
R3(conf-if-vl-1001)# ip ospf 100 area 0
R3(conf-if-vl-1001)# end

R3# configure terminal
R3(config)# router ospf 100 vrf red
R3(config-router-ospf-100)# interface port-channel 12
R3(conf-if-po-12)# ip ospf 100 area 0
R3(conf-if-po-12)# end

R3# configure terminal
R3(config)# router ospf 100 vrf red
R3(config-router-ospf-100)# interface Lol
R3(conf-if-lo-1)# ip ospf 100 area 0
R3(conf-if-lo-1)# end

R3# configure terminal
R3(config)# ip multicast-routing vrf red
R3(config)# end

R3# configure terminal
R3(config)# interface Lol1
R3(conf-if-lo-1)# ip vrf forwarding red
R3(conf-if-lo-1)# ip address 182.190.168.224/32
R3(conf-if-lo-1)# ip pim sparse-mode
R3(conf-if-lo-1)# no shutdown
R3(conf-if-lo-1)# end

R3# configure terminal

```

```
R3(config)# ip pim vrf red rp-address 182.190.168.224 group-address 224.0.0.0/4
R3(config)# end
```

#### Sample configuration on R4:

```
R4# configure terminal
R4(config)# ip vrf red
R4(config-vrf)# end

R4# configure terminal
R4(config)# interface vlan 2001
R4(config-if-vl-2001)# ip vrf forwarding red
R4(config-if-vl-2001)# end

R4# configure terminal
R4(config)# interface ethernet 1/1/40:1
R4(config-if-eth1/1/40:1)# no ip vrf forwarding
R4(config-if-eth1/1/40:1)# switchport mode trunk
R4(config-if-eth1/1/40:1)# switchport trunk allowed vlan 2001
R4(config-if-eth1/1/40:1)# end

R4# configure terminal
R4(config)# interface port-channel 11
R4(config-if-po-11)# no switchport
R4(config-if-po-11)# ip vrf forwarding red
R4(config-if-po-11)# end
R4# configure terminal
R4(config)# interface port-channel 12
R4(config-if-po-12)# no switchport
R4(config-if-po-12)# ip vrf forwarding red
R4(config-if-po-12)# end

R4# configure terminal
R4(config)# interface ethernet 1/1/26:1
R4(config-if-eth1/1/26:1)# no ip vrf forwarding
R4(config-if-eth1/1/26:1)# no switchport
R4(config-if-eth1/1/26:1)# channel-group 11
R4(config-if-eth1/1/26:1)# end

R4# configure terminal
R4(config)# interface ethernet 1/1/5:1
R4(config-if-eth1/1/5:1)# no ip vrf forwarding
R4(config-if-eth1/1/5:1)# no switchport
R4(config-if-eth1/1/5:1)# channel-group 12
R4(config-if-eth1/1/5:1)# end

R4# configure terminal
R4(config)# interface vlan 2001
R4(config-if-vl-2001)# ip vrf forwarding red
R4(config-if-vl-2001)# ip address 208.1.1.2/24
R4(config-if-vl-2001)# ip pim sparse-mode
R4(config-if-vl-2001)# no shutdown
R4(config-if-vl-2001)# end

R4# configure terminal
R4(config)# interface port-channel 11
R4(config-if-po-11)# no switchport
R4(config-if-po-11)# interface port-channel 11
R4(config-if-po-11)# ip vrf forwarding red
R4(config-if-po-11)# ip address 193.1.1.2/24
R4(config-if-po-11)# ip pim sparse-mode
R4(config-if-po-11)# no shutdown
R4(config-if-po-11)# end

R4# configure terminal
R4(config)# interface port-channel 12
R4(config-if-po-12)# no switchport
R4(config-if-po-12)# interface port-channel 12
R4(config-if-po-12)# ip vrf forwarding red
R4(config-if-po-12)# ip address 194.1.1.2/24
R4(config-if-po-12)# ip pim sparse-mode
R4(config-if-po-12)# no shutdown
```

```

R4(conf-if-po-12)# end

R4# configure terminal
R4(config)# interface Lo0
R4(conf-if-lo-0)# ip vrf forwarding red
R4(conf-if-lo-0)# ip address 4.4.4.4/32
R4(conf-if-lo-0)# ip pim sparse-mode
R4(conf-if-lo-0)# no shutdown
R4(conf-if-lo-0)# end

R4# configure terminal
R4(config)# router ospf 100 vrf red
R4(config-router-ospf-100)# interface vlan 2001
R4(conf-if-vl-2001)# ip ospf 100 area 0
R4(conf-if-vl-2001)# end

R4# configure terminal
R4(config)# router ospf 100 vrf red
R4(config-router-ospf-100)# interface port-channel 11
R4(conf-if-po-11)# ip ospf 100 area 0
R4(conf-if-po-11)# end

R4# configure terminal
R4(config)# router ospf 100 vrf red
R4(config-router-ospf-100)# interface port-channel 12
R4(conf-if-po-12)# ip ospf 100 area 0
R4(conf-if-po-12)# end

R4# configure terminal
R4(config)# ip multicast-routing vrf red
R4(config)# end

R4# configure terminal
R4(config)# ip pim vrf red rp-address 182.190.168.224 group-address 224.0.0.0/4
R4(config)# end

```

### Verify the configuration

To verify the configuration, use the following show commands.

#### First hop router (R1)

```

R1# show ip pim vrf red neighbor
Neighbor Address Interface Uptime/Expires Ver DR Priority / Mode

191.1.1.2 ethernet1/1/9 02:13:21/00:01:25 v2 1/ DR S
193.1.1.2 port-channell11 02:15:29/00:01:22 v2 1/ DR S

```

```

R1# show ip pim vrf red tib

PIM Multicast Routing Table
Flags: S - Sparse, C - Connected, L - Local, P - Pruned,
 R - RP-bit set, F - Register Flag, T - SPT-bit set, J - Join SPT,
 K - Ack-Pending state
Timers: Uptime/Expires
Interface state: Interface, next-Hop, State/Mode

(201.1.1.1, 224.1.1.1), uptime 00:00:33, expires 00:02:56, flags: FT
Incoming interface: ethernet1/1/7, RPF neighbor 0.0.0.0
Outgoing interface list:
port-channell11 Forward/Sparse 00:00:33/00:02:56

```

```

R1# show ip pim vrf red rp
Group RP

```

```

224.1.1.1 182.190.168.224
```

```
R1# show ip pim vrf red rp mapping
Group(s) : 224.0.0.0/4, Static
RP : 182.190.168.224, v2
```

```
R1# show ip pim vrf red mcache
PIM Multicast Routing Cache Table

(201.1.1.1, 224.1.1.1)
Incoming interface : ethernet1/1/7
Outgoing interface list :
port-channell1
```

### Rendezvous point (R3)

```
R3# show ip pim vrf red neighbor
Neighbor Address Interface Uptime/Expires Ver DR Priority / Mode

192.1.1.2 vlan1001 02:11:46/00:01:33 v2 1/ DR S
194.1.1.2 port-channel12 02:14:12/00:01:33 v2 1/ DR S
```

```
R3# show ip pim vrf red tib

PIM Multicast Routing Table
Flags: S - Sparse, C - Connected, L - Local, P - Pruned,
 R - RP-bit set, F - Register Flag, T - SPT-bit set, J - Join SPT,
 K - Ack-Pending state
Timers: Uptime/Expires
Interface state: Interface, next-Hop, State/Mode

(*, 224.1.1.1), uptime 00:01:48, expires 00:00:00, RP 182.190.168.224, flags: S
Incoming interface: Null, RPF neighbor 0.0.0.0
Outgoing interface list:
port-channell2 Forward/Sparse 00:01:48/00:02:41
```

```
R3# show ip pim vrf red mcache
PIM Multicast Routing Cache Table

(*, 224.1.1.1)
Incoming interface :
Outgoing interface list :
port-channell2
```

```
R3# show ip rpf vrf red
RPF information for 182.190.168.224
RPF interface:
RPF neighbor: 0.0.0.0
RPF route/mask: 0.0.0.0/0.0.0.0
RPF type: Unicast
```

```
R3# show ip pim vrf red rp mapping
Group(s) : 224.0.0.0/4, Static
RP : 182.190.168.224, v2
```

```
R3# show ip pim vrf red rp
Group RP

224.1.1.1 182.190.168.224
```

```
R3# show ip pim vrf red rp
Group RP
```

```

224.1.1.1 182.190.168.224
```

```
R3# show ip pim vrf red tib
```

```
PIM Multicast Routing Table
```

```
Flags: S - Sparse, C - Connected, L - Local, P - Pruned,
 R - RP-bit set, F - Register Flag, T - SPT-bit set, J - Join SPT,
 K - Ack-Pending state
```

```
Timers: Uptime/Expires
```

```
Interface state: Interface, next-Hop, State/Mode
```

```
(* , 224.1.1.1), uptime 00:04:41, expires 00:00:00, RP 182.190.168.224, flags: S
Incoming interface: Null, RPF neighbor 0.0.0.0
Outgoing interface list:
 port-channel12 Forward/Sparse 00:04:41/00:02:48
```

```
(201.1.1.1, 224.1.1.1), uptime 00:01:55, expires 00:02:29, flags: P
Incoming interface: port-channel12, RPF neighbor 194.1.1.2
Outgoing interface list:
```

```
R3# show ip pim vrf red mcache
```

```
PIM Multicast Routing Cache Table
```

```
(* , 224.1.1.1)
Incoming interface :
Outgoing interface list :
 port-channel12
```

#### Last hop router (R4)

```
R4# show ip pim vrf red neighbor
```

| Neighbor Address | Interface      | Uptime/Expires    | Ver | DR | Priority | Mode |
|------------------|----------------|-------------------|-----|----|----------|------|
| 193.1.1.1        | port-channel11 | 02:11:48/00:01:26 | v2  | 1  |          | / S  |
| 194.1.1.1        | port-channel12 | 02:12:07/00:01:41 | v2  | 1  |          | / S  |

```
R4# show ip pim vrf red rp mapping
```

```
Group(s) : 224.0.0.0/4, Static
RP : 182.190.168.224, v2
```

```
R4# show ip pim vrf red rp
```

```
Group RP

224.1.1.1 182.190.168.224
```

```
R4# show ip igmp vrf red groups
```

```
Total Number of Groups: 1
```

```
IGMP Connected Group Membership
```

| Group Address | Expires  | Interface | Mode          |
|---------------|----------|-----------|---------------|
| 224.1.1.1     |          | vlan2001  | IGMPv2-Compat |
| 00:00:18      | 00:02:07 | 208.1.1.1 |               |

```
R4# show ip rpf vrf red
```

```
RPF information for 182.190.168.224
```

```
RPF interface: port-channel12
RPF neighbor: 194.1.1.1
RPF route/mask: 182.190.168.224/255.255.255.255
RPF type: Unicast
```

```
R4# show ip pim vrf red tib
```

```
PIM Multicast Routing Table
```

```
Flags: S - Sparse, C - Connected, L - Local, P - Pruned,
 R - RP-bit set, F - Register Flag, T - SPT-bit set, J - Join SPT,
 K - Ack-Pending state
```

```
Timers: Uptime/Expires
```

```
Interface state: Interface, next-Hop, State/Mode
```



```

(*, 224.1.1.1), uptime 00:05:44, expires 00:00:15, RP 182.190.168.224, flags: SCJ
 Incoming interface: port-channel12, RPF neighbor 194.1.1.1
 Outgoing interface list:
 vlan2001 Forward/Sparse 00:05:44/Never

(201.1.1.1, 224.1.1.1), uptime 00:02:58, expires 00:00:31, flags: CT
 Incoming interface: port-channel11, RPF neighbor 193.1.1.1
 Outgoing interface list:
 vlan2001 Forward/Sparse 00:02:58/Never

R4# show ip pim vrf red mcache
PIM Multicast Routing Cache Table

(*, 224.1.1.1)
 Incoming interface : port-channel12
 Outgoing interface list :
 vlan2001

(201.1.1.1, 224.1.1.1)
 Incoming interface : port-channel11
 Outgoing interface list :
 vlan2001

R4# show ip pim vrf red summary

Entries in PIM-TIB/MFC: 3/2

Active Modes:
 PIM-SM

Interface summary:
 4 active PIM interfaces
 0 passive PIM interfaces
 2 active PIM neighbor

TIB Summary:
 1/1 (*,G) entries in PIM-TIB/MFC
 1/1 (S,G) entries in PIM-TIB/MFC
 1/0 (S,G,Rpt) entries in PIM-TIB/MFC

 1 RP
 1 sources

Message Summary:
 81268/13033 Joins/Prunes sent/received
 0 Null Register messages received
 0/0 Register-stop messages sent/received

Data path event summary:
 0/0 pim-assert messages sent/received
 0/0 register messages sent/received

```

## VLT multicast routing

OS10 supports multicast routing in a VLT domain for IPv4 networks. This feature provides resiliency to multicast-routed traffic when a VLT peer node or the VLTi link goes down.

## Multicast routing table synchronization

Multicast routing protocols do not exchange multicast routes between peer VLT nodes. Each VLT node runs the PIM protocol independent of the peer VLT node. Hence, the PIM states do not synchronize between the nodes. However, OS10 synchronizes the multicast routing table with routes that the PIM learns on each of the nodes between the peer VLT nodes. Multicast routing table synchronization:

- Avoids unoptimized forwarding over VLTi links. Table synchronization allows the incoming traffic sent to the wrong peer to be routed locally within the device.

- Provides traffic resiliency in the event of a VLT node failure. The traffic is forwarded until the PIM protocol reconverges and builds a new tree.

## IGMP message synchronization

VLT nodes use the VLTi link to synchronize IGMP messages across their peers. Any IGMP join message that is received on one of the VLT nodes synchronizes with the peer node. Therefore, the IGMP tables are identical in a VLT domain.

## Egress mask

When multicast traffic from the source arrives at one of the VLT peer nodes, it is sent to the downstream receivers using local routing or switching and over the VLTi link. The port block at the VLTi link of the peer node drops the multicast traffic. This port block, also known as the egress mask, avoids duplicate traffic forwarding on the VLT port channel by both VLT nodes. However, if the receiver is connected to the peer node, the system forwards the multicast traffic to the receiver.

## Spanned VLAN

Any VLAN configured on both the VLT peer nodes is known as a spanned VLAN. The VLT interconnect (VLTi) port is automatically added as a member of the spanned VLAN. Any adjacent router connected to at least one VLT node on a spanned VLAN subnet is directly reachable from both the VLT peer nodes at the L3 level.

- Spanned VLAN L3 interface: If you enable PIM on each of the spanned VLAN L3 interfaces on both VLT nodes, the interface is a spanned VLAN L3 interface.
  - Spanned VLT VLAN L3 interface: Includes all spanned L3 VLANs that have at least one VLT port that is configured as a port channel member.
  - Spanned non-VLT VLAN L3 interface: Includes all spanned VLANs that do not have VLT ports configured as port channel members.
- Nonspanned L3 interface: All point-to-point interfaces or L3 VLANs that do not have VLT ports configured as port channel members.

For more information, see [Deployment considerations](#).

## Deployment considerations

Dell Technologies recommends the following:

- In a VLT-enabled PIM router, multicast routing is not supported when there are multiple PIM spanned paths to reach the source or RP. Configure only one PIM spanned path to reach any PIM router in the aggregation or spine.
- If a source is connected to a nonspanned interface of the VLT peer nodes and the RP is reachable on a spanned interface from both the VLT nodes, the receiver might receive duplicate traffic. To avoid duplicate traffic, configure the source to be reachable on a spanned interface.
- For better convergence, the upstream incoming interface (IIF) and the downstream outgoing interface (OIF) must be a spanned VLAN.
- In VLT deployments, Dell Technologies recommends not to change the PIM designated router by configuring a non-default value using the `ip pim dr-priority` command.
- In large-scale multicast deployments, you might see frequent bursts of multicast control traffic. For such deployments, Dell Technologies recommends that you increase the burst size for queue 2 on all PIM routers using control-plane policing. For more information about how to configure a QoS policy to rate limit control-plane traffic, see [Configure control-plane policing](#).

## Example: Spanned L3 VLAN IIF

This section describes how to configure VLT multicast routing in a four-node setup—core, AG1, AG2, and ToR—using the topology shown in the following figure:

- Core, AG1, and AG2 are multicast routers in a VLT domain.
- ToR is an IGMP-enabled L2 switch.
- OSPF is the unicast routing protocol.

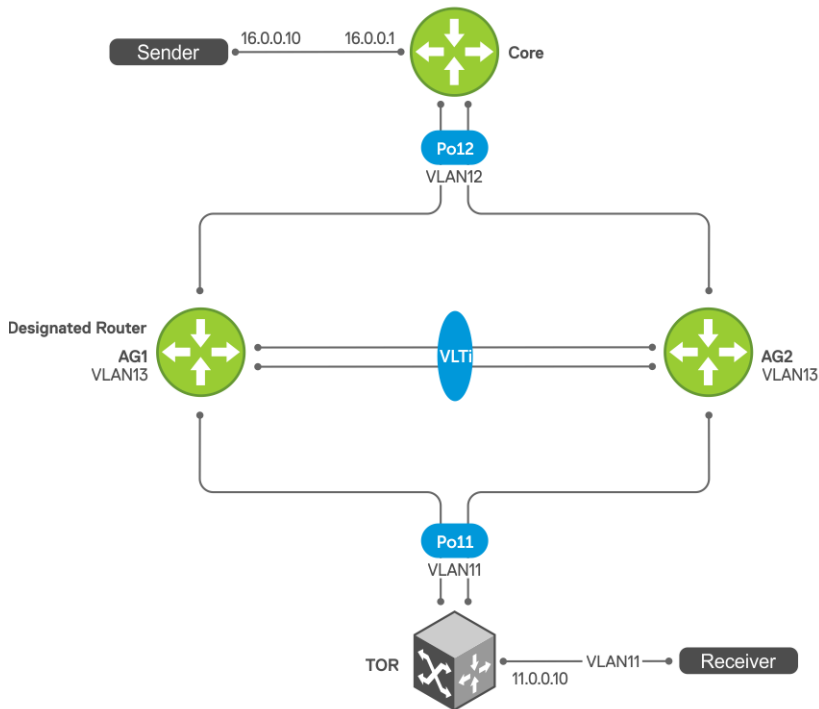

## Sample configuration on core:

```

core# configure terminal
core(config)# ip multicast-routing
core(config)# ip pim rp-address 103.0.0.3 group-address 224.0.0.0/4
core(config)# router ospf 100
core(config-router-ospf-100)# exit

core(config)# interface ethernet 1/1/32:1
core(conf-if-eth1/1/32:1)# no shutdown
core(conf-if-eth1/1/32:1)# no switchport
core(conf-if-eth1/1/32:1)# ip address 16.0.0.1/24
core(conf-if-eth1/1/32:1)# flowcontrol receive off
core(conf-if-eth1/1/32:1)# ip pim sparse-mode
core(conf-if-eth1/1/32:1)# ip ospf 100 area 0.0.0.0
core(conf-if-eth1/1/32:1)# exit

core(config)# interface vlan 12
core(conf-if-vl-12)# no shutdown
core(conf-if-vl-12)# ip address 12.0.0.3/24
core(conf-if-vl-12)# ip pim sparse-mode
core(conf-if-vl-12)# ip pim dr-priority 1000
core(conf-if-vl-12)# ip ospf 100 area 0.0.0.0
core(conf-if-vl-12)# exit

core(config)# interface loopback 103
core(conf-if-lo-103)# no shutdown
core(conf-if-lo-103)# ip address 103.0.0.3/32
core(conf-if-lo-103)# ip pim sparse-mode
core(conf-if-lo-103)# ip ospf 100 area 0.0.0.0
core(conf-if-lo-103)# exit

```

### PIM neighbors of core and the interface to reach the neighbors

The `show ip pim neighbor` command displays the PIM neighbors of core and the interface to reach the neighbors.

```

core# show ip pim neighbor
Neighbor Address Interface Uptime/Expires Ver DR Priority / Mode

```

|          |        |                   |    |    |     |
|----------|--------|-------------------|----|----|-----|
| 12.0.0.1 | vlan12 | 00:01:06/00:01:43 | v2 | 10 | / S |
| 12.0.0.2 | vlan12 | 00:01:03/00:01:42 | v2 | 10 | / S |

### PIM states in core

The output of the show ip pim tib command.

```
core# show ip pim tib
PIM Multicast Routing Table
Flags: S - Sparse, C - Connected, L - Local, P - Pruned,
 R - RP-bit set, F - Register Flag, T - SPT-bit set, J - Join SPT,
 K - Ack-Pending state
Timers: Uptime/Expires
Interface state: Interface, next-Hop, State/Mode

(*, 225.1.1.1), uptime 00:04:16, expires 00:00:00, RP 103.0.0.3, flags: S
 Incoming interface: Null, RPF neighbor 0.0.0.0
 Outgoing interface list:
 vlan12 Forward/Sparse 00:04:16/00:03:13
```

### The following show command output displays traffic after flow is initiated:

The show ip pim tib command output displays the PIM tree information base (TIB).

```
core# show ip pim tib
PIM Multicast Routing Table
Flags: S - Sparse, C - Connected, L - Local, P - Pruned,
 R - RP-bit set, F - Register Flag, T - SPT-bit set, J - Join SPT,
 K - Ack-Pending state
Timers: Uptime/Expires
Interface state: Interface, next-Hop, State/Mode

(*, 225.1.1.1), uptime 00:09:54, expires 00:00:00, RP 103.0.0.3, flags: S
 Incoming interface: Null, RPF neighbor 0.0.0.0
 Outgoing interface list:
 vlan12 Forward/Sparse 00:09:54/00:02:35

(16.0.0.10, 225.1.1.1), uptime 00:00:34, expires 00:02:55, flags: FT
 Incoming interface: ethernet1/1/32:1, RPF neighbor 0.0.0.0
 Outgoing interface list:
 vlan12 Forward/Sparse 00:00:34/00:02:55
```

The show ip pim mcache command output displays multicast route entries.

```
core# show ip pim mcache
PIM Multicast Routing Cache Table

(16.0.0.10, 225.1.1.1)
 Incoming interface : ethernet1/1/32:1
 Outgoing interface list :
 vlan12
```

## Sample configuration on AG1:

```
AG1# configure terminal
AG1(config)# ip multicast-routing
AG1 (config)# ip pim rp-address 103.0.0.3 group-address 224.0.0.0/4
AG1(config)# router ospf 100
AG1(config-router-ospf-100)# exit

AG1(config)# vlt-domain 255
AG1(conf-vlt-255)# backup destination 10.16.132.147
AG1(conf-vlt-255)# discovery-interface ethernet1/1/31:1,1/1/31:4
AG1(conf-vlt-255)# peer-routing
AG1(conf-vlt-255)# primary-priority 1
AG1(conf-vlt-255)# vlt-mac 00:00:00:11:11:11
AG1(conf-vlt-255)# exit
```

```

AG1(config)# interface ethernet 1/1/32:1
AG1(conf-if-eth1/1/32:1)# no shutdown
AG1(conf-if-eth1/1/32:1)# no switchport
AG1(conf-if-eth1/1/32:1)# ip address 16.0.0.1/24
AG1(conf-if-eth1/1/32:1)# flowcontrol receive off
AG1(conf-if-eth1/1/32:1)# ip pim sparse-mode
AG1(conf-if-eth1/1/32:1)# ip ospf 100 area 0.0.0.0
AG1(conf-if-eth1/1/32:1)# exit

```

```

AG1(config)# interface vlan 11
AG1(conf-if-vlan-11)# no shutdown
AG1(conf-if-vlan-11)# ip address 11.0.0.1/24
AG1(conf-if-vlan-11)# ip pim sparse-mode
AG1(conf-if-vlan-11)# ip pim dr-priority 1000
AG1(conf-if-vlan-11)# ip ospf 100 area 0.0.0.0
AG1(conf-if-vlan-11)# ip ospf cost 3000
AG1(conf-if-vlan-11)# exit

```

```

AG1(config)# interface vlan 12
AG1(conf-if-vlan-12)# no shutdown
AG1(conf-if-vlan-12)# ip address 12.0.0.1/24
AG1(conf-if-vlan-12)# ip pim sparse-mode
AG1(conf-if-vlan-12)# ip pim dr-priority 10
AG1(conf-if-vlan-12)# ip ospf 100 area 0.0.0.0
AG1(conf-if-vlan-12)# exit

```

```

AG1(config)# interface vlan 13
AG1(conf-if-vlan-13)# no shutdown
AG1(conf-if-vlan-13)# ip address 13.0.0.1/24
AG1(conf-if-vlan-13)# ip pim sparse-mode
AG1(conf-if-vlan-13)# ip pim dr-priority 10
AG1(conf-if-vlan-13)# ip ospf 100 area 0.0.0.0
AG1(conf-if-vlan-13)# ip ospf cost 4000
AG1(conf-if-vlan-13)# exit

```

```

AG1(config)# interface loopback 101
AG1(conf-if-lo-101)# no shutdown
AG1(conf-if-lo-101)# ip address 101.0.0.1/32
AG1(conf-if-lo-101)# ip pim sparse-mode
AG1(conf-if-lo-101)# ip ospf 100 area 0.0.0.0
AG1(conf-if-lo-101)# exit

```

```

AG1(config)# interface port-channel11
AG1(conf-if-po-11)# no shutdown
AG1(conf-if-po-11)# switchport mode trunk
AG1(conf-if-po-11)# switchport trunk allowed vlan 11
AG1(conf-if-po-11)# vlt-port-channel 11
AG1(conf-if-po-11)# exit

```

```

AG1(config)# interface port-channel12
AG1(conf-if-po-12)# no shutdown
AG1(conf-if-po-12)# switchport mode trunk
AG1(conf-if-po-12)# switchport access vlan 1
AG1(conf-if-po-12)# switchport trunk allowed vlan 12
AG1(conf-if-po-12)# vlt-port-channel 12
AG1(conf-if-po-12)# exit

```

### PIM neighbors of AG1 and the interface to reach the neighbors

The `show ip pim neighbor` command displays the PIM neighbors of AG1 and the interface to reach the neighbors.

```

AG1# show ip pim neighbor
Neighbor Address Interface Uptime/Expires Ver DR Priority / Mode

11.0.0.2 vlan11 00:00:43/00:01:33 v2 10 / S
12.0.0.2 vlan12 00:01:01/00:01:44 v2 10 / S
12.0.0.3 vlan12 00:01:01/00:01:43 v2 1000 / DR S
13.0.0.2 vlan13 00:01:02/00:01:42 v2 1000 / DR S

```

### IGMP and PIM states in AG1

The show ip igmp groups command output displays the IGMP database.

```
AG1# show ip igmp groups
Total Number of Groups: 1
IGMP Connected Group Membership
Group Address Interface Mode
Uptime Expires Last Reporter
225.1.1.1 vlan11 Exclude
00:01:55 00:01:53 0.0.0.0
```

The show ip pim tib command output displays the PIM tree information base (TIB).

```
AG1# show ip pim tib

PIM Multicast Routing Table
Flags: S - Sparse, C - Connected, L - Local, P - Pruned,
 R - RP-bit set, F - Register Flag, T - SPT-bit set, J - Join SPT,
 K - Ack-Pending state
Timers: Uptime/Expires
Interface state: Interface, next-Hop, State/Mode

(*, 225.1.1.1), uptime 00:02:05, expires 00:00:54, RP 103.0.0.3, flags: SCJ
Incoming interface: vlan12, RPF neighbor 12.0.0.3
Outgoing interface list:
 vlan11 Forward/Sparse 00:02:05/Never
```

The show ip pim mcache command output displays multicast route entries.

```
AG1# show ip pim mcache
PIM Multicast Routing Cache Table

(*, 225.1.1.1)
Incoming interface : vlan12
Outgoing interface list :
 vlan11

AG1-VLT-NODE-1# show ip pim mcache vlt
PIM Multicast Routing Cache Table
Flags: S - Synced

(*, 225.1.1.1)
Incoming interface : vlan12
Outgoing interface list :
 vlan11
```

**The following show command output displays traffic after traffic flow is established:**

The show ip pim tib command shows the PIM tree information base.

```
AG1# show ip pim tib

PIM Multicast Routing Table
Flags: S - Sparse, C - Connected, L - Local, P - Pruned,
 R - RP-bit set, F - Register Flag, T - SPT-bit set, J - Join SPT,
 K - Ack-Pending state
Timers: Uptime/Expires
Interface state: Interface, next-Hop, State/Mode

(*, 225.1.1.1), uptime 00:10:15, expires 00:00:44, RP 103.0.0.3, flags: SCJ
Incoming interface: vlan12, RPF neighbor 12.0.0.3
Outgoing interface list:
 vlan11 Forward/Sparse 00:10:15/Never

(16.0.0.10, 225.1.1.1), uptime 00:00:55, expires 00:02:34, flags: CT
Incoming interface: vlan12, RPF neighbor 12.0.0.3
Outgoing interface list:
 vlan11 Forward/Sparse 00:00:55/Never
```

The `show ip pim mcache` command displays the multicast route entries.

```
AG1# show ip pim mcache
PIM Multicast Routing Cache Table

(*, 225.1.1.1)
 Incoming interface : vlan12
 Outgoing interface list :
 vlan11

(16.0.0.10, 225.1.1.1)
 Incoming interface : vlan12
 Outgoing interface list :
 vlan11
```

The `show ip pim mcache vlt` command displays multicast route entries.

```
AG1# show ip pim mcache vlt
PIM Multicast Routing Cache Table
Flags: S - Synced

(*, 225.1.1.1)
 Incoming interface : vlan12
 Outgoing interface list :
 vlan11

(16.0.0.10, 225.1.1.1)
 Incoming interface : vlan12
 Outgoing interface list :
 vlan11
```

## Sample configuration on AG2:

```
AG2# configure terminal
AG2(config)# ip multicast-routing
AG2 (config)# ip pim rp-address 103.0.0.3 group-address 224.0.0.0/4
AG2(config)# router ospf 100
AG2(config-router-ospf-100)# exit

AG2(config)# vlt-domain 255
AG2(conf-vlt-255)# backup destination 10.16.132.153
AG2(conf-vlt-255)# discovery-interface ethernet1/1/31:1,1/1/31:4
AG2(conf-vlt-255)# peer-routing
AG2(conf-vlt-255)# vlt-mac 00:00:00:11:11:11
AG2(conf-vlt-255)# exit

AG2(config)# interface ethernet 1/1/32:1
AG2(conf-if-eth1/1/32:1)# no shutdown
AG2(conf-if-eth1/1/32:1)# no switchport
AG2(conf-if-eth1/1/32:1)# ip address 16.0.0.1/24
AG2(conf-if-eth1/1/32:1)# flowcontrol receive off
AG2(conf-if-eth1/1/32:1)# ip pim sparse-mode
AG2(conf-if-eth1/1/32:1)# ip ospf 100 area 0.0.0.0
AG2(conf-if-eth1/1/32:1)# exit

AG2(config)# interface vlan 11
AG2(conf-if-vlan-11)# no shutdown
AG2(conf-if-vlan-11)# ip address 11.0.0.2/24
AG2(conf-if-vlan-11)# ip pim sparse-mode
AG2(conf-if-vlan-11)# ip pim dr-priority 10
AG2(conf-if-vlan-11)# ip ospf 100 area 0.0.0.0
AG2(conf-if-vlan-11)# ip ospf cost 3000
AG2(conf-if-vlan-11)# exit

AG2(config)# interface vlan 12
AG2(conf-if-vlan-12)# no shutdown
AG2(conf-if-vlan-12)# ip address 12.0.0.2/24
AG2(conf-if-vlan-12)# ip pim sparse-mode
AG2(conf-if-vlan-12)# ip pim dr-priority 10
```

```

AG2(conf-if-vlan-12)# ip ospf 100 area 0.0.0.0
AG2(conf-if-vlan-12)# exit

AG2(config)# interface vlan 13
AG2(conf-if-vlan-13)# no shutdown
AG2(conf-if-vlan-13)# ip address 13.0.0.2/24
AG2(conf-if-vlan-13)# ip pim sparse-mode
AG2(conf-if-vlan-13)# ip pim dr-priority 1000
AG2(conf-if-vlan-13)# ip ospf 100 area 0.0.0.0
AG2(conf-if-vlan-13)# ip ospf cost 4000
AG2(conf-if-vlan-13)# exit

AG2(config)# interface loopback 102
AG2(conf-if-lo-102)# no shutdown
AG2(conf-if-lo-102)# ip address 102.0.0.2/32
AG2(conf-if-lo-102)# ip pim sparse-mode
AG2(conf-if-lo-102)# ip ospf 100 area 0.0.0.0
AG2(conf-if-lo-102)# exit

AG2(config)# interface port-channel11
AG2(conf-if-po-11)# no shutdown
AG2(conf-if-po-11)# switchport mode trunk
AG2(conf-if-po-11)# switchport access vlan 1
AG2(conf-if-po-11)# switchport trunk allowed vlan 11
AG2(conf-if-po-11)# vlt-port-channel 11
AG2(conf-if-po-11)# exit

AG2(config)# interface port-channel12
AG2(conf-if-po-12)# no shutdown
AG2(conf-if-po-12)# switchport mode trunk
AG2(conf-if-po-12)# switchport access vlan 1
AG2(conf-if-po-12)# switchport trunk allowed vlan 12
AG2(conf-if-po-12)# vlt-port-channel 12
AG2(conf-if-po-12)# exit

```

### PIM neighbors of AG2 and the interface to reach the neighbors

The `show ip pim neighbor` command displays the PIM neighbors of AG2 and the interface to reach the neighbors.

```

AG2# show ip pim neighbor
Neighbor Address Interface Uptime/Expires Ver DR Priority / Mode

11.0.0.1 vlan11 00:00:38/00:01:36 v2 1000 / DR S
12.0.0.1 vlan12 00:01:00/00:01:19 v2 10 / S
12.0.0.3 vlan12 00:01:06/00:01:18 v2 1000 / DR S
13.0.0.1 vlan13 00:01:00/00:01:19 v2 10 / S

```

### IGMP and PIM states in AG2

The `show ip igmp groups` command output displays the IGMP database.

```

AG2# show ip igmp groups
Total Number of Groups: 1
IGMP Connected Group Membership
Group Address Expires Interface Mode
Uptime Last Reporter
225.1.1.1 00:01:47 vlan11 Exclude
00:02:00
0.0.0.0

```

The output of the `show ip pim tib` command.

```

AG2# show ip pim tib

PIM Multicast Routing Table
Flags: S - Sparse, C - Connected, L - Local, P - Pruned,
 R - RP-bit set, F - Register Flag, T - SPT-bit set, J - Join SPT,
 K - Ack-Pending state
Timers: Uptime/Expires
Interface state: Interface, next-Hop, State/Mode

(*, 225.1.1.1), uptime 00:02:15, expires 00:00:00, RP 103.0.0.3, flags: SC
Incoming interface: vlan12, RPF neighbor 12.0.0.3

```



```
Outgoing interface list:
 vlan11 Forward/Sparse 00:02:15/Never
```

The show ip pim mcache command output displays multicast route entries.

```
AG2# show ip pim mcache
PIM Multicast Routing Cache Table
```

```
(* , 225.1.1.1)
 Incoming interface : vlan12
 Outgoing interface list :
 vlan11
```

```
AG2# show ip pim mcache vlt
PIM Multicast Routing Cache Table
Flags: S - Synced
```

```
(* , 225.1.1.1), flags: S
 Incoming interface : vlan12
 Outgoing interface list :
 vlan11 (S)
```

**The following show command output displays the synchronized states after traffic flow is established:**

```
AG2# show ip pim tib
```

```
PIM Multicast Routing Table
Flags: S - Sparse, C - Connected, L - Local, P - Pruned,
 R - RP-bit set, F - Register Flag, T - SPT-bit set, J - Join SPT,
 K - Ack-Pending state
Timers: Uptime/Expires
Interface state: Interface, next-Hop, State/Mode
```

```
(* , 225.1.1.1), uptime 00:10:30, expires 00:00:00, RP 103.0.0.3, flags: SC
 Incoming interface: vlan12, RPF neighbor 12.0.0.3
 Outgoing interface list:
 vlan11 Forward/Sparse 00:10:30/Never
```

```
AG2# show ip pim mcache
PIM Multicast Routing Cache Table
```

```
(* , 225.1.1.1)
 Incoming interface : vlan12
 Outgoing interface list :
 vlan11
```

```
(16.0.0.10, 225.1.1.1)
 Incoming interface : vlan12
 Outgoing interface list :
 vlan11
```

```
AG2# show ip pim mcache vlt
PIM Multicast Routing Cache Table
Flags: S - Synced
```

```
(* , 225.1.1.1), flags: S
 Incoming interface : vlan12
 Outgoing interface list :
 vlan11 (S)
```

```
(16.0.0.10, 225.1.1.1), flags: S
 Incoming interface : vlan12
 Outgoing interface list :
 vlan11 (S)
```

## Sample configuration on TOR:

```
TOR# configure terminal
TOR(config)# ip igmp snooping enable

TOR(config)# interface vlan 11
TOR(conf-if-vlan-11)# no shutdown
TOR(conf-if-vlan-11)# exit

TOR(config)# interface port-channel 11
TOR(conf-if-po-11)# no shutdown
TOR(conf-if-po-11)# switchport mode trunk
TOR(conf-if-po-11)# switchport access vlan 1
TOR(conf-if-po-11)# switchport trunk allowed vlan 11
TOR(conf-if-po-11)# exit

TOR(config)# interface ethernet 1/1/32:1
TOR(conf-if-eth1/1/32:1)# no shutdown
TOR(conf-if-eth1/1/32:1)# switchport mode trunk
TOR(conf-if-eth1/1/32:1)# switchport access vlan 1
TOR(conf-if-eth1/1/32:1)# switchport trunk allowed vlan 11
TOR(conf-if-eth1/1/32:1)# flowcontrol receive off
TOR(conf-if-eth1/1/32:1)# exit
```

### IGMP snooping information on TOR

The following command displays IGMP snooping groups membership details:

```
ToR# show ip igmp snooping groups
Total Number of Groups: 1
IGMP Connected Group Membership
Group Address Interface Mode Expires
225.1.1.1 vlan11 IGMPv2-Compat 00:02:09
 Member-ports :ethernet1/1/32:1
```

## Example: Active-active PIM in a square VLT topology

The following topology uses active/active PIM in a square VLT environment:

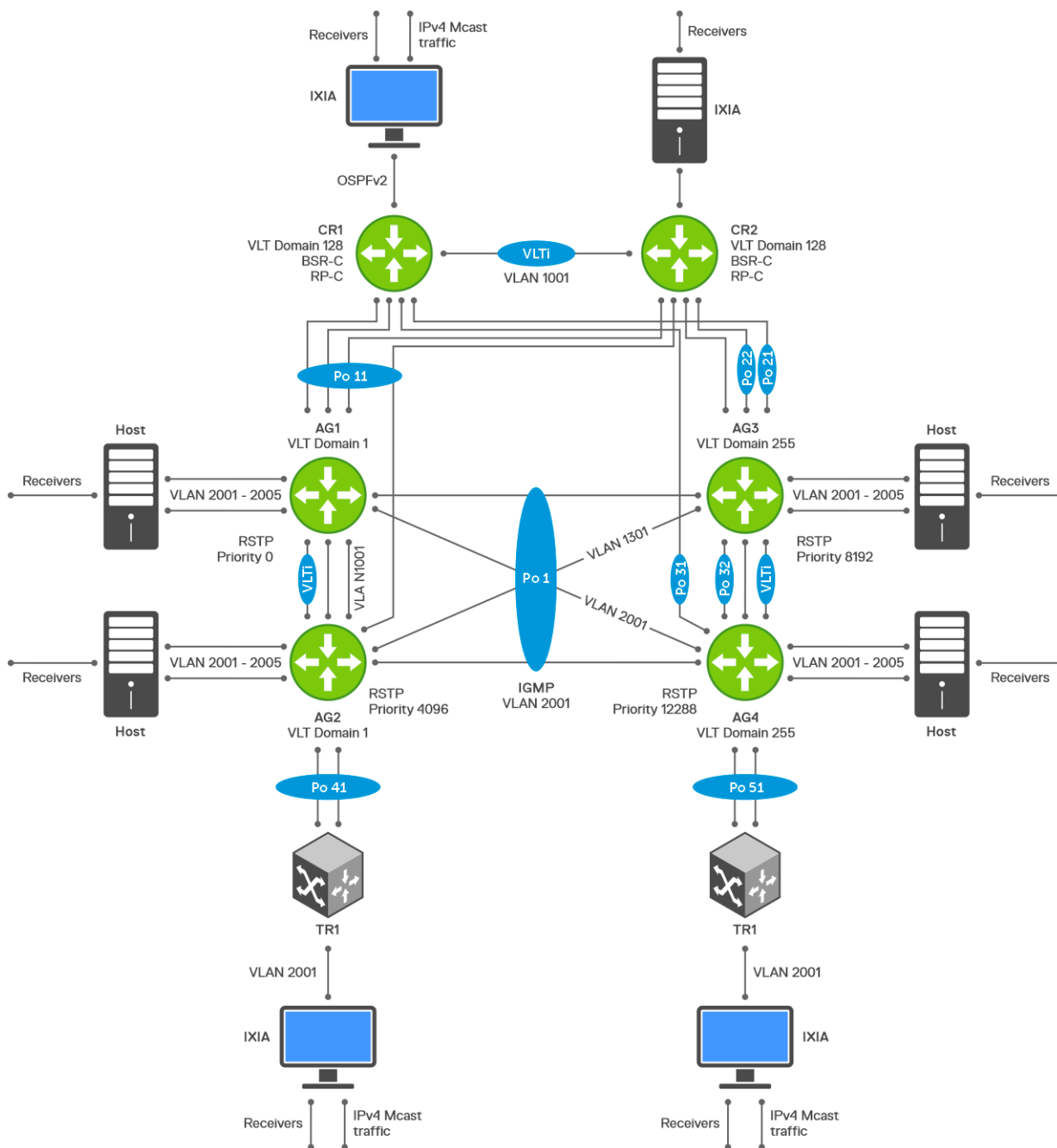

- CR1, CR2, AG1, AG2, AG3, and AG4 are multicast routers.
- CR1 and CR2 are the BSR and RP nodes.
- TR1 and TR2 are IGMP-enabled L2 nodes.
- OSPFv2 is the unicast routing protocol.

## CR1 switch

1. Configure RSTP.

```
CR1(config)# spanning-tree disable
```

2. Configure the VLT domain.

```
CR1(config)# interface ethernet 1/1/27:2
CR1(conf-if-eth1/1/27:2)# no switchport
```

```
CR1(config)# vlt-domain 128
```

```
CR1(conf-vlt-128)# backup destination 10.222.208.160
CR1(conf-vlt-128)# discovery-interface ethernet1/1/27:2
CR1(conf-vlt-128)# peer-routing
CR1(conf-vlt-128)# primary-priority 1
CR1(conf-vlt-128)# vlt-mac 9a:00:00:aa:aa:aa
```

3. Configure a port channel interface towards AG1 and AG2.

```
CR1(config)# interface port-channel 11

CR1(config)# interface ethernet 1/1/1:1
CR1(conf-if-eth1/1/1:1)# channel-group 11 mode active

CR1(config)# interface ethernet 1/1/9:1
CR1(conf-if-eth1/1/9:1)# channel-group 11 mode active

CR1(config)# interface port-channel 11
CR1(conf-if-po-11)# vlt-port-channel 11
```

4. Configure a port channel interface towards AG3.

```
CR1(config)# interface port-channel 21

CR1(config)# interface ethernet 1/1/25:1
CR1(conf-if-eth1/1/25:1)# channel-group 21 mode active
```

5. Configure a port channel interface towards AG4.

```
CR1(config)# interface port-channel 31

CR1(config)# interface ethernet 1/1/17:1
CR1(conf-if-eth1/1/17:1)# channel-group 31 mode active
```

6. Configure a Loopback interface and enable PIM-sparse mode.

```
CR1(config)# interface loopback 1
CR1(conf-if-lo-1)# ip address 10.1.100.5/32
CR1(conf-if-lo-1)# ip pim sparse-mode
```

7. Enable multicast routing on the default VRF.

```
CR1(config)# ip multicast-routing
```

8. Enable BSR.

```
CR1(config)# ip pim bsr-candidate loopback1 hash-mask-len 31 priority 199
```

9. Enable the RP candidate.

```
CR1(config)# ip pim rp-candidate loopback1 priority 100 acl mcast_acl
```

10. Configure an access-list for RP mapping.

```
CR1(config)# ip access-list mcast_acl
CR1(config-ipv4-acl)# permit ip any 225.0.0.0/8
```

11. Configure OSPF for unicast routing.

```
CR1(config)# router ospf 1
CR1(config-router-ospf-1)# log-adjacency-changes
CR1(config-router-ospf-1)# redistribute connected
CR1(config-router-ospf-1)# router-id 10.1.100.5
```

12. Configure the IP address, OSPF process, and PIM-SM on the VLANs.

- VLAN 100 towards CR2

```
CR1(config)# interface vlan 100
CR1(conf-if-vl-100)# ip address 10.1.1.5/24
CR1(conf-if-vl-100)# ip ospf 1 area 0.0.0.0
CR1(conf-if-vl-100)# ip pim sparse-mode
CR1(conf-if-vl-100)# ip pim dr-priority 1
```

- VLAN 1001 towards AG1 and AG2

```
CR1(config)# interface vlan 1001
CR1(conf-if-vl-1001)# ip address 10.1.2.5/24
CR1(conf-if-vl-1001)# ip ospf 1 area 0.0.0.0
CR1(conf-if-vl-1001)# ip pim sparse-mode
CR1(conf-if-vl-1001)# ip igmp snooping mrouter interface port-channel11
```

- VLAN 1101 towards AG3

```
CR1(config)# interface vlan 1101
CR1(conf-if-vl-1101)# ip address 10.1.3.5/24
CR1(conf-if-vl-1101)# ip ospf 1 area 0.0.0.0
CR1(conf-if-vl-1101)# ip pim sparse-mode
CR1(conf-if-vl-1101)# ip ospf cost 65535
CR1(conf-if-vl-1101)# ip igmp snooping mrouter interface port-channel21
```

- VLAN 1201 towards AG4

```
CR1(config)# interface vlan 1201
CR1(conf-if-vl-1201)# ip address 10.1.4.5/24
CR1(conf-if-vl-1201)# ip ospf 1 area 0.0.0.0
CR1(conf-if-vl-1201)# ip pim sparse-mode
CR1(conf-if-vl-1201)# ip ospf cost 65535
CR1(conf-if-vl-1201)# ip igmp snooping mrouter interface port-channel31
```

### 13. Configure the interfaces as VLAN trunk ports and specify the allowed VLANs.

```
CR1(config)# interface port-channel 11
CR1(conf-if-po-11)# switchport mode trunk
CR1(conf-if-po-11)# switchport trunk allowed vlan 1001
```

```
CR1(config)# interface port-channel 21
CR1(conf-if-po-21)# switchport mode trunk
CR1(conf-if-po-21)# switchport trunk allowed vlan 1101
```

```
CR1(config)# interface port-channel 31
CR1(conf-if-po-31)# switchport mode trunk
CR1(conf-if-po-31)# switchport trunk allowed vlan 1201
```

```
CR1(config)# interface ethernet 1/1/28:1
CR1(conf-if-eth1/1/28:1)# switchport mode trunk
CR1(conf-if-eth1/1/28:1)# switchport trunk allowed vlan 100
```

```
CR1(config)# interface ethernet 1/1/28:3
CR1(conf-if-eth1/1/28:3)# switchport mode trunk
CR1(conf-if-eth1/1/28:3)# switchport trunk allowed vlan 100
```

## CR2 switch

1. Configure RSTP.

```
CR2(config)# spanning-tree disable
```

2. Configure the VLT domain.

```
CR2(config)# interface ethernet 1/1/27:2
CR2(conf-if-eth1/1/27:2)# no switchport

CR2(config)#vlt-domain 128
CR2(conf-vlt-128)# backup destination 10.222.208.238
CR2(conf-vlt-128)# discovery-interface ethernet1/1/27:2
CR2(conf-vlt-128)# peer-routing
CR2(conf-vlt-128)# primary-priority 65535
CR2(conf-vlt-128)# vlt-mac 9a:00:00:aa:aa:aa
```

3. Configure a port channel interface towards AG1 and AG2.

```
CR2(config)# interface port-channel 11

CR2(config)# interface ethernet 1/1/1:1
CR2(conf-if-eth1/1/1:1)# channel-group 11 mode active

CR2(config)# interface ethernet 1/1/9:1
CR2(conf-if-eth1/1/9:1)# channel-group 11 mode active

CR2(config)# interface port-channel 11
CR2(conf-if-po-11)# vlt-port-channel 11
```

4. Configure a port channel interface towards AG3.

```
CR2(config)# interface port-channel 22

CR2(config)# interface ethernet 1/1/25:1
CR2(conf-if-eth1/1/25:1)# channel-group 22 mode active
```

5. Configure a port channel interface towards AG4.

```
CR2(config)# interface port-channel 32

CR2(config)# interface ethernet 1/1/17:1
CR2(conf-if-eth1/1/17:1)# channel-group 32 mode active
```

6. Configure a Loopback interface and enable PIM-SM.

```
CR2(config)# interface loopback 1
CR2(conf-if-lo-1)# ip address 10.1.100.6/32
CR2(conf-if-lo-1)# ip pim sparse-mode
```

7. Enable multicast routing on the default VRF.

```
CR2(config)# ip multicast-routing
```

8. Enable BSR. This router becomes the elected BSR.

```
CR2(config)# ip pim bsr-candidate loopback1 hash-mask-len 31 priority 99
```

9. Enable the RP candidate.

```
CR2(config)# ip pim rp-candidate loopback1 priority 100 acl mcast_acl
```

10. Configure an access list for RP mapping.

```
CR2(config)# ip access-list mcast_acl
CR2(config-ipv4-acl)# permit ip any 225.0.0.0/8
```

11. Configure OSPF for unicast routing.

```
CR2(config)# router ospf 1
CR2(config-router-ospf-1)# log-adjacency-changes
CR2(config-router-ospf-1)# redistribute connected
CR2(config-router-ospf-1)# router-id 10.1.100.6
```

12. Configure the IP address, OSPF process, and PIM sparse mode on the VLANs.

- VLAN 100 towards CR1

```
CR2(config)# interface vlan 100
CR2(conf-if-vl-100)# ip address 10.1.1.6/24
CR2(conf-if-vl-100)# ip ospf 1 area 0.0.0.0
CR2(conf-if-vl-100)# ip pim sparse-mode
CR2(conf-if-vl-100)# ip pim dr-priority 4294967295
```

- VLAN 1001 towards AG1 and AG2

```
CR2(config)# interface vlan 1001
CR2(conf-if-vl-1001)# ip address 10.1.2.6/24
CR2(conf-if-vl-1001)# ip ospf 1 area 0.0.0.0
```

```
CR2(conf-if-vl-1001)# ip pim sparse-mode
CR2(conf-if-vl-1001)# ip igmp snooping mrouter interface port-channel11
```

- VLAN 1151 towards AG3

```
CR2(config)# interface vlan 1151
CR2(conf-if-vl-1151)# ip address 10.110.1.5/24
CR2(conf-if-vl-1151)# ip ospf 1 area 0.0.0.0
CR2(conf-if-vl-1151)# ip pim sparse-mode
CR2(conf-if-vl-1151)# ip ospf cost 65535
CR2(conf-if-vl-1151)# ip igmp snooping mrouter interface port-channel22
```

- VLAN 1251 towards AG4

```
CR2(config)# interface vlan 1251
CR2(conf-if-vl-1251)# ip address 10.192.168.5/24
CR2(conf-if-vl-1251)# ip ospf 1 area 0.0.0.0
CR2(conf-if-vl-1251)# ip pim sparse-mode
CR2(conf-if-vl-1251)# ip ospf cost 65535
CR2(conf-if-vl-1251)# ip igmp snooping mrouter interface port-channel32
```

13. Configure the interfaces as VLAN trunk ports and specify the allowed VLANs.

```
CR2(config)# interface port-channel 11
CR2(conf-if-po-11)# switchport mode trunk
CR2(conf-if-po-11)# switchport trunk allowed vlan 1001
```

```
CR2(config)# interface port-channel 22
CR2(conf-if-po-22)# switchport mode trunk
CR2(conf-if-po-22)# switchport trunk allowed vlan 1151
```

```
CR2(config)# interface port-channel 32
CR2(conf-if-po-32)# switchport mode trunk
CR2(conf-if-po-32)# switchport trunk allowed vlan 1251
```

```
CR2(config)# interface ethernet 1/1/28:2
CR2(conf-if-eth1/1/28:2)# switchport mode trunk
CR2(conf-if-eth1/1/28:2)# switchport trunk allowed vlan 100
```

```
CR2(config)# interface ethernet 1/1/28:4
CR2(conf-if-eth1/1/28:4)# switchport mode trunk
CR2(conf-if-eth1/1/28:4)# switchport trunk allowed vlan 100
```

## AG1 switch

1. Configure RSTP.

```
AG1(config)# spanning-tree mode rstp
AG1(config)# spanning-tree rstp priority 0
```

2. Configure the VLT domain.

```
AG1(config)# interface ethernet 1/1/25:1
AG1(conf-if-eth1/1/25:1)# no switchport

AG1(config)# vlt-domain 1
AG1(conf-vlt-1)# backup destination 10.222.208.211
AG1(conf-vlt-1)# discovery-interface ethernet1/1/25:1
AG1(conf-vlt-1)# peer-routing
AG1(conf-vlt-1)# primary-priority 1
AG1(conf-vlt-1)# vlt-mac de:11:de:11:de:11
```

3. Configure a port channel interface towards CR1 and CR2.

```
AG1(config)# interface port-channel 11
AG1(config)# interface ethernet 1/1/1:1
```

```

AG1(conf-if-eth1/1/1:1)# channel-group 11 mode active

AG1(config)# interface ethernet 1/1/3:1
AG1(conf-if-eth1/1/3:1)# channel-group 11 mode active

AG1(config)# interface port-channel 11
AG1(conf-if-po-11)# vlt-port-channel 11
AG1(conf-if-po-11)# spanning-tree disable

```

4. Configure a port channel interface towards AG3 and AG4.

```

AG1(config)# interface port-channel 1
AG1(conf-if-po-1)# vlt-port-channel 1

AG1(config)# interface ethernet 1/1/24:1
AG1(conf-if-eth1/1/24:1)# channel-group 1 mode active

AG1(config)# interface ethernet 1/1/26:1
AG1(conf-if-eth1/1/26:1)# channel-group 1 mode active

```

5. Configure a port channel interface towards TR1.

```

AG1(config)# interface port-channel 41
AG1(conf-if-po-41)# vlt-port-channel 41

AG1(config)# interface ethernet 1/1/17:1
AG1(conf-if-eth1/1/17:1)# channel-group 41 mode active

```

6. Configure a Loopback interface and enable PIM-SM.

```

AG1(config)# interface loopback 1
AG1(conf-if-lo-1)# ip address 10.1.100.1/32
AG1(conf-if-lo-1)# ip pim sparse-mode

```

7. Enable multicast routing on the default VRF.

```

AG1(config)# ip multicast-routing

```

8. Configure OSPF for unicast routing.

```

AG1(config)# router ospf 1
AG1(config-router-ospf-1)# log-adjacency-changes
AG1(config-router-ospf-1)# redistribute connected
AG1(config-router-ospf-1)# router-id 10.1.100.1

```

9. Configure the IP address, OSPF process, and PIM-SM on the VLANs.

- VLAN 1001 towards CR1 and CR2

```

AG1(config)# interface vlan 1001
AG1(conf-if-vl-1001)# ip address 10.1.2.1/24
AG1(conf-if-vl-1001)# ip ospf 1 area 0.0.0.0
AG1(conf-if-vl-1001)# ip pim sparse-mode
AG1(conf-if-vl-1001)# ip igmp snooping mrouter interface port-channel11

```

- VLAN 1301 towards AG3 and AG4

```

AG1(config)# interface vlan 1301
AG1(conf-if-vl-1301)# ip address 10.112.1.1/24
AG1(conf-if-vl-1301)# ip ospf 1 area 0.0.0.0
AG1(conf-if-vl-1301)# ip pim sparse-mode
AG1(conf-if-vl-1301)# ip igmp snooping mrouter interface port-channel11

```

- VLAN 2001 towards TR1

```

AG1(config)# interface vlan 2001
AG1(conf-if-vl-2001)# ip address 192.168.1.1/24
AG1(conf-if-vl-2001)# ip pim sparse-mode
AG1(conf-if-vl-2001)# ip pim dr-priority 4294967295
AG1(conf-if-vl-2001)# ip igmp snooping mrouter interface port-channel11

```



10. Configure the interfaces as VLAN trunk ports and specify the allowed VLANs.

```
AG1(config)# interface port-channel 11
AG1(conf-if-po-11)# switchport mode trunk
AG1(conf-if-po-11)# switchport trunk allowed vlan 1001
```

```
AG1(config)# interface port-channel 1
AG1(conf-if-po-1)# switchport mode trunk
AG1(conf-if-po-1)# switchport trunk allowed vlan 1301,2001
```

```
AG1(config)# interface port-channel 41
AG1(conf-if-po-41)# switchport mode trunk
AG1(conf-if-po-41)# switchport trunk allowed vlan 2001
```

```
AG1(config)# interface ethernet 1/1/6:2
AG1(conf-if-eth1/1/6:2)# switchport mode trunk
AG1(conf-if-eth1/1/6:2)# switchport trunk allowed vlan 2001
AG1(conf-if-eth1/1/6:2)# spanning-tree port type edge
```

## AG2 switch

1. Configure RSTP.

```
AG2(config)# spanning-tree mode rstp
AG2(config)# spanning-tree rstp priority 4096
```

2. Configure the VLT domain.

```
AG2(config)# interface ethernet 1/1/25:1
AG2(conf-if-eth1/1/25:1)# no switchport

AG2(config)#vlt-domain 1
AG2(conf-vlt-1)# backup destination 10.16.208.218
AG2(conf-vlt-1)# discovery-interface ethernet1/1/25:1
AG2(conf-vlt-1)# peer-routing
AG2(conf-vlt-1)# primary-priority 65535
AG2(conf-vlt-1)# vlt-mac de:11:de:11:de:11
```

3. Configure a port channel interface towards CR1 and CR2.

```
AG2(config)# interface port-channel 11

AG2(config)# interface ethernet 1/1/1:1
AG2(conf-if-eth1/1/1:1)# channel-group 11 mode active

AG2(config)# interface ethernet 1/1/3:1
AG2(conf-if-eth1/1/3:1)# channel-group 11 mode active

AG2(config)# interface port-channel 11
AG2(conf-if-po-11)# vlt-port-channel 11
AG2(conf-if-po-11)# spanning-tree disable
```

4. Configure a port channel interface towards AG3 and AG4.

```
AG2(config)# interface port-channel 1
AG2(conf-if-po-1)# vlt-port-channel 1

AG2(config)# interface ethernet 1/1/24:1
AG2(conf-if-eth1/1/24:1)# channel-group 1 mode active

AG2(config)# interface ethernet 1/1/26:1
AG2(conf-if-eth1/1/26:1)# channel-group 1 mode active
```

5. Configure a port channel interface towards TR1.

```
AG2(config)# interface port-channel 41
AG2(conf-if-po-41)# vlt-port-channel 41
```

```
AG2(config)# interface ethernet 1/1/17:1
AG2(conf-if-eth1/1/17:1)# channel-group 41 mode active
```

6. Configure Loopback interface and enable PIM-SM.

```
AG2(config)# interface loopback 1
AG2(conf-if-lo-1)# ip address 10.1.100.2/32
AG2(conf-if-lo-1)# ip pim sparse-mode
```

7. Enable multicast routing on the default VRF.

```
AG2(config)# ip multicast-routing
```

8. Configure OSPF for unicast routing.

```
AG2(config)# router ospf 1
AG2(config-router-ospf-1)# log-adjacency-changes
AG2(config-router-ospf-1)# redistribute connected
AG2(config-router-ospf-1)# router-id 10.1.100.2
```

9. Configure the IP address, OSPF process, and PIM-SM on the VLANs.

- VLAN 1001 towards CR1 and CR2

```
AG2(config)# interface vlan 1001
AG2(conf-if-vl-1001)# ip address 10.1.2.2/24
AG2(conf-if-vl-1001)# ip ospf 1 area 0.0.0.0
AG2(conf-if-vl-1001)# ip pim sparse-mode
AG2(conf-if-vl-1001)# ip igmp snooping mrouter interface port-channel11
```

- VLAN 1301 towards AG3 and AG4

```
AG2(config)# interface vlan 1301
AG2(conf-if-vl-1301)# ip address 10.112.1.2/24
AG2(conf-if-vl-1301)# ip ospf 1 area 0.0.0.0
AG2(conf-if-vl-1301)# ip pim sparse-mode
AG2(conf-if-vl-1301)# ip igmp snooping mrouter interface port-channel1
```

- VLAN 2001 towards TR1

```
AG2(config)# interface vlan 2001
AG2(conf-if-vl-2001)# ip address 192.168.1.2/24
AG2(conf-if-vl-2001)# ip pim sparse-mode
AG2(conf-if-vl-2001)# ip pim dr-priority 4294967290
AG2(conf-if-vl-2001)# ip igmp snooping mrouter interface port-channel1
```

10. Configure the interfaces as VLAN trunk ports and specify the allowed VLANs.

```
AG2(config)# interface port-channel 11
AG2(conf-if-po-11)# switchport mode trunk
AG2(conf-if-po-11)# switchport trunk allowed vlan 1001
```

```
AG2(config)# interface port-channel 1
AG2(conf-if-po-1)# switchport mode trunk
AG2(conf-if-po-1)# switchport trunk allowed vlan 1301,2001
```

```
AG2(config)# interface port-channel 41
AG2(conf-if-po-41)# switchport mode trunk
AG2(conf-if-po-41)# switchport trunk allowed vlan 2001
```

```
AG2(config)# interface ethernet 1/1/6:2
AG2(conf-if-eth1/1/6:2)# switchport mode trunk
AG2(conf-if-eth1/1/6:2)# switchport trunk allowed vlan 2001
AG2(conf-if-eth1/1/6:2)# spanning-tree port type edge
```

## AG3 switch

1. Configure RSTP.

```
AG3(config)# spanning-tree mode rstp
AG3(config)# spanning-tree rstp priority 8192
```

2. Configure the VLT domain.

```
AG3(config)# interface ethernet 1/1/25:1
AG3(conf-if-eth1/1/25:1)# no switchport

AG3(config)#vlt-domain 1
AG3(conf-vlt-255)# backup destination 10.222.208.39
AG3(conf-vlt-255)# discovery-interface ethernet1/1/25:1
AG3(conf-vlt-255)# peer-routing
AG3(conf-vlt-255)# primary-priority 1
AG3(conf-vlt-255)# vlt-mac f0:ce:10:f0:ce:10
```

3. Configure a port channel interface towards CR1.

```
AG3(config)# interface port-channel 21

AG3(config)# interface ethernet 1/1/1:1
AG3(conf-if-eth1/1/1:1)# channel-group 21 mode active
```

4. Configure a port channel interface towards CR2.

```
AG3(config)# interface port-channel 22

AG3(config)# interface ethernet 1/1/4:1
AG3(conf-if-eth1/1/4:1)# channel-group 22 mode active
```

5. Configure a port channel interface towards AG3 and AG4.

```
AG3(config)# interface port-channel 1
AG3(conf-if-po-1)# vlt-port-channel 1

AG3(config)# interface ethernet 1/1/24:1
AG3(conf-if-eth1/1/24:1)# channel-group 1 mode active

AG3(config)# interface ethernet 1/1/26:1
AG3(conf-if-eth1/1/26:1)# channel-group 1 mode active
```

6. Configure a port channel interface towards TR2.

```
AG3(config)# interface port-channel 51
AG3(conf-if-po-51)# vlt-port-channel 51

AG3(config)# interface ethernet 1/1/17:1
AG3(conf-if-eth1/1/17:1)# channel-group 51 mode active
```

7. Enable multicast routing on the default VRF.

```
AG3(config)# ip multicast-routing
```

8. Configure OSPF for unicast routing.

```
AG3(config)# router ospf 1
AG3(config-router-ospf-1)# log-adjacency-changes
AG3(config-router-ospf-1)# redistribute connected
AG3(config-router-ospf-1)# router-id 10.1.100.3
```

9. Configure the IP address, OSPF process, and PIM-SM on the VLANs.

- VLAN 1101 towards CR1

```
AG3(config)# interface vlan 1101
AG3(conf-if-vl-1101)# ip address 10.1.3.3/24
AG3(conf-if-vl-1101)# ip ospf 1 area 0.0.0.0
```

```
AG3(conf-if-vl-1101)# ip pim sparse-mode
AG3(conf-if-vl-1101)# ip igmp snooping mrouter interface port-channel21
```

- VLAN 1151 towards CR2

```
AG3(config)# interface vlan 1151
AG3(conf-if-vl-1151)# ip address 10.110.1.3/24
AG3(conf-if-vl-1151)# ip ospf 1 area 0.0.0.0
AG3(conf-if-vl-1151)# ip pim sparse-mode
AG3(conf-if-vl-1151)# ip igmp snooping mrouter interface port-channel22
```

- VLAN 1301 towards AG1 and AG2

```
AG3(config)# interface vlan 1301
AG3(conf-if-vl-1301)# ip address 10.112.1.3/24
AG3(conf-if-vl-1301)# ip ospf 1 area 0.0.0.0
AG3(conf-if-vl-1301)# ip pim sparse-mode
AG3(conf-if-vl-1301)# ip igmp snooping mrouter interface port-channel1
```

- VLAN 2001 towards TR2

```
AG3(config)# interface vlan 2001
AG3(conf-if-vl-2001)# ip address 192.168.1.3/24
AG3(conf-if-vl-2001)# ip pim sparse-mode
AG3(conf-if-vl-2001)# ip pim dr-priority 100000
AG3(conf-if-vl-2001)# ip igmp snooping mrouter interface port-channel1
```

## 10. Configure the interfaces as VLAN trunk ports and specify the allowed VLANs.

```
AG3(config)# interface port-channel 21
AG3(conf-if-po-21)# switchport mode trunk
AG3(conf-if-po-21)# switchport trunk allowed vlan 1101
AG3(conf-if-po-21)# spanning-tree disable
```

```
AG3(config)# interface port-channel 22
AG3(conf-if-po-22)# switchport mode trunk
AG3(conf-if-po-22)# switchport trunk allowed vlan 1201
AG3(conf-if-po-22)# spanning-tree disable
```

```
AG3(config)# interface port-channel 1
AG3(conf-if-po-1)# switchport mode trunk
AG3(conf-if-po-1)# switchport trunk allowed vlan 1301,2001
```

```
AG3(config)# interface port-channel 51
AG3(conf-if-po-51)# switchport mode trunk
AG3(conf-if-po-51)# switchport trunk allowed vlan 2001
```

```
AG3(config)# interface ethernet 1/1/32:2
AG3(conf-if-eth1/1/32:2)# switchport mode trunk
AG3(conf-if-eth1/1/32:2)# switchport trunk allowed vlan 2001
AG3(conf-if-eth1/1/32:2)# spanning-tree port type edge
```

## AG4 switch

1. Configure RSTP.

```
AG4(config)# spanning-tree mode rstp
AG4(config)# spanning-tree rstp priority 12288
```

2. Configure the VLT domain.

```
AG4(config)# interface ethernet 1/1/25:1
AG4(conf-if-eth1/1/25:1)# no switchport

AG4(config)#vlt-domain 1
AG4(conf-vlt-255)# backup destination 10.222.208.219
AG4(conf-vlt-255)# discovery-interface ethernet1/1/25:1
```

```
AG4(config-vlt-255)# peer-routing
AG4(config-vlt-255)# primary-priority 65535
AG4(config-vlt-255)# vlt-mac f0:ce:10:f0:ce:10
```

3. Configure a port channel interface towards CR1.

```
AG4(config)# interface port-channel 31
AG4(config)# interface ethernet 1/1/1:1
AG4(config-if-eth1/1/1:1)# channel-group 31 mode active
```

4. Configure a port channel interface towards CR2.

```
AG4(config)# interface port-channel 32
AG4(config)# interface ethernet 1/1/4:1
AG4(config-if-eth1/1/4:1)# channel-group 32 mode active
```

5. Configure a port channel interface towards AG3 and AG4.

```
AG4(config)# interface port-channel 1
AG4(config-if-po-1)# vlt-port-channel 1
AG4(config)# interface ethernet 1/1/24:1
AG4(config-if-eth1/1/24:1)# channel-group 1 mode active
AG4(config)# interface ethernet 1/1/26:1
AG4(config-if-eth1/1/26:1)# channel-group 1 mode active
```

6. Configure a port channel interface towards TR2.

```
AG4(config)# interface port-channel 51
AG4(config-if-po-51)# vlt-port-channel 51
AG4(config)# interface ethernet 1/1/17:1
AG4(config-if-eth1/1/17:1)# channel-group 51 mode active
```

7. Enable multicast routing on the default VRF.

```
AG4(config)# ip multicast-routing
```

8. Configure OSPF for unicast routing.

```
AG4(config)# router ospf 1
AG4(config-router-ospf-1)# log-adjacency-changes
AG4(config-router-ospf-1)# redistribute connected
AG4(config-router-ospf-1)# router-id 10.1.100.4
```

9. Configure the IP address, OSPF process, and PIM-SM on the VLANs.

- VLAN 1201 towards CR1

```
AG4(config)# interface vlan 1201
AG4(config-if-vl-1201)# ip address 10.1.4.4/24
AG4(config-if-vl-1201)# ip ospf 1 area 0.0.0.0
AG4(config-if-vl-1201)# ip pim sparse-mode
AG4(config-if-vl-1201)# ip igmp snooping mrouter interface port-channel31
```

- VLAN 1251 towards CR2

```
AG4(config)# interface vlan 1251
AG4(config-if-vl-1251)# ip address 10.192.168.4/24
AG4(config-if-vl-1251)# ip ospf 1 area 0.0.0.0
AG4(config-if-vl-1251)# ip pim sparse-mode
AG4(config-if-vl-1251)# ip igmp snooping mrouter interface port-channel32
```

- VLAN 1301 towards AG1 and AG2

```
AG4(config)# interface vlan 1301
AG4(config-if-vl-1301)# ip address 10.112.1.4/24
AG4(config-if-vl-1301)# ip ospf 1 area 0.0.0.0
```

```
AG4(conf-if-vl-1301)# ip pim sparse-mode
AG4(conf-if-vl-1301)# ip igmp snooping mrouter interface port-channel1
```

- VLAN 2001 towards TR2

```
AG4(config)# interface vlan 2001
AG4(conf-if-vl-2001)# ip address 192.168.1.4/24
AG4(conf-if-vl-2001)# ip pim sparse-mode
AG4(conf-if-vl-2001)# ip igmp snooping mrouter interface port-channel1
```

10. Configure the interfaces as VLAN trunk ports and specify the allowed VLANs.

```
AG4(config)# interface port-channel 31
AG4(conf-if-po-31)# switchport mode trunk
AG4(conf-if-po-31)# switchport trunk allowed vlan 1201
AG4(conf-if-po-31)# spanning-tree disable
```

```
AG4(config)# interface port-channel 32
AG4(conf-if-po-32)# switchport mode trunk
AG4(conf-if-po-32)# switchport trunk allowed vlan 1251
AG4(conf-if-po-32)# spanning-tree disable
```

```
AG4(config)# interface port-channel 1
AG4(conf-if-po-1)# switchport mode trunk
AG4(conf-if-po-1)# switchport trunk allowed vlan 1301,2001
```

```
AG4(config)# interface port-channel 51
AG4(conf-if-po-51)# switchport mode trunk
AG4(conf-if-po-51)# switchport trunk allowed vlan 2001
```

```
AG4(config)# interface ethernet 1/1/32:2
AG4(conf-if-eth1/1/32:2)# switchport mode trunk
AG4(conf-if-eth1/1/32:2)# switchport trunk allowed vlan 2001
AG4(conf-if-eth1/1/32:2)# spanning-tree port type edge
```

## TR1 switch

1. Configure RSTP.

```
TR1(config)# spanning-tree mode rstp
```

2. Configure a port channel interface towards AG1.

```
TR1(config)# interface port-channel 41
TR1(config)# interface ethernet 1/1/39
TR1(conf-if-eth1/1/39)# channel-group 41 mode active
```

3. Configure a port channel interface towards AG2.

```
TR1(config)# interface ethernet 1/1/27:1
TR1(conf-if-eth1/1/27:1)# channel-group 41 mode active
```

4. Configure VLAN 2001 towards AG1 and AG2.

```
TR1(config)# interface vlan 2001
```

5. Configure the interfaces as VLAN trunk ports and specify the allowed VLANs.

```
TR1(config)# interface port-channel 41
TR1(conf-if-po-41)# switchport mode trunk
TR1(conf-if-po-41)# switchport trunk allowed vlan 2001
```

```
TR1(config)# interface ethernet 1/1/31
TR1(conf-if-eth1/1/31)# switchport mode trunk
```

```
TR1(conf-if-eth1/1/31)# switchport trunk allowed vlan 2001
TR1(conf-if-eth1/1/31)# spanning-tree port type edge
```

```
TR1(config)# interface ethernet 1/1/32
TR1(conf-if-eth1/1/32)# switchport mode trunk
TR1(conf-if-eth1/1/32)# switchport trunk allowed vlan 2001
TR1(conf-if-eth1/1/32)# spanning-tree port type edge
```

## TR2 switch

1. Configure RSTP.

```
TR2(config)# spanning-tree mode rstp
```

2. Configure a port channel interface towards AG3.

```
TR2(config)# interface port-channel 51
TR2(config)# interface ethernet 1/1/1
TR2(conf-if-eth1/1/1)# channel-group 51 mode active
```

3. Configure a port channel interface towards AG4.

```
TR2(config)# interface ethernet 1/1/25:1
TR2(conf-if-eth1/1/25:1)# channel-group 51 mode active
```

4. Configure VLAN 2001 towards AG1 and AG2.

```
TR2(config)# interface vlan 2001
```

5. Configure the interfaces as VLAN trunk ports and specify the allowed VLANs.

```
TR2(config)# interface port-channel 51
TR2(conf-if-po-51)# switchport mode trunk
TR2(conf-if-po-51)# switchport trunk allowed vlan 2001
```

```
TR2(config)# interface ethernet 1/1/21
TR2(conf-if-eth1/1/31)# switchport mode trunk
TR2(conf-if-eth1/1/31)# switchport trunk allowed vlan 2001
TR2(conf-if-eth1/1/31)# spanning-tree port type edge
```

```
TR2(config)# interface ethernet 1/1/22
TR2(conf-if-eth1/1/32)# switchport mode trunk
TR2(conf-if-eth1/1/32)# switchport trunk allowed vlan 2001
TR2(conf-if-eth1/1/32)# spanning-tree port type edge
```

## Verify the configuration

You can use the following show commands to verify the configuration.

### CR1

The show ip pim interface command displays the PIM-enabled interfaces on the node.

```
CR1# show ip pim interface
Address Interface Ver/Mode Nbr Count Query Intvl DR Prio DR

10.1.1.5 vlan100 v2/S 1 30 1 10.1.1.6
10.1.3.5 vlan1101 v2/S 1 30 1 10.1.3.5
10.1.4.5 vlan1201 v2/S 1 30 1 10.1.4.5
10.1.2.5 vlan1001 v2/S 3 30 1 10.1.2.6
```

The show ip pim neighbor command displays the PIM neighbor of the node and the interface to reach the neighbor.

```
CR1# show ip pim neighbor
Neighbor Address Interface Uptime/Expires Ver DR Priority / Mode

10.1.1.6 vlan100 00:24:19/00:01:25 v2 4294967295 / DR
S
10.1.3.3 vlan1101 00:20:28/00:01:18 v2 1 /
S
10.1.4.4 vlan1201 00:18:21/00:01:24 v2 1 /
S
10.1.2.1 vlan1001 00:22:12/00:01:36 v2 1 /
S
10.1.2.2 vlan1001 00:17:38/00:01:36 v2 1 /
S
10.1.2.6 vlan1001 00:24:17/00:01:36 v2 1 / DR S
```

The show ip pim summary command displays the PIM summary.

```
CR1# show ip pim summary

Entries in PIM-TIB/MFC: 96/52

Active Modes:
 PIM-SM

Interface summary:
 4 active PIM interfaces
 0 passive PIM interfaces
 6 active PIM neighbor

TIB Summary:
 20/12 (*,G) entries in PIM-TIB/MFC
 40/40 (S,G) entries in PIM-TIB/MFC
 36/0 (S,G,Rpt) entries in PIM-TIB/MFC

 2 RP
 3 sources
 0 Register states

Message Summary:
 189/770 Joins/Prunes sent/received
 0/56 Candidate-RP advertisements sent/received
 420/112 BSR messages sent/received

 267 Null Register messages received
 357/0 Register-stop messages sent/received

Data path event summary:
 0 last-hop switchover messages received
 28/28 pim-assert messages sent/received
 0/119 register messages sent/received

VLT Multicast summary:
 0(*,G) synced entries in MFC
 20(S,G) synced entries in MFC
 0(S,G,Rpt) synced entries in MFC
```

The show ip pim tib command displays the PIM tree information base (TIB).

```
CR1# show ip pim tib

PIM Multicast Routing Table
Flags: S - Sparse, C - Connected, L - Local, P - Pruned,
 R - RP-bit set, F - Register Flag, T - SPT-bit set, J - Join SPT,
 K - Ack-Pending state
Timers: Uptime/Expires
Interface state: Interface, next-Hop, State/Mode

(*, 225.1.0.0), uptime 01:42:49, expires 00:00:00, RP 10.1.100.6, flags: SC
 Incoming interface: vlan100, RPF neighbor 10.1.1.6
 Outgoing interface list:
```



```
(172.16.1.201, 225.1.0.0), uptime 01:24:45, expires 00:02:46, flags: CTP
Incoming interface: vlan100, RPF neighbor 0.0.0.0
Outgoing interface list:
```

The `show ip pim mcache` command displays the multicast route entries.

```
CR1# show ip pim mcache
PIM Multicast Routing Cache Table

(192.168.1.201, 225.1.0.0)
Incoming interface : vlan1001
Outgoing interface list :
vlan1

(192.168.1.202, 225.1.0.0)
Incoming interface : vlan1001
Outgoing interface list :
vlan1

(172.16.1.201, 225.1.0.0)
Incoming interface : vlan1
Outgoing interface list :
vlan1001
```

The `show ip pim mcache vlt` command displays the multicast route entries synchronized between the VLT peers.

```
CR1# show ip pim mcache vlt | no-more
PIM Multicast Routing Cache Table
Flags: S - Synced

(192.168.1.201, 225.1.0.0), flags: S
Incoming interface : vlan1001
Outgoing interface list :
vlan100 (S)

(192.168.1.202, 225.1.0.0), flags: S
Incoming interface : vlan1001
Outgoing interface list :
vlan100 (S)

(172.16.1.201, 225.1.0.0)
Incoming interface : vlan1
Outgoing interface list :
vlan1001 (S)
```

The `show ip pim bsr-router` command displays information about the BSR.

```
CR1# show ip pim bsr-router

This system is the Bootstrap Router (v2)
BSR address: 10.1.100.5
BSR Priority: 199, Hash mask length: 31
Next bootstrap message in 00:00:12
This system is a candidate BSR
Candidate BSR address: 10.1.100.5, priority: 199, hash mask length: 31
Next Cand_RP_advertisement in 00:00:24
RP: 10.1.100.5(loopback1)
```

The `show ip pim rp` command displays information about all multicast group-to-RP mappings.

```
CR1# show ip pim rp
Group RP
```

```

225.1.0.0 10.1.100.6
```

```
CR1# show ip pim rp mapping
Group(s) : 225.0.0.0/8
RP : 10.1.100.5, v2
 Info source: 10.1.100.5, via bootstrap, priority 100
 expires: 00:00:56
Group(s) : 225.0.0.0/8
RP : 10.1.100.6, v2
 Info source: 10.1.100.5, via bootstrap, priority 100
 expires: 00:01:07
```

The show ip igmp snooping groups command displays the IGMP database.

```
CR1# show ip igmp snooping groups
Total Number of Groups: 320
```

```
CR1# show ip igmp snooping groups vlan 1 225.1.0.0 detail
Interface vlan1
Group 225.1.0.0
Source List
--
 Member Port Mode Uptime
Expires
 port-channel1000 IGMPv2-Compat 01:56:53
00:02:07
 ethernet1/1/28:1 IGMPv2-Compat 01:56:53 00:02:03
```

## CR2

The show ip pim interface command displays the PIM-enabled interfaces on the node.

```
CR2# show ip pim interface
Address Interface Ver/Mode Nbr Count Query Intvl DR Prio DR

10.1.1.6 vlan100 v2/S 1 30 4294967295
10.1.1.6
10.110.1.5 vlan1151 v2/S 1 30 1
10.110.1.5
10.192.168.5 vlan1251 v2/S 1 30 1
10.192.168.5
10.1.2.6 vlan1001 v2/S 3 30 1 10.1.2.6
```

The show ip pim neighbor command displays the PIM neighbor of the node and the interface to reach the neighbor.

```
CR2# show ip pim neighbor
Neighbor Address Interface Uptime/Expires Ver DR Priority / Mode

10.1.1.5 vlan100 00:26:16/00:01:28 v2 1 / S
10.110.1.3 vlan1151 00:22:17/00:01:29 v2 1 / S
10.192.168.4 vlan1251 00:20:13/00:01:31 v2 1 / S
10.1.2.1 vlan1001 00:24:09/00:01:39 v2 1 / S
10.1.2.2 vlan1001 00:19:35/00:01:39 v2 1 / S
10.1.2.5 vlan1001 00:26:14/00:01:42 v2 1 / S
```

The show ip pim summary command displays the PIM summary.

```
CR2# show ip pim summary

Entries in PIM-TIB/MFC: 98/59

Active Modes:
 PIM-SM

Interface summary:
 4 active PIM interfaces
 0 passive PIM interfaces
 6 active PIM neighbor
```

```

TIB Summary:
20/20 (*,G) entries in PIM-TIB/MFC
39/39 (S,G) entries in PIM-TIB/MFC
39/0 (S,G,Rpt) entries in PIM-TIB/MFC

2 RP
3 sources
16 Register states

Message Summary:
208/885 Joins/Prunes sent/received
60/0 Candidate-RP advertisements sent/received
310/405 BSR messages sent/received

205 Null Register messages received
268/181 Register-stop messages sent/received

Data path event summary:
11 last-hop switchover messages received
28/28 pim-assert messages sent/received
186/79 register messages sent/received

VLT Multicast summary:
0(*,G) synced entries in MFC
21(S,G) synced entries in MFC
0(S,G,Rpt) synced entries in MFC

```

The show ip pim tib command displays the PIM tree information base (TIB).

```

CR2# show ip pim tib

PIM Multicast Routing Table
Flags: S - Sparse, C - Connected, L - Local, P - Pruned,
 R - RP-bit set, F - Register Flag, T - SPT-bit set, J - Join SPT,
 K - Ack-Pending state
Timers: Uptime/Expires
Interface state: Interface, next-Hop, State/Mode

(*, 225.1.0.0), uptime 01:43:37, expires 00:00:00, RP 10.1.100.6, flags: SC
Incoming interface: Null, RPF neighbor 0.0.0.0
Outgoing interface list:
 vlan100 Forward/Sparse 01:43:37/Never
 vlan1001 Forward/Sparse 01:39:18/00:03:08
 vlan1251 Forward/Sparse 01:25:23/00:03:06

(192.168.1.201, 225.1.0.0), uptime 01:25:24, expires 00:02:42, flags: CT
Incoming interface: vlan1001, RPF neighbor 10.1.2.2
Outgoing interface list:
 vlan100 Forward/Sparse 01:25:24/Never

(192.168.1.202, 225.1.0.0), uptime 01:25:24, expires 00:02:56, flags: CT
Incoming interface: vlan1001, RPF neighbor 10.1.2.2
Outgoing interface list:
 vlan100 Forward/Sparse 01:25:24/Never

(172.16.1.201, 225.1.0.0), uptime 01:25:24, expires 00:02:57, flags: CFT
Incoming interface: vlan100, RPF neighbor 0.0.0.0
Outgoing interface list:
 vlan1001 Forward/Sparse 01:25:24/00:03:13
 vlan1251 Forward/Sparse 01:25:23/00:03:06

```

The show ip pim mcache command displays the multicast route entries.

```

CR2# show ip pim mcache
PIM Multicast Routing Cache Table

(192.168.1.201, 225.1.0.0)
Incoming interface : vlan1001

```

```

Outgoing interface list :
 vlan1

(192.168.1.202, 225.1.0.0)
 Incoming interface : vlan1001
 Outgoing interface list :
 vlan1

(172.16.1.201, 225.1.0.0)
 Incoming interface : vlan1
 Outgoing interface list :
 vlan1001
 vlan1251

```

The `show ip pim mcache vlt` command displays the multicast route entries synchronized between the VLT peers.

```

CR2# show ip pim mcache vlt
PIM Multicast Routing Cache Table
Flags: S - Synced

(192.168.1.201, 225.1.0.0)
 Incoming interface : vlan1001
 Outgoing interface list :
 vlan1

(192.168.1.202, 225.1.0.0)
 Incoming interface : vlan1001
 Outgoing interface list :
 vlan1

(172.16.1.201, 225.1.0.0)
 Incoming interface : vlan1
 Outgoing interface list :
 vlan1001

```

The `show ip pim bsr-router` command displays information about the BSR.

```

CR2# show ip pim bsr-router

PIMv2 Bootstrap information
 BSR address: 10.1.100.5
 BSR Priority: 199, Hash mask length: 31
 Expires: 00:00:17
 This system is a candidate BSR
 Candidate BSR address: 10.1.100.6, priority: 99, hash mask length: 31
 Next Cand RP advertisement in 00:00:24
 RP: 10.1.100.6(loopback1)

```

The `show ip pim rp mapping` command displays information about all multicast group-to-RP mappings.

```

CR2# show ip pim rp
Group RP

225.1.0.0 10.1.100.6

```

```

CR2# show ip pim rp mapping
Group(s) : 225.0.0.0/8
RP : 10.1.100.5, v2
 Info source: 10.1.100.5, via bootstrap, priority 100
 expires: 00:00:58
Group(s) : 225.0.0.0/8
RP : 10.1.100.6, v2
 Info source: 10.1.100.5, via bootstrap, priority 100
 expires: 00:00:39

```

The show ip igmp snooping groups command displays the IGMP database.

```
CR2# show ip igmp snooping groups
Total Number of Groups: 320
```

```
CR2# show ip igmp snooping groups vlan 1 225.1.0.0 detail
Interface vlan1
Group 225.1.0.0
Source List
--
Member Port Mode Uptime
Expires
port-channel1000 IGMPv2-Compat 01:57:20
00:01:39
ethernet1/1/28:4 IGMPv2-Compat 01:57:31 00:01:39
```

## AG1

The show ip pim interface command displays the PIM-enabled interfaces on the node.

```
AG1# show ip pim interface
Address Interface Ver/Mode Nbr Count Query Intvl DR Prio DR

10.1.2.1 vlan1001 v2/S 3 30 30 1 10.1.2.6
10.112.1.1 vlan1301 v2/S 3 30 30 1 10.112.1.4
192.168.1.4 vlan2001 v2/S 3 30 30 4294967295 192.168.1.4
```

The show ip pim neighbor command displays the PIM neighbor of the node and the interface to reach the neighbor.

```
AG1# show ip pim neighbor
Neighbor Address Interface Uptime/Expires Ver DR Priority / Mode

10.1.2.2 vlan1001 00:19:45/00:01:29 v2 1 / S
10.1.2.5 vlan1001 00:24:18/00:01:32 v2 1 / S
10.1.2.6 vlan1001 00:24:19/00:01:29 v2 1 / DR S
10.112.1.2 vlan1301 00:19:52/00:01:22 v2 1 / S
10.112.1.3 vlan1301 00:22:14/00:01:24 v2 1 / S
10.112.1.4 vlan1301 00:20:38/00:01:22 v2 1 / DR S
192.168.1.3 vlan2001 00:19:51/00:01:23 v2 4294967290 / S
192.168.1.2 vlan2001 00:22:11/00:01:23 v2 100000 / S
192.168.1.1 vlan2001 00:20:36/00:01:25 v2 1 / S
```

The show ip pim summary command displays the PIM summary.

```
AG1# show ip pim summary
Entries in PIM-TIB/MFC: 140/80

Active Modes:
PIM-SM

Interface summary:
7 active PIM interfaces
0 passive PIM interfaces
21 active PIM neighbor

TIB Summary:
20/20 (*,G) entries in PIM-TIB/MFC
60/60 (S,G) entries in PIM-TIB/MFC
60/0 (S,G,Rpt) entries in PIM-TIB/MFC

2 RP
3 sources
40 Register states

Message Summary:
418/386 Joins/Prunes sent/received
0/0 Candidate-RP advertisements sent/received
597/1827 BSR messages sent/received

0 Null Register messages received
```

```
0/459 Register-stop messages sent/received
```

Data path event summary:

```
20 last-hop switchover messages received
23/159 pim-assert messages sent/received
499/0 register messages sent/received
```

VLT Multicast summary:

```
0(*,G) synced entries in MFC
0(S,G) synced entries in MFC
0(S,G,Rpt) synced entries in MFC
```

The show ip pim tib command displays the PIM tree information base (TIB).

```
AG1# show ip pim tib
```

PIM Multicast Routing Table

```
Flags: S - Sparse, C - Connected, L - Local, P - Pruned,
 R - RP-bit set, F - Register Flag, T - SPT-bit set, J - Join SPT,
 K - Ack-Pending state
```

Timers: Uptime/Expires

Interface state: Interface, next-Hop, State/Mode

```
(*, 225.1.0.0), uptime 01:39:47, expires 00:00:09, RP 10.1.100.6, flags: SCJ
```

```
Incoming interface: vlan1001, RPF neighbor 10.1.2.6
```

Outgoing interface list:

```
vlan2001 Forward/Sparse 01:39:47/Never
vlan2002 Forward/Sparse 01:39:41/Never
vlan2003 Forward/Sparse 01:39:44/Never
vlan2004 Forward/Sparse 01:39:44/Never
vlan2005 Forward/Sparse 01:39:43/Never
```

```
(192.168.1.201, 225.1.0.0), uptime 01:25:53, expires 00:01:14, flags: CFT
```

```
Incoming interface: vlan2001, RPF neighbor 0.0.0.0
```

Outgoing interface list:

```
vlan2002 Forward/Sparse 01:25:53/Never
vlan2003 Forward/Sparse 01:25:53/Never
vlan2004 Forward/Sparse 01:25:53/Never
vlan2005 Forward/Sparse 01:25:53/Never
```

```
(192.168.1.202, 225.1.0.0), uptime 01:25:53, expires 00:01:14, flags: CFT
```

```
Incoming interface: vlan2001, RPF neighbor 0.0.0.0
```

Outgoing interface list:

```
vlan2002 Forward/Sparse 01:25:53/Never
vlan2003 Forward/Sparse 01:25:53/Never
vlan2004 Forward/Sparse 01:25:53/Never
vlan2005 Forward/Sparse 01:25:53/Never
```

```
(172.16.1.201, 225.1.0.0), uptime 01:22:46, expires 00:01:15, flags: CT
```

```
Incoming interface: vlan1001, RPF neighbor 10.1.2.6
```

Outgoing interface list:

```
vlan2002 Forward/Sparse 01:22:46/Never
vlan2003 Forward/Sparse 01:22:46/Never
vlan2004 Forward/Sparse 01:22:46/Never
vlan2005 Forward/Sparse 01:22:46/Never
```

The show ip pim mcache command displays the multicast route entries.

```
AG1# show ip pim mcache
```

PIM Multicast Routing Cache Table

```
(*, 225.1.0.0)
```

```
Incoming interface : vlan1001
```

Outgoing interface list :

```
vlan2002
vlan2003
vlan2004
vlan2005
```

```

(192.168.1.201, 225.1.0.0)
 Incoming interface : vlan2001
 Outgoing interface list :
 vlan1001
 vlan2002
 vlan2003
 vlan2004
 vlan2005

(192.168.1.202, 225.1.0.0)
 Incoming interface : vlan2001
 Outgoing interface list :
 vlan1001
 vlan2002
 vlan2003
 vlan2004
 vlan2005

(172.16.1.201, 225.1.0.0)
 Incoming interface : vlan1001
 Outgoing interface list :
 vlan2002
 vlan2003
 vlan2004
 vlan2005

```

The `show ip pim mcache vlt` command displays the multicast route entries synchronized between the VLT peers.

```

AG1# show ip pim mcache vlt | no-more
PIM Multicast Routing Cache Table
Flags: S - Synced

(*, 225.1.0.0)
 Incoming interface : vlan1001
 Outgoing interface list :
 vlan2002
 vlan2003
 vlan2004
 vlan2005

(192.168.1.201, 225.1.0.0)
 Incoming interface : vlan2001
 Outgoing interface list :
 vlan1001 (S)
 vlan2002
 vlan2003
 vlan2004
 vlan2005

(192.168.1.202, 225.1.0.0)
 Incoming interface : vlan2001
 Outgoing interface list :
 vlan1001 (S)
 vlan2002
 vlan2003
 vlan2004
 vlan2005

(172.16.1.201, 225.1.0.0)
 Incoming interface : vlan1001
 Outgoing interface list :
 vlan2002
 vlan2003
 vlan2004
 vlan2005

```

The `show ip pim bsr-router` command displays information about the BSR.

```

AG1# show ip pim bsr-router

PIMv2 Bootstrap information
 BSR address: 10.1.100.5

```

```
BSR Priority: 199, Hash mask length: 31
Expires: 00:00:23
```

The show ip pim rp mapping command displays information about all multicast group-to-RP mappings.

```
AG1# show ip pim rp
Group RP

225.1.0.0 10.1.100.6
```

```
AG1# show ip pim rp mapping
Group(s) : 225.0.0.0/8
RP : 10.1.100.5, v2
 Info source: 10.1.100.5, via bootstrap, priority 100
 expires: 00:00:45
Group(s) : 225.0.0.0/8
RP : 10.1.100.6, v2
 Info source: 10.1.100.5, via bootstrap, priority 100
 expires: 00:00:56
```

The show ip igmp snooping groups command displays the IGMP database.

```
AG1# show ip igmp snooping groups
Total Number of Groups: 1600
```

```
AG1# show ip igmp snooping groups vlan 2001 225.1.0.0 detail
Interface vlan2001
Group 225.1.0.0
Source List
--
Member Port Mode Uptime
Expires
port-channel1 Exclude 01:53:40
00:01:35
port-channel1000 IGMPv2-Compat 01:53:16
00:01:41
port-channel41 Exclude 01:53:37
00:01:37
ethernet1/1/6:2 IGMPv2-Compat 01:53:34 00:01:41
```

## AG2

The show ip pim interface command displays the PIM-enabled interfaces on the node.

```
AG2# show ip pim interface
Address Interface Ver/Mode Nbr Count Query Intvl DR Prio DR

192.168.1.3 vlan2001 v2/S 3 30 4294967290 192.168.1.4
10.112.1.2 vlan1301 v2/S 3 30 1 10.112.1.4
10.1.2.2 vlan1001 v2/S 3 30 1 10.1.2.6
```

The show ip pim neighbor command displays the PIM neighbor of the node and the interface to reach the neighbor.

```
AG2# show ip pim neighbor
Neighbor Address Interface Uptime/Expires Ver DR Priority / Mode

192.168.1.4 vlan2001 00:21:42/00:01:38 v2 4294967295 / DR S
192.168.1.2 vlan2001 00:21:50/00:01:38 v2 100000 / S
192.168.1.1 vlan2001 00:20:39/00:01:39 v2 1 / S
10.112.1.1 vlan1301 00:22:29/00:01:40 v2 1 / S
10.112.1.3 vlan1301 00:22:29/00:01:38 v2 1 / S
10.112.1.4 vlan1301 00:20:39/00:01:36 v2 1 / DR S
10.1.2.1 vlan1001 00:22:44/00:01:44 v2 1 / S
10.1.2.5 vlan1001 00:22:33/00:01:17 v2 1 / S
10.1.2.6 vlan1001 00:22:34/00:01:44 v2 1 / DR S
```



The show ip pim summary command displays the PIM summary.

```
AG2# show ip pim summary

Entries in PIM-TIB/MFC: 60/40

Active Modes:
 PIM-SM

Interface summary:
 7 active PIM interfaces
 0 passive PIM interfaces
 21 active PIM neighbor

TIB Summary:
 20/0 (*,G) entries in PIM-TIB/MFC
 40/40 (S,G) entries in PIM-TIB/MFC
 0/0 (S,G,Rpt) entries in PIM-TIB/MFC

 2 RP
 2 sources
 0 Register states

Message Summary:
 63/775 Joins/Prunes sent/received
 0/0 Candidate-RP advertisements sent/received
 587/1895 BSR messages sent/received

 0 Null Register messages received
 0/0 Register-stop messages sent/received

Data path event summary:
 0 last-hop switchover messages received
 22/162 pim-assert messages sent/received
 0/0 register messages sent/received

VLT Multicast summary:
 20(*,G) synced entries in MFC
 20(S,G) synced entries in MFC
 0(S,G,Rpt) synced entries in MFC
```

The show ip pim tib command displays the PIM tree information base (TIB).

```
AG2# show ip pim tib

PIM Multicast Routing Table
Flags: S - Sparse, C - Connected, L - Local, P - Pruned,
 R - RP-bit set, F - Register Flag, T - SPT-bit set, J - Join SPT,
 K - Ack-Pending state
Timers: Uptime/Expires
Interface state: Interface, next-Hop, State/Mode

(*, 225.1.0.0), uptime 01:40:01, expires 00:00:00, RP 10.1.100.6, flags: SC
 Incoming interface: vlan1001, RPF neighbor 10.1.2.6
 Outgoing interface list:
 vlan2001 Forward/Sparse 01:39:57/Never
 vlan2002 Forward/Sparse 01:40:01/Never
 vlan2003 Forward/Sparse 01:39:55/Never
 vlan2004 Forward/Sparse 01:39:51/Never
 vlan2005 Forward/Sparse 01:39:52/Never

(192.168.1.201, 225.1.0.0), uptime 01:26:21, expires 00:01:10, flags: CT
 Incoming interface: vlan2001, RPF neighbor 0.0.0.0
 Outgoing interface list:
 vlan1001 Forward/Sparse 01:26:21/00:03:09

(192.168.1.202, 225.1.0.0), uptime 01:26:21, expires 00:01:10, flags: CT
 Incoming interface: vlan2001, RPF neighbor 0.0.0.0
 Outgoing interface list:
 vlan1001 Forward/Sparse 01:26:21/00:03:09
```

The `show ip pim mcache` command displays the multicast route entries.

```
AG2# show ip pim mcache
PIM Multicast Routing Cache Table

(*, 225.1.0.0)
 Incoming interface : vlan1001
 Outgoing interface list :
 vlan2002
 vlan2003
 vlan2004
 vlan2005

(192.168.1.201, 225.1.0.0)
 Incoming interface : vlan2001
 Outgoing interface list :
 vlan1001
 vlan2002
 vlan2003
 vlan2004
 vlan2005

(192.168.1.202, 225.1.0.0)
 Incoming interface : vlan2001
 Outgoing interface list :
 vlan1001
 vlan2002
 vlan2003
 vlan2004
 vlan2005

(172.16.1.201, 225.1.0.0)
 Incoming interface : vlan1001
 Outgoing interface list :
 vlan2002
 vlan2003
 vlan2004
 vlan2005
```

The `show ip pim mcache vlt` command displays the multicast route entries synchronized between the VLT peers.

```
AG2# show ip pim mcache vlt | no-more
PIM Multicast Routing Cache Table
Flags: S - Synced

(*, 225.1.0.0), flags: S
 Incoming interface : vlan1001
 Outgoing interface list :
 vlan2002 (S)
 vlan2003 (S)
 vlan2004 (S)
 vlan2005 (S)

(192.168.1.201, 225.1.0.0)
 Incoming interface : vlan2001
 Outgoing interface list :
 vlan1001
 vlan2002 (S)
 vlan2003 (S)
 vlan2004 (S)
 vlan2005 (S)

(192.168.1.202, 225.1.0.0)
 Incoming interface : vlan2001
 Outgoing interface list :
 vlan1001
 vlan2002 (S)
 vlan2003 (S)
 vlan2004 (S)
 vlan2005 (S)

(172.16.1.201, 225.1.0.0), flags: S
```

```

Incoming interface : vlan1001
Outgoing interface list :
vlan2002 (S)
vlan2003 (S)
vlan2004 (S)
vlan2005 (S)

```

The show ip pim bsr-router command displays information about the BSR.

```

AG2# show ip pim bsr-router

PIMv2 Bootstrap information
BSR address: 10.1.100.5
BSR Priority: 199, Hash mask length: 31
Expires: 00:00:26

```

The show ip pim rp mapping command displays information about all multicast group-to-RP mappings.

```

AG2# show ip pim rp
Group RP

225.1.0.0 10.1.100.6

```

```

AG2# show ip pim rp mapping
Group(s) : 225.0.0.0/8
RP : 10.1.100.5, v2
Info source: 10.1.100.5, via bootstrap, priority 100
expires: 00:01:03
Group(s) : 225.0.0.0/8
RP : 10.1.100.6, v2
Info source: 10.1.100.5, via bootstrap, priority 100
expires: 00:00:44

```

The show ip igmp snooping groups command displays the IGMP database.

```

AG2# show ip igmp snooping groups
Total Number of Groups: 1600

```

```

AG2# show ip igmp snooping groups vlan 2001 225.1.0.0 detail
Interface vlan2001
Group 225.1.0.0
Source List
--
Member Port Mode Uptime
Expires
port-channell Exclude 01:51:31
00:01:30
port-channel1000 IGMPv2-Compat 01:53:27
00:01:36
port-channel41 Exclude 01:50:30
00:01:32
ethernet1/1/6:2 IGMPv2-Compat 01:51:28 00:01:30

```

### AG3

The show ip pim interface command displays the PIM-enabled interfaces on the node.

```

AG3# show ip pim interface
Address Interface Ver/Mode Nbr Count Query Intvl DR Prio DR

10.112.1.3 vlan1301 v2/S 3 30 1 10.112.1.4
192.168.1.2 vlan2001 v2/S 3 30 100000 192.168.1.4
10.110.1.3 vlan1151 v2/S 1 30 1 10.110.1.5
10.1.3.3 vlan1101 v2/S 1 30 1 10.1.3.5

```

The show ip pim neighbor command displays the PIM neighbor of the node and the interface to reach the neighbor.

```

AG3# show ip pim neighbor
Neighbor Address Interface Uptime/Expires Ver DR Priority / Mode

```

```

10.112.1.1 vlan1301 00:22:45/00:01:24 v2 1 / S
10.112.1.2 vlan1301 00:20:24/00:01:20 v2 1 / S
10.112.1.4 vlan1301 00:21:09/00:01:20 v2 1 / DR S
192.168.1.4 vlan2001 00:22:47/00:01:22 v2 4294967295 / DR S
192.168.1.3 vlan2001 00:20:22/00:01:22 v2 4294967290 / S
192.168.1.1 vlan2001 00:21:07/00:01:23 v2 1 / S
10.110.1.5 vlan1151 00:22:58/00:01:16 v2 1 / DR S
10.1.3.5 vlan1101 00:23:05/00:01:38 v2 1 / DR S

```

The show ip pim summary command displays the PIM summary.

```

AG3# show ip pim summary

Entries in PIM-TIB/MFC: 60/40

Active Modes:
 PIM-SM

Interface summary:
 8 active PIM interfaces
 0 passive PIM interfaces
 20 active PIM neighbor

TIB Summary:
 20/0 (*,G) entries in PIM-TIB/MFC
 40/40 (S,G) entries in PIM-TIB/MFC
 0/0 (S,G,Rpt) entries in PIM-TIB/MFC

 2 RP
 2 sources
 0 Register states

Message Summary:
 40/20 Joins/Prunes sent/received
 0/0 Candidate-RP advertisements sent/received
 680/1899 BSR messages sent/received

 0 Null Register messages received
 0/0 Register-stop messages sent/received

Data path event summary:
 0 last-hop switchover messages received
 22/164 pim-assert messages sent/received
 0/0 register messages sent/received

VLT Multicast summary:
 0(*,G) synced entries in MFC
 0(S,G) synced entries in MFC
 0(S,G,Rpt) synced entries in MFC

```

The show ip pim tib command displays the PIM tree information base (TIB).

```

AG3# show ip pim tib

PIM Multicast Routing Table
Flags: S - Sparse, C - Connected, L - Local, P - Pruned,
 R - RP-bit set, F - Register Flag, T - SPT-bit set, J - Join SPT,
 K - Ack-Pending state
Timers: Uptime/Expires
Interface state: Interface, next-Hop, State/Mode

(*, 225.1.0.0), uptime 01:39:57, expires 00:00:00, RP 10.1.100.6, flags: SC
Incoming interface: vlan1151, RPF neighbor 10.110.1.5
Outgoing interface list:
 vlan2001 Forward/Sparse 01:39:57/Never
 vlan2002 Forward/Sparse 01:39:57/Never
 vlan2003 Forward/Sparse 01:39:57/Never
 vlan2004 Forward/Sparse 01:39:57/Never
 vlan2005 Forward/Sparse 01:39:57/Never

```

```
(192.168.1.201, 225.1.0.0), uptime 01:26:40, expires 00:00:52, flags: CTP
Incoming interface: vlan2001, RPF neighbor 0.0.0.0
Outgoing interface list:
```

```
(192.168.1.202, 225.1.0.0), uptime 01:26:40, expires 00:00:52, flags: CTP
Incoming interface: vlan2001, RPF neighbor 0.0.0.0
Outgoing interface list:
```

The `show ip pim mcache` command displays the multicast route entries.

```
AG3# show ip pim mcache
PIM Multicast Routing Cache Table

(192.168.1.201, 225.1.0.0)
Incoming interface : vlan2001
Outgoing interface list :

(192.168.1.202, 225.1.0.0)
Incoming interface : vlan2001
Outgoing interface list :
```

The `show ip pim bsr-router` command displays information about the BSR.

```
AG3# show ip pim bsr-router

PIMv2 Bootstrap information
BSR address: 10.1.100.5
BSR Priority: 199, Hash mask length: 31
Expires: 00:00:30
```

The `show ip pim rp mapping` command displays information about all multicast group-to-RP mappings.

```
AG3# show ip pim rp
Group RP

225.1.0.0 10.1.100.6
```

```
AG3# show ip pim rp mapping
Group(s) : 225.0.0.0/8
RP : 10.1.100.5, v2
Info source: 10.1.100.5, via bootstrap, priority 100
expires: 00:00:43
Group(s) : 225.0.0.0/8
RP : 10.1.100.6, v2
Info source: 10.1.100.5, via bootstrap, priority 100
expires: 00:00:54
```

The `show ip igmp snooping groups` command displays the IGMP database.

```
AG3# show ip igmp snooping groups
Total Number of Groups: 1600
```

```
AG3# show ip igmp snooping groups vlan 2001 225.1.0.0 detail
Interface vlan2001
Group 225.1.0.0
Source List
--
Member Port Mode Uptime
Expires
port-channell Exclude 01:53:46
00:01:28
port-channell000 IGMPv2-Compat 01:54:04
00:01:29
port-channel51 Exclude 01:54:40
00:01:23
ethernet1/1/32:2 IGMPv2-Compat 01:54:04 00:01:28
```

## AG4

The `show ip pim interface` command displays the PIM-enabled interfaces on the node.

```
AG4# show ip pim interface
Address Interface Ver/Mode Nbr Count Query Intvl DR Prio DR

10.1.4.4 vlan1201 v2/S 1 30 1 10.1.4.5
10.112.1.4 vlan1301 v2/S 3 30 1 10.112.1.4
192.168.1.1 vlan2001 v2/S 3 30 1 192.168.1.4
10.192.168.4 vlan1251 v2/S 1 30 1 10.192.168.5
```

The `show ip pim neighbor` command displays the PIM neighbor of the node and the interface to reach the neighbor.

```
AG4# show ip pim neighbor
Neighbor Address Interface Uptime/Expires Ver DR Priority / Mode

10.1.4.5 vlan1201 00:22:44/00:01:35 v2 1 / DR S
10.112.1.1 vlan1301 00:22:52/00:01:43 v2 1 / S
10.112.1.2 vlan1301 00:20:35/00:01:40 v2 1 / S
10.112.1.3 vlan1301 00:23:26/00:01:42 v2 1 / S
192.168.1.4 vlan2001 00:22:52/00:01:41 v2 4294967295 / DR S
192.168.1.3 vlan2001 00:20:33/00:01:41 v2 4294967290 / S
192.168.1.2 vlan2001 00:23:50/00:01:41 v2 100000 / S
10.192.168.5 vlan1251 00:22:37/00:01:39 v2 1 / DR S
```

The `show ip pim summary` command displays the PIM summary.

```
AG4# show ip pim summary

Entries in PIM-TIB/MFC: 140/80

Active Modes:
 PIM-SM

Interface summary:
 8 active PIM interfaces
 0 passive PIM interfaces
 20 active PIM neighbor

TIB Summary:
 20/20 (*,G) entries in PIM-TIB/MFC
 60/60 (S,G) entries in PIM-TIB/MFC
 60/0 (S,G,Rpt) entries in PIM-TIB/MFC

 2 RP
 3 sources
 0 Register states

Message Summary:
 389/0 Joins/Prunes sent/received
 0/0 Candidate-RP advertisements sent/received
 687/1944 BSR messages sent/received

 0 Null Register messages received
 0/0 Register-stop messages sent/received

Data path event summary:
 22 last-hop switchover messages received
 120/67 pim-assert messages sent/received
 0/0 register messages sent/received

VLT Multicast summary:
 0(*,G) synced entries in MFC
 0(S,G) synced entries in MFC
 0(S,G,Rpt) synced entries in MFC
```

The `show ip pim tib` command displays the PIM tree information base (TIB).

```
AG4# show ip pim tib
```

```

PIM Multicast Routing Table
Flags: S - Sparse, C - Connected, L - Local, P - Pruned,
 R - RP-bit set, F - Register Flag, T - SPT-bit set, J - Join SPT,
 K - Ack-Pending state
Timers: Uptime/Expires
Interface state: Interface, next-Hop, State/Mode

(*, 225.1.0.0), uptime 01:40:17, expires 00:00:58, RP 10.1.100.6, flags: SCJ
Incoming interface: vlan1251, RPF neighbor 10.192.168.5
Outgoing interface list:
 vlan2001 Forward/Sparse 01:40:17/Never
 vlan2002 Forward/Sparse 01:40:09/Never
 vlan2003 Forward/Sparse 01:40:04/Never
 vlan2004 Forward/Sparse 01:40:04/Never
 vlan2005 Forward/Sparse 01:40:04/Never

(192.168.1.201, 225.1.0.0), uptime 01:27:01, expires 00:00:30, flags: CTP
Incoming interface: vlan2001, RPF neighbor 0.0.0.0
Outgoing interface list:

(192.168.1.202, 225.1.0.0), uptime 01:27:01, expires 00:00:30, flags: CTP
Incoming interface: vlan2001, RPF neighbor 0.0.0.0
Outgoing interface list:

(172.16.1.201, 225.1.0.0), uptime 01:27:01, expires 00:00:31, flags: CT
Incoming interface: vlan1251, RPF neighbor 10.192.168.5
Outgoing interface list:
 vlan2001 Forward/Sparse 01:27:01/Never

```

The show ip pim mcache command displays the multicast route entries.

```

AG4# show ip pim mcache
PIM Multicast Routing Cache Table

(*, 225.1.0.0)
Incoming interface : vlan1251
Outgoing interface list :
 vlan2001

(192.168.1.201, 225.1.0.0)
Incoming interface : vlan2001
Outgoing interface list :

(192.168.1.202, 225.1.0.0)
Incoming interface : vlan2001
Outgoing interface list :

(172.16.1.201, 225.1.0.0)
Incoming interface : vlan1251
Outgoing interface list :
 vlan2001

```

The show ip pim bsr-router command displays information about the BSR.

```

AG4# show ip pim bsr-router

PIMv2 Bootstrap information
 BSR address: 10.1.100.5
 BSR Priority: 199, Hash mask length: 31
 Expires: 00:00:20

```

The show ip pim rp mapping command displays information about all multicast group-to-RP mappings.

```

AG4# show ip pim rp
Group RP

```

```

225.1.0.0 10.1.100.6
```

```
AG4# show ip pim rp mapping
Group(s) : 225.0.0.0/8
RP : 10.1.100.5, v2
 Info source: 10.1.100.5, via bootstrap, priority 100
 expires: 00:01:02
Group(s) : 225.0.0.0/8
RP : 10.1.100.6, v2
 Info source: 10.1.100.5, via bootstrap, priority 100
 expires: 00:00:43
```

The show ip igmp snooping groups command displays the IGMP database.

```
AG4# show ip igmp snooping groups
Total Number of Groups: 1600
```

```
AG4# show ip igmp snooping groups vlan 2001 225.1.0.0 detail
Interface vlan2001
Group 225.1.0.0
Source List
--
 Member Port Mode Uptime
Expires
 port-channel1 Exclude 01:52:34
00:01:26
 port-channel1000 IGMPv2-Compat 01:54:04
00:01:27
 port-channel51 Exclude 01:52:49
00:01:21
 ethernet1/1/32:2 IGMPv2-Compat 01:53:42 00:01:27
```

## TR1

The show ip igmp snooping groups command displays the IGMP database.

```
TR1# show ip igmp snooping groups
Total Number of Groups: 1600
```

```
TR1# show ip igmp snooping groups vlan 2001 225.1.0.0 detail
Interface vlan2001
Group 225.1.0.0
Source List
--
 Member Port Mode Uptime
Expires
 ethernet1/1/31 IGMPv2-Compat 01:56:02
00:01:17
 ethernet1/1/32 IGMPv2-Compat 01:56:02 00:01:21
```

## TR2

The show ip igmp snooping groups command displays the IGMP database.

```
TR2# show ip igmp snooping groups
Total Number of Groups: 1600
```

```
TR2# show ip igmp snooping groups vlan 2001
Total Number of Groups: 20
IGMP Connected Group Membership
Group Address Interface Mode
Expires
225.1.0.0 vlan2001 IGMPv2-Compat
00:01:36
 Member-ports :ethernet1/1/21,ethernet1/1/22
225.1.0.1 vlan2001 IGMPv2-Compat
00:01:36
 Member-ports :ethernet1/1/21,ethernet1/1/22
```



```

225.1.0.2 vlan2001 IGMPv2-Compat
00:01:36
 Member-ports :ethernet1/1/21,ethernet1/1/22
<<Output_truncated>>

```

## VLT multicast routing commands

### show vlt inconsistency ip mcache

Displays information about mismatched IIF routes between the local and peer VLT nodes.

- Syntax** `show vlt inconsistency ip mcache [vrf vrf-name]`
- Parameters** `vrf vrf-name`—(Optional) Enter the keyword then the name of the VRF to display information about mismatched IIF routes corresponding to that non-default VRF.
- Default** None
- Command Mode** EXEC
- Usage Information** None

**Example**

```

OS10# show vlt inconsistency ip mcache

Spanned Multicast routing IIF inconsistency:
Multicast Route Local IIF Peer IIF
(22.22.22.200, 225.1.1.2) Vlan 5 Vlan6
(*, 225.1.1.2) Vlan 15 ethernet 1/1/1

```

**Supported Releases** 10.5.0 or later

### show vlt mismatch

Displays configuration mismatch between VLT peers.

- Syntax** `show vlt {domain-id | all} mismatch`
- Parameters** `domain-id`—Enter a VLT domain ID, from 1 to 255.
- Default** None
- Command Mode** EXEC
- Usage Information** The `show vlt mismatch` command displays multicast configuration mismatches.

**Example**

```

OS10# show vlt all mismatch

Multicast routing mismatches:
Global status:
Parameter VRF Local Peer

V4 Multicast default Enabled Disabled

Vlan status
VlanId Local Peer Local Peer

Vlan 11 Enabled Disabled Disabled Disabled
Vlan 12 Enabled Disabled Disabled Disabled
Vlan 13 Enabled Disabled Disabled Disabled

```

**Supported  
Releases**

10.5.0 or later

# VXLAN

A virtual extensible LAN (VXLAN) extends Layer 2 (L2) server connectivity over an underlying Layer 3 (L3) transport network in a virtualized data center. A virtualized data center consists of virtual machines (VMs) in a multi-tenant environment. OS10 supports VXLAN as described in RFC 7348.

VXLAN provides a L2 overlay mechanism on an existing L3 network by encapsulating the L2 frames in L3 packets. The VXLAN-shared forwarding domain allows hosts such as virtual and physical machines, in tenant L2 segments to communicate over the shared IP network. Each tenant L2 segment is identified by a 24-bit ID called a VXLAN network identifier (VNI).

Deployed as a VXLAN gateway, an OS10 switch performs encapsulation/de-encapsulation of L2 frames in L3 packets while tunneling server traffic. In this role, an OS10 switch operates as a VXLAN tunnel endpoint (VTEP). Using VXLAN tunnels, server VLAN segments communicate through the extended L2 forwarding domain.

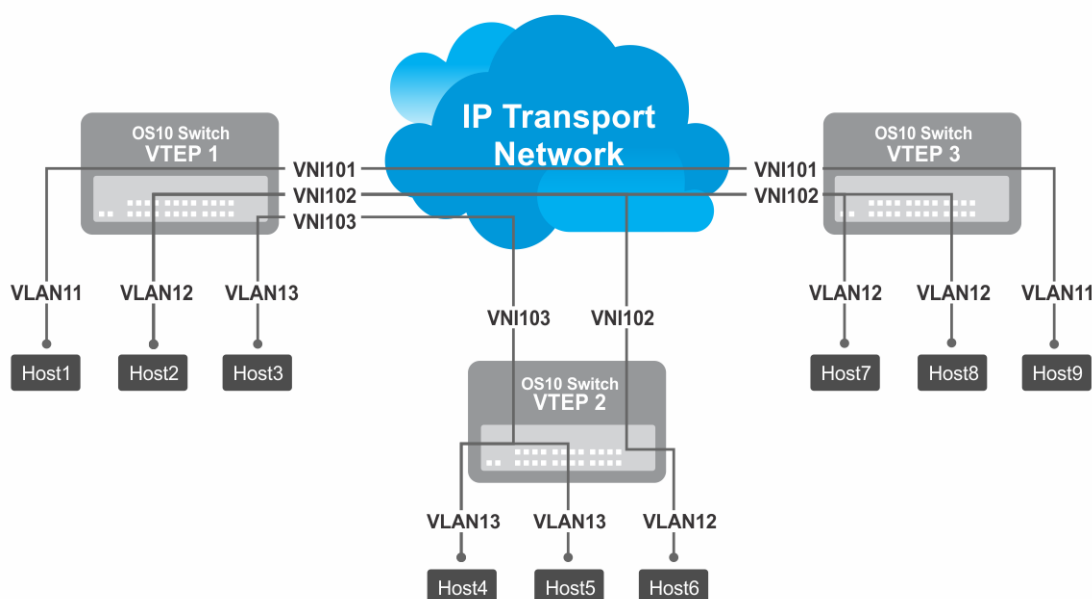

**Figure 11. VXLAN topology**

## **NOTE:**

- The platforms that support only L2 VXLAN gateway include: S4048-ON, Z9100-ON, and Z9264F-ON
- The platforms that support both L2 VXLAN and L3 VXLAN routing (Routing In and Out of Tunnels (RIOT)) include:
  - Asymmetric IRB: S4048T-ON, S4248-ON series, S4100-ON series, S5200-ON series, and S6010-ON
  - Symmetric IRB: S4048T-ON, S4100-ON series, S5200-ON series, and S6010-ON

After VXLAN decapsulation, routing between virtual networks and tenant VLANs is supported only on the following platforms:

- S4200-ON series
- S5200-ON series

On other platforms, routing after decapsulation is performed only between virtual networks. You can connect an egress virtual network to a VLAN in an external router, which connects to an external network.

This feature is not supported on the following platforms:

- S3048-ON

- Z9332F-ON

### Configuration notes

All Dell EMC PowerSwitches except MX-Series, S4200-Series, S5200 Series, and Z9332F-ON:

In a static VXLAN, overlay routing is supported on:

- S4100-ON Series
- S4200-ON Series
- S5200-ON Series
- S4048T-ON
- S6010-ON

## VXLAN concepts

|                                             |                                                                                                                                                                                                                                                                                                                                                                                                                                                                                                                                                                                                                                                                                                         |
|---------------------------------------------|---------------------------------------------------------------------------------------------------------------------------------------------------------------------------------------------------------------------------------------------------------------------------------------------------------------------------------------------------------------------------------------------------------------------------------------------------------------------------------------------------------------------------------------------------------------------------------------------------------------------------------------------------------------------------------------------------------|
| <b>Network virtualization overlay (NVO)</b> | <p>An overlay network extends L2 connectivity between server virtual machines (VMs) in a tenant segment over an underlay L3 IP network. A tenant segment can be a group of hosts or servers that are spread across an underlay network.</p> <ul style="list-style-type: none"> <li>• The NVO overlay network uses a separate L2 bridge domain (virtual network), which is independent of legacy VLAN forwarding.</li> <li>• The NVO underlay network operates in the default VRF using the existing L3 infrastructure and routing protocols.</li> </ul>                                                                                                                                                 |
| <b>Virtual extensible LAN (VXLAN)</b>       | <p>A type of network virtualization overlay that encapsulates a tenant payload into IP UDP packets for transport across the IP underlay network.</p>                                                                                                                                                                                                                                                                                                                                                                                                                                                                                                                                                    |
| <b>VXLAN network identifier (VNI)</b>       | <p>A 24-bit ID number that identifies a tenant segment and transmits in a VXLAN-encapsulated packet.</p>                                                                                                                                                                                                                                                                                                                                                                                                                                                                                                                                                                                                |
| <b>VXLAN tunnel endpoint (VTEP)</b>         | <p>A switch with connected end hosts that are assigned to virtual networks. The virtual networks map to VXLAN segments. Local and remote VTEPs perform encapsulation and de-capsulation of VXLAN headers for the traffic between end hosts. A VTEP is also known as a network virtualization edge (NVE) node.</p>                                                                                                                                                                                                                                                                                                                                                                                       |
| <b>Bridge domain</b>                        | <p>A L2 domain that receives packets from member interfaces and forwards or floods them to other member interfaces based on the destination MAC address of the packet. OS10 supports two types of bridge domains: simple VLAN and virtual network.</p> <ul style="list-style-type: none"> <li>• Simple VLAN: A bridge domain a VLAN ID represents. Traffic on all member ports is assigned with the same VLAN ID.</li> <li>• Virtual network: A bridge domain a virtual network ID (VNID) represents. A virtual network supports overlay encapsulation and maps with either a single VLAN ID in a <i>switch-scoped VLAN</i> or with multiple (Port,VLAN) pairs in a <i>port-scoped VLAN</i>.</li> </ul> |
| <b>Distributed routing</b>                  | <p>All VTEPs in a virtual network perform intersubnet routing and serve as L3 gateways in two possible modes:</p> <ul style="list-style-type: none"> <li>• Asymmetric routing: All VTEPs can perform routing. Routing decisions are made only on ingress VTEPs. Egress VTEPs perform bridging.</li> <li>• Symmetric routing: All VTEPs perform routing. Routing decisions are made on both ingress and egress VTEPs.</li> </ul>                                                                                                                                                                                                                                                                         |
| <b>Virtual network</b>                      | <p>In OS10, each L2 flooding domain in the overlay network is represented as a <i>virtual network</i>.</p>                                                                                                                                                                                                                                                                                                                                                                                                                                                                                                                                                                                              |
| <b>Virtual network identifier (VNID)</b>    | <p>A 16-bit ID number that identifies a virtual network in OS10.</p>                                                                                                                                                                                                                                                                                                                                                                                                                                                                                                                                                                                                                                    |
| <b>Virtual-network interface</b>            | <p>A router interface that connects a virtual network bridge to a tenant VRF routing instance.</p>                                                                                                                                                                                                                                                                                                                                                                                                                                                                                                                                                                                                      |
| <b>Access port</b>                          | <p>A port on a VTEP switch that connects to an end host and is part of the overlay network.</p>                                                                                                                                                                                                                                                                                                                                                                                                                                                                                                                                                                                                         |
| <b>Network port</b>                         | <p>A port on a VTEP switch that connects to the underlay network.</p>                                                                                                                                                                                                                                                                                                                                                                                                                                                                                                                                                                                                                                   |
| <b>Switch-scoped VLAN</b>                   | <p>A VLAN that is mapped to a virtual network ID (VNID) in OS10. All member ports of the VLAN are automatically added to the virtual network.</p> <ul style="list-style-type: none"> <li>• You can map only one VLAN ID to a virtual network.</li> </ul>                                                                                                                                                                                                                                                                                                                                                                                                                                                |

- Ideally suited for existing tenant VLANs that stretch over an IP fabric using VXLAN.

### Port-scoped VLAN

A Port,VLAN pair that maps to a virtual network ID (VNID) in OS10. Assign an individual member interface to a virtual network either with an associated tagged VLAN or as an untagged member. Using a port-scoped VLAN, you can configure:

- The same VLAN ID on different access interfaces to different virtual networks.
- Different VLAN IDs on different access interfaces to the same virtual network.

## VXLAN as NVO solution

Network virtualization overlay (NVO) is a solution that addresses the requirements of a multi-tenant data center, especially one with virtualized hosts. An NVO network is an overlay network that is used to extend L2 connectivity among VMs belonging to a tenant segment over an underlay IP network. Each tenant payload is encapsulated in an IP packet at the originating VTEP. To access the payload, the tenant payload is stripped of the encapsulation at the destination VTEP. Each tenant segment is also known as a *virtual-network* and is uniquely identified in OS10 using a virtual network ID (VNID).

VXLAN is a type of encapsulation used as an NVO solution. VXLAN encapsulates a tenant payload into IP UDP packets for transport across the IP underlay network. In OS10, each virtual network is assigned a 24-bit number that is called a *VXLAN network identifier* (VNI) that the VXLAN-encapsulated packet carries. The VNI uniquely identifies the tenant segment on all VTEPs. OS10 sets up ASIC tables to:

- Enables creation of a L2 bridge flooding domain across a L3 network.
- Facilitates packet forwarding between local ports and tunneling packets from the local device to a remote device.

## Configure VXLAN

To extend a L2 tenant segment using VXLAN, follow these configuration steps on each VTEP switch:

1. Configure the source IP address used in encapsulated VXLAN packets.
2. Configure a virtual network and assign a VXLAN VNI.
3. Configure VLAN-tagged access ports.
4. Configure untagged access ports.
5. (Optional) Enable routing for hosts on different virtual networks.
6. Advertise the local VXLAN source IP address to remote VTEPs.
7. (Optional) Configure VLT.

## Configure source IP address on VTEP

When you configure a switch as a VXLAN tunnel endpoint (VTEP), configure a Loopback interface, whose IP address is used as the source IP address in encapsulated packet headers. Only a Loopback interface assigned to a network virtualization edge (NVE) instance is used as a source VXLAN interface.

- Do not reconfigure the VXLAN source interface or the IP address assigned to the source interface if there is at least one VXLAN network ID (VNI) already assigned to a virtual-network ID (VNID) on the switch.
- The source Loopback IP address must be reachable from a remote VTEP.
- An IPv6 address is not supported as the source VXLAN address.
- Do not assign the source Loopback interface to a non-default VRF instance.
- Underlay reachability of remote tunnel endpoints is supported only in the default VRF.
- Do not assign the IP address that is configured as the source IP address to end hosts in any VRF.

To configure source IP address on VTEP:

1. Configure a Loopback interface to serve as the source VXLAN tunnel endpoint in CONFIGURATION mode. The range is from 0 to 255.

```
interface loopback number
```

2. Configure an IP address on the Loopback interface in INTERFACE mode. The IP address allows the source VTEP to send VXLAN frames over the L3 transport network.

```
ip address ip-address/mask
```

3. Return to CONFIGURATION mode.

```
exit
```

4. Enter NVE mode from CONFIGURATION mode. NVE mode allows you to configure the VXLAN tunnel endpoint on the switch.

```
nve
```

5. Configure the Loopback interface as the source tunnel endpoint for all virtual networks on the switch in NVE mode.

```
source-interface loopback number
```

6. Return to CONFIGURATION mode.

```
exit
```

## Configure a VXLAN virtual network

To create a VXLAN, assign a VXLAN segment ID (VNI) to a virtual network ID (VNID) and configure a remote VTEP. A unique 2-byte VNID identifies a virtual network. You cannot assign the same VXLAN VNI to more than one virtual network. Manually configure VXLAN tunnel endpoints in a static VXLAN or use BGP EVPN to automatically discover the VXLAN tunnel endpoints.

1. Create a virtual-network bridge domain in CONFIGURATION mode. Valid VNID numbers are from 1 to 65535.

```
virtual-network vn-id
```

2. Assign a VXLAN VNI to the virtual network in VIRTUAL-NETWORK mode. The range is from 1 to 16,777,215. Configure the VNI for the same tenant segment on each VTEP switch.

```
vxlan-vni vni
```

3. (Optional) If you use BGP EVPN for VXLAN, this step is not required — To set up a static VXLAN, configure the source IP address of a remote VTEP in VXLAN-VNI mode. You can configure up to 1024 remote VTEP addresses for a VXLAN VNI.

```
remote-vtep ip-address
```

After you configure the remote VTEP, when the IP routing path to the remote VTEP IP address in the underlay IP network is known, the virtual network sends and receives VXLAN-encapsulated traffic from and to downstream servers and hosts. All broadcast, multicast, and unknown unicast (BUM) traffic received on access interfaces replicate and are sent to all configured remote VTEPs. Each packet contains the VXLAN VNI in its header.

By default, MAC learning from a remote VTEP is enabled and unknown unicast packets flood to all remote VTEPs. To configure additional remote VTEPs, re-enter the `remote-vtep ip-address` command.

4. Return to VIRTUAL-NETWORK mode.

```
exit
```

5. Return to CONFIGURATION mode.

```
exit
```

## Configure VLAN-tagged access ports

Configure local access ports in the VXLAN overlay network using either a switch-scoped VLAN or port-scoped VLAN. Only one method is supported. You cannot assign tagged VLAN member interfaces to a virtual network using both switch-scoped and port-scoped VLANs.

- To use a switch-scoped VLAN to add VLAN-tagged member ports to a virtual network:

1. Assign a VLAN to the virtual network in VLAN Interface mode.

```
interface vlan vlan-id
virtual-network vn-id
```

2. Configure port interfaces as trunk members of the VLAN in Interface mode.

```
interface ethernet node/slot/port[:subport]
switchport mode trunk
switchport trunk allowed-vlan vlan-id
exit
```

The local physical ports assigned to the VLAN transmit packets over the virtual network.

- NOTE:** A switch-scoped VLAN assigned to a virtual network cannot have a configured IP address and cannot participate in L3 routing; for example:

```
OS10(config)# interface vlan 102
OS10(conf-if-vlan-102)# ip address 1.1.1.1/24
% Error: vlan102, IP address cannot be configured for VLAN attached to Virtual
Network.
```

- To use a port-scoped VLAN to add VLAN-tagged member ports to a virtual network:

1. Configure interfaces as trunk members in Interface mode.

```
interface ethernet node/slot/port[:subport]
switchport mode trunk
exit
```

2. Assign a trunk member interface as a Port,VLAN ID pair to the virtual network in VIRTUAL-NETWORK mode. All traffic sent and received for the virtual network on the interface carries the VLAN tag. Multiple tenants connected to different switch interfaces can have the same `vlan-tag` VLAN ID.

```
virtual-network vn-id
member-interface ethernet node/slot/port[:subport] vlan-tag vlan-id
```

The Port,VLAN pair starts to transmit packets over the virtual network.

3. Repeat Steps 1 and 2 to assign additional member Port,VLAN pairs to the virtual network.
  - You cannot assign the same Port,VLAN member interface pair to more than one virtual network.
  - You can assign the same `vlan-tag` VLAN ID with different member interfaces to different virtual networks.
  - You can assign a member interface with different `vlan-tag` VLAN IDs to different virtual networks.

The VLAN ID tag is removed from packets transmitted in a VXLAN tunnel. Each packet is encapsulated with the VXLAN VNI in the packet header before it is sent from the egress source interface for the tunnel. At the remote VTEP, the VXLAN VNI is removed and the packet transmits on the virtual-network bridge domain. The VLAN ID regenerates using the VLAN ID associated with the virtual-network egress interface on the VTEP and is included in the packet header.

## Configure untagged access ports

Add untagged access ports to the VXLAN overlay network using either a switch-scoped VLAN or port-scoped VLAN. Only one method is supported.

- To use a switch-scoped VLAN to add untagged member ports to a virtual network:

1. Assign a VLAN to a virtual network in VLAN Interface mode.

```
interface vlan vlan-id
virtual-network vn-id
exit
```

2. Configure port interfaces as access members of the VLAN in Interface mode.

```
interface ethernet node/slot/port[:subport]
switchport access vlan vlan-id
exit
```

Packets received on the untagged ports transmit over the virtual network.

- To use a port-scoped VLAN to add untagged member ports to a virtual network:
  1. Create a reserved VLAN ID to assign untagged traffic on member interfaces to a virtual network in CONFIGURATION mode. The VLAN ID is used internally for all untagged member interfaces on the switch that belong to virtual networks.

```
virtual-network untagged-vlan untagged-vlan-id
```

2. Configure port interfaces as trunk members and remove the access VLAN in Interface mode.

```
interface ethernet node/slot/port[:subport]
switchport mode trunk
no switchport access vlan
exit
```

3. Assign the trunk interfaces as untagged members of the virtual network in VIRTUAL-NETWORK mode. You cannot use the reserved VLAN ID for a legacy VLAN or for tagged traffic on member interfaces of virtual networks.

```
virtual-network vn-id
member-interface ethernet node/slot/port[:subport] untagged
exit
```

If at least one untagged member interface is assigned to a virtual network, you cannot delete the reserved untagged VLAN ID. If you reconfigure the reserved untagged VLAN ID, you must either reconfigure all untagged member interfaces in the virtual networks to use the new ID or reload the switch.

## Enable overlay routing between virtual networks

The previous sections describe how a VTEP switches traffic between hosts in the same L2 tenant segment on a virtual network, and transports traffic over an IP underlay fabric. This section describes how a VTEP enables hosts *in different* L2 segments belonging to the same tenant VRF to communicate with each other.

**NOTE:** On the S4248-ON switch, IPv6 overlay routing between virtual networks is not supported with static VXLAN. IPv6 overlay routing is, however, supported with BGP EVPN asymmetric IRB.

Each tenant is assigned a VRF and each virtual-network interface is assigned an IP subnet in the tenant VRF. The VTEP acts as the L3 gateway that routes traffic from one tenant subnet to another in the overlay before encapsulating it in the VXLAN header and transporting it over the IP underlay fabric.

To enable host traffic routing between virtual networks, configure an interface for each virtual network and associate it to a tenant VRF. Assign a unique IP address in the IP subnet range associated with the virtual network to each virtual-network interface on each VTEP.

To enable efficient traffic forwarding on a VTEP, OS10 supports distributed and centralized gateway routing. A distributed gateway means that multiple VTEPs act as the gateway router for a tenant subnet. The VTEP nearest to a host acts as its gateway router. To support seamless migration of hosts and virtual machines on different VTEPs, configure a common virtual IP address, known as an anycast IP address, on all VTEPs for each virtual network. Use this anycast IP address as the gateway IP address on VMs.

To support multiple tenants when each tenant has its own L2 segments, configure a different IP VRF for each tenant. All tenants share the same VXLAN underlay IP fabric in the default VRF.

1. Create a non-default VRF instance for overlay routing in Configuration mode. For multi-tenancy, create a VRF instance for each tenant.

```
ip vrf tenant-vrf-name
exit
```

2. Configure the anycast gateway MAC address all VTEPs use in all VXLAN virtual networks in Configuration mode.

When a VM sends an Address Resolution Protocol (ARP) request for the anycast gateway IP address in a VXLAN virtual network, the nearest VTEP responds with the configured anycast MAC address. Configure the same MAC address on all VTEPs so that the anycast gateway MAC address remains the same if a VM migrates to a different VTEP. Because the configured MAC address is automatically used for all VXLAN virtual networks, configure it in global Configuration mode.

```
ip virtual-router mac-address mac-address
```

3. Configure a virtual-network interface, assign it to the tenant VRF, and configure an IP address.



The interface IP address must be unique on each VTEP, including VTEPs in VLT pairs. You can configure an IPv6 address on the virtual-network interface. Different virtual-network interfaces you configure on the same VTEP must have virtual-network IP addresses in different subnets. If you do not assign the virtual-network interface to a tenant VRF, it is assigned to the default VRF.

```
interface virtual-network vn-id
ip vrf forwarding tenant-vrf-name
ip address ip-address/mask
no shutdown
exit
```

4. Configure an anycast gateway IPv4 or IPv6 address for each virtual network in INTERFACE-VIRTUAL-NETWORK mode. This anycast IP address must be in the same subnet as the IP address of the virtual-network interface in Step 3.

Configure the same IPv4 or IPv6 address as the anycast IP address on all VTEPs in a virtual network. All hosts use the anycast gateway IP address as the default gateway IP address in the subnet that connects to the virtual-network interface configured in Step 3. Configure the anycast gateway IP address on all downstream VMs. Using the same anycast gateway IP address allows host VMs to move from one VTEP to another VTEP in a VXLAN. Dell EMC recommends using an anycast gateway in both VLT and non-VLT VXLAN configurations.

```
interface virtual-network vn-id
ip virtual-router address ip-address
```

#### Configuration notes for virtual-network routing:

- VXLAN overlay routing includes routing tenant traffic on the ingress VTEP and bridging the traffic on the egress VTEP. The ingress VTEP learns ARP entries and associates all destination IP addresses of tenant VMs with the corresponding VM MAC addresses in the overlay. On the ingress VTEP, configure a virtual network for each destination IP subnet even if there are no locally attached hosts for an IP subnet.
- Routing protocols, such as Open Shortest Path First (OSPF) and BGP, are not supported on the virtual-network interface in the overlay network. However, static routes that point to a virtual-network interface or to a next-hop IP address that belongs to a virtual-network subnet are supported.
- When you add a static route in the overlay, any next-hop IP address that belongs to a virtual-network subnet must be the only next-hop for that route and cannot be one of multiple ECMP next-hops. For example, if you enter the following configuration commands one after the other, where 10.250.0.0/16 is a virtual-network subnet, only the first next-hop is active on the switch.

```
OS10(config)# ip route 0.0.0.0/0 10.250.0.101
OS10(config)# ip route 0.0.0.0/0 10.250.0.102
```

If the next-hop is a pair of dual-homed VTEPs in a VLT domain, a workaround is to configure the same anycast gateway IP address on both VTEPs and use this address as the next-hop IP address.

- VLT peer routing is not supported in a virtual network. A packet destined to the virtual-network peer MAC address L2 switches instead of IP routes. To achieve active-active peer routing in a virtual network, configure the same virtual anycast gateway IP and MAC addresses on both VTEP VLT peers and use the anycast IP as the default gateway on the VMs.
- Virtual Router Redundancy Protocol (VRRP) is not supported on a virtual-network interface. Configure the virtual anycast gateway IP address to share a single gateway IP address on both VTEP VLT peers and use the anycast IP as default gateway on the VMs.
- Internet Group Management Protocol (IGMP) and Protocol-Independent Multicast (PIM) are not supported on a virtual-network interface.
- IP routing of incoming VXLAN encapsulated traffic in the overlay after VXLAN termination is not supported.

The following tables show how to use anycast gateway IP and MAC addresses in a data center with three virtual networks and multiple VTEPs:

- Globally configure an anycast MAC address for all VTEPs in all virtual networks. For example, if you use three VTEP switches in three virtual networks:

**Table 41. MAC address for all VTEPs**

| Virtual network | VTEP   | Anycast gateway MAC address |
|-----------------|--------|-----------------------------|
| VNID 11         | VTEP 1 | 00.11.22.33.44.55           |
|                 | VTEP 2 | 00.11.22.33.44.55           |
|                 | VTEP 3 | 00.11.22.33.44.55           |

**Table 41. MAC address for all VTEPs (continued)**

| Virtual network | VTEP   | Anycast gateway MAC address |
|-----------------|--------|-----------------------------|
| VNID 12         | VTEP 1 | 00.11.22.33.44.55           |
|                 | VTEP 2 | 00.11.22.33.44.55           |
|                 | VTEP 3 | 00.11.22.33.44.55           |
| VNID 13         | VTEP 1 | 00.11.22.33.44.55           |
|                 | VTEP 2 | 00.11.22.33.44.55           |
|                 | VTEP 3 | 00.11.22.33.44.55           |

- Configure a unique IP address on the virtual-network interface on each VTEP across all virtual networks. Configure the same anycast gateway IP address on all VTEPs in a virtual-network subnet. For example:

**Table 42. IP address on the virtual-network interface on each VTEP**

| Virtual network | VTEP   | Virtual-network IP address | Anycast gateway IP address |
|-----------------|--------|----------------------------|----------------------------|
| VNID 11         | VTEP 1 | 10.10.1.201                | 10.10.1.254                |
|                 | VTEP 2 | 10.10.1.202                | 10.10.1.254                |
|                 | VTEP 3 | 10.10.1.203                | 10.10.1.254                |
| VNID 12         | VTEP 1 | 10.20.1.201                | 10.20.1.254                |
|                 | VTEP 2 | 10.20.1.202                | 10.20.1.254                |
|                 | VTEP 3 | 10.20.1.203                | 10.20.1.254                |
| VNID 13         | VTEP 1 | 10.30.1.201                | 10.30.1.254                |
|                 | VTEP 2 | 10.30.1.202                | 10.30.1.254                |
|                 | VTEP 3 | 10.30.1.203                | 10.30.1.254                |

## Advertise VXLAN source IP address

1. Advertise the IP address of the local source tunnel interface to all VTEPs in the underlay IP network using the existing routing infrastructure. This example uses OSPF to advertise the VXLAN source IP address on Ethernet1/1/3, which is the underlay network-facing interface:

```
OS10(config)# router ospf 100
OS10(config-ospf)# router-id 110.111.170.195
OS10(config-ospf)# exit
OS10(config)# interface ethernet1/1/3
OS10(config-if-eth1/1/3)# ip ospf 100 area 0.0.0.0
OS10(config-if-eth1/1/3)# exit
OS10(config)# interface loopback 1
OS10(config-if-lo-1)# ip ospf 100 area 0.0.0.0
```

Each VTEP switch in the underlay IP network learns the IP address of the VXLAN source interface. If a remote VTEP switch is not reachable, its status displays as DOWN in the `show nve remote-vtep` output.

2. Configure the MTU value on L3 underlay network-facing interfaces in Interface mode to be at least 50 bytes higher than the MTU on the server-facing links to allow for VXLAN encapsulation. The range is from 1312 to 9216.

```
mtu value
```

3. Return to CONFIGURATION mode.

```
exit
```

## Configure VLT

(Optional) To use VXLAN in a VLT domain, configure the VLT domain — including the VLT Interconnect (VLTi) interfaces, backup heartbeat, and VLT MAC address — as described in the *OS10 Enterprise Edition User Guide* in the *Virtual link trunking* section.

Required VLT VXLAN configuration:

- The IP address of the VTEP source Loopback interface must be same on the VLT peers.
- If you use a port-scoped VLAN to assign tagged access interfaces to a virtual network, to identify traffic belonging to each virtual network, you must configure a unique VLAN ID for the VLT Interconnect (VLTi) link.
- Configure a VLAN to transmit VXLAN traffic over the VLTi link in VIRTUAL-NETWORK mode. All traffic sent and received from a virtual network on the VLTi carries the VLTi VLAN ID tag.

Configure the same VLTi VLAN ID on both VLT peers. You cannot use the ID of an existing VLAN on a VLT peer or the reserved untagged VLAN ID. You can use the VLTi VLAN ID to assign tagged or untagged access interfaces to a virtual network.

```
virtual-network vn-id
vlti-vlan vlan-id
```

- Although a VXLAN virtual network has no access port members that connect to downstream servers, you must configure a switch-scoped VLAN or VLTi VLAN. The presence of this VLAN ensures that the VLTi link is added as a member of the virtual network so that mis-hashed ARP packets received from the VXLAN tunnel reach the intended VLT node.

Best practices:

- If a VLT peer loses connectivity to the underlay L3 network, it continues to transmit routing traffic to the network through the VLTi link on a dedicated L3 VLAN to the other VLT peer. Configure a L3 VLAN between VLT peers in the underlay network and enable routing on the VLAN; for example:

```
OS10(config)# interface vlan4000
OS10(config-if-vl-4000)# no shutdown
OS10(config-if-vl-4000)# ip address 41.1.1.1/24
OS10(config-if-vl-4000)# ip ospf 1 area 0.0.0.0
```

- To reduce traffic loss when a VLT peer boots up and joins an existing VLT domain, or when the VLTi links fails and the VLT peer is still up as detected by the VLT heartbeat, create an uplink state group. Configure all access VLT port channels on the peer as upstream links. Configure all network-facing links as downstream link. For example:

```
OS10(config)# uplink-state-group 1
OS10(conf-uplink-state-group-1)# enable
OS10(conf-uplink-state-group-1)# downstream ethernet1/1/1-1/1/2
OS10(conf-uplink-state-group-1)# upstream port-channel 10
```

### Configuration notes

All Dell EMC PowerSwitches except MX-Series, S4200-Series, S5200 Series, and Z9332F-ON:

To check mismatch of MAC address table entries between VLT peers, use the `show vlt mac-inconsistency` command. To identify mismatches in VLT configuration on peer switches, use the `show vlt domain-name mismatch` command.

```
OS10# show vlt-mac-inconsistency
Checking Vlan 228 .. Found 7 inconsistencies .. Progress 100%
VLAN 128

MAC 00:00:00:00:00:02 is missing from Node(s) 2
VLAN 1

MAC 00:a0:c9:00:00:18 is missing from Node(s) 2
MAC 00:a0:c9:00:00:20 is missing from Node(s) 2
VLAN 131

MAC 00:00:00:00:00:02 is missing from Node(s) 2
VLAN 132

MAC 00:00:00:00:00:02 is missing from Node(s) 2
VLAN 135

MAC 00:00:00:00:00:02 is missing from Node(s) 2
```

VLAN 137

-----  
MAC 00:00:00:00:00:02 is missing from Node(s) 2  
Run "show vlt dl mismatch ..." commands to identify configuration issues

## L3 VXLAN route scaling

The S4100-ON series, S5200-ON series, S4048T-ON, S4248-ON series, and S6010-ON switches support native VxLAN routing — routing in and out of tunnels (RIOT). RIOT requires dedicated hardware resources reserved for overlay routing. You cannot use these dedicated resources for underlay routing.

Each overlay ARP entry requires a routing next-hop in the hardware to bind a destination tenant VM IP address to the corresponding tenant VM MAC address and VNI. Each virtual-network interface assigned to an IP subnet requires a routing interface in the hardware.

OS10 supports preset profiles to re-allocate the number of resources reserved for overlay ARP entries. The number of entries reserved for each preset mode differs according to OS10 switch.

**Table 43. Routing next-hops reserved on OS10 switches**

| OS10 Switch              | Overlay next-hop entries | Underlay next-hop entries | Overlay L3 RIF entries | Underlay L3 RIF entries |
|--------------------------|--------------------------|---------------------------|------------------------|-------------------------|
| S41xx-ON series:         | —                        | —                         | —                      | —                       |
| default-overlay-routing  | 4096                     | 28672                     | 2048                   | 10240                   |
| disable-overlay-routing  | 0                        | 32768                     | 0                      | 12288                   |
| balanced-overlay-routing | 16384                    | 16384                     | 6144                   | 6144                    |
| scaled-overlay-routing   | 24576                    | 8192                      | 10240                  | 2048                    |
| S4048T-ON and S6010-ON:  | —                        | —                         | —                      | —                       |
| default-overlay-routing  | 8192                     | 4096                      | 2048                   | 2048                    |
| disable-overlay-routing  | 0                        | 49152                     | 49152                  | 0                       |
| balanced-overlay-routing | 24576                    | 24576                     | 24576                  | 6144                    |
| scaled-overlay-routing   | 40960                    | 8192                      | 8192                   | 10240                   |
| S52xx-ON series:         | —                        | —                         | —                      | —                       |
| default-overlay-routing  | 8192                     | 57344                     | 2048                   | 14336                   |
| disable-overlay-routing  | 0                        | 65536                     | 0                      | 16384                   |
| balanced-overlay-routing | 32768                    | 32768                     | 8192                   | 8192                    |
| scaled-overlay-routing   | 53248                    | 12288                     | 12288                  | 4096                    |
| S4248-ON:                | —                        | —                         | —                      | —                       |
| default-overlay-routing  | 20480                    | 110592                    | 4096                   | 28672                   |

 **NOTE:** The S4248-ON switch supports only one default profile to reserve resources for overlay ARP entries.

To activate the profile after you configure an overlay routing profile, save the configuration and reload the switch.

### Configure an overlay routing profile

- Enable an overlay routing profile in Configuration mode or disable the configured profile and return to the default.

```
OS10(config)# hardware overlay-routing-profile {disable-overlay-routing | balanced-
overlay-routing |
scaled-overlay-routing}
```

### Display overlay routing profiles

- View the hardware resources available for overlay routing in different profiles; for example, in the S5200-ON series:

```
OS10# show hardware overlay-routing-profile mode all
Mode Underlay L3 RIF Overlay Next-hop Underlay Next-hop Overlay L3 RIF
Entries Entries Entries Entries
default-overlay-routing 8192 57344 2048 14336
disable-overlay-routing 0 65536 0 16384
balanced-overlay-routing 32768 32768 8192 8192
scaled-overlay-routing 53248 12288 12288 4096
```

- View the currently configured overlay routing profile; for example, in the S5200-ON series:

```
show hardware overlay-routing-profile mode
Setting Mode Overlay Next-hop Underlay Next-hop Overlay L3 RIF Underlay L3 RIF
Entries Entries Entries Entries
Current default-overlay-routing 8192 57344 2048 14336
Next-boot default-overlay-routing 8192 57344 2048 14336
```

## DHCP relay on VTEPs

Dynamic Host Configuration Protocol (DHCP) clients on hosts in the overlay communicate with a DHCP server using a DHCP relay on the VTEP switch. To work seamlessly, VTEP DHCP relay transmits the virtual-network IP address of the relay interface to the DHCP server.

By default, DHCP uses the `giaddr` packet field to carry these addresses to the server. In a VxLAN, which has overlay and underlay subnets in the same default VRF, DHCP relay on VTEPs operates without user intervention. However, in a VxLAN in which the underlay and overlay are in different VRFs, the default DHCP method is not successful. The IP tenant subnet is in the overlay address space. The IP address where the VTEP is reachable is in the underlay address space. To transmit the IP subnet of the client separately from the IP address where the VTEP is reachable, you must configure an additional DHCP sub-option (5 or 151) in DHCP relay agent option 82.

Because OS10 does not support the required sub-options in DHCP relay agent option 82, the `giaddr` packet field must contain the virtual-network IP address of the relay interface, and this IP address must be reachable from the DHCP server in the underlay. Each VTEP that acts as a DHCP relay must have its virtual-network IP address installed using a route leaking mechanism as a route to the underlay and advertised to all underlay routers, including the spine switches.

Similarly, the DHCP server in the underlay VRF must be reachable from the client tenant VRF in the overlay. Configure a static route for the DHCP server subnet in the underlay default VRF, and leak the static route to the client tenant VRF in the overlay. This configuration sets up a bi-directional communication between the client and DHCP server across the virtual networks. The route-leaking configuration is not required if the VxLAN overlay subnet and underlay subnet are in same default VRF.

### Configure DHCP relay on VTEPs

- Configure the IP address of the virtual-network relay interface in the non-default tenant VRF as a static route in the default VRF.

```
OS10(config)# ip route 10.10.0.2/32 interface virtual-network 10
```

- Configure a static IP route to the DHCP server interface in the tenant VRF.

```
OS10(config)# ip route vrf tenant01 40.1.1.0/24 interface vlan40
```

- Configure DHCP relay on the virtual-network interface of the tenant VRF.

```
OS10(config)# interface virtual-network 10
OS10(conf-if-vn-10)# ip helper-address 40.1.1.1 vrf tenant01
```

## View VXLAN configuration

Use `show` commands to verify the VXLAN configuration and monitor VXLAN operation.

## View the VXLAN virtual network

```
OS10# show virtual-network
Codes: DP - MAC-learn Dataplane, CP - MAC-learn Controlplane, UUD - Unknown-Unicast-Drop
Un-tagged VLAN: 888
Virtual Network: 60000
 VLTi-VLAN: 2500
Members:
 VLAN 1000: port-channell1, ethernet1/1/9, ethernet1/1/10
 VLAN 2500: port-channell1000
VxLAN Virtual Network Identifier: 16775000
Source Interface: loopback100(222.222.222.222)
Remote-VTEPs (flood-list): 55.55.55.55 (DP),77.1.1.1 (DP)
```

## View the VXLAN virtual-network port

```
OS10# show virtual-network interface ethernet 1/1/1
Interface Vlan Virtual-network
ethernet1/1/1 100 1000
ethernet1/1/1 200 2000
ethernet1/1/1 300 3000
```

## View the VXLAN virtual-network VLAN

```
OS10# show virtual-network vlan 100
Vlan Virtual-network Interface
100 1000 ethernet1/1/1,ethernet1/1/2
100 5000 ethernet1/1/2
```

## View the VXLAN virtual-network VLANs

```
OS10# show vlan
Codes: * - Default VLAN, M - Management VLAN, R - Remote Port Mirroring VLANs,
@ - Attached to Virtual Network
Q: A - Access (Untagged), T - Tagged

 NUM Status Description Q Ports
* 1 up A Eth1/1/1-1/1/48
@ 100 up T Eth1/1/2,Eth1/1/3
 A Eth1/1/1
@ 101 up T port-channel5
 200 up T Eth1/1/11-1/1/15
```

## View the VXLAN virtual-network statistics

```
OS10# show virtual-network counters
Virtual-Network Input (Packets/Bytes) Output (Packets/Bytes)
1000 857/8570 257/23709
2000 457/3570 277/13709
```

```
OS10# show virtual-network counters interface 1/1/3 vlan 100
Virtual-Network Input (Packets/Bytes) Output (Packets/Bytes)
1000 857/8570 257/23709
2000 457/3570 277/13709
```

**NOTE:** Using flex counters, OS10 may display additional packets in the Output field number, but the additional packets do not transmit. For an accurate count, use the Output Bytes number.

## View the VXLAN remote VTEPs

```
OS10# show nve remote-vtep summary
Remote-VTEP State

2.2.2.2 up
```

```
OS10# show nve remote-vtep
Codes: DP - MAC-learn Dataplane, CP - MAC-learn Controlplane, UUD - Unknown-Unicast-Drop
```

```
IP Address: 2.2.2.2, State: up, Encap: VxLAN
VNI list: 10000 (DP), 200 (DP), 300 (DP)
```

### View the VXLAN statistics on the remote VTEPs

```
OS10# show nve remote-vtep counters
Remote-VTEP Input (Packets/Bytes) Output (Packets/Bytes)

10.10.10.10 857/8570 257/23709
20.20.20.20 457/3570 277/13709
```

### View the VXLAN virtual network by VNID

```
OS10# show nve vxlan-vni
VNI Virtual-Network Source-IP Remote-VTEPs

101 101 44.44.44.44 11.11.11.11,22.22.22.22,33.33.33.33
102 102 44.44.44.44 11.11.11.11,22.22.22.22,33.33.33.33
103 103 44.44.44.44 11.11.11.11,22.22.22.22,33.33.33.33
104 104 44.44.44.44 11.11.11.11,22.22.22.22,33.33.33.33
```

### View VXLAN routing between virtual networks

The `show ip arp vrf` and `show ipv6 neighbors vrf` command output displays information about IPv4 and IPv6 neighbors learned in a non-default VRF on the switch. The `show ip route vrf` command displays the IPv4 and IPv6 routes learned.

```
OS10# show ip arp vrf tenant1
Address Hardware address Interface Egress Interface

111.0.0.2 00:c5:15:02:12:f1 virtual-network20 ethernet1/1/5
111.0.0.3 00:c5:15:02:12:a2 virtual-network20 port-channel5
111.0.0.4 00:12:98:1f:34:11 virtual-network20 VXLAN(20.0.0.1)
121.0.0.3 00:12:28:1f:34:15 virtual-network20 port-channel5
121.0.0.4 00:f2:34:ac:34:09 virtual-network20 VXLAN(20.0.0.1)
```

```
OS10# show ipv6 neighbors vrf tenant1
IPv6 Address Hardware Address State Interface Egress Interface

200::2 00:12:28:1f:34:15 STALE virtual-network40 port-channel5
200::f 00:f2:34:ac:34:09 REACH virtual-network40 VXLAN(20.0.0.1)
```

```
OS10# show ip route vrf vrf_1
Codes: C - connected
 S - static
 B - BGP, IN - internal BGP, EX - external BGP
 O - OSPF, IA - OSPF inter area, N1 - OSPF NSSA external type 1,
 N2 - OSPF NSSA external type 2, E1 - OSPF external type 1,
 E2 - OSPF external type 2, * - candidate default,
 + - summary route, > - non-active route
Gateway of last resort is not set

Destination Gateway Dist/Metric Last Change

C 100.1.0.0/16 via 100.1.1.4 virtual-network60000 0/0 00:36:24
C 100.33.0.0/16 via 100.33.1.4 virtual-network60032 0/0 00:36:23
C 100.65.0.0/16 via 100.65.1.4 virtual-network60064 0/0 00:36:22
C 100.97.0.0/16 via 100.97.1.4 virtual-network60096 0/0 00:36:21
```

```
OS10# show ipv6 route vrf vrf_1
Codes: C - connected
 S - static
 B - BGP, IN - internal BGP, EX - external BGP
 O - OSPF, IA - OSPF inter area, N1 - OSPF NSSA external type 1,
 N2 - OSPF NSSA external type 2, E1 - OSPF external type 1,
 E2 - OSPF external type 2, * - candidate default,
 + - summary route, > - non-active route
Gateway of last resort is not set

Destination Gateway Dist/Metric Last Change

C 1000:100:10:1::/64 via 1000:100:10:1::4 virtual-network60000 0/0 00:37:08
C 1000:100:10:21::/64 via 1000:100:10:21::4 virtual-network60032 0/0 00:37:07
```

```
C 1000:100:10:41::/64 via 1000:100:10:41::4 virtual-network60064 0/0 00:37:06
C 1000:100:10:61::/64 via 1000:100:10:61::4 virtual-network60096 0/0 00:37:05
```

## VXLAN MAC addresses

Use the `show mac address-table virtual-network` or `show mac address-table extended` commands to display the MAC addresses learned on a VXLAN virtual network or learned on both VXLAN virtual networks and legacy VLANs.

Use the `clear mac address-table dynamic virtual-network` and `clear mac address-table dynamic nve remote-vtep` commands to delete address entries from the MAC address virtual-network table.

**NOTE:** The existing `show mac address-table` and `clear mac-address table` commands do not display and clear MAC addresses in a virtual-network bridge domain even when access ports in a switch-scoped VLAN are assigned to a VXLAN virtual network.

### Display VXLAN MAC addresses

**Table 44. Display VXLAN MAC addresses**

| Command                                                                                                                                                                                   | Description                                                                                                                                                                                                                                                                                                                                                                                                                                                                                                                                                                                                                                                                                                                                                   |
|-------------------------------------------------------------------------------------------------------------------------------------------------------------------------------------------|---------------------------------------------------------------------------------------------------------------------------------------------------------------------------------------------------------------------------------------------------------------------------------------------------------------------------------------------------------------------------------------------------------------------------------------------------------------------------------------------------------------------------------------------------------------------------------------------------------------------------------------------------------------------------------------------------------------------------------------------------------------|
| <code>show mac address-table virtual-network [vn-id   local   remote   static   dynamic   address mac-address   interface {ethernet node/slot/port:subport   port-channel number}]</code> | <p>Displays all MAC addresses learned on all or a specified virtual network.</p> <p><i>vn-id</i>: Displays only information about the specified virtual network.</p> <p><i>local</i>: Displays only locally-learned MAC addresses.</p> <p><i>remote</i>: Displays only remote MAC addresses.</p> <p><i>static</i>: Displays only static MAC addresses.</p> <p><i>dynamic</i>: Displays only dynamic MAC addresses.</p> <p><i>address mac-address</i>: Displays only information about the specified MAC address.</p> <p><i>interface ethernet node/slot/port:subport</i>: Displays only MAC addresses learned on the specified interface.</p> <p><i>interface port-channel number</i>: Displays only MAC addresses learned on the specified port channel.</p> |
| <code>show mac address-table extended [address mac-address   interface {ethernet node/slot/port:subport   port-channel number}   static   dynamic]</code>                                 | <p>Displays MAC addresses learned on all VLANs and VXLANs (default).</p> <p><i>address mac-address</i>: Displays only information about the specified MAC address.</p> <p><i>interface ethernet node/slot/port:subport</i>: Displays only MAC addresses learned on the specified interface.</p> <p><i>interface port-channel number</i>: Displays only MAC addresses learned on the specified port channel.</p> <p><i>static</i>: Displays only static MAC addresses.</p> <p><i>dynamic</i>: Displays only dynamic MAC addresses.</p>                                                                                                                                                                                                                         |
| <code>show mac address-table nve {vxlan-vni vn-id   remote-vtep ip-address}</code>                                                                                                        | <p><i>vxlan-vni vn-id</i>: Displays MAC addresses learned on NVE from the specified VXLAN virtual-network ID.</p> <p><i>remote-vtep ip-address</i>: Displays MAC addresses learned on NVE from the specified remote VTEP.</p>                                                                                                                                                                                                                                                                                                                                                                                                                                                                                                                                 |
| <code>show mac address-table count virtual-network [dynamic   local   remote   static   interface</code>                                                                                  | Displays the number of MAC addresses learned on all virtual networks (default).                                                                                                                                                                                                                                                                                                                                                                                                                                                                                                                                                                                                                                                                               |



**Table 44. Display VXLAN MAC addresses (continued)**

| Command                                                                                                              | Description                                                                                                                                                                                                                                                                                                                                                                                                                                                                                                                                                                                                                                                                                                                                                                                    |
|----------------------------------------------------------------------------------------------------------------------|------------------------------------------------------------------------------------------------------------------------------------------------------------------------------------------------------------------------------------------------------------------------------------------------------------------------------------------------------------------------------------------------------------------------------------------------------------------------------------------------------------------------------------------------------------------------------------------------------------------------------------------------------------------------------------------------------------------------------------------------------------------------------------------------|
| <code>{ethernet node/slot/port:subport   port-channel number}   vn-id]</code>                                        | <p><b>dynamic:</b> Displays the number of dynamic MAC addresses learned on all or a specified virtual network.</p> <p><b>local:</b> Displays the number of locally-learned MAC addresses.</p> <p><b>remote:</b> Displays the number of remote MAC addresses learned on all or a specified virtual network.</p> <p><b>static:</b> Displays the number of static MAC addresses learned on all or a specified virtual network.</p> <p><b>interface ethernet node/slot/port:subport:</b> Displays the number of MAC addresses learned on the specified interface.</p> <p><b>interface port-channel number:</b> Displays the number of MAC addresses learned on the specified port channel.</p> <p><b>vn-id:</b> Displays the number of MAC addresses learned on the specified virtual network.</p> |
| <code>show mac address-table count nve {remote-vtep ip-address   vxlan-vni vn-id}</code>                             | <p>Displays the number of MAC addresses learned for a virtual network or from a remote VTEP.</p> <p><b>remote-vtep ip-address:</b> Displays the number of MAC addresses learned on the specified remote VTEP.</p> <p><b>vxlan-vni vn-id:</b> Displays the number of MAC addresses learned on the specified VXLAN virtual network.</p>                                                                                                                                                                                                                                                                                                                                                                                                                                                          |
| <code>show mac address-table count extended [interface ethernet node/slot/port:subport   port-channel number]</code> | <p>Displays the number of MAC addresses learned on all VLANs and VXLAN virtual networks.</p> <p><b>interface ethernet node/slot/port:subport:</b> Displays the number of MAC addresses learned from VLANs and VXLANs on the specified interface.</p> <p><b>port-channel number:</b> Displays the number of MAC addresses learned from VLANs and VXLANs on the specified port channel.</p>                                                                                                                                                                                                                                                                                                                                                                                                      |

**Clear VXLAN MAC addresses**

**Table 45. Clear VXLAN MAC addresses**

| Command                                                                                                                                                                        | Description                                                                                                                                                                                                                                                                                                                                                                                                                                                                                                                                                                             |
|--------------------------------------------------------------------------------------------------------------------------------------------------------------------------------|-----------------------------------------------------------------------------------------------------------------------------------------------------------------------------------------------------------------------------------------------------------------------------------------------------------------------------------------------------------------------------------------------------------------------------------------------------------------------------------------------------------------------------------------------------------------------------------------|
| <code>clear mac address-table dynamic virtual-network [interface {ethernet node/slot/port:subport   port-channel number}   local   vn-id [address mac-address   local]]</code> | <p>Clears all MAC addresses learned on all VXLAN virtual networks.</p> <p><b>interface ethernet node/slot/port:subport:</b> Clears only MAC addresses learned on the specified interface.</p> <p><b>interface port-channel number:</b> Clears only MAC addresses learned on the specified port channel.</p> <p><b>local:</b> Clears only locally-learned MAC addresses.</p> <p><b>vn-id:</b> Clears only the MAC addresses learned on the specified virtual network.</p> <p><b>vn-id address mac-address:</b> Clears only the MAC address learned on the specified virtual network.</p> |

**Table 45. Clear VXLAN MAC addresses (continued)**

| Command                                                                 | Description                                                      |
|-------------------------------------------------------------------------|------------------------------------------------------------------|
| <code>clear mac address-table dynamic nve remote-vtep ip-address</code> | Clears all MAC addresses learned from the specified remote VTEP. |

## VXLAN commands

### hardware overlay-routing-profile

Configures the number of reserved ARP table entries for VXLAN overlay routing.

|                           |                                                                                                                                                                                                                                                                                                                                                                                                                                                                                                                                                                                                                                                                                                                    |
|---------------------------|--------------------------------------------------------------------------------------------------------------------------------------------------------------------------------------------------------------------------------------------------------------------------------------------------------------------------------------------------------------------------------------------------------------------------------------------------------------------------------------------------------------------------------------------------------------------------------------------------------------------------------------------------------------------------------------------------------------------|
| <b>Syntax</b>             | <code>hardware overlay-routing-profile {balanced-overlay-routing   scaled-overlay-routing   disable-overlay-routing}</code>                                                                                                                                                                                                                                                                                                                                                                                                                                                                                                                                                                                        |
| <b>Parameters</b>         | <p><b>balanced-overlay-routing</b> Reserve routing entries for balanced VXLAN tenant routing:</p> <ul style="list-style-type: none"> <li>• S4048T-ON and S6010-ON: 24576 entries</li> <li>• S4100-ON series: 16384 entries</li> <li>• S5200-ON series switches: 32768 entries</li> </ul> <p><b>scaled-overlay-routing</b> Reserve routing entries for scaled VXLAN tenant routing:</p> <ul style="list-style-type: none"> <li>• S4048T-ON and S6010-ON: 36864 entries</li> <li>• S4100-ON series: 24576 entries</li> <li>• S5200-ON series switches: 53248 entries</li> </ul> <p><b>disable-overlay-routing</b> Allocate 0 next-hop entries for overlay routing and all next-hop entries for underlay routing.</p> |
| <b>Default</b>            | <p>S4048T-ON and S6010-ON switches reserve 8192 ARP table entries.</p> <p>S4100-ON series switches reserve 4096 ARP table entries.</p> <p>S5200-ON series switches reserve 8192 ARP table entries.</p>                                                                                                                                                                                                                                                                                                                                                                                                                                                                                                             |
| <b>Command mode</b>       | CONFIGURATION                                                                                                                                                                                                                                                                                                                                                                                                                                                                                                                                                                                                                                                                                                      |
| <b>Usage information</b>  | The number of reserved table entries in a profile varies according to the OS10 switch. To view the available overlay routing profiles for a switch, use the <code>show hardware overlay-routing-profile mode all</code> command. After you configure a profile, reload the switch to activate the profile. The <code>no</code> form of the command disables the configured profile and restores the default number of reserved ARP table entries.                                                                                                                                                                                                                                                                  |
| <b>Example</b>            | <pre>OS10(config)# hardware overlay-routing-profile balanced-overlay-routing OS10(config)# exit OS10# write memory OS10# reload</pre>                                                                                                                                                                                                                                                                                                                                                                                                                                                                                                                                                                              |
| <b>Supported releases</b> | 10.4.3.0 or later                                                                                                                                                                                                                                                                                                                                                                                                                                                                                                                                                                                                                                                                                                  |

### interface virtual-network

Configures a virtual-network router interface.

|                   |                                                                           |
|-------------------|---------------------------------------------------------------------------|
| <b>Syntax</b>     | <code>interface virtual-network vn-id</code>                              |
| <b>Parameters</b> | <b>virtual-network vn-id</b> Enter a virtual-network ID, from 1 to 65535. |

|                           |                                                                                                                                                                                                                                                             |
|---------------------------|-------------------------------------------------------------------------------------------------------------------------------------------------------------------------------------------------------------------------------------------------------------|
| <b>Default</b>            | Not configured                                                                                                                                                                                                                                              |
| <b>Command mode</b>       | CONFIGURATION                                                                                                                                                                                                                                               |
| <b>Usage information</b>  | Configure a virtual-network router interface to enable hosts connected to a virtual network to route traffic to hosts on another virtual network in the same VRF. The virtual-network IP address must be unique on each VTEP, including VTEPs in VLT pairs. |
| <b>Example</b>            | <pre>OS10(config)# interface virtual-network 10000 OS10(config-if-vn-10000)# ip vrf forwarding tenant1 OS10(config-if-vn-10000)# ip address 10.1.0.1/16 OS10(config-if-vn-10000)# no shutdown</pre>                                                         |
| <b>Supported releases</b> | 10.4.3.0 or later                                                                                                                                                                                                                                           |

## ip virtual-router address

Configures an anycast gateway IP address for a VXLAN virtual network.

|                           |                                                                                                                                                                                                                                                                                                                                            |
|---------------------------|--------------------------------------------------------------------------------------------------------------------------------------------------------------------------------------------------------------------------------------------------------------------------------------------------------------------------------------------|
| <b>Syntax</b>             | <code>ip virtual-router address <i>ip-address</i></code>                                                                                                                                                                                                                                                                                   |
| <b>Parameters</b>         | <b>address <i>ip-address</i></b> Enter the IP address of the anycast L3 gateway.                                                                                                                                                                                                                                                           |
| <b>Default</b>            | Not configured                                                                                                                                                                                                                                                                                                                             |
| <b>Command mode</b>       | INTERFACE-VIRTUAL-NETWORK                                                                                                                                                                                                                                                                                                                  |
| <b>Usage information</b>  | Configure the same anycast gateway IP address on all VTEPs in a VXLAN virtual network. Use the anycast gateway IP address as the default gateway IP address if the host VMs move from one VTEP to another in a VXLAN. The anycast gateway IP address must be in the same subnet as the IP address of the virtual-network router interface. |
| <b>Example</b>            | <pre>OS10(config)# interface virtual-network 10000 OS10(config-if-vn-10000)# ip virtual-router address 10.1.0.100</pre>                                                                                                                                                                                                                    |
| <b>Supported releases</b> | 10.4.3.0 or later                                                                                                                                                                                                                                                                                                                          |

## ip virtual-router mac-address

Configures the MAC address of an anycast L3 gateway for VXLAN routing.

|                           |                                                                                                                                                                                                                                                                                |
|---------------------------|--------------------------------------------------------------------------------------------------------------------------------------------------------------------------------------------------------------------------------------------------------------------------------|
| <b>Syntax</b>             | <code>ip virtual-router mac-address <i>mac-address</i></code>                                                                                                                                                                                                                  |
| <b>Parameters</b>         | <b>mac-address <i>mac-address</i></b> Enter the MAC address of the anycast L3 gateway.                                                                                                                                                                                         |
| <b>Default</b>            | Not configured                                                                                                                                                                                                                                                                 |
| <b>Command mode</b>       | CONFIGURATION                                                                                                                                                                                                                                                                  |
| <b>Usage information</b>  | Configure the same MAC address on all VTEPs so that the anycast gateway MAC address remains the same if a VM migrates to a different VTEP. Because the configured MAC address is automatically used for all VXLAN virtual networks, configure it in global Configuration mode. |
| <b>Example</b>            | <pre>OS10(config)# ip virtual-router mac-address 00:01:01:01:01:01</pre>                                                                                                                                                                                                       |
| <b>Supported releases</b> | 10.4.3.0 or later                                                                                                                                                                                                                                                              |

## member-interface

Assigns untagged or tagged VLAN traffic on a member interface to a virtual network.

**Syntax** `member-interface {ethernet node/slot/port[:subport] | port-channel number} {vlan-tag vlan-id | untagged}`

**Parameters**

- ethernet *node/slot/port[:subport]*** Assign the specified interface to a virtual network.
- port-channel *number*** Assign the specified port channel to a virtual network.
- untagged** Assign untagged traffic on an interface or port channel to a virtual network.
- vlan-tag *vlan-id*** Assign tagged traffic on the specified VLAN to a virtual network.

**Default** Not configured

**Command mode** VIRTUAL-NETWORK

**Usage information** Use this command to assign traffic on the same VLAN or interface to different virtual networks. The no version of this command removes the configured value.

**Example**

```
OS10(config)# virtual-network 10000
OS10(config-vn)# member-interface port-channel 10 vlan-tag 200
OS10(config-vn)# member-interface port-channel 20 untagged
```

**Supported releases** 10.4.2.0 or later

## nve

Enters network virtualization edge (NVE) configuration mode to configure the source VXLAN tunnel endpoint.

**Syntax** `nve`

**Parameters** None

**Default** None

**Command mode** CONFIGURATION

**Usage information** In NVE mode, configure the source tunnel endpoint for all virtual networks on the switch.

**Example**

```
OS10# nve
OS10(config-nve)#
```

**Supported releases** 10.4.2.0 or later

## remote-vtep

Configures the IP address of a remote tunnel endpoint in a VXLAN network.

**Syntax** `remote-vtep ip-address`

**Parameters** *ip-address* — Enter the IP address of a remote virtual tunnel endpoint (VTEP).

**Default** Not configured

**Command mode** VIRTUAL-NETWORK VXLAN-VNI

**Usage information** After you configure the remote VTEP, the VXLAN virtual network is enabled to start sending server traffic. You can configure multiple remote VTEPs. All broadcast, multicast, and unknown unicast (BUM) traffic received on an access interface is replicated on remote VTEPs. The `no` version of this command removes the configured value.

**Example**

```
OS10(config-vn-vxlan-vni)# remote-vtep 20.20.20.1
OS10(config-vn-vxlan-vni-remote-vtep)# exit
OS10(config-vn-vxlan-vni)# remote-vtep 30.20.20.1
```

**Supported releases** 10.4.2.0 or later

## show hardware overlay-routing-profile mode

Displays the number of hardware resources available for overlay routing in different profiles.

**Syntax** `show hardware overlay-routing-profile mode [all]`

**Parameters** **all** View the number of tenant entries available in each hardware partition for overlay routing profiles.

**Default** Not configured

**Command mode** EXEC

**Usage information** On S4100-ON series, S5200-ON series, S4048T-ON, S4248-ON, and S6010-ON switches, L3 VXLAN overlay routing requires reserved hardware resources. The number of reserved table entries in a profile varies according to the OS10 switch.

**Example (S5200-ON series)**

```
OS10# show hardware overlay-routing-profile mode all
Mode
default-overlay-routing Overlay Underlay
 Next-hop Next-hop
 Entries Entries
 8192 57344
disable-overlay-routing 0 65536
balanced-overlay-routing 32768 32768
scaled-overlay-routing 53248 12288
```

```
show hardware overlay-routing-profile mode
Setting Mode
Current default-overlay-routing
14336
Next-boot default-overlay-routing
8192 57344
2048 14336
```

**Supported releases** 10.4.3.0 or later

## show interface virtual-network

Displays the configuration of virtual-network router interfaces and packet statistics.

**Syntax** `show interface virtual-network [vn-id]`

**Parameters** **vn-id** Enter a virtual-network ID, from 1 to 65535.

**Default** Not configured

**Command mode** EXEC

**Usage information**

Use this command to display the virtual-network IP address used for routing traffic in a virtual network. Traffic counters also display.

**Example**

```
show interface virtual-network 102
Virtual-network 102 is up, line protocol is up
Address is 14:18:77:25:6f:84, Current address is 14:18:77:25:6f:84
Interface index is 66
Internet address is 12.12.12.2/24
Mode of IPv4 Address Assignment: MANUAL
Interface IPv6 oper status: Enabled
Link local IPv6 address: fe80::1618:77ff:fe25:6eb9/64
MTU 1532 bytes, IP MTU 1500 bytes
ARP type: ARPA, ARP Timeout: 60
Last clearing of "show interface" counters: 10:24:21
Queuing strategy: fifo
Input statistics:
 89 packets, 10056 octets
Output statistics:
 207 packets, 7376 octets
Time since last interface status change: 10:23:21
```

**Supported releases**

10.4.3.0 or later

## show nve remote-vtep

Displays information about remote VXLAN tunnel endpoints.

**Syntax**

```
show nve remote-vtep [ip-address | summary | counters]
```

**Parameters**

|                          |                                                             |
|--------------------------|-------------------------------------------------------------|
| <b><i>ip-address</i></b> | Display detailed information about a specified remote VTEP. |
| <b>summary</b>           | Display summary information about remote VTEPs.             |
| <b>counters</b>          | Display statistics on remote VTEP traffic.                  |

**Default**

Not configured

**Command mode**

EXEC

**Usage information**

Use this command to display the IP address, operational state, and configured VXLANs for each remote VTEP. The remote MAC learning and unknown unicast drop settings used for each VXLAN ID (VNI) also display.

**Example**

```
OS10# show nve remote-vtep summary
Remote-VTEP State

2.2.2.2 up
```

```
OS10# show nve remote-vtep
Codes: DP - MAC-learn Dataplane, CP - MAC-learn Controlplane, UUD -
Unknown-Unicast-Drop
IP Address: 2.2.2.2, State: up, Encap: VxLAN
VNI list: 10000 (DP), 200 (DP), 300 (DP)
```

**Supported releases**

10.4.2.0 or later

## show nve remote-vtep counters

Displays VXLAN packet statistics for a remote VTEP.

**Syntax**

```
show nve remote-vtep [ip-address] counters
```

|                           |                                                                                                                                                                                                                                                |
|---------------------------|------------------------------------------------------------------------------------------------------------------------------------------------------------------------------------------------------------------------------------------------|
| <b>Parameters</b>         | <ul style="list-style-type: none"> <li><i>ip-address</i> — Enter IP address of a remote VTEP.</li> </ul>                                                                                                                                       |
| <b>Default</b>            | Not configured                                                                                                                                                                                                                                 |
| <b>Command mode</b>       | EXEC                                                                                                                                                                                                                                           |
| <b>Usage information</b>  | Use this command to display input and output statistics for VXLAN traffic on a remote VTEP. A VTEP is identified by its IP address. Use the <code>clear nve remote-vtep [ip-address] counters</code> command to clear VXLAN packet statistics. |
| <b>Example</b>            | <pre>OS10# show nve remote-vtep counters Peer           Input (Packets/Bytes)   Output (Packets/Bytes) 10.10.10.10    857/8570                257/23709 20.20.20.20    457/3570                277/13709</pre>                                 |
| <b>Supported releases</b> | 10.4.2.0 or later                                                                                                                                                                                                                              |

## show nve vxlan-vni

Displays information about the VXLAN virtual networks on the switch.

|                           |                                                                                                                                                                                                                                                               |
|---------------------------|---------------------------------------------------------------------------------------------------------------------------------------------------------------------------------------------------------------------------------------------------------------|
| <b>Syntax</b>             | <code>show nve vxlan-vni</code>                                                                                                                                                                                                                               |
| <b>Parameters</b>         | None                                                                                                                                                                                                                                                          |
| <b>Default</b>            | Not configured                                                                                                                                                                                                                                                |
| <b>Command mode</b>       | EXEC                                                                                                                                                                                                                                                          |
| <b>Usage information</b>  | Use this command to display information about configured VXLAN virtual networks. Each VXLAN virtual network is identified by its virtual-network ID.                                                                                                          |
| <b>Example</b>            | <pre>OS10# show nve vxlan-vni VNI           Virtual-Network   Source-IP   Remote-VTEPs ----- 10000         1                 1.1.1.1     2.2.2.2 200           2                 1.1.1.1     2.2.2.2 300           300              1.1.1.1     2.2.2.2</pre> |
| <b>Supported releases</b> | 10.4.2.0 or later                                                                                                                                                                                                                                             |

## show virtual-network

Displays a virtual-network configuration, including all VXLAN configurations.

|                          |                                                                                                                                                                                           |
|--------------------------|-------------------------------------------------------------------------------------------------------------------------------------------------------------------------------------------|
| <b>Syntax</b>            | <code>show virtual-network [vn-id]</code>                                                                                                                                                 |
| <b>Parameters</b>        | <b><i>vn-id</i></b> Enter a virtual-network ID, from 1 to 65535.                                                                                                                          |
| <b>Default</b>           | Not configured                                                                                                                                                                            |
| <b>Command mode</b>      | EXEC                                                                                                                                                                                      |
| <b>Usage information</b> | Use this command to display the VNID, port members, source interface, and remote tunnel endpoints of a VXLAN virtual network.                                                             |
| <b>Example</b>           | <pre>OS10# show virtual-network Codes: DP - MAC-learn Dataplane, CP - MAC-learn Controlplane, UUD - Unknown-Unicast-Drop Un-tagged VLAN: 888 Virtual Network: 60000 VLTi-VLAN: 2500</pre> |

```

Members:
 VLAN 1000: port-channel1, ethernet1/1/9, ethernet1/1/10
 VLAN 2500: port-channel1000
VxLAN Virtual Network Identifier: 16775000
Source Interface: loopback100 (222.222.222.222)
Remote-VTEPs (flood-list): 55.55.55.55 (DP), 77.1.1.1 (DP)

```

**Supported releases** 10.4.2.0 or later

## show virtual-network counters

Displays packet statistics for virtual networks.

**Syntax** `show virtual-network [vn-id] counters`

**Parameters** `vn-id` Enter a virtual-network ID, from 1 to 65535.

**Default** Not configured

**Command mode** EXEC

**Usage information** Use this command to monitor the packet throughput on virtual networks, including VXLANs. Use the `clear virtual-network counters` command to clear virtual-network counters.

### Example

```

OS10# show virtual-network counters
Virtual-Network Input (Packets/Bytes) Output (Packets/Bytes)
1000 857/8570 257/23709
2000 457/3570 277/13709

```

**Supported releases** 10.4.2.0 or later

## show virtual-network interface counters

Displays packet statistics for a member port, port channel, or VLAN in VXLAN virtual networks.

**Syntax** `show virtual-network interface {ethernet node/slot/port:subport | port-channel number} [vlan vlan-id] counters`

**Parameters** `interface ethernet node/slot/port[:subport]` Enter the port information for an Ethernet interface.

`interface port-channel number` Enter a port-channel number, from 1 to 128.

`vlan vlan-id` (Optional) Enter a VLAN ID, from 1 to 4093.

**Default** Not configured

**Command mode** EXEC

**Usage information** Use this command to monitor the packet throughput on a port interface that is a member of a VXLAN virtual network. Assign a VLAN member interface to only one virtual network. To clear VXLAN packet counters on a member port or VLAN members of a virtual network, use the `clear virtual-network interface {ethernet node/slot/port:subport | port-channel number} [vlan vlan-id] counters` command.



## Example

```
OS10# show virtual-network interface 1/1/3 vlan 100 counters
Virtual-Network Input (Packets/Bytes) Output (Packets/Bytes)
2000 457/3570 277/13709
```

**Supported releases** 10.4.2.0 or later

## show virtual-network interface

Displays the VXLAN virtual networks and server VLANs where a port is assigned.

**Syntax** `show virtual-network interface {ethernet node/slot/port:subport | port-channel number}`

**Parameters**

**interface** Enter the port information for an Ethernet interface.  
**ethernet**  
**node/slot/**  
**port[:subport**  
**]**

**interface** Enter a port-channel number, from 1 to 128.  
**port-channel**  
**number**

**Default** Not configured

**Command mode** EXEC

**Usage information** Use this command to verify the VXLAN VLANs where an Ethernet port connected to downstream servers is a member.

## Example

```
OS10# show virtual-network interface ethernet 1/1/1
Interface Vlan Virtual-network
ethernet1/1/1 100 1000
ethernet1/1/1 200 2000
ethernet1/1/1 300 3000
```

**Supported releases** 10.4.2.0 or later

## show virtual-network vlan

Displays the VXLAN virtual networks where a VLAN is assigned.

**Syntax** `show virtual-network vlan vlan-id`

**Parameters** **vlan *vlan-id*** Enter a VLAN ID, from 1 to 4093.

**Default** Not configured

**Command mode** EXEC

**Usage information** Use this command to verify the VXLAN virtual networks where a VLAN is assigned, including the port members connected to downstream servers.

## Example

```
OS10# show show virtual-network 100
Vlan Virtual-network Interface
100 1000 ethernet1/1/1,ethernet1/1/2
```

**Supported releases** 10.4.2.0 or later

## show vlan (virtual network)

Displays the VLANs assigned to virtual networks.

|                          |                                                                                                          |
|--------------------------|----------------------------------------------------------------------------------------------------------|
| <b>Syntax</b>            | <code>show vlan</code>                                                                                   |
| <b>Parameters</b>        | None                                                                                                     |
| <b>Default</b>           | Not configured                                                                                           |
| <b>Command mode</b>      | EXEC                                                                                                     |
| <b>Usage information</b> | Use this command to display the VLAN port interfaces that transmit VXLAN packets over a virtual network. |

### Example

```
OS10# show vlan
Codes: * - Default VLAN, M - Management VLAN, R - Remote Port Mirroring
VLANs,
@ - Attached to Virtual Network
Q: A - Access (Untagged), T - Tagged

 NUM Status Description Q Ports
* 1 up Eth1/1/1-1/1/48 A Eth1/1/1-1/1/48
@ 100 up Eth1/1/2,Eth1/1/3 T Eth1/1/2,Eth1/1/3
 up Eth1/1/1 A Eth1/1/1
@ 101 up port-channel5 T port-channel5
 up Eth1/1/11-1/1/15 T Eth1/1/11-1/1/15
```

**Supported releases** 10.4.2.0 or later

## source-interface loopback

Configures a dedicated Loopback interface as the source VTEP.

|                          |                                                                                                                                                                                                                                                                                                                                                                                                                                                                                                                                                                                                                                                                      |
|--------------------------|----------------------------------------------------------------------------------------------------------------------------------------------------------------------------------------------------------------------------------------------------------------------------------------------------------------------------------------------------------------------------------------------------------------------------------------------------------------------------------------------------------------------------------------------------------------------------------------------------------------------------------------------------------------------|
| <b>Syntax</b>            | <code>source-interface loopback <i>number</i></code>                                                                                                                                                                                                                                                                                                                                                                                                                                                                                                                                                                                                                 |
| <b>Parameters</b>        | <b>loopback <i>number</i></b> Enter the Loopback interface used as the source interface of a VXLAN virtual tunnel, from 0 to 16383.                                                                                                                                                                                                                                                                                                                                                                                                                                                                                                                                  |
| <b>Default</b>           | Not configured                                                                                                                                                                                                                                                                                                                                                                                                                                                                                                                                                                                                                                                       |
| <b>Command mode</b>      | NVE-INSTANCE                                                                                                                                                                                                                                                                                                                                                                                                                                                                                                                                                                                                                                                         |
| <b>Usage information</b> | <p>The IP address of the Loopback interface serves as the source IP address in encapsulated packets transmitted from the switch as an NVE VTEP.</p> <ul style="list-style-type: none"><li>• The Loopback interface must have an IP address configured. The Loopback IP address must be reachable from the remote VTEP.</li><li>• You cannot change the source interface if at least one VXLAN virtual network ID (VNID) is configured for the NVE instance.</li></ul> <p>Use this command in NVE mode to override a previously configured value and reconfigure the source IP address. The <code>no</code> version of this command removes the configured value.</p> |

### Examples

```
OS10(config-nve)# source-interface loopback 1
```

**Supported releases** 10.4.2.0 or later

## virtual-network

Creates a virtual network for VXLAN tunneling.

|                           |                                                                                                                                                                                                                          |
|---------------------------|--------------------------------------------------------------------------------------------------------------------------------------------------------------------------------------------------------------------------|
| <b>Syntax</b>             | <code>virtual-network <i>vn-id</i></code>                                                                                                                                                                                |
| <b>Parameters</b>         | <b><i>vn-id</i></b> Enter the virtual-network ID, from 1 to 65535.                                                                                                                                                       |
| <b>Default</b>            | Not configured                                                                                                                                                                                                           |
| <b>Command mode</b>       | CONFIGURATION                                                                                                                                                                                                            |
| <b>Usage information</b>  | The virtual network operates as a L2 bridging domain. To add a VXLAN to the virtual network, use the <code>vxlan-vni</code> command. The <code>no</code> version of this command removes the configured virtual network. |
| <b>Example</b>            | <pre>OS10(config)# virtual-network 1000 OS10(config-vn)#</pre>                                                                                                                                                           |
| <b>Supported releases</b> | 10.4.2.0 or later                                                                                                                                                                                                        |

## virtual-network untagged-vlan

Configures a dedicated VLAN for internal use to transmit untagged traffic on member ports in virtual networks on the switch.

|                           |                                                                                                                                                                                                                                                                                                                             |
|---------------------------|-----------------------------------------------------------------------------------------------------------------------------------------------------------------------------------------------------------------------------------------------------------------------------------------------------------------------------|
| <b>Syntax</b>             | <code>virtual-network untagged-vlan <i>vlan-id</i></code>                                                                                                                                                                                                                                                                   |
| <b>Parameters</b>         | <b><i>id</i></b> Enter the reserved untagged VLAN ID, from 1 to 4093.                                                                                                                                                                                                                                                       |
| <b>Default</b>            | Not configured                                                                                                                                                                                                                                                                                                              |
| <b>Command mode</b>       | CONFIGURATION                                                                                                                                                                                                                                                                                                               |
| <b>Usage information</b>  | The untagged VLAN ID is used internally for all untagged member interfaces that belong to virtual networks. You cannot use the reserved untagged VLAN ID for a simple VLAN bridge or for tagged traffic on member interfaces of virtual networks. The <code>no</code> version of this command removes the configured value. |
| <b>Example</b>            | <pre>OS10(config)# virtual-network untagged-vlan 10</pre>                                                                                                                                                                                                                                                                   |
| <b>Supported releases</b> | 10.4.2.0 or later                                                                                                                                                                                                                                                                                                           |

## vxlan-vni

Assigns a VXLAN ID to a virtual network.

|                           |                                                                                                                                          |
|---------------------------|------------------------------------------------------------------------------------------------------------------------------------------|
| <b>Syntax</b>             | <code>vxlan-vni <i>vni</i></code>                                                                                                        |
| <b>Parameters</b>         | <b><i>vni</i></b> Enter the VXLAN ID for a virtual network, from 1 to 16,777,215.                                                        |
| <b>Default</b>            | Not configured                                                                                                                           |
| <b>Command mode</b>       | VIRTUAL-NETWORK                                                                                                                          |
| <b>Usage information</b>  | This command associates a VXLAN ID number with a virtual network. The <code>no</code> version of this command removes the configured ID. |
| <b>Example</b>            | <pre>OS10(conf-vn-100)# vxlan-vni 100 OS10(config-vn-vxlan-vni)#</pre>                                                                   |
| <b>Supported releases</b> | 10.4.2.0 or later                                                                                                                        |

# VXLAN MAC commands

## clear mac address-table dynamic nve remote-vtep

Clears all MAC addresses learned from a remote VTEP.

|                           |                                                                                                                                                                                                              |
|---------------------------|--------------------------------------------------------------------------------------------------------------------------------------------------------------------------------------------------------------|
| <b>Syntax</b>             | <code>clear mac address-table dynamic nve remote-vtep ip-address</code>                                                                                                                                      |
| <b>Parameters</b>         | <b>remote-vtep</b> Clear MAC addresses learned from the specified remote VTEP.<br><b>ip-address</b>                                                                                                          |
| <b>Default</b>            | Not configured                                                                                                                                                                                               |
| <b>Command mode</b>       | EXEC                                                                                                                                                                                                         |
| <b>Usage information</b>  | To display the MAC addresses learned from a remote VTEP, use the <code>show mac address-table nve remote-vtep</code> command. Use this command to delete all MAC address entries learned from a remote VTEP. |
| <b>Example</b>            | <pre>OS10# clear mac address-table dynamic nve remote-vtep 32.1.1.1</pre>                                                                                                                                    |
| <b>Supported releases</b> | 10.4.2.0 or later                                                                                                                                                                                            |

## clear mac address-table dynamic virtual-network

Clears MAC addresses learned on all or a specified VXLAN virtual network.

|                          |                                                                                                                                                                                                                                                                                                                                                                                                                                                                                                                                                                                                                                                                                                                                                                                                                                                                               |
|--------------------------|-------------------------------------------------------------------------------------------------------------------------------------------------------------------------------------------------------------------------------------------------------------------------------------------------------------------------------------------------------------------------------------------------------------------------------------------------------------------------------------------------------------------------------------------------------------------------------------------------------------------------------------------------------------------------------------------------------------------------------------------------------------------------------------------------------------------------------------------------------------------------------|
| <b>Syntax</b>            | <code>clear mac address-table dynamic virtual-network [interface {ethernet node/slot/port:subport   port-channel number}   local   vn-id [address mac-address   local]]</code>                                                                                                                                                                                                                                                                                                                                                                                                                                                                                                                                                                                                                                                                                                |
| <b>Parameters</b>        | <b>interface</b> Clear all MAC addresses learned on the specified interface.<br><b>ethernet</b><br><b>node/slot/</b><br><b>port[:subport</b><br><b>]</b><br><b>interface</b> Clear all MAC addresses learned on the specified port channel.<br><b>port-channel</b><br><b>number</b><br><b>virtual-</b><br><b>network vn-id</b> Clear all MAC addresses learned on the specified virtual network, from 1 to 65535.<br><b>local</b> Clear only locally-learned MAC addresses.<br><b>vn-id</b> Clear learned MAC addresses on the specified virtual network, from 1 to 65535.<br><b>vn-id local</b> Clear locally learned MAC addresses on the specified virtual network, from 1 to 65535.<br><b>vn-id address</b> Clear only the MAC address entry learned in the specified virtual network. Enter the MAC address in <code>EEEE.EEEE.EEEE</code> format.<br><b>mac-address</b> |
| <b>Default</b>           | Not configured                                                                                                                                                                                                                                                                                                                                                                                                                                                                                                                                                                                                                                                                                                                                                                                                                                                                |
| <b>Command mode</b>      | EXEC                                                                                                                                                                                                                                                                                                                                                                                                                                                                                                                                                                                                                                                                                                                                                                                                                                                                          |
| <b>Usage information</b> | Use this command with no optional parameters to delete all dynamic MAC address entries that are learned only on virtual-network bridges from the MAC address table. This command does not delete MAC address entries learned on simple VLAN bridges. Use the <code>show mac address-table virtual-network</code> command to display the MAC addresses learned on a virtual network.                                                                                                                                                                                                                                                                                                                                                                                                                                                                                           |

## Example

```
OS10# clear mac address-table dynamic virtual-network
```

## Supported releases

10.4.2.0 or later

# show mac address-table count extended

Displays the number of MAC addresses learned on all VLANs and VXLAN virtual networks.

## Syntax

```
show mac address-table count extended [interface {ethernet node/slot/
port:subport | port-channel number}]
```

## Parameters

|                              |                                                                                                    |
|------------------------------|----------------------------------------------------------------------------------------------------|
| <b>interface</b>             | Display the number of MAC addresses learned on all VLANs and VXLANs on the specified interface.    |
| <b>ethernet</b>              |                                                                                                    |
| <b><i>node/slot/</i></b>     |                                                                                                    |
| <b><i>port[:subport]</i></b> |                                                                                                    |
| <b><i>J</i></b>              |                                                                                                    |
| <b>interface</b>             | Display the number of MAC addresses learned on all VLANs and VXLANs on the specified port channel. |
| <b>port-channel</b>          |                                                                                                    |
| <b><i>number</i></b>         |                                                                                                    |

## Default

Not configured

## Command mode

EXEC

## Usage information

Use this command to display the number of MAC address entries learned on all VLANs and VXLAN virtual networks.

## Example

```
OS10# show mac address-table count extended
MAC Entries for all vlans :
Dynamic Address Count : 10
Static Address (User-defined) Count : 2
Total MAC Addresses in Use: 12
```

## Supported releases

10.4.2.0 or later

# show mac address-table count nve

Displays the number of MAC addresses learned on a VXLAN virtual network or from a remote VXLAN tunnel endpoint.

## Syntax

```
show mac address-table count nve {vxlan-vni vni | remote-vtep ip-address}
```

## Parameters

|                    |                          |                                                                                             |
|--------------------|--------------------------|---------------------------------------------------------------------------------------------|
| <b>vxlan-vni</b>   | <b><i>vni</i></b>        | Display MAC addresses learned on the specified VXLAN virtual network, from 1 to 16,777,215. |
| <b>remote-vtep</b> | <b><i>ip-address</i></b> | Display MAC addresses learned from the specified remote VTEP.                               |

## Default

Not configured

## Command mode

EXEC

## Usage information

Use the `clear mac address-table dynamic nve remote-vtep` command to delete all MAC address entries learned from a remote VTEP. Use the `clear mac address-table dynamic virtual-network vn-id` command to delete all dynamic MAC address entries learned on a virtual-network bridge.

## Example

```
OS10# show mac address-table count nve vxlan-vni 1001
MAC Entries for all vlans :
Dynamic Address Count : 1
```

```

Static Address (User-defined) Count : 0
Total MAC Addresses in Use: 1

OS10# show mac address-table count nve remote-vtep 32.1.1.1
MAC Entries for all vlans :
Dynamic Address Count : 2
Static Address (User-defined) Count : 0
Total MAC Addresses in Use: 2

```

**Supported releases** 10.4.2.0 or later

## show mac address-table count virtual-network

Displays the number of MAC addresses learned on virtual networks.

**Syntax** `show mac address-table count virtual-network [dynamic | local | remote | static | interface {ethernet node/slot/port:subport | port-channel number} | vn-id]`

**Parameters**

|                                                                                                |                                                                                                |
|------------------------------------------------------------------------------------------------|------------------------------------------------------------------------------------------------|
| <b>dynamic</b>                                                                                 | Display the number of local dynamically-learned MAC addresses.                                 |
| <b>local</b>                                                                                   | Display the number of local MAC addresses.                                                     |
| <b>remote</b>                                                                                  | Display the number of MAC addresses learned from remote VTEPs.                                 |
| <b>static</b>                                                                                  | Display the number of local statically-configured MAC addresses.                               |
| <b>interface</b>                                                                               | Display the number of MAC addresses learned on the specified interface.                        |
| <b>ethernet</b><br><b><i>node/slot/</i></b><br><b><i>port[:subport]</i></b><br><b><i>]</i></b> |                                                                                                |
| <b>interface</b><br><b>port-channel</b><br><b><i>number</i></b>                                | Display the number of MAC addresses learned on the specified port channel.                     |
| <b><i>vn-id</i></b>                                                                            | Display the number of MAC addresses learned on the specified virtual network, from 1 to 65535. |

**Default** Not configured

**Command mode** EXEC

**Usage information** Use this command to display the number of MAC address entries learned on virtual networks in the MAC address table.

**Example**

```

OS10# show mac address-table count virtual-network
MAC Entries for all vlans :
Dynamic Address Count : 8
Static Address (User-defined) Count : 0
Total MAC Addresses in Use: 8

```

**Supported releases** 10.4.2.0 or later

## show mac address-table extended

Displays MAC addresses learned on all VLANs and VXLANs.

**Syntax** `show mac address-table extended [address mac-address | interface {ethernet node/slot/port:subport | port-channel number} | static | dynamic]`

|                   |                                                    |                                                                   |
|-------------------|----------------------------------------------------|-------------------------------------------------------------------|
| <b>Parameters</b> | <b>address mac-address</b>                         | Display only information about the specified MAC address.         |
|                   | <b>interface ethernet node/slot/port[:subport]</b> | Display only MAC addresses learned on the specified interface.    |
|                   | <b>interface port-channel number</b>               | Display only MAC addresses learned on the specified port channel. |
|                   | <b>static</b>                                      | Display only static MAC addresses.                                |
|                   | <b>dynamic</b>                                     | Display only dynamic MAC addresses.                               |

**Default** Not configured

**Command mode** EXEC

**Usage information** By default, MAC learning from a remote VTEP is enabled. Use this command to verify the MAC addresses learned both on VXLAN virtual networks and VLANs on the switch. The `show mac address-table` command displays the MAC addresses learned only on LAN port and VLAN interfaces.

**Example**

```
OS10# show mac address-table extended
Virtual-Network VlanId MAC Address Type Interface/Remote-VTEP

- 500 00:00:00:00:11:11 dynamic ethernet1/1/31:1
- 500 00:00:00:00:44:44 dynamic port-channel1000
- 1 aa:bb:cc:dd:f0:03 static port-channel1000
- 500 aa:bb:cc:dd:f0:03 static port-channel1000
- 4000 aa:bb:cc:dd:f0:03 static port-channel1000
10000 10000 00:00:00:00:00:11 dynamic ethernet1/1/31:1
10000 10000 00:00:00:00:00:44 dynamic port-channel1000
10000 10000 00:00:00:00:00:55 dynamic port-channel10
10000 10000 00:00:00:00:00:77 dynamic VxLAN(32.1.1.1)
20000 300 00:00:00:00:00:22 dynamic port-channel100
20000 300 00:00:00:00:00:33 dynamic port-channel1000
20000 300 00:00:00:00:00:66 dynamic port-channel10
20000 20000 00:00:00:00:00:88 dynamic VxLAN(32.1.1.1)
```

**Supported releases** 10.4.2.0 or later

## show mac address-table nve

Displays MAC addresses learned on a VXLAN virtual network or from a remote VXLAN tunnel endpoint.

**Syntax** `show mac address-table nve {vxlan-vni vni | remote-vtep ip-address}`

|                   |                               |                                                                                             |
|-------------------|-------------------------------|---------------------------------------------------------------------------------------------|
| <b>Parameters</b> | <b>vxlan-vni vni</b>          | Display MAC addresses learned on the specified VXLAN virtual network, from 1 to 16,777,215. |
|                   | <b>remote-vtep ip-address</b> | Display MAC addresses learned from the specified remote VTEP.                               |

**Default** Not configured

**Command mode** EXEC

**Usage information** Use the `clear mac address-table dynamic nve remote-vtep` command to delete all MAC address entries learned from a remote VTEP. Use the `clear mac address-table dynamic virtual-network vn-id` command to delete all dynamic MAC address entries learned on a virtual-network bridge.

## Example

```
OS10# show mac address-table nve remote-vtep 32.1.1.1
Virtual-Network VNI MAC Address Type Remote-VTEP

10000 9999 00:00:00:00:00:77 dynamic VxLAN(32.1.1.1)
20000 19999 00:00:00:00:00:88 dynamic VxLAN(32.1.1.1)

OS10# show mac address-table nve vxlan-vni 9999
Virtual-Network VNI MAC Address Type Remote-VTEP

10000 9999 00:00:00:00:00:77 dynamic VxLAN(32.1.1.1)
```

## Supported releases

10.4.2.0 or later

# show mac address-table virtual-network

Displays the MAC addresses learned on all or a specified virtual network.

## Syntax

```
show mac address-table virtual-network [vn-id | local | remote | static |
dynamic | address mac-address | interface {ethernet node/slot/port:subport
| port-channel number}]
```

## Parameters

|                                                    |                                                                                                                  |
|----------------------------------------------------|------------------------------------------------------------------------------------------------------------------|
| <b>vn-id</b>                                       | Display only information about the specified virtual network.                                                    |
| <b>local</b>                                       | Display only locally learned MAC addresses.                                                                      |
| <b>remote</b>                                      | Display only remote MAC addresses.                                                                               |
| <b>static</b>                                      | Display only static MAC addresses.                                                                               |
| <b>dynamic</b>                                     | Display only dynamic MAC addresses.                                                                              |
| <b>address mac-address</b>                         | Display only information about the specified MAC address. Enter the MAC address in <i>EEEE.EEEE.EEEE</i> format. |
| <b>interface ethernet node/slot/port[:subport]</b> | Display only MAC addresses learned on the specified interface.                                                   |
| <b>interface port-channel number</b>               | Display only MAC addresses learned on the specified port channel.                                                |

## Default

Not configured

## Command mode

EXEC

## Usage information

Use this command to verify the MAC addresses learned on VXLAN virtual networks. By default, MAC learning from a remote VTEP is enabled.

## Example

```
OS10# show mac address-table virtual-network
Virtual-Network VlanId MAC Address Type Interface/Remote-VTEP

10000 00:00:00:00:00:11 dynamic ethernet1/1/31:1
10000 100 00:00:00:00:00:44 dynamic port-channel1000
10000 100 00:00:00:00:00:55 dynamic port-channel10
10000 00:00:00:00:00:77 dynamic VxLAN(32.1.1.1)
10000 100 34:a0:a0:a1:a2:f6 dynamic port-channel10
20000 300 00:00:00:00:00:22 dynamic port-channel100
20000 300 00:00:00:00:00:33 dynamic port-channel1000
20000 300 00:00:00:00:00:66 dynamic port-channel10
20000 00:00:00:00:00:88 dynamic VxLAN(32.1.1.1)
20000 300 34:a0:a0:a1:a2:f6 dynamic port-channel10
```



## Example: VXLAN with static VTEP

This example uses a typical Clos leaf-spine topology with static VXLAN tunnel endpoints (VTEPs) in VLT dual-homing domains. The individual switch configuration shows how to set up an end-to-end VXLAN. The underlay IP network routes advertise using OSPF.

- On VTEPs 1 and 2, access ports are assigned to the virtual network using a switch-scoped VLAN configuration.
- On VTEPs 3 and 4, access ports are assigned to the virtual network using a port-scoped VLAN configuration.
- Overlay routing between hosts in different IP subnets is configured on the VTEPs.

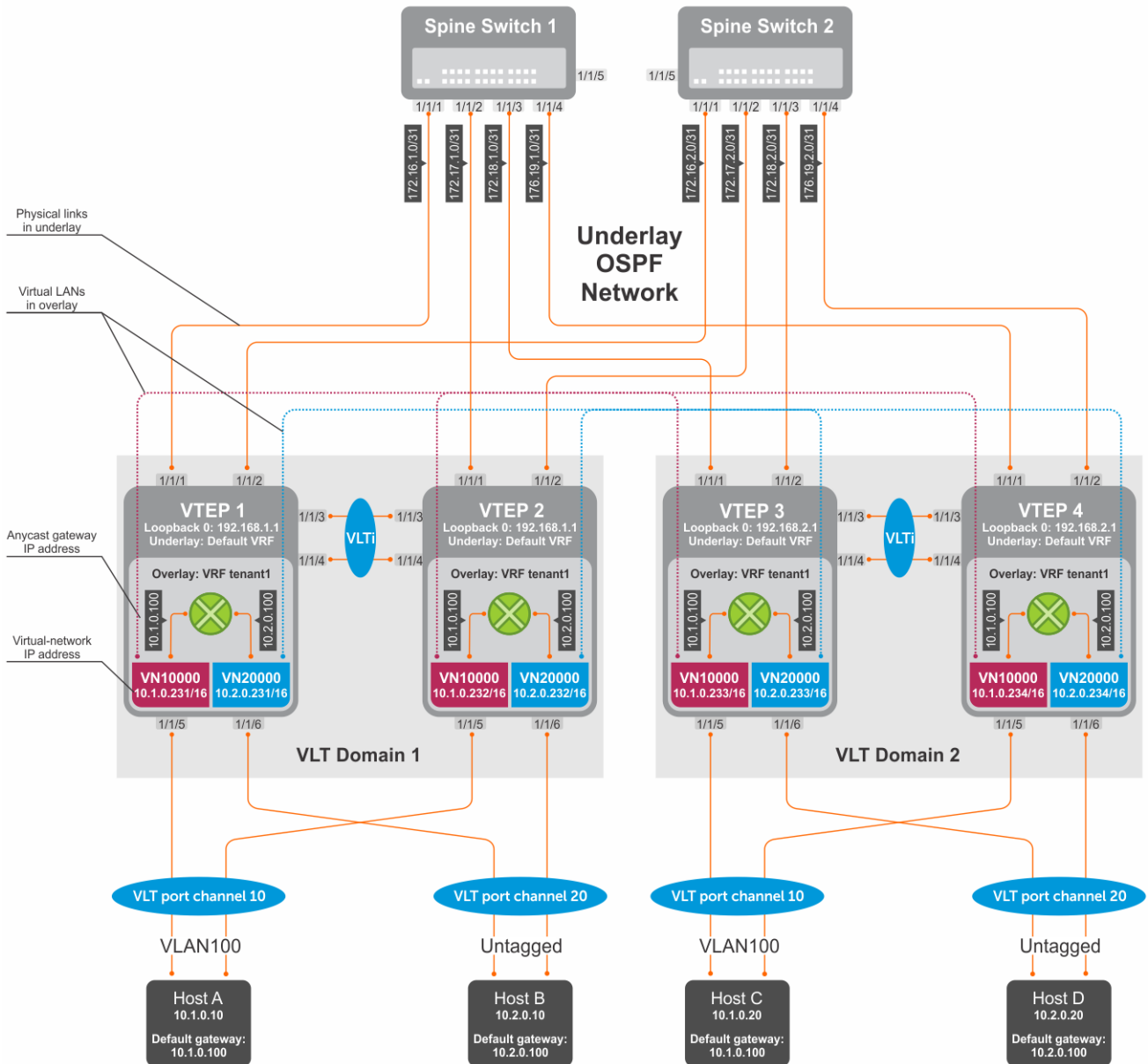

Figure 12. Static VXLAN use case

## VTEP 1 Leaf Switch

### 1. Configure the underlay OSPF protocol.

Do not configure the same IP address for the router ID and the source loopback interface in Step 2.

```
OS10(config)# router ospf 1
OS10(config-router-ospf-1)# router-id 172.16.0.1
OS10(config-router-ospf-1)# exit
```

### 2. Configure a Loopback interface.

```
OS10(config)# interface loopback0
OS10(conf-if-lo-0)# no shutdown
OS10(conf-if-lo-0)# ip address 192.168.1.1/32
OS10(conf-if-lo-0)# ip ospf 1 area 0.0.0.0
OS10(conf-if-lo-0)# exit
```

### 3. Configure the Loopback interface as the VXLAN source tunnel interface.

```
OS10(config)# nve
OS10(config-nve)# source-interface loopback0
OS10(config-nve)# exit
```

### 4. Configure VXLAN virtual networks with a static VTEP.

```
OS10(config)# virtual-network 10000
OS10(config-vn-10000)# vxlan-vni 10000
OS10(config-vn-vxlan-vni)# remote-vtep 192.168.2.1
OS10(config-vn-vxlan-vni-remote-vtep)# exit
OS10(config-vn-vxlan-vni)# exit
OS10(config-vn-10000)# exit
OS10(config)# virtual-network 20000
OS10(config-vn-20000)# vxlan-vni 20000
OS10(config-vn-vxlan-vni)# remote-vtep 192.168.2.1
OS10(config-vn-vxlan-vni-remote-vtep)# exit
OS10(config-vn-vxlan-vni)# exit
OS10(config-vn-20000)# exit
```

### 5. Assign VLAN member interfaces to virtual networks.

Use a switch-scoped VLAN-to-VNI mapping:

```
OS10(config)# interface vlan100
OS10(config-if-vl-100)# virtual-network 10000
OS10(config-if-vl-100)# no shutdown
OS10(config-if-vl-100)# exit
OS10(config)# interface vlan200
OS10(config-if-vl-100)# virtual-network 20000
OS10(config-if-vl-100)# no shutdown
OS10(config-if-vl-100)# exit
```

### 6. Configure access ports as VLAN members for switch-scoped VLAN-to-VNI mapping.

```
OS10(config)# interface port-channel10
OS10(conf-if-po-10)# no shutdown
OS10(conf-if-po-10)# switchport mode trunk
OS10(conf-if-po-10)# switchport trunk allowed vlan 100
OS10(conf-if-po-10)# exit

OS10(config)# interface ethernet1/1/5
OS10(conf-if-eth1/1/5)# no shutdown
OS10(conf-if-eth1/1/5)# channel-group 10 mode active
OS10(conf-if-eth1/1/5)# no switchport
OS10(conf-if-eth1/1/5)# exit

OS10(config)# interface port-channel20
OS10(conf-if-po-20)# no shutdown
OS10(conf-if-po-20)# switchport access vlan 200
OS10(conf-if-po-20)# exit
```

```
OS10(config)# interface ethernet1/1/6
OS10(config-if-eth1/1/6)# no shutdown
OS10(config-if-eth1/1/6)# channel-group 20 mode active
OS10(config-if-eth1/1/6)# no switchport
OS10(config-if-eth1/1/6)# exit
```

## 7. Configure upstream network-facing ports.

```
OS10(config)# interface ethernet1/1/1
OS10(config-if-eth1/1/1)# no shutdown
OS10(config-if-eth1/1/1)# no switchport
OS10(config-if-eth1/1/1)# mtu 1650
OS10(config-if-eth1/1/1)# ip address 172.16.1.0/31
OS10(config-if-eth1/1/1)# ip ospf 1 area 0.0.0.0
OS10(config-if-eth1/1/1)# exit
```

```
OS10(config)# interface ethernet1/1/2
OS10(config-if-eth1/1/2)# no shutdown
OS10(config-if-eth1/1/2)# no switchport
OS10(config-if-eth1/1/2)# mtu 1650
OS10(config-if-eth1/1/2)# ip address 172.16.2.0/31
OS10(config-if-eth1/1/2)# ip ospf 1 area 0.0.0.0
OS10(config-if-eth1/1/2)# exit
```

## 8. Configure VLT

### Configure a dedicated L3 underlay path to reach the VLT Peer in case of network failure.

```
OS10(config)# interface vlan4000
OS10(config-if-vl-4000)# no shutdown
OS10(config-if-vl-4000)# ip address 172.16.250.1/30
OS10(config-if-vl-4000)# ip ospf 1 area 0.0.0.0
OS10(config-if-vl-4000)# exit
```

### Configure the VLT port channel.

```
OS10(config)# interface port-channel10
OS10(config-if-po-10)# vlt-port-channel 10
OS10(config-if-po-10)# exit
```

```
OS10(config)# interface port-channel20
OS10(config-if-po-20)# vlt-port-channel 20
OS10(config-if-po-20)# exit
```

### Configure the VLTi member links.

```
OS10(config)# interface ethernet1/1/3
OS10(config-if-eth1/1/3)# no shutdown
OS10(config-if-eth1/1/3)# no switchport
OS10(config-if-eth1/1/3)# exit
```

```
OS10(config)# interface ethernet1/1/4
OS10(config-if-eth1/1/4)# no shutdown
OS10(config-if-eth1/1/4)# no switchport
OS10(config-if-eth1/1/4)# exit
```

### Configure the VLT domain.

```
OS10(config)# vlt-domain 1
OS10(config-vlt-1)# backup destination 10.16.150.1
OS10(config-vlt-1)# discovery-interface ethernet1/1/3,1/1/4
OS10(config-vlt-1)# vlt-mac aa:bb:cc:dd:ee:ff
OS10(config-vlt-1)# exit
```

### Configure UFD with uplink VLT ports and downlink network ports.

```
OS10(config)# uplink-state-group 1
OS10(config-uplink-state-group-1)# enable
OS10(config-uplink-state-group-1)# downstream ethernet1/1/1-1/1/2
```

```
OS10(config-uplink-state-group-1)# upstream port-channel10
OS10(config-uplink-state-group-1)# upstream port-channel20
OS10(config-uplink-state-group-1)# exit
```

## 9. Configure overlay IP routing

### Create the tenant VRF.

```
OS10(config)# ip vrf tenant1
OS10(config-vrf)# exit
```

### Configure the anycast L3 gateway MAC address for all VTEPs.

```
OS10(config)# ip virtual-router mac-address 00:01:01:01:01:01
```

### Configure routing with an anycast gateway IP address for each virtual network.

```
OS10(config)# interface virtual-network 10000
OS10(config-if-vn-10000)# ip vrf forwarding tenant1
OS10(config-if-vn-10000)# ip address 10.1.0.231/16
OS10(config-if-vn-10000)# ip virtual-router address 10.1.0.100
OS10(config-if-vn-10000)# no shutdown
OS10(config-if-vn-10000)# exit
OS10(config)# interface virtual-network 20000
OS10(config-if-vn-20000)# ip vrf forwarding tenant1
OS10(config-if-vn-20000)# ip address 10.2.0.231/16
OS10(config-if-vn-20000)# ip virtual-router address 10.2.0.100
OS10(config-if-vn-20000)# no shutdown
OS10(config-if-vn-20000)# exit
```

## VTEP 2 Leaf Switch

### 1. Configure the underlay OSPF protocol.

Do not configure the same router ID on other VTEP switches.

```
OS10(config)# router ospf 1
OS10(config-router-ospf-1)# router-id 172.17.0.1
OS10(config-router-ospf-1)# exit
```

### 2. Configure a Loopback interface.

The source-interface IP address must be same as the source-interface IP address on the VLT peer.

```
OS10(config)# interface loopback0
OS10(config-if-lo-0)# no shutdown
OS10(config-if-lo-0)# ip address 192.168.1.1/32
OS10(config-if-lo-0)# ip ospf 1 area 0.0.0.0
OS10(config-if-lo-0)# exit
```

### 3. Configure the Loopback interface as the VXLAN source tunnel interface.

```
OS10(config)# nve
OS10(config-nve)# source-interface loopback0
OS10(config-nve)# exit
```

### 4. Configure VXLAN virtual networks with a static VTEP.

```
OS10(config)# virtual-network 10000
OS10(config-vn-10000)# vxlan-vni 10000
OS10(config-vn-vxlan-vni)# remote-vtep 192.168.2.1
OS10(config-vn-vxlan-vni-remote-vtep)# exit
OS10(config-vn-vxlan-vni)# exit
OS10(config-vn-10000)# exit
OS10(config)# virtual-network 20000
OS10(config-vn-20000)# vxlan-vni 20000
OS10(config-vn-vxlan-vni)# remote-vtep 192.168.2.1
OS10(config-vn-vxlan-vni-remote-vtep)# exit
```

```
OS10(config-vn-vxlan-vni)# exit
OS10(config-vn-20000)# exit
```

## 5. Assign a switch-scoped VLAN to a virtual network.

```
OS10(config)# interface vlan100
OS10(config-if-vl-100)# virtual-network 10000
OS10(config-if-vl-100)# no shutdown
OS10(config-if-vl-100)# exit
OS10(config)# interface vlan200
OS10(config-if-vl-100)# virtual-network 20000
OS10(config-if-vl-100)# no shutdown
OS10(config-if-vl-100)# exit
```

## 6. Configure access ports as VLAN members.

```
OS10(config)# interface port-channel10
OS10(conf-if-po-10)# no shutdown
OS10(conf-if-po-10)# switchport mode access
OS10(conf-if-po-10)# switchport access vlan 200
OS10(conf-if-po-10)# exit

OS10(config)# interface ethernet1/1/5
OS10(conf-if-eth1/1/5)# no shutdown
OS10(conf-if-eth1/1/5)# channel-group 10 mode active
OS10(conf-if-eth1/1/5)# no switchport
OS10(conf-if-eth1/1/5)# exit

OS10(config)# interface port-channel20
OS10(conf-if-po-20)# no shutdown
OS10(conf-if-po-20)# switchport mode access
OS10(conf-if-po-20)# switchport access vlan 200
OS10(conf-if-po-20)# exit

OS10(config)# interface ethernet1/1/6
OS10(conf-if-eth1/1/6)# no shutdown
OS10(conf-if-eth1/1/6)# channel-group 20 mode active
OS10(conf-if-eth1/1/6)# no switchport
OS10(conf-if-eth1/1/6)# exit
```

## 7. Configure upstream network-facing ports.

```
OS10(config)# interface ethernet1/1/1
OS10(conf-if-eth1/1/1)# no shutdown
OS10(conf-if-eth1/1/1)# no switchport
OS10(conf-if-eth1/1/1)# mtu 1650
OS10(conf-if-eth1/1/1)# ip address 172.17.1.0/31
OS10(conf-if-eth1/1/1)# ip ospf 1 area 0.0.0.0
OS10(conf-if-eth1/1/1)# exit

OS10(config)# interface ethernet1/1/2
OS10(conf-if-eth1/1/2)# no shutdown
OS10(conf-if-eth1/1/2)# no switchport
OS10(conf-if-eth1/1/1)# mtu 1650
OS10(conf-if-eth1/1/2)# ip address 172.17.2.0/31
OS10(conf-if-eth1/1/2)# ip ospf 1 area 0.0.0.0
OS10(conf-if-eth1/1/2)# exit
```

## 8. Configure VLT

### Configure a dedicated L3 underlay path to reach the VLT Peer in case of network failure.

```
OS10(config)# interface vlan4000
OS10(config-if-vl-4000)# no shutdown
OS10(config-if-vl-4000)# ip address 172.16.250.2/30
OS10(config-if-vl-4000)# ip ospf 1 area 0.0.0.0
OS10(config-if-vl-4000)# exit
```

### Configure a VLT port channel.

```
OS10(config)# interface port-channel10
OS10(conf-if-po-10)# vlt port-channel 10
OS10(conf-if-po-10)# exit

OS10(config)# interface port-channel20
OS10(conf-if-po-20)# vlt port-channel 20
OS10(conf-if-po-20)# exit
```

### Configure VLTi member links.

```
OS10(config)# interface ethernet1/1/3
OS10(conf-if-eth1/1/3)# no shutdown
OS10(conf-if-eth1/1/3)# no switchport
OS10(conf-if-eth1/1/3)# exit

OS10(config)# interface ethernet1/1/4
OS10(conf-if-eth1/1/4)# no shutdown
OS10(conf-if-eth1/1/4)# no switchport
OS10(conf-if-eth1/1/4)# exit
```

### Configure a VLT domain.

```
OS10(config)# vlt-domain 1
OS10(conf-vlt-1)# backup destination 10.16.150.2
OS10(conf-vlt-1)# discovery-interface ethernet1/1/3,1/1/4
OS10(conf-vlt-1)# vlt-mac aa:bb:cc:dd:ee:ff
OS10(conf-vlt-1)# exit
```

### Configure UFD with uplink VLT ports and downlink network ports.

```
OS10(config)# uplink-state-group 1
OS10(conf-uplink-state-group-1)# enable
OS10(conf-uplink-state-group-1)# downstream ethernet1/1/1-1/1/2
OS10(conf-uplink-state-group-1)# upstream port-channel10
OS10(conf-uplink-state-group-1)# upstream port-channel20
OS10(conf-uplink-state-group-1)# exit
```

## 9. Configure overlay IP routing

### Create a tenant VRF.

```
OS10(config)# ip vrf tenant1
OS10(conf-vrf)# exit
```

### Configure an anycast L3 gateway MAC address for all VTEPs.

```
OS10(config)# ip virtual-router mac-address 00:01:01:01:01:01
```

### Configure routing with anycast gateway IP address for each virtual network.

```
OS10(config)# interface virtual-network 10000
OS10(config-if-vn-10000)# ip vrf forwarding tenant1
OS10(config-if-vn-10000)# ip address 10.1.0.232/16
OS10(config-if-vn-10000)# ip virtual-router address 10.1.0.100
OS10(config-if-vn-10000)# no shutdown
OS10(config-if-vn-10000)# exit
OS10(config)# interface virtual-network 20000
OS10(config-if-vn-20000)# ip vrf forwarding tenant1
OS10(config-if-vn-20000)# ip address 10.2.0.232/16
OS10(config-if-vn-20000)# ip virtual-router address 10.2.0.100
OS10(config-if-vn-20000)# no shutdown
OS10(config-if-vn-20000)# exit
```

## VTEP 3 Leaf Switch

### 1. Configure the underlay OSPF protocol.

Do not configure the same IP address for the router ID and the source loopback interface in Step 2.

```
OS10(config)# router ospf 1
OS10(config-router-ospf-1)# router-id 172.18.0.1
OS10(config-router-ospf-1)# exit
```

### 2. Configure a Loopback interface.

```
OS10(config)# interface loopback0
OS10(conf-if-lo-0)# no shutdown
OS10(conf-if-lo-0)# ip address 192.168.2.1/32
OS10(conf-if-lo-0)# ip ospf 1 area 0.0.0.0
OS10(conf-if-lo-0)# exit
```

### 3. Configure the Loopback interface as the VXLAN source tunnel interface.

```
OS10(config)# nve
OS10(config-nve)# source-interface loopback0
OS10(config-nve)# exit
```

### 4. Configure VXLAN virtual networks with a static VTEP.

```
OS10(config)# virtual-network 10000
OS10(config-vn-10000)# vxlan-vni 10000
OS10(config-vn-vxlan-vni)# remote-vtep 192.168.1.1
OS10(config-vn-vxlan-vni-remote-vtep)# exit
OS10(config-vn-vxlan-vni)# exit
OS10(config-vn-10000)# exit
OS10(config)# virtual-network 20000
OS10(config-vn-20000)# vxlan-vni 20000
OS10(config-vn-vxlan-vni)# remote-vtep 192.168.1.1
OS10(config-vn-vxlan-vni-remote-vtep)# exit
OS10(config-vn-vxlan-vni)# exit
OS10(config-vn-20000)# exit
```

### 5. Configure a reserved VLAN ID for untagged member interfaces.

```
OS10(config)# virtual-network untagged-vlan 1000
```

### 6. Configure access ports.

```
OS10(config)# interface port-channel10
OS10(conf-if-po-10)# no shutdown
OS10(conf-if-po-10)# switchport mode trunk
OS10(conf-if-po-10)# no switchport access vlan
OS10(conf-if-po-10)# exit

OS10(config)# interface ethernet1/1/5
OS10(conf-if-eth1/1/5)# no shutdown
OS10(conf-if-eth1/1/5)# channel-group 10 mode active
OS10(conf-if-eth1/1/5)# no switchport
OS10(conf-if-eth1/1/5)# exit

OS10(config)# interface port-channel20
OS10(conf-if-po-20)# no shutdown
OS10(conf-if-po-20)# switchport mode trunk
OS10(conf-if-po-20)# no switchport access vlan
OS10(conf-if-po-20)# exit

OS10(config)# interface ethernet1/1/6
OS10(conf-if-eth1/1/6)# no shutdown
OS10(conf-if-eth1/1/6)# channel-group 20 mode active
OS10(conf-if-eth1/1/6)# no switchport
OS10(conf-if-eth1/1/6)# exit
```

## 7. Add access ports to the VXLAN virtual networks.

```
OS10(config)# virtual-network 10000
OS10(config-vn-10000)# member-interface port-channel 10 vlan-tag 100
OS10(config-vn-10000)# exit
OS10(config)# virtual-network 20000
OS10(config-vn-20000)# member-interface port-channel 20 untagged
OS10(config-vn-20000)# exit
```

**NOTE:** This step shows how to add access ports using port-scoped VLAN-to-VNI mapping. You can also add access ports using a switch-scoped VLAN-to-VNI mapping. However, you cannot use both methods at the same time; you must use either a port-scoped or switch-scoped VLAN-to-VNI mapping.

## 8. Configure upstream network-facing ports.

```
OS10(config)# interface ethernet1/1/1
OS10(conf-if-eth1/1/1)# no shutdown
OS10(conf-if-eth1/1/1)# no switchport
OS10(conf-if-eth1/1/1)# mtu 1650
OS10(conf-if-eth1/1/1)# ip address 172.18.1.0/31
OS10(conf-if-eth1/1/1)# ip ospf 1 area 0.0.0.0
OS10(conf-if-eth1/1/1)# exit

OS10(config)# interface ethernet1/1/2
OS10(conf-if-eth1/1/2)# no shutdown
OS10(conf-if-eth1/1/2)# no switchport
OS10(conf-if-eth1/1/1)# mtu 1650
OS10(conf-if-eth1/1/2)# ip address 172.18.2.0/31
OS10(conf-if-eth1/1/2)# ip ospf 1 area 0.0.0.0
OS10(conf-if-eth1/1/2)# exit
```

## 9. Configure VLT

### Configure VLTi VLAN for the VXLAN virtual network.

```
OS10(config)# virtual-network 10000
OS10(config-vn-10000)# vlti-vlan 100
OS10(config-vn-10000)# exit
OS10(config)# virtual-network 20000
OS10(config-vn-20000)# vlti-vlan 200
OS10(config-vn-20000)# exit
```

### Configure a dedicated L3 underlay path to reach the VLT Peer in case of network failure.

```
OS10(config)# interface vlan4000
OS10(config-if-vl-4000)# no shutdown
OS10(config-if-vl-4000)# ip address 172.16.250.9/30
OS10(config-if-vl-4000)# ip ospf 1 area 0.0.0.0
OS10(config-if-vl-4000)# exit
```

### Configure a VLT port channel.

```
OS10(config)# interface port-channel10
OS10(conf-if-po-10)# vlt port-channel 10
OS10(conf-if-po-10)# exit

OS10(config)# interface port-channel20
OS10(conf-if-po-20)# vlt port-channel 20
OS10(conf-if-po-20)# exit
```

### Configure VLTi member links.

```
OS10(config)# interface ethernet1/1/3
OS10(conf-if-eth1/1/3)# no shutdown
OS10(conf-if-eth1/1/3)# no switchport
OS10(conf-if-eth1/1/3)# exit

OS10(config)# interface ethernet1/1/4
OS10(conf-if-eth1/1/4)# no shutdown
```



```
OS10(config-if-eth1/1/4)# no switchport
OS10(config-if-eth1/1/4)# exit
```

### Configure a VLT domain.

```
OS10(config)# vlt-domain 1
OS10(config-vlt-1)# backup destination 10.16.150.3
OS10(config-vlt-1)# discovery-interface ethernet1/1/3,1/1/4
OS10(config-vlt-1)# vlt-mac aa:bb:dd:cc:ff:ee
OS10(config-vlt-1)# exit
```

### Configure UFD with uplink VLT ports and downlink network ports.

```
OS10(config)# uplink-state-group 1
OS10(config-uplink-state-group-1)# enable
OS10(config-uplink-state-group-1)# downstream ethernet1/1/1-1/1/2
OS10(config-uplink-state-group-1)# upstream port-channel10
OS10(config-uplink-state-group-1)# upstream port-channel20
OS10(config-uplink-state-group-1)# exit
```

## 10. Configure overlay IP routing

### Create a tenant VRF.

```
OS10(config)# ip vrf tenant1
OS10(config-vrf)# exit
```

### Configure an anycast L3 gateway.

```
OS10(config)# ip virtual-router mac-address 00:01:01:01:01:01
```

### Configure routing with an anycast gateway IP address for each virtual network.

```
OS10(config)# interface virtual-network 10000
OS10(config-if-vn-10000)# ip vrf forwarding tenant1
OS10(config-if-vn-10000)# ip address 10.1.0.233/16
OS10(config-if-vn-10000)# ip virtual-router address 10.1.0.100
OS10(config-if-vn-10000)# no shutdown
OS10(config-if-vn-10000)# exit
OS10(config)# interface virtual-network 20000
OS10(config-if-vn-20000)# ip vrf forwarding tenant1
OS10(config-if-vn-20000)# ip address 10.2.0.233/16
OS10(config-if-vn-20000)# ip virtual-router address 10.2.0.100
OS10(config-if-vn-20000)# no shutdown
OS10(config-if-vn-20000)# exit
```

## VTEP 4 Leaf Switch

### 1. Configure the underlay OSPF protocol.

Do not configure the same IP address for the router ID and the source loopback interface in Step 2..

```
OS10(config)# router ospf 1
OS10(config-router-ospf-1)# router-id 172.19.0.1
OS10(config-router-ospf-1)# exit
```

### 2. Configure a Loopback interface.

```
OS10(config)# interface loopback0
OS10(config-if-lo-0)# no shutdown
OS10(config-if-lo-0)# ip address 192.168.2.1/32
OS10(config-if-lo-0)# ip ospf 1 area 0.0.0.0
OS10(config-if-lo-0)# exit
```

### 3. Configure the Loopback interface as the VXLAN source tunnel interface.

```
OS10(config)# nve
OS10(config-nve)# source-interface loopback0
OS10(config-nve)# exit
```

### 4. Configure VXLAN virtual networks with a static VTEP.

```
OS10(config)# virtual-network 10000
OS10(config-vn-10000)# vxlan-vni 10000
OS10(config-vn-vxlan-vni)# remote-vtep 192.168.1.1
OS10(config-vn-vxlan-vni-remote-vtep)# exit
OS10(config-vn-vxlan-vni)# exit
OS10(config-vn-10000)# exit
OS10(config)# virtual-network 20000
OS10(config-vn-20000)# vxlan-vni 20000
OS10(config-vn-vxlan-vni)# remote-vtep 192.168.1.1
OS10(config-vn-vxlan-vni-remote-vtep)# exit
OS10(config-vn-vxlan-vni)# exit
OS10(config-vn-20000)# exit
```

### 5. Configure a reserved VLAN ID for untagged member interfaces.

```
OS10(config)# virtual-network untagged-vlan 1000
```

### 6. Configure access ports.

```
OS10(config)# interface port-channel10
OS10(conf-if-po-10)# no shutdown
OS10(conf-if-po-10)# switchport mode trunk
OS10(conf-if-po-10)# no switchport access vlan
OS10(conf-if-po-10)# exit

OS10(config)# interface ethernet1/1/5
OS10(conf-if-eth1/1/5)# no shutdown
OS10(conf-if-eth1/1/5)# channel-group 10 mode active
OS10(conf-if-eth1/1/5)# no switchport
OS10(conf-if-eth1/1/5)# exit

OS10(config)# interface port-channel20
OS10(conf-if-po-20)# no shutdown
OS10(conf-if-po-20)# switchport mode trunk
OS10(conf-if-po-20)# no switchport access vlan
OS10(conf-if-po-20)# exit

OS10(config)# interface ethernet1/1/6
OS10(conf-if-eth1/1/6)# no shutdown
OS10(conf-if-eth1/1/6)# channel-group 20 mode active
OS10(conf-if-eth1/1/6)# no switchport
OS10(conf-if-eth1/1/6)# exit
```

### 7. Add access ports to the VXLAN virtual network.

```
OS10(config)# virtual-network 10000
OS10(config-vn-10000)# member-interface port-channel 10 vlan-tag 100
OS10(config-vn-10000)# exit
OS10(config)# virtual-network 20000
OS10(config-vn-20000)# member-interface port-channel 20 untagged
OS10(config-vn-20000)# exit
```

### 8. Configure upstream network-facing ports.

```
OS10(config)# interface ethernet1/1/1
OS10(conf-if-eth1/1/1)# no shutdown
OS10(conf-if-eth1/1/1)# no switchport
OS10(conf-if-eth1/1/1)# mtu 1650
OS10(conf-if-eth1/1/1)# ip address 172.19.1.0/31
OS10(conf-if-eth1/1/1)# ip ospf 1 area 0.0.0.0
OS10(conf-if-eth1/1/1)# exit
```

```

OS10(config)# interface ethernet1/1/2
OS10(config-if-eth1/1/2)# no shutdown
OS10(config-if-eth1/1/2)# no switchport
OS10(config-if-eth1/1/1)# mtu 1650
OS10(config-if-eth1/1/2)# ip address 172.19.2.0/31
OS10(config-if-eth1/1/2)# ip ospf 1 area 0.0.0.0
OS10(config-if-eth1/1/2)# exit

```

## 9. Configure VLT

### Configure VLTi VLAN for the VXLAN virtual network.

```

OS10(config)# virtual-network 10000
OS10(config-vn-10000)# vlti-vlan 200
OS10(config-vn-10000)# exit
OS10(config)# virtual-network 20000
OS10(config-vn-20000)# vlti-vlan 100
OS10(config-vn-20000)# exit

```

### Configure a dedicated L3 underlay path to reach the VLT Peer in case of network failure.

```

OS10(config)# interface vlan4000
OS10(config-if-vl-4000)# no shutdown
OS10(config-if-vl-4000)# ip address 172.16.250.10/30
OS10(config-if-vl-4000)# ip ospf 1 area 0.0.0.0
OS10(config-if-vl-4000)# exit

```

### Configure a VLT port channel.

```

OS10(config)# interface port-channel10
OS10(config-if-po-10)# vlt port-channel 10
OS10(config-if-po-10)# exit

```

```

OS10(config)# interface port-channel20
OS10(config-if-po-20)# vlt port-channel 20
OS10(config-if-po-20)# exit

```

### Configure VLTi member links.

```

OS10(config)# interface ethernet1/1/3
OS10(config-if-eth1/1/3)# no shutdown
OS10(config-if-eth1/1/3)# no switchport
OS10(config-if-eth1/1/3)# exit

```

```

OS10(config)# interface ethernet1/1/4
OS10(config-if-eth1/1/4)# no shutdown
OS10(config-if-eth1/1/4)# no switchport
OS10(config-if-eth1/1/4)# exit

```

### Configure a VLT domain.

```

OS10(config)# vlt-domain 1
OS10(config-vlt-1)# backup destination 10.16.150.4
OS10(config-vlt-1)# discovery-interface ethernet1/1/3,1/1/4
OS10(config-vlt-1)# vlt-mac aa:bb:dd:cc:ff:ee
OS10(config-vlt-1)# exit

```

### Configure UFD with uplink VLT ports and downlink network ports.

```

OS10(config)# uplink-state-group 1
OS10(config-uplink-state-group-1)# enable
OS10(config-uplink-state-group-1)# downstream ethernet1/1/1-1/1/2
OS10(config-uplink-state-group-1)# upstream port-channel10
OS10(config-uplink-state-group-1)# upstream port-channel20
OS10(config-uplink-state-group-1)# exit

```

## 10. Configure overlay IP routing.

### Create a tenant VRF.

```
OS10(config)# ip vrf tenant1
OS10(conf-vrf)# exit
```

### Configure an anycast L3 gateway for all VTEPs in all virtual networks.

```
OS10(config)# ip virtual-router mac-address 00:01:01:01:01:01
```

### Configure routing with an anycast gateway IP address for each virtual network.

```
OS10(config)# interface virtual-network 10000
OS10(config-if-vn-10000)# ip vrf forwarding tenant1
OS10(config-if-vn-10000)# ip address 10.1.0.234/16
OS10(config-if-vn-10000)# ip virtual-router address 10.1.0.100
OS10(config-if-vn-10000)# no shutdown
OS10(config-if-vn-10000)# exit
OS10(config)# interface virtual-network 20000
OS10(config-if-vn-20000)# ip vrf forwarding tenant1
OS10(config-if-vn-20000)# ip address 10.2.0.234/16
OS10(config-if-vn-20000)# ip virtual-router address 10.2.0.100
OS10(config-if-vn-20000)# no shutdown
OS10(config-if-vn-20000)# exit
```

## Spine Switch 1

### 1. Configure downstream ports on underlay links to leaf switches.

```
OS10(config)# interface ethernet1/1/1
OS10(conf-if-eth1/1/1)# no shutdown
OS10(conf-if-eth1/1/1)# no switchport
OS10(conf-if-eth1/1/1)# ip address 172.16.1.1/31
OS10(conf-if-eth1/1/1)# ip ospf 1 area 0.0.0.0
OS10(conf-if-eth1/1/1)# exit

OS10(config)# interface ethernet1/1/2
OS10(conf-if-eth1/1/2)# no shutdown
OS10(conf-if-eth1/1/2)# no switchport
OS10(conf-if-eth1/1/2)# ip address 172.17.1.1/31
OS10(conf-if-eth1/1/2)# ip ospf 1 area 0.0.0.0
OS10(conf-if-eth1/1/2)# exit

OS10(config)# interface ethernet1/1/3
OS10(conf-if-eth1/1/3)# no shutdown
OS10(conf-if-eth1/1/3)# no switchport
OS10(conf-if-eth1/1/3)# ip address 172.18.1.1/31
OS10(conf-if-eth1/1/3)# ip ospf 1 area 0.0.0.0
OS10(conf-if-eth1/1/3)# exit

OS10(config)# interface ethernet1/1/4
OS10(conf-if-eth1/1/4)# no shutdown
OS10(conf-if-eth1/1/4)# no switchport
OS10(conf-if-eth1/1/4)# ip address 172.19.1.1/31
OS10(conf-if-eth1/1/4)# ip ospf 1 area 0.0.0.0
OS10(conf-if-eth1/1/4)# exit
```

### 2. Configure the underlay OSPF protocol.

```
OS10(config)# router ospf 1
OS10(config-router-ospf-1)# router-id 172.200.0.1
OS10(config-router-ospf-1)# exit
```

## Spine Switch 2

### 1. Configure downstream ports on underlay links to leaf switches.

```
OS10(config)# interface ethernet1/1/1
OS10(config-if-eth1/1/1)# no shutdown
OS10(config-if-eth1/1/1)# no switchport
OS10(config-if-eth1/1/1)# ip address 172.16.2.1/31
OS10(config-if-eth1/1/1)# ip ospf 1 area 0.0.0.0
OS10(config-if-eth1/1/1)# exit

OS10(config)# interface ethernet1/1/2
OS10(config-if-eth1/1/2)# no shutdown
OS10(config-if-eth1/1/2)# no switchport
OS10(config-if-eth1/1/2)# ip address 172.17.2.1/31
OS10(config-if-eth1/1/2)# ip ospf 1 area 0.0.0.0
OS10(config-if-eth1/1/2)# exit

OS10(config)# interface ethernet1/1/3
OS10(config-if-eth1/1/3)# no shutdown
OS10(config-if-eth1/1/3)# no switchport
OS10(config-if-eth1/1/3)# ip address 172.18.2.1/31
OS10(config-if-eth1/1/3)# ip ospf 1 area 0.0.0.0
OS10(config-if-eth1/1/3)# exit

OS10(config)# interface ethernet1/1/4
OS10(config-if-eth1/1/4)# no shutdown
OS10(config-if-eth1/1/4)# no switchport
OS10(config-if-eth1/1/4)# ip address 172.19.2.1/31
OS10(config-if-eth1/1/4)# ip ospf 1 area 0.0.0.0
OS10(config-if-eth1/1/4)# exit
```

### 2. Configure the underlay OSPF protocol.

```
OS10(config)# router ospf 1
OS10(config-router-ospf-1)# router-id 172.201.0.1
OS10(config-router-ospf-1)# exit
```

## BGP EVPN for VXLAN

Ethernet Virtual Private Network (EVPN) is a control plane for VXLAN that reduces flooding in the network and resolves scalability concerns. EVPN uses MP-BGP to exchange information between VTEPs. EVPN was introduced in RFC 7432 and is based on BGP MPLS-based VPNs. RFC 8365 describes VXLAN-based EVPN.

The MP-BGP EVPN control plane provides protocol-based remote VTEP discovery, and MAC and ARP learning. This configuration reduces flooding related to L2 unknown unicast traffic. The distribution of host MAC and IP reachability information supports virtual machine (VM) mobility and scalable VXLAN overlay network designs.

The BGP EVPN protocol groups MAC addresses and ARP/neighbor addresses under EVPN instances (EVI) to exchange them between VTEPs. In OS10, each EVI is associated with a VXLAN VNI in 1:1 mapping.

### Benefits of a BGP EVPN-based VXLAN

- Eliminates the flood-and-learn method of VTEP discovery by enabling control-plane learning of end-host L2 and L3 reachability information.
- Minimizes network flooding of unknown unicast and broadcast traffic through EVPN-based MAC and IP route advertisements on local VTEPs.
- Provides support for host mobility.

## BGP EVPN compared to static VXLAN

OS10 supports two types of VXLAN NVO overlay networks:

- Static VXLAN
- BGP EVPN

Configure and operate static VXLANs and BGP EVPNs for VXLAN in the same way:

- Manually configure the overlay and underlay networks.
- Manually configure each virtual network and VNI.
- Manually configure access port membership in a virtual network.
- Existing routing protocols provision and learn underlay reachability to VTEP peers.

However, static VXLANs and BGP EVPNs for VXLAN differ as described:

**Table 46. Differences between Static VXLAN and VXLAN BGP EVPN**

| Static VXLAN                                                                                                                                      | VXLAN BGP EVPN                                                                                                                                                                                                                                                     |
|---------------------------------------------------------------------------------------------------------------------------------------------------|--------------------------------------------------------------------------------------------------------------------------------------------------------------------------------------------------------------------------------------------------------------------|
| To start sending and receiving virtual-network traffic to and from a remote VTEP, manually configure the VTEP as a member of the virtual network. | No manual configuration is required. Each remote VTEP is automatically learned as a member of a virtual network from the EVPN routes received from the remote VTEP. After a remote VTEP address is learned, VXLAN traffic is sent to, and received from, the VTEP. |
| Data packets learn remote hosts after decapsulation of the VXLAN header in the data plane.                                                        | Remote host MAC addresses are learned in the control plane using BGP EVPN Type 2 routes and MAC/IP advertisements.                                                                                                                                                 |

## VXLAN BGP EVPN operation

The EVPN address family allows VXLAN to carry EVPN routes in External Border Gateway Protocol (eBGP) and Internal Border Gateway Protocol (iBGP) sessions. In a data center network, use eBGP or iBGP for route exchange in both the IP underlay network and EVPN.

The following sample BGP EVPN topology shows a leaf-spine data center network where eBGP exchanges IP routes in the IP underlay network, and exchanges EVPN routes in the VXLAN overlay network. All spine nodes are in one autonomous system—AS 65535. All leaf nodes are in another autonomous system—AS 65000.

To advertise underlay IP routes, eBGP peer sessions establish between the leaf and spine nodes using an interface IP address. To advertise EVPN routes, eBGP peer sessions between the leaf and spine nodes use a Loopback IP address.

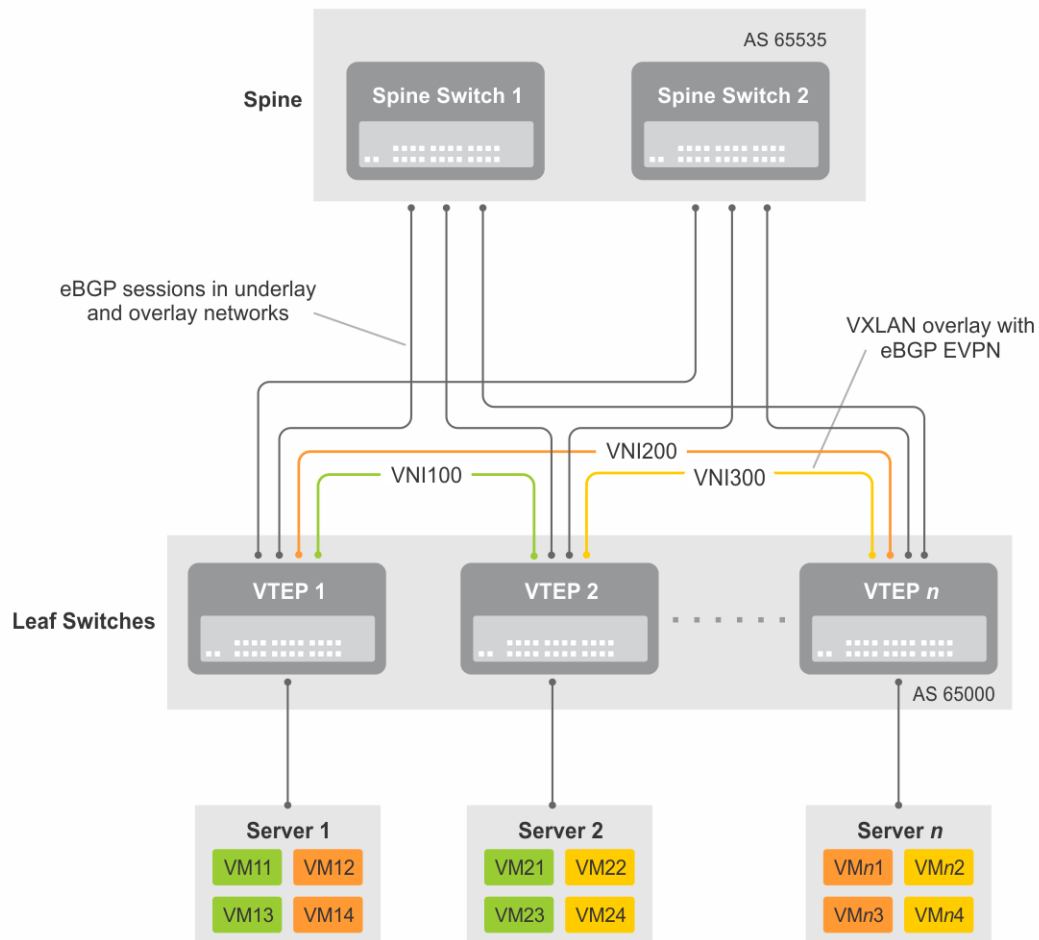

**Figure 13. BGP EVPN topology**

### Leaf nodes

Leaf nodes are typically top-of-rack (ToR) switches in a data center network. They act as the VXLAN tunnel endpoints and perform VXLAN encapsulation and decapsulation. Leaf nodes also participate in the MP-BGP EVPN to support control plane and data plane functions.

Control plane functions include:

- Initiate and maintain route adjacencies using any routing protocol in the underlay network.
- Advertise locally learned routes to all MP-BGP EVPN peers.
- Process the routes that are received from remote MP-BGP EVPN peers and install them in the local forwarding plane.

Data plane functions include:

- Encapsulate server traffic with VXLAN headers and forward the packets in the underlay network.
- Decapsulate VXLAN packets received from remote VTEPs and forward the native packets to downstream hosts.
- Perform underlay route processing, including routing based on the outer IP address.

### Spine nodes

The role of a spine node changes based on its control plane and data plane functions. Spine nodes participate in underlay route processing to forward packets and in the overlay network to advertise EVPN routes to all MP-BGP peers.

Control plane functions include:

- Initiate BGP peering with all neighbor leaf nodes.
- Advertise BGP routes to all BGP peers.
- Initiate and maintain routing adjacencies with all leaf and spine nodes in the underlay network.

Data plane functions include:

- Perform only underlay route processing based on the outer header in VXLAN encapsulated packets.

- Does not perform VXLAN encapsulation or decapsulation.

The BGP EVPN running on each VTEP listens to the exchange of route information in the local overlay, encodes the learned routes as BGP EVPN routes, and injects them into BGP to advertise to the peers. Tunnel endpoints advertise as Type 3 EVPN routes. MAC/IP addresses advertise as Type 2 EVPN routes.

### EVPN instance

An EVPN instance (EVI) spans across the VTEPs that participate in an Ethernet VPN. Each virtual-network tenant segment, that is advertised using EVPN, must associate with an EVI. In OS10, configure EVIs in auto-EVI or manual configuration mode.

- Auto-EVI — After you configure a virtual network on a VTEP, auto-EVI mode automatically creates an EVPN instance. The route distinguisher (RD) and route target (RT) values automatically generate:
  - The EVI ID autogenerates with the same value as the virtual-network ID (VNID) configured on the VTEP and associates with the VXLAN network ID (VNI).
  - A Route Distinguisher autogenerates for each EVI ID. A Route Distinguisher maintains the uniqueness of an EVPN route between different EVPN instances.
  - A Route Target import and export value autogenerates for each EVI ID. A Route Target determines how EVPN routes distribute among EVPN instances.
- Manual EVI configuration — To specify the RD and RT values, manually configure EVPN instances and associate each EVI with the overlay virtual network using the VXLAN VNI. The EVI activates only when you configure the virtual network, RD, and RT values.

In manual EVI configuration, you can either manually configure the RD and RT or have them autoconfigured.

 **NOTE:** Dell Technologies recommends using manual EVI for interoperability with network equipment vendors.

### Route distinguisher

The RD is an 8-byte identifier that uniquely identifies an EVI. Each EVPN route is prefixed with a unique RD and exchanged between BGP peers, making the tenant route unique across the network. In this way, overlapping address spaces among tenants are supported.

You can autogenerate or manually configure a RD for each EVI. In auto-EVI mode, the RD is autogenerated. In manual EVI configuration mode, you can autogenerate or manually configure the RD.

As specified in RFC 7432, a manually configured RD is encoded in the format: *4-octet-ipv4-address:2-octet-number*. An autogenerated RD has the format: *vtep-ip-address:evi*.

### Route target

While a RD maintains the uniqueness of an EVPN route among different EVIs, a RT controls the way the EVPN routes are distributed among EVIs. Each EVI is configured with an import and export RT value. BGP EVPN routes advertise for an EVI carry the export RT associated with the EVI. A receiving VTEP downloads information in the BGP EVPN route to EVIs that have a matching import RT value.

You can autogenerate or manually configure the RT import and export for each EVI. In auto-EVI mode, RT autogenerates. In manual EVI configuration mode, you can autogenerate or manually configure the RT.

The RT consists of a 2-octet *type* and a 6-octet *value*. If you autoconfigure a RT, the encoding format is different for a 2-byte and 4-byte AS number (ASN):

- For a 2-byte ASN, the RT *type* is set to 0200 (Type 0 in RFC 4364). The RT *value* is encoded in the format that is described in section 5.1.2.1 of RFC 8365: *2-octet-ASN: 4-octet-number*, where the following values are used in the *4-octet-number* field:
  - Type: 1
  - D-ID: 0
  - Service-ID: VNI
- For a 4-byte ASN, the RT *type* is set to 0202 (Type 2 in RFC 4364). The RT *value* is encoded in the format: *4-octet-ASN: 2-octet-number*, where the *2-octet-number* field contains the EVI ID. In auto-EVI mode, the EVI ID is the same as the virtual network ID (VNID). In 4-byte ASN deployment, OS10 supports RT autoconfiguration if the VNID-to-VNI mapping is the same on all VTEPs.

 **NOTE:** Dell Technologies recommends using manual route-target for interoperability with network equipment vendors.



# Configure BGP EVPN for VXLAN

To set up BGP EVPN service in a VXLAN overlay network:

1. Configure the VXLAN overlay network. If you enable routing for VXLAN virtual networks, Integrated Routing and Bridging (IRB) for BGP EVPN is automatically enabled. For more information, see [Configure VXLAN](#).
2. Configure BGP to advertise EVPN routes.
3. Configure EVPN, including the VNI, RD, and RT values associated with the EVPN instance.
4. Verify the BGP EVPN configuration.

## Configuration

1. Configure BGP to advertise EVPN routes.

EVPN requires that you establish MP-BGP sessions between leaf and spine nodes in the underlay network. On each spine and leaf node, configure at least two BGP peering sessions:

- A directly connected BGP peer in the underlay network to advertise VTEP and Loopback IP addresses using the IPv4 unicast address family.
- A BGP peer in the overlay network to advertise overlay information using the EVPN address family. In BGP peer sessions in the overlay, activate only the EVPN address family.

For each BGP peer session in the underlay network:

- a. Create a BGP instance in CONFIGURATION mode. You enter router BGP configuration mode.

```
router bgp as-number
```

- b. Assign an IP address to the BGP instance in ROUTER-BGP mode.

```
router-id ip-address
```

- c. Enter IPv4 address-family configuration mode from ROUTER-BGP mode.

```
address-family ipv4 unicast
```

- d. Advertise the IPv4 prefix to BGP peers in the address family in ROUTER-BGP-ADDRESS-FAMILY mode.

```
network ip-address/mask
```

- e. Return to ROUTER-BGP mode.

```
exit
```

- f. Configure the BGP peer address in ROUTER-BGP mode.

```
neighbor ip-address
```

- g. Assign the BGP neighbor to an autonomous system in ROUTER-BGP-NEIGHBOR mode.

```
remote-as as-number
```

- h. Enable the peer session with the BGP neighbor in ROUTER-BGP-NEIGHBOR mode.

```
no shutdown
```

- i. Return to ROUTER-BGP mode.

```
exit
```

For each BGP peer session in the overlay network:

- a. Configure the BGP peer using its Loopback IP address on the VTEP in ROUTER-BGP mode.

```
neighbor loopback-ip-address
```

- b. Assign the BGP neighbor Loopback address to the autonomous system in ROUTER-BGP-NEIGHBOR mode. The neighbor Loopback IP address is the source interface on the remote VTEP.

```
remote-as as-number
```

- c. Use the local Loopback address as the source address in BGP packets sent to the neighbor in ROUTER-BGP-NEIGHBOR mode.

```
update-source loopback0
```

- d. Send an extended community attribute to the BGP neighbor in ROUTER-BGP-NEIGHBOR mode.

```
send-community extended
```

- e. Enable the peer session with the BGP neighbor in ROUTER-BGP-NEIGHBOR mode.

```
no shutdown
```

- f. Configure the L2 VPN EVPN address family for VXLAN host-based routing to the BGP peer in ROUTER-BGP-NEIGHBOR mode.

```
address-family l2vpn evpn
```

- g. Enable the exchange of L2VPN EVPN addresses with the BGP peer in ROUTER-BGP-NEIGHBOR mode.

```
activate
```

- h. Return to ROUTER-BGP mode.

```
exit
```

- i. Enter IPv4 address-family configuration mode from ROUTER-BGP mode.

```
address-family ipv4 unicast
```

- j. Disable the exchange of IPv4 addresses with BGP peers in ROUTER-BGP mode.

```
no activate
```

- k. Return to ROUTER-BGP-NEIGHBOR mode.

```
exit
```

- l. (Optional) If all the leaf switches are configured in the same ASN:

- On each leaf switch, enter L2VPN EVPN address-family configuration mode from ROUTER-BGP-NEIGHBOR mode. Activate the exchange of L2VPN EVPN addresses with BGP peers. Configure the switch to accept a route with the local AS number in updates received from a peer in ROUTER-BGP-NEIGHBOR-AF mode.

```
OS10(config-router-bgp-neighbor)# address-family l2vpn evpn
OS10(config-router-neighbor-af)# activate
OS10(config-router-neighbor-af)# allowas-in 1
OS10(config-router-neighbor-af)# exit
OS10(config-router-bgp-neighbor)# exit
```

- On each spine switch, disable sender-side loop detection to leaf switch neighbors in ROUTER-BGP-NEIGHBOR-AF mode.

```
OS10(conf-router-neighbor)# address-family ipv4 unicast
OS10(conf-router-neighbor-af)# no sender-side-loop-detection
OS10(conf-router-neighbor-af)# exit
```

- m. (Optional) In a VLT deployment, on each leaf switch, configure the number of multi-hop peer routes in ROUTER-BGP-NEIGHBOR mode to ensure that the BGP EVPN peer session establishes over the VLT VTEP peer if all local links to spine switches are down.

```
OS10(conf-router-neighbor)# ebgp-multihop 1
```

## 2. Configure EVPN.

An EVPN instance (EVI) spans across the VTEPs that participate in the EVPN. In OS10, configure an EVI in auto-EVI or manual configuration mode.

- **Auto-EVI mode**

- a. Enable the EVPN control plane in CONFIGURATION mode.

```
evpn
```

- b. Enable auto-EVI creation for overlay virtual networks in EVPN mode. Auto-EVI creation is supported only if BGP EVPN is used with 2-byte AS numbers and if at least one BGP instance is enabled with the EVPN address family. No further manual configuration is allowed in auto-EVI mode.

```
auto-evi
```

• **Manual EVI configuration mode**

- a. Enable the EVPN control plane in CONFIGURATION mode.

```
evpn
```

- b. Manually create an EVPN instance in EVPN mode. The range is from 1 to 65535.

```
evi id
```

- c. Configure the Route Distinguisher in EVPN EVI mode.

```
rd {A.B.C.D:[1-65535] | auto}
```

Where:

- `rd A.B.C.D:[1-65535]` configures the RD with a 4-octet IPv4 address then a 2-octet-number.
- `rd auto` automatically generates the RD.

- d. Configure the RT values in EVPN EVI mode.

```
route-target {auto | value [asn4] {import | export | both}}
```

Where:

- `route-target auto` auto-configures an import and export value for EVPN routes.
- `route-target value [asn4]{import | export | both}` configures an import or export value for EVPN routes in the format *2-octet-ASN:4-octet-number* or *4-octet-ASN:2-octet-number*.
  - The *2-octet* ASN number is 1 to 65535.
  - The *4-octet* ASN number is 1 to 4294967295.

To configure the same value for the RT import and export values, use the `both` option. `asn4` advertises a 2-byte AS number as a 4-byte route target value. If you specify the `asn4` option, configure the VXLAN network ID associated with the EVPN instance in EVPN EVI mode, from 1 to 16,777,215. Configure the same VNI value that you configure for the VXLAN virtual network. For more information, see [Configure VXLAN](#).

```
vni vni
```

3. Verify the BGP EVPN configuration.

**Display the EVPN instance configuration**

```
OS10# show evpn evi 1
EVI : 65447, State : up
Bridge-Domain : (Virtual-Network)100, (VNI)100
Route-Distinguisher : 1:110.111.170.102:65447(auto)
Route-Targets : 0:101:268435556(auto) both
Inclusive Multicast : 110.111.170.107
```

**Display the VXLAN overlay for the EVPN instance**

```
OS10# show evpn vxlan-vni
VXLAN-VNI EVI Virtual-Network-Instance
100001 1 1
100010 2 2
```

### Display the BGP neighbors in the EVPN instances

```
OS10# show ip bgp neighbors 110.111.170.102
BGP neighbor is 110.111.170.102, remote AS 100, local AS 100 internal link
BGP version 4, remote router ID 110.111.170.102
BGP state ESTABLISHED, in this state for 04:02:59
Last read 00:21:21 seconds
Hold time is 180, keepalive interval is 60 seconds
Configured hold time is 180, keepalive interval is 60 seconds
Fall-over disabled

Received 311 messages
 2 opens, 2 notifications, 3 updates
 304 keepalives, 0 route refresh requests
Sent 307 messages
 4 opens, 0 notifications, 2 updates
 301 keepalives, 0 route refresh requests
Minimum time between advertisement runs is 30 seconds
Minimum time before advertisements start is 0 seconds
Capabilities received from neighbor for IPv4 Unicast:
 MULTIPROTO_EXT(1)
 ROUTE_REFRESH(2)
 CISCO_ROUTE_REFRESH(128)
 4 OCTET_AS(65)
 MP_L2VPN_EVPN
Capabilities advertised to neighbor for IPv4 Unicast:
 MULTIPROTO_EXT(1)
 ROUTE_REFRESH(2)
 CISCO_ROUTE_REFRESH(128)
 4 OCTET_AS(65)
 MP_L2VPN_EVPN
Prefixes accepted 1, Prefixes advertised 1
Connections established 2; dropped 0
Last reset never
Prefixes ignored due to:
 Martian address 0, Our own AS in AS-PATH 0
 Invalid Nexthop 0, Invalid AS-PATH length 0
 Wellknown community 0, Locally originated 0

Local host: 110.111.180.195, Local port: 43081
Foreign host: 110.111.170.102, Foreign port: 179
```

### Display the BGP L2VPN EVPN address family

```
OS10# show ip bgp l2vpn evpn
BGP local RIB : Routes to be Added , Replaced , Withdrawn
BGP local router ID is 110.111.170.102
Status codes: s suppressed, S stale, d dampened, h history, * valid, > best
Path source: I - internal, a - aggregate, c - confed-external,
r - redistributed/network, S - stale
Origin codes: i - IGP, e - EGP, ? - incomplete
 Network Next Hop Metric LocPrf Weight Path
*>r Route distinguisher: 110.111.170.102:65447
[3]:[0]:[32]:[110.111.170.102]/152 110.111.170.102 0 100 32768 ?
*> Route distinguisher: 110.111.170.107:64536
[3]:[0]:[32]:[110.111.170.107]/152 110.111.170.107 0 100 0 100 101 ?
```

### Display the EVPN routes for host MAC addresses

```
OS10# show evpn mac
Type -(lcl): Local (rmt): remote

EVI Mac-Address Type Seq-No Interface/Next-Hop
50 00:00:00:aa:aa:aa rmt 0 55.1.1.3
50 00:00:00:cc:cc:cc lcl 0 ethernet1/1/8:1

OS10# show evpn mac evi 50
Type -(lcl): Local (rmt): remote

EVI Mac-Address Type Seq-No Interface/Next-Hop
```

|    |                   |     |   |                 |
|----|-------------------|-----|---|-----------------|
| 50 | 00:00:00:aa:aa:aa | rmt | 0 | 55.1.1.3        |
| 50 | 00:00:00:cc:cc:cc | lcl | 0 | ethernet1/1/8:1 |

## VXLAN BGP EVPN routing

This section describes how EVPN implements overlay routing between L2 segments associated with EVIs belonging to the *same* tenant on a VTEP. *IETF draft draft-ietf-bess-evpn-inter-subnet-forwarding-05* describes EVPN inter-subnet forwarding, Integrated Routing and Bridging (IRB), and how to use EVPN with IP routing between L2 tenant domains.

You set up overlay routing by assigning a VRF to each tenant, creating a virtual-network interface, and assigning an IP subnet in the VRF to each virtual-network interface. The VTEP acts as the L3 gateway that routes traffic from one tenant subnet to another in the overlay before encapsulating it in the VXLAN header and transporting it over the underlay fabric. On virtual networks that associate with EVIs, EVPN IRB is enabled only after you create a virtual-network interface.

When you enable IRB for a virtual network/EVI, EVPN operation on each VTEP also advertises the local tenant IP-MAC bindings learned on the EVPN-enabled virtual networks to all other VTEPs. The local tenant IP-MAC bindings are learned from ARP or ICMPv6 protocol operation. They advertise as EVPN Type-2 BGP route updates to other VTEPs, each of whom then imports and installs them as ARP/IPv6 neighbor entries in the dataplane.

To enable efficient traffic forwarding on a VTEP, OS10 supports distributed gateway routing. A distributed gateway allows multiple VTEPs to act as the gateway router for a tenant subnet. The VTEP that is located nearest to a host acts as its gateway router.

To enable L3 gateway/IRB functionality for BGP EVPN, configure a VXLAN overlay network and enable routing on a switch:

1. Create a non-default VRF instance for overlay routing. For multi-tenancy, create a VRF instance for each tenant.
2. Configure globally the anycast gateway MAC address used by all VTEPs.
3. Configure a virtual-network interface for each virtual network, (optional) assign it to the tenant VRF, and configure an IP address. Then enable the interface.
4. Configure an anycast gateway IP address for each virtual network. OS10 supports distributed gateway routing.

EVPN supports different types of IRB routing for tenants, VMs, and servers, that connect to each VTEP:

- Centralized routing: For each tenant subnet, one VTEP is designated as the L3 gateway to perform IRB inter-subnet routing. All other VTEPs perform L2 bridging.
- Distributed routing: For each tenant subnet, all VTEPs perform L3 gateway routing for the tenant VMs and servers connected to a VTEP. In a large multi-tenant network, distributed routing allows for more efficient bandwidth use and traffic forwarding. IRB routing is performed either:
  - Only on an ingress VTEP.
  - On both ingress and egress VTEPs.

## Asymmetric IRB routing

In asymmetric IRB routing, IRB routing is performed only on ingress VTEPs. Egress VTEPs perform L2 bridging in the tenant subnet.

An ingress VTEP directly routes packets to a destination host MAC address in the destination virtual-network VNI. An egress VTEP only bridges packets to a host by removing the VXLAN header and forwarding a packet to the local Layer 2 domain using the VNI-to-VLAN mapping.

The ingress VTEP is configured with all destination virtual networks, and has the ARP entries and MAC addresses for all destination hosts in its hardware tables. Each VTEP learns the host MAC and MAC-to-IP bindings using ARP snooping for local addresses and type-2 route advertisements from remote VTEPs.

For VXLAN BGP EVPN examples that use asymmetric IRB, see [Example: VXLAN with BGP EVPN](#) and [Example: VXLAN BGP EVPN — Multiple AS topology](#).

## Symmetric IRB routing

In symmetric IRB routing, both ingress and egress VTEPs perform IRB routing and bridging for a tenant subnet. The ingress VTEP routes packets to an egress VTEP MAC address in an intermediate virtual-network VNI. The egress VTEP then routes the packet again to the destination host in the destination virtual-network VNI.

Using the L3 VNI associated with each tenant VRF, an ingress VTEP routes all traffic for the prefix to an egress VTEP on the L3 VNI. The egress VTEP routes from the L3 VNI to the destination virtual network or bridge domain. The L3 VNI does not have to

be associated with an IP address; routing is set up in the data plane using the egress VTEP's MAC address. This behavior is known as IP-VRF to IP-VRF interface-less routing.

The ingress VTEP does not have to be configured with every destination virtual network; it must have the ARP and MAC addresses only to the egress VTEP, not to each host connected to the VTEP. For this reason, symmetric IRB routing allows the overlay network to scale larger than asymmetric routing. Assign the same router MAC address to each VLT peer in a VTEP VLT domain.

Each VTEP learns host MAC and MAC-to-IP bindings using ARP snooping for local addresses, and type-2 and type-5 route advertisements from remote VTEPs. In addition to L3 VNI-connected networks, type-5 route advertisements communicate external routes from a border leaf VTEP to all other VTEPs.

For a VXLAN BGP EVPN example that uses symmetric IRB and Type-5 route, see [Example: VXLAN BGP EVPN — Symmetric IRB](#).

## Configure Symmetric IRB for VXLAN BGP EVPN

### Before you start

1. Follow the procedure in [Configure VXLAN](#) to:
  - Configure the VXLAN overlay network.
  - Enable routing for VXLAN virtual networks. Integrated Routing and Bridging (IRB) is automatically enabled.
  - Enable an overlay routing profile with the number of reserved ARP table entries for VXLAN overlay routing.
2. Follow the procedure in [Configure BGP EVPN for VXLAN](#) to:
  - Configure BGP to advertise EVPN routes.
  - Configure EVPN for VXLAN virtual networks.

For a sample configuration, see [Example: VXLAN with BGP EVPN](#).

### Configure symmetric IRB

1. (Optional) If the switch is a VTEP VLT peer, configure a local router MAC that is used by remote VTEPs as the destination address in VXLAN encapsulated packets sent to the switch in EVPN mode.

If you assign a unique VLT MAC address on each pair of VLT peers, use the same MAC address as the local router MAC. By default, the router MAC is derived as an offset from the local system MAC address.

In a VLT VTEP pair, the router MAC configured in both the VLT peers must be the same. Router MAC configuration is mandatory for VTEP VLT peers.

```
OS10(config)# evpn
OS10(config-evpn)# router-mac nn:nn:nn:nn:nn
```

2. Configure a non-default VRF with a dedicated VXLAN VNI for each tenant VRF in EVPN mode. The tenant VRF is created using the `ip vrf` command when you enable overlay routing with IRB; see [Enable overlay routing between virtual networks](#). The VXLAN VNI associated with the tenant VRF for EVPN symmetric IRB must be unique on the switch.

By default, the route distinguisher value is auto-generated. To reconfigure it, use the `rd A.B.C.D:[1-65535]` command. The route target value is a mandatory entry.

```
OS10(config-evpn)# vrf tenant-vrf-name
OS10(config-evpn-vrf-vrf-tenant)# vni vxlan-vni
OS10(config-evpn-vrf-vrf-tenant)# rd {A.B.C.D:[1-65535]}
OS10(config-evpn-vrf-vrf-tenant)# route-target {auto | value {import | export |
both} [asn4]}
OS10(config-evpn-vrf-vrf-tenant)# exit
```

3. (Optional) Advertise the IP prefixes learned from external networks and directly connected networks into EVPN type-5 route advertisements in EVPN-VRF mode; for example:

```
OS10(config)# evpn
OS10(config-evpn)# vrf vrf-tenant1
OS10(config-evpn-vrf-vrf-tenant1)# advertise {ipv4 | ipv6} {connected | static| ospf
| bgp} [route-map map-name]
```

- (Optional) To redistribute EVPN routes to a BGP or OSPF neighbor, configure the redistribution of L2VPN EVPN routes into BGP or OSPF IPv4/IPv6 routes on a border leaf VTEP in ROUTER-BGP or ROUTER-OSPF mode; for example:

```
OS10(config)# router bgp 101
OS10(conf-router-bgp-101)# vrf blue
OS10(conf-router-bgp-101-vrf)# address-family ipv4 unicast
OS10(configure-router-bgpv4-af)# redistribute l2vpn evpn [route-map map-name]
```

- Verify the VXLAN BGP EVPN with symmetric IRB configuration.

#### Display the EVPN instance configuration

```
OS10# show evpn evi 10000

EVI : 10000, State : up
 Bridge-Domain : Virtual-Network 10000, VNI 10000
 Route-Distinguisher : 1:110.111.170.195:10000(auto)
 Route-Targets : 0:10000:16787216(auto) both
 Inclusive Multicast : 110.111.170.107
 IRB : Enabled(VRF-TENANT-1)

OS10# show evpn evi 20000
EVI : 20000, State : up
 Bridge-Domain : Virtual-Network 20000, VNI 20000
 Route-Distinguisher : 1:110.111.170.195:20000(auto)
 Route-Targets : 0:20000:16797216(auto) both
 Inclusive Multicast :
 IRB : Enabled(VRF-TENANT-1)
```

#### Display the EVPN Type 2 routes for host MAC/IP addresses

```
show evpn mac-ip
Type -(lcl): Local (rmt): remote
EVI Mac Address Type Seq No Host-IP Interface/Next-Hops
10000 00:00:0b:0b:0b:0a lcl 0 10.10.10.10 ethernet1/1/6
10000 14:18:77:25:4e:82 rmt 0 10.10.10.11 110.111.170.107
```

#### Display the VRF instances used to forward EVPN routes in VXLAN overlay networks

```
OS10# show evpn vrf
VXLAN-VNI EVI Virtual-Network-Instance VRF-Name
30 30 30 vrf_30
40 40 40 vrf_40

OS10# show evpn vrf 13-vni
VRF : vrf_30, State : up
 L3-VNI : 3030
 Route-Distinguisher : 1:80.80.1.1:3030(auto)
 Route-Targets : 0:200:268438486(auto) both
 Remote VTEP : 4.4.4.4

VRF : vrf_40, State : up
 L3-VNI : 4040
 Route-Distinguisher : 1:80.80.1.1:4040(auto)
 Route-Targets : 0:200:268439496(auto) both
 Remote VTEP : 4.4.4.4

VRF : vrf_50, State : up
 L3-VNI : 5050
 Route-Distinguisher : 1:80.80.1.1:5050(auto)
 Route-Targets : 0:200:268430506(auto) both
 Remote VTEP : 4.4.4.4
```

#### Display the router MAC address used in overlay network for symmetric IRB

```
show evpn router-mac
Local Router MAC : 14:18:77:25:4e:4d

Remote-VTEP Router's-MAC
```

```
4.4.4.4 14:18:77:25:6f:4d
5.5.5.5 00:00:01:00:a3:b4
```

## Display the learned EVPN Type 5 routes

```
OS10# show ip bgp l2vpn evpn
BGP local RIB : Routes to be Added , Replaced , Withdrawn
BGP local router ID is 95.0.0.4
Status codes: s suppressed, S stale, d dampened, h history, * valid, > best
Path source: I - internal, a - aggregate, c - confed-external,
r - redistributed/network, S - stale
Origin codes: i - IGP, e - EGP, ? - incomplete
```

| Network                                                                                                | Next Hop | Metric | LocPrf | Weight    | Path |
|--------------------------------------------------------------------------------------------------------|----------|--------|--------|-----------|------|
| *>r Route distinguisher: 4.4.4.4:65001 VNI:65001<br>[5]:[0]:[24]:[11.11.11.0]:[0.0.0.0]/224            | 4.4.4.4  | 0      | 100    | 32768     | ?    |
| *>r Route distinguisher: 3.3.3.3:65002 VNI:65002<br>[5]:[0]:[24]:[12.12.12.0]:[0.0.0.0]/224            | 3.3.3.3  | 0      | 100    | 0 100 101 | ?    |
| *>r Route distinguisher: 4.4.4.4:101 VNI:101<br>[2]:[0]:[48]:[14:18:77:25:6f:4d]:[32]:[11.11.11.2]/224 | 4.4.4.4  | 0      | 100    | 32768     | ?    |
| *>r Route distinguisher: 3.3.3.3:102 VNI:102<br>[2]:[0]:[48]:[14:18:77:25:8f:6d]:[32]:[12.12.12.1]/224 | 3.3.3.3  | 0      | 100    | 0 100 101 | ?    |
| *> Route distinguisher: 3.3.3.3:101<br>[3]:[0]:[32]:[3.3.3.3]/152                                      | 3.3.3.3  | 0      | 100    | 0 100 101 | ?    |
| *>r Route distinguisher: 4.4.4.4:101<br>[3]:[0]:[32]:[4.4.4.4]/152                                     | 4.4.4.4  | 0      | 100    | 32768     | ?    |
| *>r Route distinguisher: 4.4.4.4:102<br>[3]:[0]:[32]:[4.4.4.4]/152                                     | 4.4.4.4  | 0      | 100    | 32768     | ?    |

```
OS10# show ip route vrf blue
Codes: C - connected
S - static
B - BGP, IN - internal BGP, EX - external BGP, EV - EVPN BGP
O - OSPF, IA - OSPF inter area, N1 - OSPF NSSA external type 1,
N2 - OSPF NSSA external type 2, E1 - OSPF external type 1,
E2 - OSPF external type 2, * - candidate default,
+ - summary route, > - non-active route
Gateway of last resort is not set
```

| Destination        | Gateway                              | Dist/Metric | Last Change    |
|--------------------|--------------------------------------|-------------|----------------|
| C 11.11.11.0/24    | via 11.11.11.1<br>virtual-network101 | 0/0         | 1 day 02:54:39 |
| B EV 15.15.15.2/32 | via 4.4.4.4                          | 200/0       | 1 day 02:09:19 |
| B EV 15.15.15.0/24 | via 4.4.4.4                          | 200/0       | 1 day 02:09:19 |
| B EV 11.11.11.2/32 | via 4.4.4.4                          | 100/0       | 1 day 05:10:11 |
| B EV 12.12.12.0/24 | via 3.3.3.3                          | 100/0       | 1 day 00:10:01 |

## BGP EVPN with VLT

OS10 supports BGP EVPN operation between VLT peers that you configure as VTEPs. For more information about configurations and best practices to set up VLT for VXLAN, see [Configure VXLAN — Configure VLT](#). This information also applies to BGP EVPN for VXLAN.

Dell EMC recommends configuring iBGP peering for the IPv4 address family between the VTEPs in a VLT pair on a dedicated L3 VLAN that is used when connectivity to the underlay L3 network is lost. It is NOT required to enable the EVPN address family on the iBGP peering session between the VTEPs in a VLT pair because EVPN peering to the spine switch is performed on Loopback interfaces.



Both VTEPs in a VLT pair advertise identical EVPN routes, which provides redundancy if one of the VTEP peers fails. To set up redundant EVPN route advertisement, configure the same EVI, RD, and RT values for each VNI on both VTEPs in a VLT pair, including:

- In auto-EVI mode, this identical configuration is automatically ensured if the VNID-to-VNI association is the same on both VTEP peers.
- In manual EVI mode, you must configure the same EVI-to-VNID association on both VTEP peers.
- In manual EVI mode, you must configure the same RD and RT values on both VTEP peers.

In an EVPN configuration, increase the VLT delay-restore timer to allow for BGP EVPN adjacency to establish and for the remote MAC and neighbor entries to download by EVPN and install in the dataplane. The VLT delay-restore determines the amount of time the VLT LAGs are kept operationally down at bootup to allow the dataplane to set up and forward traffic, resulting in minimal traffic loss as the VLT peer node boots up and joins the VLT domain.

For a sample BGP EVPN VLT configuration, see [Example: VXLAN with BGP EVPN](#).

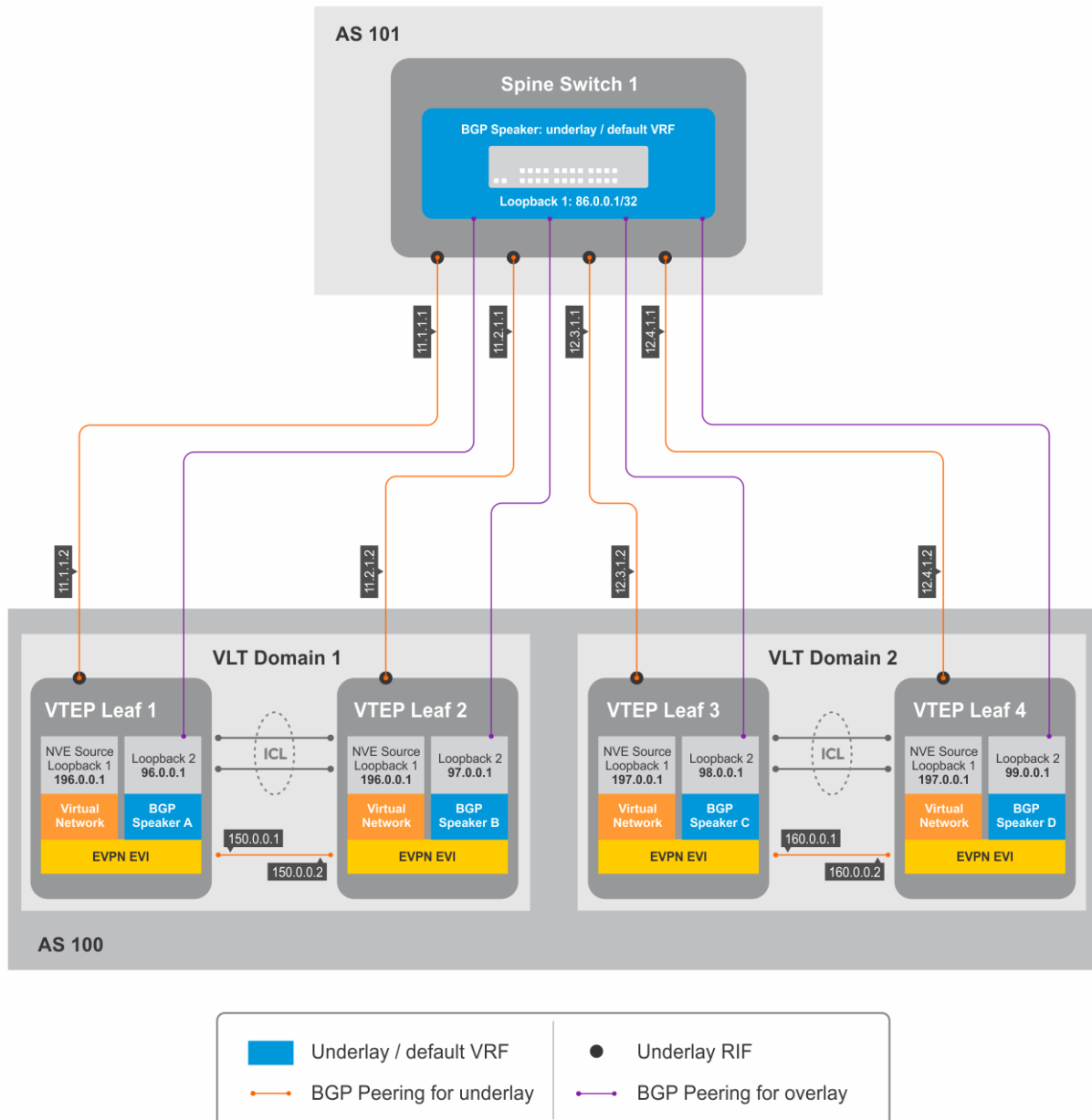

Figure 14. BGP EVPN in VLT domain

## VXLAN BGP commands

### activate (l2vpn evpn)

Enables the exchange of L2 VPN EVPN address family information with a BGP neighbor or peer group.

|                           |                                                                                                                                                                                                                                                              |
|---------------------------|--------------------------------------------------------------------------------------------------------------------------------------------------------------------------------------------------------------------------------------------------------------|
| <b>Syntax</b>             | <code>activate</code>                                                                                                                                                                                                                                        |
| <b>Parameters</b>         | None                                                                                                                                                                                                                                                         |
| <b>Default</b>            | Not configured                                                                                                                                                                                                                                               |
| <b>Command Mode</b>       | ROUTER-BGP-NEIGHBOR-AF                                                                                                                                                                                                                                       |
| <b>Usage Information</b>  | Use this command to exchange L2 VPN EVPN address information for VXLAN host-based routing with a BGP neighbor. The IPv4 unicast address family is enabled by default. Use the <code>no activate</code> command to disable an address family with a neighbor. |
| <b>Example</b>            | <pre>OS10(conf-router-neighbor)# address-family l2vpn evpn unicast OS10(conf-router-bgp-neighbor-af)# activate</pre>                                                                                                                                         |
| <b>Supported Releases</b> | 10.2.0E or later                                                                                                                                                                                                                                             |

### address-family l2vpn evpn

Configures the L2 VPN EVPN address family for VXLAN host-based routing to a BGP neighbor.

|                           |                                                                                                                                                               |
|---------------------------|---------------------------------------------------------------------------------------------------------------------------------------------------------------|
| <b>Syntax</b>             | <code>address-family l2vpn evpn</code>                                                                                                                        |
| <b>Parameters</b>         | None                                                                                                                                                          |
| <b>Default</b>            | Not configured                                                                                                                                                |
| <b>Command mode</b>       | ROUTER-NEIGHBOR                                                                                                                                               |
| <b>Usage information</b>  | To use BGP EVPN service in a VXLAN, you must configure and enable the L2VPN EVPN address family on a VTEP to support host-based routing to each BGP neighbor. |
| <b>Example</b>            | <pre>OS10(config)# router bgp 100 OS10(config-router-bgp-100)# neighbor 45.0.0.1 OS10(config-router-neighbor)# address-family l2vpn evpn</pre>                |
| <b>Supported releases</b> | 10.4.2.0 or later                                                                                                                                             |

### allowas-in

Configures the number of times the local AS number can appear in the BGP AS\_PATH path attribute before the switch rejects the route.

|                          |                                                                                                                                                                                                                                       |
|--------------------------|---------------------------------------------------------------------------------------------------------------------------------------------------------------------------------------------------------------------------------------|
| <b>Syntax</b>            | <code>allowas-in as-number</code>                                                                                                                                                                                                     |
| <b>Parameters</b>        | <code>as-number</code> —Enter the number of occurrences for a local AS number, from 1 to 10.                                                                                                                                          |
| <b>Default</b>           | Disabled                                                                                                                                                                                                                              |
| <b>Command Mode</b>      | ROUTER-BPG-NEIGHBOR-AF                                                                                                                                                                                                                |
| <b>Usage Information</b> | Use this command to enable the BGP speaker to accept a route with the local AS number in updates received from a peer for the specified number of times. The <code>no</code> version of this command resets the value to the default. |

### Example (IPv4)

```
OS10(config-router-neighbor)# address-family ipv4 unicast
OS10(conf-router-bgp-neighbor-af)# allowas-in 5
```

### Example (IPv6)

```
OS10(conf-router-template)# address-family ipv6 unicast
OS10(conf-router-bgp-template-af)# allowas-in 5
```

### Example (L2vpn)

```
OS10(config-router-neighbor)# address-family l2vpn evpn
OS10(config-router-bgp-neighbor-af)# allowas-in 3
```

**Supported Releases** 10.3.0E or later

## sender-side-loop-detection

Enables the sender-side loop detection process for a BGP neighbor.

**Syntax** sender-side-loop-detection

**Parameters** None

**Default** Enabled

**Command Mode** ROUTER-BGP-NEIGHBOR-AF

**Usage Information** This command helps detect routing loops, based on the AS path before it starts advertising routes. To configure a neighbor to accept routes use the `neighbor allowas-in` command. The `no` version of this command disables sender-side loop detection for that neighbor.

### Example (IPv4)

```
OS10(conf-router-bgp-102)# neighbor 3.3.3.1
OS10(conf-router-neighbor)# address-family ipv4 unicast
OS10(conf-router-bgp-neighbor-af)# sender-side-loop-detection
```

### Example (IPv6)

```
OS10(conf-router-bgp-102)# neighbor 32::1
OS10(conf-router-neighbor)# address-family ipv6 unicast
OS10(conf-router-bgp-neighbor-af)# no sender-side-loop-detection
```

**Supported Releases** 10.3.0E or later

## show ip bgp l2vpn evpn

Displays the internal BGP routes in the L2VPN EVPN address family in EVPN instances.

**Syntax** show ip bgp l2vpn evpn [summary | neighbors [*ip-address* | interface *interface-type*]]

**Parameters**

- summary** Displays a summary of the BGP routes in the L2VPN address family that exchange with remote VTEPs.
- neighbors** Display the remote VTEPs with whom BGP routes in the L2VPN address family exchange.
- ip-address** Displays information about a specific neighbor.
- interface interface-type** Displays BGP information that is learned through an unnumbered neighbor.

**Default** Not configured

**Command mode** EXEC

## Usage information

Use this command to display the BGP routes used for the L2VPN EVPN address family in EVPN instances on the switch.

## Examples

```
OS10# show ip bgp l2vpn evpn
BGP local RIB : Routes to be Added , Replaced , Withdrawn
BGP local router ID is 110.111.170.102
Status codes: s suppressed, S stale, d dampened, h history, * valid, >
best
Path source: I - internal, a - aggregate, c - confed-external,
r - redistributed/network, S - stale
Origin codes: i - IGP, e - EGP, ? - incomplete
 Network Next Hop Metric LocPrf
Weight Path
*>r Route distinguisher: 110.111.170.102:65447
[3]:[0]:[32]:[110.111.170.102]/152 110.111.170.102 0 100
32768 ?
*> Route distinguisher: 110.111.170.107:64536
[3]:[0]:[32]:[110.111.170.107]/152 110.111.170.107 0 100
0 100 101 ?
```

```
OS10# show ip bgp l2vpn evpn summary
BGP router identifier 2.2.2.2 local AS number 4294967295
Neighbor AS MsgRcvd MsgSent Up/Down State/
Pfx
3.3.3.3 4294967295 2831 9130 05:57:27 504
4.4.4.4 4294967295 2364 9586 05:56:43 504
5.5.5.5 4294967295 4947 8399 01:10:39 11514
6.6.6.6 4294967295 2413 7310 05:51:56 504
```

```
OS10# show ip bgp l2vpn evpn neighbors
BGP neighbor is 3.3.3.3, remote AS 4294967295, local AS 4294967295
internal link
```

```
 BGP version 4, remote router ID 3.3.3.3
 BGP state ESTABLISHED, in this state for 06:21:55
 Last read 00:37:43 seconds
 Hold time is 180, keepalive interval is 60 seconds
 Configured hold time is 180, keepalive interval is 60 seconds
 Fall-over disabled
 Route reflector client
```

```
 Received 2860 messages
 1 opens, 0 notifications, 2422 updates
 437 keepalives, 0 route refresh requests
 Sent 32996 messages
 1 opens, 0 notifications, 32565 updates
 430 keepalives, 0 route refresh requests
 Minimum time between advertisement runs is 30 seconds
 Minimum time before advertisements start is 0 seconds
```

```
 Capabilities received from neighbor for IPv4 Unicast:
 ROUTE_REFRESH(2)
 CISCO_ROUTE_REFRESH(128)
 4_OCTET_AS(65)
 MP_L2VPN_EVPN(1)
 Capabilities advertised to neighbor for IPv4 Unicast:
 ROUTE_REFRESH(2)
 CISCO_ROUTE_REFRESH(128)
 4_OCTET_AS(65)
 MP_L2VPN_EVPN(1)
```

```
 Prefixes accepted 504, Prefixes advertised 13012
 Connections established 1; dropped 0
 Last reset never
 Local host: 2.2.2.2, Local port: 37853
 Foreign host: 3.3.3.3, Foreign port: 179
 <Output Truncated>
```

```
OS10# show ip bgp l2vpn evpn neighbors interface vlan 30
```

```
BGP neighbor is fe80::76e6:e2ff:fef6:99a9 via vlan30, remote AS 100,
local AS 200 external link
```

```
BGP version 4, remote router ID 125.12.57.117
```

```
BGP state ESTABLISHED, in this state for 00:15:52
```

```
Last read 00:21:08 seconds
```

```
Hold time is 180, keepalive interval is 60 seconds
```

```
Configured hold time is 180, keepalive interval is 60 seconds
```

```
Fall-over disabled
```

```
Received 20 messages
```

```
1 opens, 0 notifications, 0 updates
```

```
19 keepalives, 0 route refresh requests
```

```
Sent 20 messages
```

```
1 opens, 1 notifications, 0 updates
```

```
18 keepalives, 0 route refresh requests
```

```
Minimum time between advertisement runs is 30 seconds
```

```
Minimum time before advertisements start is 0 seconds
```

```
Capabilities received from neighbor for IPv4 Unicast:
```

```
MULTIPROTO_EXT(1)
```

```
ROUTE_REFRESH(2)
```

```
CISCO_ROUTE_REFRESH(128)
```

```
4_OCTET_AS(65)
```

```
MP_L2VPN_EVPN(1)
```

```
Extended Next Hop Encoding (5)
```

```
Capabilities advertised to neighbor for IPv4 Unicast:
```

```
MULTIPROTO_EXT(1)
```

```
ROUTE_REFRESH(2)
```

```
CISCO_ROUTE_REFRESH(128)
```

```
4_OCTET_AS(65)
```

```
MP_L2VPN_EVPN(1)
```

```
Extended Next Hop Encoding (5)
```

```
Prefixes accepted 0, Prefixes advertised 0
```

```
Connections established 1; dropped 0
```

```
Last reset never
```

```
Prefixes ignored due to:
```

```
Martian address 0, Our own AS in AS-PATH 0
```

```

Invalid Nexthop 0, Invalid AS-PATH length 0

Wellknown community 0, Locally originated 0

Local host: fe80::76e6:e2ff:fef5:a43e, Local port: 45926

Foreign host: fe80::76e6:e2ff:fef6:99a9, Foreign port: 179

```

```

OS10# show ip bgp l2vpn evpn summary
BGP router identifier 89.101.17.125 local AS number 100
Neighbor AS
MsgRcvd MsgSent Up/Down State/Pfx
ethernet1/1/1 19 00:15:34 200
19 19 00:15:34 0

```

**Supported releases** 10.4.2.0 or later

## VXLAN EVPN commands

### advertise

Advertises the IP prefixes learned from external networks and directly connected neighbors into EVPN.

**Syntax** `advertise {ipv4 | ipv6} {connected | static | ospf | bgp} [route-map map-name]`

- Parameters**
- `ipv4` — Advertise learned IPv4 routes.
  - `ipv6` — Advertise learned IPv6 routes.
  - `connected` — Advertise routes learned from directly connected neighbors.
  - `static` — Advertise manually configured routes.
  - `ospf` — Advertise OSPF routes into EVPN.
  - `bgp` — Advertise BGP learned external routes into EVPN.
  - `route-map map-name` — (Optional) Filter EVPN Type-5 advertised routes using the specified route map.

**Default** None

**Command Mode** EVPN-VRF

**Usage Information** EVPN uses Type 5 route advertisements. To specify the types of learned routes to use in EVPN Type 5 advertisements in a tenant VRF, use the `advertise` command.

**Example**

```

OS10(config)# evpn
OS10(config-evpn)# vrf vrf-blue
OS10(config-evpn-vrf-vrf-blue)# advertise ipv4 connected route-map map-connected

```

**Supported Releases** 10.5.1 or later

### auto-evi

Creates an EVPN instance automatically, including Route Distinguisher (RD) and Route Target (RT) values.

**Syntax** `auto-evi`

**Parameters** None

**Default** Not configured

**Command mode** EVPN

**Usage information** In deployments running BGP with 2-byte or 4-byte autonomous systems, auto-EVI automatically creates EVPN instances when you create a virtual network on a VTEP in the overlay network. In auto-EVI mode, the RD and RT values automatically generate:

- For a 2-byte autonomous system:
  - The RD auto-configures as Type 1 from the overlay network source IP address and the auto-generated EVI index.
  - The RT auto-configures as Type 0 from the 2-byte AS and the 3-byte VNI—Type encoded as 0x0002.
- For a 4-byte autonomous system:
  - The RD auto-configures as Type 1 from the overlay network source IP address and the auto-generated EVI index.
  - The RT auto-configures as Type 2 from the 4-byte AS and the 2-byte EVI—Type encoded as 0x0202.

**Example**

```
OS10(config)# evpn
OS10(config-evpn)# auto-evi
```

**Supported releases** 10.4.2.0 or later

## disable-rt-asn

Sets the ASN value to 0 in auto-derived route targets.

**Syntax** `disable-rt-asn`

**Parameters** None

**Default** Not configured

**Command mode** EVPN

**Usage information** In a Clos leaf-spine topology, if you configure the leaf nodes (VTEPs) in separate ASNs, the system cannot use the route targets that are automatically generated using the `auto-evi` or `route-target auto` commands. The route target includes the ASN and the route targets derived on each of the leaf nodes differ from one another.

In such eBGP EVPN scenarios, use the `disable-rt-asn` command to automatically provision route targets in the leaf nodes. When you use this command, the `export route-target` has the ASN value set to 0 and ensures that identical route targets are generated on all the leaf nodes. The leaf VTEPs can import EVPN routes only based on VNI, even though the leaf VTEPs are on different ASNs.

This command is applicable when you use the `auto-evi` or `route-target auto` commands for EVIs, symmetric IRB VRFs, or both.

Note: You must manually configure the route target and set the ASN value to 0 in other vendor switches that do not support the `disable-rt-asn` feature.

**Example 1**

```
OS10(config)# evpn
OS10(config-evpn)# auto-evi
OS10(config-evpn)# disable-rt-asn
```

**Example 2**

```
OS10(config)# evpn
OS10(config-evpn)# disable-rt-asn
OS10(config-evpn)# evi 1001
OS10(config-evpn-evi-1001)# route-target auto
OS10(config-evpn)# vrf BLUE
OS10(config-evpn-vrf-BLUE)# vni 64001
OS10(config-evpn-vrf-BLUE)# route-target auto
OS10(config-evpn-vrf-BLUE)#
```

**Supported releases** 10.5.1.0 or later

## evi

Creates an EVPN instance (EVI) in EVPN mode.

**Syntax** `evi id`

**Parameters** `id` Enter the EVPN instance ID, from 1 to 65535.

**Default** Not configured

**Command mode** EVPN

**Usage information** If an MP-BGP network uses 4-byte autonomous systems or to specify the RD and RT values, manually configure EVPN instances and associate each EVI with the overlay VXLAN virtual network. The EVI activates only when you configure the VXLAN network ID (VNI), RD, RT, and virtual network.

### Example

```
OS10(config)# evpn
OS10(config-evpn)# evi 10
OS10(config-evpn-evi)#
```

**Supported releases** 10.4.2.0 or later

## evpn

Enables the EVPN control plane for VXLAN.

**Syntax** `evpn`

**Parameters** None

**Default** Not configured

**Command mode** CONFIGURATION

**Usage information** Enabling EVPN triggers BGP to advertise EVPN capability with AFI=25 and SAFI=70 to all BGP peers in an autonomous system. The `no` version of this command disables EVPN on the switch.

### Example

```
OS10(config)# evpn
OS10(config-evpn)#
```

**Supported releases** 10.4.2.0 or later

## rd

Configures the Route Distinguisher (RD) value that EVPN routes use.

**Syntax** `rd {A.B.C.D:[1-65535] | auto}`

**Parameters** **A.B.C.D:** Manually configure the RD with a 4-octet IPv4 address, then a 2-octet-number from 1 to 65535.  
**[1-65535]**  
**auto** Configure the RD to automatically generate.

**Default** Not configured

**Command mode** EVPN-EVI and EVPN-VRF



## Usage information

A RD maintains the uniqueness of an EVPN route between different EVPN instances. Configure a route distinguisher in a tenant VRF used for EVPN symmetric IRB traffic. The RD auto-configures as Type 1 from the overlay network source IP address and the auto-generated EVPN instance ID.

The `rd auto` command is not supported in EVPN-VRF mode. When you create a VRF in EVPN mode, the RD is automatically generated. The `rd A.B.C.D:[1-65535]` command is supported in EVPN-VRF mode in 10.5.1 and later releases.

## Example

```
OS10(config)# evpn
OS10(config-evpn)# evi 10
OS10(config-evpn-evi)# vni 10000
OS10(config-evpn-evi)# rd 111.111.111.111:65535
```

```
OS10(config)# evpn
OS10(config-evpn)# vrf vrf-blue
OS10(config-evpn-vrf-vrf-blue)# rd 111.111.111.111:65000
```

## Supported releases

10.4.2.0 or later

## redistribute l2vpn evpn

Redistributes L2VPN EVPN routes into BGP and OSPF IPv4/IPv6 routes.

### Syntax

```
redistribute l2vpn evpn [route-map map name]
```

### Parameters

- `route-map map-name` — (Optional) Filter the L2VPN EVPN routes that are redistributed in BGP and OSPF.

### Default

None

### Command Mode

ROUTER-BGPv4-AF, ROUTER-BGPv6-AF, ROUTER-OSPF, or ROUTER-OSPFv6

### Usage Information

Use the `redistribute l2vpn evpn` command to redistribute the L2VPN EVPN routes learned in non-default tenant VRFs for BGP and or OSPF IPv4/IPv6 routing.

## Example

```
OS10(config)# router bgp 101
OS10(conf-router-bgp-101)# vrf blue
OS10(conf-router-bgp-101-vrf)# address-family ipv4 unicast
OS10(configure-router-bgpv4-af)# redistribute l2vpn evpn
```

```
OS10(config)# router ospf 1 vrf GREEN
OS10(config-router-ospf-1)# redistribute l2vpn evpn
```

```
OS10(config)# router ospfv3 2 vrf GREEN
OS10(config-router-ospfv3-2)# redistribute l2vpn evpn
```

## Supported Releases

10.5.1 or later

## route-target

Configures the Route Target (RT) values that EVPN routes use.

### Syntax

```
route-target {auto | value {import | export | both} [asn4]}
```

### Parameters

**value {import | export | both}** Configure an RT import or export value, or both values in the format `2-octet-ASN:4-octet-number` or `4-octet-ASN:2-octet-number`.

- The `2-octet` ASN or number is 1 to 65535.
- The `4-octet` ASN or number is 1 to 4294967295.

**auto** Configure the RT import and export values to automatically generate.  
**asn4** (Optional) Advertises a 4-byte AS number in RT values.

**Default** Not configured

**Command mode** EVPN-EVI and EVPN-VRF

**Usage information** A RT determines how EVPN routes distribute among EVPN instances. Configure each RT with an import and export value. When the EVPN routes advertise, the RT export value configured for export attaches to each route. The receiving VTEP compares a route export value with the local RT import value. If the values match, the routes download and install on the VTEP.

- For 2-byte autonomous systems, the RT auto-configures as Type 0 from the 2-byte AS and the 3-byte VNI—Type encoded as 0x0002.
- For 4-byte autonomous systems, the RT auto-configures as Type 2 from the 4-byte AS and the 2-byte EVI—Type encoded as 0x0202.

Configure a route target in a tenant VRF used for EVPN symmetric IRB traffic. The `route-target` command is supported in EVPN-VRF mode in 10.5.1 and later releases. In EVPN-VRF command mode, the manual route-target configuration should be unique across VRFs.

### Example

```
OS10(config)# evpn
OS10(config-evpn)# evi 10
OS10(config-evpn-evi)# vni 10000
OS10(config-evpn-evi)# rd 111.111.111.111:65535
OS10(config-evpn-evi)# route-target 1:3 both
```

```
OS10(config)# evpn
OS10(config-evpn)# vrf vrf-blue
OS10(config-evpn-vrf-vrf-blue)# route-target auto
```

**Supported releases** 10.4.2.0 or later

## router-mac

Configure the local router MAC address that is used by remote VTEPs as the destination address in VXLAN encapsulated packets sent to the switch.

**Syntax** `router-mac mac-address`

**Parameters** **mac-address** Enter the MAC address in `nn:nn:nn:nn:nn:nn` format.

**Default** Not configured

**Command mode** EVPN

**Usage information** The EVPN router MAC address is encoded in the router's MAC extended community in MAC/IP Type 2 and IP-prefix Type 5 route updates. It also serves as the destination MAC address in VXLAN encapsulated packets sent to the switch. In a VLT domain, configure the same router MAC address on both VLT VTEP peers.

### Example

```
OS10(config-evpn)# router-mac 00:01:02:03:04:05
```

**Supported releases** 10.5.1 or later

## show evpn evi

Displays the configuration settings of EVPN instances.

**Syntax** `show evpn evi [id]`

**Parameters** *id* — (Optional) Enter the EVPN instance ID, from 1 to 65535.

**Default** Not configured

**Command mode** EXEC

**Usage information** Use this command to verify EVPN instance status, associated VXLAN virtual networks and the RD and RT values the BGP EVPN routes use in the EVI. The status of integrated routing and bridging (IRB) and the VRF used for EVPN traffic also display.

**Example**

```
OS10# show evpn evi 101
EVI : 101, State : up
Bridge-Domain : Virtual-Network 101, VNI 101
Route-Distinguisher : 1:95.0.0.4:101(auto)
Route-Targets : 0:101:268435556(auto) both
Inclusive Multicast : 95.0.0.3
IRB : Enabled(VRF: default)
```

**Supported releases** 10.4.2.0 or later

## show evpn mac

Displays BGP EVPN routes for host MAC addresses.

**Syntax** `show evpn mac {count | mac-address nn.nn.nn.nn | evi id [mac-address nn.nn.nn.nn | count | next-hop ip-address count]}`

- Parameters**
- `count` — Displays the total number of local and remote host MAC addresses in EVPN instances.
  - `mac-address nn.nn.nn.nn` — Displays the BGP EVPN routes for a specific 48-bit host MAC address.
  - `evi id` — Displays the host MAC addresses and next hops in a specified EVPN instance, from 1 to 65535. To filter the output, display information on the host MAC address count for an EVPN ID or for a next-hop IP address, and BGP routes for a specified MAC address.

**Default** Not configured

**Command mode** EXEC

**Usage information** Use this command to display the BGP routes for host MAC addresses in EVPN instances. The type 2 routes received from the remote VTEP is displayed only if there is a corresponding EVI configured locally.

**Examples**

```
OS10# show evpn mac
Type -(lcl): Local (rmt): remote

EVI Mac-Address Type Seq-No Interface/Next-Hop
50 00:00:00:aa:aa:aa rmt 0 55.1.1.3
```

```
OS10# show evpn mac count

Total MAC Entries :
 Local MAC Address Count : 2
 Remote MAC Address Count : 5
```

```
OS10# show evpn mac evi 811 count

EVI 811 MAC Entries :
 Local MAC Address Count : 1
 Remote MAC Address Count : 2
```

```
OS10# show evpn mac evi 811 next-hop 80.80.1.8 count
```

```
EVI 811 next-hop 80.80.1.8 MAC Entries :
Remote MAC Address Count : 2
```

**Supported releases** 10.4.2.0 or later

## show evpn mac-ip

Displays the BGP EVPN Type 2 routes used for host MAC-IP address binding.

**Syntax** `show evpn mac-ip [count | evi evi [mac-address mac-address] | mac-address mac-address | next-hop ip-address]`

- Parameters**
- `count` — Displays the total number of MAC addresses in EVPN MAC-IP address binding.
  - `evi evi` — Enter an EVPN instance ID, from 1 to 65535.
  - `host ip-address` — Enter the IP address of a host that communicates through EVPN routes.
  - `mac-address mac-address` — Enter the MAC address of a host that communicates through EVPN routes in the format `nn:nn:nn:nn:nn`.
  - `next-hop ip-address` — Enter the IP address of a next-hop switch.

**Default** Not configured

**Command mode** EXEC

**Usage information** Use this command to view the MAC-IP address binding for host communication in VXLAN tenant segments. The type 2 routes received from the remote VTEP is displayed only if there is a corresponding EVI configured locally.

### Example

```
OS10# show evpn mac-ip

Type -(lcl): Local (rmt): remote

EVI Mac-Address Type Seq-No Host-IP Interface/Next-Hop
101 14:18:77:0c:e5:a3 rmt 0 11.11.11.3 95.0.0.5
101 14:18:77:0c:e5:a3 rmt 0 2001:11::11:3 95.0.0.5
101 14:18:77:25:4e:84 rmt 0 55.55.55.1 95.0.0.3
101 14:18:77:25:6f:84 lcl 0 11.11.11.2 95.0.0.3
101 14:18:77:25:6f:84 lcl 0 2001:11::11:2 95.0.0.3
102 14:18:77:0c:e5:a4 rmt 0 12.12.12.3 95.0.0.5
102 14:18:77:0c:e5:a4 rmt 0 2001:12::12:3 95.0.0.5
102 14:18:77:25:4d:b9 rmt 0 12.12.12.1 95.0.0.3
102 14:18:77:25:6e:b9 lcl 0 12.12.12.2 95.0.0.3
103 14:18:77:25:4e:84 rmt 0 13.13.13.1 95.0.0.3
103 14:18:77:25:4e:84 rmt 0 2001:13::13:1 95.0.0.3
103 14:18:77:25:6f:84 lcl 0 13.13.13.2 95.0.0.3
103 14:18:77:25:6f:84 lcl 0 2001:13::13:2 95.0.0.3
104 14:18:77:25:4d:b9 rmt 0 14.14.14.1 95.0.0.3
104 14:18:77:25:4d:b9 rmt 0 2001:14::14:1 95.0.0.3
104 14:18:77:25:6e:b9 lcl 0 14.14.14.2 95.0.0.3
104 14:18:77:25:6e:b9 lcl 0 2001:14::14:2 95.0.0.3
105 14:18:77:25:4d:b9 rmt 0 15.15.15.1 95.0.0.3
105 14:18:77:25:4d:b9 rmt 0 2001:15::15:1 95.0.0.3
105 14:18:77:25:6e:b9 lcl 0 15.15.15.2 95.0.0.3
105 14:18:77:25:6e:b9 lcl 0 2001:15::15:2 95.0.0.3
106 14:18:77:25:4e:84 rmt 0 16.16.16.1 95.0.0.3
106 14:18:77:25:4e:84 rmt 0 2001:16::16:1 95.0.0.3
106 14:18:77:25:6f:84 lcl 0 16.16.16.2 95.0.0.3
106 14:18:77:25:6f:84 lcl 0 2001:16::16:2 95.0.0.3
```

```
OS10# show evpn mac-ip evi 104

Type -(lcl): Local (rmt): remote

EVI Mac-Address Type Seq-No Host-IP Interface/Next-Hop
```

```

104 14:18:77:25:4d:b9 rmt 0 14.14.14.1 95.0.0.3
104 14:18:77:25:4d:b9 rmt 0 2001:14::14:1 95.0.0.3
104 14:18:77:25:6e:b9 lcl 0 14.14.14.2
104 14:18:77:25:6e:b9 lcl 0 2001:14::14:2

```

```
OS10# show evpn mac-ip evi 101 mac-address 14:18:77:0c:e5:a3
```

```
Type -(lcl): Local (rmt): remote
```

| EVI | Mac-Address       | Type | Seq-No | Host-IP       | Interface/Next-Hop |
|-----|-------------------|------|--------|---------------|--------------------|
| 101 | 14:18:77:0c:e5:a3 | rmt  | 0      | 11.11.11.3    | 95.0.0.5           |
| 101 | 14:18:77:0c:e5:a3 | rmt  | 0      | 2001:11::11:3 | 95.0.0.5           |

```
OS10# show evpn mac-ip mac-address 14:18:77:25:4e:84
```

```
Type -(lcl): Local (rmt): remote
```

| EVI | Mac-Address       | Type | Seq-No | Host-IP       | Interface/Next-Hop |
|-----|-------------------|------|--------|---------------|--------------------|
| 101 | 14:18:77:25:4e:84 | rmt  | 0      | 55.55.55.1    | 95.0.0.3           |
| 103 | 14:18:77:25:4e:84 | rmt  | 0      | 13.13.13.1    | 95.0.0.3           |
| 103 | 14:18:77:25:4e:84 | rmt  | 0      | 2001:13::13:1 | 95.0.0.3           |
| 106 | 14:18:77:25:4e:84 | rmt  | 0      | 16.16.16.1    | 95.0.0.3           |
| 106 | 14:18:77:25:4e:84 | rmt  | 0      | 2001:16::16:1 | 95.0.0.3           |

**Supported releases**

10.4.3.0 or later

## show evpn router-mac remote-vtep

Displays both the local and remote router MAC addresses used in symmetric IRB.

**Syntax** `show evpn router-mac {router-vtep [vtep-ip-address]}`

**Parameters** `vtep-ip-address` — (Optional) Enter the IP address of a remote VTEP.

**Default** Not configured

**Command mode** EXEC

**Usage information** Use the `show evpn router-mac remote-vtep` command to display the router MAC address used on the switch and on specified remote VTEPs. Use the `router-mac` command to create a local router MAC address. The `show evpn router-mac` command displays the local router mac and router mac of all remote VTEPs. The `show evpn router-mac remote-vtep [vtep-ip-address]` command displays router mac of specified remote VTEP.

**Example**

```

OS10# show evpn router-mac

Local Router MAC : 14:18:77:25:4e:4d

Remote-VTEP Router's-MAC
4.4.4.4 14:18:77:25:6f:4d
5.5.5.5 00:00:01:00:a3:b4

```

**Supported releases**

10.5.1.0 or later

## show evpn vrf

Displays the VRF instances used to forward EVPN routes in VXLAN overlay networks.

**Syntax** `show evpn vrf [vrf-name]`

**Parameters** `vrf-name` — (Optional) Enter the name of a non-default tenant VRF instance.

**Default** Not configured

**Command mode** EXEC

**Usage information** Use this command to verify the tenant VRF instances used in EVPN instances to exchange BGP EVPN routes in VXLANs.

**Example**

```
show evpn vrf

VXLAN-VNI EVI Virtual-Network-Instance VRF-Name
102 102 102 blue
103 103 103 default
104 104 104 blue
106 106 106 default
105 105 105 blue
101 101 101 default
```

**Supported releases** 10.4.3.0 or later

## show evpn vrf l3-vni

Displays the configuration of the tenant VRF instances used for symmetric IRB.

**Syntax** show evpn vrf l3-vni [*tenant-vrf-name*]

**Parameters** *tenant-vrf-name* — (Optional) Enter the name of a non-default tenant VRF instance.

**Default** Not configured

**Command mode** EXEC

**Usage information** Use the show evpn vrf l3-vni command to display the configuration settings of each tenant VRF with its unique VXLAN VNI. Use the show evpn vrf command to display the tenant VRF instances used to exchange BGP EVPN routes in VXLANs.

**Example**

```
OS10# show evpn vrf l3-vni

VRF : vrf_30, State : up
L3-VNI : 3030
Route-Distinguisher : 1:80.80.1.1:3030(auto)
Route-Targets : 0:200:268438486(auto) both
Remote VTEP : 4.4.4.4

VRF : vrf_40, State : up
L3-VNI : 4040
Route-Distinguisher : 1:80.80.1.1:4040(auto)
Route-Targets : 0:200:268439496(auto) both
Remote VTEP : 4.4.4.4

VRF : vrf_50, State : up
L3-VNI : 5050
Route-Distinguisher : 1:80.80.1.1:5050(auto)
Route-Targets : 0:200:268440506(auto) both
Remote VTEP : 4.4.4.4
```

```
OS10# show evpn vrf
VXLAN-VNI EVI Virtual-Network-Instance VRF-Name
30 30 30 vrf_30
40 40 40 vrf_40
```

```
OS10# show evpn vrf l3-vni vrf_30
VRF : vrf_30, State : up
L3-VNI : 3030
Route-Distinguisher : 1:80.80.1.1:3030(auto)
Route-Targets : 0:200:268435557(auto) both
Remote VTEP : 4.4.4.4
```

**Supported releases** 10.5.1.0 or later

## show evpn vxlan-vni

Displays the VXLAN overlay network for EVPN instances.

|                          |                                                                                                  |
|--------------------------|--------------------------------------------------------------------------------------------------|
| <b>Syntax</b>            | <code>show evpn vxlan-vni [vni]</code>                                                           |
| <b>Parameters</b>        | <i>vni</i> — (Optional) Enter the VXLAN virtual-network ID, from 1 to 16,777,215.                |
| <b>Default</b>           | Not configured                                                                                   |
| <b>Command mode</b>      | EXEC                                                                                             |
| <b>Usage information</b> | Use this command to verify the VXLAN virtual network and bridge domain used by an EVPN instance. |

### Example

```
OS10# show evpn vxlan-vni

VXLAN-VNI EVI Bridge-Domain
100 65447 65447
```

**Supported releases** 10.4.2.0 or later

## vni

Associates an EVPN instance with a VXLAN VNI or configures a VXLAN VNI to use for L3 EVPN symmetric IRB traffic.

|                          |                                                                                                                                                                                                                                                                                           |
|--------------------------|-------------------------------------------------------------------------------------------------------------------------------------------------------------------------------------------------------------------------------------------------------------------------------------------|
| <b>Syntax</b>            | <code>vni vni</code>                                                                                                                                                                                                                                                                      |
| <b>Parameters</b>        | <b>vni</b> Enter a VXLAN virtual-network ID, from 1 to 16,777,215.                                                                                                                                                                                                                        |
| <b>Default</b>           | Not configured                                                                                                                                                                                                                                                                            |
| <b>Command mode</b>      | EVPN-EVI and EVPN-VRF                                                                                                                                                                                                                                                                     |
| <b>Usage information</b> | Use this command: <ul style="list-style-type: none"><li>• In EVPN-EVI mode to configure an EVPN instance with RD and RT values for an overlay VXLAN virtual network.</li><li>• In EVPN-VRF mode to configure a unique VXLAN VNI for EVPN symmetric IRB traffic in a tenant VRF.</li></ul> |

### Example

```
OS10(config)# evpn
OS10(config-evpn)# evi 10
OS10(config-evpn-evi)# vni 10000
```

```
OS10(config)# evpn
OS10(config-evpn)# vrf vrf-blue
OS10(config-evpn-vrf-vrf-blue)# vni 65536
```

**Supported releases** 10.5.1 or later

## vrf

Creates a non-default VRF instance for EVPN symmetric IRB traffic.

|                     |                                                                                                                                        |
|---------------------|----------------------------------------------------------------------------------------------------------------------------------------|
| <b>Syntax</b>       | <code>vrf vrf-name</code>                                                                                                              |
| <b>Parameters</b>   | <ul style="list-style-type: none"><li>• <i>vrf-name</i> — Enter the name of a non-default tenant VRF; 32 characters maximum.</li></ul> |
| <b>Default</b>      | Not configured                                                                                                                         |
| <b>Command Mode</b> | EVPN                                                                                                                                   |

**Usage Information** Configure a non-default VRF for symmetric IRB for each tenant VRF. The tenant VRF is created using the `ip vrf` command when you enable overlay routing with IRB; see [Enable overlay routing between virtual networks](#).

**Example**

```
OS10(config)# evpn
OS10(config-evpn)# vrf vrf-blue
```

**Supported Releases** 10.5.1 or later

## Example: VXLAN with BGP EVPN

The following VXLAN with BGP EVPN example uses a Clos leaf-spine topology with VXLAN tunnel endpoints (VTEPs). The individual switch configuration shows how to set up an end-to-end VXLAN. eBGP is used to exchange IP routes in the IP underlay network, and EVPN routes in the VXLAN overlay network. All spine nodes are in one autonomous system—AS 101. All leaf nodes are in another autonomous system—AS 100.

- On VTEPs 1 and 2: Access ports are assigned to the virtual network using a switch-scoped VLAN. EVPN is configured using auto-EVI mode.
- On VTEPs 3 and 4: Access ports are assigned to the virtual network using a port-scoped VLAN. The EVPN instance is configured using manual configuration mode. The RD and RT are configured using auto mode.

All VTEPs perform asymmetric IRB routing, in which:

- IRB routing is performed only on ingress VTEPs.
- Egress VTEPs perform IRB bridging.



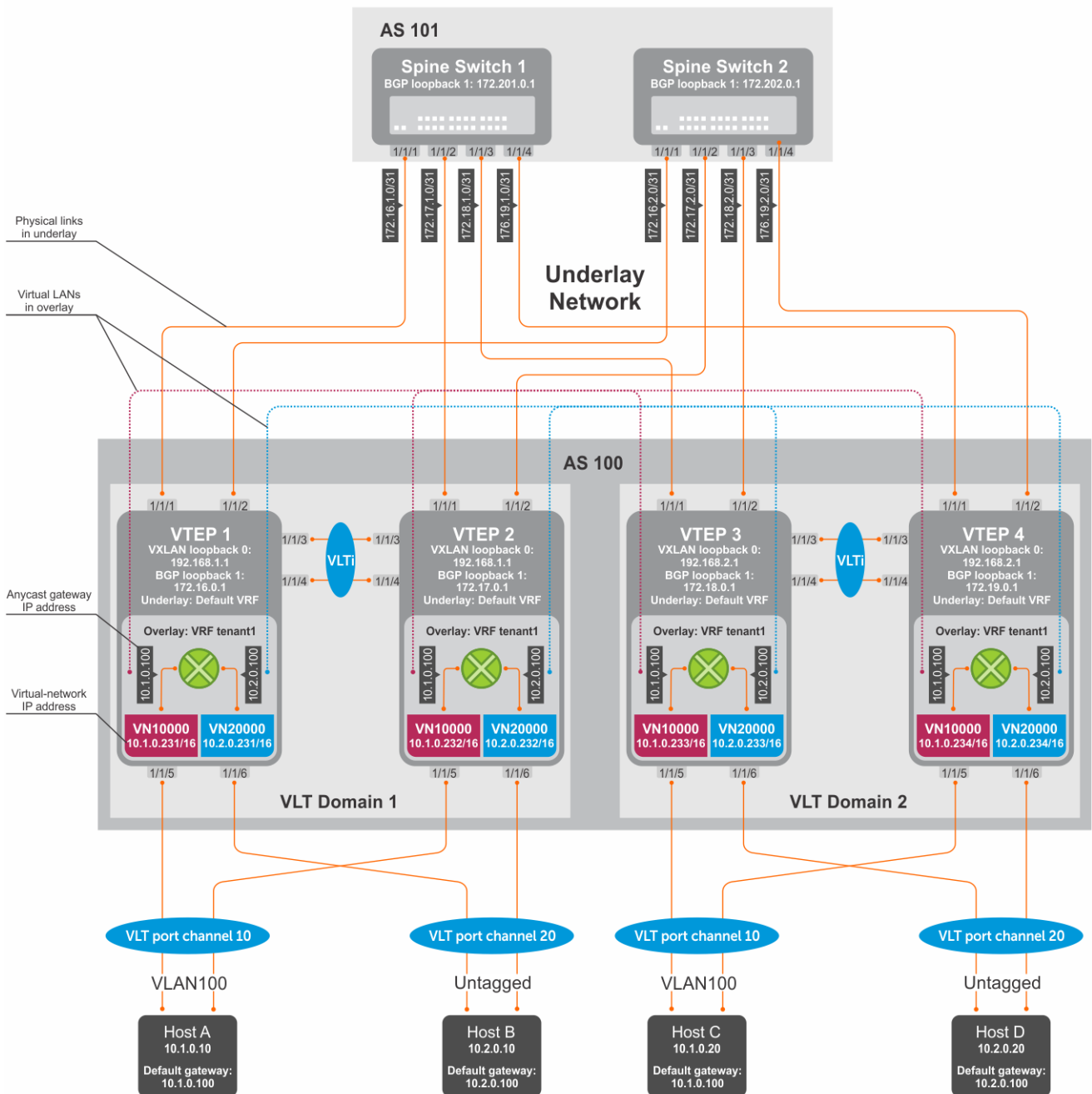

Figure 15. VXLAN BGP EVPN use case

## VTEP 1 Leaf Switch

1. Configure a Loopback interface for the VXLAN underlay using same IP address as the VLT peer.

```
OS10(config)# interface loopback0
OS10(conf-if-lo-0)# no shutdown
OS10(conf-if-lo-0)# ip address 192.168.1.1/32
OS10(conf-if-lo-0)# exit
```

2. Configure the Loopback interface as the VXLAN source tunnel interface.

```
OS10(config)# nve
OS10(config-nve)# source-interface loopback0
OS10(config-nve)# exit
```

### 3. Configure VXLAN virtual networks.

```
OS10(config)# virtual-network 10000
OS10(config-vn-10000)# vxlan-vni 10000
OS10(config-vn-vxlan-vni)# exit
OS10(config-vn-10000)# exit
OS10(config)# virtual-network 20000
OS10(config-vn-20000)# vxlan-vni 20000
OS10(config-vn-vxlan-vni)# exit
OS10(config-vn-20000)# exit
```

### 4. Assign VLAN member interfaces to the virtual networks.

Use a switch-scoped VLAN-to-VNI mapping:

```
OS10(config)# interface vlan100
OS10(config-if-vl-100)# virtual-network 10000
OS10(config-if-vl-100)# no shutdown
OS10(config-if-vl-100)# exit
OS10(config)# interface vlan200
OS10(config-if-vl-200)# virtual-network 20000
OS10(config-if-vl-200)# no shutdown
OS10(config-if-vl-200)# exit
```

### 5. Configure access ports as VLAN members for a switch-scoped VLAN-to-VNI mapping.

```
OS10(config)# interface port-channel10
OS10(config-if-po-10)# no shutdown
OS10(config-if-po-10)# switchport mode trunk
OS10(config-if-po-10)# switchport trunk allowed vlan 100
OS10(config-if-po-10)# no switchport access vlan
OS10(config-if-po-10)# exit

OS10(config)# interface ethernet1/1/5
OS10(config-if-eth1/1/5)# no shutdown
OS10(config-if-eth1/1/5)# channel-group 10 mode active
OS10(config-if-eth1/1/5)# no switchport
OS10(config-if-eth1/1/5)# exit

OS10(config)# interface port-channel20
OS10(config-if-po-20)# no shutdown
OS10(config-if-po-20)# switchport mode trunk
OS10(config-if-po-20)# switchport access vlan 200
OS10(config-if-po-20)# exit

OS10(config)# interface ethernet1/1/6
OS10(config-if-eth1/1/6)# no shutdown
OS10(config-if-eth1/1/6)# channel-group 20 mode active
OS10(config-if-eth1/1/6)# no switchport
OS10(config-if-eth1/1/6)# exit
```

### 6. Configure upstream network-facing ports.

```
OS10(config)# interface ethernet1/1/1
OS10(config-if-eth1/1/1)# no shutdown
OS10(config-if-eth1/1/1)# no switchport
OS10(config-if-eth1/1/1)# mtu 1650
OS10(config-if-eth1/1/1)# ip address 172.16.1.0/31
OS10(config-if-eth1/1/1)# exit

OS10(config)# interface ethernet1/1/2
OS10(config-if-eth1/1/2)# no shutdown
OS10(config-if-eth1/1/2)# no switchport
OS10(config-if-eth1/1/1)# mtu 1650
OS10(config-if-eth1/1/2)# ip address 172.16.2.0/31
OS10(config-if-eth1/1/2)# exit
```

### 7. Configure eBGP.

```
OS10(config)# router bgp 100
OS10(config-router-bgp-100)# router-id 172.16.0.1
```

```
OS10(config-router-bgp-100)# address-family ipv4 unicast
OS10(config-router-bgp-af)# redistribute connected
OS10(config-router-bgp-af)# exit
```

## 8. Configure eBGP for the IPv4 point-to-point peering.

```
OS10(config-router-bgp-100)# neighbor 172.16.1.1
OS10(config-router-neighbor)# remote-as 101
OS10(config-router-neighbor)# address-family ipv4 unicast
OS10(config-router-bgp-neighbor-af)# allowas-in 1
OS10(config-router-bgp-neighbor-af)# exit
OS10(config-router-neighbor)# no shutdown
OS10(config-router-neighbor)# exit

OS10(config-router-bgp-100)# neighbor 172.16.2.1
OS10(config-router-neighbor)# remote-as 101
OS10(config-router-neighbor)# address-family ipv4 unicast
OS10(config-router-bgp-neighbor-af)# allowas-in 1
OS10(config-router-bgp-neighbor-af)# exit
OS10(config-router-neighbor)# no shutdown
OS10(config-router-neighbor)# exit
OS10(config-router-bgp-100)# exit
```

## 9. Configure a Loopback interface for BGP EVPN peering different from the VLT peer IP address.

```
OS10(config)# interface loopback1
OS10(conf-if-lo-1)# no shutdown
OS10(conf-if-lo-1)# ip address 172.16.0.1/32
OS10(conf-if-lo-1)# exit
```

## 10. Configure BGP EVPN peering.

```
OS10(config)# router bgp 100
OS10(config-router-bgp-100)# neighbor 172.201.0.1
OS10(config-router-neighbor)# remote-as 101
OS10(config-router-neighbor)# ebgp-multihop 4
OS10(config-router-neighbor)# send-community extended
OS10(config-router-neighbor)# update-source loopback1
OS10(config-router-neighbor)# no shutdown
OS10(config-router-neighbor)# address-family ipv4 unicast
OS10(config-router-bgp-neighbor-af)# no activate
OS10(config-router-bgp-neighbor-af)# exit
OS10(config-router-neighbor)# address-family l2vpn evpn
OS10(config-router-bgp-neighbor-af)# activate
OS10(config-router-bgp-neighbor-af)# allowas-in 1
OS10(config-router-bgp-neighbor-af)# exit
OS10(config-router-neighbor)# exit

OS10(config-router-bgp-100)# neighbor 172.202.0.1
OS10(config-router-neighbor)# remote-as 101
OS10(config-router-neighbor)# ebgp-multihop 4
OS10(config-router-neighbor)# send-community extended
OS10(config-router-neighbor)# update-source loopback1
OS10(config-router-neighbor)# no shutdown
OS10(config-router-neighbor)# address-family ipv4 unicast
OS10(config-router-bgp-neighbor-af)# no activate
OS10(config-router-bgp-neighbor-af)# exit
OS10(config-router-neighbor)# address-family l2vpn evpn
OS10(config-router-bgp-neighbor-af)# activate
OS10(config-router-bgp-neighbor-af)# allowas-in 1
OS10(config-router-bgp-neighbor-af)# exit
OS10(config-router-neighbor)# exit
OS10(config-router-bgp-100)# exit
```

## 11. Configure EVPN.

Configure the EVPN instance, RD, and RT using auto-EVI mode:

```
OS10(config)# evpn
OS10(config-evpn)# auto-evi
OS10(config-evpn)# exit
```

## 12. Configure VLT.

Configure a dedicated L3 underlay path to reach the VLT Peer in case of a network failure.

```
OS10(config)# interface vlan4000
OS10(config-if-vl-4000)# no shutdown
OS10(config-if-vl-4000)# ip address 172.16.250.0/31
OS10(config-if-vl-4000)# exit
```

Configure the VLT port channel.

```
OS10(config)# interface port-channel10
OS10(conf-if-po-10)# vlt-port-channel 10
OS10(conf-if-po-10)# exit

OS10(config)# interface port-channel20
OS10(conf-if-po-20)# vlt-port-channel 20
OS10(conf-if-po-20)# exit
```

Configure the VLTi member links.

```
OOS10(config)# interface ethernet1/1/3
OS10(conf-if-eth1/1/3)# no shutdown
OS10(conf-if-eth1/1/3)# no switchport
OS10(conf-if-eth1/1/3)# exit

OS10(config)# interface ethernet1/1/4
OS10(conf-if-eth1/1/4)# no shutdown
OS10(conf-if-eth1/1/4)# no switchport
OS10(conf-if-eth1/1/4)# exit
```

Configure the VLT domain.

```
OS10(config)# vlt-domain 1
OS10(conf-vlt-1)# backup destination 10.16.150.1
OS10(conf-vlt-1)# discovery-interface ethernet1/1/3,1/1/4
OS10(conf-vlt-1)# vlt-mac aa:bb:cc:dd:ee:ff
OS10(conf-vlt-1)# exit
```

Configure UFD with uplink VLT ports and downlink network ports.

```
OS10(config)# uplink-state-group 1
OS10(conf-uplink-state-group-1)# enable
OS10(conf-uplink-state-group-1)# downstream ethernet1/1/1-1/1/2
OS10(conf-uplink-state-group-1)# upstream port-channel10
OS10(conf-uplink-state-group-1)# upstream port-channel20
OS10(conf-uplink-state-group-1)# exit
```

Configure iBGP IPv4 peering between VLT peers.

```
OS10(config)# router bgp 100
OS10(config-router-bgp-100)# neighbor 172.16.250.1
OS10(config-router-neighbor)# remote-as 100
OS10(config-router-neighbor)# no shutdown
OS10(config-router-neighbor)# exit
OS10(config-router-bgp-100)# exit
```

## 13. Configure IP switching in the overlay network.

Create a tenant VRF.

```
OS10(config)# ip vrf tenant1
OS10(conf-vrf)# exit
```

Configure an anycast gateway MAC address.

```
OS10(config)# ip virtual-router mac-address 00:01:01:01:01:01
```

### Configure routing on the virtual networks.

```
OS10(config)# interface virtual-network 10000
OS10(config-if-vn-10000)# ip vrf forwarding tenant1
OS10(config-if-vn-10000)# ip address 10.1.0.231/16
OS10(config-if-vn-10000)# ip virtual-router address 10.1.0.100
OS10(config-if-vn-10000)# no shutdown
OS10(config-if-vn-10000)# exit

OS10(config)# interface virtual-network 20000
OS10(config-if-vn-20000)# ip vrf forwarding tenant1
OS10(config-if-vn-20000)# ip address 10.2.0.231/16
OS10(config-if-vn-20000)# ip virtual-router address 10.2.0.100
OS10(config-if-vn-20000)# no shutdown
OS10(config-if-vn-20000)# exit
```

## VTEP 2 Leaf Switch

### 1. Configure a Loopback interface for the VXLAN underlay using the same IP address as the VLT peer.

```
OS10(config)# interface loopback0
OS10(config-if-lo-0)# no shutdown
OS10(config-if-lo-0)# ip address 192.168.1.1/32
OS10(config-if-lo-0)# exit
```

### 2. Configure the Loopback interface as the VXLAN source tunnel interface.

```
OS10(config)# nve
OS10(config-nve)# source-interface loopback0
OS10(config-nve)# exit
```

### 3. Configure the VXLAN virtual networks.

```
OS10(config)# virtual-network 10000
OS10(config-vn-10000)# vxlan-vni 10000
OS10(config-vn-vxlan-vni)# exit
OS10(config-vn)# exit
OS10(config)# virtual-network 20000
OS10(config-vn-20000)# vxlan-vni 20000
OS10(config-vn-vxlan-vni)# exit
OS10(config-vn-20000)# exit
```

### 4. Assign VLAN member interfaces to the virtual networks.

Use a switch-scoped VLAN-to-VNI mapping:

```
OS10(config)# interface vlan100
OS10(config-if-vl-100)# virtual-network 10000
OS10(config-if-vl-100)# no shutdown
OS10(config-if-vl-100)# exit
OS10(config)# interface vlan200
OS10(config-if-vl-200)# virtual-network 20000
OS10(config-if-vl-200)# no shutdown
OS10(config-if-vl-200)# exit
```

### 5. Configure access ports as VLAN members for a switch-scoped VLAN-to-VNI mapping.

```
OS10(config)# interface port-channel10
OS10(config-if-po-10)# no shutdown
OS10(config-if-po-10)# switchport mode trunk
OS10(config-if-po-10)# switchport trunk allowed vlan 100
OS10(config-if-po-10)# no switchport access vlan
OS10(config-if-po-10)# exit

OS10(config)# interface ethernet1/1/5
OS10(config-if-eth1/1/5)# no shutdown
OS10(config-if-eth1/1/5)# channel-group 10 mode active
OS10(config-if-eth1/1/5)# no switchport
```

```

OS10(config-if-eth1/1/5)# exit

OS10(config)# interface port-channel20
OS10(config-if-po-20)# no shutdown
OS10(config-if-po-20)# switchport mode trunk
OS10(config-if-po-20)# switchport access vlan 200
OS10(config-if-po-20)# exit

OS10(config)# interface ethernet1/1/6
OS10(config-if-eth1/1/6)# no shutdown
OS10(config-if-eth1/1/6)# channel-group 20 mode active
OS10(config-if-eth1/1/6)# no switchport
OS10(config-if-eth1/1/6)# exit

```

## 6. Configure upstream network-facing ports.

```

OS10(config)# interface ethernet1/1/1
OS10(config-if-eth1/1/1)# no shutdown
OS10(config-if-eth1/1/1)# no switchport
OS10(config-if-eth1/1/1)# mtu 1650
OS10(config-if-eth1/1/1)# ip address 172.17.1.0/31
OS10(config-if-eth1/1/1)# exit

OS10(config)# interface ethernet1/1/2
OS10(config-if-eth1/1/2)# no shutdown
OS10(config-if-eth1/1/2)# no switchport
OS10(config-if-eth1/1/2)# mtu 1650
OS10(config-if-eth1/1/2)# ip address 172.17.2.0/31
OS10(config-if-eth1/1/2)# exit

```

## 7. Configure eBGP.

```

OS10(config)# router bgp 100
OS10(config-router-bgp-100)# router-id 172.17.0.1
OS10(config-router-bgp-100)# address-family ipv4 unicast
OS10(config-router-bgp-af)# redistribute connected
OS10(config-router-bgp-af)# exit

```

## 8. Configure eBGP for the IPv4 point-to-point peering.

```

OS10(config-router-bgp-100)# neighbor 172.17.1.1
OS10(config-router-neighbor)# remote-as 101
OS10(config-router-neighbor)# address-family ipv4 unicast
OS10(config-router-bgp-neighbor-af)# allowas-in 1
OS10(config-router-bgp-neighbor-af)# exit
OS10(config-router-neighbor)# no shutdown
OS10(config-router-neighbor)# exit

OS10(config-router-bgp-100)# neighbor 172.17.2.1
OS10(config-router-neighbor)# remote-as 101
OS10(config-router-neighbor)# address-family ipv4 unicast
OS10(config-router-bgp-neighbor-af)# allowas-in 1
OS10(config-router-bgp-neighbor-af)# exit
OS10(config-router-neighbor)# no shutdown
OS10(config-router-neighbor)# exit
OS10(config-router-bgp-100)# exit

```

## 9. Configure a Loopback interface for BGP EVPN peering different from VLT peer IP address.

```

OS10(config)# interface loopback1
OS10(config-if-lo-1)# no shutdown
OS10(config-if-lo-1)# ip address 172.17.0.1/32
OS10(config-if-lo-1)# exit

```

## 10. Configure BGP EVPN peering.

```

OS10(config)# router bgp 100
OS10(config-router-bgp-100)# neighbor 172.201.0.1
OS10(config-router-neighbor)# remote-as 101
OS10(config-router-neighbor)# ebgp-multihop 4
OS10(config-router-neighbor)# send-community extended

```

```

OS10(config-router-neighbor)# update-source loopback1
OS10(config-router-neighbor)# no shutdown
OS10(config-router-neighbor)# address-family ipv4 unicast
OS10(config-router-bgp-neighbor-af)# no activate
OS10(config-router-bgp-neighbor-af)# exit
OS10(config-router-neighbor)# address-family l2vpn evpn
OS10(config-router-bgp-neighbor-af)# activate
OS10(config-router-bgp-neighbor-af)# allowas-in 1
OS10(config-router-bgp-neighbor-af)# exit
OS10(config-router-neighbor)# exit

OS10(config-router-bgp-100)# neighbor 172.202.0.1
OS10(config-router-neighbor)# remote-as 101
OS10(config-router-neighbor)# ebgp-multihop 4
OS10(config-router-neighbor)# send-community extended
OS10(config-router-neighbor)# update-source loopback1
OS10(config-router-neighbor)# no shutdown
OS10(config-router-bgp-neighbor)# address-family ipv4 unicast
OS10(config-router-bgp-neighbor-af)# no activate
OS10(config-router-bgp-neighbor-af)# exit
OS10(config-router-neighbor)# address-family l2vpn evpn
OS10(config-router-bgp-neighbor-af)# activate
OS10(config-router-bgp-neighbor-af)# allowas-in 1
OS10(config-router-bgp-neighbor-af)# exit
OS10(config-router-neighbor)# exit
OS10(config-router-bgp-100)# exit

```

## 11. Configure EVPN.

Configure the EVPN instance, RD, and RT using auto-EVI mode:

```

OS10(config)# evpn
OS10(config-evpn)# auto-evi
OS10(config-evpn)# exit

```

## 12. Configure VLT.

**Configure a dedicated L3 underlay path to reach the VLT Peer in case of a network failure.**

```

OS10(config)# interface vlan4000
OS10(config-if-vl-4000)# no shutdown
OS10(config-if-vl-4000)# ip address 172.16.250.1/31
OS10(config-if-vl-4000)# exit

```

**Configure the VLT port channel.**

```

OS10(config)# interface port-channel10
OS10(conf-if-po-10)# vlt-port-channel 10
OS10(conf-if-po-10)# exit

OS10(config)# interface port-channel20
OS10(conf-if-po-20)# vlt-port-channel 20
OS10(conf-if-po-20)# exit

```

**Configure VLTi member links.**

```

OS10(config)# interface ethernet1/1/3
OS10(conf-if-eth1/1/3)# no shutdown
OS10(conf-if-eth1/1/3)# no switchport
OS10(conf-if-eth1/1/3)# exit

OS10(config)# interface ethernet1/1/4
OS10(conf-if-eth1/1/4)# no shutdown
OS10(conf-if-eth1/1/4)# no switchport
OS10(conf-if-eth1/1/4)# exit

```

**Configure the VLT domain.**

```

OS10(config)# vlt-domain 1
OS10(conf-vlt-1)# backup destination 10.16.150.2
OS10(conf-vlt-1)# discovery-interface ethernet1/1/3,1/1/4

```

```
OS10(config-vlt-1)# vlt-mac aa:bb:cc:dd:ee:ff
OS10(config-vlt-1)# exit
```

### Configure UFD with uplink VLT ports and downlink network ports.

```
OS10(config)# uplink-state-group 1
OS10(config-uplink-state-group-1)# enable
OS10(config-uplink-state-group-1)# downstream ethernet1/1/1-1/1/2
OS10(config-uplink-state-group-1)# upstream port-channel10
OS10(config-uplink-state-group-1)# upstream port-channel20
OS10(config-uplink-state-group-1)# exit
```

### Configure iBGP IPv4 peering between VLT peers.

```
OS10(config)# router bgp 100
OS10(config-router-bgp-100)# neighbor 172.16.250.0
OS10(config-router-neighbor)# remote-as 100
OS10(config-router-neighbor)# no shutdown
OS10(config-router-neighbor)# exit
OS10(config-router-bgp-100)# exit
```

## 13. Configure IP switching in overlay network.

### Create a tenant VRF.

```
OS10(config)# ip vrf tenant1
OS10(config-vrf)# exit
```

### Configure an anycast gateway MAC address.

```
OS10(config)# ip virtual-router mac-address 00:01:01:01:01:01
```

### Configure routing on the virtual networks.

```
OS10(config)# interface virtual-network 10000
OS10(config-if-vn-10000)# ip vrf forwarding tenant1
OS10(config-if-vn-10000)# ip address 10.1.0.232/16
OS10(config-if-vn-10000)# ip virtual-router address 10.1.0.100
OS10(config-if-vn-10000)# no shutdown
OS10(config-if-vn-10000)# exit

OS10(config)# interface virtual-network 20000
OS10(config-if-vn-20000)# ip vrf forwarding tenant1
OS10(config-if-vn-20000)# ip address 10.2.0.232/16
OS10(config-if-vn-20000)# ip virtual-router address 10.2.0.100
OS10(config-if-vn-20000)# no shutdown
OS10(config-if-vn-20000)# exit
```

## VTEP 3 Leaf Switch

### 1. Configure a Loopback interface for the VXLAN underlay using same IP address as the VLT peer.

```
OS10(config)# interface loopback0
OS10(config-if-lo-0)# no shutdown
OS10(config-if-lo-0)# ip address 192.168.2.1/32
OS10(config-if-lo-0)# exit
```

### 2. Configure the Loopback interface as the VXLAN source tunnel interface.

```
OS10(config)# nve
OS10(config-nve)# source-interface loopback0
OS10(config-nve)# exit
```

### 3. Configure VXLAN virtual networks.

```
OS10(config)# virtual-network 10000
OS10(config-vn-10000)# vxlan-vni 10000
```



```
OS10(config-vn-vxlan-vni)# exit
OS10(config-vn-10000)# exit

OS10(config)# virtual-network 20000
OS10(config-vn-20000)# vxlan-vni 20000
OS10(config-vn-vxlan-vni)# exit
OS10(config-vn-20000)# exit
```

#### 4. Configure unused VLAN ID for untagged membership.

```
OS10(config)# virtual-network untagged-vlan 1000
```

#### 5. Configure access ports as VLAN members for a port-scoped VLAN-to-VNI mapping.

```
OS10(config)# interface port-channel10
OS10(conf-if-po-10)# no shutdown
OS10(conf-if-po-10)# switchport mode trunk
OS10(conf-if-po-10)# no switchport access vlan
OS10(conf-if-po-10)# exit

OS10(config)# interface ethernet1/1/5
OS10(conf-if-eth1/1/5)# no shutdown
OS10(conf-if-eth1/1/5)# channel-group 10 mode active
OS10(conf-if-eth1/1/5)# no switchport
OS10(conf-if-eth1/1/5)# exit

OS10(config)# interface port-channel20
OS10(conf-if-po-20)# no shutdown
OS10(conf-if-po-20)# switchport mode trunk
OS10(conf-if-po-20)# no switchport access vlan
OS10(conf-if-po-20)# exit

OS10(config)# interface ethernet1/1/6
OS10(conf-if-eth1/1/6)# no shutdown
OS10(conf-if-eth1/1/6)# channel-group 20 mode active
OS10(conf-if-eth1/1/6)# no switchport
OS10(conf-if-eth1/1/6)# exit
```

#### 6. Add the access ports to virtual networks.

```
OS10(config)# virtual-network 10000
OS10(config-vn-10000)# member-interface port-channel 10 vlan-tag 100
OS10(config-vn-10000)# exit

OS10(config)# virtual-network 20000
OS10(config-vn-20000)# member-interface port-channel 20 untagged
OS10(config-vn-20000)# exit
```

#### 7. Configure upstream network-facing ports.

```
OS10(config)# interface ethernet1/1/1
OS10(conf-if-eth1/1/1)# no shutdown
OS10(conf-if-eth1/1/1)# no switchport
OS10(conf-if-eth1/1/1)# mtu 1650
OS10(conf-if-eth1/1/1)# ip address 172.18.1.0/31
OS10(conf-if-eth1/1/1)# exit

OS10(config)# interface ethernet1/1/2
OS10(conf-if-eth1/1/2)# no shutdown
OS10(conf-if-eth1/1/2)# no switchport
OS10(conf-if-eth1/1/1)# mtu 1650
OS10(conf-if-eth1/1/2)# ip address 172.18.2.0/31
OS10(conf-if-eth1/1/2)# exit
```

#### 8. Configure eBGP.

```
OS10(config)# router bgp 100
OS10(config-router-bgp-100)# router-id 172.18.0.1
OS10(config-router-bgp-100)# address-family ipv4 unicast
```

```
OS10(configure-router-bgp-af)# redistribute connected
OS10(configure-router-bgp-af)# exit
```

### 9. Configure eBGP for the IPv4 point-to-point peering.

```
OS10(config-router-bgp-100)# neighbor 172.18.1.1
OS10(config-router-neighbor)# remote-as 101
OS10(config-router-neighbor)# address-family ipv4 unicast
OS10(config-router-bgp-neighbor-af)# allowas-in 1
OS10(config-router-bgp-neighbor-af)# exit
OS10(config-router-neighbor)# no shutdown
OS10(config-router-neighbor)# exit

OS10(config-router-bgp-100)# neighbor 172.18.2.1
OS10(config-router-neighbor)# remote-as 101
OS10(config-router-neighbor)# address-family ipv4 unicast
OS10(config-router-bgp-neighbor-af)# allowas-in 1
OS10(config-router-bgp-neighbor-af)# exit
OS10(config-router-neighbor)# no shutdown
OS10(config-router-neighbor)# exit
OS10(config-router-bgp-100)# exit
```

### 10. Configure a Loopback interface for BGP EVPN peering different from VLT peer IP address.

```
OS10(config)# interface loopback1
OS10(conf-if-lo-1)# no shutdown
OS10(conf-if-lo-1)# ip address 172.18.0.1/32
OS10(conf-if-lo-1)# exit
```

### 11. Configure BGP EVPN peering.

```
OS10(config)# router bgp 100
OS10(config-router-bgp-100)# neighbor 172.201.0.1
OS10(config-router-neighbor)# remote-as 101
OS10(config-router-neighbor)# ebgp-multihop 4
OS10(config-router-neighbor)# send-community extended
OS10(config-router-neighbor)# update-source loopback1
OS10(config-router-neighbor)# no shutdown
OS10(config-router-neighbor)# address-family ipv4 unicast
OS10(config-router-bgp-neighbor-af)# no activate
OS10(config-router-bgp-neighbor-af)# exit
OS10(config-router-neighbor)# address-family l2vpn evpn
OS10(config-router-bgp-neighbor-af)# activate
OS10(config-router-bgp-neighbor-af)# allowas-in 1
OS10(config-router-bgp-neighbor-af)# exit
OS10(config-router-neighbor)# exit

OS10(config-router-bgp-100)# neighbor 172.202.0.1
OS10(config-router-neighbor)# remote-as 101
OS10(config-router-neighbor)# ebgp-multihop 4
OS10(config-router-neighbor)# send-community extended
OS10(config-router-neighbor)# update-source loopback1
OS10(config-router-neighbor)# no shutdown
OS10(config-router-neighbor)# address-family ipv4 unicast
OS10(config-router-bgp-neighbor-af)# no activate
OS10(config-router-bgp-neighbor-af)# exit
OS10(config-router-neighbor)# address-family l2vpn evpn
OS10(config-router-bgp-neighbor-af)# activate
OS10(config-router-bgp-neighbor-af)# allowas-in 1
OS10(config-router-bgp-neighbor-af)# exit
OS10(config-router-neighbor)# exit
OS10(config-router-bgp-100)# exit
```

### 12. Configure EVPN.

Configure the EVPN instance in manual configuration mode, and RD and RT configuration in auto mode:

```
OS10(config)# evpn
OS10(config-evpn)# evi 10000
OS10(config-evpn-evi-10000)# vni 10000
OS10(config-evpn-evi-10000)# rd auto
```

```

OS10(config-evpn-evi-10000)# route-target auto
OS10(config-evpn-evi-10000)# exit

OS10(config-evpn)# evi 20000
OS10(config-evpn-evi-20000)# vni 20000
OS10(config-evpn-evi-20000)# rd auto
OS10(config-evpn-evi-20000)# route-target auto
OS10(config-evpn-evi-20000)# exit
OS10(config-evpn)# exit

```

### 13. Configure VLT.

#### Configure a VLTi VLAN for the virtual network.

```

OS10(config)# virtual-network 10000
OS10(config-vn-10000)# vlti-vlan 100
OS10(config-vn-10000)# exit

OS10(config)# virtual-network 20000
OS10(config-vn-20000)# vlti-vlan 200
OS10(config-vn-20000)# exit

```

#### Configure a dedicated L3 underlay path to reach the VLT Peer in case of a network failure.

```

OS10(config)# interface vlan4000
OS10(config-if-vl-4000)# no shutdown
OS10(config-if-vl-4000)# ip address 172.16.250.10/31
OS10(config-if-vl-4000)# exit

```

#### Configure the VLT port channels.

```

OS10(config)# interface port-channel10
OS10(conf-if-po-10)# vlt-port-channel 10
OS10(conf-if-po-10)# exit

OS10(config)# interface port-channel20
OS10(conf-if-po-20)# vlt-port-channel 20
OS10(conf-if-po-20)# exit

```

#### Configure VLTi member links.

```

OS10(config)# interface ethernet1/1/3
OS10(conf-if-eth1/1/3)# no shutdown
OS10(conf-if-eth1/1/3)# no switchport
OS10(conf-if-eth1/1/3)# exit

OS10(config)# interface ethernet1/1/4
OS10(conf-if-eth1/1/4)# no shutdown
OS10(conf-if-eth1/1/4)# no switchport
OS10(conf-if-eth1/1/4)# exit

```

#### Configure the VLT domain.

```

OS10(config)# vlt-domain 1
OS10(conf-vlt-1)# backup destination 10.16.150.3
OS10(conf-vlt-1)# discovery-interface ethernet1/1/3,1/1/4
OS10(conf-vlt-1)# vlt-mac aa:bb:cc:dd:ff:ee
OS10(conf-vlt-1)# exit

```

#### Configure UFD with uplink VLT ports and downlink network ports.

```

OS10(config)# uplink-state-group 1
OS10(conf-uplink-state-group-1)# enable
OS10(conf-uplink-state-group-1)# downstream ethernet1/1/1-1/1/2
OS10(conf-uplink-state-group-1)# upstream port-channel10
OS10(conf-uplink-state-group-1)# upstream port-channel20
OS10(conf-uplink-state-group-1)# exit

```

### Configure iBGP IPv4 peering between VLT peers.

```
OS10(config)# router bgp 100
OS10(config-router-bgp-100)# neighbor 172.16.250.11
OS10(config-router-neighbor)# remote-as 100
OS10(config-router-neighbor)# no shutdown
OS10(config-router-neighbor)# exit
OS10(config-router-bgp-100)# exit
```

### 14. Configure IP routing in the overlay network.

#### Create the tenant VRF.

```
OS10(config)# ip vrf tenant1
OS10(conf-vrf)# exit
```

#### Configure an anycast gateway MAC address.

```
OS10(config)# ip virtual-router mac-address 00:01:01:01:01:01
```

#### Configure routing on the virtual networks.

```
OS10(config)# interface virtual-network 10000
OS10(conf-if-vn-10000)# ip vrf forwarding tenant1
OS10(conf-if-vn-10000)# ip address 10.1.0.233/16
OS10(conf-if-vn-10000)# ip virtual-router address 10.1.0.100
OS10(conf-if-vn-10000)# no shutdown
OS10(conf-if-vn-10000)# exit

OS10(config)# interface virtual-network 20000
OS10(conf-if-vn-20000)# ip vrf forwarding tenant1
OS10(conf-if-vn-20000)# ip address 10.2.0.233/16
OS10(conf-if-vn-20000)# ip virtual-router address 10.2.0.100
OS10(conf-if-vn-20000)# no shutdown
OS10(conf-if-vn-20000)# exit
```

## VTEP 4 Leaf Switch

### 1. Configure a Loopback interface for the VXLAN underlay using same IP address as the VLT peer.

```
OS10(config)# interface loopback0
OS10(conf-if-lo-0)# no shutdown
OS10(conf-if-lo-0)# ip address 192.168.2.1/32
OS10(conf-if-lo-0)# exit
```

### 2. Configure the Loopback interface as the VXLAN source tunnel interface.

```
OS10(config)# nve
OS10(config-nve)# source-interface loopback0
OS10(config-nve)# exit
```

### 3. Configure the VXLAN virtual networks.

```
OS10(config)# virtual-network 10000
OS10(config-vn-10000)# vxlan-vni 10000
OS10(config-vn-vxlan-vni)# exit
OS10(config-vn-10000)# exit

OS10(config)# virtual-network 20000
OS10(config-vn-20000)# vxlan-vni 20000
OS10(config-vn-vxlan-vni)# exit
OS10(config-vn-20000)# exit
```

### 4. Configure the unused VLAN ID for untagged membership.

```
OS10(config)# virtual-network untagged-vlan 1000
```

## 5. Configure access ports as VLAN members for a port-scoped VLAN-to-VNI mapping.

```
OS10(config)# interface port-channel10
OS10(config-if-po-10)# no shutdown
OS10(config-if-po-10)# switchport mode trunk
OS10(config-if-po-10)# no switchport access vlan
OS10(config-if-po-10)# exit

OS10(config)# interface ethernet1/1/5
OS10(config-if-eth1/1/5)# no shutdown
OS10(config-if-eth1/1/5)# channel-group 10 mode active
OS10(config-if-eth1/1/5)# no switchport
OS10(config-if-eth1/1/5)# exit

OS10(config)# interface port-channel20
OS10(config-if-po-20)# no shutdown
OS10(config-if-po-20)# switchport mode trunk
OS10(config-if-po-20)# no switchport access vlan
OS10(config-if-po-20)# exit

OS10(config)# interface ethernet1/1/6
OS10(config-if-eth1/1/6)# no shutdown
OS10(config-if-eth1/1/6)# channel-group 20 mode active
OS10(config-if-eth1/1/6)# no switchport
OS10(config-if-eth1/1/6)# exit
```

## 6. Add the access ports to the virtual networks.

```
OS10(config)# virtual-network 10000
OS10(config-vn-10000)# member-interface port-channel 10 vlan-tag 100
OS10(config-vn)# exit

OS10(config)# virtual-network 20000
OS10(config-vn-20000)# member-interface port-channel 20 untagged
OS10(config-vn)# exit
```

## 7. Configure upstream network-facing ports.

```
OS10(config)# interface ethernet1/1/1
OS10(config-if-eth1/1/1)# no shutdown
OS10(config-if-eth1/1/1)# no switchport
OS10(config-if-eth1/1/1)# mtu 1650
OS10(config-if-eth1/1/1)# ip address 172.19.1.0/31
OS10(config-if-eth1/1/1)# exit

OS10(config)# interface ethernet1/1/2
OS10(config-if-eth1/1/2)# no shutdown
OS10(config-if-eth1/1/2)# no switchport
OS10(config-if-eth1/1/2)# mtu 1650
OS10(config-if-eth1/1/2)# ip address 172.19.2.0/31
OS10(config-if-eth1/1/2)# exit
```

## 8. Configure eBGP.

```
OS10(config)# router bgp 100
OS10(config-router-bgp-100)# router-id 172.19.0.1
OS10(config-router-bgp-100)# address-family ipv4 unicast
OS10(configure-router-bgp-af)# redistribute connected
OS10(configure-router-bgp-af)# exit
```

## 9. Configure eBGP for the IPv4 point-to-point peering.

```
OS10(config-router-bgp-100)# neighbor 172.19.1.1
OS10(config-router-neighbor)# remote-as 101
OS10(config-router-neighbor)# address-family ipv4 unicast
OS10(config-router-bgp-neighbor-af)# allowas-in 1
OS10(config-router-bgp-neighbor-af)# exit
OS10(config-router-neighbor)# no shutdown
OS10(config-router-neighbor)# exit

OS10(config-router-bgp-100)# neighbor 172.19.2.1
```

```

OS10(config-router-neighbor)# remote-as 101
OS10(config-router-neighbor)# address-family ipv4 unicast
OS10(config-router-bgp-neighbor-af)# allowas-in 1
OS10(config-router-bgp-neighbor-af)# exit
OS10(config-router-neighbor)# no shutdown
OS10(config-router-neighbor)# exit
OS10(config-router-bgp-100)# exit

```

#### 10. Configure a Loopback interface for BGP EVPN peering different from the VLT peer IP address.

```

OS10(config)# interface loopback1
OS10(conf-if-lo-1)# no shutdown
OS10(conf-if-lo-1)# ip address 172.19.0.1/32
OS10(conf-if-lo-1)# exit

```

#### 11. Configure BGP EVPN peering.

```

OS10(config)# router bgp 100
OS10(config-router-bgp-100)# neighbor 172.201.0.1
OS10(config-router-neighbor)# remote-as 101
OS10(config-router-neighbor)# ebgp-multihop 4
OS10(config-router-neighbor)# send-community extended
OS10(config-router-neighbor)# update-source loopback1
OS10(config-router-neighbor)# no shutdown
OS10(config-router-neighbor)# address-family ipv4 unicast
OS10(config-router-bgp-neighbor-af)# no activate
OS10(config-router-bgp-neighbor-af)# exit
OS10(config-router-neighbor)# address-family l2vpn evpn
OS10(config-router-bgp-neighbor-af)# activate
OS10(config-router-bgp-neighbor-af)# allowas-in 1
OS10(config-router-bgp-neighbor-af)# exit
OS10(config-router-neighbor)# exit

OS10(config-router-bgp-100)# neighbor 172.202.0.1
OS10(config-router-neighbor)# remote-as 101
OS10(config-router-neighbor)# ebgp-multihop 4
OS10(config-router-neighbor)# send-community extended
OS10(config-router-neighbor)# update-source loopback1
OS10(config-router-neighbor)# no shutdown
OS10(config-router-neighbor)# address-family ipv4 unicast
OS10(config-router-bgp-neighbor-af)# no activate
OS10(config-router-bgp-neighbor-af)# exit
OS10(config-router-neighbor)# address-family l2vpn evpn
OS10(config-router-bgp-neighbor-af)# activate
OS10(config-router-bgp-neighbor-af)# allowas-in 1
OS10(config-router-bgp-neighbor-af)# exit
OS10(config-router-neighbor)# exit
OS10(config-router-bgp-100)# exit

```

#### 12. Configure EVPN.

Configure the EVPN instance manual configuration mode, and RD, and RT configuration in auto mode:

```

OS10(config)# evpn
OS10(config-evpn)# evi 10000
OS10(config-evpn-evi-10000)# vni 10000
OS10(config-evpn-evi-10000)# rd auto
OS10(config-evpn-evi-10000)# route-target auto
OS10(config-evpn-evi-10000)# exit

OS10(config-evpn)# evi 20000
OS10(config-evpn-evi-20000)# vni 20000
OS10(config-evpn-evi-20000)# rd auto
OS10(config-evpn-evi-20000)# route-target auto
OS10(config-evpn-evi-20000)# exit
OS10(config-evpn)# exit

```

#### 13. Configure VLT.

### Configure a VLTi VLAN for the virtual network.

```
OS10(config)# virtual-network 10000
OS10(config-vn-10000)# vlti-vlan 100
OS10(config-vn-10000)# exit

OS10(config)# virtual-network 20000
OS10(config-vn-20000)# vlti-vlan 200
OS10(config-vn-20000)# exit
```

### Configure a dedicated L3 underlay path to reach the VLT Peer in case of a network failure.

```
OS10(config)# interface vlan4000
OS10(config-if-vl-4000)# no shutdown
OS10(config-if-vl-4000)# ip address 172.16.250.11/31
OS10(config-if-vl-4000)# exit
```

### Configure VLT port channels.

```
OS10(config)# interface port-channel10
OS10(config-if-po-10)# vlt-port-channel 10
OS10(config-if-po-10)# exit

OS10(config)# interface port-channel20
OS10(config-if-po-20)# vlt-port-channel 20
OS10(config-if-po-20)# exit
```

### Configure VLTi member links.

```
OOS10(config)# interface ethernet1/1/3
OS10(config-if-eth1/1/3)# no shutdown
OS10(config-if-eth1/1/3)# no switchport
OS10(config-if-eth1/1/3)# exit

OS10(config)# interface ethernet1/1/4
OS10(config-if-eth1/1/4)# no shutdown
OS10(config-if-eth1/1/4)# no switchport
OS10(config-if-eth1/1/4)# exit
```

### Configure the VLT domain.

```
OS10(config)# vlt-domain 1
OS10(config-vlt-1)# backup destination 10.16.150.4
OS10(config-vlt-1)# discovery-interface ethernet1/1/3,1/1/4
OS10(config-vlt-1)# vlt-mac aa:bb:cc:dd:ff:ee
OS10(config-vlt-1)# exit
```

### Configure UFD with uplink VLT ports and downlink network ports.

```
OS10(config)# uplink-state-group 1
OS10(config-uplink-state-group-1)# enable
OS10(config-uplink-state-group-1)# downstream ethernet1/1/1-1/1/2
OS10(config-uplink-state-group-1)# upstream port-channel10
OS10(config-uplink-state-group-1)# upstream port-channel20
OS10(config-uplink-state-group-1)# exit
```

### Configure iBGP IPv4 peering between the VLT peers.

```
OS10(config)# router bgp 100
OS10(config-router-bgp-100)# neighbor 172.16.250.10
OS10(config-router-neighbor)# remote-as 100
OS10(config-router-neighbor)# no shutdown
OS10(config-router-neighbor)# exit
OS10(config-router-bgp-100)# exit
```

## 14. Configure IP routing in the overlay network.

### Create a tenant VRF.

```
OS10(config)# ip vrf tenant1
OS10(config-vrf)# exit
```

### Configure an anycast gateway MAC address.

```
OS10(config)# ip virtual-router mac-address 00:01:01:01:01:01
```

### Configure routing on the virtual networks.

```
OS10(config)# interface virtual-network 10000
OS10(config-if-vn-10000)# ip vrf forwarding tenant1
OS10(config-if-vn-10000)# ip address 10.1.0.234/16
OS10(config-if-vn-10000)# ip virtual-router address 10.1.0.100
OS10(config-if-vn-10000)# no shutdown
OS10(config-if-vn-10000)# exit

OS10(config)# interface virtual-network 20000
OS10(config-if-vn-20000)# ip vrf forwarding tenant1
OS10(config-if-vn-20000)# ip address 10.2.0.234/16
OS10(config-if-vn-20000)# ip virtual-router address 10.2.0.100
OS10(config-if-vn-20000)# no shutdown
OS10(config-if-vn-20000)# exit
```

## Spine Switch 1

### 1. Configure downstream ports on underlay links to the leaf switches.

```
OS10(config)# interface ethernet1/1/1
OS10(config-if-eth1/1/1)# no shutdown
OS10(config-if-eth1/1/1)# no switchport
OS10(config-if-eth1/1/1)# ip address 172.16.1.1/31
OS10(config-if-eth1/1/1)# exit
OS10(config)# interface ethernet1/1/2
OS10(config-if-eth1/1/2)# no shutdown
OS10(config-if-eth1/1/2)# no switchport
OS10(config-if-eth1/1/2)# ip address 172.17.1.1/31
OS10(config-if-eth1/1/2)# exit
OS10(config)# interface ethernet1/1/3
OS10(config-if-eth1/1/3)# no shutdown
OS10(config-if-eth1/1/3)# no switchport
OS10(config-if-eth1/1/3)# ip address 172.18.1.1/31
OS10(config-if-eth1/1/3)# exit
OS10(config)# interface ethernet1/1/4
OS10(config-if-eth1/1/4)# no shutdown
OS10(config-if-eth1/1/4)# no switchport
OS10(config-if-eth1/1/4)# ip address 172.19.1.1/31
OS10(config-if-eth1/1/4)# exit
```

### 2. Configure eBGP.

```
OS10(config)# router bgp 101
OS10(config-router-bgp-101)# router-id 172.201.0.1
OS10(config-router-bgp-101)# address-family ipv4 unicast
OS10(config-router-bgp-101-af)# redistribute connected
OS10(config-router-bgp-101-af)# exit
```

### 3. Configure eBGP IPv4 peer sessions on the P2P links.

```
OS10(config-router-bgp-101)# neighbor 172.16.1.0
OS10(config-router-neighbor)# remote-as 100
OS10(config-router-neighbor)# no shutdown
OS10(config-router-neighbor)# address-family ipv4 unicast
OS10(config-router-neighbor-af)# no sender-side-loop-detection
OS10(config-router-neighbor-af)# exit
OS10(config-router-neighbor)# exit
```



```

OS10(conf-router-bgp-101)# neighbor 172.17.1.0
OS10(conf-router-neighbor)# remote-as 100
OS10(conf-router-neighbor)# no shutdown
OS10(conf-router-neighbor)# address-family ipv4 unicast
OS10(conf-router-neighbor-af)# no sender-side-loop-detection
OS10(conf-router-neighbor-af)# exit
OS10(conf-router-neighbor)# exit

OS10(conf-router-bgp-101)# neighbor 172.18.1.0
OS10(conf-router-neighbor)# remote-as 100
OS10(conf-router-neighbor)# no shutdown
OS10(conf-router-neighbor)# address-family ipv4 unicast
OS10(conf-router-neighbor-af)# no sender-side-loop-detection
OS10(conf-router-neighbor-af)# exit
OS10(conf-router-neighbor)# exit

OS10(conf-router-bgp-101)# neighbor 172.19.1.0
OS10(conf-router-neighbor)# remote-as 100
OS10(conf-router-neighbor)# no shutdown
OS10(conf-router-neighbor)# address-family ipv4 unicast
OS10(conf-router-neighbor-af)# no sender-side-loop-detection
OS10(conf-router-neighbor-af)# exit
OS10(conf-router-neighbor)# exit
OS10(conf-router-bgp-101)# exit

```

#### 4. Configure a Loopback interface for BGP EVPN peering.

```

OS10(config)# interface loopback1
OS10(conf-if-lo-1)# no shutdown
OS10(conf-if-lo-1)# ip address 172.201.0.1/32
OS10(conf-if-lo-1)# exit

```

#### 5. Configure BGP EVPN peer sessions.

```

OS10(config)# router bgp 101
OS10(conf-router-bgp-101)# neighbor 172.16.0.1
OS10(conf-router-neighbor)# ebgp-multihop 4
OS10(conf-router-neighbor)# remote-as 100
OS10(conf-router-neighbor)# send-community extended
OS10(conf-router-neighbor)# update-source loopback1
OS10(conf-router-neighbor)# no shutdown
OS10(conf-router-neighbor)# address-family ipv4 unicast
OS10(conf-router-neighbor-af)# no activate
OS10(conf-router-neighbor-af)# exit
OS10(conf-router-neighbor)# address-family l2vpn evpn
OS10(conf-router-neighbor-af)# no sender-side-loop-detection
OS10(conf-router-neighbor-af)# activate
OS10(conf-router-neighbor-af)# exit

OS10(conf-router-bgp-101)# neighbor 172.17.0.1
OS10(conf-router-neighbor)# ebgp-multihop 4
OS10(conf-router-neighbor)# remote-as 100
OS10(conf-router-neighbor)# send-community extended
OS10(conf-router-neighbor)# update-source loopback1
OS10(conf-router-neighbor)# no shutdown
OS10(conf-router-neighbor)# address-family ipv4 unicast
OS10(conf-router-neighbor-af)# no activate
OS10(conf-router-neighbor-af)# exit
OS10(conf-router-neighbor)# address-family l2vpn evpn
OS10(conf-router-neighbor-af)# no sender-side-loop-detection
OS10(conf-router-neighbor-af)# activate
OS10(conf-router-neighbor-af)# exit

OS10(conf-router-bgp-101)# neighbor 172.18.0.1
OS10(conf-router-neighbor)# ebgp-multihop 4
OS10(conf-router-neighbor)# remote-as 100
OS10(conf-router-neighbor)# send-community extended
OS10(conf-router-neighbor)# update-source loopback1
OS10(conf-router-neighbor)# no shutdown
OS10(conf-router-neighbor)# address-family ipv4 unicast
OS10(conf-router-neighbor-af)# no activate
OS10(conf-router-neighbor-af)# exit

```

```

OS10(conf-router-neighbor)# address-family l2vpn evpn
OS10(conf-router-neighbor-af)# no sender-side-loop-detection
OS10(conf-router-neighbor-af)# activate
OS10(conf-router-neighbor-af)# exit

OS10(conf-router-bgp-101)# neighbor 172.19.0.1
OS10(conf-router-neighbor)# ebgp-multihop 4
OS10(conf-router-neighbor)# remote-as 100
OS10(conf-router-neighbor)# send-community extended
OS10(conf-router-neighbor)# update-source loopback1
OS10(conf-router-neighbor)# no shutdown
OS10(conf-router-neighbor)# address-family ipv4 unicast
OS10(conf-router-neighbor-af)# no activate
OS10(conf-router-neighbor-af)# exit
OS10(conf-router-neighbor)# address-family l2vpn evpn
OS10(conf-router-neighbor-af)# no sender-side-loop-detection
OS10(conf-router-neighbor-af)# activate
OS10(conf-router-neighbor-af)# exit

```

## Spine Switch 2

### 1. Configure downstream ports on the underlay links to the leaf switches.

```

OS10(config)# interface ethernet1/1/1
OS10(conf-if-eth1/1/1)# no shutdown
OS10(conf-if-eth1/1/1)# no switchport
OS10(conf-if-eth1/1/1)# ip address 172.16.2.1/31
OS10(conf-if-eth1/1/1)# exit
OS10(config)# interface ethernet1/1/2
OS10(conf-if-eth1/1/2)# no shutdown
OS10(conf-if-eth1/1/2)# no switchport
OS10(conf-if-eth1/1/2)# ip address 172.17.2.1/31
OS10(conf-if-eth1/1/2)# exit
OS10(config)# interface ethernet1/1/3
OS10(conf-if-eth1/1/3)# no shutdown
OS10(conf-if-eth1/1/3)# no switchport
OS10(conf-if-eth1/1/3)# ip address 172.18.2.1/31
OS10(conf-if-eth1/1/3)# exit
OS10(config)# interface ethernet1/1/4
OS10(conf-if-eth1/1/4)# no shutdown
OS10(conf-if-eth1/1/4)# no switchport
OS10(conf-if-eth1/1/4)# ip address 172.19.2.1/31
OS10(conf-if-eth1/1/4)# exit

```

### 2. Configure eBGP.

```

OS10(config)# router bgp 101
OS10(config-router-bgp-101)# router-id 172.202.0.1
OS10(config-router-bgp-101)# address-family ipv4 unicast
OS10(configure-router-bgpv4-af)# redistribute connected
OS10(configure-router-bgpv4-af)# exit

```

### 3. Configure eBGP IPv4 peer sessions on the P2P links.

```

OS10(conf-router-bgp-101)# neighbor 172.16.2.0
OS10(conf-router-neighbor)# remote-as 100
OS10(conf-router-neighbor)# no shutdown
OS10(conf-router-neighbor)# address-family ipv4 unicast
OS10(conf-router-neighbor-af)# no sender-side-loop-detection
OS10(conf-router-neighbor-af)# exit
OS10(conf-router-neighbor)# exit

OS10(conf-router-bgp-101)# neighbor 172.17.2.0
OS10(conf-router-neighbor)# remote-as 100
OS10(conf-router-neighbor)# no shutdown
OS10(conf-router-neighbor)# address-family ipv4 unicast
OS10(conf-router-neighbor-af)# no sender-side-loop-detection
OS10(conf-router-neighbor-af)# exit
OS10(conf-router-neighbor)# exit

```

```

OS10(conf-router-bgp-101)# neighbor 172.18.2.0
OS10(conf-router-neighbor)# remote-as 100
OS10(conf-router-neighbor)# no shutdown
OS10(conf-router-neighbor)# address-family ipv4 unicast
OS10(conf-router-neighbor-af)# no sender-side-loop-detection
OS10(conf-router-neighbor-af)# exit
OS10(conf-router-neighbor)# exit

OS10(conf-router-bgp-101)# neighbor 172.19.2.0
OS10(conf-router-neighbor)# remote-as 100
OS10(conf-router-neighbor)# no shutdown
OS10(conf-router-neighbor)# address-family ipv4 unicast
OS10(conf-router-neighbor-af)# no sender-side-loop-detection
OS10(conf-router-neighbor-af)# exit
OS10(conf-router-neighbor)# exit
OS10(conf-router-bgp-101)# exit

```

#### 4. Configure a Loopback interface for BGP EVPN peering.

```

OS10(config)# interface loopback1
OS10(conf-if-lo-1)# no shutdown
OS10(conf-if-lo-1)# ip address 172.202.0.1/32
OS10(conf-if-lo-1)# exit

```

#### 5. Configure BGP EVPN peer sessions.

```

OS10(config)# router bgp 101
OS10(conf-router-bgp-101)# neighbor 172.16.0.1
OS10(conf-router-neighbor)# ebgp-multihop 4
OS10(conf-router-neighbor)# remote-as 100
OS10(conf-router-neighbor)# send-community extended
OS10(conf-router-neighbor)# update-source loopback1
OS10(conf-router-neighbor)# no shutdown
OS10(conf-router-neighbor)# address-family ipv4 unicast
OS10(conf-router-neighbor-af)# no activate
OS10(conf-router-neighbor-af)# exit
OS10(conf-router-neighbor)# address-family l2vpn evpn
OS10(conf-router-neighbor-af)# no sender-side-loop-detection
OS10(conf-router-neighbor-af)# activate
OS10(conf-router-neighbor-af)# exit

OS10(conf-router-bgp-101)# neighbor 172.17.0.1
OS10(conf-router-neighbor)# ebgp-multihop 4
OS10(conf-router-neighbor)# remote-as 100
OS10(conf-router-neighbor)# send-community extended
OS10(conf-router-neighbor)# update-source loopback1
OS10(conf-router-neighbor)# no shutdown
OS10(conf-router-neighbor)# address-family ipv4 unicast
OS10(conf-router-neighbor-af)# no activate
OS10(conf-router-neighbor-af)# exit
OS10(conf-router-neighbor)# address-family l2vpn evpn
OS10(conf-router-neighbor-af)# no sender-side-loop-detection
OS10(conf-router-neighbor-af)# activate
OS10(conf-router-neighbor-af)# exit

OS10(conf-router-bgp-101)# neighbor 172.18.0.1
OS10(conf-router-neighbor)# ebgp-multihop 4
OS10(conf-router-neighbor)# remote-as 100
OS10(conf-router-neighbor)# send-community extended
OS10(conf-router-neighbor)# update-source loopback1
OS10(conf-router-neighbor)# no shutdown
OS10(conf-router-neighbor)# address-family ipv4 unicast
OS10(conf-router-neighbor-af)# no activate
OS10(conf-router-neighbor-af)# exit
OS10(conf-router-neighbor)# address-family l2vpn evpn
OS10(conf-router-neighbor-af)# no sender-side-loop-detection
OS10(conf-router-neighbor-af)# activate
OS10(conf-router-neighbor-af)# exit

OS10(conf-router-bgp-101)# neighbor 172.19.0.1
OS10(conf-router-neighbor)# ebgp-multihop 4

```

```

OS10(conf-router-neighbor)# remote-as 100
OS10(conf-router-neighbor)# send-community extended
OS10(conf-router-neighbor)# update-source loopback1
OS10(conf-router-neighbor)# no shutdown
OS10(conf-router-neighbor)# address-family ipv4 unicast
OS10(conf-router-neighbor-af)# no activate
OS10(conf-router-neighbor-af)# exit
OS10(conf-router-neighbor)# address-family l2vpn evpn
OS10(conf-router-neighbor-af)# no sender-side-loop-detection
OS10(conf-router-neighbor-af)# activate
OS10(conf-router-neighbor-af)# exit

```

## Verify VXLAN with BGP EVPN configuration.

### 1. Verify virtual network configurations.

```

LEAF1# show virtual-network
Codes: DP - MAC-learn Dataplane, CP - MAC-learn Controlplane, UUD - Unknown-Unicast-Drop
Virtual Network: 10000
 Members:
 VLAN 100: port-channel10, port-channel1000
 VxLAN Virtual Network Identifier: 10000
 Source Interface: loopback0(192.168.1.1)
 Remote-VTEPs (flood-list): 192.168.2.1(CP)

Virtual Network: 20000
 Members:
 Untagged: port-channel20
 VLAN 200: port-channel1000
 VxLAN Virtual Network Identifier: 20000
 Source Interface: loopback0(192.168.1.1)
 Remote-VTEPs (flood-list): 192.168.2.1(CP)
LEAF1#

```

### 2. Verify EVPN configurations and EVPN parameters.

```

LEAF1# show evpn evi

EVI : 10000, State : up
 Bridge-Domain : Virtual-Network 10000, VNI 10000
 Route-Distinguisher : 1:192.168.1.1:10000(auto)
 Route-Targets : 0:100:268445456(auto) both
 Inclusive Multicast : 192.168.2.1
 IRB : Enabled(tenant1)

EVI : 20000, State : up
 Bridge-Domain : Virtual-Network 20000, VNI 20000
 Route-Distinguisher : 1:192.168.1.1:20000(auto)
 Route-Targets : 0:100:268455456(auto) both
 Inclusive Multicast : 192.168.2.1
 IRB : Enabled(tenant1)
LEAF1#

```

### 3. Verify BGP EVPN neighborship between leaf and spine nodes.

```

LEAF1# show ip bgp l2vpn evpn summary
BGP router identifier 172.16.0.1 local AS number 100
Neighbor AS MsgRcvd MsgSent Up/Down State/Pfx
172.201.0.1 101 1132 1116 13:29:00 27
172.202.0.1 101 1131 1118 13:29:02 28
LEAF1#

```

### 4. Check connectivity between host A and host B.

```

root@HOST-A:~# ping 10.2.0.10 -c 5
PING 10.2.0.10 (10.2.0.10) 56(84) bytes of data.
64 bytes from 10.2.0.10: icmp_seq=1 ttl=63 time=0.824 ms
64 bytes from 10.2.0.10: icmp_seq=2 ttl=63 time=0.847 ms
64 bytes from 10.2.0.10: icmp_seq=3 ttl=63 time=0.835 ms

```

```
64 bytes from 10.2.0.10: icmp_seq=4 ttl=63 time=0.944 ms
64 bytes from 10.2.0.10: icmp_seq=5 ttl=63 time=0.806 ms

--- 10.2.0.10 ping statistics ---
5 packets transmitted, 5 received, 0% packet loss, time 4078ms
rtt min/avg/max/mdev = 0.806/0.851/0.944/0.051 ms
root@HOST-A:~#
```

#### 5. Check connectivity between host A and host C.

```
root@HOST-A:~# ping 10.1.0.20 -c 5
PING 10.1.0.20 (10.1.0.20) 56(84) bytes of data.
64 bytes from 10.1.0.20: icmp_seq=1 ttl=64 time=0.741 ms
64 bytes from 10.1.0.20: icmp_seq=2 ttl=64 time=0.737 ms
64 bytes from 10.1.0.20: icmp_seq=3 ttl=64 time=0.772 ms
64 bytes from 10.1.0.20: icmp_seq=4 ttl=64 time=0.799 ms
64 bytes from 10.1.0.20: icmp_seq=5 ttl=64 time=0.866 ms

--- 10.1.0.20 ping statistics ---
5 packets transmitted, 5 received, 0% packet loss, time 4061ms
rtt min/avg/max/mdev = 0.737/0.783/0.866/0.047 ms
root@HOST-A:~#
```

#### 6. Check connectivity between host A and host D.

```
root@HOST-A:~# ping 10.2.0.20 -c 5
PING 10.2.0.20 (10.2.0.20) 56(84) bytes of data.
64 bytes from 10.2.0.20: icmp_seq=1 ttl=63 time=0.707 ms
64 bytes from 10.2.0.20: icmp_seq=2 ttl=63 time=0.671 ms
64 bytes from 10.2.0.20: icmp_seq=3 ttl=63 time=0.687 ms
64 bytes from 10.2.0.20: icmp_seq=4 ttl=63 time=0.640 ms
64 bytes from 10.2.0.20: icmp_seq=5 ttl=63 time=0.644 ms

--- 10.2.0.20 ping statistics ---
5 packets transmitted, 5 received, 0% packet loss, time 4089ms
rtt min/avg/max/mdev = 0.640/0.669/0.707/0.041 ms
root@HOST-A:~#
```

**NOTE:** Follow Steps 1 to 6 to check ping connectivity between combinations of other hosts, and between hosts through different virtual-network IP addresses.

## Example: VXLAN BGP EVPN — Multiple AS topology

The following VXLAN with BGP EVPN example uses a Clos leaf-spine example. The individual switch configuration shows how to set up an end-to-end VXLAN. eBGP is used to exchange IP routes in the IP underlay network, and EVPN routes in the VXLAN overlay network. All VTEPs perform asymmetric IRB routing, in which:

- IRB routing is performed only on ingress VTEPs.
- Egress VTEPs perform IRB bridging.

In this example, each node in the spine network and each VTEP in the leaf network belongs to a different autonomous system. Spine switch 1 is in AS 101. Spine switch 2 is in AS 102. For leaf nodes, VLT domain 1 is in AS 99; VLT domain 2 is in AS 100.

- On VTEPs 1 and 2: Access ports are assigned to the virtual network using a switch-scoped VLAN. EVPN instance along with RD and RT values are configured in manual mode.
- On VTEPs 3 and 4: Access ports are assigned to the virtual network using a port-scoped VLAN. EVPN instance along with RD and RT values are configured in manual mode.

**NOTE:** In multiple AS topology, you can configure route targets in an easier way using the `disable-rt-asn` command with `route-target auto` or `auto evi` commands.

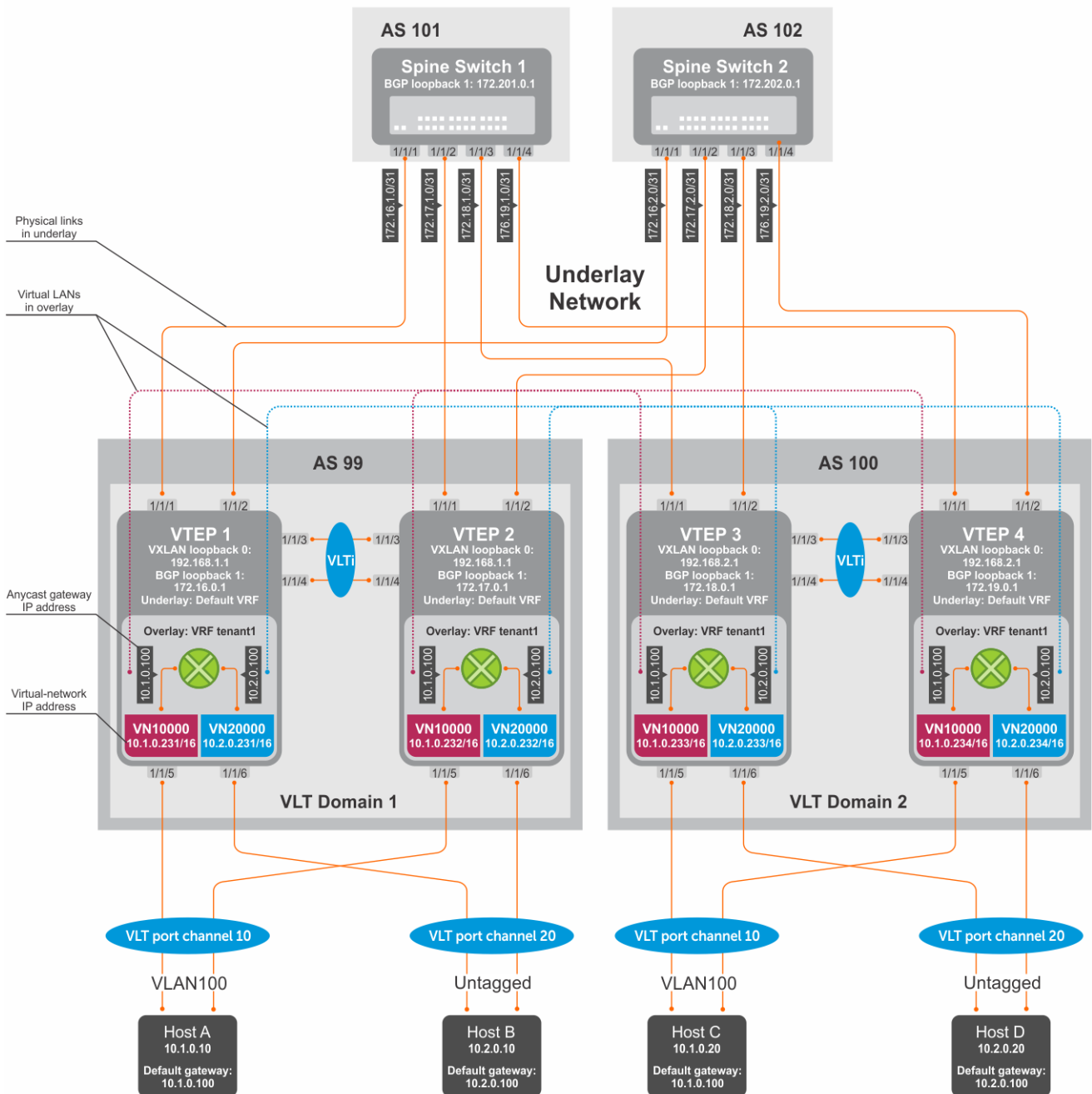

Figure 16. VXLAN BGP EVPN with multiple AS

## VTEP 1 Leaf Switch

1. Configure a Loopback interface for the VXLAN underlay using same IP address as the VLT peer.

```
OS10(config)# interface loopback0
OS10(conf-if-lo-0)# no shutdown
OS10(conf-if-lo-0)# ip address 192.168.1.1/32
OS10(conf-if-lo-0)# exit
```

2. Configure the Loopback interface as the VXLAN source tunnel interface.

```
OS10(config)# nve
OS10(config-nve)# source-interface loopback0
OS10(config-nve)# exit
```

### 3. Configure VXLAN virtual networks.

```
OS10(config)# virtual-network 10000
OS10(config-vn-10000)# vxlan-vni 10000
OS10(config-vn-vxlan-vni)# exit
OS10(config-vn-10000)# exit
OS10(config)# virtual-network 20000
OS10(config-vn-20000)# vxlan-vni 20000
OS10(config-vn-vxlan-vni)# exit
OS10(config-vn-20000)# exit
```

### 4. Assign VLAN member interfaces to the virtual networks.

Use a switch-scoped VLAN-to-VNI mapping:

```
OS10(config)# interface vlan100
OS10(config-if-vl-100)# virtual-network 10000
OS10(config-if-vl-100)# no shutdown
OS10(config-if-vl-100)# exit
OS10(config)# interface vlan200
OS10(config-if-vl-200)# virtual-network 20000
OS10(config-if-vl-200)# no shutdown
OS10(config-if-vl-200)# exit
```

### 5. Configure access ports as VLAN members for a switch-scoped VLAN-to-VNI mapping.

```
OS10(config)# interface port-channel10
OS10(config-if-po-10)# no shutdown
OS10(config-if-po-10)# switchport mode trunk
OS10(config-if-po-10)# switchport trunk allowed vlan 100
OS10(config-if-po-10)# no switchport access vlan
OS10(config-if-po-10)# exit

OS10(config)# interface ethernet1/1/5
OS10(config-if-eth1/1/5)# no shutdown
OS10(config-if-eth1/1/5)# channel-group 10 mode active
OS10(config-if-eth1/1/5)# no switchport
OS10(config-if-eth1/1/5)# exit

OS10(config)# interface port-channel20
OS10(config-if-po-20)# no shutdown
OS10(config-if-po-20)# switchport mode trunk
OS10(config-if-po-20)# switchport access vlan 200
OS10(config-if-po-20)# exit

OS10(config)# interface ethernet1/1/6
OS10(config-if-eth1/1/6)# no shutdown
OS10(config-if-eth1/1/6)# channel-group 20 mode active
OS10(config-if-eth1/1/6)# no switchport
OS10(config-if-eth1/1/6)# exit
```

### 6. Configure upstream network-facing ports.

```
OS10(config)# interface ethernet1/1/1
OS10(config-if-eth1/1/1)# no shutdown
OS10(config-if-eth1/1/1)# no switchport
OS10(config-if-eth1/1/1)# mtu 1650
OS10(config-if-eth1/1/1)# ip address 172.16.1.0/31
OS10(config-if-eth1/1/1)# exit

OS10(config)# interface ethernet1/1/2
OS10(config-if-eth1/1/2)# no shutdown
OS10(config-if-eth1/1/2)# no switchport
OS10(config-if-eth1/1/1)# mtu 1650
OS10(config-if-eth1/1/2)# ip address 172.16.2.0/31
OS10(config-if-eth1/1/2)# exit
```

### 7. Configure eBGP.

```
OS10(config)# router bgp 99
OS10(config-router-bgp-99)# router-id 172.16.0.1
```

```
OS10(config-router-bgp-99)# address-family ipv4 unicast
OS10(config-router-bgp-af)# redistribute connected
OS10(config-router-bgp-af)# exit
```

## 8. Configure eBGP for the IPv4 point-to-point peering.

```
OS10(config-router-bgp-99)# neighbor 172.16.1.1
OS10(config-router-neighbor)# remote-as 101
OS10(config-router-neighbor)# no shutdown
OS10(config-router-neighbor)# exit
OS10(config-router-bgp-99)# neighbor 172.16.2.1
OS10(config-router-neighbor)# remote-as 102
OS10(config-router-neighbor)# no shutdown
OS10(config-router-neighbor)# exit
OS10(config-router-bgp-99)# exit
```

## 9. Configure a Loopback interface for BGP EVPN peering different from the VLT peer IP address.

```
OS10(config)# interface loopback1
OS10(conf-if-lo-1)# no shutdown
OS10(conf-if-lo-1)# ip address 172.16.0.1/32
OS10(conf-if-lo-1)# exit
```

## 10. Configure BGP EVPN peering.

```
OS10(config)# router bgp 99
OS10(config-router-bgp-99)# neighbor 172.201.0.1
OS10(config-router-neighbor)# remote-as 101
OS10(config-router-neighbor)# ebgp-multihop 4
OS10(config-router-neighbor)# send-community extended
OS10(config-router-neighbor)# update-source loopback1
OS10(config-router-neighbor)# no shutdown
OS10(config-router-neighbor)# address-family ipv4 unicast
OS10(config-router-bgp-neighbor-af)# no activate
OS10(config-router-bgp-neighbor-af)# exit
OS10(config-router-neighbor)# address-family l2vpn evpn
OS10(config-router-bgp-neighbor-af)# activate
OS10(config-router-bgp-neighbor-af)# exit
OS10(config-router-neighbor)# exit

OS10(config-router-bgp-99)# neighbor 172.202.0.1
OS10(config-router-neighbor)# remote-as 102
OS10(config-router-neighbor)# ebgp-multihop 4
OS10(config-router-neighbor)# send-community extended
OS10(config-router-neighbor)# update-source loopback1
OS10(config-router-neighbor)# no shutdown
OS10(config-router-neighbor)# address-family ipv4 unicast
OS10(config-router-bgp-neighbor-af)# no activate
OS10(config-router-bgp-neighbor-af)# exit
OS10(config-router-neighbor)# address-family l2vpn evpn
OS10(config-router-bgp-neighbor-af)# activate
OS10(config-router-bgp-neighbor-af)# exit
OS10(config-router-neighbor)# exit
OS10(config-router-bgp-100)# exit
```

## 11. Configure EVPN.

Configure the EVPN instance with RD and RT values in manual mode:

```
OS10(config)# evpn
OS10(config-evpn)# evi 10000
OS10(config-evpn-evi-10000)# vni 10000
OS10(config-evpn-evi-10000)# rd 192.168.1.1:10000
OS10(config-evpn-evi-10000)# route-target 99:10000 both
OS10(config-evpn-evi-10000)# route-target 100:10000 import
OS10(config-evpn-evi-10000)#exit

OS10(config-evpn)# evi 20000
OS10(config-evpn-evi-20000)# vni 20000
OS10(config-evpn-evi-20000)# rd 192.168.1.1:20000
OS10(config-evpn-evi-20000)# route-target 99:20000 both
```



```
OS10(config-evpn-evi-20000)# route-target 100:20000 import
OS10(config-evpn-evi-20000)#exit
OS10(config-evpn)#
```

## 12. Configure VLT.

**Configure a dedicated L3 underlay path to reach the VLT Peer in case of a network failure.**

```
OS10(config)# interface vlan4000
OS10(config-if-vl-4000)# no shutdown
OS10(config-if-vl-4000)# ip address 172.16.250.0/31
OS10(config-if-vl-4000)# exit
```

**Configure the VLT port channel.**

```
OS10(config)# interface port-channel10
OS10(conf-if-po-10)# vlt-port-channel 10
OS10(conf-if-po-10)# exit

OS10(config)# interface port-channel20
OS10(conf-if-po-20)# vlt-port-channel 20
OS10(conf-if-po-20)# exit
```

**Configure the VLTi member links.**

```
OOS10(config)# interface ethernet1/1/3
OS10(conf-if-eth1/1/3)# no shutdown
OS10(conf-if-eth1/1/3)# no switchport
OS10(conf-if-eth1/1/3)# exit

OS10(config)# interface ethernet1/1/4
OS10(conf-if-eth1/1/4)# no shutdown
OS10(conf-if-eth1/1/4)# no switchport
OS10(conf-if-eth1/1/4)# exit
```

**Configure the VLT domain.**

```
OS10(config)# vlt-domain 1
OS10(conf-vlt-1)# backup destination 10.16.150.1
OS10(conf-vlt-1)# discovery-interface ethernet1/1/3,1/1/4
OS10(conf-vlt-1)# vlt-mac aa:bb:cc:dd:ee:ff
OS10(conf-vlt-1)# exit
```

**Configure UFD with uplink VLT ports and downlink network ports.**

```
OS10(config)# uplink-state-group 1
OS10(conf-uplink-state-group-1)# enable
OS10(conf-uplink-state-group-1)# downstream ethernet1/1/1-1/1/2
OS10(conf-uplink-state-group-1)# upstream port-channel10
OS10(conf-uplink-state-group-1)# upstream port-channel20
OS10(conf-uplink-state-group-1)# exit
```

**Configure iBGP IPv4 peering between VLT peers.**

```
OS10(config)# router bgp 99
OS10(config-router-bgp-99)# neighbor 172.16.250.1
OS10(config-router-neighbor)# remote-as 99
OS10(config-router-neighbor)# no shutdown
OS10(config-router-neighbor)# exit
OS10(config-router-bgp-99)# exit
```

## 13. Configure IP switching in the overlay network.

**Create a tenant VRF**

```
OS10(config)# ip vrf tenant1
OS10(conf-vrf)# exit
```

### Configure an anycast gateway MAC address.

```
OS10(config)# ip virtual-router mac-address 00:01:01:01:01:01
```

### Configure routing on the virtual networks.

```
OS10(config)# interface virtual-network10000
OS10(config-if-vn-10000)# ip vrf forwarding tenant1
OS10(config-if-vn-10000)# ip address 10.1.0.231/16
OS10(config-if-vn-10000)# ip virtual-router address 10.1.0.100
OS10(config-if-vn-10000)# no shutdown
OS10(config-if-vn-10000)# exit

OS10(config)# interface virtual-network20000
OS10(config-if-vn-20000)# ip vrf forwarding tenant1
OS10(config-if-vn-20000)# ip address 10.2.0.231/16
OS10(config-if-vn-20000)# ip virtual-router address 10.2.0.100
OS10(config-if-vn-20000)# no shutdown
OS10(config-if-vn-20000)# exit
```

## VTEP 2 Leaf Switch

### 1. Configure a Loopback interface for the VXLAN underlay using the same IP address as the VLT peer.

```
OS10(config)# interface loopback0
OS10(config-if-lo-0)# no shutdown
OS10(config-if-lo-0)# ip address 192.168.1.1/32
OS10(config-if-lo-0)# exit
```

### 2. Configure the Loopback interface as the VXLAN source tunnel interface.

```
OS10(config)# nve
OS10(config-nve)# source-interface loopback0
OS10(config-nve)# exit
```

### 3. Configure the VXLAN virtual networks.

```
OS10(config)# virtual-network 10000
OS10(config-vn-10000)# vxlan-vni 10000
OS10(config-vn-vxlan-vni)# exit
OS10(config-vn)# exit
OS10(config)# virtual-network 20000
OS10(config-vn-20000)# vxlan-vni 20000
OS10(config-vn-vxlan-vni)# exit
OS10(config-vn-20000)# exit
```

### 4. Assign VLAN member interfaces to the virtual networks.

Use a switch-scoped VLAN-to-VNI mapping:

```
OS10(config)# interface vlan100
OS10(config-if-vl-100)# virtual-network 10000
OS10(config-if-vl-100)# no shutdown
OS10(config-if-vl-100)# exit
OS10(config)# interface vlan200
OS10(config-if-vl-200)# virtual-network 20000
OS10(config-if-vl-200)# no shutdown
OS10(config-if-vl-200)# exit
```

### 5. Configure access ports as VLAN members for a switch-scoped VLAN-to-VNI mapping.

```
OS10(config)# interface port-channel10
OS10(config-if-po-10)# no shutdown
OS10(config-if-po-10)# switchport mode trunk
OS10(config-if-po-10)# switchport trunk allowed vlan 100
OS10(config-if-po-10)# no switchport access vlan
OS10(config-if-po-10)# exit
```

```

OS10(config)# interface ethernet1/1/5
OS10(conf-if-eth1/1/5)# no shutdown
OS10(conf-if-eth1/1/5)# channel-group 10 mode active
OS10(conf-if-eth1/1/5)# no switchport
OS10(conf-if-eth1/1/5)# exit

OS10(config)# interface port-channel20
OS10(conf-if-po-20)# no shutdown
OS10(conf-if-po-20)# switchport mode trunk
OS10(conf-if-po-20)# switchport access vlan 200
OS10(conf-if-po-20)# exit

OS10(config)# interface ethernet1/1/6
OS10(conf-if-eth1/1/6)# no shutdown
OS10(conf-if-eth1/1/6)# channel-group 20 mode active
OS10(conf-if-eth1/1/6)# no switchport
OS10(conf-if-eth1/1/6)# exit

```

## 6. Configure upstream network-facing ports.

```

OS10(config)# interface ethernet1/1/1
OS10(conf-if-eth1/1/1)# no shutdown
OS10(conf-if-eth1/1/1)# no switchport
OS10(conf-if-eth1/1/1)# mtu 1650
OS10(conf-if-eth1/1/1)# ip address 172.17.1.0/31
OS10(conf-if-eth1/1/1)# exit

OS10(config)# interface ethernet1/1/2
OS10(conf-if-eth1/1/2)# no shutdown
OS10(conf-if-eth1/1/2)# no switchport
OS10(conf-if-eth1/1/2)# mtu 1650
OS10(conf-if-eth1/1/2)# ip address 172.17.2.0/31
OS10(conf-if-eth1/1/2)# exit

```

## 7. Configure eBGP.

```

OS10(config)# router bgp 99
OS10(config-router-bgp-99)# router-id 172.17.0.1
OS10(config-router-bgp-99)# address-family ipv4 unicast
OS10(configure-router-bgp-af)# redistribute connected
OS10(configure-router-bgp-af)# exit

```

## 8. Configure eBGP for the IPv4 point-to-point peering.

```

OS10(config-router-bgp-99)# neighbor 172.17.1.1
OS10(config-router-neighbor)# remote-as 101
OS10(config-router-neighbor)# no shutdown
OS10(config-router-neighbor)# exit

OS10(config-router-bgp-99)# neighbor 172.17.2.1
OS10(config-router-neighbor)# remote-as 102
OS10(config-router-neighbor)# no shutdown
OS10(config-router-neighbor)# exit
OS10(config-router-bgp-99)# exit

```

## 9. Configure a Loopback interface for BGP EVPN peering different from VLT peer IP address.

```

OS10(config)# interface loopback1
OS10(conf-if-lo-1)# no shutdown
OS10(conf-if-lo-1)# ip address 172.17.0.1/32
OS10(conf-if-lo-1)# exit

```

## 10. Configure BGP EVPN peering.

```

OS10(config)# router bgp 99
OS10(config-router-bgp-99)# neighbor 172.201.0.1
OS10(config-router-neighbor)# remote-as 101
OS10(config-router-neighbor)# ebgp-multihop 4
OS10(config-router-neighbor)# send-community extended
OS10(config-router-neighbor)# update-source loopback1
OS10(config-router-neighbor)# no shutdown

```

```

OS10(config-router-neighbor)# address-family ipv4 unicast
OS10(config-router-bgp-neighbor-af)# no activate
OS10(config-router-bgp-neighbor-af)# exit
OS10(config-router-neighbor)# address-family l2vpn evpn
OS10(config-router-bgp-neighbor-af)# activate
OS10(config-router-bgp-neighbor-af)# exit
OS10(config-router-neighbor)# exit

OS10(config-router-bgp-99)# neighbor 172.202.0.1
OS10(config-router-neighbor)# remote-as 102
OS10(config-router-neighbor)# ebgp-multihop 4
OS10(config-router-neighbor)# send-community extended
OS10(config-router-neighbor)# update-source loopback1
OS10(config-router-neighbor)# no shutdown
OS10(config-router-bgp-neighbor)# address-family ipv4 unicast
OS10(config-router-bgp-neighbor-af)# no activate
OS10(config-router-bgp-neighbor-af)# exit
OS10(config-router-neighbor)# address-family l2vpn evpn
OS10(config-router-bgp-neighbor-af)# activate
OS10(config-router-bgp-neighbor-af)# exit
OS10(config-router-neighbor)# exit
OS10(config-router-bgp-99)# exit

```

## 11. Configure EVPN.

Configure the EVPN instance with RD and RT in manual configuration mode:

```

OS10(config)# evpn
OS10(config-evpn)# evi 10000
OS10(config-evpn-evi-10000)# vni 10000
OS10(config-evpn-evi-10000)# rd 192.168.1.1:10000
OS10(config-evpn-evi-10000)# route-target 99:10000 both
OS10(config-evpn-evi-10000)# route-target 100:10000 import
OS10(config-evpn-evi-10000)#exit

OS10(config-evpn)# evi 20000
OS10(config-evpn-evi-20000)# vni 20000
OS10(config-evpn-evi-20000)# rd 192.168.1.1:20000
OS10(config-evpn-evi-20000)# route-target 99:20000 both
OS10(config-evpn-evi-20000)# route-target 100:20000 import
OS10(config-evpn-evi-20000)#exit
OS10(config-evpn)#

```

## 12. Configure VLT.

Configure a dedicated L3 underlay path to reach the VLT Peer in case of a network failure.

```

OS10(config)# interface vlan4000
OS10(config-if-vl-4000)# no shutdown
OS10(config-if-vl-4000)# ip address 172.16.250.1/31
OS10(config-if-vl-4000)# exit

```

Configure the VLT port channel.

```

OS10(config)# interface port-channel10
OS10(conf-if-po-10)# vlt-port-channel 10
OS10(conf-if-po-10)# exit

OS10(config)# interface port-channel20
OS10(conf-if-po-20)# vlt-port-channel 20
OS10(conf-if-po-20)# exit

```

Configure VLTi member links.

```

OOS10(config)# interface ethernet1/1/3
OS10(conf-if-eth1/1/3)# no shutdown
OS10(conf-if-eth1/1/3)# no switchport
OS10(conf-if-eth1/1/3)# exit

OS10(config)# interface ethernet1/1/4
OS10(conf-if-eth1/1/4)# no shutdown

```

```
OS10(config-if-eth1/1/4)# no switchport
OS10(config-if-eth1/1/4)# exit
```

### Configure the VLT domain.

```
OS10(config)# vlt-domain 1
OS10(config-vlt-1)# backup destination 10.16.150.2
OS10(config-vlt-1)# discovery-interface ethernet1/1/3,1/1/4
OS10(config-vlt-1)# vlt-mac aa:bb:cc:dd:ee:ff
OS10(config-vlt-1)# exit
```

### Configure UFD with uplink VLT ports and downlink network ports.

```
OS10(config)# uplink-state-group 1
OS10(config-uplink-state-group-1)# enable
OS10(config-uplink-state-group-1)# downstream ethernet1/1/1-1/1/2
OS10(config-uplink-state-group-1)# upstream port-channel10
OS10(config-uplink-state-group-1)# upstream port-channel20
OS10(config-uplink-state-group-1)# exit
```

### Configure iBGP IPv4 peering between VLT peers.

```
OS10(config)# router bgp 99
OS10(config-router-bgp-99)# neighbor 172.16.250.0
OS10(config-router-neighbor)# remote-as 99
OS10(config-router-neighbor)# no shutdown
OS10(config-router-neighbor)# exit
OS10(config-router-bgp-99)# exit
```

## 13. Configure IP switching in overlay network.

### Create a tenant VRF.

```
OS10(config)# ip vrf tenant1
OS10(config-vrf)# exit
```

### Configure an anycast gateway MAC address.

```
OS10(config)# ip virtual-router mac-address 00:01:01:01:01:01
```

### Configure routing on the virtual networks.

```
OS10(config)# interface virtual-network10000
OS10(config-if-vn-10000)# ip vrf forwarding tenant1
OS10(config-if-vn-10000)# ip address 10.1.0.232/16
OS10(config-if-vn-10000)# ip virtual-router address 10.1.0.100
OS10(config-if-vn-10000)# no shutdown
OS10(config-if-vn-10000)# exit

OS10(config)# interface virtual-network20000
OS10(config-if-vn-20000)# ip vrf forwarding tenant1
OS10(config-if-vn-20000)# ip address 10.2.0.232/16
OS10(config-if-vn-20000)# ip virtual-router address 10.2.0.100
OS10(config-if-vn-20000)# no shutdown
OS10(config-if-vn-20000)# exit
```

## VTEP 3 Leaf Switch

### 1. Configure a Loopback interface for the VXLAN underlay using same IP address as the VLT peer.

```
OS10(config)# interface loopback0
OS10(config-if-lo-0)# no shutdown
OS10(config-if-lo-0)# ip address 192.168.2.1/32
OS10(config-if-lo-0)# exit
```

## 2. Configure the Loopback interface as the VXLAN source tunnel interface.

```
OS10(config)# nve
OS10(config-nve)# source-interface loopback0
OS10(config-nve)# exit
```

## 3. Configure VXLAN virtual networks.

```
OS10(config)# virtual-network 10000
OS10(config-vn-10000)# vxlan-vni 10000
OS10(config-vn-vxlan-vni)# exit
OS10(config-vn-10000)# exit

OS10(config)# virtual-network 20000
OS10(config-vn-20000)# vxlan-vni 20000
OS10(config-vn-vxlan-vni)# exit
OS10(config-vn-20000)# exit
```

## 4. Configure unused VLAN ID for untagged membership.

```
OS10(config)# virtual-network untagged-vlan 1000
```

## 5. Configure access ports as VLAN members for a port-scoped VLAN-to-VNI mapping.

```
OS10(config)# interface port-channel10
OS10(conf-if-po-10)# no shutdown
OS10(conf-if-po-10)# switchport mode trunk
OS10(conf-if-po-10)# no switchport access vlan
OS10(conf-if-po-10)# exit

OS10(config)# interface ethernet1/1/5
OS10(conf-if-eth1/1/5)# no shutdown
OS10(conf-if-eth1/1/5)# channel-group 10 mode active
OS10(conf-if-eth1/1/5)# no switchport
OS10(conf-if-eth1/1/5)# exit

OS10(config)# interface port-channel20
OS10(conf-if-po-20)# no shutdown
OS10(conf-if-po-20)# switchport mode trunk
OS10(conf-if-po-20)# no switchport access vlan
OS10(conf-if-po-20)# exit

OS10(config)# interface ethernet1/1/6
OS10(conf-if-eth1/1/6)# no shutdown
OS10(conf-if-eth1/1/6)# channel-group 20 mode active
OS10(conf-if-eth1/1/6)# no switchport
OS10(conf-if-eth1/1/6)# exit
```

## 6. Add the access ports to virtual networks.

```
OS10(config)# virtual-network 10000
OS10(config-vn-10000)# member-interface port-channel 10 vlan-tag 100
OS10(config-vn-10000)# exit

OS10(config)# virtual-network 20000
OS10(config-vn-20000)# member-interface port-channel 20 untagged
OS10(config-vn-20000)# exit
```

## 7. Configure upstream network-facing ports.

```
OS10(config)# interface ethernet1/1/1
OS10(conf-if-eth1/1/1)# no shutdown
OS10(conf-if-eth1/1/1)# no switchport
OS10(conf-if-eth1/1/1)# mtu 1650
OS10(conf-if-eth1/1/1)# ip address 172.18.1.0/31
OS10(conf-if-eth1/1/1)# exit

OS10(config)# interface ethernet1/1/2
OS10(conf-if-eth1/1/2)# no shutdown
OS10(conf-if-eth1/1/2)# no switchport
```

```
OS10(config-if-eth1/1/1)# mtu 1650
OS10(config-if-eth1/1/2)# ip address 172.18.2.0/31
OS10(config-if-eth1/1/2)# exit
```

## 8. Configure eBGP.

```
OS10(config)# router bgp 100
OS10(config-router-bgp-100)# router-id 172.18.0.1
OS10(config-router-bgp-100)# address-family ipv4 unicast
OS10(configure-router-bgp-af)# redistribute connected
OS10(configure-router-bgp-af)# exit
```

## 9. Configure eBGP for the IPv4 point-to-point peering.

```
OS10(config-router-bgp-100)# neighbor 172.18.1.1
OS10(config-router-neighbor)# remote-as 101
OS10(config-router-neighbor)# no shutdown
OS10(config-router-neighbor)# exit

OS10(config-router-bgp-100)# neighbor 172.18.2.1
OS10(config-router-neighbor)# remote-as 102
OS10(config-router-neighbor)# no shutdown
OS10(config-router-neighbor)# exit
OS10(config-router-bgp-100)# exit
```

## 10. Configure a Loopback interface for BGP EVPN peering different from VLT peer IP address.

```
OS10(config)# interface loopback1
OS10(conf-if-lo-1)# no shutdown
OS10(conf-if-lo-1)# ip address 172.18.0.1/32
OS10(conf-if-lo-1)# exit
```

## 11. Configure BGP EVPN peering.

```
OS10(config)# router bgp 100
OS10(config-router-bgp-100)# neighbor 172.201.0.1
OS10(config-router-neighbor)# remote-as 101
OS10(config-router-neighbor)# ebgp-multihop 4
OS10(config-router-neighbor)# send-community extended
OS10(config-router-neighbor)# update-source loopback1
OS10(config-router-neighbor)# no shutdown
OS10(config-router-neighbor)# address-family ipv4 unicast
OS10(config-router-bgp-neighbor-af)# no activate
OS10(config-router-bgp-neighbor-af)# exit
OS10(config-router-neighbor)# address-family l2vpn evpn
OS10(config-router-bgp-neighbor-af)# activate
OS10(config-router-bgp-neighbor-af)# exit
OS10(config-router-neighbor)# exit

OS10(config-router-bgp-100)# neighbor 172.202.0.1
OS10(config-router-neighbor)# remote-as 102
OS10(config-router-neighbor)# ebgp-multihop 4
OS10(config-router-neighbor)# send-community extended
OS10(config-router-neighbor)# update-source loopback1
OS10(config-router-neighbor)# no shutdown
OS10(config-router-neighbor)# address-family ipv4 unicast
OS10(config-router-bgp-neighbor-af)# no activate
OS10(config-router-bgp-neighbor-af)# exit
OS10(config-router-neighbor)# address-family l2vpn evpn
OS10(config-router-bgp-neighbor-af)# activate
OS10(config-router-bgp-neighbor-af)# exit
OS10(config-router-neighbor)# exit
OS10(config-router-bgp-100)# exit
```

## 12. Configure EVPN.

Configure the EVPN instance, RD, and RT in manual configuration mode:

```
OS10(config)# evpn
OS10(config-evpn)# evi 10000
OS10(config-evpn-evi-10000)# vni 10000
```

```

OS10(config-evpn-evi-10000)# rd 192.168.2.1:10000
OS10(config-evpn-evi-10000)# route-target 99:10000 import
OS10(config-evpn-evi-10000)# route-target 100:10000 both
OS10(config-evpn-evi-10000)#exit

OS10(config-evpn)# evi 20000
OS10(config-evpn-evi-20000)# vni 20000
OS10(config-evpn-evi-20000)# rd 192.168.2.1:20000
OS10(config-evpn-evi-20000)# route-target 99:20000 import
OS10(config-evpn-evi-20000)# route-target 100:20000 both
OS10(config-evpn-evi-20000)#exit
OS10(config-evpn)#

```

### 13. Configure VLT.

#### Configure a VLTi VLAN for the virtual network.

```

OS10(config)# virtual-network 10000
OS10(config-vn-10000)# vlti-vlan 100
OS10(config-vn-10000)# exit

OS10(config)# virtual-network 20000
OS10(config-vn-20000)# vlti-vlan 200
OS10(config-vn-20000)# exit

```

#### Configure a dedicated L3 underlay path to reach the VLT Peer in case of a network failure.

```

OS10(config)# interface vlan4000
OS10(config-if-vl-4000)# no shutdown
OS10(config-if-vl-4000)# ip address 172.16.250.10/31
OS10(config-if-vl-4000)# exit

```

#### Configure the VLT port channels.

```

OS10(config)# interface port-channel10
OS10(conf-if-po-10)# vlt-port-channel 10
OS10(conf-if-po-10)# exit

OS10(config)# interface port-channel20
OS10(conf-if-po-20)# vlt-port-channel 20
OS10(conf-if-po-20)# exit

```

#### Configure VLTi member links.

```

OOS10(config)# interface ethernet1/1/3
OS10(conf-if-eth1/1/3)# no shutdown
OS10(conf-if-eth1/1/3)# no switchport
OS10(conf-if-eth1/1/3)# exit

OS10(config)# interface ethernet1/1/4
OS10(conf-if-eth1/1/4)# no shutdown
OS10(conf-if-eth1/1/4)# no switchport
OS10(conf-if-eth1/1/4)# exit

```

#### Configure the VLT domain.

```

OS10(config)# vlt-domain 1
OS10(conf-vlt-1)# backup destination 10.16.150.3
OS10(conf-vlt-1)# discovery-interface ethernet1/1/3,1/1/4
OS10(conf-vlt-1)# vlt-mac aa:bb:cc:dd:ff:ee
OS10(conf-vlt-1)# exit

```

#### Configure UFD with uplink VLT ports and downlink network ports.

```

OS10(config)# uplink-state-group 1
OS10(conf-uplink-state-group-1)# enable
OS10(conf-uplink-state-group-1)# downstream ethernet1/1/1-1/1/2
OS10(conf-uplink-state-group-1)# upstream port-channel10
OS10(conf-uplink-state-group-1)# upstream port-channel20
OS10(conf-uplink-state-group-1)# exit

```



### Configure iBGP IPv4 peering between VLT peers.

```
OS10(config)# router bgp 100
OS10(config-router-bgp-100)# neighbor 172.16.250.11
OS10(config-router-neighbor)# remote-as 100
OS10(config-router-neighbor)# no shutdown
OS10(config-router-neighbor)# exit
OS10(config-router-bgp-100)# exit
```

### 14. Configure IP routing in the overlay network.

#### Create the tenant VRF.

```
OS10(config)# ip vrf tenant1
OS10(conf-vrf)# exit
```

#### Configure an anycast gateway MAC address.

```
OS10(config)# ip virtual-router mac-address 00:01:01:01:01:01
```

#### Configure routing on the virtual networks.

```
OS10(config)# interface virtual-network10000
OS10(conf-if-vn-10000)# ip vrf forwarding tenant1
OS10(conf-if-vn-10000)# ip address 10.1.0.233/16
OS10(conf-if-vn-10000)# ip virtual-router address 10.1.0.100
OS10(conf-if-vn-10000)# no shutdown
OS10(conf-if-vn-10000)# exit

OS10(config)# interface virtual-network20000
OS10(conf-if-vn-20000)# ip vrf forwarding tenant1
OS10(conf-if-vn-20000)# ip address 10.2.0.233/16
OS10(conf-if-vn-20000)# ip virtual-router address 10.2.0.100
OS10(conf-if-vn-20000)# no shutdown
OS10(conf-if-vn-20000)# exit
```

## VTEP 4 Leaf Switch

### 1. Configure a Loopback interface for the VXLAN underlay using same IP address as the VLT peer.

```
OS10(config)# interface loopback0
OS10(conf-if-lo-0)# no shutdown
OS10(conf-if-lo-0)# ip address 192.168.2.1/32
OS10(conf-if-lo-0)# exit
```

### 2. Configure the Loopback interface as the VXLAN source tunnel interface.

```
OS10(config)# nve
OS10(config-nve)# source-interface loopback0
OS10(config-nve)# exit
```

### 3. Configure the VXLAN virtual networks.

```
OS10(config)# virtual-network 10000
OS10(config-vn-10000)# vxlan-vni 10000
OS10(config-vn-vxlan-vni)# exit
OS10(config-vn-10000)# exit

OS10(config)# virtual-network 20000
OS10(config-vn-20000)# vxlan-vni 20000
OS10(config-vn-vxlan-vni)# exit
OS10(config-vn-20000)# exit
```

### 4. Configure the unused VLAN ID for untagged membership.

```
OS10(config)# virtual-network untagged-vlan 1000
```

## 5. Configure access ports as VLAN members for a port-scoped VLAN-to-VNI mapping.

```
OS10(config)# interface port-channel10
OS10(config-if-po-10)# no shutdown
OS10(config-if-po-10)# switchport mode trunk
OS10(config-if-po-10)# no switchport access vlan
OS10(config-if-po-10)# exit

OS10(config)# interface ethernet1/1/5
OS10(config-if-eth1/1/5)# no shutdown
OS10(config-if-eth1/1/5)# channel-group 10 mode active
OS10(config-if-eth1/1/5)# no switchport
OS10(config-if-eth1/1/5)# exit

OS10(config)# interface port-channel20
OS10(config-if-po-20)# no shutdown
OS10(config-if-po-20)# switchport mode trunk
OS10(config-if-po-20)# no switchport access vlan
OS10(config-if-po-20)# exit

OS10(config)# interface ethernet1/1/6
OS10(config-if-eth1/1/6)# no shutdown
OS10(config-if-eth1/1/6)# channel-group 20 mode active
OS10(config-if-eth1/1/6)# no switchport
OS10(config-if-eth1/1/6)# exit
```

## 6. Add the access ports to the virtual networks.

```
OS10(config)# virtual-network 10000
OS10(config-vn-10000)# member-interface port-channel 10 vlan-tag 100
OS10(config-vn)# exit

OS10(config)# virtual-network 20000
OS10(config-vn-20000)# member-interface port-channel 20 untagged
OS10(config-vn)# exit
```

## 7. Configure upstream network-facing ports.

```
OS10(config)# interface ethernet1/1/1
OS10(config-if-eth1/1/1)# no shutdown
OS10(config-if-eth1/1/1)# no switchport
OS10(config-if-eth1/1/1)# mtu 1650
OS10(config-if-eth1/1/1)# ip address 172.19.1.0/31
OS10(config-if-eth1/1/1)# exit

OS10(config)# interface ethernet1/1/2
OS10(config-if-eth1/1/2)# no shutdown
OS10(config-if-eth1/1/2)# no switchport
OS10(config-if-eth1/1/2)# mtu 1650
OS10(config-if-eth1/1/2)# ip address 172.19.2.0/31
OS10(config-if-eth1/1/2)# exit
```

## 8. Configure eBGP.

```
OS10(config)# router bgp 100
OS10(config-router-bgp-100)# router-id 172.19.0.1
OS10(config-router-bgp-100)# address-family ipv4 unicast
OS10(configure-router-bgp-af)# redistribute connected
OS10(configure-router-bgp-af)# exit
```

## 9. Configure eBGP for the IPv4 point-to-point peering.

```
OS10(config-router-bgp-100)# neighbor 172.19.1.1
OS10(config-router-neighbor)# remote-as 101
OS10(config-router-neighbor)# no shutdown
OS10(config-router-neighbor)# exit

OS10(config-router-bgp-100)# neighbor 172.19.2.1
OS10(config-router-neighbor)# remote-as 102
OS10(config-router-neighbor)# no shutdown
```

```
OS10(config-router-neighbor)# exit
OS10(config-router-bgp-100)# exit
```

## 10. Configure a Loopback interface for BGP EVPN peering different from the VLT peer IP address.

```
OS10(config)# interface loopback1
OS10(config-if-lo-1)# no shutdown
OS10(config-if-lo-1)# ip address 172.19.0.1/32
OS10(config-if-lo-1)# exit
```

## 11. Configure BGP EVPN peering.

```
OS10(config)# router bgp 100
OS10(config-router-bgp-100)# neighbor 172.201.0.1
OS10(config-router-neighbor)# remote-as 101
OS10(config-router-neighbor)# ebgp-multihop 4
OS10(config-router-neighbor)# send-community extended
OS10(config-router-neighbor)# update-source loopback1
OS10(config-router-neighbor)# no shutdown
OS10(config-router-neighbor)# address-family ipv4 unicast
OS10(config-router-bgp-neighbor-af)# no activate
OS10(config-router-bgp-neighbor-af)# exit
OS10(config-router-neighbor)# address-family l2vpn evpn
OS10(config-router-bgp-neighbor-af)# activate
OS10(config-router-bgp-neighbor-af)# exit
OS10(config-router-neighbor)# exit

OS10(config-router-bgp-100)# neighbor 172.202.0.1
OS10(config-router-neighbor)# remote-as 102
OS10(config-router-neighbor)# ebgp-multihop 4
OS10(config-router-neighbor)# send-community extended
OS10(config-router-neighbor)# update-source loopback1
OS10(config-router-neighbor)# no shutdown
OS10(config-router-neighbor)# address-family ipv4 unicast
OS10(config-router-bgp-neighbor-af)# no activate
OS10(config-router-bgp-neighbor-af)# exit
OS10(config-router-neighbor)# address-family l2vpn evpn
OS10(config-router-bgp-neighbor-af)# activate
OS10(config-router-bgp-neighbor-af)# exit
OS10(config-router-neighbor)# exit
OS10(config-router-bgp-100)# exit
```

## 12. Configure EVPN.

Configure the EVPN instance, RD, RT in manual configuration mode:

```
OS10(config)# evpn
OS10(config-evpn)# evi 10000
OS10(config-evpn-evi-10000)# vni 10000
OS10(config-evpn-evi-10000)# rd 192.168.2.1:10000
OS10(config-evpn-evi-10000)# route-target 99:10000 import
OS10(config-evpn-evi-10000)# route-target 100:10000 both
OS10(config-evpn-evi-10000)#exit

OS10(config-evpn)# evi 20000
OS10(config-evpn-evi-20000)# vni 20000
OS10(config-evpn-evi-20000)# rd 192.168.2.1:20000
OS10(config-evpn-evi-20000)# route-target 99:20000 import
OS10(config-evpn-evi-20000)# route-target 100:20000 both
OS10(config-evpn-evi-20000)#exit
OS10(config-evpn)#
```

## 13. Configure VLT.

### Configure a VLTi VLAN for the virtual network.

```
OS10(config)# virtual-network 10000
OS10(config-vn-10000)# vlti-vlan 100
OS10(config-vn-10000)# exit

OS10(config)# virtual-network 20000
```

```
OS10(config-vn-20000)# vlti-vlan 200
OS10(config-vn-20000)# exit
```

### Configure a dedicated L3 underlay path to reach the VLT Peer in case of a network failure.

```
OS10(config)# interface vlan4000
OS10(config-if-vl-4000)# no shutdown
OS10(config-if-vl-4000)# ip address 172.16.250.11/31
OS10(config-if-vl-4000)# exit
```

### Configure VLT port channels.

```
OS10(config)# interface port-channel10
OS10(config-if-po-10)# vlt-port-channel 10
OS10(config-if-po-10)# exit

OS10(config)# interface port-channel20
OS10(config-if-po-20)# vlt-port-channel 20
OS10(config-if-po-20)# exit
```

### Configure VLTi member links.

```
OOS10(config)# interface ethernet1/1/3
OS10(config-if-eth1/1/3)# no shutdown
OS10(config-if-eth1/1/3)# no switchport
OS10(config-if-eth1/1/3)# exit

OS10(config)# interface ethernet1/1/4
OS10(config-if-eth1/1/4)# no shutdown
OS10(config-if-eth1/1/4)# no switchport
OS10(config-if-eth1/1/4)# exit
```

### Configure the VLT domain.

```
OS10(config)# vlt-domain 1
OS10(config-vlt-1)# backup destination 10.16.150.4
OS10(config-vlt-1)# discovery-interface ethernet1/1/3,1/1/4
OS10(config-vlt-1)# vlt-mac aa:bb:cc:dd:ff:ee
OS10(config-vlt-1)# exit
```

### Configure UFD with uplink VLT ports and downlink network ports.

```
OS10(config)# uplink-state-group 1
OS10(config-uplink-state-group-1)# enable
OS10(config-uplink-state-group-1)# downstream ethernet1/1/1-1/1/2
OS10(config-uplink-state-group-1)# upstream port-channel10
OS10(config-uplink-state-group-1)# upstream port-channel20
OS10(config-uplink-state-group-1)# exit
```

### Configure iBGP IPv4 peering between the VLT peers.

```
OS10(config)# router bgp 100
OS10(config-router-bgp-100)# neighbor 172.16.250.10
OS10(config-router-neighbor)# remote-as 100
OS10(config-router-neighbor)# no shutdown
OS10(config-router-neighbor)# exit
OS10(config-router-bgp-100)# exit
```

## 14. Configure IP routing in the overlay network.

### Create a tenant VRF.

```
OS10(config)# ip vrf tenant1
OS10(config-vrf)# exit
```

### Configure an anycast gateway MAC address.

```
OS10(config)# ip virtual-router mac-address 00:01:01:01:01:01
```

## Configure routing on the virtual networks.

```
OS10(config)# interface virtual-network10000
OS10(config-if-vn-10000)# ip vrf forwarding tenant1
OS10(config-if-vn-10000)# ip address 10.1.0.234/16
OS10(config-if-vn-10000)# ip virtual-router address 10.1.0.100
OS10(config-if-vn-10000)# no shutdown
OS10(config-if-vn-10000)# exit

OS10(config)# interface virtual-network20000
OS10(config-if-vn-20000)# ip vrf forwarding tenant1
OS10(config-if-vn-20000)# ip address 10.2.0.234/16
OS10(config-if-vn-20000)# ip virtual-router address 10.2.0.100
OS10(config-if-vn-20000)# no shutdown
OS10(config-if-vn-20000)# exit
```

## Spine Switch 1

### 1. Configure downstream ports on underlay links to the leaf switches.

```
OS10(config)# interface ethernet1/1/1
OS10(config-if-eth1/1/1)# no shutdown
OS10(config-if-eth1/1/1)# no switchport
OS10(config-if-eth1/1/1)# ip address 172.16.1.1/31
OS10(config-if-eth1/1/1)# exit
OS10(config)# interface ethernet1/1/2
OS10(config-if-eth1/1/2)# no shutdown
OS10(config-if-eth1/1/2)# no switchport
OS10(config-if-eth1/1/2)# ip address 172.17.1.1/31
OS10(config-if-eth1/1/2)# exit
OS10(config)# interface ethernet1/1/3
OS10(config-if-eth1/1/3)# no shutdown
OS10(config-if-eth1/1/3)# no switchport
OS10(config-if-eth1/1/3)# ip address 172.18.1.1/31
OS10(config-if-eth1/1/3)# exit
OS10(config)# interface ethernet1/1/4
OS10(config-if-eth1/1/4)# no shutdown
OS10(config-if-eth1/1/4)# no switchport
OS10(config-if-eth1/1/4)# ip address 172.19.1.1/31
OS10(config-if-eth1/1/4)# exit
```

### 2. Configure eBGP.

```
OS10(config)# router bgp 101
OS10(config-router-bgp-101)# router-id 172.201.0.1
OS10(config-router-bgp-101)# address-family ipv4 unicast
OS10(config-router-bgp-101)# redistribute connected
OS10(config-router-bgp-101)# exit
```

### 3. Configure eBGP IPv4 peer sessions on the P2P links.

```
OS10(config-router-bgp-101)# neighbor 172.16.1.0
OS10(config-router-neighbor)# remote-as 99
OS10(config-router-neighbor)# no shutdown
OS10(config-router-neighbor)# exit

OS10(config-router-bgp-101)# neighbor 172.17.1.0
OS10(config-router-neighbor)# remote-as 99
OS10(config-router-neighbor)# no shutdown
OS10(config-router-neighbor)# exit

OS10(config-router-bgp-101)# neighbor 172.18.1.0
OS10(config-router-neighbor)# remote-as 100
OS10(config-router-neighbor)# no shutdown
OS10(config-router-neighbor)# exit

OS10(config-router-bgp-101)# neighbor 172.19.1.0
OS10(config-router-neighbor)# remote-as 100
OS10(config-router-neighbor)# no shutdown
```

```
OS10(conf-router-neighbor)# exit
OS10(conf-router-bgp-101)# exit
```

#### 4. Configure a Loopback interface for BGP EVPN peering.

```
OS10(config)# interface loopback1
OS10(conf-if-lo-1)# no shutdown
OS10(conf-if-lo-1)# ip address 172.201.0.1/32
OS10(conf-if-lo-1)# exit
```

#### 5. Configure BGP EVPN peer sessions.

```
OS10(config)# router bgp 101
OS10(conf-router-bgp-101)# neighbor 172.16.0.1
OS10(conf-router-neighbor)# ebgp-multihop 4
OS10(conf-router-neighbor)# remote-as 99
OS10(conf-router-neighbor)# send-community extended
OS10(conf-router-neighbor)# update-source loopback1
OS10(conf-router-neighbor)# no shutdown
OS10(conf-router-neighbor)# address-family ipv4 unicast
OS10(conf-router-neighbor-af)# no activate
OS10(conf-router-neighbor-af)# exit
OS10(conf-router-neighbor)# address-family l2vpn evpn
OS10(conf-router-neighbor-af)# activate
OS10(conf-router-neighbor-af)# exit

OS10(conf-router-bgp-101)# neighbor 172.17.0.1
OS10(conf-router-neighbor)# ebgp-multihop 4
OS10(conf-router-neighbor)# remote-as 99
OS10(conf-router-neighbor)# send-community extended
OS10(conf-router-neighbor)# update-source loopback1
OS10(conf-router-neighbor)# no shutdown
OS10(conf-router-neighbor)# address-family ipv4 unicast
OS10(conf-router-neighbor-af)# no activate
OS10(conf-router-neighbor-af)# exit
OS10(conf-router-neighbor)# address-family l2vpn evpn
OS10(conf-router-neighbor-af)# activate
OS10(conf-router-neighbor-af)# exit

OS10(conf-router-bgp-101)# neighbor 172.18.0.1
OS10(conf-router-neighbor)# ebgp-multihop 4
OS10(conf-router-neighbor)# remote-as 100
OS10(conf-router-neighbor)# send-community extended
OS10(conf-router-neighbor)# update-source loopback1
OS10(conf-router-neighbor)# no shutdown
OS10(conf-router-neighbor)# address-family ipv4 unicast
OS10(conf-router-neighbor-af)# no activate
OS10(conf-router-neighbor-af)# exit
OS10(conf-router-neighbor)# address-family l2vpn evpn
OS10(conf-router-neighbor-af)# activate
OS10(conf-router-neighbor-af)# exit

OS10(conf-router-bgp-101)# neighbor 172.19.0.1
OS10(conf-router-neighbor)# ebgp-multihop 4
OS10(conf-router-neighbor)# remote-as 100
OS10(conf-router-neighbor)# send-community extended
OS10(conf-router-neighbor)# update-source loopback1
OS10(conf-router-neighbor)# no shutdown
OS10(conf-router-neighbor)# address-family ipv4 unicast
OS10(conf-router-neighbor-af)# no activate
OS10(conf-router-neighbor-af)# exit
OS10(conf-router-neighbor)# address-family l2vpn evpn
OS10(conf-router-neighbor-af)# activate
OS10(conf-router-neighbor-af)# exit
```

## Spine Switch 2

### 1. Configure downstream ports on the underlay links to the leaf switches.

```
OS10(config)# interface ethernet1/1/1
OS10(config-if-eth1/1/1)# no shutdown
OS10(config-if-eth1/1/1)# no switchport
OS10(config-if-eth1/1/1)# ip address 172.16.2.1/31
OS10(config-if-eth1/1/1)# exit
OS10(config)# interface ethernet1/1/2
OS10(config-if-eth1/1/2)# no shutdown
OS10(config-if-eth1/1/2)# no switchport
OS10(config-if-eth1/1/2)# ip address 172.17.2.1/31
OS10(config-if-eth1/1/2)# exit
OS10(config)# interface ethernet1/1/3
OS10(config-if-eth1/1/3)# no shutdown
OS10(config-if-eth1/1/3)# no switchport
OS10(config-if-eth1/1/3)# ip address 172.18.2.1/31
OS10(config-if-eth1/1/3)# exit
OS10(config)# interface ethernet1/1/4
OS10(config-if-eth1/1/4)# no shutdown
OS10(config-if-eth1/1/4)# no switchport
OS10(config-if-eth1/1/4)# ip address 172.19.2.1/31
OS10(config-if-eth1/1/4)# exit
```

### 2. Configure eBGP.

```
OS10(config)# router bgp 102
OS10(config-router-bgp-102)# router-id 172.202.0.1
OS10(config-router-bgp-102)# address-family ipv4 unicast
OS10(configure-router-bgpv4-af)# redistribute connected
OS10(configure-router-bgpv4-af)# exit
```

### 3. Configure eBGP IPv4 peer sessions on the P2P links.

```
OS10(config-router-bgp-102)# neighbor 172.16.2.0
OS10(config-router-neighbor)# remote-as 99
OS10(config-router-neighbor)# no shutdown
OS10(config-router-neighbor)# exit

OS10(config-router-bgp-102)# neighbor 172.17.2.0
OS10(config-router-neighbor)# remote-as 99
OS10(config-router-neighbor)# no shutdown
OS10(config-router-neighbor)# exit

OS10(config-router-bgp-102)# neighbor 172.18.2.0
OS10(config-router-neighbor)# remote-as 100
OS10(config-router-neighbor)# no shutdown
OS10(config-router-neighbor)# exit

OS10(config-router-bgp-102)# neighbor 172.19.2.0
OS10(config-router-neighbor)# remote-as 100
OS10(config-router-neighbor)# no shutdown
OS10(config-router-neighbor)# exit
OS10(config-router-bgp-102)# exit
```

### 4. Configure a Loopback interface for BGP EVPN peering.

```
OS10(config)# interface loopback1
OS10(config-if-lo-1)# no shutdown
OS10(config-if-lo-1)# ip address 172.202.0.1/32
OS10(config-if-lo-1)# exit
```

### 5. Configure BGP EVPN peer sessions.

```
OS10(config)# router bgp 102
OS10(config-router-bgp-102)# neighbor 172.16.0.1
OS10(config-router-neighbor)# ebgp-multihop 4
OS10(config-router-neighbor)# remote-as 99
OS10(config-router-neighbor)# send-community extended
```

```

OS10(conf-router-neighbor)# update-source loopback1
OS10(conf-router-neighbor)# no shutdown
OS10(conf-router-neighbor)# address-family ipv4 unicast
OS10(conf-router-neighbor-af)# no activate
OS10(conf-router-neighbor-af)# exit
OS10(conf-router-neighbor)# address-family l2vpn evpn
OS10(conf-router-neighbor-af)# activate
OS10(conf-router-neighbor-af)# exit

OS10(conf-router-bgp-102)# neighbor 172.17.0.1
OS10(conf-router-neighbor)# ebgp-multihop 4
OS10(conf-router-neighbor)# remote-as 99
OS10(conf-router-neighbor)# send-community extended
OS10(conf-router-neighbor)# update-source loopback1
OS10(conf-router-neighbor)# no shutdown
OS10(conf-router-neighbor)# address-family ipv4 unicast
OS10(conf-router-neighbor-af)# no activate
OS10(conf-router-neighbor-af)# exit
OS10(conf-router-neighbor)# address-family l2vpn evpn
OS10(conf-router-neighbor-af)# activate
OS10(conf-router-neighbor-af)# exit

OS10(conf-router-bgp-102)# neighbor 172.18.0.1
OS10(conf-router-neighbor)# ebgp-multihop 4
OS10(conf-router-neighbor)# remote-as 100
OS10(conf-router-neighbor)# send-community extended
OS10(conf-router-neighbor)# update-source loopback1
OS10(conf-router-neighbor)# no shutdown
OS10(conf-router-neighbor)# address-family ipv4 unicast
OS10(conf-router-neighbor-af)# no activate
OS10(conf-router-neighbor-af)# exit
OS10(conf-router-neighbor)# address-family l2vpn evpn
OS10(conf-router-neighbor-af)# activate
OS10(conf-router-neighbor-af)# exit

OS10(conf-router-bgp-102)# neighbor 172.19.0.1
OS10(conf-router-neighbor)# ebgp-multihop 4
OS10(conf-router-neighbor)# remote-as 100
OS10(conf-router-neighbor)# send-community extended
OS10(conf-router-neighbor)# update-source loopback1
OS10(conf-router-neighbor)# no shutdown
OS10(conf-router-neighbor)# address-family ipv4 unicast
OS10(conf-router-neighbor-af)# no activate
OS10(conf-router-neighbor-af)# exit
OS10(conf-router-neighbor)# address-family l2vpn evpn
OS10(conf-router-neighbor-af)# activate
OS10(conf-router-neighbor-af)# exit

```

## Verify VXLAN with BGP EVPN — Multiple AS topology.

### 1. Verify virtual network configurations.

```

LEAF1# show virtual-network
Codes: DP - MAC-learn Dataplane, CP - MAC-learn Controlplane, UUD - Unknown-Unicast-Drop
Virtual Network: 10000
Members:
 VLAN 100: port-channel10, port-channel1000
VxLAN Virtual Network Identifier: 10000
Source Interface: loopback0(192.168.1.1)
Remote-VTEPs (flood-list): 192.168.2.1(CP)

Virtual Network: 20000
Members:
 Untagged: port-channel20
VLAN 200: port-channel1000
VxLAN Virtual Network Identifier: 20000
Source Interface: loopback0(192.168.1.1)
Remote-VTEPs (flood-list): 192.168.2.1(CP)
LEAF1#

```



## 2. Verify EVPN configurations and EVPN parameters.

```
LEAF1# show evpn evi

EVI : 10000, State : up
 Bridge-Domain : Virtual-Network 10000, VNI 10000
 Route-Distinguisher : 1:192.168.1.1:10000
 Route-Targets : 0:99:10000 both, 0:100:10000 import
 Inclusive Multicast : 192.168.2.1
 IRB : Enabled(tenant1)

EVI : 20000, State : up
 Bridge-Domain : Virtual-Network 20000, VNI 20000
 Route-Distinguisher : 1:192.168.1.1:20000
 Route-Targets : 0:99:10000 both, 0:100:10000 import
 Inclusive Multicast : 192.168.2.1
 IRB : Enabled(tenant1)
LEAF1#
```

## 3. Verify BGP EVPN neighborship between leaf and spine nodes.

```
LEAF1# show ip bgp l2vpn evpn summary
BGP router identifier 172.16.0.1 local AS number 99
Neighbor AS MsgRcvd MsgSent Up/Down State/Pfx
172.201.0.1 101 1132 1116 13:29:00 27
172.202.0.1 102 1131 1118 13:29:02 28
LEAF1#
```

## 4. Check connectivity between host A and host B.

```
root@HOST-A:~# ping 10.2.0.10 -c 5
PING 10.2.0.10 (10.2.0.10) 56(84) bytes of data.
64 bytes from 10.2.0.10: icmp_seq=1 ttl=63 time=0.824 ms
64 bytes from 10.2.0.10: icmp_seq=2 ttl=63 time=0.847 ms
64 bytes from 10.2.0.10: icmp_seq=3 ttl=63 time=0.835 ms
64 bytes from 10.2.0.10: icmp_seq=4 ttl=63 time=0.944 ms
64 bytes from 10.2.0.10: icmp_seq=5 ttl=63 time=0.806 ms

--- 10.2.0.10 ping statistics ---
5 packets transmitted, 5 received, 0% packet loss, time 4078ms
rtt min/avg/max/mdev = 0.806/0.851/0.944/0.051 ms
root@HOST-A:~#
```

## 5. Check connectivity between host A and host C.

```
root@HOST-A:~# ping 10.1.0.20 -c 5
PING 10.1.0.20 (10.1.0.20) 56(84) bytes of data.
64 bytes from 10.1.0.20: icmp_seq=1 ttl=64 time=0.741 ms
64 bytes from 10.1.0.20: icmp_seq=2 ttl=64 time=0.737 ms
64 bytes from 10.1.0.20: icmp_seq=3 ttl=64 time=0.772 ms
64 bytes from 10.1.0.20: icmp_seq=4 ttl=64 time=0.799 ms
64 bytes from 10.1.0.20: icmp_seq=5 ttl=64 time=0.866 ms

--- 10.1.0.20 ping statistics ---
5 packets transmitted, 5 received, 0% packet loss, time 4061ms
rtt min/avg/max/mdev = 0.737/0.783/0.866/0.047 ms
root@HOST-A:~#
```

## 6. Check connectivity between host A and host D.

```
root@HOST-A:~# ping 10.2.0.20 -c 5
PING 10.2.0.20 (10.2.0.20) 56(84) bytes of data.
64 bytes from 10.2.0.20: icmp_seq=1 ttl=63 time=0.707 ms
64 bytes from 10.2.0.20: icmp_seq=2 ttl=63 time=0.671 ms
64 bytes from 10.2.0.20: icmp_seq=3 ttl=63 time=0.687 ms
64 bytes from 10.2.0.20: icmp_seq=4 ttl=63 time=0.640 ms
64 bytes from 10.2.0.20: icmp_seq=5 ttl=63 time=0.644 ms

--- 10.2.0.20 ping statistics ---
5 packets transmitted, 5 received, 0% packet loss, time 4089ms
```

```
rtt min/avg/max/mdev = 0.640/0.669/0.707/0.041 ms
root@HOST-A:~#
```

**NOTE:** Follow Steps 1 to 6 to check ping connectivity between combinations of other hosts, and between hosts through different virtual-network IP addresses.

## Example: VXLAN BGP EVPN — Centralized L3 gateway

The following VXLAN with BGP EVPN example uses a centralized Layer 3 gateway to perform virtual-network routing. It is based on the sample configuration in [Example: VXLAN BGP EVPN — Multiple AS topology](#).

In the VXLAN BGP EVPN multiple AS topology, all VTEPs are configured to perform distributed L3 gateway routing, in which each VTEP routes VXLAN traffic. Routing decisions are made by ingress VTEPs.

However, in a multi-tenant network, some VTEPs may operate only in Layer 2 VXLAN mode and perform only Layer 2 functions. In this case, configure routing for Layer 2 VTEPs on one Layer 3 VTEP that supports Layer 3 VXLAN functionality. The Layer 2 VXLAN-capable VTEPs are connected with the centralized Layer 3 gateway either directly or through an IP underlay fabric. Any ingress routing traffic on a Layer 2 VTEP is switched to the Layer 3 centralized gateway. All routing decisions are made by the centralized gateway to forward VXLAN traffic to the destination Layer 2 VTEP.

The following centralized L3 gateway example for VXLAN BGP EVPN uses a Clos leaf-spine topology. In this example:

- VTEP 1 and VTEP 2 in VLT 1 operate as a L2 gateway.
- VTEP 3 and VTEP 4 in VLT 2 operate as a centralized L3 gateway.
- Host A and Host B are connected to the L2 gateway. The L2 gateway is connected to a centralized L3 gateway through an IP underlay fabric.
- You must configure the IP address and anycast IP address of the virtual networks in the centralized L3 gateway VTEP. It is not necessary to configure these addresses in the L2 gateway VTEPs.

Routing for tenant L3 traffic is not performed on the L2 VTEPs. The L2 VTEPs forward tenant traffic to the centralized L3 gateway in VLT 2. The L3 gateway routes traffic between L2 tenant segments.

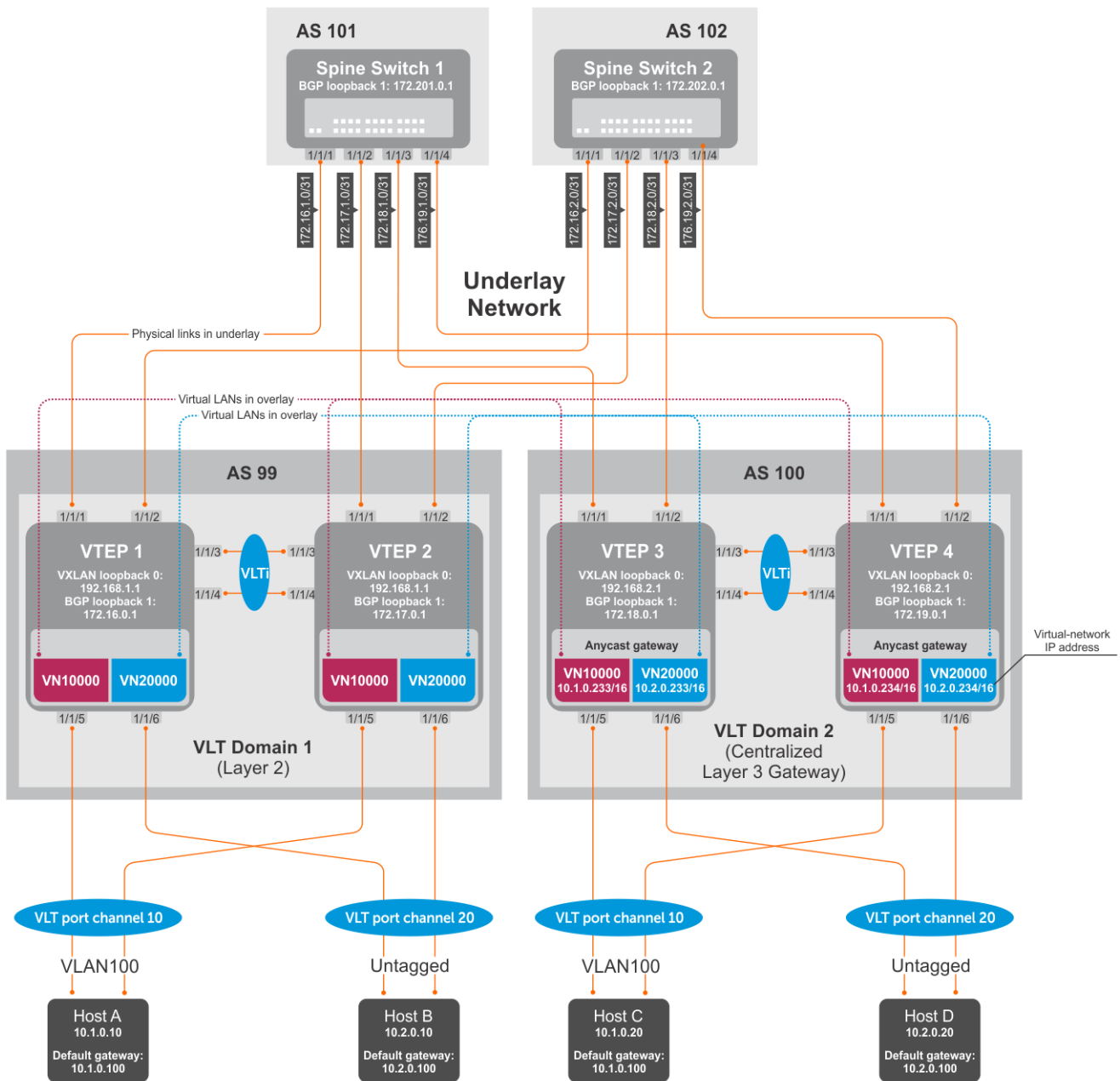

Figure 17. VXLAN BGP EVPN with centralized L3 gateway

**NOTE:** This centralized L3 gateway example for VXLAN BGP EVPN uses the same configuration steps as in [Example: VXLAN BGP EVPN — Multiple AS topology](#). Configure each spine and leaf switch as in the Multiple AS topology example, except:

- Because VTEPs 1 and 2 operate only in Layer 2 VXLAN mode, do not configure **IP switching in the overlay network**. This step consists of configuring virtual network interfaces with IP addresses, anycast IP addresses, and anycast gateway MAC addresses.
- Configure **IP switching in the overlay network** only on VTEPs 3 and 4.

## VTEP 3 Leaf Switch

### 1. Configure IP switching in the overlay network.

### Create a tenant VRF.

```
OS10(config)# ip vrf tenant1
OS10(config-vrf)# exit
```

### Configure an anycast gateway MAC address.

```
OS10(config)# ip virtual-router mac-address 00:01:01:01:01:01
```

### Configure routing on the virtual networks.

```
OS10(config)# interface virtual-network10000
OS10(config-if-vn-10000)# ip vrf forwarding tenant1
OS10(config-if-vn-10000)# ip address 10.1.0.233/16
OS10(config-if-vn-10000)# ip virtual-router address 10.1.0.100
OS10(config-if-vn-10000)# no shutdown
OS10(config-if-vn-10000)# exit

OS10(config)# interface virtual-network20000
OS10(config-if-vn-20000)# ip vrf forwarding tenant1
OS10(config-if-vn-20000)# ip address 10.2.0.233/16
OS10(config-if-vn-20000)# ip virtual-router address 10.2.0.100
OS10(config-if-vn-20000)# no shutdown
OS10(config-if-vn-20000)# exit
```

## VTEP 4 Leaf Switch

### 1. Configure IP switching in overlay network.

#### Create a tenant VRF.

```
OS10(config)# ip vrf tenant1
OS10(config-vrf)# exit
```

#### Configure an anycast gateway MAC address.

```
OS10(config)# ip virtual-router mac-address 00:01:01:01:01:01
```

#### Configure routing on the virtual networks.

```
OS10(config)# interface virtual-network10000
OS10(config-if-vn-10000)# ip vrf forwarding tenant1
OS10(config-if-vn-10000)# ip address 10.1.0.234/16
OS10(config-if-vn-10000)# ip virtual-router address 10.1.0.100
OS10(config-if-vn-10000)# no shutdown
OS10(config-if-vn-10000)# exit

OS10(config)# interface virtual-network20000
OS10(config-if-vn-20000)# ip vrf forwarding tenant1
OS10(config-if-vn-20000)# ip address 10.2.0.234/16
OS10(config-if-vn-20000)# ip virtual-router address 10.2.0.100
OS10(config-if-vn-20000)# no shutdown
OS10(config-if-vn-20000)# exit
```

## Example: VXLAN BGP EVPN — Border leaf gateway with asymmetric IRB

This VXLAN BGP EVPN example shows how to transmit VXLAN traffic to an external network. Traffic from a tenant host that is destined to the Internet is transmitted to a border leaf gateway over L3 VTEPs and an IP underlay fabric.

**NOTE:** After VXLAN decapsulation, routing between virtual networks and tenant VLANs is supported only on the S4200-ON series and S5200-ON series due to NPU capability. On other Dell EMC switches that support VXLAN routing, such as

S4048T-ON, S6010-ON, and the S4100-ON series, routing after decapsulation is performed only between virtual networks. You can connect an egress virtual network to a VLAN in an external router, which connects to the external network.

In the following example, VLT domain 1 is a VLT VTEP. VLT domain 2 is the border leaf VLT VTEP pair. All virtual networks in the data center network are configured in all VTEPs with virtual-network IP and anycast IP gateway addresses.

Configure a dedicated virtual network for sending VXLAN traffic to an external network on all VTEPs. Configure the anycast L3 gateway for the dedicated virtual network only on the border leaf VTEP pair in VLT domain 2. For asymmetric IRB, configure a static default route on all VTEPs, except the border leaf VTEPs. This allows traffic destined to an external network to be transmitted to the anycast L3 address of the dedicated virtual network on the border leaf VTEP. A different static route is configured on the border leaf VTEP. Using this second static route, traffic to an external network is transmitted on an egress VLAN to a WAN router or an Internet address.

When VLT domain 1 receives traffic destined to an external network, the traffic is routed to the dedicated virtual network in the ingress VTEP and sent to the border leaf VTEP. On the border leaf VTEP, the traffic is routed to the VLAN to which an external WAN router is connected or directly connected to the Internet. Similarly, any traffic destined to a VXLAN virtual network that is received on the border leaf VTEP is routed to the destination virtual network.

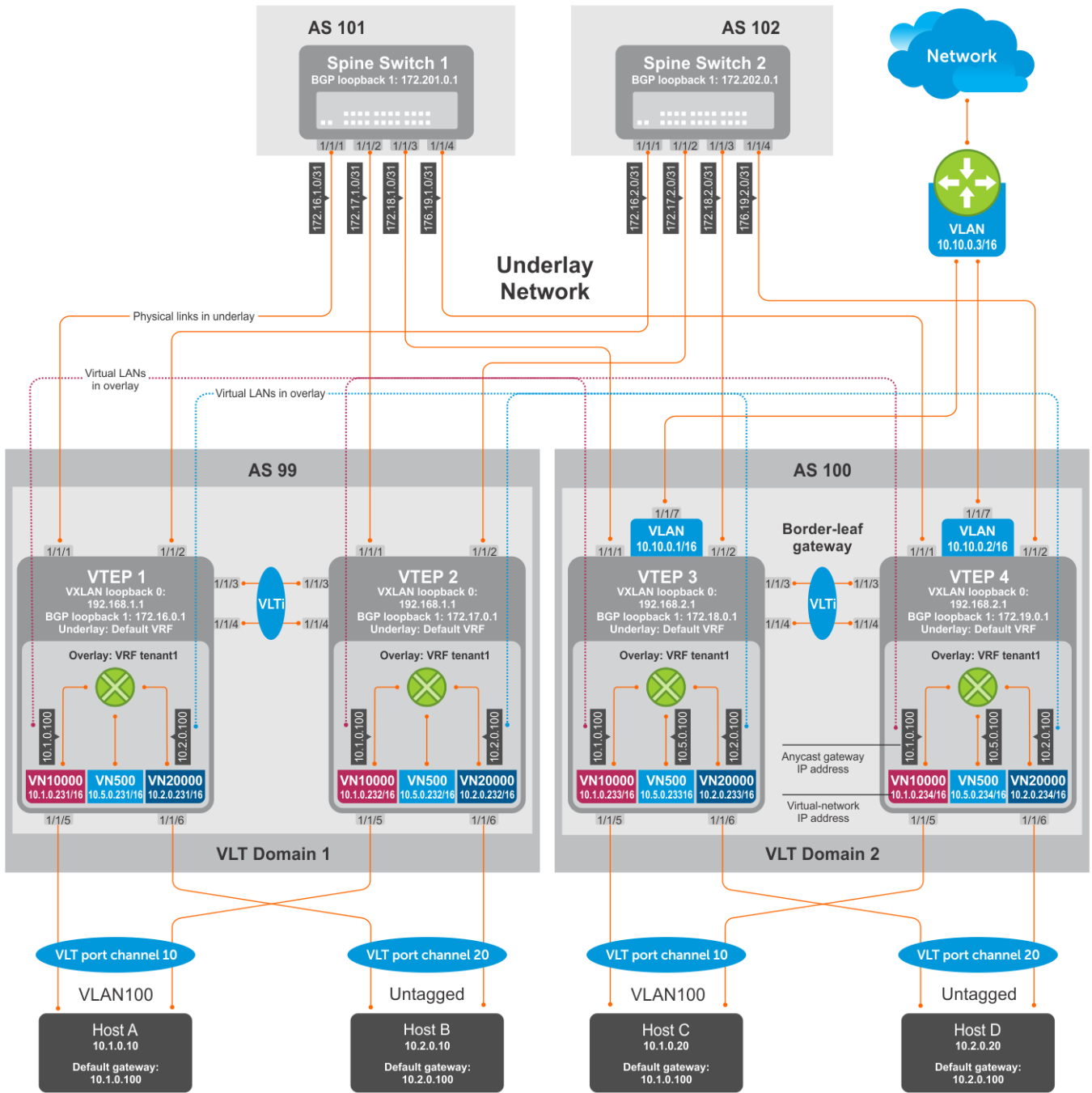

Figure 18. VXLAN BGP EVPN with border leaf gateway

**NOTE:** This border leaf gateway example for VXLAN BGP EVPN uses the same configuration steps as in [Example: VXLAN BGP EVPN — Multiple AS topology](#). Configure each spine and leaf switch as in the Multiple AS topology example and add the following additional configuration steps on each VTEP.

## VTEP 1 Leaf Switch

### 1. Configure a dedicated VXLAN virtual network.

```
OS10(config)# virtual-network 500
OS10(config-vn-500)# vxlan-vni 500
OS10(config-vn-vxlan-vni)# exit
OS10(config-vn-10000)# exit
```

## 2. Configure routing on the virtual network.

```
OS10(config)# interface virtual-network 500
OS10(conf-if-vn-10000)# ip vrf forwarding tenant1
OS10(conf-if-vn-10000)# ip address 10.5.0.231/16
```

## 3. Configure a static route for outbound traffic sent to the anycast MAC address of the dedicated virtual network.

```
OS10(config)#ip route 0.0.0.0/0 10.5.0.100
```

## VTEP 2 Leaf Switch

### 1. Configure a dedicated VXLAN virtual network.

```
OS10(config)# virtual-network 500
OS10(config-vn-500)# vxlan-vni 500
OS10(config-vn-vxlan-vni)# exit
OS10(config-vn-10000)# exit
```

### 2. Configure routing on the virtual networks.

```
OS10(config)# interface virtual-network 500
OS10(conf-if-vn-10000)# ip vrf forwarding tenant2
OS10(conf-if-vn-10000)# ip address 10.5.0.232/16
```

### 3. Configure a static route for outbound traffic sent to the anycast MAC address of the dedicated virtual network.

```
OS10(config)#ip route 0.0.0.0/0 10.5.0.100
```

## VTEP 3 Leaf Switch

### 1. Configure a dedicated VXLAN virtual network.

```
OS10(config)# virtual-network 500
OS10(config-vn-500)# vxlan-vni 500
OS10(config-vn-vxlan-vni)# exit
OS10(config-vn-10000)# exit
```

### 2. Configure an anycast gateway MAC address on the border leaf VTEP. This MAC address must be different from the anycast gateway MAC address configured on non-border-leaf VTEPs.

```
OS10(config)# ip virtual-router mac-address 00:02:02:02:02:02
```

### 3. Configure routing on the virtual network.

```
OS10(config)# interface virtual-network 500
OS10(conf-if-vn-10000)# ip vrf forwarding tenant1
OS10(conf-if-vn-10000)# ip address 10.5.0.233/16
OS10(conf-if-vn-10000)# ip virtual-router address 10.5.0.100
OS10(conf-if-vn-10000)# no shutdown
OS10(conf-if-vn-10000)# exit
```

### 4. Configure externally connected VLAN.

```
OS10(conf)#interface vlan 200
OS10(conf-if-vlan)#ip address 10.10.0.1/16
OS10(conf-if-vlan)#no shutdown
OS10(conf-if-vlan)#exit
```

```
OS10(conf)#interface ethernet 1/1/7
switchport mode trunk
switchport trunk allowed vlan 200
```

## 5. Configure a static route for outbound traffic sent to VLAN 200.

```
OS10(config)#ip route 0.0.0.0/0 10.10.0.3
```

## VTEP 4 Leaf Switch

### 1. Configure a dedicated VXLAN virtual network.

```
OS10(config)# virtual-network 500
OS10(config-vn-500)# vxlan-vni 500
OS10(config-vn-vxlan-vni)# exit
OS10(config-vn-10000)# exit
```

### 2. Configure an anycast gateway MAC address on the border leaf VTEP. This MAC address must be different from the anycast gateway MAC address configured on non-border-leaf VTEPs.

```
OS10(config)# ip virtual-router mac-address 00:02:02:02:02:02
```

### 3. Configure routing on the virtual network.

```
OS10(config)# interface virtual-network 500
OS10(conf-if-vn-10000)# ip vrf forwarding tenant1
OS10(conf-if-vn-10000)# ip address 10.5.0.234/16
OS10(conf-if-vn-10000)# ip virtual-router address 10.5.0.100
OS10(conf-if-vn-10000)# no shutdown
OS10(conf-if-vn-10000)# exit
```

### 4. Configure an externally connected VLAN.

```
OS10(conf)#interface vlan 200
OS10(conf-if-vlan)#ip address 10.10.0.2/16
OS10(conf-if-vlan)#no shutdown
OS10(conf-if-vlan)#exit

OS10(conf)#interface ethernet 1/1/7
switchport mode trunk
switchport trunk allowed vlan 200
```

### 5. Configure a static route for outbound traffic sent to VLAN 200.

```
OS10(config)#ip route 0.0.0.0/0 10.10.0.3
```

## Example: VXLAN BGP EVPN—Symmetric IRB

The following VXLAN with BGP EVPN example uses a Clos leaf-spine topology to show how to set up an end-to-end VXLAN with symmetric IRB. eBGP is used to exchange IP routes in the IP underlay network, and EVPN routes in the VXLAN overlay network. All spine nodes are in one autonomous system—AS 101. All leaf nodes are in another autonomous system—AS 100.

- On VTEPs 1 and 2, access ports are assigned to the virtual network using a switch-scoped VLAN. EVPN for the overlay VXLAN is configured using auto-EVI mode.
- On VTEPs 3 and 4, access ports are assigned to the virtual network using a port-scoped VLAN. The EVPN instance for the overlay VXLAN is configured using manual configuration mode. The RD and RT are configured using auto mode.
- On all VTEPs, symmetric IRB is configured in EVPN mode using a unique, dedicated VXLAN VNI and EVPN RD and RT values for each tenant VRF.
- The VLAN to an external network is configured only on VTEPs 3 and 4 in the VLT domain that serves as the border leaf gateway.

**i NOTE:** In asymmetric IRB, you must configure all destination virtual-network subnets on each VTEP. Symmetric IRB simplifies the VXLAN intersubnet configuration by reducing the number of required VNI configurations. In this example, VLT domain 1 requires only VNI subnet 10.1.0.0/16; VLT domain 2 requires only VNI subnet 10.2.0.0/16. Symmetric IRB facilitates the scaling of VXLAN virtual networks.



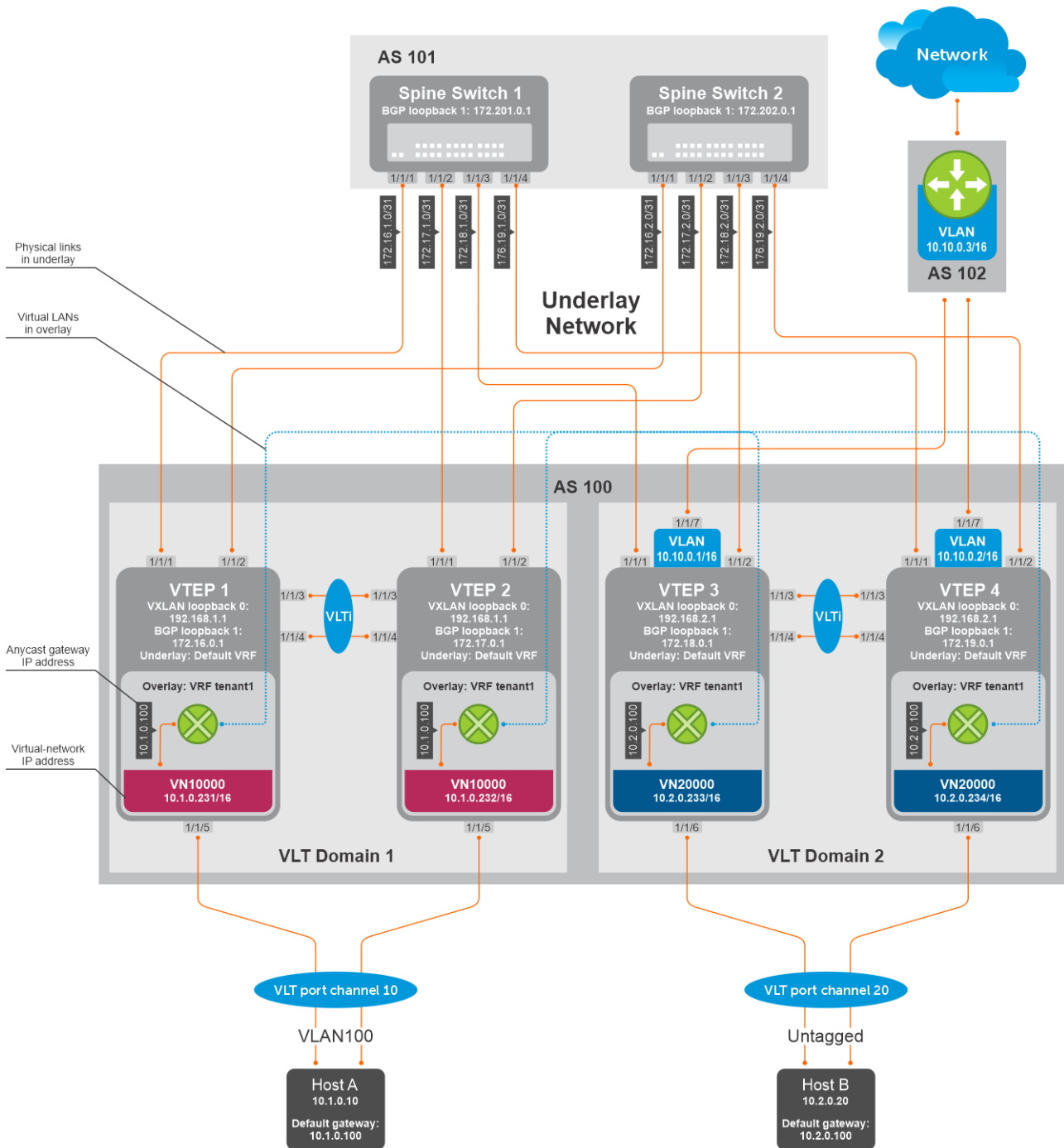

## VTEP 1 Leaf Switch

1. Configure a Loopback interface for the VXLAN underlay using same IP address as the VLT peer.

```
OS10(config)# interface loopback0
OS10(conf-if-lo-0)# no shutdown
OS10(conf-if-lo-0)# ip address 192.168.1.1/32
OS10(conf-if-lo-0)# exit
```

2. Configure the Loopback interface as the VXLAN source tunnel interface.

```
OS10(config)# nve
OS10(config-nve)# source-interface loopback0
OS10(config-nve)# exit
```

### 3. Configure the VXLAN virtual network.

```
OS10(config)# virtual-network 10000
OS10(config-vn-10000)# vxlan-vni 10000
OS10(config-vn-vxlan-vni)# exit
OS10(config-vn-10000)# exit
```

### 4. Assign VLAN member interfaces to the virtual network.

Use a switch-scoped VLAN-to-VNI mapping:

```
OS10(config)# interface vlan100
OS10(config-if-vl-100)# virtual-network 10000
OS10(config-if-vl-100)# no shutdown
OS10(config-if-vl-100)# exit
```

### 5. Configure access ports as VLAN members for a switch-scoped VLAN-to-VNI mapping.

```
OS10(config)# interface port-channel10
OS10(config-if-po-10)# no shutdown
OS10(config-if-po-10)# switchport mode trunk
OS10(config-if-po-10)# switchport trunk allowed vlan 100
OS10(config-if-po-10)# no switchport access vlan
OS10(config-if-po-10)# exit

OS10(config)# interface ethernet1/1/5
OS10(config-if-eth1/1/5)# no shutdown
OS10(config-if-eth1/1/5)# channel-group 10 mode active
OS10(config-if-eth1/1/5)# no switchport
OS10(config-if-eth1/1/5)# exit
```

### 6. Configure upstream network-facing ports.

```
OS10(config)# interface ethernet1/1/1
OS10(config-if-eth1/1/1)# no shutdown
OS10(config-if-eth1/1/1)# no switchport
OS10(config-if-eth1/1/1)# mtu 1650
OS10(config-if-eth1/1/1)# ip address 172.16.1.0/31
OS10(config-if-eth1/1/1)# exit

OS10(config)# interface ethernet1/1/2
OS10(config-if-eth1/1/2)# no shutdown
OS10(config-if-eth1/1/2)# no switchport
OS10(config-if-eth1/1/1)# mtu 1650
OS10(config-if-eth1/1/2)# ip address 172.16.2.0/31
OS10(config-if-eth1/1/2)# exit
```

### 7. Configure eBGP.

```
OS10(config)# router bgp 100
OS10(config-router-bgp-100)# router-id 172.16.0.1
OS10(config-router-bgp-100)# address-family ipv4 unicast
OS10(config-router-bgp-af)# redistribute connected
OS10(config-router-bgp-af)# exit
```

### 8. Configure eBGP for the IPv4 point-to-point peering.

```
OS10(config-router-bgp-100)# neighbor 172.16.1.1
OS10(config-router-neighbor)# remote-as 101
OS10(config-router-neighbor)# address-family ipv4 unicast
OS10(config-router-bgp-neighbor-af)# allowas-in 1
OS10(config-router-bgp-neighbor-af)# exit
OS10(config-router-neighbor)# no shutdown
OS10(config-router-neighbor)# exit

OS10(config-router-bgp-100)# neighbor 172.16.2.1
OS10(config-router-neighbor)# remote-as 101
OS10(config-router-neighbor)# address-family ipv4 unicast
OS10(config-router-bgp-neighbor-af)# allowas-in 1
OS10(config-router-bgp-neighbor-af)# exit
OS10(config-router-neighbor)# no shutdown
```

```
OS10(config-router-neighbor)# exit
OS10(config-router-bgp-100)# exit
```

### 9. Configure a Loopback interface for BGP EVPN peering different from the VLT peer IP address.

```
OS10(config)# interface loopback1
OS10(config-if-lo-1)# no shutdown
OS10(config-if-lo-1)# ip address 172.16.0.1/32
OS10(config-if-lo-1)# exit
```

### 10. Configure BGP EVPN peering.

```
OS10(config)# router bgp 100
OS10(config-router-bgp-100)# neighbor 172.201.0.1
OS10(config-router-neighbor)# remote-as 101
OS10(config-router-neighbor)# ebgp-multihop 4
OS10(config-router-neighbor)# send-community extended
OS10(config-router-neighbor)# update-source loopback1
OS10(config-router-neighbor)# no shutdown
OS10(config-router-neighbor)# address-family ipv4 unicast
OS10(config-router-bgp-neighbor-af)# no activate
OS10(config-router-bgp-neighbor-af)# exit
OS10(config-router-neighbor)# address-family l2vpn evpn
OS10(config-router-bgp-neighbor-af)# activate
OS10(config-router-bgp-neighbor-af)# allowas-in 1
OS10(config-router-bgp-neighbor-af)# exit
OS10(config-router-neighbor)# exit
```

```
OS10(config-router-bgp-100)# neighbor 172.202.0.1
OS10(config-router-neighbor)# remote-as 101
OS10(config-router-neighbor)# ebgp-multihop 4
OS10(config-router-neighbor)# send-community extended
OS10(config-router-neighbor)# update-source loopback1
OS10(config-router-neighbor)# no shutdown
OS10(config-router-neighbor)# address-family ipv4 unicast
OS10(config-router-bgp-neighbor-af)# no activate
OS10(config-router-bgp-neighbor-af)# exit
OS10(config-router-neighbor)# address-family l2vpn evpn
OS10(config-router-bgp-neighbor-af)# activate
OS10(config-router-bgp-neighbor-af)# allowas-in 1
OS10(config-router-bgp-neighbor-af)# exit
OS10(config-router-neighbor)# exit
OS10(config-router-bgp-100)# exit
```

### 11. Configure EVPN for the VXLAN virtual network.

Configure the EVPN instance, RD, and RT using auto-EVI mode.

```
OS10(config)# evpn
OS10(config-evpn)# auto-evi
OS10(config-evpn)# exit
```

### 12. Configure VLT.

#### Configure a dedicated L3 underlay path to reach the VLT Peer in case of a network failure.

```
OS10(config)# interface vlan4000
OS10(config-if-vl-4000)# no shutdown
OS10(config-if-vl-4000)# ip address 172.16.250.0/31
OS10(config-if-vl-4000)# exit
```

#### Configure the VLT port channel.

```
OS10(config)# interface port-channel10
OS10(config-if-po-10)# vlt-port-channel 10
OS10(config-if-po-10)# exit
```

#### Configure the VLTi member links.

```
OS10(config)# interface ethernet1/1/3
OS10(config-if-eth1/1/3)# no shutdown
```

```
OS10(config-if-eth1/1/3)# no switchport
OS10(config-if-eth1/1/3)# exit

OS10(config)# interface ethernet1/1/4
OS10(config-if-eth1/1/4)# no shutdown
OS10(config-if-eth1/1/4)# no switchport
OS10(config-if-eth1/1/4)# exit
```

### Configure the VLT domain.

```
OS10(config)# vlt-domain 1
OS10(config-vlt-1)# backup destination 10.16.150.1
OS10(config-vlt-1)# discovery-interface ethernet1/1/3,1/1/4
OS10(config-vlt-1)# vlt-mac aa:bb:cc:dd:ee:ff
OS10(config-vlt-1)# exit
```

### Configure UFD with uplink VLT ports and downlink network ports.

```
OS10(config)# uplink-state-group 1
OS10(config-uplink-state-group-1)# enable
OS10(config-uplink-state-group-1)# downstream ethernet1/1/1-1/1/2
OS10(config-uplink-state-group-1)# upstream port-channel10
OS10(config-uplink-state-group-1)# exit
```

### Configure iBGP IPv4 peering between VLT peers.

```
OS10(config)# router bgp 100
OS10(config-router-bgp-100)# neighbor 172.16.250.1
OS10(config-router-neighbor)# remote-as 100
OS10(config-router-neighbor)# no shutdown
OS10(config-router-neighbor)# exit
OS10(config-router-bgp-100)# exit
```

## 13. Configure IP routing in the overlay network.

### Create a tenant VRF.

```
OS10(config)# ip vrf tenant1
OS10(config-vrf)# exit
```

### Configure an anycast gateway MAC address.

```
OS10(config)# ip virtual-router mac-address 00:01:01:01:01:01
```

### Configure routing on the virtual network.

```
OS10(config)# interface virtual-network 10000
OS10(config-if-vn-10000)# ip vrf forwarding tenant1
OS10(config-if-vn-10000)# ip address 10.1.0.231/16
OS10(config-if-vn-10000)# ip virtual-router address 10.1.0.100
OS10(config-if-vn-10000)# no shutdown
OS10(config-if-vn-10000)# exit
```

## 14. Configure symmetric IRB.

In EVPN mode, configure the router MAC used by remote VTEPs as the destination address in VXLAN encapsulated packets sent to the switch. Configure a dedicated VXLAN VNI for symmetric IRB for each tenant VRF.

```
OS10(config)# evpn
OS10(config-evpn)# router-mac 00:01:02:03:04:05
OS10(config-evpn)# vrf tenant1
OS10(config-evpn-vrf-tenant1)# vni 3000
OS10(config-evpn-vrf-tenant1)# route-target 65535:30000 both
OS10(config-evpn-vrf-tenant1)# exit
OS10(config-evpn)# exit
OS10(config)#
```

## 15. Configure advertisement of connected networks through EVPN type-5 routes.

```
OS10(config)# evpn
OS10(config-evpn)# vrf tenant1
OS10(config-evpn-vrf-tenant1)# advertise ipv4 connected
OS10(config-evpn-vrf-tenant1)# exit
```

## VTEP 2 Leaf Switch

### 1. Configure a Loopback interface for the VXLAN underlay using the same IP address as the VLT peer.

```
OS10(config)# interface loopback0
OS10(conf-if-lo-0)# no shutdown
OS10(conf-if-lo-0)# ip address 192.168.1.1/32
OS10(conf-if-lo-0)# exit
```

### 2. Configure the Loopback interface as the VXLAN source tunnel interface.

```
OS10(config)# nve
OS10(config-nve)# source-interface loopback0
OS10(config-nve)# exit
```

### 3. Configure the VXLAN virtual network.

```
OS10(config)# virtual-network 10000
OS10(config-vn-10000)# vxlan-vni 10000
OS10(config-vn-vxlan-vni)# exit
OS10(config-vn)# exit
```

### 4. Assign VLAN member interfaces to the virtual network.

Use a switch-scoped VLAN-to-VNI mapping:

```
OS10(config)# interface vlan100
OS10(config-if-vl-100)# virtual-network 10000
OS10(config-if-vl-100)# no shutdown
OS10(config-if-vl-100)# exit
```

### 5. Configure access ports as VLAN members for a switch-scoped VLAN-to-VNI mapping.

```
OS10(config)# interface port-channel10
OS10(conf-if-po-10)# no shutdown
OS10(conf-if-po-10)# switchport mode trunk
OS10(conf-if-po-10)# switchport trunk allowed vlan 100
OS10(conf-if-po-10)# no switchport access vlan
OS10(conf-if-po-10)# exit

OS10(config)# interface ethernet1/1/5
OS10(conf-if-eth1/1/5)# no shutdown
OS10(conf-if-eth1/1/5)# channel-group 10 mode active
OS10(conf-if-eth1/1/5)# no switchport
OS10(conf-if-eth1/1/5)# exit
```

### 6. Configure upstream network-facing ports.

```
OS10(config)# interface ethernet1/1/1
OS10(conf-if-eth1/1/1)# no shutdown
OS10(conf-if-eth1/1/1)# no switchport
OS10(conf-if-eth1/1/1)# mtu 1650
OS10(conf-if-eth1/1/1)# ip address 172.17.1.0/31
OS10(conf-if-eth1/1/1)# exit

OS10(config)# interface ethernet1/1/2
OS10(conf-if-eth1/1/2)# no shutdown
OS10(conf-if-eth1/1/2)# no switchport
OS10(conf-if-eth1/1/1)# mtu 1650
```

```
OS10(conf-if-eth1/1/2)# ip address 172.17.2.0/31
OS10(conf-if-eth1/1/2)# exit
```

## 7. Configure eBGP.

```
OS10(config)# router bgp 100
OS10(config-router-bgp-100)# router-id 172.17.0.1
OS10(config-router-bgp-100)# address-family ipv4 unicast
OS10(configure-router-bgp-af)# redistribute connected
OS10(configure-router-bgp-af)# exit
```

## 8. Configure eBGP for the IPv4 point-to-point peering.

```
OS10(config-router-bgp-100)# neighbor 172.17.1.1
OS10(config-router-neighbor)# remote-as 101
OS10(config-router-neighbor)# address-family ipv4 unicast
OS10(config-router-bgp-neighbor-af)# allowas-in 1
OS10(config-router-bgp-neighbor-af)# exit
OS10(config-router-neighbor)# no shutdown
OS10(config-router-neighbor)# exit

OS10(config-router-bgp-100)# neighbor 172.17.2.1
OS10(config-router-neighbor)# remote-as 101
OS10(config-router-neighbor)# address-family ipv4 unicast
OS10(config-router-bgp-neighbor-af)# allowas-in 1
OS10(config-router-bgp-neighbor-af)# exit
OS10(config-router-neighbor)# no shutdown
OS10(config-router-neighbor)# exit
OS10(config-router-bgp-100)# exit
```

## 9. Configure a Loopback interface for BGP EVPN peering different from VLT peer IP address.

```
OS10(config)# interface loopback1
OS10(conf-if-lo-1)# no shutdown
OS10(conf-if-lo-1)# ip address 172.17.0.1/32
OS10(conf-if-lo-1)# exit
```

## 10. Configure BGP EVPN peering.

```
OS10(config)# router bgp 100
OS10(config-router-bgp-100)# neighbor 172.201.0.1
OS10(config-router-neighbor)# remote-as 101
OS10(config-router-neighbor)# ebgp-multihop 4
OS10(config-router-neighbor)# send-community extended
OS10(config-router-neighbor)# update-source loopback1
OS10(config-router-neighbor)# no shutdown
OS10(config-router-neighbor)# address-family ipv4 unicast
OS10(config-router-bgp-neighbor-af)# no activate
OS10(config-router-bgp-neighbor-af)# exit
OS10(config-router-neighbor)# address-family l2vpn evpn
OS10(config-router-bgp-neighbor-af)# activate
OS10(config-router-bgp-neighbor-af)# allowas-in 1
OS10(config-router-bgp-neighbor-af)# exit
OS10(config-router-neighbor)# exit

OS10(config-router-bgp-100)# neighbor 172.202.0.1
OS10(config-router-neighbor)# remote-as 101
OS10(config-router-neighbor)# ebgp-multihop 4
OS10(config-router-neighbor)# send-community extended
OS10(config-router-neighbor)# update-source loopback1
OS10(config-router-neighbor)# no shutdown
OS10(config-router-bgp-neighbor)# address-family ipv4 unicast
OS10(config-router-bgp-neighbor-af)# no activate
OS10(config-router-bgp-neighbor-af)# exit
OS10(config-router-neighbor)# address-family l2vpn evpn
OS10(config-router-bgp-neighbor-af)# activate
OS10(config-router-bgp-neighbor-af)# allowas-in 1
OS10(config-router-bgp-neighbor-af)# exit
OS10(config-router-neighbor)# exit
OS10(config-router-bgp-100)# exit
```

## 11. Configure EVPN for the VXLAN virtual network.

Configure the EVPN instance, RD, and RT using auto-EVI mode.

```
OS10(config)# evpn
OS10(config-evpn)# auto-evi
OS10(config-evpn)# exit
```

## 12. Configure VLT.

Configure a dedicated L3 underlay path to reach the VLT Peer in case of a network failure.

```
OS10(config)# interface vlan4000
OS10(config-if-vl-4000)# no shutdown
OS10(config-if-vl-4000)# ip address 172.16.250.1/31
OS10(config-if-vl-4000)# exit
```

Configure the VLT port channel.

```
OS10(config)# interface port-channel10
OS10(conf-if-po-10)# vlt-port-channel 10
OS10(conf-if-po-10)# exit
```

Configure VLTi member links.

```
OOS10(config)# interface ethernet1/1/3
OS10(conf-if-eth1/1/3)# no shutdown
OS10(conf-if-eth1/1/3)# no switchport
OS10(conf-if-eth1/1/3)# exit

OS10(config)# interface ethernet1/1/4
OS10(conf-if-eth1/1/4)# no shutdown
OS10(conf-if-eth1/1/4)# no switchport
OS10(conf-if-eth1/1/4)# exit
```

Configure the VLT domain.

```
OS10(config)# vlt-domain 1
OS10(conf-vlt-1)# backup destination 10.16.150.2
OS10(conf-vlt-1)# discovery-interface ethernet1/1/3,1/1/4
OS10(conf-vlt-1)# vlt-mac aa:bb:cc:dd:ee:ff
OS10(conf-vlt-1)# exit
```

Configure UFD with uplink VLT ports and downlink network ports.

```
OS10(config)# uplink-state-group 1
OS10(conf-uplink-state-group-1)# enable
OS10(conf-uplink-state-group-1)# downstream ethernet1/1/1-1/1/2
OS10(conf-uplink-state-group-1)# upstream port-channel10
OS10(conf-uplink-state-group-1)# exit
```

Configure iBGP IPv4 peering between VLT peers.

```
OS10(config)# router bgp 100
OS10(config-router-bgp-100)# neighbor 172.16.250.0
OS10(config-router-neighbor)# remote-as 100
OS10(config-router-neighbor)# no shutdown
OS10(config-router-neighbor)# exit
OS10(config-router-bgp-100)# exit
```

## 13. Configure IP routing in overlay network.

Create a tenant VRF.

```
OS10(config)# ip vrf tenant1
OS10(conf-vrf)# exit
```

### Configure an anycast gateway MAC address.

```
OS10(config)# ip virtual-router mac-address 00:01:01:01:01:01
```

### Configure routing on the virtual network.

```
OS10(config)# interface virtual-network 10000
OS10(config-if-vn-10000)# ip vrf forwarding tenant1
OS10(config-if-vn-10000)# ip address 10.1.0.232/16
OS10(config-if-vn-10000)# ip virtual-router address 10.1.0.100
OS10(config-if-vn-10000)# no shutdown
OS10(config-if-vn-10000)# exit
```

### 14. Configure symmetric IRB.

In EVPN mode, configure the router MAC used by remote VTEPs as the destination address in VXLAN encapsulated packets sent to the switch. Configure a dedicated VXLAN VNI for symmetric IRB for each tenant VRF.

```
OS10(config)# evpn
OS10(config-evpn)# router-mac 00:01:02:03:04:05
OS10(config-evpn)# vrf tenant1
OS10(config-evpn-vrf-tenant1)# vni 3000
OS10(config-evpn-vrf-tenant1)# route-target 65535:30000 both
OS10(config-evpn-vrf-tenant1)# exit
OS10(config-evpn)# exit
OS10(config)#
```

### 15. Configure advertisement of connected networks through EVPN type-5 routes.

```
OS10(config)# evpn
OS10(config-evpn)# vrf tenant1
OS10(config-evpn-vrf-tenant1)# advertise ipv4 connected
OS10(config-evpn-vrf-tenant1)# exit
```

## VTEP 3 Leaf Switch

### 1. Configure a Loopback interface for the VXLAN underlay using same IP address as the VLT peer.

```
OS10(config)# interface loopback0
OS10(config-if-lo-0)# no shutdown
OS10(config-if-lo-0)# ip address 192.168.2.1/32
OS10(config-if-lo-0)# exit
```

### 2. Configure the Loopback interface as the VXLAN source tunnel interface.

```
OS10(config)# nve
OS10(config-nve)# source-interface loopback0
OS10(config-nve)# exit
```

### 3. Configure the VXLAN virtual network.

```
OS10(config)# virtual-network 20000
OS10(config-vn-20000)# vxlan-vni 20000
OS10(config-vn-vxlan-vni)# exit
OS10(config-vn-20000)# exit
```

### 4. Configure unused VLAN ID for untagged membership.

```
OS10(config)# virtual-network untagged-vlan 1000
```

### 5. Configure access ports as VLAN members for a port-scoped VLAN-to-VNI mapping.

```
OS10(config)# interface port-channel20
OS10(config-if-po-20)# no shutdown
OS10(config-if-po-20)# switchport mode trunk
OS10(config-if-po-20)# no switchport access vlan
OS10(config-if-po-20)# exit
```



```
OS10(config)# interface ethernet1/1/6
OS10(conf-if-eth1/1/6)# no shutdown
OS10(conf-if-eth1/1/6)# channel-group 20 mode active
OS10(conf-if-eth1/1/6)# no switchport
OS10(conf-if-eth1/1/6)# exit
```

## 6. Add the access ports to the virtual network.

```
OS10(config)# virtual-network 20000
OS10(config-vn-20000)# member-interface port-channel 20 untagged
OS10(config-vn-20000)# exit
```

## 7. Configure upstream network-facing ports.

```
OS10(config)# interface ethernet1/1/1
OS10(conf-if-eth1/1/1)# no shutdown
OS10(conf-if-eth1/1/1)# no switchport
OS10(conf-if-eth1/1/1)# mtu 1650
OS10(conf-if-eth1/1/1)# ip address 172.18.1.0/31
OS10(conf-if-eth1/1/1)# exit

OS10(config)# interface ethernet1/1/2
OS10(conf-if-eth1/1/2)# no shutdown
OS10(conf-if-eth1/1/2)# no switchport
OS10(conf-if-eth1/1/1)# mtu 1650
OS10(conf-if-eth1/1/2)# ip address 172.18.2.0/31
OS10(conf-if-eth1/1/2)# exit
```

## 8. Configure eBGP.

```
OS10(config)# router bgp 100
OS10(config-router-bgp-100)# router-id 172.18.0.1
OS10(config-router-bgp-100)# address-family ipv4 unicast
OS10(configure-router-bgp-af)# redistribute connected
OS10(configure-router-bgp-af)# exit
```

## 9. Configure eBGP for the IPv4 point-to-point peering.

```
OS10(config-router-bgp-100)# neighbor 172.18.1.1
OS10(config-router-neighbor)# remote-as 101
OS10(config-router-neighbor)# address-family ipv4 unicast
OS10(config-router-bgp-neighbor-af)# allowas-in 1
OS10(config-router-bgp-neighbor-af)# exit
OS10(config-router-neighbor)# no shutdown
OS10(config-router-neighbor)# exit

OS10(config-router-bgp-100)# neighbor 172.18.2.1
OS10(config-router-neighbor)# remote-as 101
OS10(config-router-neighbor)# address-family ipv4 unicast
OS10(config-router-bgp-neighbor-af)# allowas-in 1
OS10(config-router-bgp-neighbor-af)# exit
OS10(config-router-neighbor)# no shutdown
OS10(config-router-neighbor)# exit
OS10(config-router-bgp-100)# exit
```

## 10. Configure a Loopback interface for BGP EVPN peering different from VLT peer IP address.

```
OS10(config)# interface loopback1
OS10(conf-if-lo-1)# no shutdown
OS10(conf-if-lo-1)# ip address 172.18.0.1/32
OS10(conf-if-lo-1)# exit
```

## 11. Configure BGP EVPN peering.

```
OS10(config)# router bgp 100
OS10(config-router-bgp-100)# neighbor 172.201.0.1
OS10(config-router-neighbor)# remote-as 101
OS10(config-router-neighbor)# ebgp-multihop 4
OS10(config-router-neighbor)# send-community extended
```

```

OS10(config-router-neighbor)# update-source loopback1
OS10(config-router-neighbor)# no shutdown
OS10(config-router-neighbor)# address-family ipv4 unicast
OS10(config-router-bgp-neighbor-af)# no activate
OS10(config-router-bgp-neighbor-af)# exit
OS10(config-router-neighbor)# address-family l2vpn evpn
OS10(config-router-bgp-neighbor-af)# activate
OS10(config-router-bgp-neighbor-af)# allowas-in 1
OS10(config-router-bgp-neighbor-af)# exit
OS10(config-router-neighbor)# exit

OS10(config-router-bgp-100)# neighbor 172.202.0.1
OS10(config-router-neighbor)# remote-as 101
OS10(config-router-neighbor)# ebgp-multihop 4
OS10(config-router-neighbor)# send-community extended
OS10(config-router-neighbor)# update-source loopback1
OS10(config-router-neighbor)# no shutdown
OS10(config-router-neighbor)# address-family ipv4 unicast
OS10(config-router-bgp-neighbor-af)# no activate
OS10(config-router-bgp-neighbor-af)# exit
OS10(config-router-neighbor)# address-family l2vpn evpn
OS10(config-router-bgp-neighbor-af)# activate
OS10(config-router-bgp-neighbor-af)# allowas-in 1
OS10(config-router-bgp-neighbor-af)# exit
OS10(config-router-neighbor)# exit
OS10(config-router-bgp-100)# exit

```

## 12. Configure EVPN for the VXLAN virtual network.

Configure the EVPN instance in manual configuration mode, and RD and RT configuration in auto mode.

```

OS10(config)# evpn
OS10(config-evpn)# evi 20000
OS10(config-evpn-evi-20000)# vni 20000
OS10(config-evpn-evi-20000)# rd auto
OS10(config-evpn-evi-20000)# route-target auto
OS10(config-evpn-evi-20000)# exit
OS10(config-evpn)# exit

```

## 13. Configure VLT.

### Configure a VLTi VLAN for the virtual network.

```

OS10(config)# virtual-network 20000
OS10(config-vn-20000)# vlti-vlan 200
OS10(config-vn-20000)# exit

```

### Configure a dedicated L3 underlay path to reach the VLT Peer in case of a network failure.

```

OS10(config)# interface vlan4000
OS10(config-if-vl-4000)# no shutdown
OS10(config-if-vl-4000)# ip address 172.16.250.10/31
OS10(config-if-vl-4000)# exit

```

### Configure the VLT port channel.

```

OS10(config)# interface port-channel20
OS10(conf-if-po-20)# vlt-port-channel 20
OS10(conf-if-po-20)# exit

```

### Configure VLTi member links.

```

OOS10(config)# interface ethernet1/1/3
OS10(conf-if-eth1/1/3)# no shutdown
OS10(conf-if-eth1/1/3)# no switchport
OS10(conf-if-eth1/1/3)# exit

OS10(config)# interface ethernet1/1/4
OS10(conf-if-eth1/1/4)# no shutdown
OS10(conf-if-eth1/1/4)# no switchport
OS10(conf-if-eth1/1/4)# exit

```

### Configure the VLT domain.

```
OS10(config)# vlt-domain 1
OS10(conf-vlt-1)# backup destination 10.16.150.3
OS10(conf-vlt-1)# discovery-interface ethernet1/1/3,1/1/4
OS10(conf-vlt-1)# vlt-mac aa:bb:cc:dd:ff:ee
OS10(conf-vlt-1)# exit
```

### Configure UFD with uplink VLT ports and downlink network ports.

```
OS10(config)# uplink-state-group 1
OS10(conf-uplink-state-group-1)# enable
OS10(conf-uplink-state-group-1)# downstream ethernet1/1/1-1/1/2
OS10(conf-uplink-state-group-1)# upstream port-channel20
OS10(conf-uplink-state-group-1)# exit
```

### Configure iBGP IPv4 peering between VLT peers.

```
OS10(config)# router bgp 100
OS10(config-router-bgp-100)# neighbor 172.16.250.11
OS10(config-router-neighbor)# remote-as 100
OS10(config-router-neighbor)# no shutdown
OS10(config-router-neighbor)# exit
OS10(config-router-bgp-100)# exit
```

## 14. Configure IP routing in the overlay network.

### Create the tenant VRF.

```
OS10(config)# ip vrf tenant1
OS10(conf-vrf)# exit
```

### Configure an anycast gateway MAC address.

```
OS10(config)# ip virtual-router mac-address 00:01:01:01:01:01
```

### Configure routing on the virtual network.

```
OS10(config)# interface virtual-network 20000
OS10(conf-if-vn-20000)# ip vrf forwarding tenant1
OS10(conf-if-vn-20000)# ip address 10.2.0.233/16
OS10(conf-if-vn-20000)# ip virtual-router address 10.2.0.100
OS10(conf-if-vn-20000)# no shutdown
OS10(conf-if-vn-20000)# exit
```

## 15. Configure symmetric IRB.

In EVPN mode, configure the router MAC used by remote VTEPs as the destination address in VXLAN encapsulated packets sent to the switch. Configure a dedicated VXLAN VNI for symmetric IRB for each tenant VRF.

```
OS10(config)# evpn
OS10(config-evpn)# router-mac 00:01:02:03:04:06
OS10(config-evpn)# vrf tenant1
OS10(config-evpn-vrf-tenant1)# vni 3000
OS10(config-evpn-vrf-tenant1)# route-target 65535:30000 both
OS10(config-evpn-vrf-tenant1)# exit
OS10(config-evpn)# exit
OS10(config)#
```

## 16. Configure an externally connected VLAN.

```
OS10(conf)# interface vlan 200
OS10(conf-if-vlan)# ip vrf forwarding tenant1
OS10(conf-if-vlan)# ip address 10.10.0.1/16
OS10(conf-if-vlan)# no shutdown
OS10(conf-if-vlan)# exit

OS10(conf)# interface ethernet 1/1/7
```

```
OS10(config-if-eth1/1/7)# switchport mode trunk
OS10(config-if-eth1/1/7)# switchport trunk allowed vlan 200
```

### 17. Configure advertisement of the connected networks via EVPN Type-5 routes.

```
OS10(config)# evpn
OS10(config-evpn)# vrf tenant1
OS10(config-evpn-vrf-tenant1)# advertise ipv4 connected
OS10(config-evpn-vrf-tenant1)# exit
```

### 18. Configure BGP session with external router on the border-leaf VTEPs.

```
OS10(config)# router bgp 100
OS10(config-router-bgp-100)# vrf tenant1
OS10(config-router-bgp-100-vrf)# neighbor 10.10.0.3
OS10(config-router-vrf-neighbor)# remote-as 102
OS10(config-router-vrf-neighbor)# no shutdown
OS10(config-router-vrf-neighbor)# end
```

### 19. Import external routes in to EVPN on the border-leaf switches.

External routes for WAN connectivity and other appliances can be imported in to a VXLAN pod using the following configuration on the border-leaf router.

```
OS10(config)# evpn
OS10(config-evpn)# vrf tenant1
OS10(config-evpn-vrf-tenant1)# advertise ipv4 bgp
OS10(config-evpn-vrf-tenant1)# end
```

### 20. Export BGP EVPN routes out of border-leaf switch to external devices.

For interpod connectivity, use the following configuration to export the BGP EVPN routes of a VXLAN pod from the border-leaf router.

With connected routes of virtual networks present in an individual VTEP advertised as type-5 routes, the border-leaf router has information about all the virtual networks present in the pod.

```
OS10(config)# router bgp 100
OS10(config-router-bgp-100)# vrf tenant1
OS10(config-router-bgp-100-vrf)# address-family ipv4 unicast
OS10(configure-router-bgpv4-vrf-af)# redistribute l2vpn evpn
OS10(configure-router-bgpv4-vrf-af)# end
```

The `redistribute l2vpn evpn` command redistributes both type-2 mac-ip (/32 routes) and type-5 routes (subnet routes). Use the `route-map` command to filter type-2 mac-ip (/32 routes) and redistribute only the type-5 routes.

```
OS10(config)# ip prefix-list deny_v4_host_routes seq 10 deny 0.0.0.0/0 ge 32 le 32
OS10(config)# ip prefix-list deny_v4_host_routes seq 20 permit 0.0.0.0/0 le 31
OS10(config)# route-map deny_v4_host_routes permit 10
OS10(config-route-map)# match ip address prefix-list deny_v4_host_routes
OS10(config-route-map)# exit

OS10(config)# router bgp 100
OS10(config-router-bgp-100)# vrf tenant1
OS10(config-router-bgp-100-vrf)# address-family ipv4 unicast
OS10(configure-router-bgpv4-vrf-af)# redistribute l2vpn evpn route-map
deny_v4_host_routes
OS10(configure-router-bgpv4-vrf-af)# end
```

Use the following configuration to advertise the local connected routes on the border-leaf switches to external device:

```
OS10(config)# router bgp 100
OS10(config-router-bgp-100)# vrf tenant1
OS10(config-router-bgp-100-vrf)# address-family ipv4 unicast
OS10(configure-router-bgpv4-vrf-af)# redistribute connected
OS10(configure-router-bgpv4-vrf-af)# end
```

## VTEP 4 Leaf Switch

### 1. Configure a Loopback interface for the VXLAN underlay using same IP address as the VLT peer.

```
OS10(config)# interface loopback0
OS10(config-if-lo-0)# no shutdown
OS10(config-if-lo-0)# ip address 192.168.2.1/32
OS10(config-if-lo-0)# exit
```

### 2. Configure the Loopback interface as the VXLAN source tunnel interface.

```
OS10(config)# nve
OS10(config-nve)# source-interface loopback0
OS10(config-nve)# exit
```

### 3. Configure the VXLAN virtual network.

```
OS10(config)# virtual-network 20000
OS10(config-vn-20000)# vxlan-vni 20000
OS10(config-vn-vxlan-vni)# exit
OS10(config-vn-20000)# exit
```

### 4. Configure the unused VLAN ID for untagged membership.

```
OS10(config)# virtual-network untagged-vlan 1000
```

### 5. Configure access ports as VLAN members for a port-scoped VLAN-to-VNI mapping.

```
OS10(config)# interface port-channel20
OS10(config-if-po-20)# no shutdown
OS10(config-if-po-20)# switchport mode trunk
OS10(config-if-po-20)# no switchport access vlan
OS10(config-if-po-20)# exit

OS10(config)# interface ethernet1/1/6
OS10(config-if-eth1/1/6)# no shutdown
OS10(config-if-eth1/1/6)# channel-group 20 mode active
OS10(config-if-eth1/1/6)# no switchport
OS10(config-if-eth1/1/6)# exit
```

### 6. Add the access ports to the virtual network.

```
OS10(config)# virtual-network 20000
OS10(config-vn-20000)# member-interface port-channel 20 untagged
OS10(config-vn)# exit
```

### 7. Configure upstream network-facing ports.

```
OS10(config)# interface ethernet1/1/1
OS10(config-if-eth1/1/1)# no shutdown
OS10(config-if-eth1/1/1)# no switchport
OS10(config-if-eth1/1/1)# mtu 1650
OS10(config-if-eth1/1/1)# ip address 172.19.1.0/31
OS10(config-if-eth1/1/1)# exit

OS10(config)# interface ethernet1/1/2
OS10(config-if-eth1/1/2)# no shutdown
OS10(config-if-eth1/1/2)# no switchport
OS10(config-if-eth1/1/2)# mtu 1650
OS10(config-if-eth1/1/2)# ip address 172.19.2.0/31
OS10(config-if-eth1/1/2)# exit
```

### 8. Configure eBGP.

```
OS10(config)# router bgp 100
OS10(config-router-bgp-100)# router-id 172.19.0.1
OS10(config-router-bgp-100)# address-family ipv4 unicast
```

```
OS10(configure-router-bgp-af)# redistribute connected
OS10(configure-router-bgp-af)# exit
```

### 9. Configure eBGP for the IPv4 point-to-point peering.

```
OS10(config-router-bgp-100)# neighbor 172.19.1.1
OS10(config-router-neighbor)# remote-as 101
OS10(config-router-neighbor)# address-family ipv4 unicast
OS10(config-router-bgp-neighbor-af)# allowas-in 1
OS10(config-router-bgp-neighbor-af)# exit
OS10(config-router-neighbor)# no shutdown
OS10(config-router-neighbor)# exit

OS10(config-router-bgp-100)# neighbor 172.19.2.1
OS10(config-router-neighbor)# remote-as 101
OS10(config-router-neighbor)# address-family ipv4 unicast
OS10(config-router-bgp-neighbor-af)# allowas-in 1
OS10(config-router-bgp-neighbor-af)# exit
OS10(config-router-neighbor)# no shutdown
OS10(config-router-neighbor)# exit
OS10(config-router-bgp-100)# exit
```

### 10. Configure a Loopback interface for BGP EVPN peering different from the VLT peer IP address.

```
OS10(config)# interface loopback1
OS10(conf-if-lo-1)# no shutdown
OS10(conf-if-lo-1)# ip address 172.19.0.1/32
OS10(conf-if-lo-1)# exit
```

### 11. Configure BGP EVPN peering.

```
OS10(config)# router bgp 100
OS10(config-router-bgp-100)# neighbor 172.201.0.1
OS10(config-router-neighbor)# remote-as 101
OS10(config-router-neighbor)# ebgp-multihop 4
OS10(config-router-neighbor)# send-community extended
OS10(config-router-neighbor)# update-source loopback1
OS10(config-router-neighbor)# no shutdown
OS10(config-router-neighbor)# address-family ipv4 unicast
OS10(config-router-bgp-neighbor-af)# no activate
OS10(config-router-bgp-neighbor-af)# exit
OS10(config-router-neighbor)# address-family l2vpn evpn
OS10(config-router-bgp-neighbor-af)# activate
OS10(config-router-bgp-neighbor-af)# allowas-in 1
OS10(config-router-bgp-neighbor-af)# exit
OS10(config-router-neighbor)# exit

OS10(config-router-bgp-100)# neighbor 172.202.0.1
OS10(config-router-neighbor)# remote-as 101
OS10(config-router-neighbor)# ebgp-multihop 4
OS10(config-router-neighbor)# send-community extended
OS10(config-router-neighbor)# update-source loopback1
OS10(config-router-neighbor)# no shutdown
OS10(config-router-neighbor)# address-family ipv4 unicast
OS10(config-router-bgp-neighbor-af)# no activate
OS10(config-router-bgp-neighbor-af)# exit
OS10(config-router-neighbor)# address-family l2vpn evpn
OS10(config-router-bgp-neighbor-af)# activate
OS10(config-router-bgp-neighbor-af)# allowas-in 1
OS10(config-router-bgp-neighbor-af)# exit
OS10(config-router-neighbor)# exit
OS10(config-router-bgp-100)# exit
```

### 12. Configure EVPN for the VXLAN virtual network.

Configure the EVPN instance manual configuration mode, and RD, and RT configuration in auto mode.

```
OS10(config)# evpn
OS10(config-evpn)# evi 20000
OS10(config-evpn-evi-20000)# vni 20000
OS10(config-evpn-evi-20000)# rd auto
```

```
OS10(config-evpn-evi-20000)# route-target auto
OS10(config-evpn-evi-20000)# exit
OS10(config-evpn)# exit
```

### 13. Configure VLT.

#### Configure a VLTi VLAN for the virtual network.

```
OS10(config)# virtual-network 20000
OS10(conf-vn-20000)# vlti-vlan 200
OS10(conf-vn-20000)# exit
```

#### Configure a dedicated L3 underlay path to reach the VLT Peer in case of a network failure.

```
OS10(config)# interface vlan4000
OS10(config-if-vl-4000)# no shutdown
OS10(config-if-vl-4000)# ip address 172.16.250.11/31
OS10(config-if-vl-4000)# exit
```

#### Configure the VLT port channel.

```
OS10(config)# interface port-channel20
OS10(conf-if-po-20)# vlt-port-channel 20
OS10(conf-if-po-20)# exit
```

#### Configure VLTi member links.

```
OOS10(config)# interface ethernet1/1/3
OS10(conf-if-eth1/1/3)# no shutdown
OS10(conf-if-eth1/1/3)# no switchport
OS10(conf-if-eth1/1/3)# exit
```

```
OS10(config)# interface ethernet1/1/4
OS10(conf-if-eth1/1/4)# no shutdown
OS10(conf-if-eth1/1/4)# no switchport
OS10(conf-if-eth1/1/4)# exit
```

#### Configure the VLT domain.

```
OS10(config)# vlt-domain 1
OS10(conf-vlt-1)# backup destination 10.16.150.4
OS10(conf-vlt-1)# discovery-interface ethernet1/1/3,1/1/4
OS10(conf-vlt-1)# vlt-mac aa:bb:cc:dd:ff:ee
OS10(conf-vlt-1)# exit
```

#### Configure UFD with uplink VLT ports and downlink network ports.

```
OS10(config)# uplink-state-group 1
OS10(conf-uplink-state-group-1)# enable
OS10(conf-uplink-state-group-1)# downstream ethernet1/1/1-1/1/2
OS10(conf-uplink-state-group-1)# upstream port-channel20
OS10(conf-uplink-state-group-1)# exit
```

#### Configure iBGP IPv4 peering between the VLT peers.

```
OS10(config)# router bgp 100
OS10(config-router-bgp-100)# neighbor 172.16.250.10
OS10(config-router-neighbor)# remote-as 100
OS10(config-router-neighbor)# no shutdown
OS10(config-router-neighbor)# exit
OS10(config-router-bgp-100)# exit
```

### 14. Configure IP routing in the overlay network.

#### Create a tenant VRF.

```
OS10(config)# ip vrf tenant1
OS10(conf-vrf)# exit
```

### Configure an anycast gateway MAC address.

```
OS10(config)# ip virtual-router mac-address 00:01:01:01:01:01
```

### Configure routing on the virtual network.

```
OS10(config)# interface virtual-network 20000
OS10(config-if-vn-20000)# ip vrf forwarding tenant1
OS10(config-if-vn-20000)# ip address 10.2.0.234/16
OS10(config-if-vn-20000)# ip virtual-router address 10.2.0.100
OS10(config-if-vn-20000)# no shutdown
OS10(config-if-vn-20000)# exit
```

### 15. Configure symmetric IRB.

In EVPN mode, configure the router MAC used by remote VTEPs as the destination address in VXLAN encapsulated packets sent to the switch. Configure a dedicated VXLAN VNI for symmetric IRB for each tenant VRF.

```
OS10(config)# evpn
OS10(config-evpn)# router-mac 00:01:02:03:04:06
OS10(config-evpn)# vrf tenant1
OS10(config-evpn-vrf-tenant1)# vni 3000
OS10(config-evpn-vrf-tenant1)# route-target 65535:30000 both
OS10(config-evpn-vrf-tenant1)# exit
OS10(config-evpn)# exit
OS10(config)#
```

### 16. Configure an externally connected VLAN.

```
OS10(config)# interface vlan 200
OS10(config-if-vlan)# ip vrf forwarding tenant1
OS10(config-if-vlan)# ip address 10.10.0.2/16
OS10(config-if-vlan)# no shutdown
OS10(config-if-vlan)# exit

OS10(config)# interface ethernet 1/1/7
OS10(config-if-eth1/1/7)# switchport mode trunk
OS10(config-if-eth1/1/7)# switchport trunk allowed vlan 200
```

### 17. Configure advertisement of the connected networks via EVPN Type-5 routes.

```
OS10(config)# evpn
OS10(config-evpn)# vrf tenant1
OS10(config-evpn-vrf-tenant1)# advertise ipv4 connected
OS10(config-evpn-vrf-tenant1)# exit
```

### 18. Configure BGP session with external router on the border-leaf VTEPs.

```
OS10(config)# router bgp 100
OS10(config-router-bgp-100)# vrf tenant1
OS10(config-router-bgp-100-vrf)# neighbor 10.10.0.3
OS10(config-router-vrf-neighbor)# remote-as 102
OS10(config-router-vrf-neighbor)# no shutdown
OS10(config-router-vrf-neighbor)# end
```

### 19. Import external routes in to EVPN on the border-leaf switches.

External routes for WAN connectivity and other appliances can be imported in to a VXLAN pod using the following configuration on the border-leaf router.

```
OS10(config)# evpn
OS10(config-evpn)# vrf tenant1
OS10(config-evpn-vrf-tenant1)# advertise ipv4 bgp
OS10(config-evpn-vrf-tenant1)# end
```

### 20. Export BGP EVPN routes out of border-leaf switch to external devices.

For interpod connectivity, use the following configuration to export the BGP EVPN routes of a VXLAN pod from the border-leaf router.



With connected routes of virtual networks present in an individual VTEP advertised as type-5 routes, the border-leaf router has information about all the virtual networks present in the pod.

```
OS10(config)# router bgp 100
OS10(config-router-bgp-100)# vrf tenant1
OS10(config-router-bgp-100-vrf)# address-family ipv4 unicast
OS10(configure-router-bgpv4-vrf-af)# redistribute l2vpn evpn
OS10(configure-router-bgpv4-vrf-af)# end
```

The redistribute l2vpn evpn command redistributes both type-2 mac-ip (/32 routes) and type-5 routes (subnet routes). Use the route-map command to filter type-2 mac-ip (/32 routes) and redistribute only the type-5 routes.

```
OS10(config)# ip prefix-list deny_v4_host_routes seq 10 deny 0.0.0.0/0 ge 32 le 32
OS10(config)# ip prefix-list deny_v4_host_routes seq 20 permit 0.0.0.0/0 le 31
OS10(config)# route-map deny_v4_host_routes permit 10
OS10(config-route-map)# match ip address prefix-list deny_v4_host_routes
OS10(config-route-map)# exit

OS10(config)# router bgp 100
OS10(config-router-bgp-100)# vrf tenant1
OS10(config-router-bgp-100-vrf)# address-family ipv4 unicast
OS10(configure-router-bgpv4-vrf-af)# redistribute l2vpn evpn route-map
deny_v4_host_routes
OS10(configure-router-bgpv4-vrf-af)# end
```

Use the following configuration to advertise the local connected routes on the border-leaf switches to external device:

```
OS10(config)# router bgp 100
OS10(config-router-bgp-100)# vrf tenant1
OS10(config-router-bgp-100-vrf)# address-family ipv4 unicast
OS10(configure-router-bgpv4-vrf-af)# redistribute connected
OS10(configure-router-bgpv4-vrf-af)# end
```

## Spine Switch 1

### 1. Configure downstream ports on underlay links to the leaf switches.

```
OS10(config)# interface ethernet1/1/1
OS10(conf-if-eth1/1/1)# no shutdown
OS10(conf-if-eth1/1/1)# no switchport
OS10(conf-if-eth1/1/1)# ip address 172.16.1.1/31
OS10(conf-if-eth1/1/1)# exit
OS10(config)# interface ethernet1/1/2
OS10(conf-if-eth1/1/2)# no shutdown
OS10(conf-if-eth1/1/2)# no switchport
OS10(conf-if-eth1/1/2)# ip address 172.17.1.1/31
OS10(conf-if-eth1/1/2)# exit
OS10(config)# interface ethernet1/1/3
OS10(conf-if-eth1/1/3)# no shutdown
OS10(conf-if-eth1/1/3)# no switchport
OS10(conf-if-eth1/1/3)# ip address 172.18.1.1/31
OS10(conf-if-eth1/1/3)# exit
OS10(config)# interface ethernet1/1/4
OS10(conf-if-eth1/1/4)# no shutdown
OS10(conf-if-eth1/1/4)# no switchport
OS10(conf-if-eth1/1/4)# ip address 172.19.1.1/31
OS10(conf-if-eth1/1/4)# exit
```

### 2. Configure eBGP.

```
OS10(config)# router bgp 101
OS10(config-router-bgp-101)# router-id 172.201.0.1
OS10(config-router-bgp-101)# address-family ipv4 unicast
OS10(configure-router-bgpv4-af)# redistribute connected
OS10(configure-router-bgpv4-af)# exit
```

### 3. Configure eBGP IPv4 peer sessions on the P2P links.

```
OS10(conf-router-bgp-101)# neighbor 172.16.1.0
OS10(conf-router-neighbor)# remote-as 100
OS10(conf-router-neighbor)# no shutdown
OS10(conf-router-neighbor)# address-family ipv4 unicast
OS10(conf-router-neighbor-af)# no sender-side-loop-detection
OS10(conf-router-neighbor-af)# exit
OS10(conf-router-neighbor)# exit

OS10(conf-router-bgp-101)# neighbor 172.17.1.0
OS10(conf-router-neighbor)# remote-as 100
OS10(conf-router-neighbor)# no shutdown
OS10(conf-router-neighbor)# address-family ipv4 unicast
OS10(conf-router-neighbor-af)# no sender-side-loop-detection
OS10(conf-router-neighbor-af)# exit
OS10(conf-router-neighbor)# exit

OS10(conf-router-bgp-101)# neighbor 172.18.1.0
OS10(conf-router-neighbor)# remote-as 100
OS10(conf-router-neighbor)# no shutdown
OS10(conf-router-neighbor)# address-family ipv4 unicast
OS10(conf-router-neighbor-af)# no sender-side-loop-detection
OS10(conf-router-neighbor-af)# exit
OS10(conf-router-neighbor)# exit

OS10(conf-router-bgp-101)# neighbor 172.19.1.0
OS10(conf-router-neighbor)# remote-as 100
OS10(conf-router-neighbor)# no shutdown
OS10(conf-router-neighbor)# address-family ipv4 unicast
OS10(conf-router-neighbor-af)# no sender-side-loop-detection
OS10(conf-router-neighbor-af)# exit
OS10(conf-router-neighbor)# exit
OS10(conf-router-bgp-101)# exit
```

### 4. Configure a Loopback interface for BGP EVPN peering.

```
OS10(config)# interface loopback1
OS10(conf-if-lo-1)# no shutdown
OS10(conf-if-lo-1)# ip address 172.201.0.1/32
OS10(conf-if-lo-1)# exit
```

### 5. Configure BGP EVPN peer sessions.

```
OS10(config)# router bgp 101
OS10(conf-router-bgp-101)# neighbor 172.16.0.1
OS10(conf-router-neighbor)# ebgp-multihop 4
OS10(conf-router-neighbor)# remote-as 100
OS10(conf-router-neighbor)# send-community extended
OS10(conf-router-neighbor)# update-source loopback1
OS10(conf-router-neighbor)# no shutdown
OS10(conf-router-neighbor)# address-family ipv4 unicast
OS10(conf-router-neighbor-af)# no activate
OS10(conf-router-neighbor-af)# exit
OS10(conf-router-neighbor)# address-family l2vpn evpn
OS10(conf-router-neighbor-af)# no sender-side-loop-detection
OS10(conf-router-neighbor-af)# activate
OS10(conf-router-neighbor-af)# exit

OS10(conf-router-bgp-101)# neighbor 172.17.0.1
OS10(conf-router-neighbor)# ebgp-multihop 4
OS10(conf-router-neighbor)# remote-as 100
OS10(conf-router-neighbor)# send-community extended
OS10(conf-router-neighbor)# update-source loopback1
OS10(conf-router-neighbor)# no shutdown
OS10(conf-router-neighbor)# address-family ipv4 unicast
OS10(conf-router-neighbor-af)# no activate
OS10(conf-router-neighbor-af)# exit
OS10(conf-router-neighbor)# address-family l2vpn evpn
OS10(conf-router-neighbor-af)# no sender-side-loop-detection
OS10(conf-router-neighbor-af)# activate
OS10(conf-router-neighbor-af)# exit
```

```

OS10(conf-router-bgp-101)# neighbor 172.18.0.1
OS10(conf-router-neighbor)# ebgp-multihop 4
OS10(conf-router-neighbor)# remote-as 100
OS10(conf-router-neighbor)# send-community extended
OS10(conf-router-neighbor)# update-source loopback1
OS10(conf-router-neighbor)# no shutdown
OS10(conf-router-neighbor)# address-family ipv4 unicast
OS10(conf-router-neighbor-af)# no activate
OS10(conf-router-neighbor-af)# exit
OS10(conf-router-neighbor)# address-family l2vpn evpn
OS10(conf-router-neighbor-af)# no sender-side-loop-detection
OS10(conf-router-neighbor-af)# activate
OS10(conf-router-neighbor-af)# exit

OS10(conf-router-bgp-101)# neighbor 172.19.0.1
OS10(conf-router-neighbor)# ebgp-multihop 4
OS10(conf-router-neighbor)# remote-as 100
OS10(conf-router-neighbor)# send-community extended
OS10(conf-router-neighbor)# update-source loopback1
OS10(conf-router-neighbor)# no shutdown
OS10(conf-router-neighbor)# address-family ipv4 unicast
OS10(conf-router-neighbor-af)# no activate
OS10(conf-router-neighbor-af)# exit
OS10(conf-router-neighbor)# address-family l2vpn evpn
OS10(conf-router-neighbor-af)# no sender-side-loop-detection
OS10(conf-router-neighbor-af)# activate
OS10(conf-router-neighbor-af)# exit

```

## Spine Switch 2

### 1. Configure downstream ports on the underlay links to the leaf switches.

```

OS10(config)# interface ethernet1/1/1
OS10(conf-if-eth1/1/1)# no shutdown
OS10(conf-if-eth1/1/1)# no switchport
OS10(conf-if-eth1/1/1)# ip address 172.16.2.1/31
OS10(conf-if-eth1/1/1)# exit
OS10(config)# interface ethernet1/1/2
OS10(conf-if-eth1/1/2)# no shutdown
OS10(conf-if-eth1/1/2)# no switchport
OS10(conf-if-eth1/1/2)# ip address 172.17.2.1/31
OS10(conf-if-eth1/1/2)# exit
OS10(config)# interface ethernet1/1/3
OS10(conf-if-eth1/1/3)# no shutdown
OS10(conf-if-eth1/1/3)# no switchport
OS10(conf-if-eth1/1/3)# ip address 172.18.2.1/31
OS10(conf-if-eth1/1/3)# exit
OS10(config)# interface ethernet1/1/4
OS10(conf-if-eth1/1/4)# no shutdown
OS10(conf-if-eth1/1/4)# no switchport
OS10(conf-if-eth1/1/4)# ip address 172.19.2.1/31
OS10(conf-if-eth1/1/4)# exit

```

### 2. Configure eBGP.

```

OS10(config)# router bgp 101
OS10(config-router-bgp-101)# router-id 172.202.0.1
OS10(config-router-bgp-101)# address-family ipv4 unicast
OS10(configure-router-bgpv4-af)# redistribute connected
OS10(configure-router-bgpv4-af)# exit

```

### 3. Configure eBGP IPv4 peer sessions on the P2P links.

```

OS10(conf-router-bgp-101)# neighbor 172.16.2.0
OS10(conf-router-neighbor)# remote-as 100
OS10(conf-router-neighbor)# no shutdown
OS10(conf-router-neighbor)# address-family ipv4 unicast
OS10(conf-router-neighbor-af)# no sender-side-loop-detection

```

```

OS10(conf-router-neighbor-af)# exit
OS10(conf-router-neighbor)# exit

OS10(conf-router-bgp-101)# neighbor 172.17.2.0
OS10(conf-router-neighbor)# remote-as 100
OS10(conf-router-neighbor)# no shutdown
OS10(conf-router-neighbor)# address-family ipv4 unicast
OS10(conf-router-neighbor-af)# no sender-side-loop-detection
OS10(conf-router-neighbor-af)# exit
OS10(conf-router-neighbor)# exit

OS10(conf-router-bgp-101)# neighbor 172.18.2.0
OS10(conf-router-neighbor)# remote-as 100
OS10(conf-router-neighbor)# no shutdown
OS10(conf-router-neighbor)# address-family ipv4 unicast
OS10(conf-router-neighbor-af)# no sender-side-loop-detection
OS10(conf-router-neighbor-af)# exit
OS10(conf-router-neighbor)# exit

OS10(conf-router-bgp-101)# neighbor 172.19.2.0
OS10(conf-router-neighbor)# remote-as 100
OS10(conf-router-neighbor)# no shutdown
OS10(conf-router-neighbor)# address-family ipv4 unicast
OS10(conf-router-neighbor-af)# no sender-side-loop-detection
OS10(conf-router-neighbor-af)# exit
OS10(conf-router-neighbor)# exit
OS10(conf-router-bgp-101)# exit

```

#### 4. Configure a Loopback interface for BGP EVPN peering.

```

OS10(config)# interface loopback1
OS10(conf-if-lo-1)# no shutdown
OS10(conf-if-lo-1)# ip address 172.202.0.1/32
OS10(conf-if-lo-1)# exit

```

#### 5. Configure BGP EVPN peer sessions.

```

OS10(config)# router bgp 101
OS10(conf-router-bgp-101)# neighbor 172.16.0.1
OS10(conf-router-neighbor)# ebgp-multihop 4
OS10(conf-router-neighbor)# remote-as 100
OS10(conf-router-neighbor)# send-community extended
OS10(conf-router-neighbor)# update-source loopback1
OS10(conf-router-neighbor)# no shutdown
OS10(conf-router-neighbor)# address-family ipv4 unicast
OS10(conf-router-neighbor-af)# no activate
OS10(conf-router-neighbor-af)# exit
OS10(conf-router-neighbor)# address-family l2vpn evpn
OS10(conf-router-neighbor-af)# no sender-side-loop-detection
OS10(conf-router-neighbor-af)# activate
OS10(conf-router-neighbor-af)# exit

OS10(conf-router-bgp-101)# neighbor 172.17.0.1
OS10(conf-router-neighbor)# ebgp-multihop 4
OS10(conf-router-neighbor)# remote-as 100
OS10(conf-router-neighbor)# send-community extended
OS10(conf-router-neighbor)# update-source loopback1
OS10(conf-router-neighbor)# no shutdown
OS10(conf-router-neighbor)# address-family ipv4 unicast
OS10(conf-router-neighbor-af)# no activate
OS10(conf-router-neighbor-af)# exit
OS10(conf-router-neighbor)# address-family l2vpn evpn
OS10(conf-router-neighbor-af)# no sender-side-loop-detection
OS10(conf-router-neighbor-af)# activate
OS10(conf-router-neighbor-af)# exit

OS10(conf-router-bgp-101)# neighbor 172.18.0.1
OS10(conf-router-neighbor)# ebgp-multihop 4
OS10(conf-router-neighbor)# remote-as 100
OS10(conf-router-neighbor)# send-community extended
OS10(conf-router-neighbor)# update-source loopback1
OS10(conf-router-neighbor)# no shutdown

```

```

OS10(conf-router-neighbor)# address-family ipv4 unicast
OS10(conf-router-neighbor-af)# no activate
OS10(conf-router-neighbor-af)# exit
OS10(conf-router-neighbor)# address-family l2vpn evpn
OS10(conf-router-neighbor-af)# no sender-side-loop-detection
OS10(conf-router-neighbor-af)# activate
OS10(conf-router-neighbor-af)# exit

OS10(conf-router-bgp-101)# neighbor 172.19.0.1
OS10(conf-router-neighbor)# ebgp-multihop 4
OS10(conf-router-neighbor)# remote-as 100
OS10(conf-router-neighbor)# send-community extended
OS10(conf-router-neighbor)# update-source loopback1
OS10(conf-router-neighbor)# no shutdown
OS10(conf-router-neighbor)# address-family ipv4 unicast
OS10(conf-router-neighbor-af)# no activate
OS10(conf-router-neighbor-af)# exit
OS10(conf-router-neighbor)# address-family l2vpn evpn
OS10(conf-router-neighbor-af)# no sender-side-loop-detection
OS10(conf-router-neighbor-af)# activate
OS10(conf-router-neighbor-af)# exit

```

## Verify VXLAN with BGP EVPN configuration.

### 1. Verify virtual network configurations.

```

LEAF1# show virtual-network
Codes: DP - MAC-learn Dataplane, CP - MAC-learn Controlplane, UUD - Unknown-Unicast-Drop
Virtual Network: 10000
Members:
 VLAN 100: port-channel10, port-channel1000
VxLAN Virtual Network Identifier: 10000
Source Interface: loopback0(192.168.1.1)
Remote-VTEPs (flood-list):
LEAF1#

```

### 2. Verify EVPN configurations and EVPN parameters.

```

LEAF1# show evpn evi

EVI : 10000, State : up
 Bridge-Domain : Virtual-Network 10000, VNI 10000
 Route-Distinguisher : 1:192.168.1.1:10000(auto)
 Route-Targets : 0:100:268445456(auto) both
 Inclusive Multicast :
 IRB : Enabled(tenant1)

LEAF1#

```

```

LEAF1# show evpn vrf l3-vni

VRF : tenant1, State : up
 L3-VNI : 3000
 Route-Distinguisher : 1:192.168.1.1:3000(auto)
 Route-Targets : 0:65535:30000 both
 Remote VTEP : 192.168.2.1

LEAF1#

```

### 3. Verify BGP EVPN neighborhood between leaf and spine nodes.

```

LEAF1# show ip bgp l2vpn evpn summary
BGP router identifier 172.16.0.1 local AS number 100
Neighbor AS MsgRcvd MsgSent Up/Down State/Pfx
172.201.0.1 101 1132 1116 13:29:00 27
172.202.0.1 101 1131 1118 13:29:02 28
LEAF1#

```

#### 4. Check connectivity between host A and host B.

```
root@HOST-A:~# ping 10.2.0.20 -c 5
PING 10.2.0.10 (10.2.0.10) 56(84) bytes of data.
64 bytes from 10.2.0.10: icmp_seq=1 ttl=63 time=0.824 ms
64 bytes from 10.2.0.10: icmp_seq=2 ttl=63 time=0.847 ms
64 bytes from 10.2.0.10: icmp_seq=3 ttl=63 time=0.835 ms
64 bytes from 10.2.0.10: icmp_seq=4 ttl=63 time=0.944 ms
64 bytes from 10.2.0.10: icmp_seq=5 ttl=63 time=0.806 ms

--- 10.2.0.10 ping statistics ---
5 packets transmitted, 5 received, 0% packet loss, time 4078ms
rtt min/avg/max/mdev = 0.806/0.851/0.944/0.051 ms
root@HOST-A:~#
```

# Example - VXLAN BGP EVPN symmetric IRB with unnumbered BGP peering

The following BGP EVPN example uses a Clos leaf-spine topology with BGP over unnumbered interfaces.

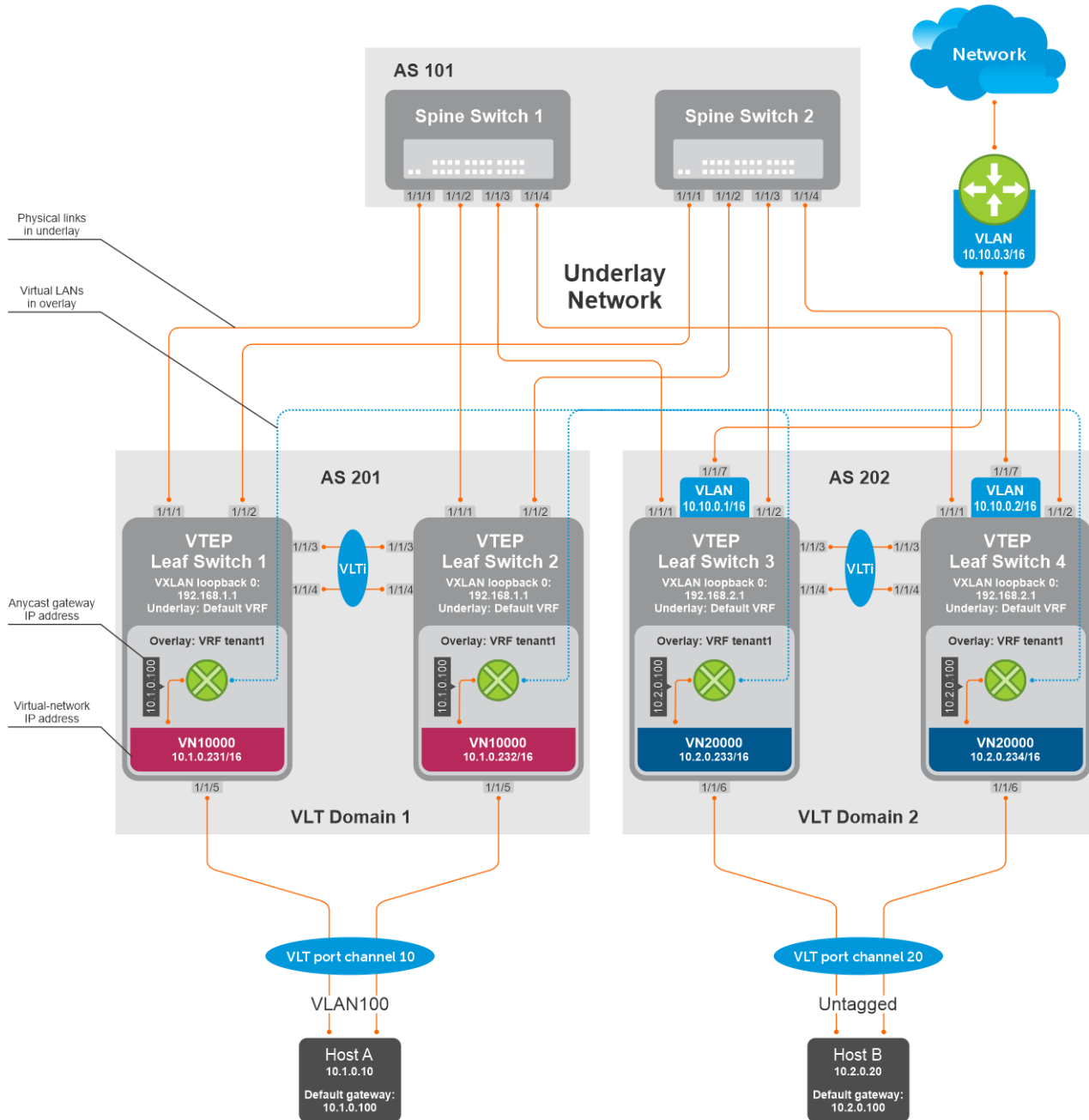

The following explains how the network is configured:

- External BGP (eBGP) over unnumbered interfaces is used to exchange both IPv4 routes and EVPN routes.
- You need not configure IP addresses on links that connect Spine and Leaf switches. BGP Unnumbered peering works without an IP address configuration on Spine-Leaf links.
- The remote AS is autodiscovered from BGP Open messages.
- All VTEPs perform Symmetric IRB routing. All spine nodes are in one autonomous system and each VTEP in the leaf network belongs to different autonomous systems. Both Spine Switch 1 and Spine Switch 2 are in AS 101. For leaf nodes, VLT domain 1 is in AS 201; VLT domain 2 is in AS 202.

- On leaf switches 1 and 2, access ports are assigned to a virtual network using a switch-scoped VLAN. EVPN for the overlay VXLAN is configured using auto-EVI mode.
- On leaf switches 3 and 4, access ports are assigned to a virtual network using a port-scoped VLAN. EVPN for the overlay VXLAN is configured using manual EVI mode with RT and RD values configured in auto mode.
- On all VTEPs, symmetric IRB is configured in EVPN mode using a unique, dedicated VXLAN VNI, and Auto RD and Auto RT values for each tenant VRF.
- On all VTEPs, the `disable-rt-asn` command is used to autoderive the RT that does not include the ASN in the RT value. This allows auto RT to be used even if there are different ASNs for each leaf node.
- The VLAN to an external network is configured only on VTEPs 3 and 4 in the VLT domain that serves as the border leaf gateway.

### Spine Switch 1 configuration

1. Configure downstream ports as unnumbered interfaces. Configure the `ipv6 nd send-ra` command and lower RA intervals. These interfaces are used for BGP unnumbered peering.

```
OS10(config)# interface ethernet1/1/1
OS10(config-if-eth1/1/1)# no shutdown
OS10(config-if-eth1/1/1)# no switchport
OS10(config-if-eth1/1/1)# mtu 1650
OS10(config-if-eth1/1/1)# ipv6 nd max-ra-interval 4
OS10(config-if-eth1/1/1)# ipv6 nd min-ra-interval 3
OS10(config-if-eth1/1/1)# ipv6 nd send-ra
OS10(config-if-eth1/1/1)# exit
OS10(config)# interface ethernet1/1/2
OS10(config-if-eth1/1/2)# no shutdown
OS10(config-if-eth1/1/2)# no switchport
OS10(config-if-eth1/1/2)# mtu 1650
OS10(config-if-eth1/1/2)# ipv6 nd max-ra-interval 4
OS10(config-if-eth1/1/2)# ipv6 nd min-ra-interval 3
OS10(config-if-eth1/1/2)# ipv6 nd send-ra
OS10(config-if-eth1/1/2)# exit
OS10(config)# interface ethernet1/1/3
OS10(config-if-eth1/1/3)# no shutdown
OS10(config-if-eth1/1/3)# no switchport
OS10(config-if-eth1/1/3)# mtu 1650
OS10(config-if-eth1/1/3)# ipv6 nd max-ra-interval 4
OS10(config-if-eth1/1/3)# ipv6 nd min-ra-interval 3
OS10(config-if-eth1/1/3)# ipv6 nd send-ra
OS10(config-if-eth1/1/3)# exit
OS10(config)# interface ethernet1/1/4
OS10(config-if-eth1/1/4)# no shutdown
OS10(config-if-eth1/1/4)# no switchport
OS10(config-if-eth1/1/4)# mtu 1650
OS10(config-if-eth1/1/4)# ipv6 nd max-ra-interval 4
OS10(config-if-eth1/1/4)# ipv6 nd min-ra-interval 3
OS10(config-if-eth1/1/4)# ipv6 nd send-ra
OS10(config-if-eth1/1/4)# exit
```

2. Configure BGP instance with router id.

```
OS10(config)# router bgp 101
OS10(config-router-bgp-101)# router-id 172.201.0.1
```

3. Configure the BGP unnumbered neighbor on Leaf-facing ports. Use a template to simplify the configuration on multiple interfaces. These neighbors are configured to carry IPv4 address family (default) and L2VPN EVPN address family.

```
OS10(config-router-bgp-101)# template ebgp_unified
OS10(config-router-template)# send-community extended
OS10(config-router-template)# address-family l2vpn evpn
OS10(config-router-bgp-template-af)# activate
OS10(config-router-bgp-template-af)# exit
OS10(config-router-template)# neighbor interface ethernet1/1/1
OS10(config-router-neighbor)# inherit template ebgp_unified inherit-type ebgp
OS10(config-router-neighbor)# no shutdown
OS10(config-router-neighbor)# exit
OS10(config-router-bgp-101)# neighbor interface ethernet1/1/2
OS10(config-router-neighbor)# inherit template ebgp_unified inherit-type ebgp
OS10(config-router-neighbor)# no shutdown
OS10(config-router-neighbor)# exit
OS10(config-router-bgp-101)# neighbor interface ethernet1/1/3
```



```

OS10(config-router-neighbor)# inherit template ebgp_unified inherit-type ebgp
OS10(config-router-neighbor)# no shutdown
OS10(config-router-neighbor)# exit
OS10(config-router-bgp-101)# neighbor interface ethernet1/1/4
OS10(config-router-neighbor)# inherit template ebgp_unified inherit-type ebgp
OS10(config-router-neighbor)# no shutdown
OS10(config-router-neighbor)# exit

```

## Spine Switch 2 configuration

1. Configure downstream ports as unnumbered interfaces. Configure the `ipv6 nd send-ra` command and lower RA intervals. These interfaces are used for BGP unnumbered peering.

```

OS10(config)# interface ethernet1/1/1
OS10(conf-if-eth1/1/1)# no shutdown
OS10(conf-if-eth1/1/1)# no switchport
OS10(conf-if-eth1/1/1)# mtu 1650
OS10(conf-if-eth1/1/1)# ipv6 nd max-ra-interval 4
OS10(conf-if-eth1/1/1)# ipv6 nd min-ra-interval 3
OS10(conf-if-eth1/1/1)# ipv6 nd send-ra
OS10(conf-if-eth1/1/1)# exit
OS10(config)# interface ethernet1/1/2
OS10(conf-if-eth1/1/2)# no shutdown
OS10(conf-if-eth1/1/2)# no switchport
OS10(conf-if-eth1/1/1)# mtu 1650
OS10(conf-if-eth1/1/2)# ipv6 nd max-ra-interval 4
OS10(conf-if-eth1/1/2)# ipv6 nd min-ra-interval 3
OS10(conf-if-eth1/1/2)# ipv6 nd send-ra
OS10(conf-if-eth1/1/2)# exit
OS10(config)# interface ethernet1/1/3
OS10(conf-if-eth1/1/3)# no shutdown
OS10(conf-if-eth1/1/3)# no switchport
OS10(conf-if-eth1/1/3)# mtu 1650
OS10(conf-if-eth1/1/3)# ipv6 nd max-ra-interval 4
OS10(conf-if-eth1/1/3)# ipv6 nd min-ra-interval 3
OS10(conf-if-eth1/1/3)# ipv6 nd send-ra
OS10(conf-if-eth1/1/3)# exit
OS10(config)# interface ethernet1/1/4
OS10(conf-if-eth1/1/4)# no shutdown
OS10(conf-if-eth1/1/4)# no switchport
OS10(conf-if-eth1/1/4)# mtu 1650
OS10(conf-if-eth1/1/4)# ipv6 nd max-ra-interval 4
OS10(conf-if-eth1/1/4)# ipv6 nd min-ra-interval 3
OS10(conf-if-eth1/1/4)# ipv6 nd send-ra
OS10(conf-if-eth1/1/4)# exit

```

2. Configure BGP instance with router id.

```

OS10(config)# router bgp 101
OS10(config-router-bgp-101)# router-id 172.202.0.1

```

3. Configure the BGP unnumbered neighbor on Leaf-facing ports. Use a template to simplify the configuration on multiple interfaces. These neighbors are configured to carry IPv4 address family (default) and L2VPN EVPN address family.

```

OS10(config-router-bgp-101)# template ebgp_unified
OS10(config-router-template)# send-community extended
OS10(config-router-template)# address-family l2vpn evpn
OS10(config-router-bgp-template-af)# activate
OS10(config-router-bgp-template-af)# exit
OS10(config-router-template)# neighbor interface ethernet1/1/1
OS10(config-router-neighbor)# inherit template ebgp_unified inherit-type ebgp
OS10(config-router-neighbor)# no shutdown
OS10(config-router-neighbor)# exit
OS10(config-router-bgp-101)# neighbor interface ethernet1/1/2
OS10(config-router-neighbor)# inherit template ebgp_unified inherit-type ebgp
OS10(config-router-neighbor)# no shutdown
OS10(config-router-neighbor)# exit
OS10(config-router-bgp-101)# neighbor interface ethernet1/1/3
OS10(config-router-neighbor)# inherit template ebgp_unified inherit-type ebgp
OS10(config-router-neighbor)# no shutdown
OS10(config-router-neighbor)# exit
OS10(config-router-bgp-101)# neighbor interface ethernet1/1/4

```

```
OS10(config-router-neighbor)# inherit template ebgp_unified inherit-type ebgp
OS10(config-router-neighbor)# no shutdown
OS10(config-router-neighbor)# exit
```

### VTEP Leaf Switch 1 configuration

1. Configure a loopback interface for the VXLAN underlay using the same IP address as the VLT peer.

```
OS10(config)# interface loopback0
OS10(config-if-lo-0)# no shutdown
OS10(config-if-lo-0)# ip address 192.168.1.1/32
OS10(config-if-lo-0)# exit
```

2. Configure the loopback interface as the VXLAN source tunnel interface.

```
OS10(config)# nve
OS10(config-nve)# source-interface loopback0
OS10(config-nve)# exit
```

3. Configure the VXLAN virtual network.

```
OS10(config)# virtual-network 10000
OS10(config-vn-10000)# vxlan-vni 10000
OS10(config-vn-vxlan-vni)# exit
OS10(config-vn-10000)# exit
```

4. Assign VLAN to the virtual network. Use a switch-scoped VLAN-to-VNI mapping.

```
OS10(config)# interface vlan100
OS10(config-if-vl-100)# virtual-network 10000
OS10(config-if-vl-100)# exit
```

5. Configure access ports as VLAN members.

```
OS10(config)# interface port-channel10
OS10(config-if-po-10)# no shutdown
OS10(config-if-po-10)# switchport mode trunk
OS10(config-if-po-10)# switchport trunk allowed vlan 100
OS10(config-if-po-10)# no switchport access vlan
OS10(config-if-po-10)# exit
OS10(config)# interface ethernet1/1/5
OS10(config-if-eth1/1/5)# no shutdown
OS10(config-if-eth1/1/5)# channel-group 10 mode active
OS10(config-if-eth1/1/5)# exit
```

6. Configure upstream network-facing ports as unnumbered interfaces. Configure the `ipv6 nd send-ra` command and lower RA intervals. These interfaces are used for BGP unnumbered peering.

```
OS10(config)# interface ethernet1/1/1
OS10(config-if-eth1/1/1)# no shutdown
OS10(config-if-eth1/1/1)# no switchport
OS10(config-if-eth1/1/1)# mtu 1650
OS10(config-if-eth1/1/1)# ipv6 nd max-ra-interval 4
OS10(config-if-eth1/1/1)# ipv6 nd min-ra-interval 3
OS10(config-if-eth1/1/1)# ipv6 nd send-ra
OS10(config-if-eth1/1/1)# exit
OS10(config)# interface ethernet1/1/2
OS10(config-if-eth1/1/2)# no shutdown
OS10(config-if-eth1/1/2)# no switchport
OS10(config-if-eth1/1/2)# mtu 1650
OS10(config-if-eth1/1/2)# ipv6 nd max-ra-interval 4
OS10(config-if-eth1/1/2)# ipv6 nd min-ra-interval 3
OS10(config-if-eth1/1/2)# ipv6 nd send-ra
OS10(config-if-eth1/1/2)# exit
```

7. Configure BGP instance with router id.

```
OS10(config)# router bgp 201
OS10(config-router-bgp-201)# router-id 172.16.0.1
OS10(config-router-bgp-201)# address-family ipv4 unicast
```

```
OS10(config-router-bgp-af)# redistribute connected
OS10(config-router-bgp-af)# exit
```

8. Configure a BGP unnumbered neighbor over network facing ports. Use a template to simplify the configuration on multiple interfaces. These neighbors are configured to carry IPv4 address family (default) and L2VPN EVPN address family.

```
OS10(config-router-bgp-201)# template ebgp_unified
OS10(config-router-template)# send-community extended
OS10(config-router-template)# address-family l2vpn evpn
OS10(config-router-bgp-template-af)# activate
OS10(config-router-bgp-template-af)# exit
OS10(config-router-template)# neighbor interface ethernet1/1/1
OS10(config-router-neighbor)# inherit template ebgp_unified inherit-type ebgp
OS10(config-router-neighbor)# no shutdown
OS10(config-router-neighbor)# exit
OS10(config-router-bgp-201)# neighbor interface ethernet1/1/2
OS10(config-router-neighbor)# inherit template ebgp_unified inherit-type ebgp
OS10(config-router-neighbor)# no shutdown
OS10(config-router-neighbor)# exit
```

9. Configure EVPN for the VXLAN virtual network. Configure EVPN instances using auto-EVI mode and disable ASN in the generated RT.

```
OS10(config)# evpn
OS10(config-evpn)# auto-evi
OS10(config-evpn)# disable-rt-asn
OS10(config-evpn)# exit
```

**i** **NOTE:** Use the `disable-rt-asn` command to autoderive RT that does not include the ASN in the RT value. This allows auto RT to be used even if the Clos leaf-spine design has separate ASN for each leaf node. Configure this command only when all the VTEPs are OS10 switches.

10. Configure VLT.

- Configure a dedicated Layer 3 forwarding path through the other VLT peer for connectivity even if all spine links go down. This VLAN interface is an unnumbered interface and used for iBGP peering with the other VLT peer.

```
OS10(config)# interface vlan4000
OS10(config-if-vl-4000)# no shutdown
OS10(config-if-vl-4000)# ipv6 nd max-ra-interval 4
OS10(config-if-vl-4000)# ipv6 nd min-ra-interval 3
OS10(config-if-vl-4000)# ipv6 nd send-ra
OS10(config-if-vl-4000)# exit
```

- Configure the VLT port channel.

```
OS10(config)# interface port-channel10
OS10(conf-if-po-10)# vlt-port-channel 10
OS10(conf-if-po-10)# exit
```

- Configure the VLTi member links.

```
OS10(config)# interface ethernet1/1/3
OS10(conf-if-eth1/1/3)# no shutdown
OS10(conf-if-eth1/1/3)# no switchport
OS10(conf-if-eth1/1/3)# exit
OS10(config)# interface ethernet1/1/4
OS10(conf-if-eth1/1/4)# no shutdown
OS10(conf-if-eth1/1/4)# no switchport
OS10(conf-if-eth1/1/4)# exit
```

- Configure the VLT domain.

```
OS10(config)# vlt-domain 1
OS10(conf-vlt-1)# backup destination 10.16.150.1
OS10(conf-vlt-1)# discovery-interface ethernet1/1/3,1/1/4
OS10(conf-vlt-1)# vlt-mac aa:bb:cc:dd:ee:ff
OS10(conf-vlt-1)# exit
```

- Configure UFD with uplink VLT ports and downlink network ports.

```
OS10(config)# uplink-state-group 1
OS10(conf-uplink-state-group-1)# enable
OS10(conf-uplink-state-group-1)# downstream ethernet1/1/1-1/1/2
OS10(conf-uplink-state-group-1)# upstream port-channel10
OS10(conf-uplink-state-group-1)# exit
```

- Configure iBGP unnumbered peering between VLT peers with both IPv4 and L2VPN EVPN address families.

```
OS10(config)# router bgp 201
OS10(config-router-bgp-201)# template ibgp_unified
OS10(config-router-template)# send-community extended
OS10(config-router-template)# address-family l2vpn evpn
OS10(config-router-bgp-template-af)# activate
OS10(config-router-bgp-template-af)# exit
OS10(config-router-template)# neighbor interface vlan4000
OS10(config-router-neighbor)# inherit template ibgp_unified inherit-type ibgp
OS10(config-router-neighbor)# no shutdown
OS10(config-router-neighbor)# exit
```

## 11. Configure IP routing in the overlay network.

- Create a tenant VRF.

```
OS10(config)# ip vrf tenant1
OS10(conf-vrf)# exit
```

- Configure an anycast gateway MAC address.

```
OS10(config)# ip virtual-router mac-address 00:01:01:01:01:01
```

- Configure routing on the virtual network.

```
OS10(config)# interface virtual-network 10000
OS10(conf-if-vn-10000)# ip vrf forwarding tenant1
OS10(conf-if-vn-10000)# ip address 10.1.0.231/16
OS10(conf-if-vn-10000)# ip virtual-router address 10.1.0.100
OS10(conf-if-vn-10000)# no shutdown
OS10(conf-if-vn-10000)# exit
```

## 12. Configure symmetric IRB.

- In EVPN mode, configure the router MAC address that is used by remote VTEPs as the destination address in VXLAN encapsulated packets that are sent to the switch. Configure a dedicated VXLAN VNI for symmetric IRB for each tenant VRF.

```
OS10(config)# evpn
OS10(config-evpn)# router-mac 00:01:02:03:04:05
OS10(config-evpn)# vrf tenant1
OS10((config-evpn-vrf-tenant1))# vni 3000
OS10((config-evpn-vrf-tenant1))# route-target auto
OS10((config-evpn-vrf-tenant1))# exit
OS10(config-evpn)# exit
```

## 13. Configure advertisement of the connected networks through EVPN Type-5 routes.

```
OS10(config)# evpn
OS10(config-evpn)# vrf tenant1
OS10((config-evpn-vrf-tenant1))# advertise ipv4 connected
OS10((config-evpn-vrf-tenant1))# exit
```

## VTEP Leaf Switch 2 configuration

1. Configure a loopback interface for the VXLAN underlay using the same IP address as the VLT peer.

```
OS10(config)# interface loopback0
OS10(conf-if-lo-0)# no shutdown
OS10(conf-if-lo-0)# ip address 192.168.1.1/32
OS10(conf-if-lo-0)# exit
```

2. Configure the loopback interface as the VXLAN source tunnel interface.

```
OS10(config)# nve
OS10(config-nve)# source-interface loopback0
OS10(config-nve)# exit
```

3. Configure the VXLAN virtual network.

```
OS10(config)# virtual-network 10000
OS10(config-vn-10000)# vxlan-vni 10000
OS10(config-vn-vxlan-vni)# exit
OS10(config-vn)# exit
```

4. Assign VLAN member interfaces to the virtual network. Use a switch-scoped VLAN-to-VNI mapping.

```
OS10(config)# interface vlan100
OS10(config-if-vl-100)# virtual-network 10000
OS10(config-if-vl-100)# exit
```

5. Configure access ports as VLAN members.

```
OS10(config)# interface port-channel10
OS10(conf-if-po-10)# no shutdown
OS10(conf-if-po-10)# switchport mode trunk
OS10(conf-if-po-10)# switchport trunk allowed vlan 100
OS10(conf-if-po-10)# no switchport access vlan
OS10(conf-if-po-10)# exit
OS10(config)# interface ethernet1/1/5
OS10(conf-if-eth1/1/5)# no shutdown
OS10(conf-if-eth1/1/5)# channel-group 10 mode active
OS10(conf-if-eth1/1/5)# exit
```

6. Configure upstream network-facing ports as unnumbered interfaces. Configure the `ipv6 nd send-ra` command and lower RA intervals. These interfaces are used for BGP unnumbered peering.

```
OS10(config)# interface ethernet1/1/1
OS10(conf-if-eth1/1/1)# no shutdown
OS10(conf-if-eth1/1/1)# no switchport
OS10(conf-if-eth1/1/1)# mtu 1650
OS10(conf-if-eth1/1/1)# ipv6 nd max-ra-interval 4
OS10(conf-if-eth1/1/1)# ipv6 nd min-ra-interval 3
OS10(conf-if-eth1/1/1)# ipv6 nd send-ra
OS10(conf-if-eth1/1/1)# exit
OS10(config)# interface ethernet1/1/2
OS10(conf-if-eth1/1/2)# no shutdown
OS10(conf-if-eth1/1/2)# no switchport
OS10(conf-if-eth1/1/2)# mtu 1650
OS10(conf-if-eth1/1/2)# ipv6 nd max-ra-interval 4
OS10(conf-if-eth1/1/2)# ipv6 nd min-ra-interval 3
OS10(conf-if-eth1/1/2)# ipv6 nd send-ra
OS10(conf-if-eth1/1/2)# exit
```

7. Configure BGP instance with router id.

```
OS10(config)# router bgp 201
OS10(config-router-bgp-201)# router-id 172.17.0.1
OS10(config-router-bgp-201)# address-family ipv4 unicast
OS10(configure-router-bgp-af)# redistribute connected
OS10(configure-router-bgp-af)# exit
```

8. Configure a BGP unnumbered neighbor on network facing ports. Use a template to simplify the configuration on multiple interfaces. These neighbors are configured to carry IPv4 address family (default) and L2VPN EVPN address family.

```
OS10(config-router-bgp-201)# template ebgp_unified
OS10(config-router-template)# send-community extended
OS10(config-router-template)# address-family l2vpn evpn
OS10(config-router-bgp-template-af)# activate
OS10(config-router-bgp-template-af)# exit
OS10(config-router-template)# neighbor interface ethernet1/1/1
OS10(config-router-neighbor)# inherit template ebgp_unified inherit-type ebgp
OS10(config-router-neighbor)# no shutdown
OS10(config-router-neighbor)# exit
```

```
OS10(config-router-bgp-201)# neighbor interface ethernet1/1/2
OS10(config-router-neighbor)# inherit template ebgp_unified inherit-type ebgp
OS10(config-router-neighbor)# no shutdown
OS10(config-router-neighbor)# exit
```

- Configure EVPN for the VXLAN virtual network. Configure the EVPN instances using Auto EVI mode and Disable ASN in the generated RT.

```
OS10(config)# evpn
OS10(config-evpn)# auto-evi
OS10(config-evpn)# disable-rt-asn
OS10(config-evpn)# exit
```

**NOTE:** Use the `disable-rt-asn` command to autoderive RT that does not include the ASN in the RT value. This allows auto RT to be used even if the Clos leaf-spine design has separate ASN for each leaf node. Configure this command only when all the VTEPs are OS10 switches.

- Configure VLT.

- Configure a dedicated Layer 3 forwarding path through the other VLT peer for connectivity even if all spine links go down. This VLAN interface would be unnumbered interface and used for iBGP peering with the other VLT peer.

```
OS10(config)# interface vlan4000
OS10(config-if-vl-4000)# no shutdown
OS10(config-if-vl-4000)# ipv6 nd max-ra-interval 4
OS10(config-if-vl-4000)# ipv6 nd min-ra-interval 3
OS10(config-if-vl-4000)# ipv6 nd send-ra
OS10(config-if-vl-4000)# exit
```

- Configure the VLT port channel.

```
OS10(config)# interface port-channel10
OS10(config-if-po-10)# vlt-port-channel 10
OS10(config-if-po-10)# exit
```

- Configure VLTi member links.

```
OS10(config)# interface ethernet1/1/3
OS10(config-if-eth1/1/3)# no shutdown
OS10(config-if-eth1/1/3)# no switchport
OS10(config-if-eth1/1/3)# exit
OS10(config)# interface ethernet1/1/4
OS10(config-if-eth1/1/4)# no shutdown
OS10(config-if-eth1/1/4)# no switchport
OS10(config-if-eth1/1/4)# exit
```

- Configure the VLT domain.

```
OS10(config)# vlt-domain 1
OS10(config-vlt-1)# backup destination 10.16.150.2
OS10(config-vlt-1)# discovery-interface ethernet1/1/3,1/1/4
OS10(config-vlt-1)# vlt-mac aa:bb:cc:dd:ee:ff
OS10(config-vlt-1)# exit
```

- Configure UFD with uplink VLT ports and downlink network ports.

```
OS10(config)# uplink-state-group 1
OS10(config-uplink-state-group-1)# enable
OS10(config-uplink-state-group-1)# downstream ethernet1/1/1-1/1/2
OS10(config-uplink-state-group-1)# upstream port-channel10
OS10(config-uplink-state-group-1)# exit
```

- Configure iBGP unnumbered peering between VLT peers with both IPv4 and L2VPN EVPN address families.

```
OS10(config)# router bgp 201
OS10(config-router-bgp-201)# template ibgp_unified
OS10(config-router-template)# send-community extended
OS10(config-router-template)# address-family l2vpn evpn
OS10(config-router-bgp-template-af)# activate
OS10(config-router-bgp-template-af)# exit
OS10(config-router-template)# neighbor interface vlan4000
OS10(config-router-neighbor)# inherit template ibgp_unified inherit-type ibgp
```

```
OS10(config-router-neighbor)# no shutdown
OS10(config-router-neighbor)# exit
```

11. Configure IP routing in overlay network.

- Create a tenant VRF.

```
OS10(config)# ip vrf tenant1
OS10(conf-vrf)# exit
```

- Configure an anycast gateway MAC address.

```
OS10(config)# ip virtual-router mac-address 00:01:01:01:01:01
```

- Configure routing on the virtual network.

```
OS10(config)# interface virtual-network 10000
OS10(conf-if-vn-10000)# ip vrf forwarding tenant1
OS10(conf-if-vn-10000)# ip address 10.1.0.232/16
OS10(conf-if-vn-10000)# ip virtual-router address 10.1.0.100
OS10(conf-if-vn-10000)# no shutdown
OS10(conf-if-vn-10000)# exit
```

12. Configure symmetric IRB. In EVPN mode, configure the router MAC address that is used by remote VTEPs as the destination address in VXLAN encapsulated packets that are sent to the switch. Configure a dedicated VXLAN VNI for symmetric IRB for each tenant VRF.

```
OS10(config)# evpn
OS10(config-evpn)# router-mac 00:01:02:03:04:05
OS10(config-evpn)# vrf tenant1
OS10(config-evpn-tenant1)# vni 3000
OS10(config-evpn-tenant1)# route-target auto
OS10(config-evpn-tenant1)# exit
OS10(config-evpn)# exit
```

13. Configure advertisement of the connected networks through EVPN Type-5 routes.

```
OS10(config)# evpn
OS10(config-evpn)# vrf tenant1
OS10(config-evpn-tenant1)# advertise ipv4 connected
OS10(config-evpn-tenant1)# exit
```

### VTEP Leaf Switch 3 configuration

1. Configure a Loopback interface for the VXLAN underlay using same IP address as the VLT peer.

```
OS10(config)# interface loopback0
OS10(conf-if-lo-0)# no shutdown
OS10(conf-if-lo-0)# ip address 192.168.2.1/32
OS10(conf-if-lo-0)# exit
```

2. Configure the loopback interface as the VXLAN source tunnel interface.

```
OS10(config)# nve
OS10(config-nve)# source-interface loopback0
OS10(config-nve)# exit
```

3. Configure the VXLAN virtual network.

```
OS10(config)# virtual-network 20000
OS10(config-vn-20000)# vxlan-vni 20000
OS10(config-vn-vxlan-vni)# exit
OS10(config-vn-20000)# exit
```

4. Configure an unused VLAN ID for untagged membership.

```
OS10(config)# virtual-network untagged-vlan 1000
```

5. Configure access ports as VLAN members for a port-scoped VLAN-to-VNI mapping.

```
OS10(config)# interface port-channel20
OS10(conf-if-po-20)# no shutdown
```

```

OS10(config-if-po-20)# switchport mode trunk
OS10(config-if-po-20)# no switchport access vlan
OS10(config-if-po-20)# exit
OS10(config)# interface ethernet1/1/6
OS10(config-if-eth1/1/6)# no shutdown
OS10(config-if-eth1/1/6)# channel-group 20 mode active
OS10(config-if-eth1/1/6)# exit

```

6. Add the access ports to the virtual network.

```

OS10(config)# virtual-network 20000
OS10(config-vn-20000)# member-interface port-channel 20 untagged
OS10(config-vn-20000)# exit

```

7. Configure upstream network-facing ports as unnumbered interfaces. Configure the `ipv6 nd send-ra` command and lower RA intervals. These interfaces would be used for BGP unnumbered peering.

```

OS10(config)# interface ethernet1/1/1
OS10(config-if-eth1/1/1)# no shutdown
OS10(config-if-eth1/1/1)# no switchport
OS10(config-if-eth1/1/1)# mtu 1650
OS10(config-if-eth1/1/1)# ipv6 nd max-ra-interval 4
OS10(config-if-eth1/1/1)# ipv6 nd min-ra-interval 3
OS10(config-if-eth1/1/1)# ipv6 nd send-ra
OS10(config-if-eth1/1/1)# exit
OS10(config)# interface ethernet1/1/2
OS10(config-if-eth1/1/2)# no shutdown
OS10(config-if-eth1/1/2)# no switchport
OS10(config-if-eth1/1/2)# mtu 1650
OS10(config-if-eth1/1/2)# ipv6 nd max-ra-interval 4
OS10(config-if-eth1/1/2)# ipv6 nd min-ra-interval 3
OS10(config-if-eth1/1/2)# ipv6 nd send-ra
OS10(config-if-eth1/1/2)# exit

```

8. Configure BGP instance with router id.

```

OS10(config)# router bgp 202
OS10(config-router-bgp-202)# router-id 172.18.0.1
OS10(config-router-bgp-202)# address-family ipv4 unicast
OS10(config-router-bgp-af)# redistribute connected
OS10(config-router-bgp-af)# exit

```

9. Configure BGP unnumbered neighbor over network facing ports. You can use a template to simplify the configuration on multiple interfaces. These neighbors are configured to carry IPv4 address family (default) and L2VPN EVPN address family.

```

OS10(config-router-bgp-202)# template ebgp_unified
OS10(config-router-template)# send-community extended
OS10(config-router-template)# address-family l2vpn evpn
OS10(config-router-bgp-template-af)# activate
OS10(config-router-bgp-template-af)# exit
OS10(config-router-template)# neighbor interface ethernet1/1/1
OS10(config-router-neighbor)# inherit template ebgp_unified inherit-type ebgp
OS10(config-router-neighbor)# no shutdown
OS10(config-router-neighbor)# exit
OS10(config-router-bgp-202)# neighbor interface ethernet1/1/2
OS10(config-router-neighbor)# inherit template ebgp_unified inherit-type ebgp
OS10(config-router-neighbor)# no shutdown
OS10(config-router-neighbor)# exit

```

10. Configure EVPN for the VXLAN virtual network. Configure the EVPN instance in manual configuration mode, and RD and RT configuration in auto mode.

```

OS10(config)# evpn
OS10(config-evpn)# disable-rt-asn
OS10(config-evpn)# evi 20000
OS10(config-evpn-evi-20000)# vni 20000
OS10(config-evpn-evi-20000)# rd auto
OS10(config-evpn-evi-20000)# route-target auto
OS10(config-evpn-evi-20000)# exit
OS10(config-evpn)# exit

```



**NOTE:** Use the `disable-rt-asn` command to autoderive RT that does not include the ASN in the RT value. This allows auto RT to be used even if the Clos leaf-spine design has separate ASN for each leaf node. Configure this command only when all the VTEPs are OS10 switches.

## 11. Configure VLT.

- Configure a VLTi VLAN for the virtual network.

```
OS10(config)# virtual-network 20000
OS10(config-vn-20000)# vlti-vlan 200
OS10(config-vn-20000)# exit
```

- Configure a dedicated Layer 3 forwarding path through the other VLT peer for connectivity even if all spine links go down. This VLAN interface is an unnumbered interface and used for iBGP peering with the other VLT peer.

```
OS10(config)# interface vlan4000
OS10(config-if-vl-4000)# no shutdown
OS10(config-if-vl-4000)# ipv6 nd max-ra-interval 4
OS10(config-if-vl-4000)# ipv6 nd min-ra-interval 3
OS10(config-if-vl-4000)# ipv6 nd send-ra
OS10(config-if-vl-4000)# exit
```

- Configure the VLT port channel.

```
OS10(config)# interface port-channel20
OS10(config-if-po-20)# vlt-port-channel 20
OS10(config-if-po-20)# exit
```

- Configure VLTi member links.

```
OS10(config)# interface ethernet1/1/3
OS10(config-if-eth1/1/3)# no shutdown
OS10(config-if-eth1/1/3)# no switchport
OS10(config-if-eth1/1/3)# exit
OS10(config)# interface ethernet1/1/4
OS10(config-if-eth1/1/4)# no shutdown
OS10(config-if-eth1/1/4)# no switchport
OS10(config-if-eth1/1/4)# exit
```

- Configure the VLT domain.

```
OS10(config)# vlt-domain 1
OS10(config-vlt-1)# backup destination 10.16.150.3
OS10(config-vlt-1)# discovery-interface ethernet1/1/3,1/1/4
OS10(config-vlt-1)# vlt-mac aa:bb:cc:dd:ff:ee
OS10(config-vlt-1)# exit
```

- Configure UFD with uplink VLT ports and downlink network ports.

```
OS10(config)# uplink-state-group 1
OS10(config-uplink-state-group-1)# enable
OS10(config-uplink-state-group-1)# downstream ethernet1/1/1-1/1/2
OS10(config-uplink-state-group-1)# upstream port-channel20
OS10(config-uplink-state-group-1)# exit
```

- Configure iBGP unnumbered peering between VLT peers with both IPv4 and L2VPN EVPN address families.

```
OS10(config)# router bgp 202
OS10(config-router-bgp-202)# template ibgp_unified
OS10(config-router-template)# send-community extended
OS10(config-router-template)# address-family l2vpn evpn
OS10(config-router-bgp-template-af)# activate
OS10(config-router-bgp-template-af)# exit
OS10(config-router-template)# neighbor interface vlan4000
OS10(config-router-neighbor)# inherit template ibgp_unified inherit-type ibgp
OS10(config-router-neighbor)# no shutdown
OS10(config-router-neighbor)# exit
```

## 12. Configure IP routing in the overlay network.

- Create the tenant VRF.

```
OS10(config)# ip vrf tenant1
OS10(conf-vrf)# exit
```

- Configure an anycast gateway MAC address.

```
OS10(config)# ip virtual-router mac-address 00:01:01:01:01:01
```

- Configure routing on the virtual network.

```
OS10(config)# interface virtual-network 20000
OS10(conf-if-vn-20000)# ip vrf forwarding tenant1
OS10(conf-if-vn-20000)# ip address 10.2.0.233/16
OS10(conf-if-vn-20000)# ip virtual-router address 10.2.0.100
OS10(conf-if-vn-20000)# no shutdown
OS10(conf-if-vn-20000)# exit
```

13. Configure symmetric IRB. In EVPN mode, configure the router MAC address that is used by remote VTEPs as the destination address in VXLAN encapsulated packets that are sent to the switch. Configure a dedicated VXLAN VNI for symmetric IRB for each tenant VRF.

```
OS10(config)# evpn
OS10(config-evpn)# router-mac 00:01:02:03:04:06
OS10(config-evpn)# vrf tenant1
OS10(config-evpn-vrf-tenant1)# vni 3000
OS10(config-evpn-vrf-tenant1)# route-target auto
OS10(config-evpn-vrf-tenant1)# exit
OS10(config-evpn)# exit
```

14. Configure an externally connected VLAN.

```
OS10(conf)# interface vlan 200
OS10(conf-if-vlan)# ip vrf forwarding tenant1
OS10(conf-if-vlan)# ip address 10.10.0.1/16
OS10(conf-if-vlan)# no shutdown
OS10(conf-if-vlan)# exit
OS10(conf)# interface ethernet 1/1/7
OS10(conf-if-eth1/1/7)# switchport mode trunk
OS10(conf-if-eth1/1/7)# switchport trunk allowed vlan 200
```

15. Configure advertisement of the connected networks through EVPN Type-5 routes.

```
OS10(config)# evpn
OS10(config-evpn)# vrf tenant1
OS10(config-evpn-vrf-tenant1)# advertise ipv4 connected
OS10(config-evpn-vrf-tenant1)# exit
```

### VTEP Leaf Switch 4 configuration

1. Configure a loopback interface for the VXLAN underlay using the same IP address as the VLT peer.

```
OS10(config)# interface loopback0
OS10(conf-if-lo-0)# no shutdown
OS10(conf-if-lo-0)# ip address 192.168.2.1/32
OS10(conf-if-lo-0)# exit
```

2. Configure the Loopback interface as the VXLAN source tunnel interface.

```
OS10(config)# nve
OS10(config-nve)# source-interface loopback0
OS10(config-nve)# exit
```

3. Configure the VXLAN virtual network.

```
OS10(config)# virtual-network 20000
OS10(config-vn-20000)# vxlan-vni 20000
OS10(config-vn-vxlan-vni)# exit
OS10(config-vn-20000)# exit
```

4. Configure an unused VLAN ID for untagged membership.

```
OS10(config)# virtual-network untagged-vlan 1000
```

5. Configure access ports as VLAN members for a port-scoped VLAN-to-VNI mapping.

```
OS10(config)# interface port-channel20
OS10(config-if-po-20)# no shutdown
OS10(config-if-po-20)# switchport mode trunk
OS10(config-if-po-20)# no switchport access vlan
OS10(config-if-po-20)# exit
OS10(config)# interface ethernet1/1/6
OS10(config-if-eth1/1/6)# no shutdown
OS10(config-if-eth1/1/6)# channel-group 20 mode active
OS10(config-if-eth1/1/6)# exit
```

6. Add the access ports to the virtual network.

```
OS10(config)# virtual-network 20000
OS10(config-vn-20000)# member-interface port-channel 20 untagged
OS10(config-vn)# exit
```

7. Configure upstream network-facing ports as unnumbered interfaces. Configure the `ipv6 nd send-ra` command and lower RA intervals. These interfaces would be used for BGP unnumbered peering.

```
OS10(config)# interface ethernet1/1/1
OS10(config-if-eth1/1/1)# no shutdown
OS10(config-if-eth1/1/1)# no switchport
OS10(config-if-eth1/1/1)# mtu 1650
OS10(config-if-eth1/1/1)# ipv6 nd max-ra-interval 4
OS10(config-if-eth1/1/1)# ipv6 nd min-ra-interval 3
OS10(config-if-eth1/1/1)# ipv6 nd send-ra
OS10(config-if-eth1/1/1)# exit
OS10(config)# interface ethernet1/1/2
OS10(config-if-eth1/1/2)# no shutdown
OS10(config-if-eth1/1/2)# no switchport
OS10(config-if-eth1/1/2)# mtu 1650
OS10(config-if-eth1/1/2)# ipv6 nd max-ra-interval 4
OS10(config-if-eth1/1/2)# ipv6 nd min-ra-interval 3
OS10(config-if-eth1/1/2)# ipv6 nd send-ra
OS10(config-if-eth1/1/2)# exit
```

8. Configure BGP instance with router id.

```
OS10(config)# router bgp 202
OS10(config-router-bgp-202)# router-id 172.19.0.1
OS10(config-router-bgp-202)# address-family ipv4 unicast
OS10(configure-router-bgp-af)# redistribute connected
OS10(configure-router-bgp-af)# exit
```

9. Configure a BGP unnumbered neighbor over network facing ports. Use a template to simplify the configuration on multiple interfaces. These neighbors are configured to carry IPv4 address family (default) and L2VPN EVPN address family.

```
OS10(config-router-bgp-202)# template ebgp_unified
OS10(config-router-template)# send-community extended
OS10(config-router-template)# address-family l2vpn evpn
OS10(config-router-bgp-template-af)# activate
OS10(config-router-bgp-template-af)# exit
OS10(config-router-template)# neighbor interface ethernet1/1/1
OS10(config-router-neighbor)# inherit template ebgp_unified inherit-type ebgp
OS10(config-router-neighbor)# no shutdown
OS10(config-router-neighbor)# exit
OS10(config-router-bgp-202)# neighbor interface ethernet1/1/2
OS10(config-router-neighbor)# inherit template ebgp_unified inherit-type ebgp
OS10(config-router-neighbor)# no shutdown
OS10(config-router-neighbor)# exit
```

10. Configure EVPN for the VXLAN virtual network. Configure the EVPN instance manual configuration mode, and RD, and RT configuration in auto mode.

```
OS10(config)# evpn
OS10(config-evpn)# disable-rt-asn
```

```
OS10(config-evpn)# evi 20000
OS10(config-evpn-evi-20000)# vni 20000
OS10(config-evpn-evi-20000)# rd auto
OS10(config-evpn-evi-20000)# route-target auto
OS10(config-evpn-evi-20000)# exit
OS10(config-evpn)# exit
```

**i** **NOTE:** Use the `disable-rt-asn` command to autoderive RT that does not include the ASN in the RT value. This allows auto RT to be used even if the Clos leaf-spine design has separate ASN for each leaf node. Configure this command only when all the VTEPs are OS10 switches.

## 11. Configure VLT.

- Configure a VLTi VLAN for the virtual network.

```
OS10(config)# virtual-network 20000
OS10(conf-vn-20000)# vlti-vlan 200
OS10(conf-vn-20000)# exit
```

- Configure a dedicated Layer 3 forwarding path through the other VLT peer if all spine links go down. This VLAN interface is unnumbered interface and is used for iBGP peering with the other VLT peer.

```
OS10(config)# interface vlan4000
OS10(config-if-vl-4000)# no shutdown
OS10(config-if-vl-4000)# ipv6 nd max-ra-interval 4
OS10(config-if-vl-4000)# ipv6 nd min-ra-interval 3
OS10(config-if-vl-4000)# ipv6 nd send-ra
OS10(config-if-vl-4000)# exit
```

- Configure the VLT port channel.

```
OS10(config)# interface port-channel20
OS10(conf-if-po-20)# vlt-port-channel 20
OS10(conf-if-po-20)# exit
```

- Configure VLTi member links.

```
OS10(config)# interface ethernet1/1/3
OS10(conf-if-eth1/1/3)# no shutdown
OS10(conf-if-eth1/1/3)# no switchport
OS10(conf-if-eth1/1/3)# exit
OS10(config)# interface ethernet1/1/4
OS10(conf-if-eth1/1/4)# no shutdown
OS10(conf-if-eth1/1/4)# no switchport
OS10(conf-if-eth1/1/4)# exit
```

- Configure the VLT domain.

```
OS10(config)# vlt-domain 1
OS10(conf-vlt-1)# backup destination 10.16.150.4
OS10(conf-vlt-1)# discovery-interface ethernet1/1/3,1/1/4
OS10(conf-vlt-1)# vlt-mac aa:bb:cc:dd:ff:ee
OS10(conf-vlt-1)# exit
```

- Configure UFD with uplink VLT ports and downlink network ports.

```
OS10(config)# uplink-state-group 1
OS10(conf-uplink-state-group-1)# enable
OS10(conf-uplink-state-group-1)# downstream ethernet1/1/1-1/1/2
OS10(conf-uplink-state-group-1)# upstream port-channel20
OS10(conf-uplink-state-group-1)# exit
```

- Configure iBGP unnumbered peering between VLT peers with both IPv4 and L2VPN EVPN address families.

```
OS10(config)# router bgp 202
OS10(config-router-bgp-202)# template ibgp_unified
OS10(config-router-template)# send-community extended
OS10(config-router-template)# address-family l2vpn evpn
OS10(config-router-bgp-template-af)# activate
OS10(config-router-bgp-template-af)# exit
OS10(config-router-template)# neighbor interface vlan4000
OS10(config-router-neighbor)# inherit template ibgp_unified inherit-type ibgp
```

```
OS10(config-router-neighbor)# no shutdown
OS10(config-router-neighbor)# exit
```

12. Configure IP routing in the overlay network.

- Create a tenant VRF.

```
OS10(config)# ip vrf tenant1
OS10(conf-vrf)# exit
```

- Configure an anycast gateway MAC address.

```
OS10(config)# ip virtual-router mac-address 00:01:01:01:01:01
```

- Configure routing on the virtual network.

```
OS10(config)# interface virtual-network 20000
OS10(conf-if-vn-20000)# ip vrf forwarding tenant1
OS10(conf-if-vn-20000)# ip address 10.2.0.234/16
OS10(conf-if-vn-20000)# ip virtual-router address 10.2.0.100
OS10(conf-if-vn-20000)# no shutdown
OS10(conf-if-vn-20000)# exit
```

13. Configure symmetric IRB. In EVPN mode, configure the router MAC address that is used by remote VTEPs as the destination address in VXLAN encapsulated packets that are sent to the switch. Configure a dedicated VXLAN VNI for symmetric IRB for each tenant VRF.

```
OS10(config)# evpn
OS10(config-evpn)# router-mac 00:01:02:03:04:06
OS10(config-evpn)# vrf tenant1
OS10(config-evpn-vrf-tenant1)# vni 3000
OS10(config-evpn-vrf-tenant1)# route-target auto
OS10(config-evpn-vrf-tenant1)# exit
OS10(config-evpn)# exit
```

14. Configure an externally connected VLAN.

```
OS10(conf)# interface vlan 200
OS10(conf-if-vlan)# ip vrf forwarding tenant1
OS10(conf-if-vlan)# ip address 10.10.0.2/16
OS10(conf-if-vlan)# no shutdown
OS10(conf-if-vlan)# exit
OS10(conf)# interface ethernet 1/1/7
OS10(conf-if-eth1/1/7)# switchport mode trunk
OS10(conf-if-eth1/1/7)# switchport trunk allowed vlan 200
```

15. Configure advertisement of the connected networks through EVPN Type-5 routes.

```
OS10(config)# evpn
OS10(config-evpn)# vrf tenant1
OS10(config-evpn-vrf-tenant1)# advertise ipv4 connected
OS10(config-evpn-vrf-tenant1)# exit
```

## Example: Migrating from Asymmetric IRB to Symmetric IRB

Until Release 10.5.0, OS10 provided support only for the Asymmetric IRB mode. Starting from Release 10.5.1, OS10 supports the Symmetric IRB mode. Symmetric IRB mode efficiently uses next hop tables in the NPU. If there are no local hosts, Symmetric IRB mode does not require creation of destination VNI in the local VTEP. You can migrate your network from Asymmetric IRB mode to Symmetric IRB mode. For a seamless migration with less or no downtime in the VLT environment, perform the following steps:

**NOTE:**

- Before you start this migration, all leaf nodes acting as VTEPs in the Clos network must be upgraded to 10.5.1.x.
- If there are overlay hosts in default VRF, migration to Symmetric IRB mode is not supported because Symmetric IRB mode cannot be used in default VRF.

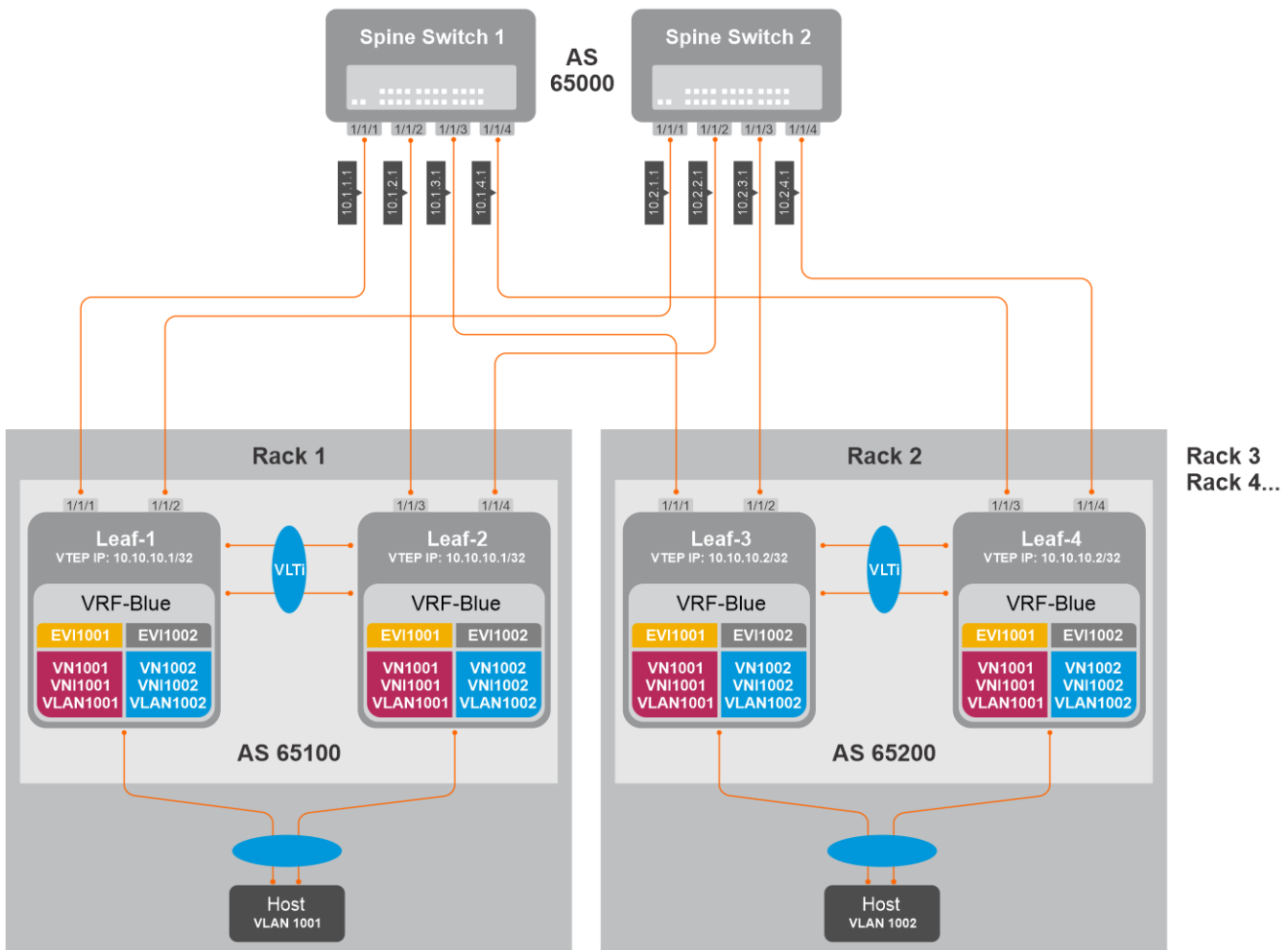

## Asymmetric to Symmetric IRB migration steps

1. **Make the spines to send overlay traffic only to Leaf-2 by making Leaf-1 advertise VTEP IP with a higher metric in the underlay network.**

### Leaf-1 configuration

- a. Configure route-map with prefix-list to set the metric higher for the VTEP IP.

```
Leaf-1(config)# ip prefix-list vtep_ip seq 10 permit 10.10.10.1/32
Leaf-1(config)# route-map set_higher_metric permit 10
Leaf-1(config-route-map)# match ip address prefix-list vtep_ip
Leaf-1(config-route-map)# continue 20
Leaf-1(config-route-map)# set metric 100
Leaf-1(config-route-map)# exit
Leaf-1(config)# route-map set_higher_metric permit 20
Leaf-1(config-route-map)# exit
```

- b. Configure the route-map to the underlay BGP neighbors towards Spine.

```
Leaf-1(config)# router bgp 65100
Leaf-1(config-router-bgp-65100)# neighbor 10.1.1.1
Leaf-1(config-router-neighbor)# address-family ipv4 unicast
Leaf-1(config-router-bgp-neighbor-af)# route-map set_higher_metric out
Leaf-1(config-router-bgp-neighbor-af)# exit
Leaf-1(config-router-neighbor)# exit
Leaf-1(config-router-bgp-65100)# neighbor 10.2.1.1
Leaf-1(config-router-neighbor)# address-family ipv4 unicast
Leaf-1(config-router-bgp-neighbor-af)# route-map set_higher_metric out
Leaf-1(config-router-bgp-neighbor-af)# end
```

2. Spines would now send the overlay traffic destined to VLT domain 1 (Rack1) only to Leaf-2.
3. Configure Symmetric IRB mode in Leaf-2.

#### Leaf-2 configuration

- a. Configure router-mac.

```
Leaf-2(config)# evpn
Leaf-2(config-evpn)# router-mac 02:10:10:10:10:10
```

- b. Configure IP VRF with L3 VNI.

```
Leaf-2(config-evpn)# vrf BLUE
Leaf-2(config-evpn-vrf-VRF001)# vni 65001
```

- c. Configure RT (auto or manual) and RD (optional, default is auto).

```
Leaf-2(config-evpn-vrf-BLUE)# route-target auto
```

- d. Advertise IPv4 and IPv6 connected routes.

```
Leaf-2(config-evpn-vrf-BLUE)# advertise ipv4 connected
Leaf-2(config-evpn-vrf-BLUE)# advertise ipv6 connected
```

4. Leaf-2 is changed to Symmetric IRB mode. VTEPs in other racks could be using Symmetric IRB or Asymmetric IRB based on its own local configuration. Irrespective of what other remote VTEPs use, Leaf-2 could now handle VXLAN encapsulated traffic from both symmetric and asymmetric modes.
5. Configure Symmetric IRB in Leaf-1.

#### Leaf-1 configuration

- a. Configure router-mac.

```
Leaf-1(config)# evpn
Leaf-1(config-evpn)# router-mac 02:10:10:10:10:10
```

- b. Configure IP VRF with L3 VNI.

```
Leaf-1(config-evpn)# vrf BLUE
Leaf-1(config-evpn-vrf-VRF001)# vni 65001
```

- c. Configure RT (auto or manual) and RD (optional, default is auto).

```
Leaf-1(config-evpn-vrf-BLUE)# route-target auto
```

- d. Advertise IPv4 and IPv6 connected routes.

```
Leaf-1(config-evpn-vrf-BLUE)# advertise ipv4 connected
Leaf-1(config-evpn-vrf-BLUE)# advertise ipv6 connected
```

6. Remove the BGP MED configuration in Leaf-1. Spines start sending traffic to Leaf-1 as well. ECMP path from Spines towards Leaf-1 and Leaf-2 is restored.

#### Leaf-1 configuration

```
Leaf-1(config)# router bgp 65100
Leaf-1(config-router-bgp-65100)# neighbor 10.1.1.1
Leaf-1(config-router-neighbor)# address-family ipv4 unicast
Leaf-1(config-router-bgp-neighbor-af)# no route-map set_higher_metric out
Leaf-1(config-router-bgp-neighbor-af)# exit
Leaf-1(config-router-neighbor)# exit
Leaf-1(config-router-bgp-65100)# neighbor 10.2.1.1
Leaf-1(config-router-neighbor)# address-family ipv4 unicast
Leaf-1(config-router-bgp-neighbor-af)# no route-map set_higher_metric out
Leaf-1(config-router-bgp-neighbor-af)# end
```

7. Rack1 is migrated to use Symmetric IRB.
8. Repeat Steps 1-to-6 on Rack2 and other racks as well.
9. After changing all Racks to Symmetric IRB, you can perform the following optional configuration changes:
  - a. If the L2 VNI (MAC-VRF VNI) does not have local hosts in the VTEPs, you can remove those VNIs on those VTEPs.

- b. Default route configured in VTEPs pointing to border leaf using an intermediate VNI could be removed. Default route or external routes could now be advertised to the VTEPs from border leaf using `advertise` commands under `EVPN-IP-VRF` mode.

## Controller-provisioned VXLAN

OS10 supports VXLAN provisioning using an Open vSwitch Database (OVSDB) controller. Currently, the only supported OVSDB controller is the VMware NSX controller. In a controller-provisioned VXLAN, the controller manages VXLAN-related configurations and other control-plane operations, such as MAC address propagation.

**NOTE:** Controller-provisioned VXLAN is not supported on S3048-ON switches. Also, controller-provisioned VXLAN is not supported on VTEPs configured as peers in a VLT domain. Only VTEPs in standalone mode are supported.

### Controller-provisioned VXLAN

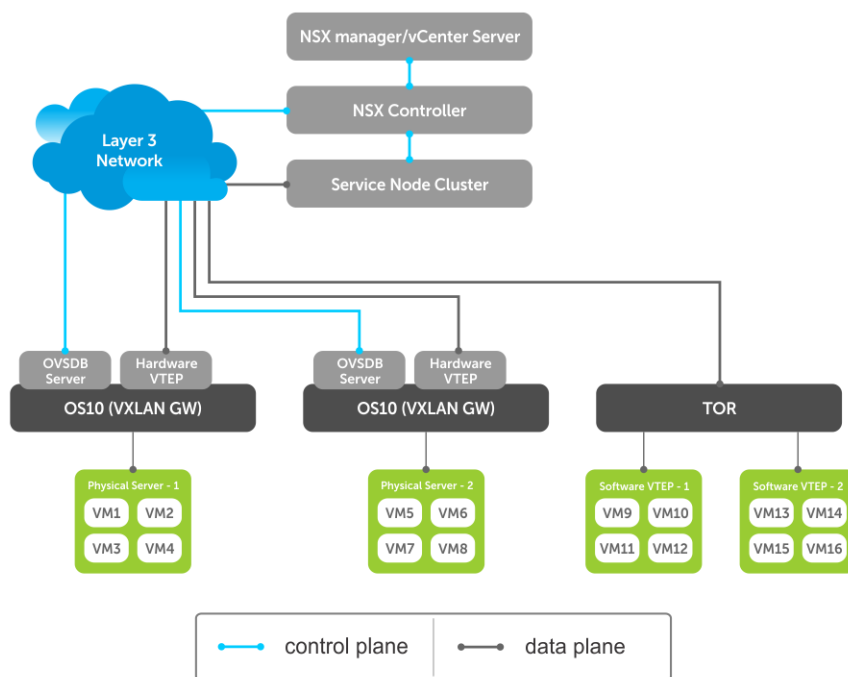

The NSX controller communicates with an OS10 VTEP using the OVSDB management protocol over a Secure Sockets Layer (SSL) connection. Establishing the communication between the controller and VTEP involves generating the SSL certificate at a VTEP and copying the certificate to the NSX controller. After SSL authentication, a secure connection over SSL is established between the controller and the VTEP. The VTEP then receives and processes the configuration data from the controller.

### Controller-provisioned VXLAN: Manual configuration

You must manually configure the underlay network using the OS10 CLI:

- Configure the L3 protocol used for underlay routing. Underlay reachability to VTEP peers is learned using the configured routing protocol.
- Configure the loopback interface in the default VRF that is used as the VTEP source IP address for controller-based provisioning.
- Assign the VTEP interfaces to be managed by the controller.

### Controller-provisioned VXLAN: Automatic provisioning

The controller automatically provisions:

- L2 overlay network
- VXLAN virtual networks, including remote VTEP source addresses
- Local access ports in a virtual network

An OS10 VTEP sends the addition or deletion of server MAC addresses at the VXLAN access port to the NSX controller using the OVSDB protocol. The controller then propagates the information to VTEP peers. The VTEPs program their forwarding tables accordingly.



# Configure controller-provisioned VXLAN

To configure the NSX controller, follow these steps on each OS10 VTEP:

1. Configure the source interface used for controller-based VXLAN provisioning. Assign an IPv4 address to a loopback interface. Assign the loopback interface to an NVE instance. The loopback interface must belong to the default VRF. For detailed information, see the [Configure source IP address on VTEP](#).
2. Configure NSX controller reachability.
3. Assign local access interfaces to be managed by the controller. The VLAN IDs of member access interfaces created using the OS10 CLI must be different from the VLAN IDs of port-scoped VLANs created by the NSX controller for virtual networks.
4. (Optional) Enable BFD in the NSX and the VTEP. OS10 complies with RFC5880 for Bidirectional Forwarding Detection.

## Configuration notes

- NSX controller-provisioned VXLAN is not supported if an OS10 switch operates in OpenFlow-only mode.
- Only one mode of VxLAN provisioning is supported at a time: NSX controller-based, static VXLAN, or BGP EVPN.
- An OS10 switch does not send VXLAN access port statistics to the NSX controller.
- Controller-provisioned VXLAN is not supported on VTEPs configured as peers in a VLT domain. Only VTEPs in standalone mode are supported.

## Specify the controller reachability information

In OS10 VTEP, the controller configuration command initializes a connection to an OVSDDB-based controller.

OS10 supports only one controller connection at a time.

 **NOTE:** Currently, the only supported OVSDDB-based controller is NSX.

To configure an OVSDDB controller on the OS10 VTEP:

1. Enable VXLAN in CONFIGURATION mode.  
`OS10(config)# nve`
2. Changes the mode to CONFIGURATION-NVE-OVSDDB from where you can configure the controller parameters.  
`OS10(config-nve)# controller ovldb`
3. Specify the IP address, OVSDDB controller port, and SSL as a secure connection protocol between the OS10 VTEP and the controller in CONFIGURATION-NVE-OVSDDB mode.  
`OS10(config-nve-ovldb)# ip ip-address port port-number ssl`  
The range of *port-number* is from 0 to 65535. Configure the port-number as 6640 and the connection type as SSL.
4. (Optional) Specify a time interval, in milliseconds (ms). This is the duration the switch waits between the connection attempts to the controller.  
`OS10(config-nve-ovldb)# max-backoff interval`  
The range is from 1000 to 180,000 ms. The default is 8000 ms.

```
OS10# configure terminal
OS10(config)# nve
OS10(config-nve)# controller ovldb
OS10(config-nve-ovldb)# ip 10.11.66.110 port 6640 ssl
```

## Assign interfaces to be managed by the controller

In a VTEP, explicitly assign interfaces for an OVSDDB controller to manage.

Before you assign the interface, consider the following:

- The interface must be in Switchport Trunk mode.
- The interface must not be a member of any VLAN
- The interface must not be a member of a port-channel

When the above conditions are not met when assigning the interfaces to be managed by the controller, the system returns error messages.

When the interface is assigned, you cannot:

- remove the interface from Switchport Trunk mode
- add the interface as a member of any VLAN
- remove the interface from the controller configuration if the interface has active port-scoped VLAN (Port,VLAN) pairs configured by the controller

To assign an interface to be managed by the OVSDB controller:

1. Configure an interface from CONFIGURATION mode.  
`OS10(config)# interface ethernet 1/1/1`
2. Configure L2 trunking in INTERFACE mode.  
`OS10(config-if-eth1/1/1)# switchport mode trunk`
3. Configure the access VLAN assigned to a L2 trunk port in the INTERFACE mode.  
`OS10(config-if-eth1/1/1)# no switchport access vlan`
4. Assign the interface to the controller.  
`OS10(config-if-eth1/1/1)# nve-controller`

To view the controller information and the ports the controller manages, use the `show nve controller` command.

```
OS10# show nve controller

Management IP : 10.16.140.29/16
Gateway IP : 55.55.5.5
Max Backoff : 1000
Configured Controller : 10.16.140.172:6640 ssl (connected)

Controller Cluster
IP Port Protocol Connected State Max-Backoff
10.16.140.173 6640 ssl true ACTIVE 1000
10.16.140.171 6640 ssl false BACKOFF 1000
10.16.140.172 6640 ssl true ACTIVE 1000

NVE Controller Ports
ethernet1/1/1:1
ethernet1/1/15
```

## Service Nodes

In an NSX-provisioned VXLAN environment, service nodes replicate L2 broadcast, unknown-unicast, and multicast (BUM) traffic that enter an OS10 VTEP to all other VTEPs. For the service node replication of BUM traffic to work, you need IP connectivity between the service nodes and the VTEP, so that the BUM traffic from a VTEP reaches the other remote VTEPs via a VXLAN overlay through the service nodes. The NSX controller manages a cluster of service nodes and sends the IP addresses of the nodes to the VTEP through OVSDB protocol. The service node cluster provides redundancy, and also facilitates load balancing of BUM traffic across service nodes.

The following shows BUM traffic replication in the controller-provisioned VXLAN environment:

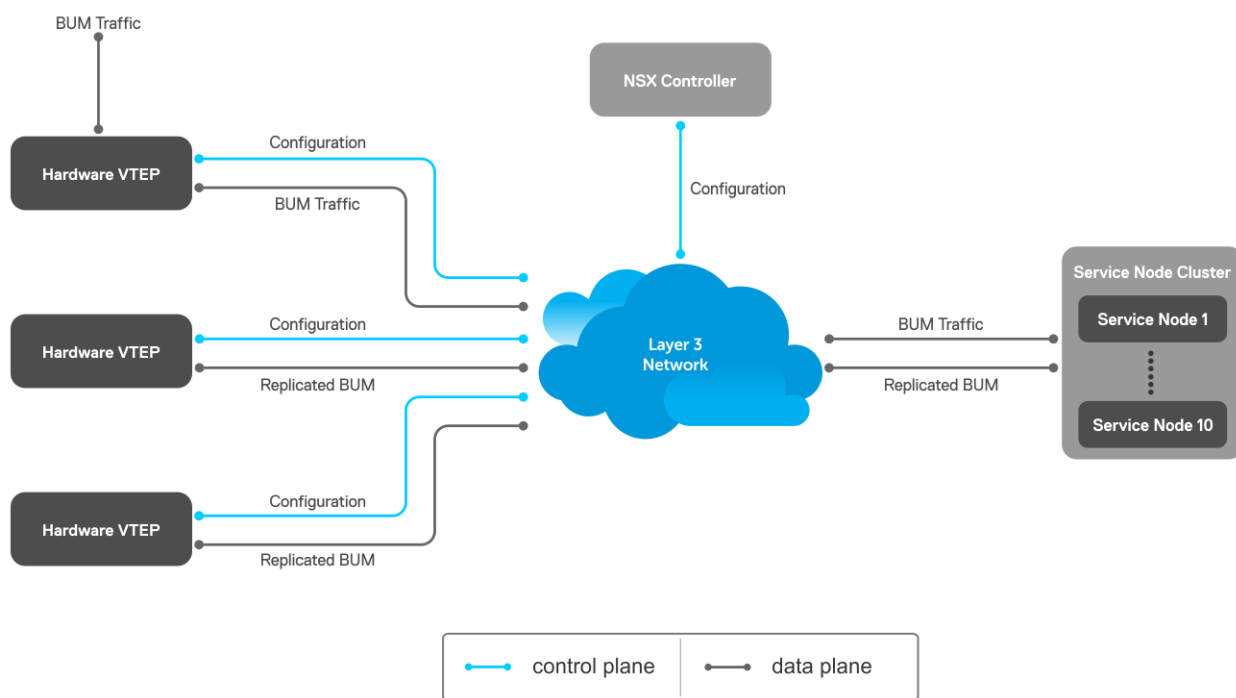

Since VTEP relies on service nodes to replicate BUM traffic, we need a mechanism to monitor the connectivity between the VTEP and the service nodes. BFD can be used to monitor the connectivity between the VTEP and service nodes, and detects failures. The NSX controller provides parameters, such as the minimum TX and RX interval, and the multiplier, to initiate the BFD session between the VTEP and the service nodes. To establish a BFD session, enable the BFD on the controller and the VTEP. To enable BFD in the VTEP, use `bfd enable` command.

**NOTE:** In controller-provisioned VXLAN, the VTEP establishes a BFD session with the service nodes using the controller-provided parameters instead of the parameters configured at the VTEP.

If BFD is not enabled in the VTEP, the VTEP uses IP reachability information to monitor connectivity to the service node.

To view established sessions, use the `show bfd neighbors` command.

```
OS10# show bfd neighbors
* - Active session role

-
 LocalAddr RemoteAddr Interface State RxInt TxInt Mult VRF Clients

-
* 55.55.5.5 2.2.2.2 virtual-network0 up 1000 1000 3 default vxlan
* 55.55.5.5 2.2.2.3 virtual-network0 up 1000 1000 3 default vxlan
```

## View replicators

To view the state of the replicators, use the `show nve replicators` command.

- Show output with details about the replicators received from the controller.

```
OS10# show nve replicators
Codes: * - Active Replicator

BFD Status:Enabled
Replicators State

2.2.2.3 Up
2.2.2.2 Up
```

- Show output with details about the replicators available for the VNID.

```
OS10# show nve replicators vnid 10009
Codes: * - Active Replicator

BFD Status:Enabled
Replicators State

2.2.2.3 Up
2.2.2.2* Up
```

\*— indicates the replicator to which the VTEP sends the BUM traffic for the specific VNID.

## Configure and control VXLAN from VMware vCenter

You can configure and control VXLAN from the VMware vCenter GUI. Complete the following steps:

1. On an OS10 switch, generate an SSL certificate in CONFIGURATION mode.

```
OS10# nve controller ssl-key-generate
```

Verify or view the certificate using the `show nve controller ssl-certificate` command.

```
OS10# show nve controller ssl-certificate
-----BEGIN CERTIFICATE-----
MIIDgDCCAmgCAQMwDQYJKoZIhvcNAQENBQAwgYExCzAJBgNVBAYTAlVTMQswCQYD
VQQIDAJDQTEVMBMGA1UECgwMT3BlbiB2U3dpdGNoMREwDwYDVQQLEDAhZd210Y2hj
YTE7MDkGA1UEAwwyT1ZTIHN3aXRjaGNoIENBIENlcnRpZmljYXRlICgyMDE4IFNl
cCAyMyAwMzo0NzoyMCKwHhcNMjgwOTI0MTYzMDUyWhcNMjgwOTI0MTYzMDUyWjCB
iTElMAkGA1UEBhMCVVMxCzAJBgNVBAGMAkNBMRUwEwYDVQQKDAxPcGVuIHZTd210
Y2gqHhZAdBgNVBASMFk9wZw4gd1N3aXRjaCBjZXJ0aWZpZXIwZWZpZXIwZWZpZXIw
bGwgaWQ6MGVlZmUwYWMtNGJjOC00MmVmLTkzOTEtN2RlMmMwY2JmMTJjMIIBIjAN
BgkqhkiG9w0BAQEFAAOCAQ8AMIIBCgKCAQEAsMlD4c4fWwy+5t6VScjizlkFsNzE
BOK5PJyI3B6ReRK/J14Fdxio1YmzG0YobjxiwjppUYEsqPL3Nvh0f10KMqwgJVbdf
6sXWHUVw+9A7cIfRh0aRI+HIYyUC4YD48GlnVnaCqhxYaA0tcMzJm4r2k7AjwJUL
0pDXiqS3uJwGmfxlhvmFio8EeHM/Z79DkBRD6FUMwacAnb3yCIKZH50AWq7qRmmG
NZOgYUT+8oaj5tO/hEQfDYuv32E5z4d3FhiBJMFT86T4YvpJYyJkiKmaQWInkthL
V3VxEMXI5vJQc1MhwYbKfPB4hh3+qdS5o+uVco76CVrcWi7rO3XmsBkbnQIDAQAB
MA0GCSqGSIb3DQEBAQUAA4IBAQAUFVD20GcHD8zdpYf0YaP4b6TuonUzF0jwoV+
Qr9b4kOjEBGuoPdevX3AeV/dvAa2Q6o1iOBM5z74NgHizhr067pFP841Nv7DAVb7
cPHHSSTTSeeJjIVMh0kv0KkVefsYuI4r1jqJxu0GZgBinqehXxVKlceouLvwbhb1
MFYXN3lcE2AXR746q1Vlc6stNkxf3nrlOpSDz3P4VOnbAnIrY+SvUVmAT0tdrowH
99y2AzoAxUH0dWsH8EjCFch7VilmCVVhyghXdfyl6lv/F6vMRwjz343BpBW3QsGj
68ROX0ILrtOz/2q5oUb/rpJd15KFFN3itT/xYBfZ1ZdLYd5F
-----END CERTIFICATE-----
```

2. Create a VXLAN gateway in VMware vCenter console.

This following steps configure the VXLAN gateway:

- a. Open a browser window, enter the vCenter IP address, and log in to VMware vCenter.
- b. Click **Service Definitions** from the left navigation pane.
- c. Click the **Hardware Devices** tab.
- d. Click the green **+** icon under **Hardware Devices** to add a device. The **Add Hardware Device** dialog window opens.
- e. Enter a name for the device in the **Name** box and copy the certificate generated in the OS10 switch and paste it in the **Certificate** box and click **OK**.

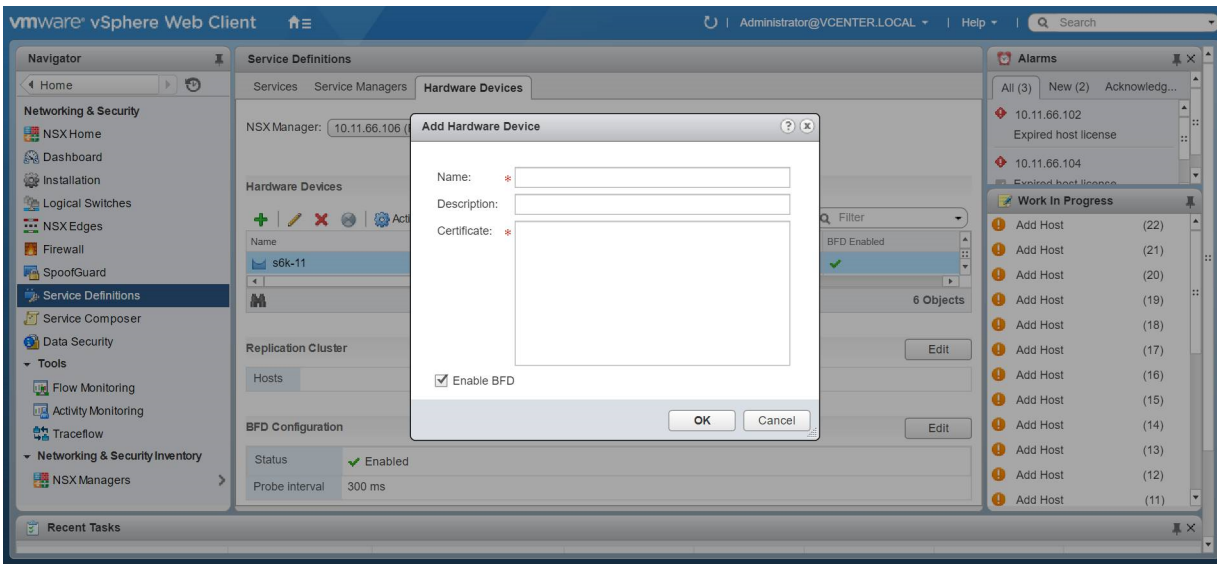

If successfully establishing connectivity between the VTEP and the NSX controller, the console displays the current connection status between the controller and the management IP address of the VTEP.

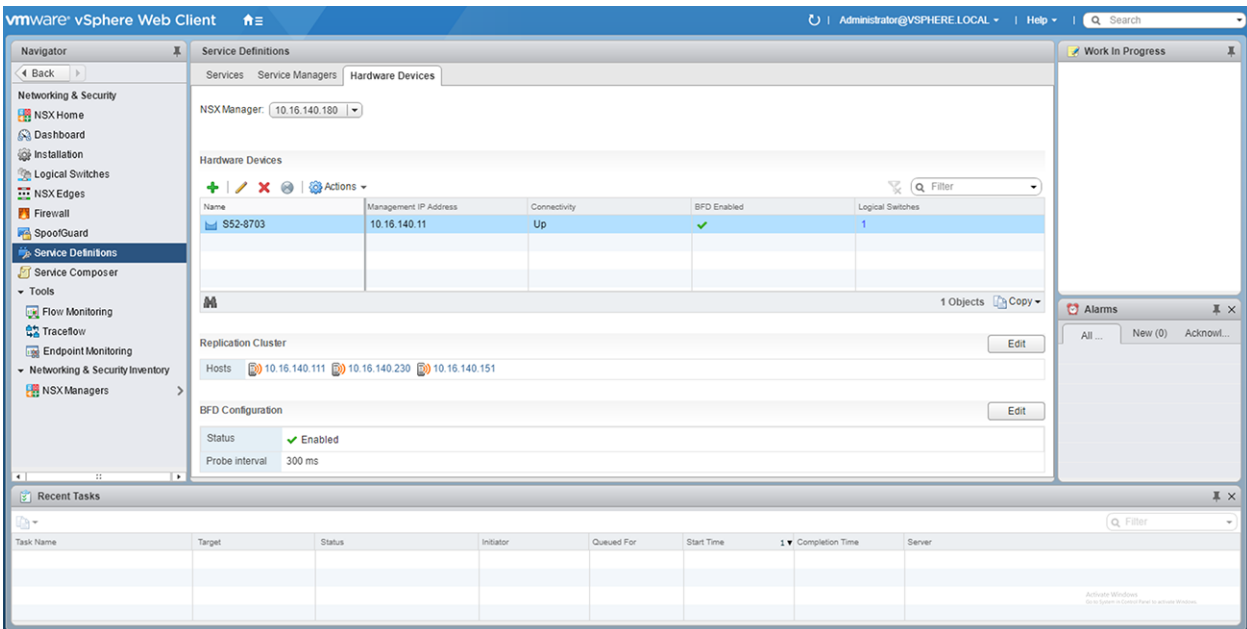

### 3. Create a logical switch.

You can create a logical network that acts as the forwarding domain for virtualized and nonvirtualized server workloads on the physical and virtual infrastructure.

The following steps configure the logical switch for NSX controller management.

- a. Click **Logical Switches** from the left navigation pane.
- b. Click the green **+** icon under **Logical Switches**. The **New Logical Switch** dialog window opens.
- c. Enter a name and select **Unicast** as the replicate mode and click **OK**

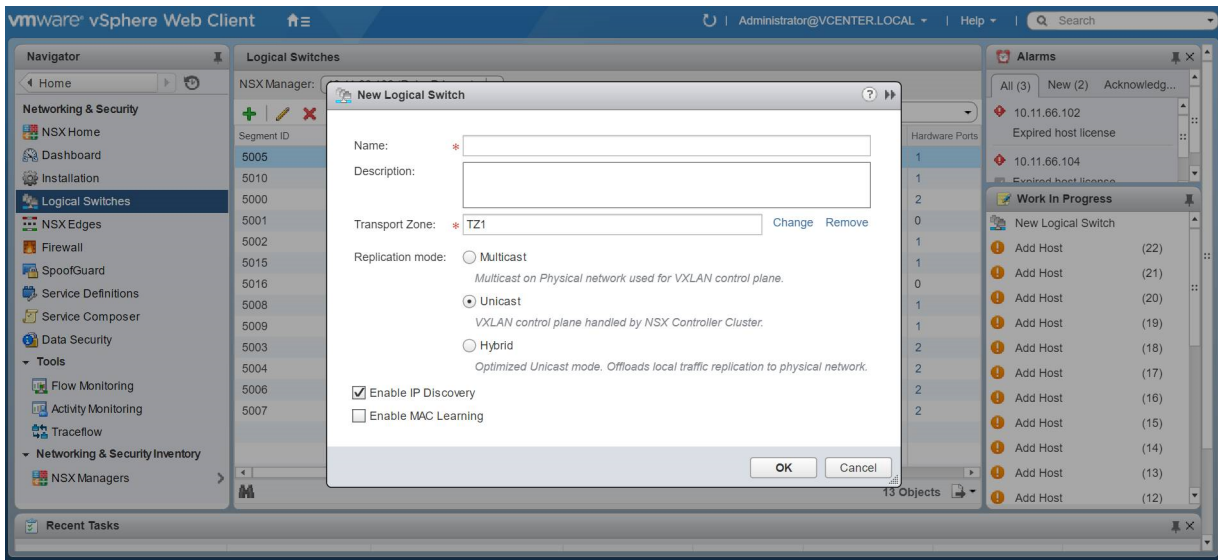

4. Create a logical switch port that provides a logical connection point for a VM interface (VIF) and a L2 gateway connection to an external network.

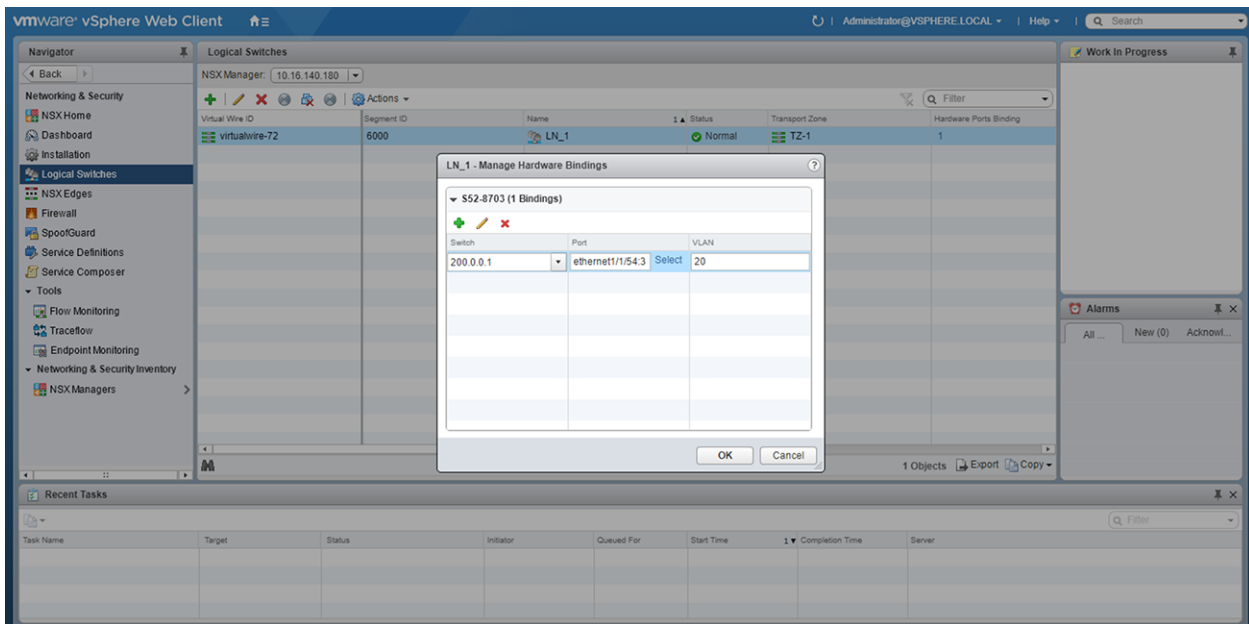

5. (Optional) Enable or disable BFD globally.  
 The following steps enable or disable BFD configuration in the controller.
  - a. Click **Service Definitions** from the left navigation pane.
  - b. Click the **Hardware Devices** tab.
  - c. Click the **Edit** button in the **BFD Configuration**.
  - d. Check or clear the **Enable BFD** check box and provide the **Probe interval**, in milliseconds, if required.

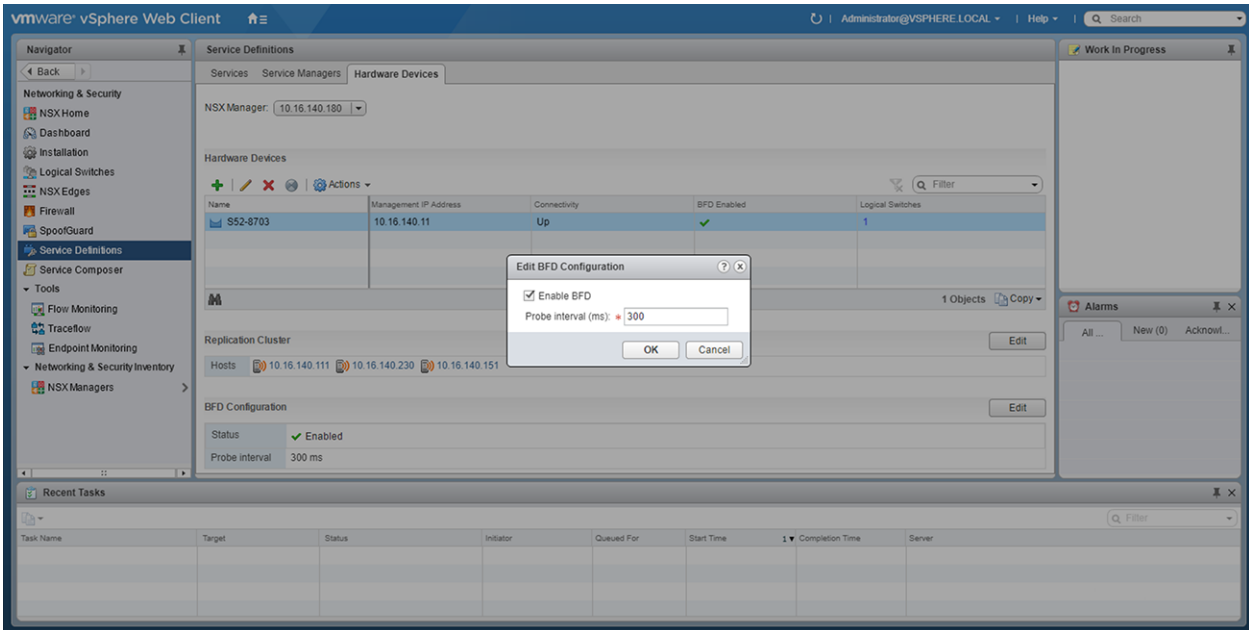

After you configure a VMware NSX controller on a server VM, connect to the controller from the VXLAN gateway switch. For more information about the NSX controller configuration in the VTEP, see [Configure a connection to an OVSDB controller](#). For more information about NSX controller configuration, see the *NSX User Guide* from VMware.

## Example: VXLAN with a controller configuration

This example shows a simple NSX controller and an hardware OS10 VTEP deployed in VXLAN environment.

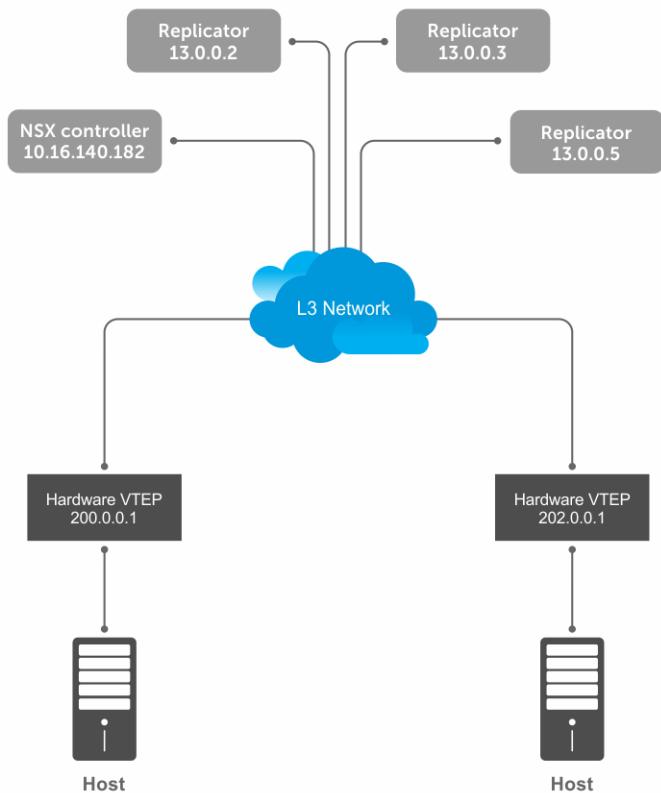

To configure an NSX controller-provisioned VXLAN:

- Configure the controller and the interfaces to be managed by the controller, in the OS10 VTEPs

- Configure the NSX controller in VMware vCenter. For more information about configuring the NSX controller using the GUI, see the [Configure and control VXLAN from the VMware vCenter](#).

You must configure an OS10 VTEP with the controller configuration so that the VTEP can communicate with the NSX controller. The NSX controller handles configurations and control plane operations in the VXLAN environment.

## VTEP 1

1. Configure the OSPF protocol in the underlay.

```
OS10# configure terminal
OS10(config)# router ospf 1
OS10(config)# exit
OS10(config)# interface ethernet 1/1/55:1
OS10(config-if-eth1/1/55:1)# no switchport
OS10(config-if-eth1/1/55:1)# ip ospf 1 area 0.0.0.0
OS10(config-if-eth1/1/55:1)# exit
```

2. Configure a Loopback interface.

```
OS10(config)# interface loopback 1
OS10(config-if-lo-1)# no shutdown
OS10(config-if-lo-1)# ip address 200.0.0.1/32
OS10(config-if-lo-1)# exit
```

3. Create an NVE instance and configure the Loopback interface as the VXLAN source tunnel interface.

```
OS10(config)# nve
OS10(config-nve)# source-interface loopback 1
```

4. Specify the NSX controller reachability information.

```
OS10(config-nve)# controller ovssdb
OS10(config-nve-ovssdb)# ip 10.16.140.182 port 6640 ssl
OS10(config-nve-ovssdb)# max-backoff 10000
OS10(config-nve-ovssdb)# exit
```

5. Assign interfaces to be managed by the controller.

```
OS10(config)# interface ethernet 1/1/54:3
OS10(config-if-eth1/1/54:3)# switchport mode trunk
OS10(config-if-eth1/1/54:3)# no switchport access vlan
OS10(config-if-eth1/1/54:3)# nve-controller
```

6. (Optional) Enable BFD.

```
OS10(config)# bfd enable
```

## VTEP 2

1. Configure the OSPF protocol in the underlay.

```
OS10# configure terminal
OS10(config)# router ospf 1
OS10(config)# exit
OS10(config)# interface ethernet 1/1/23:1
OS10(config-if-eth1/1/23:1)# no switchport
OS10(config-if-eth1/1/23:1)# ip ospf 1 area 0.0.0.0
OS10(config-if-eth1/1/23:1)# exit
```

2. Configure a Loopback interface.

```
OS10(config)# interface loopback 1
OS10(config-if-lo-1)# no shutdown
OS10(config-if-lo-1)# ip address 202.0.0.1/32
OS10(config-if-lo-1)# exit
```



3. Create an NVE instance and configure a Loopback interface as the VXLAN source tunnel interface.

```
OS10(config)# nve
OS10(config-nve)# source-interface loopback 1
```

4. Specify the NSX controller reachability information.

```
OS10(config-nve)# controller ovssdb
OS10(config-nve-ovssdb)# ip 10.16.140.182 port 6640 ssl
OS10(config-nve-ovssdb)# max-backoff 10000
OS10(config-nve-ovssdb)# exit
```

5. Assign interfaces to be managed by the controller.

```
OS10(config)# interface ethernet 1/1/25:3
OS10(config-if-eth1/1/25:3)# switchport mode trunk
OS10(config-if-eth1/1/25:3)# no switchport access vlan
OS10(config-if-eth1/1/25:3)# nve-controller
```

6. (Optional) Enable BFD.

```
OS10(config)# bfd enable
```

## Verify the controller configuration

### VTEP 1

To view controller-based information on the VTEP 1, use the `show nve controller` command.

```
OS10# show nve controller

Management IP : 10.16.140.11/16
Gateway IP : 200.0.0.1
Max Backoff : 10000
Configured Controller : 10.16.140.181:6640 ssl (connected)

Controller Cluster
IP Port Protocol Connected State Max-Backoff
10.16.140.182 6640 ssl true ACTIVE 10000
10.16.140.183 6640 ssl true ACTIVE 10000
10.16.140.181 6640 ssl true ACTIVE 10000

NVE Controller Ports
ethernet1/1/54:3
```

To display the VNID, port members, source interface, and remote VTEPs of the VXLAN, use the `show virtual-network` command.

```
OS10# show virtual-network
Codes: DP - MAC-learn Dataplane, CP - MAC-learn Controlplane, UUD - Unknown-Unicast-Drop
Virtual Network: 0
Members:

Virtual Network: 6000
Members:
 VLAN 20: ethernet1/1/54:3
VxLAN Virtual Network Identifier: 6000
Source Interface: loopback1(200.0.0.1)
Remote-VTEPs (flood-list): 13.0.0.5(CP)
```

To view all the replicators and their status in the VXLAN, use the `show nve replicators` command.

```
OS10# show nve replicators
Codes: * - Active Replicator

BFD Status:Disabled
Replicators State
```

```

13.0.0.5 Up
13.0.0.3 Up
13.0.0.2 Up
```

To view the remote VTEP status, use the `show nve remote-vtep` command.

```
OS10# show nve remote-vtep
IP Address: 13.0.0.2, State: up, Encap: VxLAN
VNI list: ,6000
IP Address: 13.0.0.3, State: up, Encap: VxLAN
VNI list: ,6000
IP Address: 13.0.0.5, State: up, Encap: VxLAN
VNI list: ,6000
IP Address: 202.0.0.1, State: up, Encap: Vxlan
VNI list: 6000
```

## VTEP 2

```
OS10# show nve controller

Management IP : 10.16.140.13/16
Gateway IP : 202.0.0.1
Max Backoff : 10000
Configured Controller : 10.16.140.181:6640 ssl (connected)

Controller Cluster
IP Port Protocol Connected State Max-Backoff
10.16.140.182 6640 ssl true ACTIVE 10000
10.16.140.183 6640 ssl true ACTIVE 10000
10.16.140.181 6640 ssl true ACTIVE 10000

NVE Controller Ports
ethernet1/1/25:3
```

To display the VNID, port members, source interface, and remote VTEPs of the VXLAN, use the `show virtual-network` command.

```
OS10# show virtual-network
Codes: DP - MAC-learn Dataplane, CP - MAC-learn Controlplane, UUD - Unknown-Unicast-Drop
Virtual Network: 0
Members:

Virtual Network: 6000
Members:
VLAN 20: ethernet1/1/25:3
VxLAN Virtual Network Identifier: 6000
Source Interface: loopback1(202.0.0.1)
Remote-VTEPs (flood-list): 13.0.0.5(CP)
```

To view all the replicators and their status in the VXLAN, use the `show nve replicators` command.

```
OS10# show nve replicators
Codes: * - Active Replicator

BFD Status:Disabled
Replicators State

13.0.0.5 Up
13.0.0.3 Up
13.0.0.2 Up
```

To view the remote VTEP status, use the `show nve remote-vtep` command.

```
OS10# show nve remote-vtep
IP Address: 13.0.0.2, State: up, Encap: VxLAN
VNI list: ,6000
IP Address: 13.0.0.3, State: up, Encap: VxLAN
```

```
VNI list: ,6000
IP Address: 13.0.0.5, State: up, Encap: VxLAN
VNI list: ,6000
IP Address: 200.0.0.1, State: up, Encap: Vxlan
VNI list: 6000
```

## VXLAN Controller commands

### controller ovssdb

Changes the mode to CONFIGURATION-NVE-OVSSDB from where you can configure the controller parameters.

**Syntax** `controller ovssdb`

**Parameters** None

**Default** None

**Command mode** CONFIGURATION-NVE

**Usage information** The controller configuration initiates the OVSSDB service on the OS10 switch.

The `no` version of this command stops the OVSSDB service. The `no` version command fails if any ports are configured as controller-managed ports or IP address configuration.

**NOTE:** Before removing the controller configuration from the device, you must delete all controller-managed ports and IP address configuration.

#### Example

```
OS10(config)# nve
OS10(config-nve)# controller ovssdb
```

**Supported releases** 10.4.3.0 or later

### ip port ssl

Configures the OVSSDB controller reachability information such as IP address, port number, and the connection type of session, in the switch.

**Syntax** `ip ip-address port port-number ssl`

**Parameters**

- `ip-address` — Specify the IP address of the OVSSDB controller to connect with.
- `port-number` — Specify the port number through which the connection to the OVSSDB controller is made.

**Default** For an OVSSDB-based controller, configure the following:

- Port number as 6640
- Connection type as SSL

**Command mode** CONFIGURATION-NVE-OVSSDB

**Usage information** Currently, the only supported OVSSDB controller is the NSX controller. `no` version of this command removes the connection to the OVSSDB controller.

#### Example

```
OS10(config)# nve
OS10(config-nve)# controller ovssdb
OS10(config-nve-ovssdb)# ip 10.11.66.110 port 6640 ssl
```

**Supported releases** 10.4.3.0 or later

## max-backoff

Configures a time interval, in milliseconds (ms). This is the duration the switch waits between the connection attempts to the controller.

**Syntax** `max-backoff interval`

**Parameters** `interval`—Enter the amount of time, in ms. This is the duration the switch waits between the connection attempts to the controller, from 1000 to 180000 ms.

**Default** 8000 ms

**Command Mode** CONFIGURATION-NVE-OVSDB

**Usage Information** The `no` version of this command replaces the default maximum wait time configuration in the switch.

### Example

```
OS10(config)# nve
OS10(config-nve)# controller ovsdb
OS10(config-nve-ovsdb)# max-backoff 40000
```

**Supported Releases** 10.4.3.0 or later

## nve-controller

Assigns the interfaces to be managed by the controller.

**Syntax** `nve-controller`

**Parameters** None

**Default** None

**Command mode** INTERFACE

**Usage information** The interface must be in Switchport Trunk mode when adding the interface to the controller. If the interface is not in the Switchport Trunk mode, the system displays the following error message:

```
% Error: Interface ethernet1/1/1, must be in switchport trunk for controller mode.
```

 **NOTE:** If the interface has active port-scoped VLAN (Port,VLAN) pairs configured by the controller, you cannot remove an interface from the controller.

The `no` version of this command removes the interface from the controller and removes any VXLAN binding associated with the interface.

### Example

```
OS10(config)# interface ethernet 1/1/1
OS10(config-if-eth1/1/1)# nve-controller
```

**Supported releases** 10.4.3.0 or later

## nve controller ssl-key-generate

Generates the SSL certificate for the OVSDB server to setup the SSL connection with the controller.

**Syntax** `nve controller ssl-key-generate`

|                           |                                                                                                                                                                                                                        |
|---------------------------|------------------------------------------------------------------------------------------------------------------------------------------------------------------------------------------------------------------------|
| <b>Parameters</b>         | None                                                                                                                                                                                                                   |
| <b>Default</b>            | None                                                                                                                                                                                                                   |
| <b>Command mode</b>       | EXEC                                                                                                                                                                                                                   |
| <b>Usage information</b>  | This command is available only for the <code>sysadmin</code> and <code>secadmin</code> roles. This command generates the SSL certificate and restarts the OVSDB server to start using the newly generated certificate. |
| <b>Example</b>            | <pre>OS10# nve controller ssl-key-generate</pre>                                                                                                                                                                       |
| <b>Supported releases</b> | 10.4.3.0 or later                                                                                                                                                                                                      |

## show nve controller

Displays information about the controller and the controller-managed interfaces.

|                           |                                                                                                                                                                                                                                                                                                                                                                                                                                                                                                                                          |
|---------------------------|------------------------------------------------------------------------------------------------------------------------------------------------------------------------------------------------------------------------------------------------------------------------------------------------------------------------------------------------------------------------------------------------------------------------------------------------------------------------------------------------------------------------------------------|
| <b>Syntax</b>             | <code>show nve controller</code>                                                                                                                                                                                                                                                                                                                                                                                                                                                                                                         |
| <b>Parameters</b>         | None                                                                                                                                                                                                                                                                                                                                                                                                                                                                                                                                     |
| <b>Default</b>            | None                                                                                                                                                                                                                                                                                                                                                                                                                                                                                                                                     |
| <b>Command mode</b>       | EXEC                                                                                                                                                                                                                                                                                                                                                                                                                                                                                                                                     |
| <b>Example</b>            | <pre>OS10# show nve controller  Management IP           : 10.16.140.29/16 Gateway IP              : 55.55.5.5 Max Backoff             : 1000 Configured Controller   : 10.16.140.172:6640 ssl (connected)  Controller Cluster IP      Port      Protocol  Connected  State      Max- Backoff 10.16.140.173  6640    ssl      true       ACTIVE     1000 10.16.140.171  6640    ssl      false      BACKOFF    1000 10.16.140.172  6640    ssl      true       ACTIVE     1000  NVE Controller Ports ethernet1/1/1:1 ethernet1/1/15</pre> |
| <b>Supported releases</b> | 10.4.3.0 or later                                                                                                                                                                                                                                                                                                                                                                                                                                                                                                                        |

## show nve controller ssl-certificate

Displays the SSL certificate generated in the system.

|                          |                                                                                                                                   |
|--------------------------|-----------------------------------------------------------------------------------------------------------------------------------|
| <b>Syntax</b>            | <code>show nve controller ssl-certificate</code>                                                                                  |
| <b>Parameters</b>        | None                                                                                                                              |
| <b>Default</b>           | None                                                                                                                              |
| <b>Command mode</b>      | EXEC                                                                                                                              |
| <b>Usage information</b> | This command is available only for <code>sysadmin</code> and <code>secadmin</code> roles.                                         |
| <b>Example</b>           | <pre>OS10# show nve controller -----BEGIN CERTIFICATE----- MIIDgDCCAmgCAQMwDQYJKoZIhvcNAQENBQAwgYExCzAJBgNVBAYTAlVTMQswCQYD</pre> |

```
VQQIDAJDQTEVMBMGA1UECgMT3B1biB2U3dpcGNoMREwDwYDVQQLDhZd210Y2hj
YTE7MDkGAlUEAwYyT1ZTIHN3aXRjaGNhIENBIENlcnRpZmljYXRlICgyMDE4IFNl
cCAyMyAwMz0NzoyMkwwHhcNMjgwOTIOMTYzMDUyWmcNMjgwOTIOMTYzMDUyWjCB
iTELMakGAlUEBhMCVVMxMzA1BjBGNVBAgMAkNBMRUwEwYDVQQKDAxPcGVuIHZTd210
Y2gxHZAAdBgNVBAsMFk9wZW4gd1N3aXRjaCBjZXJ0aWZpZXIxNTAzBgNVBAMMLGRl
bGwgaWQ6MGVlZmUwYWMtNGJjOC00MmVmlTkzOTEtN2RlMmMwY2JmMTJmIIBIjAN
BgkqhkiG9w0BAQEFAAOCAQ8AMIIBCgKCAQEAsM1D4c4fWwy+5t6VScjizlkFsnZe
BOK5PJyI3B6ReRK/J14Fdxio1YmzG0YObjxiwjpUYEsqPL3Nvh0f10KMqwqJVbdf
6sXWHUVw+9A7cIfRh0aRI+HIYyUC4YD48GlnVnaCqhxYaa0tcMzJm4r2k7AjjwJU1
0pDXiqS3uJwGmfxlhvmFio8EeHM/Z79DkBRD6FUMwacAnb3yCIKZH50AWq7qRmmG
NZOgYUT+8oaj5tO/hEQfDYuv32E5z4d3FhiBJMFT86T4YvpJYyJkiKmaQWInkthL
V3VxEMXI5vJQc1MhwYbKfPB4hh3+qdS5o+uVco76CVrcWi7r03XmsBkbnQIDAQAB
MA0GCSqGSIb3DQEBAQUAA4IBAQAuFVD20GcHD8zdpYf0YaP4b6TuonUzF0jwoV+
Qr9b4kOjEBGuoPdevX3AeV/dvAa2Q6oliOBM5z74NgHizhr067pFP841Nv7DAVb7
cPHHSSTTSeeJjIVMh0kv0KkVefsYuI4rljqJxu0GZgBinqehXxVKlceouLvwbbh1
MFYXN3lcE2AXR746q1Vlc6stNkxf3nr1OpSDz3P4VOnbAnIrY+SvUvMAT0tdrowH
99y2AzoAxUHodWsh8EjCFch7VilmCVVhyghXdfyl6lv/F6vMRwjc343BpBW3QsGj
68ROX0ILrtOz/2q5oUb/rpJd15KFFN3itT/xYBfZ1ZdLYd5F
-----END CERTIFICATE-----
```

**Supported releases** 10.4.3.0 or later

## show nve replicators

Displays all the replicators and their states.

**Syntax** show nve replicators [vnid vnid]

**Parameters** None

**Default** None

**Command mode** EXEC

**Usage information** When you specify the VNID, the output displays details about the service nodes available for the VNID.

### Example (without VNID)

```
OS10# show nve replicators
Codes: * - Active Replicator

BFD Status:Enabled
Replicators State

2.2.2.3 Up
2.2.2.2 Up

OS10# show nve replicators
```

### Example (with VNID)

```
OS10# show nve replicators vnid 10009
Codes: * - Active Replicator

BFD Status:Enabled
Replicators State

2.2.2.3 Up
2.2.2.2* Up
```

\* — indicates service node to which the VTEP sends BUM traffic for the specific VNID.

**Supported releases** 10.4.3.0 or later

## show ovssdb-tables mac-local-ucast

Displays information about local MAC address entries including each MAC address, IP address, local switch name, and VNID.

**Syntax** show ovssdb-tables mac-local-ucast

**Parameters** None

**Default** None

**Command mode** EXEC

**Usage information** This command is available only for netadmin, sysadmin, and secadmin roles.

### Example

```
OS10# show ovssdb-tables mac-local-ucast
Count : 1356
Ucast_Macs_Local table
MAC _uuid ipaddr locator
logical_switch

"00:00:09:00:00:00" 948d2357-9a68-49b2-b5b2-a6a9beaec17a "" bb43d2ec-1e60-4367-9840-648a8cc8acff
f8994210-e29d-4ad4-90fb-557c30f83769
"00:00:09:00:00:01" 4e620093-311a-420e-957f-fbd2bb63f20a "" bb43d2ec-1e60-4367-9840-648a8cc8acff
f8994210-e29d-4ad4-90fb-557c30f83769
"00:00:09:00:00:02" 3846973c-2b29-4c84-af39-dfe7513cbb3d "" bb43d2ec-1e60-4367-9840-648a8cc8acff
f8994210-e29d-4ad4-90fb-557c30f83769
```

**Supported releases** 10.4.3.0 or later

## show ovssdb-tables mac-remote-ucast

Displays information about remote MAC address entries including each MAC address, IP address, local switch name, and VNID.

**Syntax** show ovssdb-tables mac-remote-ucast

**Parameters** None

**Default** None

**Command mode** EXEC

**Usage information** This command is available only for netadmin, sysadmin, and secadmin roles.

### Example

```
OS10# show ovssdb-tables mac-remote-ucast
Count : 1
Ucast_Macs_Remote table
MAC _uuid ipaddr locator
logical_switch

"00:50:56:8a:b4:c8" 61fa240b-e6a3-4d8e-a693-dd2468e6f308 "" 3105e34b-a273-4193-a60f-51d9cee91403
6932fc02-fb12-4a22-9ec2-f0e2b20df476
```

**Supported releases** 10.4.3.0 or later

## show ovssdb-tables manager

Displays information about the list of controllers and the respective controller connection details.

**Syntax** show ovssdb-tables manager

**Parameters** None

**Default** None

**Command mode** EXEC

**Usage information** This command is available only for netadmin, sysadmin, and secadmin roles.

## Example

```
OS10# show ovssdb-tables manager
Count : 3
Manager table
 _uuid inactivity_probe is_connected max_backoff
 other_config
 status
 target

478ec8ca-9c5a-4d29-9069-633af6c48002 [] false 1000 {}
{state=BACKOFF}
"ssl:10.16.140.171:6640"
52f2b491-6372-43e0-98ed-5c4ab0ca8542 [] true 1000 {}
{sec_since_connect="37831", sec_since_disconnect="37832", state=ACTIVE}
"ssl:10.16.140.173:6640"
7b8a7e36-6221-4297-b85e-51f910abcb5c [] true 1000 {}
{sec_since_connect="87", sec_since_disconnect="99", state=ACTIVE}
"ssl:10.16.140.172:6640"
OS10#
```

## Supported releases

10.4.3.0 or later

## show ovssdb-tables tunnel

Displays information about the tunnels created by the physical switch to the service nodes.

**Syntax** show ovssdb-tables tunnel

**Parameters** None

**Default** None

**Command mode** EXEC

**Usage information** This command is available only for netadmin, sysadmin, and secadmin roles.

## Example

```
OS10# show ovssdb-tables tunnel
Count : 2
Tunnel table
 _uuid bfd_config_local bfd_params
 bfd_config_remote
 bfd_status
 local remote

8025d953-acf5-4091-9fa2-75d41953b397 {bfd_dst_ip="55.55.5.5", bfd_dst_mac="00:23:20:00:00:01"} {bfd_dst_ip="2.2.2.2",
bfd_dst_mac="00:50:56:65:b2:3c"} {enable="true", forwarding_if_rx="true", min_rx="1000"} {diagnostic="No Diagnostic",
enabled="true", forwarding="true", remote_state=up, state=up} bb43d2ec-1e60-4367-9840-648a8cc8acff
2d8963da-24d0-4fbd-81e2-fb1a7bba88fd
9853f77a-9db7-47f5-8203-b5b8895d15bd {bfd_dst_ip="55.55.5.5", bfd_dst_mac="00:23:20:00:00:01"} {bfd_dst_ip="2.2.2.3",
bfd_dst_mac="00:50:56:6e:56:9b"} {enable="true", forwarding_if_rx="true", min_rx="1000"} {diagnostic="No Diagnostic",
enabled="true", forwarding="true", remote_state=up, state=up} bb43d2ec-1e60-4367-9840-648a8cc8acff 5eee586b-
e0aa-442b-83ea-16633ec41230
```

## Supported releases

10.4.3.0 or later



## UFT modes

A switch in a Layer 2 (L2) network may require a larger MAC address table size, while a switch in a Layer 3 (L3) network may require a larger routing table size. Unified forwarding table (UFT) offers the flexibility to configure internal L2/L3 forwarding table sizes.

OS10 supports several UFT modes for the forwarding tables. By default, OS10 selects a UFT mode that provides a reasonable size for all tables. The supported UFT modes are: default, scaled-l2-switch, scaled-l3-hosts, and scaled-l3-routes.

**NOTE:** This feature is not supported on the Z9332F-ON platform.

**Table 47. UFT Modes — Table Size for S4048-ON, S4048T-ON, S6010-ON**

| UFT Mode         | L2 MAC Table Size | L3 Host Table Size | L3 Routes Table Size |
|------------------|-------------------|--------------------|----------------------|
| Scaled-l2-switch | 294912            | 16384              | 16384                |
| Scaled-l3-hosts  | 98304             | 212992             | 98304                |
| Scaled-l3-routes | 32768             | 16384              | 131072               |
| Default          | 163840            | 147456             | 16384                |

**Table 48. UFT Modes — Table Size for S3048-ON**

| UFT Mode         | L2 MAC Table Size | L3 Host Table Size | L3 Routes Table Size |
|------------------|-------------------|--------------------|----------------------|
| Scaled-l2-switch | 40960             | 2048               | 8192                 |
| Scaled-l3-hosts  | 8192              | 18432              | 8192                 |
| Default          | 28672             | 8192               | 8192                 |

**Table 49. UFT Modes — Table Size for S41XX-ON series**

| UFT Mode         | L2 MAC Table Size | L3 Host Table Size | L3 Routes Table Size |
|------------------|-------------------|--------------------|----------------------|
| Scaled-l2-switch | 278528            | 4096               | 16384                |
| Scaled-l3-hosts  | 16384             | 266240             | 16384                |
| Scaled-l3-routes | 16384             | 4096               | 262144               |
| Default          | 81920             | 69632              | 131072               |

**Table 50. UFT Modes — Table Size for Z9100-ON**

| UFT Mode         | L2 MAC Table Size | L3 Host Table Size | L3 Routes Table Size |
|------------------|-------------------|--------------------|----------------------|
| Scaled-l2-switch | 139264            | 8192               | 16384                |
| Scaled-l3-hosts  | 8192              | 139264             | 16384                |
| Scaled-l3-routes | 8192              | 8192               | 131072               |
| Default          | 73728             | 73728              | 16384                |

**Table 51. UFT Modes — Table Size for Z9264F-ON**

| UFT Mode         | L2 MAC Table Size | L3 Host Table Size | L3 Routes Table Size |
|------------------|-------------------|--------------------|----------------------|
| Scaled-l2-switch | 270336            | 8192               | 32768                |
| Scaled-l3-hosts  | 8192              | 270336             | 32768                |
| Scaled-l3-routes | 8192              | 8192               | 262144               |
| Default          | 139264            | 139264             | 32768                |

**Table 52. UFT Modes — Table Size for S52XX-ON series**

| UFT Mode         | L2 MAC Table Size | L3 Host Table Size | L3 Routes Table Size |
|------------------|-------------------|--------------------|----------------------|
| Scaled-l2-switch | 294912            | 16384              | 16384                |
| Scaled-l3-hosts  | 32768             | 278528             | 16384                |
| Scaled-l3-routes | 32768             | 16384              | 389120               |
| Default          | 163840            | 147456             | 16384                |

**Table 53. UFT Modes — Table Size for S42xxFB-ON**

| UFT Mode | L2 MAC Table Size | L3 Host Table Size | L3 Routes Table Size |
|----------|-------------------|--------------------|----------------------|
| Default  | 250 K             | 48 K               | 130 K                |

**Table 54. UFT Modes — Table Size for S42xxFBL-ON**

| UFT Mode | L2 MAC Table Size | L3 Host Table Size | L3 Routes Table Size |
|----------|-------------------|--------------------|----------------------|
| Default  | 250 K             | 48 K               | 2 Million            |

 **NOTE:** The L3 routes table size for Scaled-l3-routes mode might vary depending on the routes that are being installed.

## Configure UFT modes

Available UFT modes include L2 MAC table, L3 host table, or L3 route table sizes. Save the configuration and reload the switch for the configuration changes to take effect.

- Select a mode to initialize the maximum table size in CONFIGURATION mode.

```
hardware forwarding-table mode [scaled-l2 | scaled-l3-routes | scaled-l3-hosts]
```

- Disable UFT mode in CONFIGURATION mode.

```
no hardware forwarding-table
```

### Configure UFT mode

```
OS10(config)# hardware forwarding-table mode scaled-l3-hosts
OS10(config)# exit
OS10# write memory
OS10# reload
```

### View UFT mode information

```
OS10# show hardware forwarding-table mode
Mode Current Settings Next-boot Settings
L2 MAC Entries : 163840 scaled-l3-hosts 98304
```

```
L3 Host Entries : 147456 212992
L3 Route Entries : 32768 98304
```

### View UFT information for all modes

```
OS10# show hardware forwarding-table mode all
Mode default scaled-l2 scaled-l3-routes scaled-l3-hosts
L2 MAC Entries 163840 294912 32768 98304
L3 Host Entries 147456 16384 16384 212992
L3 Route Entries 32768 32768 131072 98304
```

## IPv6 extended prefix routes

IPv6 addresses that contain prefix routes with mask between /64 to /128 are called as IPv6 extended prefix routes. These routes require double the key size in the Longest prefix match (LPM) table.

You can configure the number of route entries for extended prefix using the `hardware l3 ipv6-extended-prefix prefix-number` command.

Save and Reload the switch for the settings to become effective.

### Configure IPv6 extended prefix route

```
OS10# configure terminal
OS10(config)# hardware l3 ipv6-extended-prefix 2048
% Warning: IPv6 Extended Prefix Installation will be applied only after a save and
reload.
OS10(config)# do write memory
OS10(config)# reload
```

### View IPv6 extended prefix route configuration

```
OS10# show running-configuration | grep hardware
hardware l3 ipv6-extended-prefix 2048
```

Configuration before reload:

```
OS10# show hardware l3
Current Settings Next-boot Settings
IPv6 Extended Prefix Entries: 0 2048
```

Configuration after reload:

```
OS10# show hardware l3
Current Settings Next-boot Settings
IPv6 Extended Prefix Entries: 2048 2048
```

The `no` version of the command removes the IPv6 extended prefix route configuration. Save and Reload the switch to remove the configuration.

```
OS10(config)# no hardware l3 ipv6-extended-prefix
% Warning: Un-configuring IPv6 Extended Prefix will be applied only after a save and
reload.
```

## UFT commands

### hardware forwarding-table mode

Selects a mode to initialize the maximum scalability size. The available options are: scaled L2 MAC address table, scaled L3 routes table, or scaled L3 hosts table.

|                           |                                                                                                                                                                                                                                                                       |
|---------------------------|-----------------------------------------------------------------------------------------------------------------------------------------------------------------------------------------------------------------------------------------------------------------------|
| <b>Syntax</b>             | <code>hardware forwarding-table mode {scaled-12   scaled-13-routes   scaled-13-hosts}</code>                                                                                                                                                                          |
| <b>Parameters</b>         | <ul style="list-style-type: none"> <li>• <code>scaled-12</code> — Enter the L2 MAC address table size.</li> <li>• <code>scaled-13-routes</code> — Enter the L3 routes table size.</li> <li>• <code>scaled-13-hosts</code> — Enter the L3 hosts table size.</li> </ul> |
| <b>Defaults</b>           | The default parameters vary according to the platform. See <a href="#">UFT modes</a> on page 1105.                                                                                                                                                                    |
| <b>Command Mode</b>       | CONFIGURATION                                                                                                                                                                                                                                                         |
| <b>Usage Information</b>  | <p>Configure the sizes of internal L2 and L3 forwarding tables for your requirements of the network environment. To apply the changes, reload the switch.</p> <p>The <code>no</code> version of this command resets the UFT mode to default.</p>                      |
| <b>Example</b>            | <pre>OS10(config)# hardware forwarding-table mode scaled-13-hosts</pre>                                                                                                                                                                                               |
| <b>Supported Releases</b> | 10.3.0E or later                                                                                                                                                                                                                                                      |

## hardware l3 ipv6-extended-prefix

Configures the maximum number of route entries for IPv6 extended prefix route.

|                           |                                                                                                                                                                                                                                       |
|---------------------------|---------------------------------------------------------------------------------------------------------------------------------------------------------------------------------------------------------------------------------------|
| <b>Syntax</b>             | <code>hardware l3 ipv6-extended-prefix <i>prefix-number</i></code>                                                                                                                                                                    |
| <b>Parameters</b>         | <i>prefix-number</i> — Enter the maximum number of route entries for IPv6 extended prefix route. The options available are: 1024, 2048, or 3072.                                                                                      |
| <b>Defaults</b>           | None                                                                                                                                                                                                                                  |
| <b>Command Mode</b>       | CONFIGURATION                                                                                                                                                                                                                         |
| <b>Usage Information</b>  | Save and Reload the switch for the settings to become effective. The <code>no</code> version of the command removes the IPv6 extended prefix route configuration.                                                                     |
| <b>Example</b>            | <pre>OS10# configure terminal OS10(config)# hardware l3 ipv6-extended-prefix 2048 % Warning: IPv6 Extended Prefix Installation will be applied only after a save and reload. OS10(config)# do write memory OS10(config)# reload</pre> |
| <b>Supported Releases</b> | 10.4.1.0 or later                                                                                                                                                                                                                     |

## show hardware forwarding-table mode

Displays the current hardware forwarding table mode, and the mode after the next boot.

|                          |                                                                                                                                                       |
|--------------------------|-------------------------------------------------------------------------------------------------------------------------------------------------------|
| <b>Syntax</b>            | <code>show hardware forwarding-table mode</code>                                                                                                      |
| <b>Parameters</b>        | None                                                                                                                                                  |
| <b>Defaults</b>          | None                                                                                                                                                  |
| <b>Command Mode</b>      | EXEC                                                                                                                                                  |
| <b>Usage Information</b> | None                                                                                                                                                  |
| <b>Example</b>           | <pre>OS10# show hardware forwarding-table mode Mode                Current Settings      Next-boot Settings default-mode        scaled-13-hosts</pre> |

|                  |   |        |        |
|------------------|---|--------|--------|
| L2 MAC Entries   | : | 163840 | 98304  |
| L3 Host Entries  | : | 147456 | 212992 |
| L3 Route Entries | : | 32768  | 98304  |

**Supported Releases** 10.3.0E or later

## show hardware forwarding-table mode all

Displays table sizes for the hardware forwarding table modes.

**Syntax** `show hardware forwarding-table mode all`

**Parameters** None

**Defaults** None

**Command Mode** EXEC

**Usage Information** None

### Example

```
OS10# show hardware forwarding-table mode all
Mode default scaled-12 scaled-13-routes scaled-
13-hosts
L2 MAC Entries 163840 294912 32768 98304
L3 Host Entries 147456 16384 16384 212992
L3 Route Entries 32768 32768 131072 98304
```

**Supported Releases** 10.3.0E or later

## show hardware l3

Displays the IPv6 extended prefix route configuration.

**Syntax** `show hardware l3`

**Parameters** None

**Defaults** None

**Command Mode** EXEC

**Usage Information** None

### Example

```
OS10# show hardware l3
IPv6 Extended Prefix Entries: 2048
Current Settings: 2048
Next-boot Settings: 2048
```

**Supported Releases** 10.4.1.0 or later

# Security

Dell EMC SmartFabric OS10 has several security features to protect the usability and integrity of the data available in the switch. OS10 also has security features to the user network from attacks and restrict network traffic.

## Switch security

Dell EMC SmartFabric OS10 has various inbuilt security features to secure the administrative access to the switch.

## User management

OS10 controls the user access to the switch and what can they do after login based on the set roles and privileges.

### Configuration notes

All Dell EMC PowerSwitches except MX-Series, S4200-Series, S5200 Series, and Z9332F-ON:

- Admin User - You can delete the default admin username, as long as there is a local user with sysadmin role present. The default admin user sees a warning message in MOTD, unless the user password is changed or the user is deleted.
- Linux Admin User - Password of the linuxadmin user can be modified via a CLI. The linuxadmin user can also be enabled or disabled via another CLI.

```
Example (password modification):
OS10(config)# system-user linuxadmin password Dell@Force10!@
OS10(config)# exit
OS10# write memory
OS10#
OS10# exit
```

```
Example (disable):
OS10(config)# system-user linuxadmin disable
OS10(config)#
```

```
Example (enable):
OS10(config)# no system-user linuxadmin disable
OS10(config)#
```

## User accounts

OS10 allows you to create user accounts to access the OS10 switches. Each user account is defined with username, password and a role to limit OS10 switch access.

## Role-based access control

RBAC provides control for access and authorization. Users are granted permissions based on defined roles — not on their individual system user ID. Create user roles based on job functions to help users perform their associated job functions. You can assign each user only a single role, and many users can have the same role. A user role authenticates and authorizes a user at login, and places the user in EXEC mode. For more information, see [CLI basics](#).

OS10 supports four pre-defined roles: `sysadmin`, `secadmin`, `netadmin`, and `netoperator`. Each user role assigns permissions that determine the commands a user can enter, and the actions a user can perform. RBAC provides an easy and efficient way to administer user rights. If a user's role matches one of the allowed user roles for a command, command authorization is granted.

The OS10 RBAC model provides separation of duty and greater security. It places limitations on each role's permissions to allow you to partition tasks. For greater security, only some user roles can view events, audits, and security system logs.

## Assign user role

To limit OS10 system access, assign a role when you configure each user.

- Enter a user name, password, and role in CONFIGURATION mode.

```
username username password password role role
```

- `username username` — Enter a text string. A maximum of 32 alphanumeric characters; 1 character minimum.
- `password password` — Enter a text string. A maximum of 32 alphanumeric characters; 9 characters minimum.
- `role role` — Enter a user role:
  - `sysadmin` — Full access to all commands in the system, exclusive access to commands that manipulate the file system, and access to the system shell. A system administrator can create user IDs and user roles.
  - `secadmin` — Full access to configuration commands that set security policy and system access, such as password strength, AAA authorization, and cryptographic keys. A security administrator can display security information, such as cryptographic keys, login statistics, and log information.
  - `netadmin` — Full access to configuration commands that manage traffic flowing through the switch, such as routes, interfaces, and ACLs. A network administrator cannot access configuration commands for security features or view security information.
  - `netoperator` — Access to EXEC mode to view the current configuration with limited access. A network operator cannot modify any configuration setting on a switch.

### Create user and assign role

```
OS10(config)# username smith password silver403! role sysadmin
```

### View users

```
OS10# show users
```

| Index | Line  | User  | Role     | Application | Idle | Login-Time            | Location         |
|-------|-------|-------|----------|-------------|------|-----------------------|------------------|
| 1     | ttyS  | root  | root     | -bash       | >24h | 2018-05-23 T23:05:03Z | console          |
| 2     | pts/0 | admin | sysadmin | bash        | 1.1s | 2018-05-30 T20:04:27Z | 10.14.1.214[ssh] |

## Linuxadmin user configuration

OS10 supports two factory-default users: `admin` and `linuxadmin`. Use the `admin` user name to log in to the command-line interface. Use the `linuxadmin` user name to access the Linux shell.

To manage the default `linuxadmin` user from the CLI, you can:

- Configure a lost or forgotten `linuxadmin` password.
- Disable the `linuxadmin` user.

 **NOTE:** These tasks allow you to manage only the default `linuxadmin` user, not other Linux users created at the root level.

### Configure linuxadmin password from CLI

To configure a password for the `linuxadmin` user, use the `system-user linuxadmin password {clear-text-password | hashed-password}` command in CONFIGURATION mode. Save the new password using the `write memory` command. For example:

```
OS10(config)# system-user linuxadmin password Dell@admin10!@
OS10(config)# exit
OS10# write memory
```

```
OS10(config)# system-user linuxadmin password $6$3M55wOYy
$Sw1V9Ok3GE4Hmf6h1ARH.dBHy9gpEFYUvdu15ZpnCYzt.nJjFm0VIz/rQvvJeX6krRtfYs2ZqB16TkmLGAwtM
OS10(config)# exit
OS10# write memory
```

The `linuxadmin` password configured from the CLI takes precedence across reboots over the password configured from the Linux shell.

Verify the `linuxadmin` password using the `show running-configuration` command.

```
OS10# show running-configuration
system-user linuxadmin password
$6$5DdOHYg5$JCE1vMSmkQOrbh31U74PIpv71yOgRmba1IxhkYibppMXs1KM4Y.gbTPcxyMP/PHUkMc5rdk/
ZLv9Sfv3ALtB6l
```

### Disable `linuxadmin` user

To disable or lock the `linuxadmin` user, use the `system-user linuxadmin disable` command in CONFIGURATION mode.

```
OS10(config)# system-user linuxadmin disable
```

To re-enable or unlock the `linuxadmin` user, use the `no system-user linuxadmin disable` command in CONFIGURATION mode.

```
OS10(config)# no system-user linuxadmin disable
```

## Privilege levels

Controlling terminal access to a switch is one method of securing the device and network. To increase security, you can limit user access to a subset of commands using privilege levels.

Configure privilege levels, add commands to them, and restrict access to the command line with passwords. The system supports 16 privilege levels:

- Level 0—Provides users the least privilege, restricting access to basic commands.
- Level 1—Provides access to a set of `show` commands and certain operations such as ping, traceroute, and so on.
- Level 15—Provides access to all available commands for a particular user role.
- Levels 0, 1, and 15—System configured privilege levels with a predefined command set.
- Levels 2 to 14—Not configured. You can customize these levels for different users and access rights.

Privilege levels inherit the commands supported on all lower levels. After logging in with a user role, a user has access to commands assigned to his privilege level and lower levels.

For users assigned to the `sysadmin`, `netadmin`, and `secadmin` roles, you cannot configure a privilege level lower than 2. You can configure `netoperator` users with privilege levels 0 or 1.

After you assign commands to privilege levels, assign the privilege level to users with the `username` command. Use the `enable password privilege-level` command to switch between privilege levels and access the commands supported at each level. The `disable` command takes the user to a lower level.

When a remote user logs in, OS10 checks for a match in the local system. If a local user entry is found, the privilege level of the local user is applied to the remote user for the login session. If no match is found in the local system, OS10 assigns a default privilege level according to the role of the remote user:

- `sysadmin`, `secadmin`, and `netadmin` roles: Level 15
- `netoperator` role: Level 1

 **NOTE:** The role of a local user in the system and the remote user who logs in must be the same at both ends.

## Configure privilege levels

To restrict CLI access, create the required privilege levels for user roles, assign commands to each level, and assign privilege levels to users.

1. Create privilege levels in CONFIGURATION mode.

```
privilege mode priv-lvl privilege-level command-string
```

- `mode` — Enter the privilege mode used to access CLI modes:
  - `exec` — Accesses EXEC mode.



- `configure` — Accesses class-map, DHCP, logging, monitor, openflow, policy-map, QOS, support-assist, telemetry, CoS, Tmap, UFD, VLT, VN, VRF, WRED, and alias modes.
- `interface` — Accesses Ethernet, fibre-channel, loopback, management, null, port-group, lag, breakout, range, port-channel, and VLAN modes.
- `route-map` — Accesses route-map mode.
- `router` — Accesses router-bgp and router-ospf modes.
- `line` — Accesses line-vty mode.
- `priv-lvl privilege-level` — Enter the number of a privilege level, from 2 to 14.
- `command-string` — Enter the commands supported at the privilege level.

2. Create a user name, password, and role, and assign a privilege level in CONFIGURATION mode.

```
username username password password role role priv-lvl privilege-level
```

- `username username` — Enter a text string; 32 alphanumeric characters maximum; one character minimum.
- `password password` — Enter a text string; 32 alphanumeric characters maximum, nine characters minimum.
- `role role` — Enter a user role:
  - `sysadmin` — Full access to all commands in the system, exclusive access to commands that manipulate the file system, and access to the system shell. A system administrator can create user IDs and user roles.
  - `secadmin` — Full access to configuration commands that set security policy and system access, such as password strength, AAA authorization, and cryptographic keys. A security administrator can display security information, such as cryptographic keys, login statistics, and log information.
  - `netadmin` — Full access to configuration commands that manage traffic flowing through the switch, such as routes, interfaces, and ACLs. A network administrator cannot access configuration commands for security features or view security information.
  - `netoperator` — Access to EXEC mode to view the current configuration with limited access. A network operator cannot modify any configuration setting on a switch.
- `priv-lvl privilege-level`—Enter a privilege level, from 0 to 15. If you do not specify the `priv-lvl` option, the system assigns privilege level 1 for the `netoperator` user and privilege level 15 for the `sysadmin`, `secadmin`, and `netadmin` users.

The following is an example of configuring privilege levels and assigning them to a user:

```
OS10(config)# privilege exec priv-lvl 12 "show version"
OS10(config)# privilege exec priv-lvl 12 "configure terminal"
OS10(config)# privilege configure priv-lvl 12 "interface ethernet"
OS10(config)# privilege interface priv-lvl 12 "ip address"
OS10(config)# username delluser password 6Yij02Phe2n6whp7b$ladskj0Howij1lkajg981 role
secadmin priv-lvl 12
```

The following example shows the privilege level of the current user:

```
OS10# show privilege
Current privilege level is 15.
```

The following example displays the privilege levels of all users who are logged into OS10:

```
OS10# show users
```

| Index | Line  | User  | Role     | Application | Idle | Login-Time            | Location         | Privilege |
|-------|-------|-------|----------|-------------|------|-----------------------|------------------|-----------|
| 1     | pts/0 | admin | sysadmin | bash        | >24h | 2018-09-08 T06:51:37Z | 10.14.1.91 [ssh] | 15        |
| 2     | pts/1 | netad | netadmin | bash        | >24h | 2018-09-08 T06:54:33Z | 10.14.1.91 [ssh] | 10        |

## Configure enable password for a privilege level

After you configure privilege levels for users, assign commands to each level and an enable password to access each level:

1. Configure a privilege level and assign commands to it in CONFIGURATION mode.

```
privilege mode priv-lvl privilege-level command-string
```

- `mode` — Enter the privilege mode used to access CLI modes:
  - `exec` — Accesses EXEC mode.

- `configure` — Accesses class-map, DHCP, logging, monitor, openflow, policy-map, QOS, support-assist, telemetry, CoS, Tmap, UFD, VLT, VN, VRF, WRED, and alias modes.
- `interface` — Accesses Ethernet, fibre-channel, loopback, management, null, port-group, lag, breakout, range, port-channel, and VLAN modes.
- `route-map` — Accesses route-map mode.
- `router` — Accesses router-bgp and router-ospf modes.
- `line` — Accesses line-vty mode.
- `priv-lvl privilege-level` — Enter the number of a privilege level, from 2 to 14.
- `command-string` — Enter the command supported at the privilege level.

For `sysadmin`, `netadmin`, and `secadmin` roles, you cannot configure a privilege level less than 2 .

## 2. Configure an enable password for each privilege level in CONFIGURATION mode.

```
enable password encryption-type password-string priv-lvl privilege-level
```

- `encryption-type` — Enter an encryption type for the password entry:
  - 0 — Use plain text with no password encryption.
  - sha-256 — Encrypt the password using the SHA-256 algorithm.
  - sha-512 — Encrypt the password using the SHA-512 algorithm.
- `priv-lvl privilege-level` — Enter a privilege level, from 1 to 15.

```
OS10(config)# privilege exec priv-lvl 3 "show version"
OS10(config)# enable password 0 P@$$w0Rd priv-lvl 3
```

```
OS10(config)# privilege exec priv-lvl 12 "configure terminal"
OS10(config)# privilege configure priv-lvl 12 route-map
OS10(config)# privilege route-map priv-lvl 12 "set local-preference"
OS10(config)# enable password sha-256 $5$2uThib1o$84p.tykjnz/w7j26ymoKBjrb7uepkUB priv-
lvl 12
```

## Passwords for user accounts

OS10 allows you to configure password check and strength for the user accounts.

### Configuration notes

All Dell EMC PowerSwitches except MX-Series, S4200-Series, S5200 Series, and Z9332F-ON:

When you enter a password in an OS10 command, either at a password prompt or in the command syntax, you can enter only alphanumeric and certain special characters - \$ - \_ . + ! \* ' ( ) - unencoded. You cannot enter any other special characters in the password. Use URL encoding instead.

For example, in the image download command, the password `a@b` is not accepted: `image download ftp://username:a@b@10.11.63.122/filename`. You must enter the password as `image download ftp://username:a%40b@10.11.63.122/filename`. The URL encoding for `@` is `%40`. For information about other characters that require URL encoding, go to [URL Encoding](#).

### Enable user lockout

By default, a maximum of three consecutive failed password attempts is supported on the switch. You can set a limit to the maximum number of allowed password retries with a specified lockout period for the user ID.

This feature is available only for the `sysadmin` and `secadmin` roles.

- Configure user lockout settings in CONFIGURATION mode.

```
password-attributes {[max-retry number] [lockout-period minutes] }
```

- `max-retry number` — Sets the maximum number of consecutive failed login attempts for a user before the user is locked out, from 0 to 16; default 3.
- `lockout-period minutes` — Sets the amount of time that a user ID is prevented from accessing the system after exceeding the maximum number of failed login attempts, from 0 to 43,200; default 0.

When a user is locked out due to exceeding the maximum number of failed login attempts, other users can still access the switch.

By default, `lockout-period minutes` is 0; no lockout period is configured. Failed login attempts do not lock out a user.

### Configure user lockout

```
OS10(config)# password-attributes max-retry 4 lockout period 360
```

## Simple password check

By default, OS10 uses a strong password check when you configure user name passwords with the `username username password password role role [priv-lvl privilege-level]` command.

To turn off the strong password check and configure simpler passwords with no restrictions, use the `service simple-password` command.

To disable the simple password check and return to the default strong password check, use the `no service simple-password` command.

- Enter the command in CONFIGURATION mode.

```
service simple-password
```

### Enable simple password check

```
OS10(config)# username abhishek password madmiamadam role sysadmin
%Error: Password fail: it does not contain enough DIFFERENT characters
OS10(config)# service simple-password
OS10(config)# username abhishek password madmiamadam role sysadmin
OS10(config)#
```

## Password strength

By default, the password you configure with the `username password role` and `enable password priv-lvl` commands must be at least nine alphanumeric characters. To increase password strength, you can create stronger password rules using the `password-attributes` command. These password rules apply to the user name and privilege-level password configuration.

When you enter the command, at least one parameter is required. When you enter the `character-restriction` parameter, at least one option is required.

- Create rules for stronger passwords in CONFIGURATION mode.

```
password-attributes {[min-length number] [character-restriction {[upper number]
[lower number][numeric number] [special-char number]}]}
```

- `min-length number` — Enter the minimum number of required alphanumeric characters, from 6 to 32; default 9.
- `character-restriction` — Enter a requirement for the alphanumeric characters in a password:
  - `upper number` — Minimum number of uppercase characters required, from 0 to 31; default 0.
  - `lower number` — Minimum number of lowercase characters required, from 0 to 31; default 0.
  - `numeric number` — Minimum number of numeric characters required, from 0 to 31; default 0.
  - `special-char number` — Minimum number of special characters required, from 0 to 31; default 0.

To turn off the strong password check enabled with the `password-attributes` command, use the `service simple-password` command. No password rules, except for the minimum 9-character requirement, are applied to the user name and privilege-level passwords. To revert to the configured `password-attributes` settings, use the `no service simple-password` command.

### Create strong password rules

```
OS10(config)# password-attributes min-length 7 character-restriction upper 4 numeric 2
```

## Display password rules

```
OS10# show running-configuration password-attributes
password-attributes min-length 7 character-restriction upper 4 numeric 2
```

## Disable strong password check

```
OS10(config)# password-attributes min-length 7 character-restriction upper 4 numeric 2
OS10(config)# username admin2 password 4newhire4 role sysadmin
>Error: Password fail: it does not contain enough DIFFERENT characters
OS10(config)# enable password 0 4newhire4 priv-lvl 5
>Error: Password it does not contain enough DIFFERENT characters.
OS10(config)# service simple-password
OS10(config)# username admin2 password 4newhire4 role sysadmin
OS10(config)# enable password 0 4newhire4 priv-lvl 5
```

## Re-enable strong password check

```
OS10(config)# no service simple-password
```

## Obscure passwords

To obscure passwords in show command output so that text characters do not display, use the `service obscure-password` command. The command obscures the passwords configured for user names, NTP, BGP, SNMP, RADIUS servers, and TACACS+ servers. To disable the obscure passwords function, use the `no service obscure-password` command.

- Enter the command in CONFIGURATION mode.

```
service obscure-password
```

## Obscure OS10 passwords

```
OS10(config)# service obscure-password

OS10(config)# show running-configuration users
username admin password **** role sysadmin priv-lvl 15
username test1 password **** role sysadmin priv-lvl 15

OS10(config)# show running-configuration radius-server
radius-server host 10.2.2.2 key 9 ****

OS10(config)# show running-configuration tacacs-server
tacacs-server host 10.1.1.1 auth-port 7777 key 9 ****
```

## Disable obscure passwords

```
OS10(config)# no service obscure-password

OS10(config)# show running-configuration users
username admin password 6q9QBeYjZ$jfxzVqGhxxX3smxJSH9DDz7/30Jc6m5wjF8nnLD7/
VKx8SloIhp4NoGZs0I/UNwh8WVuxwfd9q4pWIGNs5BKH role sysadmin priv-lvl 15
username test1 password 6rounds=656000$50vutEWA9w3ImvF.
$2pSDnaINyTKCQ6WAlJqeabiFQNRvUgui3.
6vR2e.L/D7DBwnV0QtY.KtOBTZAIDDT5.AFWxQHvgs2/V3jC3yG1 role sysadmin priv-lvl 15

OS10(config)# show running-configuration radius-server
radius-server host 10.2.2.2 key 9
3c0e479bd43bb5baf4ebb16e1317a845f01f832e25a03836c70bd26b9754d6a0

OS10(config)# show running-configuration tacacs-server
tacacs-server host 10.1.1.1 auth-port 7777 key 9
27ca79bf3cbf351708c8d19caf50815661dcd0638719a06c865e88090d03558b
```

## User management commands

### disable

Lowers the privilege level.

|                          |                                                                                                                   |
|--------------------------|-------------------------------------------------------------------------------------------------------------------|
| <b>Syntax</b>            | <code>disable <i>privilege-level</i></code>                                                                       |
| <b>Parameters</b>        | <ul style="list-style-type: none"><li>• <i>privilege-level</i>—Enter the privilege level, from 0 to 15.</li></ul> |
| <b>Defaults</b>          | 1                                                                                                                 |
| <b>Command Mode</b>      | Privileged EXEC                                                                                                   |
| <b>Usage Information</b> | If you do not specify a privilege level, the system assigns level 1.                                              |
| <b>Example</b>           |                                                                                                                   |

```
OS10# disable
```

```
OS10# disable 6
```

|                           |                   |
|---------------------------|-------------------|
| <b>Supported Releases</b> | 10.4.3.0 or later |
|---------------------------|-------------------|

### enable

Enables a specific privilege level.

|                          |                                                                                                                                                                                                                                                                                                                                                                                                                                                                                                                                                                                                                                                                                                                                                                                                                                                                                                                                               |
|--------------------------|-----------------------------------------------------------------------------------------------------------------------------------------------------------------------------------------------------------------------------------------------------------------------------------------------------------------------------------------------------------------------------------------------------------------------------------------------------------------------------------------------------------------------------------------------------------------------------------------------------------------------------------------------------------------------------------------------------------------------------------------------------------------------------------------------------------------------------------------------------------------------------------------------------------------------------------------------|
| <b>Syntax</b>            | <code>enable <i>privilege-level</i></code>                                                                                                                                                                                                                                                                                                                                                                                                                                                                                                                                                                                                                                                                                                                                                                                                                                                                                                    |
| <b>Parameters</b>        | <ul style="list-style-type: none"><li>• <i>privilege-level</i>—Enter the configured privilege level, from 0 to 15.</li></ul>                                                                                                                                                                                                                                                                                                                                                                                                                                                                                                                                                                                                                                                                                                                                                                                                                  |
| <b>Defaults</b>          | 15                                                                                                                                                                                                                                                                                                                                                                                                                                                                                                                                                                                                                                                                                                                                                                                                                                                                                                                                            |
| <b>Command Mode</b>      | Exec                                                                                                                                                                                                                                                                                                                                                                                                                                                                                                                                                                                                                                                                                                                                                                                                                                                                                                                                          |
| <b>Usage Information</b> | <p>Dell EMC Networking recommends configuring a password for privilege level 15 using the <code>enable password</code> command. If you do not configure a password for a level, you can switch to that level without entering a password, unless a password is configured for a highest intermediate level. If you configure a password for an intermediate level, enter that password when prompted. To access privilege level 15, you must configure the <code>enable password</code> command. If you do not configure a password for privilege level 15, you cannot enter level 15. For privilege levels 0 to 14, the <code>enable password</code> command is optional.</p> <p>Privilege levels inherit all permitted commands from all lower levels. For example, if you log in to privilege level 10 using the <code>enable 10</code> command, all commands that are assigned to privilege level 10 and lower are available for use.</p> |

|                |  |
|----------------|--|
| <b>Example</b> |  |
|----------------|--|

```
OS10# enable
```

```
OS10# enable 10
```

|                           |                   |
|---------------------------|-------------------|
| <b>Supported Releases</b> | 10.4.3.0 or later |
|---------------------------|-------------------|

### enable password priv-lvl

Sets a password for a privilege level.

|                   |                                                                                                                   |
|-------------------|-------------------------------------------------------------------------------------------------------------------|
| <b>Syntax</b>     | <code>enable password <i>encryption-type password-string priv-lvl privilege-level</i></code>                      |
| <b>Parameters</b> | <ul style="list-style-type: none"><li>• <i>encryption-type</i> — Enter the type of password encryption:</li></ul> |

- 0 — Use an unencrypted password.
- sha-256 — Use a SHA-256 encrypted password.
- sha-512 — Use a SHA-512 encrypted password.
- `priv-lvl privilege-level` — Enter a privilege number from 1 to 15.

**Defaults** Not configured

**Command Mode** CONFIGURATION

**Usage Information** To increase the required password strength, create stronger password rules using the `password-attributes` command. The `no` version of this command removes a privilege-level password.

**Example**

```
OS10(conf)# enable password 0 P@$$w0Rd priv-lvl 12
```

```
OS10(conf)# enable password sha-256 $5$2uThib1o$84p.tykjnz/
w7j26ymoKBjrb7uepkUB priv-lvl 12
```

```
OS10(conf)# enable password sha-512 6Yij02Phe2n6whp7b
$ladskj0HowijIlkajg981 priv-lvl 12
```

```
OS10# enable 12
password:
OS10# show privilege
Current privilege level is 12.
```

**Supported Releases** 10.4.3.0 or later

## password-attributes

Configures rules for password entries.

**Syntax** `password-attributes {[min-length number] [character-restriction {[upper number] [lower number] [numeric number] [special-char number]}]}`

- Parameters**
- `min-length number` — (Optional) Sets the minimum number of required alphanumeric characters, from 6 to 32; default 9.
  - `character-restriction:`
    - `upper number` — (Optional) Sets the minimum number of uppercase characters required, from 0 to 31; default 0.
    - `lower number` — (Optional) Sets the minimum number of lowercase characters required, from 0 to 31; default 0.
    - `numeric number` — (Optional) Sets the minimum number of numeric characters required, from 0 to 31; default 0.
    - `special-char number` — (Optional) Sets the minimum number of special characters required, from 0 to 31; default 0.

- Default**
- Minimum length: 9 characters
  - Uppercase characters: 0
  - Lowercase characters: 0
  - Numeric characters: 0
  - Special characters: 0

**Command Mode** EXEC

**Usage Information** By default, the password you configure with the `username password` command must be at least nine alphanumeric characters.

Use this command to increase password strength. When you enter the command, at least one parameter is required. When you enter the `character-restriction` parameter, at least one option is required.

To reset parameters to their default values, use the `no password-attributes` command.

Supported on the MX9116n and MX5108n switches in Full Switch mode starting in release 10.4.0E(R3S). Also supported in SmartFabric mode starting in release 10.5.0.1.

### Example

```
OS10(config)# password-attributes min-length 6 character-restriction
upper 2 lower 2 numeric 2
```

### Supported Releases

10.4.0E(R1) or later

## password-attributes max-retry lockout-period

Configures a maximum number of consecutive failed login attempts and the lockout period for the user ID.

**Syntax** `password-attributes {[max-retry number] [lockout-period minutes]}`

### Parameters

- `max-retry number` — (Optional) Sets the maximum number of consecutive failed login attempts for a user before the user is locked out, from 0 to 16.
- `lockout-period minutes` — (Optional) Sets the amount of time that a user ID is prevented from accessing the system after exceeding the maximum number of failed login attempts, from 0 to 43,200.

### Default

- Maximum number of retries: 3
- Lockout period: 0 — No lockout period is configured. Failed login attempts do not lock out a user.

**Command Mode** CONFIGURATION

### Usage Information

To remove the configured `max-retry` or `lockout-period` settings, use the `no password-attributes {max-retry | lockout-period}` command.

When a user is locked out due to exceeding the maximum number of failed login attempts, other users can still access the switch.

Supported on the MX9116n and MX5108n switches in Full Switch mode starting in release 10.4.1.0. Also supported in SmartFabric mode starting in release 10.5.0.1.

### Example

```
OS10(config)# password-attributes max-retry 5 lockout-period 30
```

### Supported Releases

10.4.1.0 or later

## privilege

Creates a privilege level and associates commands with it.

**Syntax** `privilege mode priv-lvl privilege-level command-string`

### Parameters

- `mode` — Enter the privilege mode used to access CLI modes:
  - `exec` — Accesses EXEC mode.
  - `configure` — Accesses class-map, DHCP, logging, monitor, openflow, policy-map, QOS, support-assist, telemetry, CoS, Tmap, UFD, VLT, VN, VRF, WRED, and alias modes.
  - `interface` — Accesses Ethernet, fibre-channel, loopback, management, null, port-group, lag, breakout, range, port-channel, and VLAN modes.
  - `route-map` — Accesses route-map mode.
  - `router` — Accesses router-bgp and router-ospf modes.
  - `line` — Accesses line-vty mode.
- `priv-lvl privilege-level` — Enter the number of a privilege level, from 2 to 14.
- `command-string` — Enter the commands supported at the privilege level.

### Defaults

Not configured

|                           |                                                                                                                                                                                                                                                                                                                                                                                                                                                                                                 |
|---------------------------|-------------------------------------------------------------------------------------------------------------------------------------------------------------------------------------------------------------------------------------------------------------------------------------------------------------------------------------------------------------------------------------------------------------------------------------------------------------------------------------------------|
| <b>Command Mode</b>       | CONFIGURATION                                                                                                                                                                                                                                                                                                                                                                                                                                                                                   |
| <b>Usage Information</b>  | <p>For users assigned to <code>sysadmin</code>, <code>netadmin</code>, and <code>secadmin</code> roles, you cannot configure a privilege level less than 2.</p> <p>If a command that you associate with a privilege level has a space, enter the command in double quotes ("). If a command does not have a space or if it has keywords separated by a hyphen, double quotes are not required.</p> <p>The <code>no</code> version of this command removes a command from a privilege level.</p> |
| <b>Example</b>            | <pre>OS10(config)# privilege exec priv-lvl 3 "configure terminal" OS10(config)# privilege configure priv-lvl 3 "interface ethernet" OS10(config)# privilege interface priv-lvl 3 "ip address" OS10(config)# privilege configure priv-lvl 3 route-map OS10(config)# privilege route-map priv-lvl 3 "set local-preference"</pre>                                                                                                                                                                  |
| <b>Supported Releases</b> | 10.4.3.0 or later                                                                                                                                                                                                                                                                                                                                                                                                                                                                               |

## service simple-password

Disables the strong password check configured with `username password role` and `password-attributes` commands.

|                           |                                                                                                                                                                                                                                                                                      |
|---------------------------|--------------------------------------------------------------------------------------------------------------------------------------------------------------------------------------------------------------------------------------------------------------------------------------|
| <b>Syntax</b>             | <code>service simple-password</code>                                                                                                                                                                                                                                                 |
| <b>Parameters</b>         | None                                                                                                                                                                                                                                                                                 |
| <b>Default</b>            | Not configured                                                                                                                                                                                                                                                                       |
| <b>Command Mode</b>       | CONFIGURATION                                                                                                                                                                                                                                                                        |
| <b>Usage Information</b>  | <p>Use the <code>service simple-password</code> command to turn off the strong password checks so that you can configure passwords with no restrictions.</p> <p>To revert to the configured stronger password settings, use the <code>no service simple-password</code> command.</p> |
| <b>Example</b>            | <pre>OS10(config)# service simple-password</pre>                                                                                                                                                                                                                                     |
| <b>Supported Releases</b> | 10.5.0 or later                                                                                                                                                                                                                                                                      |

## service obscure-password

Obscures passwords in `show` command output.

|                           |                                                                                                                                                                                                                                                                                                                                                                                          |
|---------------------------|------------------------------------------------------------------------------------------------------------------------------------------------------------------------------------------------------------------------------------------------------------------------------------------------------------------------------------------------------------------------------------------|
| <b>Syntax</b>             | <code>service obscure-password</code>                                                                                                                                                                                                                                                                                                                                                    |
| <b>Parameters</b>         | None                                                                                                                                                                                                                                                                                                                                                                                     |
| <b>Default</b>            | Not configured                                                                                                                                                                                                                                                                                                                                                                           |
| <b>Command Mode</b>       | CONFIGURATION                                                                                                                                                                                                                                                                                                                                                                            |
| <b>Usage Information</b>  | <p>Use <code>service obscure-password</code> command so that the text characters of passwords are not displayed in <code>show</code> command output. The command obscures the passwords that you configure for user names, NTP, BGP, SNMP, RADIUS servers, and TACACS+ servers. To disable the obscure passwords function, use the <code>no service obscure-password</code> command.</p> |
| <b>Example</b>            | <pre>OS10(config)# service obscure-password</pre>                                                                                                                                                                                                                                                                                                                                        |
| <b>Supported Releases</b> | 10.5.0 or later                                                                                                                                                                                                                                                                                                                                                                          |



## show users

Displays information for all users logged into OS10.

**Syntax** show users  
**Parameters** None  
**Default** Not configured  
**Command Mode** EXEC

**Usage Information** Updated the command to display the privilege levels of all users on OS10 version .

### Example

```
OS10# show users
Index Line User Role Application Idle Login-Time Location
Privilege

1 pts/0 admin sysadmin bash >24h 2018-09-08 T06:51:37Z 10.14.1.91 [ssh] 15
2 pts/1 netad netadmin bash >24h 2018-09-08 T06:54:33Z 10.14.1.91 [ssh] 10
```

**Supported Releases** 10.2.0E or later 10.4.3.0 or later

## show privilege

Displays your current privilege level.

**Syntax** show privilege  
**Parameters** None  
**Defaults** Not configured  
**Command Mode** EXEC

### Example

```
OS10# show privilege
Current privilege level is 15.
```

**Supported Releases** 10.4.3.0 or later

## show running-configuration privilege

Displays the configured privilege levels of all users.

**Syntax** show running-configuration privilege  
**Parameters** None  
**Defaults** Not configured  
**Command Mode** EXEC

### Example

```
OS10# show running-configuration privilege
privilege exec priv-lvl 3 configure
privilege configure priv-lvl 4 "interface ethernet"
enable password sha-512 6Yij02Phe2n6whp7b$ladskj0Howij1lkajg981 priv-
lvl 12
```

**Supported Releases** 10.4.3.0 or later

## system-user linuxadmin password

Configures a password for the linuxadmin user.

|                           |                                                                                                                                                                                                                                                      |
|---------------------------|------------------------------------------------------------------------------------------------------------------------------------------------------------------------------------------------------------------------------------------------------|
| <b>Syntax</b>             | <code>system-user linuxadmin password {clear-text-password   hashed-password}</code>                                                                                                                                                                 |
| <b>Parameters</b>         | None                                                                                                                                                                                                                                                 |
| <b>Defaults</b>           | Not configured                                                                                                                                                                                                                                       |
| <b>Command Mode</b>       | CONFIGURATION                                                                                                                                                                                                                                        |
| <b>Usage Information</b>  | Use this command to set a clear-text or hashed-password for the linuxadmin user.<br>Supported on the MX9116n and MX5108n switches in Full Switch mode starting in release 10.4.3.0. Also supported in SmartFabric mode starting in release 10.5.0.1. |
| <b>Example</b>            | <pre>OS10(config)# system-user linuxadmin password Dell@Force10!@<br/><br/>OS10(config)# system-user linuxadmin password \$6\$3M55wOYy<br/>\$Sw1V9Ok3GE4Hmf6h1ARH.dBHy9gpEFYUvdu15ZpnCYzt.nJjFm0VIz/<br/>rQvvJeX6krRtfYs2ZqBl6TkmLGAwtM</pre>        |
| <b>Supported Releases</b> | 10.4.3.0 or later                                                                                                                                                                                                                                    |

## system-user linuxadmin disable

Disables the linuxadmin user.

|                           |                                                                                                                                                                                                                                                                                                      |
|---------------------------|------------------------------------------------------------------------------------------------------------------------------------------------------------------------------------------------------------------------------------------------------------------------------------------------------|
| <b>Syntax</b>             | <code>[no] system-user linuxadmin disable</code>                                                                                                                                                                                                                                                     |
| <b>Parameters</b>         | None                                                                                                                                                                                                                                                                                                 |
| <b>Defaults</b>           | Enabled                                                                                                                                                                                                                                                                                              |
| <b>Command Mode</b>       | CONFIGURATION                                                                                                                                                                                                                                                                                        |
| <b>Usage Information</b>  | Use this command to disable and lock the linuxadmin user. The no version of the command enables and unlocks the linuxadmin user.<br>Supported on the MX9116n and MX5108n switches in Full Switch mode starting in release 10.4.3.0. Also supported in SmartFabric mode starting in release 10.5.0.1. |
| <b>Example</b>            | <pre>OS10(config)# system-user linuxadmin disable<br/><br/>OS10(config)# no system-user linuxadmin disable</pre>                                                                                                                                                                                     |
| <b>Supported Releases</b> | 10.4.3.0 or later                                                                                                                                                                                                                                                                                    |

## userrole inherit

Reconfigures the default netoperator role and permissions that OS10 assigns by default to a RADIUS or TACACS+ authenticated user with an unknown user role or privilege level. You can also configure an unknown RADIUS or TACACS+ user role to inherit permissions from an existing OS10 role.

|                   |                                                                                                                                                                                                                                                                                                                                                                                                                                                                                  |
|-------------------|----------------------------------------------------------------------------------------------------------------------------------------------------------------------------------------------------------------------------------------------------------------------------------------------------------------------------------------------------------------------------------------------------------------------------------------------------------------------------------|
| <b>Syntax</b>     | <code>userrole {default   name} inherit existing-role-name</code>                                                                                                                                                                                                                                                                                                                                                                                                                |
| <b>Parameters</b> | <ul style="list-style-type: none"><li>• <code>default inherit</code> — Reconfigure the default permissions assigned to an authenticated user with a missing or unknown role or privilege level.</li><li>• <code>name inherit</code> — Enter the name of the RADIUS or TACACS+ user role that inherits permissions from an OS10 user role; 32 characters maximum.</li><li>• <code>existing-role-name</code> — Assign the permissions associated with an OS10 user role:</li></ul> |

- `sysadmin` — Full access to all commands in the system, exclusive access to commands that manipulate the file system, and access to the system shell. A system administrator can create user IDs and user roles.
- `secadmin` — Full access to configuration commands that set security policy and system access, such as password strength, AAA authorization, and cryptographic keys. A security administrator can display security information, such as cryptographic keys, login statistics, and log information.
- `netadmin` — Full access to configuration commands that manage traffic flowing through the switch, such as routes, interfaces, and ACLs. A network administrator cannot access configuration commands for security features or view security information.
- `netoperator` — Access to EXEC mode to view the current configuration with limited access. A network operator cannot modify any configuration setting on a switch.

**Default** OS10 assigns the `netoperator` role to a user authenticated by a RADIUS or TACACS+ server with a missing or unknown role or privilege level.

**Command Mode** CONFIGURATION

**Usage Information** When a RADIUS or TACACS+ server authenticates a user and does not return a role or privilege level, or returns an unknown role or privilege level, OS10 assigns the `netoperator` role to the user by default. Use this command to reconfigure the default `netoperator` permissions.

To assign OS10 user role permissions to an unknown user role, enter the RADIUS or TACACS+ `name` with the `inherit existing-role-name` value. The `no` version of the command resets the role to `netoperator`.

Supported on the MX9116n and MX5108n switches in Full Switch mode starting in release 10.4.0E(R3S). Also supported in SmartFabric mode starting in release 10.5.0.1.

**Example**

```
OS10(config)# userrole default inherit sysadmin
```

**Supported Releases** 10.4.0E(R3P3) or later

## username password role

Creates an authentication entry based on a user name and password, and assigns a role to the user.

**Syntax** `username username password password role role [priv-lvl privilege-level]`

- Parameters**
- `username username`—Enter a text string. A maximum of 32 alphanumeric characters; one character minimum.
  - `password password`—Enter a text string. A maximum of 32 alphanumeric characters; nine characters minimum. Password prefixes \$1\$, \$5\$, and \$6\$ are not supported in clear-text passwords.
  - `role role`—Enter a user role:
    - `sysadmin` — Full access to all commands in the system, exclusive access to commands that manipulate the file system, and access to the system shell. A system administrator can create user IDs and user roles.
    - `secadmin` — Full access to configuration commands that set security policy and system access, such as password strength, AAA authorization, and cryptographic keys. A security administrator can display security information, such as cryptographic keys, login statistics, and log information.
    - `netadmin` — Full access to configuration commands that manage traffic flowing through the switch, such as routes, interfaces, and ACLs. A network administrator cannot access configuration commands for security features or view security information.
    - `netoperator` — Access to EXEC mode to view the current configuration with limited access. A network operator cannot modify any configuration setting on a switch.
  - `priv-lvl privilege-level` — Enter a privilege level, from 0 to 15. If you do not specify the `priv-lvl` option, the system assigns privilege level 1 for the `netoperator` role and privilege level 15 for the `sysadmin`, `secadmin`, and `netadmin` roles.

**Default** ● User name and password entries are in clear text.

- There is no default user role.
- The default privilege levels are level 1 for `netoperator`, and level 15 for `sysadmin`, `secadmin`, and `netadmin`.

**Command Mode** CONFIGURATION

**Usage Information** By default, the password must be at least nine alphanumeric characters. Only the following special characters are supported:

```
! # % & ' () ; < = > [] * + - . / : ^ _
```

Enter the password in clear text. It is converted to SHA-512 format in the running configuration. For backward compatibility with OS10 releases 10.3.1E and earlier, passwords entered in MD-5, SHA-256, and SHA-512 format are supported.

You cannot assign a privilege level higher than privilege level 1 to a user with the `netoperator` role and higher than privilege level 2 for a `sysadmin`, `secadmin`, and `netadmin` roles.

To increase the required password strength, use the `password-attributes` command. The `no` version of this command deletes the authentication for a user.

Supported on the MX9116n and MX5108n switches in Full Switch mode starting in release 10.4.0E(R3S). Also supported in SmartFabric mode starting in release 10.5.0.1.

### Example

```
OS10(config)# username user05 password newpwd404 role sysadmin priv-lvl 10
```

**Supported Releases** 10.2.0E or later

## AAA

Authentication, authorization, and accounting (AAA) services secure networks against unauthorized access. In addition to local authentication, OS10 supports remote authentication dial-in user service (RADIUS) and terminal access controller access control system (TACACS+) client/server authentication systems. For RADIUS and TACACS+, an OS10 switch acts as a client and sends authentication requests to a server that contains all user authentication and network service access information.

A RADIUS or TACACS+ server provides: authentication of user credentials, authorization using role-based permissions, and accounting services. You can configure the security protocol used for different login methods and users. RADIUS provides limited authorization and accounting services compared to TACACS+. If you use a RADIUS or TACACS+ security server, configure the required security parameters on the server by following the procedures in the server documentation.

### AAA configuration

On the switch, AAA configuration consists of setting up access control and accounting services:

1. Configure the authentication methods used to allow access to the switch.
2. Configure the level of command authorization for authenticated users.
3. Configure security settings for user sessions.
4. Enable AAA accounting.

## AAA authentication

An OS10 switch uses a list of authentication methods to define the types of authentication and the sequence in which they apply. By default, OS10 uses only the `local` authentication method.

The authentication methods in the method list execute in the order you configure them. Re-enter the methods to change the order. The `local` authentication method remains enabled even if you remove all configured methods in the list using the `no aaa authentication login {console | default}` command.

**NOTE:** If you configure multiple authentication methods on Dell EMC PowerEdge MX7000 Ethernet switches—MX9116n Fabric Switching Engine and MX5108n Ethernet Switch—operating in SmartFabric mode, you must configure local authentication as the first method in the list.

- Configure the AAA authentication method in CONFIGURATION mode.

```
aaa authentication login {console | default} {local | group radius | group tacacs+}
```

- console—Configure authentication methods for console logins.
- default—Configure authentication methods for nonconsole such as SSH and Telnet logins.
- local—Use the local username, password, and role entries configured with the `username password role` command.
- group radius—Configure RADIUS servers using the `radius-server host` command.
- group tacacs+—Configure TACACS+ servers using the `tacacs-server host` command.

### Configure user role on server

If a console user logs in with RADIUS or TACACS+ authentication, the role you configured for the user on the RADIUS or TACACS+ server applies. User authentication fails if no role is configured on the authentication server.

To authenticate a user on OS10 through a TACACS+ server, configure the mandatory role with the value `sysadmin` along with 15 as privilege level on the TACACS+ Server. The following figure shows the Cisco ISE TACACS server configuration:

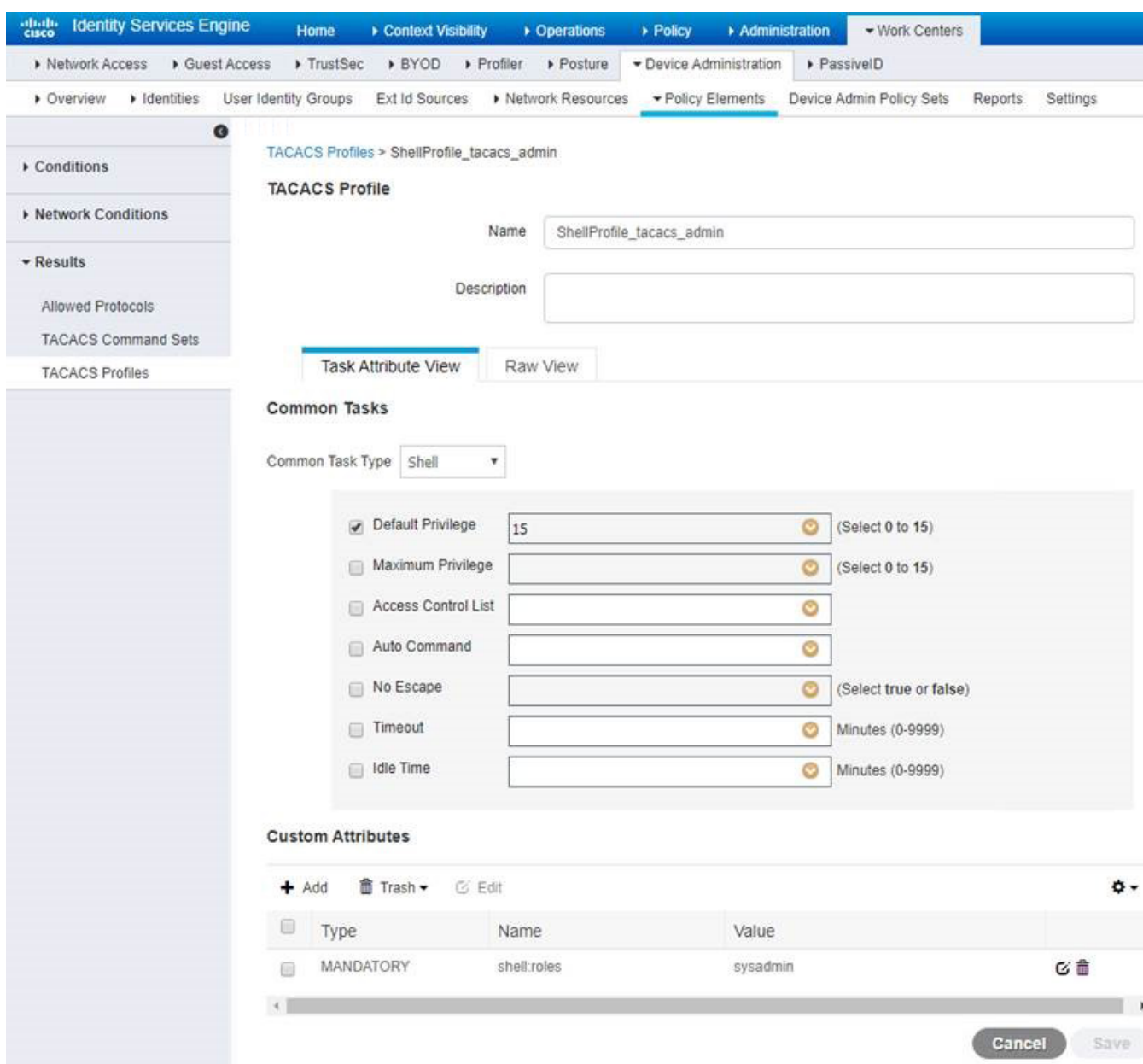

Also, you must configure the user role on the RADIUS or TACACS+ server using the vendor-specific attribute (VSA) or the authentication fails. The vendor ID of Dell EMC is 674. Create a VSA with Name = `Dell-group-name`, OID = 2, Type

= string. Valid values for *Dell-group-name* are *sysadmin*, *secadmin*, *netadmin*, and *netoperator*. Use the VSA *Dell-group-name* values when you create users on a RADIUS or TACACS+ server.

For detailed information about how to configure vendor-specific attributes on a RADIUS or TACACS+ server, see the respective RADIUS or TACACS+ server documentation.

### Configure AAA authentication

```
OS10(config)# aaa authentication login default group radius local
OS10(config)# do show running-configuration aaa
aaa authentication login default group radius local
aaa authentication login console local
```

### Remove AAA authentication methods

```
OS10(config)# no aaa authentication login default
OS10(config)# do show running-configuration aaa
aaa authentication login default local
aaa authentication login console local
```

## User re-authentication

To prevent users from accessing resources and performing tasks that they are not authorized to perform, OS10 requires users to re-authenticate by logging in again when:

- Adding or removing a RADIUS server using the `radius-server host` command
- Adding or removing an authentication method using the `aaa authentication login {console | default} {local | group radius | group tacacs+}` command

By default, user re-authentication is disabled. You can enable this feature so that user re-authentication is required when any of these actions are performed. In these cases, logged-in users are logged out of the switch and all OS10 sessions terminate.

### Enable user re-authentication

- Enable user re-authentication in CONFIGURATION mode.

```
aaa re-authenticate enable
```

The `no` version of this command disables user re-authentication.

## AAA with RADIUS authentication

To configure a RADIUS server for authentication, enter the server IP address or hostname, and the key that is used to authenticate the OS10 switch on a RADIUS host. You can enter the authentication key in plain text or encrypted format. You can change the User Datagram Protocol (UDP) port number on the server.

- Configure a RADIUS authentication server in CONFIGURATION mode. By default, a RADIUS server uses UDP port 1812.

```
radius-server host {hostname | ip-address} key {0 authentication-key | 9
authentication-key | authentication-key} [auth-port port-number]
```

To configure more than one RADIUS server, re-enter the `radius-server host` command multiple times. If you configure multiple RADIUS servers, OS10 attempts to connect in the order you configured them. An OS10 switch connects with the configured RADIUS servers one at a time, until a RADIUS server responds with an accept or reject response. The switch tries to connect with a server for the configured number of retransmit retries and timeout period.

Configure global settings for the timeout and retransmit attempts that are allowed on RADIUS servers. By default, OS10 supports three RADIUS authentication attempts and times out after five seconds. No source interface is configured. The default VRF instance is used to contact RADIUS servers.

**NOTE:** You cannot configure both a nondefault VRF instance (including management VRF) and a source interface at the same time for RADIUS authentication.

**NOTE:** A RADIUS server that is configured with a hostname is not supported on a nondefault VRF.

- Configure the number of times OS10 retransmits a RADIUS authentication request in CONFIGURATION mode, from 0 to 100 retries; the default is 3.

```
radius-server retransmit retries
```

- Configure the timeout period used to wait for an authentication response from a RADIUS server in CONFIGURATION mode, from 0 to 1000 seconds; the default is 5.

```
radius-server timeout seconds
```

- (Optional) Specify an interface whose IP address is used as the source IP address for user authentication with RADIUS servers in CONFIGURATION mode. By default, no source interface is configured. OS10 selects the source IP address of any interface from which a packet is sent to a RADIUS server.

An interface may have two IPv4 addresses and multiple IPv6 addresses. The selected OS10 source interface matches the version of the RADIUS server IP address: IPv4 or IPv6.

- For an IPv4 RADIUS server, the primary IPv4 address is used.
- For an IPv6 server, any of the global IPv6 addresses that are configured on the interface are used.
- If no address of the same IP version as the RADIUS server is configured, RADIUS authentication is performed with no source interface, using the IP address of the management interface. The management IP address serves as the RADIUS network access server (NAS) IP address on the switch.

```
ip radius source-interface interface
```

On the RADIUS server, you must update the configured IP routes using the Linux command line so that the source interface routes match the NAS IP route.

If OS10 uses a RADIUS server VRF instance, a RADIUS server source interface is not supported and cannot be configured.

- (Optional) When you use management VRF for RADIUS authentication, configure the IP address of the network access server (NAS) using the radius-server nas-ip-address command.

```
radius-server nas-ip-address ipv4-address
```

- (Optional) By default, the switch uses the default VRF instance to communicate with RADIUS servers. You can optionally configure a nondefault or the management VRF instance for RADIUS authentication in CONFIGURATION mode.

```
radius-server vrf management
radius-server vrf vrf-name
```

### Configure RADIUS server

```
OS10(config)# radius-server host 1.2.4.5 key secret1
OS10(config)# radius-server retransmit 10
OS10(config)# radius-server timeout 10
OS10(config)# ip radius source-interface mgmt 1/1/1
```

### Configure RADIUS server for non-default VRFs

```
OS10(config)# ip vrf blue
OS10(conf-vrf)# exit
OS10(config)# radius-server vrf blue
```

### Configure RADIUS server for management VRF

```
OS10(config)# ip vrf management
OS10(conf-vrf)# exit
OS10(config)# radius-server nas-ip-address 10.5.1.1
```

### View RADIUS server configuration

```
OS10# show running-configuration
...
radius-server host 1.2.4.5 key 9
3a95c26b2a5b96a6b80036839f296babe03560f4b0b7220d6454b3e71bdfc59b
radius-server retransmit 10
radius-server timeout 10
```

```
ip radius source-interface mgmt 1/1/1
...
```

### Delete RADIUS server

```
OS10# no radius-server host 1.2.4.5
```

## RADIUS over TLS authentication

Traditional RADIUS-based user authentication runs over UDP and uses the MD5 message-digest algorithm for secure communications. To provide enhanced security in RADIUS user authentication exchanges, RFC 6614 defines the RADIUS over Transport Layer Security (TLS) protocol. RADIUS over TLS secures the entire authentication exchange in a TLS connection and provides additional security by:

- Performing mutual authentication of a client and server using public key infrastructure (PKI) certificates
- Encrypting the entire authentication exchange so that neither the user ID nor password is vulnerable to discovery

RADIUS over TLS authentication requires that X.509v3 PKI certificates are configured on a certification authority (CA) and installed on the switch. For more information, including a complete RADIUS over TLS use case, see [X.509v3 certificates](#).

**NOTE:** If you enable FIPS using the `crypto fips enable` command, RADIUS over TLS operates in FIPS mode. In FIPS mode, RADIUS over TLS requires that a FIPS-compliant certificate and key pair are installed on the switch. In non-FIPS mode, RADIUS over TLS requires that a certificate is installed as a non-FIPS certificate. For information about how to install FIPS-compliant and non-FIPS certificates, see [Request and install host certificates](#).

To configure RADIUS over TLS user authentication, use the `radius-server host tls` command. Enter the server IP address or host name, and the shared secret key used to authenticate the OS10 switch on a RADIUS host. You must enter the name of an X.509v3 security profile to use with RADIUS over TLS authentication — see [Security profiles](#). You can enter the authentication key in plain text or encrypted format. By default, RADIUS over TLS connections use TCP port 2083, and require that the authentication key is `radsec`. You can change the TCP port number on the server.

- Configure a RADIUS over TLS authentication on a RADIUS server in CONFIGURATION mode.

```
radius-server host {hostname | ip-address} tls security-profile profile-name
[auth-port port-number] key {0 authentication-key | 9 authentication-key |
authentication-key}
```

To configure more than one RADIUS server for RADIUS over TLS authentication, re-enter the `radius-server host tls` command multiple times. If you configure multiple RADIUS servers, OS10 attempts to connect in the order you configured them. An OS10 switch connects with the configured RADIUS servers one at a time, until a RADIUS server responds with an accept or reject response. The switch tries to connect with a server for the configured number of retransmit retries and timeout period.

A security profile determines the X.509v3 certificate on the switch to use for TLS authentication with a RADIUS server. To configure a security profile for an OS10 application, see [Security profiles](#).

Configure global settings for the timeout and retransmit attempts allowed on RADIUS servers as described in [RADIUS authentication](#).

### Configure RADIUS over TLS authentication server

```
OS10(config)# radius-server host 1.2.4.5 tls security-profile radius-prof key radsec
OS10(config)# radius-server retransmit 10
OS10(config)# radius-server timeout 10
```

## AAA with TACACS+ authentication

Configure a TACACS+ authentication server by entering the server IP address or host name. You must also enter a text string for the key used to authenticate the OS10 switch on a TACACS+ host. The Transmission Control Protocol (TCP) port entry is optional.

TACACS+ provides greater data security by encrypting the entire protocol portion in a packet sent from the switch to an authentication server. RADIUS encrypts only passwords.



- Configure a TACACS+ authentication server in CONFIGURATION mode. By default, a TACACS+ server uses TCP port 49 for authentication.

```
tacacs-server host {hostname | ip-address} key {0 authentication-key | 9
authentication-key | authentication-key} [auth-port port-number]
```

Re-enter the `tacacs-server host` command multiple times to configure more than one TACACS+ server. If you configure multiple TACACS+ servers, OS10 attempts to connect in the order you configured them. An OS10 switch connects with the configured TACACS+ servers one at a time, until a TACACS+ server responds with an accept or reject response.

Configure a global timeout setting allowed on TACACS+ servers. By default, OS10 times out after five seconds. No source interface is configured. The default VRF instance is used to contact TACACS+ servers.

**i** **NOTE:** You cannot configure both a nondefault VRF instance and a source interface at the same time for TACACS+ authentication.

**i** **NOTE:** A TACACS+ server configured with a host name is not supported on a nondefault VRF.

- Configure the global timeout used to wait for an authentication response from TACACS+ servers in CONFIGURATION mode, from 1 to 1000 seconds; the default is 5.

```
tacacs-server timeout seconds
```

- (Optional) Specify an interface whose IP address is used as the source IP address for user authentication with a TACACS+ server in CONFIGURATION mode. By default, no source interface is configured. OS10 selects the source IP address of any interface from which a packet is sent to a TACACS+ server.

**i** **NOTE:** If you configure a source interface which has no IP address, the IP address of the management interface is used.

```
ip tacacs source-interface interface
```

- (Optional) By default, the switch uses the default VRF instance to communicate with TACACS+ servers. You can optionally configure a non-default or the management VRF instance for TACACS+ authentication in CONFIGURATION mode.

```
tacacs-server vrf management
tacacs-server vrf vrf-name
```

### Configure TACACS+ server

```
OS10(config)# tacacs-server host 1.2.4.5 key mysecret
OS10(config)# ip tacacs source-interface loopback 2
```

### Configure TACACS+ server for non-default VRFs

```
OS10(config)# ip vrf blue
OS10(conf-vrf)# exit
OS10(config)# tacacs-server vrf blue
```

### View TACACS+ server configuration

```
OS10# show running-configuration
...
tacacs-server host 1.2.4.5 key 9
3a95c26b2a5b96a6b80036839f296babe03560f4b0b7220d6454b3e71bdfc59b
ip tacacs source-interface loopback 2
...
```

### Delete TACACS+ server

```
OS10# no tacacs-server host 1.2.4.5
```

## TACACS as Primary Authentication

The AAA authentication configuration must be present as one of the authentication methods. The following error message is displayed when you attempt to configure AAA authentication without first configuring the local authentication method:

```
% Error: local authentication not configured
```

After upgrading to 10.5.1 from an earlier release, there is no change in the AAA authentication configuration when this configuration has the local authentication method configured. After upgrading to 10.5.1 in MX-series platforms, the local authentication method is appended to the authentication list when local authentication is not configured.

## Configure authorization

AAA command authorization controls user access to a set of commands assigned to users and is performed after user authentication. When enabled, AAA authorization checks a remote authorization server for each command that a user enters on the switch. If the commands that are entered by the user are configured in the remote server for that user, the remote server authorizes the usage of the command.

By default, the role you configure with the `username password role` command sets the level of CLI commands that a user can access.

An OS10 switch uses a list of authorization methods and the sequence in which they apply to determine the level of command authorization granted to a user. You can configure authorization methods with the `aaa authorization` command. By default, OS10 uses only the `local` authorization method. You can also configure TACACS+ server-based authorization.

The authorization methods in the method list execute in the order you configure them. Re-enter the methods to change the order. The `local` authorization method remains enabled even if you remove all configured methods in the list using the `no aaa authorization` command.

- Enable authorization and configure the authorization methods for CLI access in CONFIGURATION mode. Re-enter the command to configure additional authorization methods and CLI access.

```
aaa authorization {commands | config-commands | exec-commands} {role user-role}
{console | default} {[local] [group tacacs+]}
```

- `commands` — Configure authorization for all CLI commands, including all EXEC and configuration commands.
- `config-commands` — Configure authorization only for configuration commands.
- `exec-commands` — Configure authorization only for EXEC commands.
- `role user-role` — Configure command authorization for a user role: `sysadmin`, `secadmin`, `netadmin`, or `netoperator`.
- `console` — Configure authorization for console-entered commands.
- `default` — Configure authorization for non-console-entered commands and commands entered in non-console sessions, such as in SSH and VTY.
- `local` — Use the local username, password, and role entries configured with the `username password role` command for command authorization.
- `group tacacs+` — Use the TACACS+ servers configured with the `tacacs-server host` command for command authorization.

 **NOTE:** Custom user roles are supported, but the custom privilege levels are not supported. The default privilege level based on the user role is assigned.

For detailed information about how to configure vendor-specific attributes on a security server, see the respective RADIUS or TACACS+ server documentation.

### Examples: AAA authorization

- All commands entered from a console session with the `sysadmin` user role are authorized using configured TACACS+ servers first, and local user credentials next, if TACACS+ servers are not reachable or configured.

```
OS10(config)# aaa authorization commands role sysadmin console group tacacs+ local
```

- All configuration commands entered from a non-console session with the `sysadmin` user role are authorized using the configured TACACS+ servers.

```
OS10(config)# aaa authorization config-commands role sysadmin default group tacacs+
```

### Remove AAA authorization methods

```
OS10(config)# no aaa authorization commands role sysadmin console
```

## Enable AAA accounting

To record information about all user-entered commands, use the AAA accounting feature — not supported for RADIUS accounting. AAA accounting records login and command information in OS10 sessions on console connections using the `console` option and remote connections using the `default` option, such as Telnet and SSH.

AAA accounting sends accounting messages:

- Sends a start notice when a process begins, and a stop notice when the process ends using the `start-stop` option
- Sends only a stop notice when a process ends using the `stop-only` option
- No accounting notices are sent using the `none` option
- Logs all accounting notices in syslog using the `logging` option
- Logs all accounting notices on configured TACACS+ servers using the `group tacacs+` option

### Enable AAA accounting

- Enable AAA accounting in CONFIGURATION mode.

```
aaa accounting commands all {console | default} {start-stop | stop-only | none}
[logging] [group tacacs+]
```

The `no` version of this command disables AAA accounting.

### Example

The following example enables AAA accounting for all commands on the console. And also enables the system to send a start notice when a process begins, and a stop notice when the process ends to the console and a TACACS+ server.

```
OS10(config)# aaa accounting commands all console start-stop logging group tacacs+
```

## AAA commands

### aaa accounting

Enables AAA accounting.

|                          |                                                                                                                                                                                                                                                                                                                                                                                                                                                                                                                                                                                                                                                                                                                                                                                                                                                                                                                                                                                                                        |
|--------------------------|------------------------------------------------------------------------------------------------------------------------------------------------------------------------------------------------------------------------------------------------------------------------------------------------------------------------------------------------------------------------------------------------------------------------------------------------------------------------------------------------------------------------------------------------------------------------------------------------------------------------------------------------------------------------------------------------------------------------------------------------------------------------------------------------------------------------------------------------------------------------------------------------------------------------------------------------------------------------------------------------------------------------|
| <b>Syntax</b>            | <code>aaa accounting exec commands all {console   default} {start-stop   stop-only   none} [logging] [group tacacs+]</code>                                                                                                                                                                                                                                                                                                                                                                                                                                                                                                                                                                                                                                                                                                                                                                                                                                                                                            |
| <b>Parameters</b>        | <ul style="list-style-type: none"><li>• <code>exec</code> — Record user authentication events.</li><li>• <code>commands all</code> — Record all user-entered commands. RADIUS accounting does not support this option.</li><li>• <code>console</code> — Record all user authentication and logins or all user-entered commands in OS10 sessions on console connections.</li><li>• <code>default</code> — Record all user authentication and logins or all user-entered commands in OS10 sessions on remote connections; for example, Telnet and SSH.</li><li>• <code>start-stop</code> — Send a start notice when a process begins, and a stop notice when the process ends.</li><li>• <code>stop-only</code> — Send only a stop notice when a process ends.</li><li>• <code>none</code> — No accounting notices are sent.</li><li>• <code>logging</code> — Logs all accounting notices in syslog.</li><li>• <code>group tacacs+</code> — Logs all accounting notices on the first reachable TACACS+ server.</li></ul> |
| <b>Default</b>           | AAA accounting is disabled.                                                                                                                                                                                                                                                                                                                                                                                                                                                                                                                                                                                                                                                                                                                                                                                                                                                                                                                                                                                            |
| <b>Command Mode</b>      | CONFIGURATION                                                                                                                                                                                                                                                                                                                                                                                                                                                                                                                                                                                                                                                                                                                                                                                                                                                                                                                                                                                                          |
| <b>Usage Information</b> | <p>You can enable the recording of accounting events in both the syslog and on TACACS+ servers.</p> <p>Supported on the MX9116n and MX5108n switches in Full Switch mode starting in release 10.4.1.0. Also supported in SmartFabric mode starting in release 10.5.0.1.</p> <p>The <code>no</code> version of the command disables AAA accounting.</p>                                                                                                                                                                                                                                                                                                                                                                                                                                                                                                                                                                                                                                                                 |

## Example

```
OS10(config)# aaa accounting commands all console start-stop logging
group tacacs+
```

## Supported Releases

10.4.1.0 or later

## aaa authentication login

Configures the AAA authentication method for console, SSH, and Telnet logins.

### Syntax

```
aaa authentication login {console | default} {local | group radius | group
tacacs+}
```

### Parameters

- `console` — Configure authentication methods for console logins.
- `default` — Configure authentication methods for SSH and Telnet logins.
- `local` — Use the local username, password, and role entries configured with the `username password role` command.
- `group radius` — Use the RADIUS servers configured with the `radius-server host` command.
- `group tacacs+` — Use the TACACS+ servers configured with the `tacacs-server host` command.

### Default

Local authentication

### Command Mode

CONFIGURATION

### Usage Information

 **NOTE:** If you configure multiple authentication methods on Dell EMC PowerEdge MX7000 Ethernet modules such as MX9116n Fabric Switching Engine and MX5108n Ethernet Switch, operating in SmartFabric mode, you must configure local authentication as the first method in the list.

Supported on the MX9116n and MX5108n switches in Full Switch mode starting in release 10.4.1.0. Also supported in SmartFabric mode starting in release 10.5.0.1.

The `no` version of this command removes all configured authentication methods and defaults to using local authentication.

## Example

```
OS10(config)# aaa authentication login default group radius local
OS10(config)# do show running-configuration aaa
aaa authentication login default group radius local
aaa authentication login console local
```

```
OS10(config)# no aaa authentication login default
OS10(config)# do show running-configuration aaa
aaa authentication login default local
aaa authentication login console local
```

## Supported Releases

10.4.1.0 or later

## aaa authorization

Enables authorization and configure the authorization methods for CLI access.

### Syntax

```
aaa authorization {commands | config-commands | exec-commands} {role user-
role} {console | default} {[local] [group tacacs+]}
```

### Parameters

- `commands` — Configure authorization for all CLI commands, including all EXEC and configuration commands.
- `config-commands` — Configure authorization only for configuration commands.
- `exec-commands` — Configure authorization only for EXEC commands.
- `role user-role` — Configure command authorization for a user role: `sysadmin`, `secadmin`, `netadmin`, or `netoperator`.

- `console` — Configure authorization for console-entered commands.
- `default` — Configure authorization for non-console-entered commands and commands entered in non-console sessions, such as in SSH and VTY.
- `local` — Use the local username, password, and role entries configured with the `username password role` command for command authorization.
- `group tacacs+` — Use the TACACS+ servers configured with the `tacacs-server host` command for command authorization.

**Default** Local authorization

**Command Mode** • CONFIGURATION

**Usage Information** Re-enter the command to configure additional authorization methods and CLI access. The authorization methods in the method list execute in the order you configure them. Re-enter the methods to change the order. The `local` authorization method remains enabled even if you remove all configured methods in the list using the `no aaa authorization` command.

If a console user logs in with TACACS+ authorization, the role you configured for the user on the TACACS+ server applies. If no role is configured on the security server, user authorization fails.

**Example**

```
OS10(config)# aaa authorization commands role sysadmin console group
tacacs+ local
```

```
OS10(config)# aaa authorization config-commands role sysadmin default
group tacacs+
```

```
OS10(config)# no aaa authorization commands role sysadmin console
```

**Supported Releases** 10.5.1 or later

## aaa re-authenticate enable

Requires user re-authentication after a change in the authentication method or server.

**Syntax** `aaa re-authenticate enable`

**Parameters** None

**Default** Disabled

**Command Mode** EXEC

**Usage Information** After you enable user re-authentication and change the authentication method or server, users are logged out of the switch and prompted to log in again to re-authenticate. User re-authentication is triggered by:

- Adding or removing a RADIUS server as a configured server host with the `radius-server host` command.
- Adding or removing an authentication method with the `aaa authentication [local | radius]` command.

Supported on the MX9116n and MX5108n switches in Full Switch mode starting in release 10.4.0E(R3S). Also supported in SmartFabric mode starting in release 10.5.0.1.

The `no` version of the command disables user re-authentication.

**Example**

```
OS10(config)# aaa re-authenticate enable
```

**Supported Releases** 10.4.0E(R1) or later

## tacacs-server host

Configures a TACACS+ server and the key used to authenticate the switch on the server.

|                           |                                                                                                                                                                                                                                                                                                                                                                                                                                                                                                                                                                                                                                                                                                                                                                                                                                                  |
|---------------------------|--------------------------------------------------------------------------------------------------------------------------------------------------------------------------------------------------------------------------------------------------------------------------------------------------------------------------------------------------------------------------------------------------------------------------------------------------------------------------------------------------------------------------------------------------------------------------------------------------------------------------------------------------------------------------------------------------------------------------------------------------------------------------------------------------------------------------------------------------|
| <b>Syntax</b>             | <code>tacacs-server host {hostname   ip-address} key {0 authentication-key   9 authentication-key   authentication-key} [auth-port port-number]</code>                                                                                                                                                                                                                                                                                                                                                                                                                                                                                                                                                                                                                                                                                           |
| <b>Parameters</b>         | <ul style="list-style-type: none"><li>• <code>hostname</code> — Enter the host name of the TACACS+ server.</li><li>• <code>ip-address</code> — Enter the IPv4 (A.B.C.D) or IPv6 (x:x:x::x) address of the TACACS+ server.</li><li>• <code>key 0 authentication-key</code> — Enter an authentication key in plain text. A maximum of 42 characters.</li><li>• <code>key 9 authentication-key</code> — Enter an authentication key in encrypted format with a maximum of 128 characters.</li><li>• <code>authentication-key</code> — Enter an authentication in plain text with a maximum of 42 characters. It is not necessary to enter 0 before the key.</li><li>• <code>key authentication-key</code> — Enter a text string for the encryption key used to authenticate the switch on the TACACS+ server. A maximum of 42 characters.</li></ul> |
| <b>Default</b>            | Not configured                                                                                                                                                                                                                                                                                                                                                                                                                                                                                                                                                                                                                                                                                                                                                                                                                                   |
| <b>Command Mode</b>       | CONFIGURATION                                                                                                                                                                                                                                                                                                                                                                                                                                                                                                                                                                                                                                                                                                                                                                                                                                    |
| <b>Usage Information</b>  | <p>The authentication key must match the key configured on the TACACS+ server. You cannot enter spaces in the key. The <code>show running-configuration</code> output displays both unencrypted and encrypted keys in encrypted format. Configure the global timeout allowed for authentication requests on TACACS+ servers using the <code>tacacs-server timeout</code> command. By default, OS10 times out an authentication attempt on a TACACS+ server after five seconds.</p> <p>Supported on the MX9116n and MX5108n switches in Full Switch mode starting in release 10.4.0E(R3S). Also supported in SmartFabric mode starting in release 10.5.0.1.</p> <p>The <code>no</code> version of this command removes a TACACS+ server configuration.</p>                                                                                        |
| <b>Example</b>            | <pre>OS10(config)# tacacs-server host 1.5.6.4 key secret1</pre>                                                                                                                                                                                                                                                                                                                                                                                                                                                                                                                                                                                                                                                                                                                                                                                  |
| <b>Supported Releases</b> | 10.4.0E(R2) or later                                                                                                                                                                                                                                                                                                                                                                                                                                                                                                                                                                                                                                                                                                                                                                                                                             |

## tacacs-server timeout

Configures the global timeout used for authentication attempts on TACACS+ servers.

|                           |                                                                                                                                                                                                                                                                                  |
|---------------------------|----------------------------------------------------------------------------------------------------------------------------------------------------------------------------------------------------------------------------------------------------------------------------------|
| <b>Syntax</b>             | <code>tacacs-server timeout seconds</code>                                                                                                                                                                                                                                       |
| <b>Parameters</b>         | <code>seconds</code> — Enter the timeout period used to wait for an authentication response from a TACACS+ server, from 1 to 1000 seconds.                                                                                                                                       |
| <b>Default</b>            | 5 seconds                                                                                                                                                                                                                                                                        |
| <b>Command Mode</b>       | CONFIGURATION                                                                                                                                                                                                                                                                    |
| <b>Usage Information</b>  | <p>Supported on the MX9116n and MX5108n switches in Full Switch mode starting in release 10.4.0E(R3S). Also supported in SmartFabric mode starting in release 10.5.0.1.</p> <p>The <code>no</code> version of this command resets the TACACS+ server timeout to the default.</p> |
| <b>Example</b>            | <pre>OS10(config)# tacacs-server timeout 360</pre>                                                                                                                                                                                                                               |
| <b>Supported Releases</b> | 10.4.0E(R2) or later                                                                                                                                                                                                                                                             |

## radius-server host

Configures a RADIUS server and the key used to authenticate the switch on the server.

|                           |                                                                                                                                                                                                                                                                                                                                                                                                                                                                                                                                                                                                                                                                                                                                                                                                                    |
|---------------------------|--------------------------------------------------------------------------------------------------------------------------------------------------------------------------------------------------------------------------------------------------------------------------------------------------------------------------------------------------------------------------------------------------------------------------------------------------------------------------------------------------------------------------------------------------------------------------------------------------------------------------------------------------------------------------------------------------------------------------------------------------------------------------------------------------------------------|
| <b>Syntax</b>             | <code>radius-server host {hostname   ip-address} key {0 authentication-key   9 authentication-key   authentication-key} [auth-port port-number]</code>                                                                                                                                                                                                                                                                                                                                                                                                                                                                                                                                                                                                                                                             |
| <b>Parameters</b>         | <ul style="list-style-type: none"><li>• <code>hostname</code> — Enter the host name of the RADIUS server.</li><li>• <code>ip-address</code> — Enter the IPv4 (A.B.C.D) or IPv6 (x:x:x::x) address of the RADIUS server.</li><li>• <code>key 0 authentication-key</code> — Enter an authentication key in plain text. A maximum of 42 characters.</li><li>• <code>key 9 authentication-key</code> — Enter an authentication key in encrypted format. A maximum of 128 characters.</li><li>• <code>authentication-key</code> — Enter an authentication in plain text. A maximum of 42 characters. It is not necessary to enter 0 before the key.</li><li>• <code>auth-port port-number</code> — (Optional) Enter the UDP port number used on the server for authentication, from 1 to 65535, default 1812.</li></ul> |
| <b>Default</b>            | Not configured                                                                                                                                                                                                                                                                                                                                                                                                                                                                                                                                                                                                                                                                                                                                                                                                     |
| <b>Command Mode</b>       | CONFIGURATION                                                                                                                                                                                                                                                                                                                                                                                                                                                                                                                                                                                                                                                                                                                                                                                                      |
| <b>Usage Information</b>  | <p>The authentication key must match the key configured on the RADIUS server. You cannot enter spaces in the key. The <code>show running-configuration</code> output displays both unencrypted and encrypted keys in encrypted format. Configure global settings for the timeout and retransmit attempts allowed on RADIUS servers using the <code>radius-server retransmit</code> and <code>radius-server timeout</code> commands.</p> <p>Supported on the MX9116n and MX5108n switches in Full Switch mode starting in release 10.4.0E(R3S). Also supported in SmartFabric mode starting in release 10.5.0.1.</p> <p>The <code>no</code> version of this command removes a RADIUS server configuration.</p>                                                                                                      |
| <b>Example</b>            | <pre>OS10(config)# radius-server host 1.5.6.4 key secret1</pre>                                                                                                                                                                                                                                                                                                                                                                                                                                                                                                                                                                                                                                                                                                                                                    |
| <b>Supported Releases</b> | 10.2.0E or later                                                                                                                                                                                                                                                                                                                                                                                                                                                                                                                                                                                                                                                                                                                                                                                                   |

## radius-server host tls

Configures a RADIUS server for RADIUS over TLS user authentication and secure communication. For RADIUS over TLS authentication, the `radsec` shared key and a security profile that uses an X.509v3 certificate are required.

|                     |                                                                                                                                                                                                                                                                                                                                                                                                                                                                                                                                                                                                                                                                                                                                                                                                                                                                                                                                                                                                                                                                                                                                                                       |
|---------------------|-----------------------------------------------------------------------------------------------------------------------------------------------------------------------------------------------------------------------------------------------------------------------------------------------------------------------------------------------------------------------------------------------------------------------------------------------------------------------------------------------------------------------------------------------------------------------------------------------------------------------------------------------------------------------------------------------------------------------------------------------------------------------------------------------------------------------------------------------------------------------------------------------------------------------------------------------------------------------------------------------------------------------------------------------------------------------------------------------------------------------------------------------------------------------|
| <b>Syntax</b>       | <code>radius-server host {hostname   ip-address} tls security-profile profile-name [auth-port tcp-port-number] key {0 authentication-key   9 authentication-key   authentication-key}</code>                                                                                                                                                                                                                                                                                                                                                                                                                                                                                                                                                                                                                                                                                                                                                                                                                                                                                                                                                                          |
| <b>Parameters</b>   | <ul style="list-style-type: none"><li>• <code>hostname</code> — Enter the host name of the RADIUS server.</li><li>• <code>ip-address</code> — Enter the IPv4 (A.B.C.D) or IPv6 (x:x:x::x) address of the RADIUS server.</li><li>• <code>tls</code> — Enter <code>tls</code> to secure RADIUS server communication using the TLS protocol.</li><li>• <code>security-profile profile-name</code> — Enter the name of an X.509v3 security profile to use with RADIUS over TLS authentication. To configure a security profile for an OS10 application, see <a href="#">Security profiles</a>.</li><li>• <code>auth-port tcp-port-number</code> — (Optional) Enter the TCP port number that the server uses for authentication. The range is from 1 to 65535. The default is 2083.</li><li>• <code>key 0 authentication-key</code> — Enter the <code>radsec</code> shared key in plain text.</li><li>• <code>key 9 authentication-key</code> — Enter the <code>radsec</code> shared key in encrypted format.</li><li>• <code>authentication-key</code> — Enter the <code>radsec</code> shared key in plain text. It is not necessary to enter 0 before the key.</li></ul> |
| <b>Default</b>      | TCP port 2083 on a RADIUS server for RADIUS over TLS communication                                                                                                                                                                                                                                                                                                                                                                                                                                                                                                                                                                                                                                                                                                                                                                                                                                                                                                                                                                                                                                                                                                    |
| <b>Command Mode</b> | CONFIGURATION                                                                                                                                                                                                                                                                                                                                                                                                                                                                                                                                                                                                                                                                                                                                                                                                                                                                                                                                                                                                                                                                                                                                                         |

**Usage Information** For RADIUS over TLS authentication, configure the `radsec` shared key on the server and OS10 switch. The `show running-configuration` output displays both the unencrypted and encrypted key in encrypted format. Configure global settings for the timeout and retransmit attempts allowed on a RADIUS over TLS servers using the `radius-server retransmit` and `radius-server timeout` commands.

RADIUS over TLS authentication requires that X.509v3 PKI certificates are configured on a certification authority and installed on the switch. For more information, including a complete RADIUS over TLS example, see [X.509v3 certificates](#).

Supported on the MX9116n and MX5108n switches in Full Switch mode starting in release 10.4.3.0. Also supported in SmartFabric mode starting in release 10.5.0.1.

The `no` version of this command removes a RADIUS server from RADIUS over TLS communication.

#### Example

```
OS10(config)# radius-server host 1.5.6.4 tls security-profile radius-admin key radsec
```

**Supported Releases** 10.4.3.0 or later

## radius-server retransmit

Configures the number of authentication attempts allowed on RADIUS servers.

**Syntax** `radius-server retransmit retries`

**Parameters** *retries* — Enter the number of retry attempts, from 0 to 10.

**Default** An OS10 switch retransmits a RADIUS authentication request three times.

**Command Mode** CONFIGURATION

**Usage Information** Use this command to globally configure the number of retransmit attempts allowed for authentication requests on RADIUS servers.

Supported on the MX9116n and MX5108n switches in Full Switch mode starting in release 10.4.0E(R3S). Also supported in SmartFabric mode starting in release 10.5.0.1.

The `no` version of this command resets the value to the default.

#### Example

```
OS10(config)# radius-server retransmit 5
```

**Supported Releases** 10.2.0E or later

## radius-server timeout

Configures the timeout used to resend RADIUS authentication requests.

**Syntax** `radius-server timeout seconds`

**Parameters** *seconds* — Enter the time in seconds for retransmission, from 1 to 100.

**Default** An OS10 switch stops sending RADIUS authentication requests after five seconds.

**Command Mode** CONFIGURATION

**Usage Information** Use this command to globally configure the timeout value used on RADIUS servers.

Supported on the MX9116n and MX5108n switches in Full Switch mode starting in release 10.4.0E(R3S). Also supported in SmartFabric mode starting in release 10.5.0.1.

The `no` version of this command resets the value to the default.

#### Example

```
OS10(config)# radius-server timeout 90
```



**Supported Releases** 10.2.0E or later

## radius-server vrf

Configures the RADIUS server for the management or non-default VRF instance.

**Syntax** `radius-server vrf {management | vrf-name}`

**Parameters**

- `management` — Enter the keyword to configure the RADIUS server for the management VRF instance.
- `vrf-name` — Enter the keyword then the name of the VRF to configure the RADIUS server for that non-default VRF instance.

**Defaults** Not configured

**Command Mode** CONFIGURATION

**Usage Information** Use this command to associate RADIUS servers with a VRF. If you do not configure a VRF on the RADIUS server list, the servers are on the default VRF. RADIUS server lists and VRFs have one-to-one mapping. The `no` version of this command removes the RADIUS server from the management VRF instance.

### Example

```
OS10(config)# radius-server vrf management
OS10(config)# radius-server vrf blue
```

**Supported Releases** 10.4.0E(R1) or later

## tacacs-server vrf

Creates an association between a TACACS server group and a VRF and source interface.

**Syntax** `tacacs-server vrf {management | vrf-name}`

**Parameters**

- `management` — Enter the keyword to associate TACACS servers to the management VRF instance. This option restricts the TACACS server association to the management VRF only.
- `vrf-name` — Enter the keyword then the name of the VRF to associate TACACS servers with that VRF.

**Defaults** None.

**Command Mode** CONFIGURATION

**Usage Information** Use this command to associate TACACS servers with a VRF instance. If you do not configure a VRF in the TACACS server list, the servers are on the default VRF instance. TACACS server lists and VRFs have one-to-one mapping. When you remove the VRF instance, the TACACS server lists are also removed automatically.

The `no` version of this command resets the value to the default.

### Example

```
[no] tacacs-server management
[no] tacacs-server vrf red
```

**Supported Releases** 10.4.3.0E or later

## ip radius source-interface

Specifies the interface whose IP address is used as the source IP address for user authentication with a RADIUS server.

**Syntax** `ip radius source-interface interface`

|                           |                                                                                                                                                                                                                                                                                                                                                                                                                                                                                                 |
|---------------------------|-------------------------------------------------------------------------------------------------------------------------------------------------------------------------------------------------------------------------------------------------------------------------------------------------------------------------------------------------------------------------------------------------------------------------------------------------------------------------------------------------|
| <b>Parameters</b>         | <p><i>interface:</i></p> <ul style="list-style-type: none"> <li>• <code>ethernet node/slot/port[:subport]</code> — Enter a physical Ethernet interface.</li> <li>• <code>loopback number</code> — Enter a Loopback interface, from 0 to 16383.</li> <li>• <code>mgmt 1/1/1</code> — Enter the management interface.</li> <li>• <code>port-channel channel-id</code> — Enter a port-channel ID, from 1 to 28.</li> <li>• <code>vlan vlan-id</code> — Enter a VLAN ID, from 1 to 4093.</li> </ul> |
| <b>Default</b>            | Not configured.                                                                                                                                                                                                                                                                                                                                                                                                                                                                                 |
| <b>Command Mode</b>       | CONFIGURATION                                                                                                                                                                                                                                                                                                                                                                                                                                                                                   |
| <b>Usage Information</b>  | By default, no source interface is configured. OS10 selects the source IP address as the IP address of the interface from which a packet is sent to the RADIUS server. The <code>no</code> version of this command removes the configured source interface.                                                                                                                                                                                                                                     |
| <b>Example</b>            | <pre>OS10(config)# ip radius source-interface ethernet 1/1/10</pre>                                                                                                                                                                                                                                                                                                                                                                                                                             |
| <b>Supported Releases</b> | 10.4.3.1 or later                                                                                                                                                                                                                                                                                                                                                                                                                                                                               |

## ip tacacs source-interface

Specifies the interface whose IP address is used as the source IP address for user authentication with a TACACS+ server.

|                           |                                                                                                                                                                                                                                                                                                                                                                                                                                                                                                 |
|---------------------------|-------------------------------------------------------------------------------------------------------------------------------------------------------------------------------------------------------------------------------------------------------------------------------------------------------------------------------------------------------------------------------------------------------------------------------------------------------------------------------------------------|
| <b>Syntax</b>             | <code>ip tacacs source-interface interface</code>                                                                                                                                                                                                                                                                                                                                                                                                                                               |
| <b>Parameters</b>         | <p><i>interface:</i></p> <ul style="list-style-type: none"> <li>• <code>ethernet node/slot/port[:subport]</code> — Enter a physical Ethernet interface.</li> <li>• <code>loopback number</code> — Enter a Loopback interface, from 0 to 16383.</li> <li>• <code>mgmt 1/1/1</code> — Enter the management interface.</li> <li>• <code>port-channel channel-id</code> — Enter a port-channel ID, from 1 to 28.</li> <li>• <code>vlan vlan-id</code> — Enter a VLAN ID, from 1 to 4093.</li> </ul> |
| <b>Default</b>            | Not configured.                                                                                                                                                                                                                                                                                                                                                                                                                                                                                 |
| <b>Command Mode</b>       | CONFIGURATION                                                                                                                                                                                                                                                                                                                                                                                                                                                                                   |
| <b>Usage Information</b>  | By default, no source interface is configured. OS10 selects the source IP address as the IP address of the interface from which a packet is sent to the TACACS+ server. The <code>no</code> version of this command removes the configured source interface.                                                                                                                                                                                                                                    |
| <b>Example</b>            | <pre>OS10(config)# ip tacacs source-interface ethernet 1/1/10</pre>                                                                                                                                                                                                                                                                                                                                                                                                                             |
| <b>Supported Releases</b> | 10.4.1.0 or later                                                                                                                                                                                                                                                                                                                                                                                                                                                                               |

## Boot security

OS10 protects boot operation by allowing you to add GRUB password and image integrity validation.

### Bootloader protection

To prevent unauthorized users with malicious intent from accessing your switch, protect the bootloader using a GRUB password. OS10 allows you to enable, disable, and view bootloader protection.

This feature is available only for the `sysadmin` and `secadmin` roles.

**NOTE:** When you enable bootloader protection, keep a copy of a configured user name and password. You cannot access the switch without configured credentials.

- Enable bootloader protection in EXEC mode. Use the `boot protect enable` command to configure a username and password. You can configure up to three users per switch.

```
OS10# boot protect enable username root password calvin
```

Disable bootloader protection for a specified user by using the `boot protect disable` command.

### Enable bootloader protection

```
OS10# boot protect enable username root password calvin
```

### Disable bootloader protection

```
OS10# boot protect disable username root
```

### Display bootloader protection

```
OS10# show boot protect
Boot protection enabled
Authorized users: root linuxadmin admin
```

## Secure Boot

OS10 secure boot verifies the authenticity and integrity of the OS10 image. Secure boot protects a system from malicious code being loaded and executed during the boot process.

Using secure boot, you can validate the OS10 image during installation and on demand at any time.

Secure boot:

- prevents the OS10 software, including the kernel and system files, from being compromised during the boot operation
- verifies the new digital image signature before installation
- protects and validates the startup configuration file at startup

OS10 checks the validity of the OS10 image before you install or upgrade your system:

- To check the validity of the OS10 image before you upgrade, see [Validate and upgrade OS10 image](#).
- To check the validity of the OS10 image before you install it, see [Validate OS10 image before manual installation from ONIE](#).

If you have already installed Release 10.5.1.0 or later, to enable secure boot, see [Enable secure boot](#).

### Enable secure boot

Enabling the secure boot feature prevents the OS10 software (kernel and system binaries) from being compromised during the boot operation.

Secure boot is disabled by default. To enable secure boot, use the `secure-boot enable` command or [RESTCONF API](#).

OS10 stores the kernel signatures and system-file hashes internally. When you enable secure boot, OS10 uses the signatures and hashes to validate the binaries during the next and future reboots.

OS10 has two images, A and B. One image is active, which is the current running version and used as the running software at the next system reload. The other image remains standby, used for software upgrades.

You can use the `secure-boot verify` command to validate the kernel, system binaries, and startup configuration file for both the installed images at any time.

```
secure-boot verify {kernel | file-system-integrity | startup-config}
```

After a switch reboot:

- If kernel binary file validation fails, OS10 returns to the GRUB menu. The system returns to the GRUB menu when the kernel binary, kernel signature file, or both have been compromised. To load OS10, reboot your system using the other OS10 image. After OS10 loads, reinstall the OS10 image to replace the invalid image.
- If the OS10 system binary file validation fails, the OS10 image loads only in EXEC mode. Configuration mode is blocked. You can reboot your system using the other OS10 image and replace the invalid image with a valid OS10 image.
- If both the installed OS10 images are compromised, you must install a new image using ONIE. For more information, see [Installation using ONIE](#).

- If the validation of the kernel and OS10 system binary files succeeds, OS10 loads successfully.

**i NOTE:** If you are installing OS10 image using zero touch deployment (ZTD):

- Secure boot is disabled after ZTD reloads the switch.
- ZTD cannot validate the image with Dell public key (PKI/sha256/GPG keys) and hence cannot perform secure installation of the OS10 image. However, if secure boot configuration is present in the ZTD configuration file, it is applied and the following secure boot features are available after installation:
  - Kernel validation during reboot
  - OS10 system binary files validation during reboot
  - Startup configuration file protection
  - All secure boot CLI commands are available

After the switch reboots, the system applies the protected version of the startup configuration. If a protected version of the startup configuration file is not available, the system applies the default configuration. You can check the status of the secure boot operation using the `show secure-boot status` and `show secure boot file-integrity-status` commands. The `show` command output displays the combined status of various secure boot features, including:

- Was secure boot used for the last reboot?
- Is secure boot enabled?
- Is the startup configuration protected?
- Were any OS10 binary files added, modified, or deleted?

```
OS10# show secure-boot status
Last boot was via secure boot : yes
Secure boot configured : yes
Latest startup config protected: yes
```

```
OS10# show secure-boot file-integrity-status
File Integrity Status: OK
```

### Protect the startup configuration file

Protecting the startup configuration file saves a copy of the current startup configuration file internally. During switch boot up, the protected version of the startup configuration is loaded.

If you make OS10 configuration changes and save them to the startup configuration, protect the current startup configuration file by using the `secureboot protect startup-config` command. This command is supported in the `sysadmin`, `secadmin`, and `netadmin` roles.

When you enable secure boot and you try to save configuration changes using the `write memory` command, a warning message prompts you to first protect the startup configuration file:

```
Configuration has changed and secure boot is enabled. The protection of the
configuration needs to be updated prior to reboot.
```

If you reboot the system using the `reload` command and either the startup configuration is not protected or there are unsaved changes in the protected startup configuration, the warning message is displayed. The system reboot is not performed until you protect the current startup configuration file using the `secureboot protect startup-config` command.

If you reboot the system using a non-CLI method, such as power cycling, the last protected startup configuration is loaded. Any unsaved changes to the current startup configuration are lost. If the startup configuration is not protected, the default startup configuration settings are loaded.

Use the `secure-boot verify startup configuration` command to check if the current configuration is protected.

```
secure-boot verify startup-config
```

## Validate OS10 image file on demand

You can validate an OS10 image file at any time using the `image verify` command in EXEC mode.

OS10 verifies the signature of the image files using hash-based authentication, GNU privacy guard (Gn uPG or GPG)-based signatures, or digital signatures (PKI-signed).

```
image verify image://PKGS_OS10-Enterprise-10.4.9999EX.3342stretch-installer-x86_64.bin
pki signature tftp://10.16.127.7/users/PKGS_OS10-Enterprise-10.4.9999EX.3342stretch-
installer-x86_64.bin.sha256.base64 public-key tftp://10.16.127.7/users/DellOS10.cert.pem
```

The image package that is verified consists of:

- PKGS\_OS10-Enterprise-10.4.9999EX.3342stretch-installer-x86\_64.bin—OS10 image binary
- PKGS\_OS10-Enterprise-10.4.9999EX.3342stretch-installer-x86\_64.bin.sha256.base64—PKI signature of the OS10 image binary
- PKGS\_OS10-Enterprise-10.4.9999EX.3342stretch-installer-x86\_64.bin.sha256—The sha256 hash of the OS10 image binary
- PKGS\_OS10-Enterprise-10.4.9999EX.3342stretch-installer-x86\_64.bin.gpg—GNU privacy guard (GnuPG or GPG) signature of the OS10 image binary
- DellOS10.cert.pem—Dell public key certificate

## Validate the OS10 kernel, system binaries, and startup configuration file

You can validate the OS10 kernel binary image, system binary files, and startup configuration file at system startup and CLI execution using the `secure-boot verify` command in EXEC mode.

```
OS10# secure-boot verify {kernel | file-system-integrity | startup-config}
```

## Validate and upgrade OS10 image

You can validate and upgrade the OS10 installer image files with digital signatures using the `image secure-install` command in EXEC mode.

```
OS10# image secure-install image-filepath {sha256 signature signature-filepath | gpg
signature signature-filepath | pki signature signature-filepath public-key key-file}
```

The OS10 image installer verifies the signature of the image files using hash-based authentication, GNU privacy guard (Gn uPG or GPG)-based signatures, or digital signatures (PKI-signed). Upgraded image files are installed after they are successfully validated.

### NOTE:

- When secure boot is enabled and you install an OS10 image upgrade, the `image install` command is disabled. Use the `image secure-install` command instead. For more information, see [Install OS10 upgrade](#).
- If secure boot is not enabled, you can validate an OS10 image using PKI after you manually install the image by using the `image verify` command. PKI image validation occurs only once during the installation, not during each reload. After you manually install the image using the `image install` command, the image is extracted. The original binary image is not stored in the system.

## Validate OS10 image before manual installation from ONIE

When you manually install an OS10 image using ONIE, you can validate the image using hash-based authentication (sha256) or digital certificates (PKI-signed).

The signature for the OS10 installer image is provided with the downloaded OS10 .tar file. You can extract the OS10 binary file image from the .tar file and install it from a local server. For more information, see [Download OS10 image](#) and [Installation using ONIE](#).

To validate and install an image using the X.509v3 certificate and OS10 image signature, use the `onie-nos-install` command during a manual installation. For more information, see [Manual installation](#); for example:

```
$ onie-nos-install image_url pki signature_filepath certificate_filepath
```

Or

```
$ onie-nos-install image_url sha256 signature_filepath
```

The OS10 image installer verifies the signature of the image files using hash-based authentication or digital signatures (PKI-signed). The image files are installed after they are successfully validated.

### View certificate information

Use the `show secure-boot pki-certificates` command in EXEC mode to view the certificate information.

When working with CA certificates, view the certificate information using the `show secure-boot pki-certificates` command in EXEC mode.

```
OS10# show secure-boot pki-certificates
Certificate Key Id : 123
Version Number : 3 (0x2)
Serial Number : 17154672033164819608 (0xee11a353271dfc98)
Signature Algorithm : sha256WithRSAEncryption
Issuer : C=IN, ST=Some-State, L=some-city, O=Internet Widgits Pty Ltd
Validity : Aug 1 11:45:39 2019 GMT - Jul 31 11:45:39 2020 GMT

Certificate Key Id : 124
Version Number : 3 (0x2)
Serial Number : 17154672033164819608 (0xee11a353271dfc98)
Signature Algorithm : sha256WithRSAEncryption
Issuer : C=IN, ST=Some-State, L=some-city, O=Internet Widgits Pty Ltd
Validity : Aug 1 11:45:39 2019 GMT - Jul 31 11:45:39 2020 GMT
```

### Revoke an installed key

If either the public key or private key used in CA certificates is compromised, revoke the key by using the `revoke key` command in EXEC mode.

For `key-id`, enter the local file path where the downloaded or locally generated private key is stored.

```
OS10# revoke key key-id
```

The key is moved to the Revoked state.

## Recover from image validation failures

This section explains how to recover from image validation failures and provides the recovery steps for the various failure scenarios.

Secure boot validates both the installed images. If validation fails for one of the images, you can install the other image. If validation fails for both the images, reinstall the OS10 image from ONIE.

### OS10 kernel validation fails for one installed OS10 image

If kernel validation fails, the system enters GRUB mode. To recover from this validation failure:

1. Select the other installed OS10 image from the GRUB menu.
2. Reboot the system using the other installed OS10 image.
3. Replace the invalid OS10 image with a valid image using the `image secure-install` command.

```
OS10# image secure-install image://PKGS_OS10-Enterprise-10.4.9999EX.3342stretch-
installer-x86_64.bin pki signature tftp://10.16.127.7/users/PKGS_OS10-
Enterprise-10.4.9999EX.3342stretch-installer-x86_64.bin.sha256.base64 public-key
tftp://10.16.127.7/users/DellOS10.cert.pem
```

### OS10 kernel validation fails for both installed OS10 images

If kernel validation fails for both installed images, the system enters GRUB mode. Use the `secure-boot verify kernel` command to check the kernel validation status. To recover from this validation failure:

1. Boot into ONIE.
2. Install a valid OS10 image using the `onie-nos-install` command. For more information, see [Installation using ONIE](#).

### OS10 system binary validation fails for one installed OS10 image

If the system binary validation fails for one of the installed images, you can log into OS10 CLI EXEC mode. You cannot access CONFIGURATION mode. The following log message appears when you use the `show logging log-file` command:

```
Dell EMC (OS10) %SECURE_BOOT: OS10 sytem file integrity failed. OS10 image needs to be
reinstalled.
```

To recover from this validation failure:

1. Reload the system using the `reload` command.
2. Select the other installed image from the GRUB menu and load that image.
3. Reboot the system using the other installed OS10 image.
4. Replace the invalid OS10 image with a valid image using the `image secure-install` command.

```
OS10# image secure-install image://PKGS_OS10-Enterprise-10.4.9999EX.3342stretch-
installer-x86_64.bin pki signature tftp://10.16.127.7/users/PKGS_OS10-
Enterprise-10.4.9999EX.3342stretch-installer-x86_64.bin.sha256.base64 public-key
tftp://10.16.127.7/users/DellOS10.cert.pem
```

### OS10 system binary validation fails for both installed OS10 images

If the system binary validation fails for one of the installed images, the system allows you to log into OS10 CLI EXEC mode. You cannot access CONFIGURATION mode. The following log message appears when you use the `show logging log-file` command:

```
Dell EMC (OS10) %SECURE_BOOT: OS10 sytem file integrity failed. OS10 image needs to be
reinstalled.
```

To recover from this validation failure:

1. Boot into ONIE.
2. Install a valid OS10 image using the `onie-nos-install` command. For more information, see [Installation using ONIE](#).

## Boot security commands

### boot protect disable username

Allows you to disable bootloader protection.

|                           |                                                                                                                            |
|---------------------------|----------------------------------------------------------------------------------------------------------------------------|
| <b>Syntax</b>             | <code>boot protect disable username <i>username</i></code>                                                                 |
| <b>Parameters</b>         | <ul style="list-style-type: none"> <li>• <i>username</i> - Enter the username to disable bootloader protection.</li> </ul> |
| <b>Default</b>            | Disabled                                                                                                                   |
| <b>Command Mode</b>       | EXEC                                                                                                                       |
| <b>Usage Information</b>  | You can disable bootloader protection for each individual user.                                                            |
| <b>Example</b>            | <pre>OS10# boot protect disable username root</pre>                                                                        |
| <b>Supported Releases</b> | 10.4.3.0 or later                                                                                                          |

### boot protect enable username password

Allows you to enable bootloader protection.

|               |                                                                                    |
|---------------|------------------------------------------------------------------------------------|
| <b>Syntax</b> | <code>boot protect enable username <i>username</i> password <i>password</i></code> |
|---------------|------------------------------------------------------------------------------------|

|                           |                                                                                                                                                                                                                |
|---------------------------|----------------------------------------------------------------------------------------------------------------------------------------------------------------------------------------------------------------|
| <b>Parameters</b>         | <ul style="list-style-type: none"> <li>• <i>username</i> — Enter the username to provide access to bootloader protection.</li> <li>• <i>password</i> — Enter a password for the specified username.</li> </ul> |
| <b>Default</b>            | Disabled                                                                                                                                                                                                       |
| <b>Command Mode</b>       | EXEC                                                                                                                                                                                                           |
| <b>Usage Information</b>  | You can enable bootloader protection by executing this command. You can configure a maximum of three username / password pairs for bootloader protection.                                                      |
| <b>Example</b>            | <pre>OS10# boot protect enable username root password calvin</pre>                                                                                                                                             |
| <b>Supported Releases</b> | 10.4.3.0 or later                                                                                                                                                                                              |

## show boot protect

Displays the current list of configured users that have access to bootloader protection.

|                           |                                                                                                                          |
|---------------------------|--------------------------------------------------------------------------------------------------------------------------|
| <b>Syntax</b>             | <code>show boot protect</code>                                                                                           |
| <b>Parameters</b>         | None                                                                                                                     |
| <b>Default</b>            | Not configured                                                                                                           |
| <b>Command Mode</b>       | EXEC                                                                                                                     |
| <b>Usage Information</b>  | Displays the current list of authorised users for bootloader protection, but hides their passwords for security reasons. |
| <b>Example (Disabled)</b> | <pre>OS10# show boot protect Boot protection disabled</pre>                                                              |
| <b>Example (Enabled)</b>  | <pre>OS10# show boot protect Boot protection enabled Authorized users: root linuxadmin admin</pre>                       |
| <b>Supported Releases</b> | 10.4.3.0 or later                                                                                                        |

## show secure-boot pki-certificates

Displays PKI certificates that are installed in the system.

|                            |                                                                                                                                                                                                                                                                                                             |
|----------------------------|-------------------------------------------------------------------------------------------------------------------------------------------------------------------------------------------------------------------------------------------------------------------------------------------------------------|
| <b>Syntax</b>              | <code>show secure-boot pki-certificates</code>                                                                                                                                                                                                                                                              |
| <b>Parameters</b>          | None                                                                                                                                                                                                                                                                                                        |
| <b>Default</b>             | None                                                                                                                                                                                                                                                                                                        |
| <b>Security and Access</b> | Sysadmin and secadmin                                                                                                                                                                                                                                                                                       |
| <b>Command Mode</b>        | EXEC                                                                                                                                                                                                                                                                                                        |
| <b>Usage Information</b>   | None                                                                                                                                                                                                                                                                                                        |
| <b>Example</b>             | <pre>OS10# show secure-boot pki-certificates Certificate Key Id      : 123 Version Number         : 3 (0x2) Serial Number          : 17154672033164819608 (0xee11a353271dfc98) Signature Algorithm    : sha256WithRSAEncryption Issuer                 : C=IN, ST=Some-State, L=some-city, O=Internet</pre> |



```

Widgits Pty Ltd
Validity : Aug 1 11:45:39 2019 GMT - Jul 31 11:45:39 2020
GMT

Certificate Key Id : 124
Version Number : 3 (0x2)
Serial Number : 17154672033164819608 (0xee11a353271dfc98)
Signature Algorithm : sha256WithRSAEncryption
Issuer : C=IN, ST=Some-State, L=some-city, O=Internet
Widgits Pty Ltd
Validity : Aug 1 11:45:39 2019 GMT - Jul 31 11:45:39 2020
GMT

```

**Supported Releases** 10.5.1.0 or later

## show secure-boot

Displays the secure boot or file integrity status.

**Syntax** `show secure-boot {status | file-integrity-status}`

**Parameters**

- `status`—Displays secure boot status.
- `file-integrity-status`—(Applicable only when you enable the secure boot feature) Displays file integrity status.

**Default** None

**Security and Access** Sysadmin and secadmin

**Command Mode** EXEC

**Usage Information** None

### Example 1

```

OS10# show secure-boot status
Last boot was via secure boot : yes
Secure boot configured : yes
Latest startup config protected: yes

```

### Example 2

```

OS10# show secure-boot file-integrity-status
File Integrity Status: OK

```

### Example 3

```

OS10# show secure-boot file-integrity-status
File Integrity Status: Failed
Potential Security Issues:
Files modified:
/opt/dell/os10/bin/dn_l3_core_services
Files added:
/opt/dell/os10/bin/trojan1
/opt/dell/os10/bin/virus123

```

**Supported Releases** 10.5.1.0 or later

## secure-boot verify

Validates the kernel, system, and startup configuration binary files of both the OS10 installed images.

**Syntax** `secure-boot verify {kernel | file-system-integrity | startup-config}`

**Parameters**

- `kernel`—Validate the kernel image.

- `file-system-integrity`—Validate the OS10 system binaries.
- `startup-config`—Validate the startup configuration file.

**Default** None

**Security and Access** Sysadmin

**Command Mode** EXEC

**Usage Information** None

**Example 1 - Kernel verification**

```
OS10# secure-boot verify kernel
Active Partition
Kernel signature verified:success
Standby Partition
Kernel signature verified:success
```

**Example 2 - File system verification**

```
OS10# secure-boot verify file-system-integrity
Active Partition
File-system integrity verified:success
Standby Partition
File-system integrity verified:success
```

**Example 3 - Startup config verification**

```
OS10# secure-boot verify startup-config
Latest startup config protected: yes
```

**Supported Releases** 10.5.1.0 or later

## secure-boot revoke key

Revokes an installed key.

**Syntax** `secure-boot revoke key key-id`

**Parameters** *key-id*—key number of the installed key that is compromised.

**Default** None

**Security and Access** Sysadmin

**Command Mode** EXEC

**Usage Information** Use this command to revoke an installed key that is compromised.

**Example**

```
OS10# secure-boot revoke key 5
```

**Supported Releases** 10.5.1.0 or later

## secure-boot protect startup-config

Protects the startup config file and its hash value.

**Syntax** `secure-boot protect startup-config`

**Parameters** None

**Default** None

|                            |                                                                                                                                                                                                                                |
|----------------------------|--------------------------------------------------------------------------------------------------------------------------------------------------------------------------------------------------------------------------------|
| <b>Security and Access</b> | Sysadmin, secadmin, netadmin                                                                                                                                                                                                   |
| <b>Command Mode</b>        | EXEC                                                                                                                                                                                                                           |
| <b>Usage Information</b>   | This CLI is available only when you enable secure boot. If the startup configuration file is deleted or compromised, use the protected version of the startup configuration file to restore the configuration during a reboot. |
| <b>Example</b>             | <pre>OS10# secure-boot protect startup-config</pre>                                                                                                                                                                            |
| <b>Supported Releases</b>  | 10.5.1.0 or later                                                                                                                                                                                                              |

## secure-boot enable

Enables secure boot.

|                            |                                                                                                                                                                                                                                                                                                                                                                                                                                |
|----------------------------|--------------------------------------------------------------------------------------------------------------------------------------------------------------------------------------------------------------------------------------------------------------------------------------------------------------------------------------------------------------------------------------------------------------------------------|
| <b>Syntax</b>              | <code>secure-boot enable</code>                                                                                                                                                                                                                                                                                                                                                                                                |
| <b>Parameters</b>          | None                                                                                                                                                                                                                                                                                                                                                                                                                           |
| <b>Default</b>             | Disabled                                                                                                                                                                                                                                                                                                                                                                                                                       |
| <b>Security and Access</b> | Sysadmin                                                                                                                                                                                                                                                                                                                                                                                                                       |
| <b>Command Mode</b>        | CONFIGURATION                                                                                                                                                                                                                                                                                                                                                                                                                  |
| <b>Usage Information</b>   | If you enable secure boot, ensure that you manually protect the startup configuration file before you reload the switch. The protected version of the startup configuration file is applied during the boot up process. If a protected version of the startup configuration file is not available, the system applies the default configuration.<br><br>The <code>no</code> version of this command removes the configuration. |
| <b>Example</b>             | <pre>OS10# secure-boot enable</pre>                                                                                                                                                                                                                                                                                                                                                                                            |
| <b>Supported Releases</b>  | 10.5.1.0 or later                                                                                                                                                                                                                                                                                                                                                                                                              |

## image verify

Verifies the OS10 image file using sha256, PKI, or GPG signatures.

|                            |                                                                                                                                                                                                                                                                                                                                                                                                                                                                                                                                |
|----------------------------|--------------------------------------------------------------------------------------------------------------------------------------------------------------------------------------------------------------------------------------------------------------------------------------------------------------------------------------------------------------------------------------------------------------------------------------------------------------------------------------------------------------------------------|
| <b>Syntax</b>              | <code>image verify image-filepath {sha256 signature signature-filepath   gpg signature signature-filepath   pki signature signature-filepath public-key key-file}</code>                                                                                                                                                                                                                                                                                                                                                       |
| <b>Parameters</b>          | <ul style="list-style-type: none"> <li>• <code>image-filepath</code>—Enter the absolute path name of the OS10 image file.</li> <li>• <code>sha256 signature signature-filepath</code>—Verify the SHA-256 cryptographic hash signature of the image file.</li> <li>• <code>gpg signature signature-filepath</code>—Verify the GNU privacy guard signature of the image file.</li> <li>• <code>pki signature signature-filepath public-key key-file</code>—Verify the PKI-signed digital signature of the image file.</li> </ul> |
| <b>Default</b>             | None                                                                                                                                                                                                                                                                                                                                                                                                                                                                                                                           |
| <b>Security and Access</b> | Sysadmin                                                                                                                                                                                                                                                                                                                                                                                                                                                                                                                       |
| <b>Command Mode</b>        | EXEC                                                                                                                                                                                                                                                                                                                                                                                                                                                                                                                           |

**Usage Information** This command verifies the signature of the OS10 image file using hash-based authentication, GNU privacy guard (Gn uPG or GPG)-based signatures, or digital signatures (PKI-signed). For GPG validation, before you validate the OS10 image, use the `image gpg-key` command to install the GPG key in the switch keyring.

**Example-sha256**

```
OS10# image verify image://PKGS_OS10-Enterprise-10.4.9999EX.3342stretch-
installer-x86_64.bin pki signature tftp://10.16.127.7/users/PKGS_OS10-
Enterprise-10.4.9999EX.3342stretch-installer-x86_64.bin.sha256.base64
public-key tftp://10.16.127.7/users/DellOS10.cert.pem
Image verified successfully.
```

**Example-GPG key**

```
OS10# image verify image://PKGS_OS10-Enterprise-10.4.9999EX.3342stretch-
installer-x86_64.bin gpg signature tftp://10.16.127.7/users/PKGS_OS10-
Enterprise-10.4.9999EX.3342stretch-installer-x86_64.bin.gpg
```

**Example-PKI**

```
OS10# image verify image://PKGS_OS10-Enterprise-10.4.9999EX.3342stretch-
installer-x86_64.bin pki signature tftp://10.16.127.7/users/PKGS_OS10-
Enterprise-10.4.9999EX.3342stretch-installer-x86_64.bin.sha256.base64
public-key tftp://10.16.127.7/users/DellOS10.cert.pem
Image verified successfully.
```

**Supported Releases** 10.5.1.0 or later

## image secure-install

Validates and installs the specified image.

**Syntax** `image secure-install image-filepath {sha256 signature signature-filepath | gpg signature signature-filepath | pki signature signature-filepath public-key key-file}`

- Parameters**
- *image-filepath*—Enter the absolute path name of the OS10 image file.
  - *sha256 signature signature-filepath*—Verify the SHA-256 cryptographic hash signature of the image file.
  - *gpg signature signature-filepath*—Verify the GNU privacy guard signature of the image file.
  - *pki signature signature-filepath public-key key-file*—Verify the PKI-signed digital signature of the image file.

**Default** None

**Security and Access** Sysadmin

**Command Mode** EXEC

**Usage Information** This command is available only when you enable secure boot. This command is similar to the `image install` command. The system, before installing the image, verifies the signature of the OS10 image file using hash-based authentication, GNU privacy guard (Gn uPG or GPG)-based signatures, or digital signatures (PKI-signed). For GPG validation, before you validate the OS10 image, use the `image gpg-key` command to install the GPG key in the switch keyring.

**Example - sha256**

```
OS10# image secure-install image://PKGS_OS10-
Enterprise-10.4.9999EX.3342stretch-installer-x86_64.bin sha256 signature
tftp://10.16.127.7/users/PKGS_OS10-Enterprise-10.4.9999EX.3342stretch-
installer-x86_64.bin.sha256
```

**Example - GPG key**

```
OS10# image secure-install image://PKGS_OS10-
Enterprise-10.4.9999EX.3342stretch-installer-x86_64.bin gpg signature
```

```
tftp://10.16.127.7/users/PKGS_OS10-Enterprise-10.4.9999EX.3342stretch-
installer-x86_64.bin.gpg
```

### Example - PKI signature

```
OS10# image secure-install image://PKGS_OS10-
Enterprise-10.4.9999EX.3342stretch-installer-x86_64.bin pki signature
tftp://10.16.127.7/users/PKGS_OS10-Enterprise-10.4.9999EX.3342stretch-
installer-x86_64.bin.sha256.base64 public-key tftp://10.16.127.7/users/
DellOS10.cert.pem
```

**Supported Releases** 10.5.1.0 or later

## image gpg-key key-server

Installs the GPG key into the switch GPG key ring.

**Syntax** `image gpg-key key-server key-server-name key-id key-id-string`

**Parameters**

- *key-server-name*—Hostname address of the GPG key server
- *key-id-string*—Key ID of the GPG key to be installed

**Default** None

**Security and Access** Sysadmin

**Command Mode** EXEC

**Usage Information** This command uses the *key-server* name and *key-id* to install the key into the switch GPG key ring. Use this command before you use the `image verify` or `image secure-install` commands with the GPG option. If the key is not installed in the key ring, the `image verify` and `image secure-install` commands fail when used with the GPG key.

### Example

```
OS10# image gpg-key key-server pool.sks-keyservers.net key-id 47CB9029
```

**Supported Releases** 10.5.1.0 or later

## Switch management access

OS10 provides security to all management access through console, Telnet, SSH connections, and SNMP requests.

## SSH server

In OS10, the secure shell server allows an SSH client to access an OS10 switch through a secure, encrypted connection. The SSH server authenticates remote clients using RADIUS challenge/response, a trusted host file, locally-stored passwords, and public keys.

### Configure SSH server

- The SSH server is enabled by default. You can disable the SSH server using the `no ip ssh server enable` command.
- Challenge response authentication is disabled by default. To enable, use the `ip ssh server challenge-response authentication` command.
- Host-based authentication is disabled by default. To enable, use the `ip ssh server hostbased-authentication` command.
- Password authentication is enabled by default. To disable, use the `no ip ssh server password-authentication` command.
- Public key authentication is enabled by default. To disable, use the `no ip ssh server pubkey-authentication` command.

- Password-less login is disabled by default. To enable, use the `username sshkey` or `username sshkey filename` commands.
- Configure the list of cipher algorithms using the `ip ssh server cipher cipher-list` command.
- Configure key exchange algorithms using the `ip ssh server kex key-exchange-algorithm` command.
- Configure hash message authentication code (HMAC) algorithms using the `ip ssh server mac hmac-algorithm` command.
- Configure the SSH server listening port using the `ip ssh server port port-number` command.
- Configure the SSH server to be reachable on the management VRF using the `ip ssh server vrf` command.
- Configure the SSH login timeout using the `ip ssh server login-grace-time seconds` command, from 0 to 300; default 60. To reset the default SSH prompt timer, use the `no ip ssh server login-grace-time` command.
- Configure the maximum number of authentication attempts using the `ip ssh server max-auth-tries number` command, from 0 to 10; default 6. To reset the default, use the `no ip ssh server max-auth-tries` command.

The `max-auth-tries` value includes all authentication attempts, including public-key and password. If you enable both, public-key based authentication and password authentication, the public-key authentication is the default and is tried first. If it fails, the number of `max-auth-tries` is reduced by one. In this case, if you configured `ip ssh server max-auth-tries 1`, the password prompt does not display.

### Regenerate public keys

When enabled, the SSH server generates public keys by default and uses them for client authentication:

- A Rivest, Shamir, and Adelman (RSA) key using 2048 bits.
- An Elliptic Curve Digital Signature Algorithm (ECDSA) key using 256 bits
- An Ed25519 key using 256 bits

 **NOTE:** RSA1 and DSA keys are not supported on the OS10 SSH server.

An SSH client must exchange the same public key to establish a secure SSH connection to the OS10 switch. If necessary, you can regenerate the keys used by the SSH server with a customized bit size. You cannot change the default size of the Ed25519 key. The `crypto key generate` command is available only to the `sysadmin` and `secadmin` roles.

1. Regenerate keys for the SSH server in EXEC mode.

```
crypto ssh-key generate {rsa {2048|3072|4096} | ecdsa {256|384|521} | ed25519}
```

2. Enter `yes` at the prompt to overwrite an existing key.

```
Host key already exists. Overwrite [confirm yes/no]:yes
Generated 2048-bit RSA key
```

3. Display the SSH public keys in EXEC mode.

```
show crypto ssh-key
```

After you regenerate SSH public keys, disable and re-enable the SSH server to use the new public keys. Restarting the SSH server does not impact current OS10 sessions.

## RESTCONF API

RESTCONF API allows to configure and monitor an OS10 switch using HTTP with the Transport Layer Security (TLS) protocol. For more information about RESTCONF API, see [RESTCONF API](#).

## Restrict SNMP access

To filter SNMP requests on the switch, assign access lists to an SNMP community. Both IPv4 and IPv6 access lists are supported.

These points are applicable when you assign an ACL to an SNMP community:

- By default, SNMP requests from all hosts are allowed.
- You can only apply `permit` ACL rules to an SNMP community. `deny` ACL rules do not take effect if you apply them.
- To permit SNMP requests for multiple hosts, apply individual `permit` ACL rules for hosts or prefixes.

1. Create access lists with permit or deny filters; for example:

```
OS10(config)# ip access-list snmp-read-only-acl
OS10(config-ipv4-acl)# permit ip 172.16.0.0 255.255.0.0 any
OS10(config-ipv4-acl)# exit
OS10(config)#
```

2. Apply ACLs to an SNMP community in CONFIGURATION mode.

```
OS10(config)# snmp-server community public ro acl snmp-read-only-acl
```

### View SNMP ACL configuration

```
OS10# show snmp community
Community : public
Access : read-only
ACL : snmp-read-only-acl
```

## Limit concurrent login sessions

To avoid an unlimited number of active sessions on a switch for the same user ID, limit the number of console and remote connections. Log in from a console connection by cabling a terminal emulator to the console serial port on the switch. Log in to the switch remotely through a virtual terminal line, such as Telnet and SSH.

- Configure the maximum number of concurrent login sessions in CONFIGURATION mode.

```
OS10(config)# login concurrent-session limit number
```

- *limit number* — Sets the maximum number of concurrent login sessions allowed for a user ID, from 1 to 12; default 10.

When you configure the maximum number of allowed concurrent login sessions, take into account that:

- Each remote VTY connection counts as one login session.
- All login sessions from a terminal emulator on an attached console count as one session.

### Configure concurrent login sessions

```
OS10(config)# login concurrent-session limit 4
```

If you log in to the switch after the maximum number of concurrent sessions are active, an error message displays. To log in to the system, close one of your existing sessions.

```
OS10(config)# login concurrent-session limit 4

Too many logins for 'admin'.
Last login: Wed Jan 31 20:37:34 2018 from 10.14.1.213
Connection to 10.11.178.26 closed.
Current sessions for user admin:
Line Location
2 vty 0 10.14.1.97
3 vty 1 10.14.1.97
4 vty 2 10.14.1.97
5 vty 3 10.14.1.97
```

## Virtual terminal line ACLs

To limit Telnet and SSH connections to the switch, apply access lists on a virtual terminal line (VTY).

There is no implicit deny rule. If none of the configured conditions match, the default behavior is to permit. If you need to deny traffic that does not match any of the configured conditions, explicitly configure a deny statement.

1. Create IPv4 or IPv6 access lists with permit or deny filters; for example:

```
OS10(config)# ip access-list permit10
OS10(config-ipv4-acl)# permit ip 172.16.0.0 255.255.0.0 any
```

```
OS10(config-ipv4-acl)# exit
OS10(config)#
```

2. Enter VTY mode using the `line vty` command in CONFIGURATION mode.

```
OS10(config)# line vty
OS10(config-line-vty)#
```

3. Apply the access lists to the VTY line with the `{ip | ipv6} access-class access-list-name` command in LINE-VTY mode.

```
OS10(config-line-vty)# ip access-class permit10
```

### View VTY ACL configuration

```
OS10(config-line-vty)# show configuration
!
line vty
 ip access-class permit10
 ipv6 access-class deny10
OS10(config-line-vty)#
```

## Switch management access

OS10 provides security to all management access through console, Telnet, SSH connections, and SNMP requests.

### ip ssh server enable

Enables the SSH server.

**Syntax** `ip ssh server enable`

**Parameters** None

**Default** Enabled

**Command Mode** CONFIGURATION

**Usage Information** Supported on the MX9116n and MX5108n switches in Full Switch mode starting in release 10.4.0E(R3S). Also supported in SmartFabric mode starting in release 10.5.0.1.

The `no` version of this command disables the SSH server.

**Example**

```
OS10(config)# ip ssh server enable
```

**Supported Releases** 10.3.0E or later

### ip ssh server challenge-response-authentication

Enables challenge response authentication in the SSH server.

**Syntax** `ip ssh server challenge-response-authentication`

**Parameters** None

**Default** Disabled

**Command Mode** CONFIGURATION

**Usage Information** Supported on the MX9116n and MX5108n switches in Full Switch mode starting in release 10.4.0E(R3S). Also supported in SmartFabric mode starting in release 10.5.0.1.

The `no` version of this command disables the challenge response authentication.



**Example**

```
OS10(config)# ip ssh server challenge-response-authentication
```

**Supported Releases**

10.3.0E or later

## ip ssh server cipher

Configures the list of cipher algorithms in the SSH server.

**Syntax**

```
ip ssh server cipher cipher-list
```

**Parameters**

*cipher-list* — Enter a list of cipher algorithms. Separate entries with a blank space. The cipher algorithms supported by the SSH server are:

- 3des-cbc
- aes128-cbc
- aes192-cbc
- aes256-cbc
- aes128-ctr
- aes192-ctr
- aes256-ctr
- aes128-gcm@openssh.com
- aes256-gcm@openssh.com
- blowfish-cbc
- cast128-cbc
- chacha20-poly1305@opens

**Default**

- aes128-ctr
- aes192-ctr
- aes256-ctr
- aes128-gcm@openssh.com
- aes256-gcm@openssh.com
- chacha20-poly1305@opens

**Command Mode**

CONFIGURATION

**Usage Information**

Supported on the MX9116n and MX5108n switches in Full Switch mode starting in release 10.4.0E(R3S). Also supported in SmartFabric mode starting in release 10.5.0.1.

The `no` version of this command removes the configuration.

**Example**

```
OS10(config)# ip ssh server cipher 3des-cbc aes128-cbc
```

**Supported Releases**

10.3.0E or later

## ip ssh server hostbased-authentication

Enables host-based authentication in an SSH server.

**Syntax**

```
ip ssh server hostbased-authentication
```

**Parameters**

None

**Default**

Disabled

**Command Mode**

CONFIGURATION

**Usage Information**

Supported on the MX9116n and MX5108n switches in Full Switch mode starting in release 10.4.0E(R3S). Also supported in SmartFabric mode starting in release 10.5.0.1.

The `no` version of this command disables the host-based authentication.

**Example**

```
OS10(config)# ip ssh server hostbased-authentication
```

**Supported Releases**

10.3.0E or later

## ip ssh server kex

Configures the key exchange algorithms used in the SSH server.

**Syntax**

```
ip ssh server kex key-exchange-algorithm
```

**Parameters**

*key-exchange-algorithm* — Enter the supported key exchange algorithms separated by a blank space. The SSH server supports these key exchange algorithms:

- curve25519-sha256
- curve25519-sha256@libssh.org
- diffie-hellman-group1-sha1
- diffie-hellman-group14-sha1
- diffie-hellman-group16-sha512
- diffie-hellman-group-exchange-sha1
- diffie-hellman-group-exchange-sha256
- ecdh-sha2-nistp256
- ecdh-sha2-nistp384
- ecdh-sha2-nistp521

**Default**

- curve25519-sha256
- diffie-hellman-group14-sha1
- diffie-hellman-group-exchange-sha256
- ecdh-sha2-nistp256
- ecdh-sha2-nistp384
- ecdh-sha2-nistp521

**Command Mode**

CONFIGURATION

**Usage Information**

Supported on the MX9116n and MX5108n switches in Full Switch mode starting in release 10.4.0E(R3S). Also supported in SmartFabric mode starting in release 10.5.0.1.

The no version of this command removes the configuration.

**Example**

```
OS10(config)# ip ssh server kex curve25519-sha256 diffie-hellman-group1-sha1
```

**Supported Releases**

10.3.0E or later

## ip ssh server mac

Configures the hash message authentication code (HMAC) algorithms used in the SSH server.

**Syntax**

```
ip ssh server mac hmac-algorithm
```

**Parameters**

*hmac-algorithm* — Enter the supported HMAC algorithms separated by a blank space. The SSH server supports these HMAC algorithms:

- hmac-md5
- hmac-md5-96
- hmac-ripemd160
- hmac-sha1
- hmac-sha1-96
- hmac-sha2-256

- hmac-sha2-512
- umac-64@openssh.com
- umac-128@openssh.com
- hmac-md5-etm@openssh.com
- hmac-md5-96-etm@openssh.com
- hmac-ripemd160-etm@openssh.com
- hmac-sha1-etm@openssh.com
- hmac-sha1-96-etm@openssh.com
- hmac-sha2-256-etm@openssh.com
- hmac-sha2-512-etm@openssh.com
- umac-64-etm@openssh.com
- umac-128-etm@openssh.com

**Default**

- hmac-sha1
- hmac-sha2-256
- hmac-sha2-512
- umac-64@openssh.com
- umac-128@openssh.com
- hmac-sha1-etm@openssh.com
- hmac-sha2-256-etm@openssh.com
- hmac-sha2-512-etm@openssh.com
- umac-64-etm@openssh.com
- umac-128-etm@openssh.com

**Command Mode** CONFIGURATION

**Usage Information**

Supported on the MX9116n and MX5108n switches in Full Switch mode starting in release 10.4.0E(R3S). Also supported in SmartFabric mode starting in release 10.5.0.1.

The no version of this command removes the configuration.

**Example**

```
OS10(config)# ip ssh server mac hmac-md5 hmac-md5-96 hmac-ripemd160
```

**Supported Releases**

10.3.0E or later

## ip ssh server password-authentication

Enables password authentication in the SSH server.

**Syntax** ip ssh server password-authentication

**Parameters** None

**Default** Enabled

**Command Mode** CONFIGURATION

**Usage Information**

Supported on the MX9116n and MX5108n switches in Full Switch mode starting in release 10.4.0E(R3S). Also supported in SmartFabric mode starting in release 10.5.0.1.

The no version of this command disables the password authentication.

**Example**

```
OS10(config)# ip ssh server password-authentication
```

**Supported Releases**

10.3.0E or later

## ip ssh server port

Configures the SSH server listening port.

|                           |                                                                                                                                                                                                                                                 |
|---------------------------|-------------------------------------------------------------------------------------------------------------------------------------------------------------------------------------------------------------------------------------------------|
| <b>Syntax</b>             | <code>ip ssh server port <i>port-number</i></code>                                                                                                                                                                                              |
| <b>Parameters</b>         | <i>port-number</i> — Enter the listening port number, from 1 to 65535.                                                                                                                                                                          |
| <b>Default</b>            | 22                                                                                                                                                                                                                                              |
| <b>Command Mode</b>       | CONFIGURATION                                                                                                                                                                                                                                   |
| <b>Usage Information</b>  | TSupported on the MX9116n and MX5108n switches in Full Switch mode starting in release 10.4.0E(R3S). Also supported in SmartFabric mode starting in release 10.5.0.1.<br>The <code>no</code> version of this command removes the configuration. |
| <b>Example</b>            | <pre>OS10(config)# ip ssh server port 255</pre>                                                                                                                                                                                                 |
| <b>Supported Releases</b> | 10.3.0E or later                                                                                                                                                                                                                                |

## ip ssh server pubkey-authentication

Enables public key authentication for the SSH server.

|                           |                                                                                                                                                                                                                                                             |
|---------------------------|-------------------------------------------------------------------------------------------------------------------------------------------------------------------------------------------------------------------------------------------------------------|
| <b>Syntax</b>             | <code>ip ssh server pubkey-authentication</code>                                                                                                                                                                                                            |
| <b>Parameters</b>         | None                                                                                                                                                                                                                                                        |
| <b>Default</b>            | Enabled                                                                                                                                                                                                                                                     |
| <b>Command Mode</b>       | CONFIGURATION                                                                                                                                                                                                                                               |
| <b>Usage Information</b>  | Supported on the MX9116n and MX5108n switches in Full Switch mode starting in release 10.4.0E(R3S). Also supported in SmartFabric mode starting in release 10.5.0.1.<br>The <code>no</code> version of this command disables the public key authentication. |
| <b>Example</b>            | <pre>OS10(config)# ip ssh server pubkey-authentication</pre>                                                                                                                                                                                                |
| <b>Supported Releases</b> | 10.3.0E or later                                                                                                                                                                                                                                            |

## ip ssh server vrf

Configures an SSH server for the management or non-default VRF instance.

|                           |                                                                                                                                                                                                                                           |
|---------------------------|-------------------------------------------------------------------------------------------------------------------------------------------------------------------------------------------------------------------------------------------|
| <b>Syntax</b>             | <code>ip ssh server vrf {management   <i>vrf-name</i>}</code>                                                                                                                                                                             |
| <b>Parameters</b>         | <ul style="list-style-type: none"><li>• <code>management</code> — Configures the management VRF instance to reach the SSH server.</li><li>• <code><i>vrf-name</i></code> — Enter the VRF instance used to reach the SSH server.</li></ul> |
| <b>Default</b>            | Not configured                                                                                                                                                                                                                            |
| <b>Command Mode</b>       | CONFIGURATION                                                                                                                                                                                                                             |
| <b>Usage Information</b>  | The SSH server uses the management VRF.                                                                                                                                                                                                   |
| <b>Example</b>            | <pre>OS10(config)# ip ssh server vrf management OS10(config)# ip ssh server vrf vrf-blue</pre>                                                                                                                                            |
| <b>Supported Releases</b> | 10.4.0E(R1) or later                                                                                                                                                                                                                      |

## show ip ssh

Displays the SSH server information.

**Syntax** show ip ssh

**Parameters** None

**Default** Not configured

**Command Mode** EXEC

**Usage Information** Use this command to view information about the established SSH sessions.

### Example

```
OS10# show ip ssh

SSH Server: Enabled

SSH Server Ciphers: chacha20-poly1305@openssh.com, aes128-ctr,
aes192-ctr, aes256-ctr,
aes128-gcm@openssh.com, aes256-
gcm@openssh.com
SSH Server MACs: umac-64-etm@openssh.com, umac-128-
etm@openssh.com,
hmac-sha2-256-etm@openssh.com,
hmac-sha2-512-etm@openssh.com,
hmac-sha1-
etm@openssh.com, umac-64@openssh.com,
umac-128@openssh.com, hmac-sha2-256,
hmac-sha2-512, hmac-sha1
SSH Server KEX algorithms: curve25519-sha256@libssh.org, ecdh-sha2-
nistp256,
ecdh-sha2-nistp384, ecdh-sha2-nistp521,
diffie-hellman-group-exchange-sha256,
diffie-hellman-group14-sha1
Password Authentication: Enabled
Host-Based Authentication: Disabled
RSA Authentication: Enabled
Challenge Response Auth: Disabled
```

**Supported Releases** 10.3.0E or later

## show crypto ssh-key

Displays the current host public keys used in SSH authentication.

**Syntax** show crypto ssh-key {rsa | ecdsa | ed25519}

**Parameters**

- `rsa` — Displays the RSA public key.
- `ecdsa` — Displays the ECDSA public key.
- `ed25519` — Displays the Ed25519 key.

**Default** Not configured

**Command Mode** EXEC

**Usage Information** After you regenerate an SSH server key with a customized bit size, disable and re-enable the SSH server to use the new public keys. To verify the changes, use the `show crypto` command.

If a remote SSH client uses strict host-key checking, copy a newly generated host key to the list of known hosts on the client device.

### Example

```
OS10# show crypto ssh-key rsa
ssh-rsa AAAAB3NzaC1yc2EAAAADAQABAAQACogJtArA0fHJkFpioGaAcp+vrDQFC313XFHtd
41wXY9kM0Ar+37yRsDul8vKodqSDiGLRuPjFTcVjvDdSKWblJRsybkMA6nuHJIyPOScDepLlicM
IOxDhXEE92VRAMGuLI2AoeVYcH+IneWXhwQOkOfLtpxfnsiQY65CfS4aGoHOHWSfx3wI7boEDRD
```

```
uvZ8gzRxTuM16Qr+RxBLJ7/OzkjNIN1/8Ok+8aJtCoJKbcYaduMjmhVNrNUW5TUXoCnp1XNRpkJ
zgS7Lt47yi86rqrTCAQW4eSYJIJs4+4ql9b4MF2D3499Ofn8uS82MjtjON1011bTbP3gsF4YYdB
WaFqp root@OS10
```

**Supported Releases** 10.4.1.0 or later

## username sshkey

Enables SSH password-less login using the public key of a remote client. The remote client is not prompted to enter a password.

**Syntax** `username username sshkey sshkey-string`

**Parameters**

- `username` — Enter the user name. This value is the user name configured with the `username password role` command.
- `sshkey-string` — Enter the public key of remote client device, as the text string. If `sshkey-string` contains a blank space, enclose the string in double quotes (").

**Default** The default SSH public keys are an RSA key generated using 2048 bits, an ECDSA key with 256 bits, and an Ed25519 key with 256 bits.

**Command Mode** CONFIGURATION

**Usage Information** To configure multiple public keys for SSH password-less login of a specific user, use the `username username sshkey filename` command. The `no` form of the command removes the public key configuration of a specified user.

Remote client system stores the public key of a user in the `~/.ssh/id_rsa.pub` file. Use public key as the `sshkey-string` parameter.

Supported on the MX9116n and MX5108n switches in Full Switch mode starting in release 10.4.1.0. Also supported in SmartFabric mode starting in release 10.5.0.1.

### Example

```
OS10(config)# username test sshkey "ssh-rsa AAAAB3NzaC1yc2EAAAABJQAAAQBqJaD
wgBgQX1PPPSEyx+F5DVG2RpBH4Zm1YQApE5YJsKlt6RpeOIT1wnJP/o54p1nCeMu38i7/zCLWuW
t3XDVVMoSCb9Za89hebQ+f6XyNs4aMpyUk5RmuZTXqwnbUUuP3nPw/Y41KkZJafWx125Ma7Ibw
fUM5wGdBu76j8mvwsWvNxrnkOsweo7Anp67p8Lsg+KBUsx3q8Fpc986qQfdrcEFO01WraJR8wzY
1mbQw/C+Hm5Ap6Nr6DoXmwqKdKUr7jfte8ThARYZD8dvZeyzhk3nykYRQ39mqjXnOyEOiD11e21
QUvI1cjcQPDxgFJUrkcclyPiGUOH5"
```

```
OS10(config)# do show running-configuration users
username admin password 6q9QBeYjZ$jfzxVqGhxxX3smxJSH9DDz7/30Jc6m5wjF8nnLD
7/VKx8SloIhp4NoGZs0I/UNwh8WVuxwfd9q4pWigNs5BKH. role sysadmin
```

```
username user10 password 6rounds=656000$G10VRFTJB291ekwo$iTGf0zd4bTUcBBpI
Vsbr6oStnUZMydN5lDs4WE6G3XHEtWbcKrGTeAo1wEF0cenEgRRPzi3SMmYyzAHCCC8ws0 role
sysadmin
```

```
username test sshkey "ssh-rsa AAAAB3NzaC1yc2EAAAABJQAAAQBqJaDwgBgQX1PPPSEyx
+F5DVG2RpBH4Zm1YQApE5YJsKlt6RpeOIT1wnJP/o54p1nCeMu38i7/zCLWuWt3XDVVMoSCb9Za
89hebQ+f6XyNs4aMpyUk5RmuZTXqwnbUUuP3nPw/Y41KkZJafWx125Ma7IbwfUM5wGdBu76j8m
vwsWvNxrnkOsweo7Anp67p8Lsg+KBUsx3q8Fpc986qQfdrcEFO01WraJR8wzY1mbQw/C+Hm5Ap6
Nr6DoXmwqKdKUr7jfte8ThARYZD8dvZeyzhk3nykYRQ39mqjXnOyEOiD11e21QUvI1cjcQPDxgF
JUrkcclyPiGUOH5"
```

**Supported Releases** 10.4.1.0 or later

## username sshkey filename

Enables SSH password-less login for remote clients using multiple public keys. A remote client is not prompted to enter a password.

**Syntax** `username username sshkey filename filepath`

|                          |                                                                                                                                                                                                                                                                                                                                                                                                                                                                                                                                                                                                                                                                                                                                                                                                                                                                |
|--------------------------|----------------------------------------------------------------------------------------------------------------------------------------------------------------------------------------------------------------------------------------------------------------------------------------------------------------------------------------------------------------------------------------------------------------------------------------------------------------------------------------------------------------------------------------------------------------------------------------------------------------------------------------------------------------------------------------------------------------------------------------------------------------------------------------------------------------------------------------------------------------|
| <b>Parameters</b>        | <ul style="list-style-type: none"> <li>• <i>username</i> — Enter an OS10 user name who logs in on a remote client. This value is the user name configured using the <code>username password role</code> command.</li> <li>• <i>filepath</i> — Enter the absolute path name of the local file containing the public keys used by remote devices to log in to the OS10 switch.</li> </ul>                                                                                                                                                                                                                                                                                                                                                                                                                                                                        |
| <b>Default</b>           | The default SSH public keys are an RSA key generated using 2048 bits, an ECDSA key with 256 bits, and an Ed25519 key with 256 bits.                                                                                                                                                                                                                                                                                                                                                                                                                                                                                                                                                                                                                                                                                                                            |
| <b>Command Mode</b>      | CONFIGURATION                                                                                                                                                                                                                                                                                                                                                                                                                                                                                                                                                                                                                                                                                                                                                                                                                                                  |
| <b>Usage Information</b> | <p>Before you use the command, locate the public keys on a remote client in the <code>~/.ssh/id_rsa.pub</code> file. Create a text file and copy the SSH public keys on the remote client into the file. Enter each public key on a separate line. Download the file to your home OS10 directory.</p> <p> <b>NOTE:</b> Entering the command when an SSH key file is not present has no effect and results in a silent failure. SSH password-less login is not enabled.</p> <p>Supported on the MX9116n and MX5108n switches in Full Switch mode starting in release 10.4.1.0. Also supported in SmartFabric mode starting in release 10.5.0.1.</p> <p>The <code>no</code> version of the command removes the SSH password-less configuration for the specified user name.</p> |

### Example

```
OS10(config)# username user10 sshkey filename /test_file.txt

OS10(config)# do show running-configuration users
username admin password 6q9QBeYjZ
$jfxzVqGhxxX3smxJSH9DDz7/30Jc6m5wjF8nnLD
7/VKx8SloIhp4NoGZs0I/UNwh8WVuxwfd9q4pWIgNs5BKH. role sysadmin

username user10 password 6rounds=656000$G10VRFTJB291ekwo
$iTGf0zd4bTUcBBpI
Vsbr6oStnUZMydN5lDs4WE6G3XHEtWbcKrGTeAo1wEF0cenEgRRPzi3SMmYyzAHCC8wS0
role
 sysadmin

username user10 sshkey filename /test_file.txt
```

**Supported Releases** 10.4.1.0 or later

## crypto ssh-key generate

Regenerates the public keys used in SSH authentication.

|                          |                                                                                                                                                                                                                                                                                                                                                                       |
|--------------------------|-----------------------------------------------------------------------------------------------------------------------------------------------------------------------------------------------------------------------------------------------------------------------------------------------------------------------------------------------------------------------|
| <b>Syntax</b>            | <code>crypto ssh-key generate {rsa bits   ecdsa bits   ed25519}</code>                                                                                                                                                                                                                                                                                                |
| <b>Parameters</b>        | <ul style="list-style-type: none"> <li>• <i>rsa bits</i> — Regenerates the RSA key with the specified bit size: 2048, 3072, or 4096; default 2048.</li> <li>• <i>ecdsa bits</i> — Regenerates the ECDSA key with the specified bit size: 256, 384, or 521; default 256.</li> <li>• <i>ed25519</i> — Regenerates the Ed25519 key with the default bit size.</li> </ul> |
| <b>Default</b>           | <p>The SSH server uses default public key lengths for client authentication:</p> <ul style="list-style-type: none"> <li>• RSA key: 2048 bits</li> <li>• ECDSA key : 256 bits</li> <li>• Ed25519 key: 256 bits</li> </ul>                                                                                                                                              |
| <b>Command Mode</b>      | EXEC                                                                                                                                                                                                                                                                                                                                                                  |
| <b>Usage Information</b> | <p>If necessary, you can regenerate the public keys used by the SSH server with a customized bit size. You cannot change the default size of the Ed25519 key. The <code>crypto ssh-key generate</code> command is available only to the <code>sysadmin</code> and <code>secadmin</code> roles.</p>                                                                    |

## Example

```
OS10# crypto ssh-key generate rsa 4096
Host key already exists. Overwrite [confirm yes/no]:yes
Generated 4096-bit RSA key
OS10#
```

**Supported Releases** 10.4.1.0 or later

## login concurrent-session limit

Configures the maximum number of concurrent login sessions allowed for a user ID.

**Syntax** `login concurrent-session limit number`

**Parameters** `limit number` — Enter the limit of concurrent login sessions, from 1 to 12.

**Default** 10 concurrent login sessions

**Command Mode** CONFIGURATION

**Usage Information** The total number of concurrent login sessions for the same user ID includes all console and remote connections, where:

- Each remote VTY connection counts as one login session.
- All login sessions from a terminal emulator on an attached console count as one session.

The `no` version of the command disables the configured number of allowed login sessions.

## Example

```
OS10(config)# login concurrent-session limit 7
```

**Supported Releases** 10.4.1.0 or later

## line vty

Enters virtual terminal line mode to access the virtual terminal (VTY).

**Syntax** `line vty`

**Parameters** None

**Default** Not configured

**Command Mode** CONFIGURATION

**Usage Information** None

## Example

```
OS10(config)# line vty
OS10(config-line-vty)#
```

**Supported Releases** 10.4.0E(R1) or later

## ipv6 access-class

Filters connections in a virtual terminal line using an IPv6 access list.

**Syntax** `ipv6 access-class access-list-name`

**Parameters** `access-list-name` — Enter the access list name.

**Default** Not configured

**Command Mode** LINE VTY CONFIGURATION



**Usage Information** The no version of this command removes the filter.

**Example**

```
OS10(config)# line vty
OS10(config-line-vty)# ipv6 access-class permit10
```

**Supported Releases** 10.4.0E(R1) or later

## ip access-class

Filters connections in a virtual terminal line using an IPv4 access list.

**Syntax** `ip access-class access-list-name`

**Parameters** *access-list-name* — Enter the access list name.

**Default** Not configured

**Command Mode** LINE VTY CONFIGURATION

**Usage Information** The no version of this command removes the filter.

**Example**

```
OS10(config)# line vty
OS10(config-line-vty)# ip access-class deny10
```

**Supported Releases** 10.4.0E(R1) or later

## Switch management statistics

OS10 monitors user and system activities and provides output-related user login statistics.

### Enable login statistics

To monitor system security, allow users to view their own login statistics when they sign in to the system. A large number of login failures or an unusual login location may indicate a system hacker. Enable the display of login information after a user successfully logs in; for example:

```
OS10 login: admin
Password:
Last login: Thu Nov 2 16:02:44 UTC 2017 on ttyS1
Linux OS10 3.16.43 #2 SMP Debian 3.16.43-2+deb8u5 x86_64
...
Time-frame for statistics : 25 days
Role changed since last login : false
Failures since last login : 0
Failures in time period : 1
Successes in time period : 14
OS10#
```

This feature is available only for the sysadmin and secadmin roles.

- Enable the display of login information in CONFIGURATION mode.

```
login-statistics enable
```

To display information about user logins, use the `show login-statistics` command.

### Enable login statistics

```
OS10(config)# login-statistics enable
```

To disable login statistics, use the `no login-statistics enable` command.

## Audit log

To monitor user activity and configuration changes on the switch, enable the audit log. Only the `sysadmin` and `secadmin` roles can enable, view, and clear the audit log.

The audit log records configuration and security events, including:

- User logins and logouts on the switch, failed logins, and concurrent login attempts by a user
- User-based configuration changes recorded with the user ID, date, and time of the change. The specific parameter changes are not logged.
- Establishment of secure traffic flows, such as SSH, and violations on secure flows
- Certificate issues, including user access and changes made to certificate installation using `crypto` commands
- Adding and deleting users

Audit log entries are saved locally and sent to configured Syslog servers. To set up a Syslog server, see [System logging](#).

### Enable audit log

- Enable configuration and security event recording in the audit log on Syslog servers in CONFIGURATION mode.

```
logging audit enable
```

To disable audit logging, use the `no logging audit enable` command.

### View audit log

- Display audit log entries in EXEC mode. By default, 24 entries are displayed, starting with the oldest event. Enter `reverse` to display entries starting with the most recent events. You can change the number of entries that display.

```
show logging audit [reverse] [number]
```

### Clear audit log

- Clear all events in the audit log in CONFIGURATION mode.

```
clear logging audit
```

### Example

```
OS10(config)# logging audit enable
OS10(config)# exit

OS10# show logging audit 4
<14>1 2019-02-14T13:15:06.283337+00:00 OS10 audispd - - - Node.1-Unit.1:PRI [audit],
Dell EMC (OS10) node=OS10 type=USER_END msg=audit(1550150106.277:597): pid=7908 uid=0
aid=4294967295 ses=4294967295 msg='op=PAM:session_close acct="admin" exe="/bin/su"
hostname=? addr=? terminal=??? res=success'
<110>1 2019-02-14T13:15:16.331515+00:00 OS10 .clish 7412 - - Node.1-Unit.1:PRI [audit],
User admin on console used cmd: 'crypto security-profile mltestprofile' - success
<110>1 2019-02-14T13:15:21.794529+00:00 OS10 .clish 7412 - - Node.1-Unit.1:PRI [audit],
User admin on console used cmd: 'exit' - success
<110>1 2019-02-14T13:16:05.882555+00:00 OS10 .clish 7412 - - Node.1-Unit.1:PRI [audit],
User admin on console used cmd: 'exit' - success

OS10# show logging audit reverse 4
<110>1 2019-02-14T13:16:05.882555+00:00 OS10 .clish 7412 - - Node.1-Unit.1:PRI [audit],
User admin on console used cmd: 'exit' - success
<110>1 2019-02-14T13:15:21.794529+00:00 OS10 .clish 7412 - - Node.1-Unit.1:PRI [audit],
User admin on console used cmd: 'exit' - success
<110>1 2019-02-14T13:15:16.331515+00:00 OS10 .clish 7412 - - Node.1-Unit.1:PRI [audit],
User admin on console used cmd: 'crypto security-profile mltestprofile' - success
<14>1 2019-02-14T13:15:06.283337+00:00 OS10 audispd - - - Node.1-Unit.1:PRI [audit],
Dell EMC (OS10) node=OS10 type=USER_END msg=audit(1550150106.277:597): pid=7908 uid=0
aid=4294967295 ses=4294967295 msg='op=PAM:session_close acct="admin" exe="/bin/su"
hostname=? addr=? terminal=??? res=success'OS10# show logging audit reverse 10
```

# Switch management statistics commands

## login-statistics enable

Enables the display of login statistics to users.

**Syntax** login-statistics enable

**Parameters** None

**Default** Disabled

**Command Mode** CONFIGURATION

**Usage Information** Only the `sysadmin` and `secadmin` roles have access to this command. When enabled, user login information, including the number of successful and failed logins, role changes, and the last time a user logged in, displays after a successful login. The `no login-statistics enable` command disables login statistics.

**Example**  
OS10(config)# login-statistics enable

**Supported Releases** 10.4.0E(R1) or later

## show login-statistics

Displays statistics on user logins to the system.

**Syntax** show login-statistics {user *user-id* | all}

- Parameters**
- `user user-id` — Enter an OS10 username.
  - `all` — Displays login statistics for all system users.

**Default** Not configured

**Command Mode** EXEC

**Usage Information** Only the `sysadmin` and `secadmin` roles can access this command. The `show` output displays login information for system users, including the number of successful and failed logins, role changes, and the last time a user logged in.

### Example

```
OS10# show login-statistics all
Display statistics upon user login: Enabled
Time-frame in days: 25

 #Fail
 since During
User Role last Timeframe Last Login Location

admin False 0 1 13 2017-11-02T16:02:44Z in
netadmin False 0 0 5 2017-11-02T15:59:04Z (00:00)
mltest False 0 0 1 2017-11-01T15:42:07Z 1001:10:16:210::4001

OS10# show login-statistics user mltest
User : mltest
Role changed since last login : False
Failures since last login : 0
Time-frame in days : 25
Failures in time period : 0
Successes in time period : 1
Last Login Time : 2017-11-01T15:42:07Z
Last Login Location : 1001:10:16:210::4001
```

## Supported Releases

10.4.0E(R1) or later

## clear logging audit

Deletes all events in the audit log.

**Syntax** clear logging audit

**Parameters** None

**Defaults** Not configured

**Command Mode** EXEC

**Usage Information** To display the contents of the audit log, use the `show logging audit` command.

### Example

```
OS10# clear logging audit
Proceed to clear all audit log messages [confirm yes/no(default)]:yes
```

**Supported Releases** 10.4.3.0 or later

## show logging audit

Displays audit log entries.

**Syntax** show logging audit [reverse] [number]

**Parameters**

- `reverse` — Display entries starting with the most recent events.
- `number` — Display the specified number of audit log entries users, from 1 to 65535.

**Default** Display 24 entries starting with the oldest events.

**Command Mode** EXEC

**Usage Information** Only the `sysadmin` and `secadmin` roles can display the audit log. Enter `reverse` to display entries starting with the most recent events. You can change the number of entries displayed. Audit log records do not display on the console as they occur. They are saved in the audit log and forwarded to any configured Syslog servers.

### Example

```
OS10# show logging audit 4
<14>1 2019-02-14T13:15:06.283337+00:00 OS10 audispd - - - Node.1-Unit.1:PRI [audit],
Dell EMC (OS10) node=OS10 type=USER_END msg=audit(1550150106.277:597): pid=7908 uid=0
aid=4294967295 ses=4294967295 msg='op=PAM:session_close acct="admin" exe="/bin/su"
hostname=? addr=? terminal=??? res=success'
<110>1 2019-02-14T13:15:16.331515+00:00 OS10 .clish 7412 - - Node.1-Unit.1:PRI [audit],
User admin on console used cmd: 'crypto security-profile mltestprofile' - success
<110>1 2019-02-14T13:15:21.794529+00:00 OS10 .clish 7412 - - Node.1-Unit.1:PRI [audit],
User admin on console used cmd: 'exit' - success
<110>1 2019-02-14T13:16:05.882555+00:00 OS10 .clish 7412 - - Node.1-Unit.1:PRI [audit],
User admin on console used cmd: 'exit' - success

OS10# show logging audit reverse 4
<110>1 2019-02-14T13:16:05.882555+00:00 OS10 .clish 7412 - - Node.1-Unit.1:PRI [audit],
User admin on console used cmd: 'exit' - success
<110>1 2019-02-14T13:15:21.794529+00:00 OS10 .clish 7412 - - Node.1-Unit.1:PRI [audit],
User admin on console used cmd: 'exit' - success
<110>1 2019-02-14T13:15:16.331515+00:00 OS10 .clish 7412 - - Node.1-Unit.1:PRI [audit],
User admin on console used cmd: 'crypto security-profile mltestprofile' - success
<14>1 2019-02-14T13:15:06.283337+00:00 OS10 audispd - - - Node.1-Unit.1:PRI [audit],
Dell EMC (OS10) node=OS10 type=USER_END msg=audit(1550150106.277:597): pid=7908 uid=0
aid=4294967295 ses=4294967295 msg='op=PAM:session_close acct="admin" exe="/bin/su"
hostname=? addr=? terminal=??? res=success'OS10# show logging audit reverse 10
```

## Supported Releases

10.4.3.0 or later

## logging audit enable

Enables recording of configuration and security event in the audit log.

|                           |                                                                                                                                                                                                                                              |
|---------------------------|----------------------------------------------------------------------------------------------------------------------------------------------------------------------------------------------------------------------------------------------|
| <b>Syntax</b>             | logging audit enable                                                                                                                                                                                                                         |
| <b>Parameters</b>         | None                                                                                                                                                                                                                                         |
| <b>Defaults</b>           | Not configured                                                                                                                                                                                                                               |
| <b>Command Mode</b>       | CONFIGURATION                                                                                                                                                                                                                                |
| <b>Usage Information</b>  | Audit log entries are saved locally and sent to configured Syslog servers. Only the <code>sysadmin</code> and <code>secadmin</code> roles can enable the audit log. The <code>no</code> version of the command disables audit log recording. |
| <b>Example</b>            | <pre>OS10(conf)# logging audit enable</pre>                                                                                                                                                                                                  |
| <b>Supported Releases</b> | 10.4.3.0 or later                                                                                                                                                                                                                            |

## X.509v3 certificates

OS10 supports X.509v3 certificates to secure communications between the switch and a host, such as a RADIUS server. Both the switch and the server exchange a public key in a signed X.509v3 certificate issued by a certificate authority (CA) to authenticate each other. The certificate authority uses its private key to sign the switch and host certificates.

The information in the certificate allows both devices to prove ownership and the validity of a public key. Assuming the CA is trusted, the switch and authentication server validate each other's identity and set up a secure, encrypted communications channel.

User authentication with a public key certificate is usually preferred over password-based authentication, although you can use both at the same time, to:

- Avoid the security risk of using low-strength passwords and provide greater resistance to brute-force attacks.
- Provide assurance of trusted, provable identities (when using certificates digitally signed by a trusted CA).
- Provide security and confidentiality in switch-server communications in addition to user authentication.

For example, you can download and install a X.509v3 certificate to enable public-key authentication in [RADIUS over TLS authentication](#) — also called RadSec. OS10 supports a public key infrastructure (PKI), including:

- Generation of self-signed certificates and certificate signing requests (CSRs), and their corresponding private keys
- Installation and deletion of self-signed certificates and CA-signed certificates
- Secure deletion of corresponding private keys
- Installation and deletion of CA certificates in the system "trust store"
- Display of certificate information

## X.509v3 concepts

|                                   |                                                                                                                                                                                                                                                                                                                                                                                                                                                                                                                                                                                                                                                                                                                                                                                 |
|-----------------------------------|---------------------------------------------------------------------------------------------------------------------------------------------------------------------------------------------------------------------------------------------------------------------------------------------------------------------------------------------------------------------------------------------------------------------------------------------------------------------------------------------------------------------------------------------------------------------------------------------------------------------------------------------------------------------------------------------------------------------------------------------------------------------------------|
| <b>Certificate</b>                | <p>A document that associates a network device with its public key. When exchanged between participating devices, certificates are used to validate device identity and the public key associated with the device. A PKI uses the following certificate types:</p> <ul style="list-style-type: none"><li>• CA certificate: The certificate of a CA that is used to sign host certificates. A CA certificate may be issued by other CAs or be self-signed. A self-signed CA certificate is called a <i>root certificate</i>.</li><li>• Host certificate: A certificate that is issued to a network device. A host certificate may be signed by a CA or self-signed.</li><li>• Self-signed certificate: A host-signed certificate, compared to a CA-signed certificate.</li></ul> |
| <b>Certificate authority (CA)</b> | <p>An entity that verifies the contents of a certificate and signs it, indicating that the certificate is trusted and correct. An intermediate CA signs certificates transmitted between a root CA and a host.</p>                                                                                                                                                                                                                                                                                                                                                                                                                                                                                                                                                              |

|                                          |                                                                                                                                                                                                                                                                                                                                                                                                                                                  |
|------------------------------------------|--------------------------------------------------------------------------------------------------------------------------------------------------------------------------------------------------------------------------------------------------------------------------------------------------------------------------------------------------------------------------------------------------------------------------------------------------|
| <b>Certificate revocation list (CRL)</b> | A CA-signed document that contains a list of certificates that are no longer valid, even though they have not yet expired. For example, when a new certificate is generated for a server, and the old certificate is no longer supported.                                                                                                                                                                                                        |
| <b>Certificate signing request (CSR)</b> | After generating a key pair, a switch signs a request to obtain a certificate using its secret private key, and sends the request to a certificate authority. The CSR contains information that identifies the switch and its public key. This public key is used to verify the private signature of the CSR and the distinguished name (DN) of the switch. A CSR is signed by a CA and returned to a host for use as a signed host certificate. |
| <b>Privacy Enhanced Mail (PEM)</b>       | PKI standard used to format X.509v3 data in a secure message exchange; described in RFC 1421.                                                                                                                                                                                                                                                                                                                                                    |
| <b>Public key infrastructure (PKI)</b>   | Application that manages the generation of private and public encryption keys, and the download, installation, and exchange of CA-signed certificates with network devices.                                                                                                                                                                                                                                                                      |
| <b>X.509v3</b>                           | Standard for the public key infrastructure that manages digital certificates and public key encryption.                                                                                                                                                                                                                                                                                                                                          |

## Public key infrastructure

To use X.509v3 certificates for secure communication and user authentication on OS10 switches in a network, a public key infrastructure (PKI) with a certificate authority (CA) is required. The CA signs certificates that prove the trustworthiness of network devices.

When an organization wants to assure customers that the connection to their network is secure, it may pay a commercial Certificate Authority, such as VeriSign or DigiCert, to sign a certificate for their domain. However, to implement an X.509v3 infrastructure, you can act as your own CA. While acting as your own CA, you can set up CAs to issue certificates to hosts in the same trusted domain to authenticate each other.

### X.509v3 public key infrastructure

To set up a PKI using X.509v3 certificates, Dell EMC Networking recommends:

1. Configure a root CA that generates a private key and a self-signed CA certificate.
2. Configure one or more intermediate CAs that generate a private key and a certificate signing request (CSR), and send the CSR to the root CA.
  - Using its private key, the root CA signs an intermediate CA's CSR and generates a CA certificate for the intermediate CA.
  - The intermediate CA downloads and installs the CA certificate. Afterwards, the intermediate CA can sign certificates for hosts in the network and for other intermediate CAs that are lower in the PKI hierarchy.
  - The root and intermediate CA certificates, but not the corresponding private keys, are made publicly available on the network for network hosts to download.
  - Whenever possible, store private keys offline or in a location restricted from general access.
3. Generate private keys and create CSRs on OS10 switches using the `crypto cert generate request` command. A switch uploads a CSR to an intermediate CA. To store the private key in a local hidden location, Dell EMC Networking recommends using the `key-file private` parameter with the command.
4. Download and install a CA certificate on a host using the `crypto ca-cert install` command. After you install a CA certificate, a host trusts any certificates that are signed by the CA and presented by other network devices. You must first download a certificate to the home directory, and then install the certificate using the `crypto ca-cert install` command.
5. Download and install a signed host certificate and private key from an intermediate CA on an OS10 switch. Then install them using the `crypto cert install` command. After you install the host certificate, OS10 applications use the certificate to secure communication with network devices. The private key is installed in the internal file system on the switch and cannot be exported or viewed.

## Manage CA certificates

OS10 supports the download and installation of public X.509v3 certificates from external certificate authorities.

In a data center environment, trusted CA servers can create CA certificates. A host operates as a trusted CA server. Network hosts install certificates that are digitally signed with the CA's private key to establish trust between participating devices in the network. The certificate on an OS10 switch is used to verify the certificates presented by clients and servers, such as Syslog and RADIUS servers, to establish a secure connection with these devices.

To import a CA server certificate:

1. Use the `copy` command to download an X.509v3 certificate created by a CA server using a secure method, such as HTTPS, SCP, or SFTP. Copy the CA certificate to the local directory on the switch, such as `home://` or `usb://`.
2. Use the `crypto ca-cert install` command to install the certificate. When you install a CA certificate, specify the local path where the certificate is stored.

The switch verifies the certificate and installs it in an existing directory of trusted certificates in PEM format.

### Install CA certificate

- Install a CA certificate in EXEC mode.

```
crypto ca-cert install ca-cert-filepath [filename]
```

- `ca-cert-filepath` specifies the local path to the downloaded certificate; for example, `home://CAcert.pem` or `usb://CA-cert.pem`.
- `filename` specifies an optional filename that the certificate is stored under in the OS10 trust-store directory. Enter the filename in the `filename.crt` format.

### Example: Download and install CA certificate

```
OS10# copy scp://tftpuser@10.11.178.103:/tftpboot/certs/Dell_rootCA1.pem home://
Dell_rootCA1.pem
password:

OS10# crypto ca-cert install home://Dell_rootCA1.pem
Processing certificate ...
Installed Root CA certificate
 CommonName = Dell_rootCA1
 IssuerName = Dell_rootCA1
```

### Display CA server certificate

```
OS10# show crypto ca-certs

Locally installed certificates
Dell_rootCA1.crt
```

```
OS10# show crypto ca-certs Dell_rootCA1.crt
Certificate:
 Data:
 Version: 3 (0x2)
 Serial Number:
 95:48:23:17:76:9d:05:e1
 Signature Algorithm: sha256WithRSAEncryption
 Issuer: C = US, ST = California, L = Santa Clara, O = Dell EMC, OU = Networking,
CN = Dell_rootCA1
 Validity
 Not Before: Jul 25 18:21:50 2018 GMT
 Not After : Jul 20 18:21:50 2038 GMT
 Subject: C = US, ST = California, L = Santa Clara, O = Dell EMC, OU =
Networking, CN = Dell_rootCA1
 Subject Public Key Info:
 Public Key Algorithm: rsaEncryption
 Public-Key: (4096 bit)
 Modulus:
 00:cd:9d:ca:10:6b:b1:54:81:10:92:42:9f:6a:cb:
 49:51:9d:46:10:cb:67:08:2b:75:2a:62:40:80:a3:
 f5:7d:58:67:f4:cc:c6:70:32:14:4c:f0:4d:cd:7e:
 0d:5c:63:28:5e:6c:ad:9e:13:13:71:6d:9d:10:a9:
 a1:d8:6b:bd:a3:a0:5a:11:19:87:4d:3d:08:6f:10:
 03:df:70:89:5f:b7:56:49:32:57:9c:28:5e:43:7f:
 ca:bc:41:c7:31:51:97:7f:73:b7:b0:c4:13:21:e6:
 2c:4c:19:fd:35:0b:26:16:78:fc:c3:73:21:3a:06:
 f6:ec:87:3f:9f:5e:3a:0c:23:5e:13:4c:9e:5a:70:
 18:d4:ad:cb:cf:47:c1:c6:50:a0:49:df:a0:a6:47:
 1e:13:19:49:9e:67:db:1c:c7:23:9e:37:3b:c7:0c:
 cd:26:46:f6:c1:e1:93:64:29:81:9c:e9:a8:1d:29:
 19:4c:8d:a4:a8:53:66:2b:b2:70:ff:ec:80:d4:87:
```

```
eb:74:e2:11:56:ed:4b:68:fc:53:2e:d4:94:f6:f5:
e4:77:d9:b6:e8:4a:91:b7:da:46:18:51:bf:e4:b6:
3e:6a:47:ab:77:f6:93:b7:d0:9a:c8:fa:ba:ae:ed:
6a:fd:81:54:c8:76:13:1b:57:74:d6:02:78:d7:98:
38:e6:c5:9b:64:03:b2:76:93:fd:8c:9f:54:c9:a3:
04:a9:0c:b7:e2:bb:02:50:3f:e0:08:33:32:89:55:
95:9b:30:6c:73:7d:be:63:f1:6c:da:4d:92:41:d0:
f5:d6:bf:e3:c0:da:98:ae:24:37:ed:07:63:86:a1:
cc:da:3b:45:d4:a9:80:e2:d6:ab:c1:ae:2a:99:32:
9d:ba:fe:88:38:f2:02:d1:b3:78:43:17:7e:6e:b1:
a2:17:85:bd:5f:4a:52:90:96:4d:bc:19:85:ed:9d:
49:77:bd:59:44:6c:6c:23:e5:b1:92:af:a0:10:ce:
68:d4:f4:07:9e:ec:ca:c5:95:a2:f4:19:bb:f7:12:
ce:f0:a6:39:df:1a:5b:10:91:d5:77:46:8d:55:9a:
8e:96:e0:70:f6:27:89:43:3d:74:99:b4:7f:4b:38:
71:18:01:64:bb:72:2c:26:6f:6e:e8:06:9a:77:4b:
07:3b:b3:8c:71:ff:61:1b:84:d4:02:46:47:e5:4d:
79:be:22:e9:7a:8c:eb:06:38:38:a6:f7:b7:83:bf:
f2:64:c9:b8:d9:7f:d1:cc:87:ac:80:b0:d0:d3:17:
35:d1:49:44:2e:6e:9f:60:9c:ca:9a:6d:cd:63:79:
7c:6d:33:72:13:74:f1:16:20:50:46:20:e7:c1:ff:
b0:42:95
Exponent: 65537 (0x10001)
X509v3 extensions:
 X509v3 Subject Key Identifier:
 75:22:3F:BE:99:B7:FA:A1:5B:1D:68:0B:E9:5E:21:7D:83:62:AC:DB
 X509v3 Authority Key Identifier:
 keyid:75:22:3F:BE:99:B7:FA:A1:5B:1D:68:0B:E9:5E:21:7D:83:62:AC:DB
 X509v3 Basic Constraints: critical
 CA:TRUE
 X509v3 Key Usage: critical
 Digital Signature, Certificate Sign, CRL Sign
Signature Algorithm: sha256WithRSAEncryption
8e:0c:50:18:5f:db:cc:80:5c:6e:ce:43:29:32:2e:0b:70:96:
db:e8:23:c9:15:a2:99:72:d6:01:c9:61:8e:ed:8d:f8:4d:2f:
99:57:bf:52:1f:4a:5b:7b:ff:24:23:5f:eb:3e:e8:8e:0c:d4:
94:0f:20:a7:e3:3b:18:e9:76:06:5a:ae:65:38:d4:3a:98:d6:
0b:73:5b:b5:8e:4c:b5:74:02:9a:9d:9a:7d:7a:18:2f:32:38:
9e:0e:7b:de:15:3c:f1:33:e8:2d:3f:92:f0:f2:4e:7a:7f:e2:
a5:2e:04:3a:2f:3b:1b:05:71:39:70:6d:a4:6e:8f:25:31:0e:
2c:8a:7e:b4:30:7c:38:2f:48:df:19:56:42:4f:be:5f:d3:02:
70:18:7e:76:66:ca:13:1c:e3:9c:4d:aa:d3:67:96:be:d9:49:
5c:69:10:75:26:53:f7:50:39:06:15:d1:3a:87:47:f6:92:a2:
d4:91:35:29:b7:4b:ea:56:4c:13:5e:32:7f:c7:3f:4c:46:67:
54:8d:67:60:38:98:75:da:24:f2:64:b9:24:a1:e3:5b:42:66:
4c:c7:cb:ee:c3:ca:bd:87:1b:7a:fc:35:53:2d:74:68:db:a7:
47:db:03:a3:30:52:af:67:7f:54:a4:de:60:ca:ae:94:43:f8:
98:85:fc:18:9b:b1:db:81:44:57:0b:be:6a:56:9d:2f:7d:75:
c2:22:a4:7c:d7:ee:f8:de:10:11:26:60:35:1c:4c:87:2e:a2:
fb:1f:5f:30:6c:11:c1:fa:f2:5b:46:02:0a:18:2f:02:a4:99:
f2:43:29:cf:e6:5b:8a:d0:ec:42:bf:49:c6:8a:7e:b4:53:38:
03:1b:fd:a9:49:88:b5:f1:42:93:c7:78:38:6c:2a:1c:be:83:
97:27:b1:26:eb:16:44:ce:34:02:53:45:08:30:c9:3a:76:83:
10:f3:af:c7:6f:0c:74:ec:81:ea:d9:c4:20:a5:1d:72:64:52:
7b:e8:30:1a:9e:3a:05:9c:8a:69:e5:b7:43:b3:36:08:f2:e0:
fb:88:d9:c1:b6:f4:4a:23:27:31:3a:51:b3:68:c9:6f:3e:f5:
dd:98:4d:07:38:ed:f4:d3:ed:06:4c:84:87:3d:cf:f3:2e:e5:
1a:b6:00:71:4c:51:35:c8:95:e4:c6:7e:82:47:d3:25:64:a4:
0b:31:53:d0:e4:6b:97:98:21:4b:fc:e7:12:be:69:01:d8:b5:
74:f5:b6:39:22:8a:8c:39:23:0f:be:4b:0f:9a:01:ac:b8:5b:
12:cb:94:06:30:f5:74:45:20:af:ab:d6:af:21:0c:d8:62:84:
18:c2:cf:4f:be:73:c9:33
```

### Delete CA server certificate

```
OS10# crypto ca-cert delete Dell_rootCA1.crt
Successfully removed certificate
```



## Certificate revocation

Before the switch and an external device, such as a RADIUS or TLS server, set up a secure connection, they present CA-signed certificates to each other. The certificate validation allows peers to authenticate each other's identity, and is followed by checking to ensure that the certificate has not been revoked by the issuing CA.

A certificate includes the URL and other information about the certificate distribution point (CDP) that issued the certificate. Using the URL, OS10 accesses the CDP to download a certificate revocation list (CRL). If the external device's certificate is on the list or if the CDP server does not respond, the connection is not set up.

A certificate revocation list contains a list of all revoked certificates. The CA that issued the certificates maintains the CRL. CAs publish a new CRL at periodic intervals. An OS10 switch automatically downloads the new CRL and uses it to verify certificates presented by connecting devices.

When a CA issues a certificate, it usually includes the CRL distribution point in the certificate. OS10 uses the CDP URL to access the server with the current CRL. OS10 supports using multiple CDPs and CRLs during a CRL revocation check. If a CRL check validates a certificate from an external device, OS10 sets up a secure connection to perform the tasks initiated by the application.

Like CA certificates, CRLs are maintained in the trust store on the switch and applied to all PKI-enabled applications. To use CRLs to validate certificates presented by external devices:

1. Configure the URL for a certificate distribution point in EXEC mode.

```
crypto cdp add cdp-name cdp-url
```

Verify the CDPs accessed by the switch in EXEC mode.

```
show crypto cdp [cdp-name]
```

To delete an installed CDP, use the `crypto cdp delete cdp-name` command.

2. Install CRLs that have been downloaded from CDPs in EXEC mode.

```
crypto crl install crl-path [crl-filename]
```

Display a list of the CRLs installed on the switch in EXEC mode.

```
show crypto crl [crl-filename]
```

To delete a manually installed CRL that was configured with the `crypto crl install` command, use the `crypto crl delete [crl-filename]` command.

To enable CRL checking on the switch, see [Security profiles](#).

### Example: Configure CDP

```
OS10# crypto cdp add cert1_cdp http://crl.chambersign.org/chambersignroot.crl
Successfully added CDP
```

```
OS10# show crypto cdp
```

```

Manually installed CDPs
cert1_cdp.crl_url

Automatically installed CDPs
```

### Example: Install CRL

```
OS10# crypto crl install home://pki-regression/Network_Solutions_Certificate_
Authority.0.crl.pem
Processing file ...
```

```
issuer=C=US,O=Network Solutions L.L.C.,CN=Network Solutions Certificate
Authority.0.crl.pem
lastUpdate=Jul 7 04:15:08 2019 GMT
nextUpdate=Jul 11 04:15:08 2019 GMT
```

```
OS10# show crypto crl

Manually installed CRLs
Network_Solutions_Certificate_Authority.0.crl.pem

Downloaded CRLs
```

## Request and install host certificates

OS10 also supports the switch obtaining its own X.509v3 host certificate. In this procedure, you generate a certificate signing request (CSR) and a private key. Store the private key locally in a secure location. Copy the CSR file to a certificate authority. The CA generates a host certificate for an OS10 switch by digitally signing the switch certificate contained in the CSR.

The administrator then copies the CA-signed host certificate to the home directory on the switch. Because a local private key is created when the CSR is generated, it is not necessary to install a private key using an uploaded file.

The switch presents its own host certificate to clients that require authentication, such as Syslog and RADIUS servers over TLS and HTTPS connections. The certificate is digitally signed with the private key of the OS10 switch. OS10 supports multiple host certificates so that you can use different certificates with different applications. For more information, see [Security profiles](#).

To obtain a host certificate from a CA:

1. Create a private key and generate a certificate signing request for the switch.
2. Copy the CSR file to a CA server.
3. Copy the CA-signed certificate to the home directory on the switch. Install the trusted certificate.

### Generate a certificate signing request and private key

- Create a private key and a CSR in EXEC mode. Store the CSR file in the home directory or `flash:` so that you can later copy it to a CA server. Specify a `keypath` to store the `device.key` file in a secure persistent location, such as the home directory, or use the `private` option to store the key file in a private hidden location in the internal file system that is not visible to users.

```
crypto cert generate request [cert-file cert-path key-file {private | keypath}]
[country 2-letter code] [state state] [locality city] [organization organization-name]
[orgunit unit-name] [cname common-name] [email email-address] [validity days]
[length length] [altname alt-name]
```

If you enter the `cert-file` option, you must enter all the required parameters, such as the local paths where the certificate and private key are stored, country code, state, locality, and other values.

If you do not specify the `cert-file` option, you are prompted to fill in the other parameter values for the certificate interactively; for example:

```
You are about to be asked to enter information that will be incorporated into your
certificate request.
What you are about to enter is what is called a Distinguished Name or a DN.
There are quite a few fields but you can leave some blank.
For some fields there will be a default value; if you enter '.', the field will be
left blank.
Country Name (2 letter code) [US]:
State or Province Name (full name) [Some-State]:California
Locality Name (eg, city) []:San Francisco
Organization Name (eg, company) []:Starfleet Command
Organizational Unit Name (eg, section) []:NCC-1701A
Common Name (eg, YOUR name) [hostname]:S4148-001
Email Address []:scotty@starfleet.com
```

The switch uses SHA-256 as the digest algorithm. The public key algorithm is RSA with a 2048-bit modulus. The `KeyUsage` bits of the certificate assert `keyEncipherment` (bit 2) and `keyAgreement` (bit 4). The `keyCertSign` bit (bit 5) is NOT set. The `ExtendedKeyUsage` fields indicate `serverAuth` and `clientAuth`.

The attribute `CA:FALSE` is set in the Extensions section of the certificate. The certificate is NOT used to validate other certificates.

- If necessary, re-enter the command to generate multiple certificate-key pairs for different applications on the switch. You can configure a certificate-key pair in a security profile. Using different certificate-key pairs is necessary if you want to change the certificate-key pair for a specified application without interrupting other critical services. For example, RADIUS over TLS may use a different certificate-key pair than SmartFabric services.

**NOTE:**

If the system is in FIPS mode using the `crypto fips enable` command, the CSR and private key are generated using FIPS-validated and compliant algorithms. You manage whether the keys are generated in FIPS mode or not.

### Copy CSR to the CA server

You can copy the CSR from flash to a destination, such as a USB flash drive, using TFTP, FTP, or SCP.

```
OS10# copy home://DellHost.pem scp://tftpuser@10.11.178.103:/tftpboot/certs/
DellHost.pem
password:
```

The CA server signs the CSR with its private key. The CA server then makes the signed certificate available for the OS10 switch to download and install.

### Install host certificate

1. Use the `copy` command to download an X.509v3 certificate signed by a CA server to the local home directory using a secure method, such as HTTPS, SCP, or SFTP.
  2. Use the `crypto cert install` command to install the certificate and the private key generated with the CSR.
- Install a trusted certificate and key file in EXEC mode.

```
crypto cert install cert-file home://cert-filepath key-file {key-path | private}
[password passphrase] [fips]
```

- `cert-file cert-filepath` specifies a source location for a downloaded certificate; for example, `home://s4048-001-cert.pem` or `usb://s4048-001-cert.pem`.
- `key-file {key-path | private}` specifies the local path to retrieve the downloaded or locally generated private key. Enter `private` to install the key from a local hidden location and rename the key file with the certificate name.
- `password passphrase` specifies the password used to decrypt the private key if it was generated using a password.
- `fips` installs the certificate-key pair as FIPS-compliant. Enter `fips` to install a certificate-key pair that is used by a FIPS-aware application, such as RADIUS over TLS. If you do not enter `fips`, the certificate-key pair is stored as a non-FIPS-compliant pair.

**NOTE:** You determine if the certificate-key pair is generated as FIPS-compliant. Do not use FIPS-compliant certificate-key pairs outside of FIPS mode. When FIPS mode is enabled, you can still generate CSRs for non-FIPS certificates for use with non-FIPS applications. Be sure to install these certificates as non-FIPS with the `crypto cert install` command.

- If you enter `fips` after using the `key-file private` option in the `crypto cert generate request` command, a FIPS-compliant private key is stored in a hidden location in the internal file system that is not visible to users.

If the certificate installation is successful, the file name of the host certificate and its common name are displayed. Use the filename to configure the certificate in a security profile using the `crypto security-profile` command.

### Example: Generate CSR and upload to server

```
OS10# crypto cert generate request cert-file home://DellHost.pem key-file home://
DellHost.key email admin@dell.com length 1024 altname DNS:dell.domain.com
Processing certificate ...
Successfully created CSR file /home/admin/DellHost.pem and key

OS10# copy home://DellHost.pem scp://tftpuser@10.11.178.103:/tftpboot/certs/
DellHost.pem
password:
```

### Host certificate tip

When administering a large number of switches, you may choose to not generate numerous CSRs for all switches. An alternate method to installing a host certificate on each switch is to generate both the private key file and CSR offline; for example, on the CA server. The CSR is signed by the CA, which generates both a certificate and key file. You then copy the trusted certificate and key file to the switch using the `copy` command and install them using the `crypto cert install cert-file home://cert-filename key-file home://key-filename` command.

 **NOTE:** For security reasons, the private key file is copied to an internal, secure location and removed from the viewable file system.

### Example: Download and install trusted certificate and private key

```
OS10# copy scp:///tftpuser@10.11.178.103:/tftpboot/certs/Dell_host1_CA1.pem home://
Dell_host1_CA1.pem
password:

OS10# copy scp:///tftpuser@10.11.178.103:/tftpboot/certs/Dell_host1_CA1.key home://
Dell_host1_CA1.key
password:

OS10# crypto cert install cert-file home://Dell_host1_CA1.pem key-file home://
Dell_host1_CA1.key
Processing certificate ...
Certificate and keys were successfully installed as "Dell_host1_CA1.pem" that may be
used in a
security profile. CN = Dell_host1_CA1
```

### Display trusted certificates

```
OS10# show crypto cert

Installed non-FIPS certificates
Dell_host1_CA1.pem

Installed FIPS certificates
```

```
OS10# show crypto cert Dell_host1_CA1.pem
----- Non FIPS certificate -----
Certificate:
 Data:
 Version: 3 (0x2)
 Serial Number: 4096 (0x1000)
 Signature Algorithm: sha256WithRSAEncryption
 Issuer: C = US, ST = California, O = Dell EMC, OU = Networking, CN =
Dell_interCA1
 Validity
 Not Before: Jul 25 19:11:19 2018 GMT
 Not After : Jul 22 19:11:19 2028 GMT
 Subject: C = US, ST = California, L = Santa Clara, O = Dell EMC, OU =
Networking, CN = Dell_host1_CA1
 Subject Public Key Info:
 Public Key Algorithm: rsaEncryption
 Public-Key: (2048 bit)
 Modulus:
 00:e7:81:4b:4a:12:8d:ce:88:e6:73:3f:da:19:03:
 c6:56:01:19:b2:02:61:3f:5b:1e:33:28:a1:ed:e3:
 85:bc:56:fb:18:d5:16:2e:a0:e7:3a:f9:34:b4:df:
 37:97:93:a9:b9:94:b2:9f:69:af:fa:31:77:68:06:
 89:7b:6d:fc:91:14:4a:c8:7b:23:93:f5:44:5a:0a:
 3f:ce:9b:af:a6:9b:49:29:fd:fd:cb:34:40:c4:02:
 30:95:37:28:50:d8:81:fb:1f:83:88:d9:1f:a3:0e:
 49:a1:b3:df:90:15:d4:98:2b:b2:38:98:6e:04:aa:
 bd:92:1b:98:48:4d:08:49:69:41:4e:6a:ee:63:d8:
 2a:9f:e6:15:e2:1d:c3:89:f5:f0:d0:fb:c1:9c:46:
 92:a9:37:b9:2f:a0:73:cf:e7:d1:88:96:b8:4a:84:
 91:83:8c:f0:9a:e0:8c:6e:7a:fa:6e:7e:99:3a:c3:
 2c:04:f9:06:8e:05:21:5f:aa:6e:9f:b7:10:37:29:
 0c:03:14:a0:9d:73:1f:95:41:39:9b:96:30:9d:0a:
 cb:d0:65:c3:59:23:01:f7:f5:3a:33:b9:e9:95:11:
 0c:51:f4:e9:1e:a5:9d:f7:95:84:9c:25:74:0c:21:
 4f:8b:07:29:2f:e3:47:14:50:8b:03:c1:fb:83:85:
 dc:bb
 Exponent: 65537 (0x10001)
 X509v3 extensions:
 X509v3 Basic Constraints:
 CA:FALSE
```

```

Netscape Cert Type:
 SSL Client, S/MIME
Netscape Comment:
 OpenSSL Generated Client Certificate
X509v3 Subject Key Identifier:
 4A:20:AA:E1:69:BF:BE:C5:66:2E:22:71:70:B4:7E:32:6F:E0:05:28
X509v3 Authority Key Identifier:
 keyid:A3:39:CB:C7:76:86:3B:05:44:34:C2:6F:90:73:1F:5F:64:55:5C:76
X509v3 Key Usage: critical

```

### Delete trusted certificate

```

OS10# OS10# crypto cert delete Dell_host1_CA1.pem
Certificate and keys were successfully deleted. CN = Dell_host1_CA1

```

## Self-signed certificates

Administrators may prefer to not set up a Certificate Authority and implement a certificate trust model in the network, but still want to use the privacy features provided by the Transport Layer Security (TLS) protocol. In this case, self-signed certificates can be used.

A self-signed certificate is not signed by a CA. The switch presents itself as a trusted device in its certificate. Connecting clients may prompt their users to trust the certificate — for example, when a web browser warns that a site is unsafe — or to reject the certificate, depending on the configuration. A self-signed certificate does not provide protection against man-in-the-middle attacks.

To generate and install a self-signed certificate:

1. Create a self-signed certificate and key in a local directory or USB flash drive.
2. Install the self-signed certificate.

### Generate a self-signed certificate

- Create a self-signed certificate in EXEC mode. Store the `device.key` file in a secure, persistent location, such as NVRAM.

```

crypto cert generate self-signed [cert-file cert-path key-file {private | keypath}]
[country 2-letter code] [state state] [locality city] [organization organization-name]
[orgunit unit-name] [cname common-name] [email email-address] [validity days]
[length length] [altname alt-name]

```

If you enter the `cert-file` option, you must enter all the required parameters, including the local path where the certificate and private key are stored.

If you do specify the `cert-file` option, you are prompted to enter the other parameter values for the certificate interactively; for example:

```

You are about to be asked to enter information that will be incorporated in your
certificate request.
What you are about to enter is what is called a Distinguished Name or a DN.
There are quite a few fields but you can leave some blank.
For some fields there will be a default value; if you enter '.', the field will be
left blank.
Country Name (2 letter code) [US]:
State or Province Name (full name) [Some-State]:California
Locality Name (eg, city) []:San Francisco
Organization Name (eg, company) []:Starfleet Command
Organizational Unit Name (eg, section) []:NCC-1701A
Common Name (eg, YOUR name) [hostname]:S4148-001
Email Address []:scotty@starfleet.com

```

The switch uses SHA-256 as the digest algorithm. The public key algorithm is RSA with a 2048-bit modulus.

- i** **NOTE:** When using self-signed X.509v3 certificates with Syslog and RADIUS servers, configure the server to accept self-signed certificates. Syslog and RADIUS servers require mutual authentication, which means that the client and server must verify each other's certificates. Dell EMC Networking recommends configuring a CA server to sign certificates for all trusted devices in the network.

### Install self-signed certificate

- Install a self-signed certificate and key file in EXEC mode.

```
crypto cert install cert-file home://cert-filename key-file {key-path | private}
[password passphrase] [fips]
```

- `cert-file cert-path` specifies a source location for a downloaded certificate; for example, `home://s4048-001-cert.pem` or `usb://s4048-001-cert.pem`.
- `key-file {key-path | private}` specifies the local path to retrieve the downloaded or locally generated private key. Enter `private` to install the key from a local hidden location and rename the key file with the certificate name.
- `password passphrase` specifies the password used to decrypt the private key if it was generated using a password.
- `fips` installs the certificate-key pair as FIPS-compliant. Enter `fips` to install a certificate-key pair that is used by a FIPS-aware application, such as RADIUS over TLS. If you do not enter `fips`, the certificate-key pair is stored as a non-FIPS compliant pair.

**i** **NOTE:** You determine if the certificate-key pair is generated as FIPS-compliant. Do not use FIPS-compliant certificate-key pairs outside of FIPS mode.

- If you enter `fips` after using the `key-file private` option in the `crypto cert generate request` command, a FIPS-compliant private key is stored in a hidden location in the internal file system that is not visible to users.

If the certificate installation is successful, the file name of the self-signed certificate and its common name are displayed. Use the file name to configure the certificate in a security profile using the `crypto security-profile` command.

### Example: Generate and install self-signed certificate and key

```
OS10# crypto cert generate self-signed cert-file home://DellHost.pem key-file home://
DellHost.key email admin@dell.com length 1024 altname DNS:dell.domain.com validity 365
Processing certificate ...
Successfully created certificate file /home/admin/DellHost.pem and key
```

```
OS10# crypto cert install cert-file home://DellHost.pem key-file home://DellHost.key
Processing certificate ...
Certificate and keys were successfully installed as "DellHost.pem" that may be used in a
security profile. CN = DellHost.
```

### Display self-signed certificate

```
OS10# show crypto cert

Installed non-FIPS certificates
DellHost.pem

Installed FIPS certificates
```

```
OS10# show crypto cert DellHost.pem
----- Non FIPS certificate -----
Certificate:
 Data:
 Version: 3 (0x2)
 Serial Number: 245 (0xf5)
 Signature Algorithm: sha256WithRSAEncryption
 Issuer: emailAddress = admin@dell.com
 Validity
 Not Before: Feb 11 20:10:12 2019 GMT
 Not After : Feb 11 20:10:12 2020 GMT
 Subject: emailAddress = admin@dell.com
 Subject Public Key Info:
 Public Key Algorithm: rsaEncryption
 Public-Key: (1024 bit)
 Modulus:
 00:c7:12:ca:a8:d6:d2:1c:ab:66:9a:d1:db:50:5a:
 b5:8a:e4:53:9d:f6:b4:fc:cd:f4:b9:46:8a:03:86:
 be:0b:50:51:c7:25:76:9f:ff:b4:f9:f8:d9:6f:5d:
 53:52:0c:4d:05:ed:31:23:79:44:5c:d7:62:01:9d:
 41:e8:ff:3a:b0:35:0c:22:d7:ef:df:05:9a:28:6b:
 95:10:8e:bc:c6:62:3a:82:30:0f:4f:4e:19:17:48:
 f1:bd:1e:0c:4f:54:03:42:f3:a7:de:22:40:3d:5e:
 6b:b2:8e:23:17:53:ef:10:d9:ae:1d:1f:d6:e4:ae:
```

```

 25:9f:d9:39:60:5c:49:b0:ad
 Exponent: 65537 (0x10001)
 X509v3 extensions:
 X509v3 Subject Key Identifier:
 DA:39:A3:EE:5E:6B:4B:0D:32:55:BF:EF:95:60:18:90:AF:D8:07:09
 X509v3 Subject Alternative Name:
 DNS:dell.domain.com
 Signature Algorithm: sha256WithRSAEncryption
 b8:83:ae:34:bb:84:e6:b4:a3:fd:77:20:67:15:3f:02:76:ca:
 f6:74:d4:d2:36:0e:58:8c:96:13:c2:85:8a:df:ba:c0:d9:c8:

```

## Security profiles

To use independent sets of security credentials for different OS10 applications, you can configure multiple security profiles and assign them to OS10 applications. A security profile consists of a certificate and private key pair.

For example, you can maintain different security profiles for RADIUS over TLS authentication and SmartFabric services. You can assign a security profile to an application when you configure the profile.

When you install a certificate-key pair, both take the name of the certificate. For example, if you install a certificate using:

```
OS10# crypto cert install cert-file home://Dell_host1.pem key-file home://abcd.key
```

The certificate-key pair is installed as `Dell_host1.pem` and `Dell_host1.key`. In configuration commands, refer to the pair as `Dell_host1`. When you configure a security profile, you would enter `Dell_host1` in the `certificate certificate-name` command.

### Configure security profile

1. Create an application-specific security profile in CONFIGURATION mode.

```
crypto security-profile profile-name
```

2. Assign a certificate and private key pair to the security profile in SECURITY-PROFILE mode. For `certificate-name`, enter the name of the certificate-key pair as it appears in the `show crypto certs` output without the `.pem` extension.

```
certificate certificate-name
exit
```

3. (Optional) Enable CRL checking for certificates received from external devices in SECURITY-PROFILE mode. CRL checking verifies the validity of a certificate using the CRLs installed on the switch.

```
revocation-check
```

4. (Optional) Enable peer name checking for certificates presented by external devices in SECURITY-PROFILE mode. Peer name checking ensures that the certificate matches the name of the peer device, such as a remote server name.

```
peer-name-check
```

5. Use the security profile to configure X.509v3-based service; for example, to configure RADIUS over TLS authentication using an X.509v3 certificate, enter the `radius-server host tls` command:

```
radius-server host {hostname | ip-address} tls security-profile profile-name
[auth-port port-number] key {0 authentication-key | 9 authentication-key |
authentication-key}
```

### Example: Security profile in RADIUS over TLS authentication

```

OS10# show crypto cert

Installed non-FIPS certificates
dv-fedgov-s6010-1.pem

Installed FIPS certificates
OS10#
OS10(config)#
OS10(config)# crypto security-profile radius-prof

```

```

OS10(config-sec-profile)# certificate dv-fedgov-s6010-1
OS10(config-sec-profile)# revocation-check
OS10(config-sec-profile)# peer-name-check
OS10(config-sec-profile)# exit
OS10(config)#
OS10(config)# radius-server host radius-server-2.test.com tls security-profile radius-
prof key radsec
OS10(config)# end
OS10# show running-configuration crypto security-profile
!
crypto security-profile radius-prof
 certificate dv-fedgov-s6010-1

OS10# show running-configuration radius-server
radius-server host radius-server-2.test.com tls security-profile radius-prof key 9
2b9799adc767c0efe8987a694969b1384c541414ba18a44cd9b25fc00ff180e9

```

## Cluster security

When you enable VLT or a fabric automation application, switches that participate in the cluster use secure channels to communicate with each other. The secure channels are enabled only when you enable the VLT or fabric cluster configuration on a switch. OS10 installs a default X.509v3 certificate-key pair to establish secure channels between the peer devices in a cluster.

**NOTE:** From 10.5.1.0 release onwards, there is no need for X.509v3 certificate in a VLT domain if both the VLT peers are running OS10 software version 10.5.1.0 or later. However, you still need the certificates during VLT upgrade from earlier version to 10.5.1.0. The upgraded VLT device has to communicate with the other VLT peer in a domain until the other device is also upgraded to 10.5.1.0.

Replace the default certificate-key pair used for cluster applications:

- In a deployment where untrusted devices access management or data ports on an OS10 switch.
- Before the default X.509v3 certificate expires on July 27, 2021. If the default certificate-key pair expires, the VLT domain on peer switches does not come up.

**NOTE:** The expiration date for the default certificate-key pair that is installed by OS10 on a switch running the 10.5.0.0 release is July 27, 2021. To ensure secure communication in a cluster before the expiration date, install a more recent X.509v3 certificate-key pair.

Create a custom X.509v3 certificate-key pair by configuring an application-specific security profile using the `cluster security-profile` command. Before the default or custom X.509v3 certificate-key pair that is used between the peer devices in a VLT domain or fabric application cluster expires, install a valid CA certificate by following the procedures in:

- [Manage CA certificates.](#)
- [Request and install host certificates.](#)

When you replace the default certificate-key pair for cluster applications, ensure that all devices in the cluster use the same custom certificate-key pair or a unique certificate-key pair that is issued by the same CA.

**CAUTION:** While you replace the default certificate-key pair, cluster devices temporarily lose their secure channel connectivity. Dell EMC Networking recommends that you change the cluster security configuration during a maintenance time.

This example shows how to install an X.509v3 CA and host certificate-key pair for a cluster application. For more information, see:

- Importing and installing a CA certificate — see [Manage CA certificates.](#)
- Generating a CSR and installing a host certificate — see [Request and install host certificates.](#)

### 1. Install a trusted CA certificate.

```

OS10# copy tftp://CAadmin:secret@172.11.222.1/GeoTrust_Universal_CA.crt
home:// GeoTrust_Universal_CA.crt

OS10# crypto ca-cert install home://GeoTrust_Universal_CA.crt
Processing certificate ...
Installed Root CA certificate

```



```
CommonName = GeoTrust Universal CA
IssuerName = GeoTrust Universal CA
```

## 2. Generate a CSR, copy the CSR to a CA server, download the signed certificate, and install the host certificate.

```
OS10# crypto cert generate request cert-file home://s4048-001.csr key-file home://
tsr6.key cname "Top of Rack 6" altname "IP:10.0.0.6 DNS:tor6.dell.com" email
admin@dell.com organization "Dell EMC" orgunit Networking locality "Santa Clara" state
California country US length 1024
Processing certificate ...
Successfully created CSR file /home/admin/tor6.csr and key

OS10# copy home://tor6.csr scp://CAadmin:secret@172.11.222.1/s4048-001-csr.pem

OS10# copy scp://CAadmin:secret@172.11.222.1/s4048-001.crt usb://s4048-001.crt

OS10# crypto cert install crt-file usb://s4048-001.crt key-file usb://s4048-001.key
This will replace the already installed host certificate.
Do you want to proceed ? [yes/no(default)]:yes
Processing certificate ...
Host certificate installed successfully.
```

## 3. Configure an X.509v3 security profile.

```
OS10# show crypto cert

Installed non-FIPS certificates
s4048-001

Installed FIPS certificates

OS10# config terminal
OS10(config)# crypto security-profile secure-cluster
OS10(config-sec-profile)# certificate s4048-001
OS10(config-sec-profile)# exit
```

## 4. Configure the cluster security profile.

```
OS10(config)# cluster security-profile secure-cluster
OS10(config)# exit
```

## Example: Configure RADIUS over TLS with X.509v3 certificates

This example shows how to install a trusted X.509v3 CA and a host certificate-key pair that supports RADIUS over TLS authentication.

### 1. Install a trusted CA certificate.

```
OS10# copy tftp://CAadmin:secret@172.11.222.1/GeoTrust_Universal_CA.crt home://
GeoTrust_Universal_CA.crt
OS10# crypto ca-cert install home://GeoTrust_Universal_CA.crt
Processing certificate ...
Installed Root CA certificate
CommonName = GeoTrust Universal CA
IssuerName = GeoTrust Universal CA
```

### 2. Generate a CSR, copy the CSR to a CA server, download the signed certificate, and install the host certificate.

```
OS10# crypto cert generate request cert-file home://s4048-001-csr.pem
key-file home://tsr6-key.pem cname "Top of Rack 6" altname "IP:10.0.0.6
DNS:tor6.dell.com"
email admin@dell.com organization "Dell EMC" orgunit Networking locality "santa Clara"
state California country US length 1024
Processing certificate ...
Successfully created CSR file /home/admin/tor6-csr.pem and key

OS10# copy home://tor6-csr.pem scp://CAadmin:secret@172.11.222.1/s4048-001-csr.pem
```

```

OS10# copy scp://CAadmin:secret@172.11.222.1/s4048-001.crt usb://s4048-001-crt.pem

OS10# crypto cert install crt-file usb://s4048-001-crt.pem key-file usb://s4048-001-
crt.key
This will replace the already installed host certificate.
Do you want to proceed ? [yes/no(default)]:yes
Processing certificate ...
Host certificate installed successfully.

```

### 3. Configure an X.509v3 security profile.

```

OS10# show crypto cert

Installed non-FIPS certificates
s4048-001-csr.pem

Installed FIPS certificates

OS10# config terminal
OS10(config)# crypto security-profile radius-admin
OS10(config-sec-profile)# certificate s4048-001-csr
OS10(config-sec-profile)# exit

```

### 4. Configure the RADIUS over TLS server.

```

OS10# radius-server host 10.0.0.1 tls security-profile radius-admin key radsec

```

### 5. Configure RADIUS-based user authentication.

```

OS10# aaa authentication login default group radius local

```

## X.509v3 commands

### certificate

Configures a certificate and private key pair in an application-specific security profile.

|                           |                                                                                                                                                                                                                                                                                                                                                                                                                                                                                                                                                                                                                                        |
|---------------------------|----------------------------------------------------------------------------------------------------------------------------------------------------------------------------------------------------------------------------------------------------------------------------------------------------------------------------------------------------------------------------------------------------------------------------------------------------------------------------------------------------------------------------------------------------------------------------------------------------------------------------------------|
| <b>Syntax</b>             | <code>certificate <i>certificate-name</i></code>                                                                                                                                                                                                                                                                                                                                                                                                                                                                                                                                                                                       |
| <b>Parameters</b>         | <i>certificate-name</i> — Enter the name of the certificate-key pair as it appears in the <code>show crypto certs</code> output without the <code>.pem</code> extension.                                                                                                                                                                                                                                                                                                                                                                                                                                                               |
| <b>Default</b>            | Not configured                                                                                                                                                                                                                                                                                                                                                                                                                                                                                                                                                                                                                         |
| <b>Command mode</b>       | SEC-PROFILE                                                                                                                                                                                                                                                                                                                                                                                                                                                                                                                                                                                                                            |
| <b>Usage information</b>  | <p>Use the <code>certificate</code> command to associate a certificate and private key with a security profile. An application-specific security profile allows you to change the certificate-key pair used by an OS10 application, such as SmartFabric services, without interrupting the service of other mission-critical applications.</p> <p>When you install a certificate-key pair, both take the name of the certificate. Enter the certificate-key pair name without an extension as the <i>certificate-name</i> value. To remove a certificate-key pair from the profile, enter the <code>no certificate</code> command.</p> |
| <b>Example</b>            | <pre> OS10# crypto security-profile secure-radius-profile OS10(config-sec-profile)# certificate Dell_host1 </pre>                                                                                                                                                                                                                                                                                                                                                                                                                                                                                                                      |
| <b>Supported releases</b> | 10.4.3.0 or later                                                                                                                                                                                                                                                                                                                                                                                                                                                                                                                                                                                                                      |

## cluster security-profile

Creates a security profile for a cluster application.

|                           |                                                                                                                                                                                                                                                                                                                                                                                                                                                                                                                                                                                                                                                                                               |
|---------------------------|-----------------------------------------------------------------------------------------------------------------------------------------------------------------------------------------------------------------------------------------------------------------------------------------------------------------------------------------------------------------------------------------------------------------------------------------------------------------------------------------------------------------------------------------------------------------------------------------------------------------------------------------------------------------------------------------------|
| <b>Syntax</b>             | <code>cluster security-profile <i>profile-name</i></code>                                                                                                                                                                                                                                                                                                                                                                                                                                                                                                                                                                                                                                     |
| <b>Parameters</b>         | <i>profile-name</i> — Enter the name of the security profile; a maximum of 32 characters.                                                                                                                                                                                                                                                                                                                                                                                                                                                                                                                                                                                                     |
| <b>Default</b>            | Not configured                                                                                                                                                                                                                                                                                                                                                                                                                                                                                                                                                                                                                                                                                |
| <b>Command mode</b>       | CONFIGURATION                                                                                                                                                                                                                                                                                                                                                                                                                                                                                                                                                                                                                                                                                 |
| <b>Usage information</b>  | When you enable VLT or a fabric automation application, switches that participate in the cluster use secure channels to communicate with each other. OS10 installs a default X.509v3 certificate-key pair to establish secure channels between the peer devices in a cluster. If untrusted devices access the management or data ports on the switch, replace the default certificate-key pair with a custom X.509v3 certificate-key pair using the <code>cluster security-profile</code> command. A security profile associates a certificate and private key pair using the <code>certificate</code> command. The <code>no</code> form of the command deletes the cluster security profile. |
| <b>Example</b>            | <pre>OS10(config)# cluster security-profile secure-cluster OS10(config)#</pre>                                                                                                                                                                                                                                                                                                                                                                                                                                                                                                                                                                                                                |
| <b>Supported releases</b> | 10.4.3.0 or later                                                                                                                                                                                                                                                                                                                                                                                                                                                                                                                                                                                                                                                                             |

## crypto ca-cert delete

Deletes a CA certificate.

|                           |                                                                                                                                                                                                                                                                                         |
|---------------------------|-----------------------------------------------------------------------------------------------------------------------------------------------------------------------------------------------------------------------------------------------------------------------------------------|
| <b>Syntax</b>             | <code>crypto ca-cert delete {<i>ca-cert-filepath</i>   all}</code>                                                                                                                                                                                                                      |
| <b>Parameters</b>         | <ul style="list-style-type: none"><li>• <i>ca-cert-filepath</i> — Enter the local path where the downloaded CA certificate is stored; for example, <code>home://CAcert.pem</code> or <code>usb://CA-cert.pem</code>.</li><li>• <code>all</code> — Delete all CA certificates.</li></ul> |
| <b>Default</b>            | Not configured                                                                                                                                                                                                                                                                          |
| <b>Command mode</b>       | EXEC                                                                                                                                                                                                                                                                                    |
| <b>Usage information</b>  | To display the currently installed CA certificates, use the <code>show crypto ca-certs</code> command.                                                                                                                                                                                  |
| <b>Example</b>            | <pre>OS10# crypto ca-cert delete Amazon_Root_CA.crt Successfully removed certificate  OS10# crypto ca-cert delete all Proceed to delete all installed CA certificates? [confirm yes/ no(default)]:yes</pre>                                                                             |
| <b>Supported releases</b> | 10.4.3.0 or later                                                                                                                                                                                                                                                                       |

## crypto ca-cert install

Installs a certificate from a Certificate Authority that is copied to the switch.

|                   |                                                                                                                                                                                                                                                                                                                                                                                                                                 |
|-------------------|---------------------------------------------------------------------------------------------------------------------------------------------------------------------------------------------------------------------------------------------------------------------------------------------------------------------------------------------------------------------------------------------------------------------------------|
| <b>Syntax</b>     | <code>crypto ca-cert install <i>ca-cet-filepath</i> [<i>filename</i>]</code>                                                                                                                                                                                                                                                                                                                                                    |
| <b>Parameters</b> | <ul style="list-style-type: none"><li>• <i>ca-cert-filepath</i> — Enter the local path where the downloaded CA certificate is stored; for example, <code>home://CAcert.pem</code> or <code>usb://CA-cert.pem</code>.</li><li>• <i>filename</i> — (Optional) Enter the filename that the CA certificate is stored under in the OS10 trust store directory. Enter the filename in the <code>filename.crt</code> format.</li></ul> |

|                           |                                                                                                                                                                                                                                                                                                                                                                |
|---------------------------|----------------------------------------------------------------------------------------------------------------------------------------------------------------------------------------------------------------------------------------------------------------------------------------------------------------------------------------------------------------|
| <b>Default</b>            | Not configured                                                                                                                                                                                                                                                                                                                                                 |
| <b>Command mode</b>       | EXEC                                                                                                                                                                                                                                                                                                                                                           |
| <b>Usage information</b>  | Before using the <code>crypto ca-cert install</code> command, copy the certificate to the home directory on the switch using a secure connection, such as HTTPS, SCP, or SFTP. After successful installation, the subject and issuer of the CA certificate are displayed. To delete a trusted certificate, use the <code>crypto ca-cert delete</code> command. |
| <b>Example</b>            | <pre>OS10# crypto ca-cert install home://GeoTrust_Universal_CA.crt Processing certificate ... Installed Root CA certificate CommonName = GeoTrust Universal CA IssuerName = GeoTrust Universal CA</pre>                                                                                                                                                        |
| <b>Supported releases</b> | 10.4.3.0 or later                                                                                                                                                                                                                                                                                                                                              |

## crypto cdp add

Installs a certificate distribution point (CDP) on the switch.

|                           |                                                                                                                                                                           |
|---------------------------|---------------------------------------------------------------------------------------------------------------------------------------------------------------------------|
| <b>Syntax</b>             | <code>crypto cdp add cdp-name cdp-url</code>                                                                                                                              |
| <b>Parameters</b>         | <ul style="list-style-type: none"> <li>• <code>cdp-name</code> — Enter a CDP name.</li> <li>• <code>cdp-url</code> — Enter the HTTP URL used to reach the CDP.</li> </ul> |
| <b>Default</b>            | Not configured                                                                                                                                                            |
| <b>Command Mode</b>       | EXEC                                                                                                                                                                      |
| <b>Usage Information</b>  | Use the <code>show crypto cdp</code> command to display the CDPs already installed on the switch                                                                          |
| <b>Example</b>            | <pre>OS10# crypto cdp add Comsign http://fedir.comsign.co.il/crl/ComSignCA.crl</pre>                                                                                      |
| <b>Supported Releases</b> | 10.5.0 or later                                                                                                                                                           |

## crypto cdp delete

Deletes a certificate distribution point from the trust store on the switch.

|                           |                                                                                                                              |
|---------------------------|------------------------------------------------------------------------------------------------------------------------------|
| <b>Syntax</b>             | <code>crypto cdp delete cdp-name</code>                                                                                      |
| <b>Parameters</b>         | <ul style="list-style-type: none"> <li>• <code>cdp-name</code> — Enter a CDP name.</li> </ul>                                |
| <b>Default</b>            | Not configured                                                                                                               |
| <b>Command Mode</b>       | EXEC                                                                                                                         |
| <b>Usage Information</b>  | Before you delete a CDP, use the <code>show crypto cdp</code> command to display a list of all CDPs installed on the switch. |
| <b>Example</b>            | <pre>OS10# crypto cdp delete Comsign</pre>                                                                                   |
| <b>Supported Releases</b> | 10.5.0 or later                                                                                                              |

## crypto cert delete

Deletes an installed host certificate and the private key created with it.

**Syntax** `crypto cert delete filename [fips]`

- Parameters**
- `filename` — Enter the file name of the host certificate as displayed in the `show crypto cert` command.
  - `fips` — (Optional) Delete a FIPS-compliant certificate-key pair. To verify whether a certificate is non-FIPS or FIPS-compliant, use the `show crypto cert` command.

**Default** Not configured

**Command mode** EXEC

**Usage information** When you delete the system's certificate, you also delete the private key. Do not delete a host certificate that is used in a security profile. To display the currently installed host certificate and associated key, use the `show crypto cert` command.

 **NOTE:** A FIPS-compliant and non-FIPS certificate may have the same file name. To delete a FIPS-compliant certificate, you must enter the `fips` parameter in the command.

### Example

```
OS10# crypto cert delete Dell_host1_CA1.pem
Certificate and keys were successfully deleted. CN = Dell_host1_CA1
```

**Supported releases** 10.4.3.0 or later

## crypto cert generate

Creates a certificate signing request (CSR) or a self-signed certificate.

**Syntax** `crypto cert generate {request | self-signed} [cert-file cert-path key-file {private | keypath}] [country 2-letter code] [state state] [locality city] [organization organization-name] [orgunit unit-name] [cname common-name] [email email-address] [validity days] [length length] [altname alt-name]`

- Parameters**
- `request` — Create a certificate signing request to copy to a CA.
  - `self-signed` — Create a self-signed certificate.
  - `cert-file cert-path` — (Optional) Enter the local path where the self-signed certificate or CSR is stored. You can enter a full path or a relative path; for example, `flash://certs/s4810-001-request.csr` or `usb://s4810-001.crt`. If you do not enter the `cert-file` option, the system interactively prompts you to fill in the remaining fields of the certificate signing request. Export the CSR to a CA using the `copy` command.
  - `key-file {key-path | private}` — Enter the local path where the downloaded or locally generated private key is stored. If the key was downloaded to a remote server, enter the server path using a secure method, such as HTTPS, SCP, or SFTP. Enter `private` to store the key in a local hidden location.
  - `country 2-letter-code` — (OPTIONAL) Enter the two-letter code that identifies the country.
  - `state state` — Enter the name of the state.
  - `locality city` — Enter the name of the city.
  - `organization organization-name` — Enter the name of the organization.
  - `orgunit unit-name` — Enter name of the unit.
  - `cname common-name` — Enter the common name assigned to the certificate. Common name is the main identity presented to connecting devices. By default, the switch's host name is the common name. You can configure a different common name for the switch; for example, an IP address. If the

*common-name* value does not match the device's presented identity, a signed certificate does not validate.

- *email email-address* — Enter a valid email address used to communicate with the organization.
- *validity days* — Enter the number of days that the certificate is valid. For a CSR, validity has no effect. For a self-signed certificate, the default is 3650 days or 10 years.
- *length bit-length* — Enter a bit value for the keyword length. For FIPS mode, the range is from 2048 to 4096; for non-FIPS mode, the range is from 1024 to 4096. The default key length for both FIPS and non-FIPS mode is 2048 bits. The minimum key length value for FIPS mode is 2048 bits. The minimum key length value for non-FIPS mode is 1024 bits.
- *altname altname* — Enter an alternate name for the organization; for example, using the IP address such as *altname IP:192.168.1.100*.

**Default** Not configured

**Command mode** EXEC

**Usage information** Generate a CSR when you want a CA to sign a host certificate. Generate a self-signed certificate if you do not set up a CA and implement a certificate trust model in your network.

If you enter the *cert-file* option, you must enter all the required parameters, including the local path where the certificate and private key are stored.

If you do not specify the *cert-file* option, you are prompted to fill in the other parameter values for the certificate interactively; for example:

```
You are about to be asked to enter information that will be incorporated
into your certificate request.
What you are about to enter is what is called a Distinguished Name or a
DN.
There are quite a few fields but you can leave some blank.
For some fields there will be a default value; if you enter '.', the
field will be left blank.
Country Name (2 letter code) [US]:
State or Province Name (full name) [Some-State]:California
Locality Name (eg, city) []:San Francisco
Organization Name (eg, company) []:Starfleet Command
Organizational Unit Name (eg, section) []:NCC-1701A
Common Name (eg, YOUR name) [hostname]:S4148-001
Email Address []:scotty@starfleet.com
```

If the system is in FIPS mode — *crypto fips enable* command — the CSR and private key are generated using approved algorithms from a cryptographic library that has been validated against the FIPS 140-2 standard. You can install the FIPS-compliant certificate-key pair using the *crypto cert install* command with the *fips* option.

## Examples

```
OS10# crypto cert generate request cert-file home://cert1.pem key-file
home://cee OS10-VM email admin@dell.com length 1024 altname DNS.dell.com
Processing certificate ...
```

```
Successfully created CSR file /home/admin/cert1.pem and key
```

```
OS10# crypto cert generate self-signed cert-file home://cert2.pem key-
file home:e OS10-VM email admin@dell.com length 1024 altname.dell.com
validity 365
Processing certificate ...
```

```
Successfully created certificate file /home/admin/cert2.pem and key
```

**Supported releases** 10.4.3.0 or later

## crypto cert install

Installs a host certificate and private key on the switch. A host certificate may be trusted from a CA or self-signed.

|                           |                                                                                                                                                                                                                                                                                                                                                                                                                                                                                                                                                                                                                                                                                                                                                                                                                                                                                                                                                                                                                                                                                                                                                                                                                                                                                                                  |
|---------------------------|------------------------------------------------------------------------------------------------------------------------------------------------------------------------------------------------------------------------------------------------------------------------------------------------------------------------------------------------------------------------------------------------------------------------------------------------------------------------------------------------------------------------------------------------------------------------------------------------------------------------------------------------------------------------------------------------------------------------------------------------------------------------------------------------------------------------------------------------------------------------------------------------------------------------------------------------------------------------------------------------------------------------------------------------------------------------------------------------------------------------------------------------------------------------------------------------------------------------------------------------------------------------------------------------------------------|
| <b>Syntax</b>             | <code>crypto cert install cert-file <i>cert-path</i> key-file {<i>key-path</i>   private} [password <i>passphrase</i>] [<i>fips</i>]</code>                                                                                                                                                                                                                                                                                                                                                                                                                                                                                                                                                                                                                                                                                                                                                                                                                                                                                                                                                                                                                                                                                                                                                                      |
| <b>Parameters</b>         | <ul style="list-style-type: none"><li>• <code>cert-file <i>cert-path</i></code> — Enter the local path to where the downloaded certificate is stored. You can enter a full path or a relative path; for example, <code>home://s4048-001-cert.pem</code> or <code>usb://s4048-001-cert.pem</code> or <code>flash://certs/s4810-001-request.crt</code>.</li><li>• <code>key-file {<i>key-path</i>   private}</code> — Enter the local path to retrieve the downloaded or locally generated private key. Specify a <i>key-path</i> to install the key from a local directory. Enter <code>private</code> to install the key from a local hidden location. After the certificate is successfully installed, the private key is deleted from the specified <i>key-path</i> location and copied to the hidden location.</li><li>• <code>password <i>passphrase</i></code> — (Optional) Enter the password used to decrypt the private key if it was generated using a password.</li><li>• <code>fips</code> — (Optional) Install the certificate-key pair as FIPS-compliant. Enter <code>fips</code> to install a certificate-key pair that a FIPS-aware application, such as RADIUS over TLS, uses. If you do not enter <code>fips</code>, the certificate-key pair is stored as a non-FIPS compliant pair.</li></ul> |
| <b>Default</b>            | Not configured                                                                                                                                                                                                                                                                                                                                                                                                                                                                                                                                                                                                                                                                                                                                                                                                                                                                                                                                                                                                                                                                                                                                                                                                                                                                                                   |
| <b>Command mode</b>       | EXEC                                                                                                                                                                                                                                                                                                                                                                                                                                                                                                                                                                                                                                                                                                                                                                                                                                                                                                                                                                                                                                                                                                                                                                                                                                                                                                             |
| <b>Usage information</b>  | <p>Before using the <code>crypto cert install</code> command, copy a CA-signed certificate to the home directory on the switch using a secure connection, such as HTTPS, SCP, or SFTP, and (optionally) the private key. To delete a trusted certificate, use the <code>crypto cert delete</code> command.</p> <p>A successful installation of a trusted certificate requires that:</p> <ul style="list-style-type: none"><li>• The downloaded certificate is correctly formatted.</li><li>• The downloaded certificate's public key corresponds to the private key.</li></ul> <p>You can assign an installed certificate-key pair to a security profile by entering the file name of the certificate without an extension.</p> <p>It is possible to store a certificate in either FIPS mode or non-FIPS mode on the switch, but not in both modes, using the <code>crypto cert install</code> command and the optional <code>fips</code> option. You must ensure that certificates installed in FIPS mode are compliant with the FIPS 140-2 standard.</p>                                                                                                                                                                                                                                                       |
| <b>Example</b>            | <pre>OS10# crypto cert install cert-file home://Dell_host1_CA1.pem key-file home://Dell_host1_CA1.key Processing Certificate ... Certificate and keys were successfully installed as "Dell_host1_CA1.pem" that may be used in a security profile. CN = Dell_host1_CA1.</pre>                                                                                                                                                                                                                                                                                                                                                                                                                                                                                                                                                                                                                                                                                                                                                                                                                                                                                                                                                                                                                                     |
| <b>Supported releases</b> | 10.4.3.0 or later                                                                                                                                                                                                                                                                                                                                                                                                                                                                                                                                                                                                                                                                                                                                                                                                                                                                                                                                                                                                                                                                                                                                                                                                                                                                                                |

## crypto crl delete

Deletes a Certificate Revocation List file in the trust store on the switch.

|                          |                                                                                                                                                                                                                                   |
|--------------------------|-----------------------------------------------------------------------------------------------------------------------------------------------------------------------------------------------------------------------------------|
| <b>Syntax</b>            | <code>crypto crl delete <i>crl-filename</i></code>                                                                                                                                                                                |
| <b>Parameters</b>        | <ul style="list-style-type: none"><li>• <code><i>crl-filename</i></code> — Enter a CRL filename with the <code>.pem</code> extension as displayed under Manually installed CRLs in <code>show crypto crl</code> output.</li></ul> |
| <b>Default</b>           | Not configured                                                                                                                                                                                                                    |
| <b>Command Mode</b>      | EXEC                                                                                                                                                                                                                              |
| <b>Usage Information</b> | The <code>crypto crl delete</code> command deletes only manually installed CRLs. Before you delete a CRL, use the <code>show crypto crl</code> command to display a list of all CRLs installed on the switch.                     |

**Example**

```
OS10# crypto crl delete COMODO_Certification_Authority.0.crl.pem
```

**Supported Releases**

10.5.0 or later

## crypto crl install

Installs the Certificate Revocation List files that you copied to the switch.

**Syntax**

```
crypto crl install crl-path [crl-filename]
```

**Parameters**

- *crl-path* — Enter the path to the directory where the CRL is downloaded.
- *crl-filename* — (Optional) Enter the CRL filename that you copied to the switch.

**Default**

Not configured

**Command Mode**

EXEC

**Usage Information**

Before you use the `crypto crl install` command, copy a CRL to the `home://` or `usb://` directory. If you do not enter a CRL filename in the command, you can copy and paste it when prompted. Use the `show crypto crl` command to view the CRLs that are already installed on the switch. In the show output, the CRLs displayed under `Manually installed CRLs` are installed using the `crypto crl install` command.

**Example**

```
OS10# copy scp:///tftpuser@10.11.178.103:/crl_example_file.pem home://
password:

OS10# crypto crl install home://
Network_Solutions_Certificate_Authority.0.crl.pem

OS10# show crypto crl

Manually installed CRLs
Network_Solutions_Certificate_Authority.0.crl.pem

Downloaded CRLs
```

**Supported Releases**

10.5.0 or later

## crypto fips enable

Enables FIPS mode.

**Syntax**

```
crypto fips enable
```

**Parameters**

None

**Default**

Not configured

**Command mode**

EXEC

**Usage information**

You can use OS10 in FIPS 140-2 compliant mode. In this mode, applications restrict their use of cryptographic algorithms to those supported by the NIST FIPS 140-2 standard and certification process. When you enable FIPS mode:

- The SSH service restarts. Existing SSH sessions are not affected. Only new SSH sessions operate in the enabled FIPS mode.
- SSH host keys are regenerated.
- If SNMPv3 is configured with privacy settings, it operates in FIPS mode.



If you enable FIPS using the `crypto fips enable` command, RADIUS over TLS operates in FIPS mode. In FIPS mode, RADIUS over TLS requires that a FIPS-compliant certificate and key pair are installed on the switch.

**Example**

```
OS10# crypto fips enable
```

**Supported releases**

10.4.3.0 or later

## crypto security-profile

Creates an application-specific security profile.

**Syntax**

`crypto security-profile profile-name`

**Parameters**

*profile-name* — Enter the name of the security profile; a maximum of 32 characters.

**Default**

Not configured

**Command mode**

CONFIGURATION

**Usage****information**

Create a security profile for a specific application on the switch, such as RADIUS over TLS. A security profile associates a certificate and private key pair using the `certificate` command. The `no` form of the command deletes the security profile.

**Example**

```
OS10# crypto security-profile secure-radius-profile
OS10(config-sec-profile)#
```

**Supported releases**

10.4.3.0 or later

## peer-name-check

Enables peer name checking in a security profile for certificates presented by external devices.

**Syntax**

`peer-name-check`

**Parameters**

None

**Default**

Not configured

**Command mode**

SEC-PROFILE

**Usage****information**

Use the `peer-name-check` command to enable an OS10 application to verify that the certificate used to connect to the switch matches the name of the peer device, such as a remote server name. The `no` version of the command disables peer name checking in the security profile.

**Example**

```
OS10(config)# crypto security-profile profile-1
OS10(config-sec-profile)# peer-name-check

OS10(config)# crypto security-profile profile-1
OS10(config-sec-profile)# no peer-name-check
```

**Supported releases**

10.5.0 or later

## revocation-check

Enables CRL checking in a security profile.

**Syntax**

`revocation-check`

**Parameters**

None

|                           |                                                                                                                                                                                                                                                                                                                                                                                                                                                 |
|---------------------------|-------------------------------------------------------------------------------------------------------------------------------------------------------------------------------------------------------------------------------------------------------------------------------------------------------------------------------------------------------------------------------------------------------------------------------------------------|
| <b>Default</b>            | Not configured                                                                                                                                                                                                                                                                                                                                                                                                                                  |
| <b>Command mode</b>       | SEC-PROFILE                                                                                                                                                                                                                                                                                                                                                                                                                                     |
| <b>Usage information</b>  | Use the <code>revocation-check</code> command to enable the verification of certificates presented by external devices for a PKI-enabled application on the switch. Use the <code>show crypto crl</code> command to display the CRLs installed on the switch and used to ensure the validity and trustworthiness of certificates from external devices. The <code>no</code> version of the command disables CRL checking in a security profile. |
| <b>Example</b>            | <pre>OS10(config)# crypto security-profile profile-1 OS10(config-sec-profile)# revocation-check  OS10(config)# crypto security-profile profile-1 OS10(config-sec-profile)# no revocation-check</pre>                                                                                                                                                                                                                                            |
| <b>Supported releases</b> | 10.5.0 or later                                                                                                                                                                                                                                                                                                                                                                                                                                 |

## show crypto ca-certs

Displays all CA certificates installed on the switch.

|                          |                                                                                                                                                                                                                                                                                                                                                                                                                                                                                                                                                                                                                                                                                                                                                                                                                                                                                                                                                                                                                                                                                                                                                                                                                                  |
|--------------------------|----------------------------------------------------------------------------------------------------------------------------------------------------------------------------------------------------------------------------------------------------------------------------------------------------------------------------------------------------------------------------------------------------------------------------------------------------------------------------------------------------------------------------------------------------------------------------------------------------------------------------------------------------------------------------------------------------------------------------------------------------------------------------------------------------------------------------------------------------------------------------------------------------------------------------------------------------------------------------------------------------------------------------------------------------------------------------------------------------------------------------------------------------------------------------------------------------------------------------------|
| <b>Syntax</b>            | <code>show crypto ca-certs [filename]</code>                                                                                                                                                                                                                                                                                                                                                                                                                                                                                                                                                                                                                                                                                                                                                                                                                                                                                                                                                                                                                                                                                                                                                                                     |
| <b>Parameters</b>        | <i>filename</i> — (Optional) Enter the text filename of a CA certificate as shown in the <code>show crypto ca-certs</code> output. Enter the filename in the format <i>filename.crt</i> .                                                                                                                                                                                                                                                                                                                                                                                                                                                                                                                                                                                                                                                                                                                                                                                                                                                                                                                                                                                                                                        |
| <b>Default</b>           | Display all installed CA certificates.                                                                                                                                                                                                                                                                                                                                                                                                                                                                                                                                                                                                                                                                                                                                                                                                                                                                                                                                                                                                                                                                                                                                                                                           |
| <b>Command mode</b>      | EXEC                                                                                                                                                                                                                                                                                                                                                                                                                                                                                                                                                                                                                                                                                                                                                                                                                                                                                                                                                                                                                                                                                                                                                                                                                             |
| <b>Usage information</b> | To delete a CA certificate, use the <code>crypto ca-cert delete</code> command. Enter the filename as shown in the <code>show crypto ca-certs</code> output.                                                                                                                                                                                                                                                                                                                                                                                                                                                                                                                                                                                                                                                                                                                                                                                                                                                                                                                                                                                                                                                                     |
| <b>Example</b>           | <pre>OS10# show crypto ca-certs -----     Locally installed certificates     ----- Dell_interCA1.crt Dell_rootCA1.crt  OS10# show crypto ca-certs Dell_interCA1.crt Certificate:   Data:     Version: 3 (0x2)     Serial Number: 4096 (0x1000)     Signature Algorithm: sha256WithRSAEncryption     Issuer: C = US, ST = California, L = Santa Clara, O = Dell EMC, OU = Networking, CN = Dell_rootCA1     Validity       Not Before: Jul 25 18:49:22 2018 GMT       Not After : Jul 22 18:49:22 2028 GMT     Subject: C = US, ST = California, O = Dell EMC, OU = Networking, CN = Dell_interCA1     Subject Public Key Info:       Public Key Algorithm: rsaEncryption       Public-Key: (4096 bit)       Modulus:         00:b8:46:93:86:27:af:3e:fb:a7:bd:c1:25:76:fd:         50:87:02:de:98:2b:95:2e:b0:49:e4:5c:7c:db:83:         b9:e7:3d:e3:61:63:e9:e1:e9:6f:a4:eb:b8:06:bf:         57:b7:bb:17:d1:50:ee:7c:ad:d1:09:fe:c3:2c:ea:         79:bf:b9:fa:92:52:22:0e:49:62:0b:97:b8:92:c2:         59:43:2e:53:e0:c6:d4:ea:d5:ec:35:79:4f:c2:95:         82:91:43:ee:3e:3d:ae:e3:a9:ba:37:94:79:27:b3:         0d:f9:5a:cc:1b:fd:6d:24:d6:00:ce:1d:3d:4a:fa:         95:94:c8:a5:1c:65:cc:f0:08:4a:7f:79:c7:68:4e:</pre> |

```
c2:3a:b5:b9:21:82:1c:25:45:f4:7e:84:f9:d3:af:
28:06:0b:8d:da:72:c1:41:1a:ca:c1:63:de:d6:25:
ef:f8:ec:a7:93:88:e0:a0:4f:93:14:81:a6:e8:90:
31:7a:b8:53:4c:52:44:e1:5c:6a:aa:94:b6:0d:eb:
73:b8:18:21:d5:9c:a4:73:a4:54:16:5b:af:b0:35:
0d:36:ff:cb:72:04:63:d1:df:48:59:d3:e9:51:e1:
cb:2a:61:20:ee:31:25:51:68:0e:be:98:c3:22:98:
29:f9:13:03:c4:2d:bb:4a:d2:cf:7d:00:f9:4c:2e:
46:70:e3:ab:e7:3c:91:b0:c9:f7:48:89:ea:e7:df:
4f:f4:f5:fc:3a:17:dc:f8:8c:48:e5:aa:03:84:d7:
20:7b:55:2e:73:63:85:1c:97:a1:bb:96:95:a1:d3:
ae:0c:7a:ae:02:3c:2c:07:b6:9b:c5:97:69:fa:88:
bd:ec:8b:88:b3:90:e3:dc:aa:98:15:c6:91:99:a4:
```

**Supported releases** 10.4.3.0 or later

## show crypto cdp

Displays a list of configured certificate distribution points (CDPs).

**Syntax** `show crypto cdp [cdp-name]`

**Parameters**

- *cdp-name* — (Optional) Display more detailed information by entering the CDP name displayed in `show crypto cdp` output.

**Default** Not configured

**Command Mode** EXEC

**Usage Information** Use the `show crypto cdp` command to verify the CDPs installed on the switch and display the URL to reach a CDP. OS10 uses the URL to access the CDP and download new CRLs. In the `show` output:

- Manually installed CDPs are installed using the `crypto cdp add` command.
- Automatically installed CDPs are automatically configured when you install a CA certificate with a specified CDP.

Add or delete CDPs using the `crypto cdp install` and `crypto cdp delete` commands.

### Example

```
OS10# show crypto cdp

Manually installed CDPs
Comsign

Automatically installed CDPs
COMODO_Certification_Authority

OS10# show crypto cdp Comsign
http://fedir.comsign.co.il/crl/ComSignCA.crl
```

**Supported Releases** 10.5.0 or later

## show crypto cert

Displays information about a specified certificate or all installed certificates.

**Syntax** `show crypto cert [filename]`

**Parameters** *filename* — (Optional) Enter the text filename of a certificate as displayed in the `show crypto certs` output. Enter the filename in the format *filename.crt*.

**Default** Display all installed host certificates.

**Command mode** EXEC

**Usage information** To delete a certificate, use the `crypto cert delete filename` command.

**Example**

```
OS10# show crypto cert

Installed non-FIPS certificates
Dell_host1_CA1.pem

Installed FIPS certificates
```

```
OS10# show crypto cert Dell_host1_CA1.pem
----- Non FIPS certificate -----
Certificate:
 Data:
 Version: 3 (0x2)
 Serial Number: 4096 (0x1000)
 Signature Algorithm: sha256WithRSAEncryption
 Issuer: C = US, ST = California, O = Dell EMC, OU = Networking,
CN = Dell_interCA1
 Validity
 Not Before: Jul 25 19:11:19 2018 GMT
 Not After : Jul 22 19:11:19 2028 GMT
 Subject: C = US, ST = California, L = Santa Clara, O = Dell EMC,
OU = Networking, CN = Dell_host1_CA1
 Subject Public Key Info:
 Public Key Algorithm: rsaEncryption
 Public-Key: (2048 bit)
 Modulus:
 00:e7:81:4b:4a:12:8d:ce:88:e6:73:3f:da:19:03:
 c6:56:01:19:b2:02:61:3f:5b:1e:33:28:a1:ed:e3:
 85:bc:56:fb:18:d5:16:2e:a0:e7:3a:f9:34:b4:df:
 37:97:93:a9:b9:94:b2:9f:69:af:fa:31:77:68:06:
 89:7b:6d:fc:91:14:4a:c8:7b:23:93:f5:44:5a:0a:
 3f:ce:9b:af:a6:9b:49:29:fd:fd:cb:34:40:c4:02:
 30:95:37:28:50:d8:81:fb:1f:83:88:d9:1f:a3:0e:
 49:a1:b3:df:90:15:d4:98:2b:b2:38:98:6e:04:aa:
 bd:92:1b:98:48:4d:08:49:69:41:4e:6a:ee:63:d8:
 2a:9f:e6:15:e2:1d:c3:89:f5:f0:d0:fb:c1:9c:46:
 92:a9:37:b9:2f:a0:73:cf:e7:d1:88:96:b8:4a:84:
 91:83:8c:f0:9a:e0:8c:6e:7a:fa:6e:7e:99:3a:c3:
 2c:04:f9:06:8e:05:21:5f:aa:6e:9f:b7:10:37:29:
 0c:03:14:a0:9d:73:1f:95:41:39:9b:96:30:9d:0a:
 cb:d0:65:c3:59:23:01:f7:f5:3a:33:b9:e9:95:11:
 0c:51:f4:e9:1e:a5:9d:f7:95:84:9c:25:74:0c:21:
 4f:8b:07:29:2f:e3:47:14:50:8b:03:c1:fb:83:85:
 dc:bb
 Exponent: 65537 (0x10001)
 X509v3 extensions:
 X509v3 Basic Constraints:
 CA:FALSE
 Netscape Cert Type:
 SSL Client, S/MIME
 Netscape Comment:
 OpenSSL Generated Client Certificate
 X509v3 Subject Key Identifier:
 4A:20:AA:E1:69:BF:BE:C5:66:2E:22:71:70:B4:7E:32:6F:E0:05:28
 X509v3 Authority Key Identifier:
 keyid:A3:39:CB:C7:76:86:3B:05:44:34:C2:6F:90:73:1F:5F:64:55:5C:76
 X509v3 Key Usage: critical
```

**Supported releases** 10.4.3.0 or later

## show crypto crl

Displays the list of installed Certificate Revocation List files.

**Syntax** `show crypto crl [crl-filename]`

**Parameters**

- `crl-filename` — (Optional) Enter a CRL filename with the `.pem` extension.

**Default** Not configured

**Command Mode** EXEC

**Usage Information** Use the `show crypto crl` command to verify the CRLs installed on the switch. In the show output:

- Manually installed CRLs are installed using the `crypto crl install` command.
- Downloaded CRLs are automatically installed from a configured CDP or when you install a CA certificate with a specified CDP.

### Example

```
OS10# show crypto crl

Manually installed CRLs
COMODO_Certification_Authority.0.crl.pem

Downloaded CRLs
```

```
OS10# show crypto crl COMODO_Certification_Authority.0.crl.pem
Certificate Revocation List (CRL):
Version 2 (0x1)
Signature Algorithm: sha1WithRSAEncryption
Issuer: /C=GB/ST=Greater Manchester/L=Salford/O=COMODO CA Limited/
CN=COMODO Certification
Authority
Last Update: May 8 20:34:21 2019 GMT
Next Update: May 12 20:34:21 2019 GMT
CRL extensions:
X509v3 Authority Key Identifier:
keyid:0B:58:E5:8B:C6:4C:15:37:A4:40:A9:30:A9:21:BE:47:36:5A:56:FF
X509v3 CRL Number:
2904
No Revoked Certificates.
Signature Algorithm: sha1WithRSAEncryption
5b:77:52:c0:a0:4e:77:be:4a:c4:6a:7e:92:98:2e:a1:6b:3c:
ad:2d:ac:db:0a:19:1d:a3:56:98:7f:d6:93:f3:1d:4b:61:40:
c3:e0:40:45:0b:41:4b:66:87:35:2b:3a:4c:f3:f1:7e:44:7e:
fe:7f:51:5d:17:ee:b3:4c:15:75:a6:a0:7b:2e:b1:92:3e:b6:
71:a8:01:8d:78:ac:80:3b:16:f2:f1:a8:fd:09:68:9f:7e:09:
55:c6:80:2c:2f:e7:f3:54:51:94:3a:d8:b4:d6:00:3f:63:b1:
19:f3:42:2a:d2:c4:3b:de:c4:4d:ad:f0:72:c5:b4:25:51:e5:
3c:76:8b:97:3c:db:fe:3f:7f:41:d2:d9:aa:7f:98:90:6b:cf:
27:53:0e:66:83:8e:cc:81:ef:6a:e5:cd:c2:f1:e2:ea:84:4f:
73:bb:90:5a:b3:19:a3:50:6a:c7:b3:99:e4:09:fd:56:99:83:
3a:15:93:b0:4a:49:28:78:69:85:de:fc:06:cc:b9:a5:5b:d9:
4a:b0:46:90:ce:94:3a:9c:f3:04:e4:d7:98:36:29:a8:8b:fe:
72:26:b0:fd:39:5e:14:f5:00:6d:0e:4f:ec:d4:a5:ca:4f:e1:
d9:4f:5a:37:21:e3:a2:fb:80:db:cd:68:0b:a0:fa:58:0d:5e:
40:e1:e4:1c
```

**Supported Releases** 10.5.0 or later

## Network security

OS10 switch has security features to restrict network traffic, protect the network from attacks, and prevent unauthorized access to the network.

## Access control lists

Access control lists (ACLs) restrict network traffic using policies and improve network performance. For more information about ACL, see [Access control lists](#).

## DHCP snooping

DHCP snooping protects your network from attacks by monitoring the DHCP messages and blocking untrusted or rogue DHCP servers. For more information about DHCP snooping, see [DHCP snooping](#).

## 802.1X port access control

802.1x defines access control that prevents unauthorized devices or users from connecting to a network. For more information about 802.1X, see [802.1X](#).

## Port security

Use the port security feature to restrict the number of workstations that can send traffic through an interface and to control MAC address movement.

Port security is a package of the following sub features that provide added security to the system:

1. MAC address learning limit (MLL)
2. Sticky MAC
3. MAC address movement control

Use the port security feature to define the number of workstations that can send traffic through an interface. MAC addresses that are learnt or statically configured on a port security enabled interface are called secure MAC addresses.

 **NOTE:** Port security features are not supported in a VLT setup.

There are three types of Secure MAC addresses :

1. **Static secure MAC addresses** are configured manually. These MAC addresses are stored both in the MAC address table and in the running configuration of the switch. Similar to static MAC addresses, when the system reloads, the system does not remove the static secure MAC addresses. When you enable port security on an interface, all existing static MAC addresses become static secure MAC addresses. These static secure MAC addresses remain in the system until you remove them.
2. **Dynamic secure MAC addresses** are dynamically-learned by the switch and stored in the MAC address table. These MAC addresses are removed from the MAC address table when the switch restarts. By default, dynamic secure MAC addresses do not age out.
3. **Sticky secure MAC addresses** are learned dynamically but are saved in the running configuration. Secure sticky MAC addresses never age out.

After you enable port security on an interface, by default, the maximum number of MAC address that the interface can learn is one. This is applicable for both dynamic and static secure MAC addresses. After you enable port security on an interface, by default, sticky MAC addresses and MAC movement are disabled on the interface.

### MAC address learning limit

Using the MAC address learning limit method, you can set an upper limit on the number of allowed MAC addresses on an interface. Limiting the MAC addresses protects switches from MAC address flooding attacks. After the configured limit is reached on an interface, by default, the system drops all traffic from any unknown device.

When you configure MAC address learning limit, ensure that the number of static MAC addresses present on the system is not greater than the MAC address learning limit that you configure. If the number of dynamically-learned MAC addresses is greater than your MAC address limit, the system flushes all dynamically-learned MAC addresses.

You can configure an interface to learn a maximum of 3072 MAC addresses. You can also disable the MAC address learning limit feature so that the interface can learn the maximum number MAC addresses that the system supports. Disabling the MAC address learning limit feature does not remove the previously learned or configured secure MAC addresses.

### MAC address movement

A MAC address movement happens when the system detects the same MAC address on an interface which it has already learned through another port security-enabled interface on the same broadcast domain. MAC address movement is not allowed for secure static and sticky MAC addresses. By default, MAC address movement for dynamically-learned MAC address is disabled on the system.

Secure dynamic MAC address movement is allowed between port-security-enabled and port-security-disabled interfaces.

### Sticky MAC addresses

When you reload the system, port security removes the dynamically learned secure MAC addresses. You can use the sticky feature to make the dynamically learned secure MAC addresses persist even after a system reboot so that the interface does not have to learn these MAC addresses again. Use the `copy running-configuration startup-configuration` command to save the sticky secure MAC addresses.

When you enable sticky MAC address learning on an interface, all existing dynamically-learned MAC addresses and MAC addresses that are learned in the future are converted to sticky MAC addresses.

To enable sticky MAC address learning on an interface, ensure that the `mac learn no-limit` command is not configured.

### Port security violations

There are two types of port security violations.

- Mac address learning limit violation
- Mac address move violation

#### Mac address learning limit violation

After the number of secure MAC address reaches the maximum configured, if an interface receives a frame with the source MAC address different from any of the learned MAC addresses, the system considers this as a MAC address learning limit violation.

You can configure MAC address learning limit violation actions.

- `log` — The system drops the packet and displays a log message with the VLAN, interface, and the source MAC address that caused the violation.
- `drop` — The system drops the packet and does not display a log message.
- `forward` — The system forwards the packet without learning the source MAC address or displaying a log message.
- `shutdown` — The system shuts down the port.

#### Mac address move violation

If the system detects the same MAC address in a port-security-enabled interface which it has already learned through another port-security-enabled interface, by default, the system considers this as a MAC address move violation. You can configure MAC address move violation actions. You can also configure the system to permit MAC address movement across port security-enabled interfaces.

You can configure MAC address move violation actions.

- `log` — The system drops the packet and displays a log message with the VLAN, interface, and the source MAC address that caused the violation.
- `drop` — The system drops the packet and does not display a log message.
- `shutdown-both` — The system shuts down both the original and offending interfaces.
- `shutdown-offending` — The system shuts down the offending interface.
- `shutdown-original` — The system shuts down the interface that originally learned the MAC address that moved.

### MAC address aging

By default, dynamically-learned secure MAC addresses do not age out. You can enable aging for secure MAC addresses so that the dynamically-learned MAC addresses are deleted from the MAC address table after the configured aging period.

### Enable port security on the system

To enable port security on the system globally:

1. Enter the following command in CONFIGURATION mode:

```
switchport port-security
```



**NOTE:** By default, port security is enabled globally. To disable the port security feature on the system, use the `no switchport port-security` command in CONFIGURATION mode.

### Enable port security on an interface

To enable port security on an interface:

1. Enter the following command in INTERFACE mode:

```
switchport port-security
```

2. Enable port security in CONFIGURATION-PORT-SECURITY mode:

```
no disable
```

**NOTE:** To disable the port security feature on an interface, use the `disable` command in CONFIGURATION-PORT-SECURITY mode.

### Configure the MAC address learning limit

After you enable port security on an interface, the interface can learn one secure MAC address by default. This limit is applicable for both secure dynamic and secure static MAC addresses.

To configure the MAC address learning limit:

1. Enter the following command in INTERFACE mode:

```
switchport port-security
```

2. Configure the number of secure MAC addresses that an interface can learn in INTERFACE PORT SECURITY mode:

```
mac-learn {limit | no-limit}
```

For the `limit` keyword, the range is from 0 to 3072. To enable the interface to learn the maximum number of MAC addresses that the hardware supports, use the `no-limit` keyword.

### MAC address learning limit example

```
OS10# configure terminal
OS10(config)#interface ethernet 1/1/1
OS10(config-if-eth1/1/1)#switchport port-security
OS10(config-if-port-sec)# no disable
OS10(config-if-port-sec)#mac-learn limit 100
```

### Configure MAC address learning limit violation actions

Use the following commands in INTERFACE PORT SECURITY mode:

- To display which MAC address causes a violation, use the `log` option. The system also drops the packet.

```
OS10(config-if-port-sec)#mac-learn limit violation log
```

- To drop the packet when a MAC address learning limit violation occurs, use the `drop` option.

```
OS10(config-if-port-sec)#mac-learn limit violation drop
```

- To forward the packet when a MAC address learning limit violation occurs, use the `flood` option. The system does not learn the MAC address.

```
OS10(config-if-port-sec)#mac-learn limit violation forward
```

- To shut down an interface on a MAC address learning limit violation, use the `shutdown` option.

```
OS10(config-if-port-sec)#mac-learn limit violation shutdown
```

### MAC address learning limit violation actions configuration example

```
OS10# configure terminal
OS10(config)#interface ethernet 1/1/1
OS10(config-if-eth1/1/1)#switchport port-security
OS10(config-if-port-sec)#no disable
OS10(config-if-port-sec)#mac-learn limit 100
OS10(config-if-port-sec)#mac-learn limit violation shutdown
```

### Configure sticky MAC addresses



To enable sticky MAC address learning on an interface:

Enter the following command in INTERFACE PORT SECURITY mode:

```
sticky
```

**i** **NOTE:** Before enabling sticky MAC address learning, ensure that you restrict the number of MAC address that an interface can learn using the `mac-learn limit` command.

### Sticky MAC addresses configuration example

```
OS10# configure terminal
OS10(config)#interface ethernet 1/1/1
OS10(config-if-eth1/1/1)#switchport port-security
OS10(config-if-port-sec)#no disable
OS10(config-if-port-sec)#mac-learn limit 100
OS10(config-if-port-sec)#sticky
```

### Permit MAC address movement

Use the following command in INTERFACE PORT SECURITY mode:

```
OS10(config-if-port-sec)#mac-move allow
```

### MAC address movement configuration example

```
OS10# configure terminal
OS10(config)#interface ethernet 1/1/1
OS10(config-if-eth1/1/1)#switchport port-security
OS10(config-if-port-sec)#no disable
OS10(config-if-port-sec)#mac-learn limit 100
OS10(config-if-port-sec)#mac-move allow
```

### Configure MAC address movement violation actions

Use the following commands in INTERFACE PORT SECURITY mode:

- To display which MAC address causes a violation, use the `log` option. The system also drops the packet.

```
OS10(config-if-port-sec)#mac-move violation log
```

- To drop the packet when a MAC address movement violation occurs, use the `drop` option.

```
OS10(config-if-port-sec)#mac-move violation drop
```

- To shut down the original interface that learned the MAC address on a MAC movement violation, use the `shutdown-original` option.

```
OS10(config-if-port-sec)#mac-move violation shutdown-original
```

- To shut down the interface that detected a MAC address that is already learned by another interface, use the `shutdown-offending` option.

```
OS10(config-if-port-sec)#mac-move violation shutdown-offending
```

- To shut down both original and offending interfaces, use the `shutdown-both` option.

```
OS10(config-if-port-sec)#mac-move violation shutdown-both
```

### Recover an error-disabled interface

1. Shut down the interface in INTERFACE mode.

```
shutdown
```

2. Bring the interface up in INTERFACE mode.

```
no shutdown
```

### Clear an error-disabled state of all interfaces

- To clear the error-disabled state of all interfaces that was caused by a MAC address learning limit violation, use the following command in CONFIGURATION mode:

```
errdisable reset cause mac-learn-limit violation
```

- To clear the error-disabled state of all interfaces that was caused by a MAC address movement violation, use the following command in CONFIGURATION mode:

```
errdisable reset cause mac-move-violation
```

- To clear the error-disabled state of all interfaces that was caused by all violation incidents, use the following command in CONFIGURATION mode:

```
errdisable reset cause all
```

### Recover an error-disabled state of interfaces automatically

- To automatically recover error-disabled interfaces that was caused by a MAC address learning limit violation, use the following command in CONFIGURATION mode:

```
errdisable recovery cause mac-learn-limit violation
```

- To automatically recover error-disabled interfaces that was caused by a MAC address movement violation, use the following command in CONFIGURATION mode:

```
errdisable recovery cause mac-move-violation
```

- Configure the recovery interval timer to delay the recovery of an error-disabled interface in CONFIGURATION mode. The range is from 30 to 65,535 in seconds.

```
errdisable recovery interval 30
```

### Configure secure static MAC addresses

- To configure a secure static MAC address, use the following command in CONFIGURATION mode:

```
mac address-table static mac-address vlan vlan-id interface {ethernet node/slot/
port[:subport] | port-channel number}
```

 **NOTE:** The configured MAC address becomes secure MAC address only if you enable the port security feature on the interface.

### Secure static MAC addresses configuration example

```
OS10# configure terminal
OS10(config)#interface port-channel 1
OS10(config-if-po-1)#switchport port-security
OS10(config-if-port-sec)#no disable
OS10(config-if-po-1)#exit
OS10(config)# mac address-table static 03:ab:cd:21:ba:01 vlan 1 interface port-channel 1
```

### Remove statically-configured secure MAC addresses

To remove statically-configured secure MAC addresses, use the following command in EXEC mode:

```
clear mac address-table secure {{dynamic | sticky} {address mac_addr | vlan vlan-id |
interface {ethernet node/slot/port[:subport] | port-channel}} |_all}
```

### Remove statically-configured secure MAC addresses configuration example

```
OS10# clear mac address-table secure sticky vlan 1
OS10#clear mac address-table secure sticky interface port-channel 128
OS10#clear mac address-table secure sticky address 00:00:00:00:00:01 vlan 100
```

### View statically-configured secure MAC addresses

To view the statically-configured secure MAC addresses, use the following command in EXEC mode:

```
show mac address-table secure {{dynamic | static | sticky} {vlan vlan-id | interface {ethernet node/slot/port[:subport] | port-channel}}}
```

### View statically-configured secure MAC addresses example

```
OS10# show mac address-table secure sticky

VlanId MAC Address Type Interface
 1 4c:76:25:e5:4f:51 sticky ethernet1/1/5
 1 4c:76:25:e5:4f:55 sticky ethernet1/1/6
 1 4c:76:25:e5:4f:59 sticky ethernet1/1/7

os10# show mac address-table secure dynamic

VlanId MAC Address Type Interface
 10 4c:76:25:e5:4f:51 dynamic port-channel120
 11 4c:76:25:e5:4f:55 dynamic ethernet1/1/6
 12 4c:76:25:e5:4f:59 dynamic ethernet1/1/7

os10# show mac address-table secure static

VlanId MAC Address Type Interface
 10 4c:76:25:e5:4f:51 static port-channel120
 11 4c:76:25:e5:4f:55 static ethernet1/1/6
 12 4c:76:25:e5:4f:59 static ethernet1/1/7
```

### View the number of secure MAC addresses on the system

- To view the number of secure MAC addresses on the system, use the following command in EXEC mode:

```
show mac address-table count [interface {ethernet slot/port[:subport] | port-channel number | vlan vlan-id]
```

### View the number of secure MAC addresses on the system example

```
OS10# show MAC address-table count
MAC Entries for all vlans :
Dynamic Address Count: 10000
Total secure dynamic MAC addresses: 5000 of (10000)
Static Address (User-defined) Count : 5000
Total secure static MAC addresses:200 of (5000)
Total secure sticky MAC addresses :0
Total MAC Addresses in Use: 15000
```

### View port-security parameters for all interfaces

To view port-security parameters for all interfaces, use the following command in EXEC mode:

```
show switchport port-security [interface {ethernet node/slot/port[:subport] | port-channel port-channel-number}]
```

### View port-security parameters for all interfaces example

```
OS10# show switchport port-security

Global Port-security status :Enable

Interface name : eth1/1/1

Port Security :Enabled
Port Status :Error-Disable
Mac learn limit :100
Mac-learn limit-Violation action :Shutdown
Sticky :Disabled
Mac-move-allow :Not Allowed
mac-move-violation action :shutdown-both
Aging :Enabled
Total MAC Addresses :10
Secure static MAC Addresses :0
```

```

Sticky MAC Addresses :10
Secure Dynamic MAC addresses :0

Interface name : eth1/1/10

Port Security :Enabled
Port Status :Error-Disable
Mac learn limit :100
Mac-learn-limit-Violation action :Shutdown
Sticky :Disabled
Mac-move-allow :Not Allowed
mac-move-violation action :shutdown-both
Aging :Enabled
Total MAC Addresses :11
Secure static MAC Addresses :0
Sticky MAC Addresses :0
Secure Dynamic MAC addresses :11

```

```
OS10# show switchport port-security interface ethernet 1/1/1
```

```

Global Port-security status :Enable

Interface name : ethernet1/1/1

Port Security :Enabled
Port Status :Error-Disable
Mac-learn limit :1024
MaC-learn-limit-Violation Action :Shutdown
Sticky :Enabled
Mac-move-allow :Not Allowed
Mac-move-violation :shutdown-both
Aging :Disbaled
Total MAC Addresses :10
Secure static MAC Addresses :0
Sticky MAC Addresses :10
Secure Dynamic MAC addresses :0

```

```
OS10# show switchport port-security interface port-channel 120
```

```

Interface name : port-channel 120

Port Security :Disabled
Port Status : Up
mac-learn limit :1024
Mac-learn-limit-Violation Action :Flood
Sticky :Enabled
Mac-move-allow :Allowed
Mac-move-violation :shutdown-offending
Aging :Disabled
Total MAC Addresses :11
Secure static MAC Addresses :0
Sticky MAC Addresses :11
Secure Dynamic MAC addresses :0

```

### View the error disabled state of interfaces

The Errdisable Cause column displays one or more reasons for the error-disabled state of an interface. If an interface is put in to the Error Disabled state for multiple reasons, the interface does not come up unless you enable automatic recovery for all the reasons.

```
OS10# show errdisable recovery
```

```
Error-Disable Recovery Timer Interval : 300 seconds
```

```

Error-Disable Reason Recovery Status

bpduguard Enabled
MLL violation Enabled
MAC-move-violation Enabled

```

```

Interface Errdisable Cause Recovery Time Left
 (seconds)

```

```

ethernet1/1/1:1 bpduguard 30
ethernet1/1/1:2 bpduguard 1
ethernet1/1/10 bpduguard/mac-learn limit/mac-move 10
port-channel100 Mac-learn limit 50
port-channel128 mac-move 49
```

## Related Videos

[Port security on SmartFabric OS10](#)

## Port security commands

### clear mac address-table secure

Clears sticky and dynamic secure MAC address entries from the MAC address table.

|                           |                                                                                                                                                                                                                                                                                                                                                                                                                                                                                                                                                                                                                                                                                                                                                                                                                                                                                                                                                                                                                                                  |
|---------------------------|--------------------------------------------------------------------------------------------------------------------------------------------------------------------------------------------------------------------------------------------------------------------------------------------------------------------------------------------------------------------------------------------------------------------------------------------------------------------------------------------------------------------------------------------------------------------------------------------------------------------------------------------------------------------------------------------------------------------------------------------------------------------------------------------------------------------------------------------------------------------------------------------------------------------------------------------------------------------------------------------------------------------------------------------------|
| <b>Syntax</b>             | <code>clear mac address-table secure {{dynamic   sticky} {address <i>mac_addr</i>   vlan <i>vlan-id</i>   interface {ethernet <i>node/slot/port[:subport]</i>   port-channel <i>channel-number</i>}}   all}</code>                                                                                                                                                                                                                                                                                                                                                                                                                                                                                                                                                                                                                                                                                                                                                                                                                               |
| <b>Parameters</b>         | <ul style="list-style-type: none"> <li>• <code>dynamic</code> — Displays secure dynamic MAC address table entries.</li> <li>• <code>sticky</code> — Displays secure sticky MAC address table entries.</li> <li>• <code>all</code> — Deletes all secure sticky and dynamic MAC address table entries.</li> <li>• <code>address <i>mac_addr</i></code> — (Optional) Deletes a configured secure MAC address from the address table in <code>nn:nn:nn:nn:nn:nn</code> format.</li> <li>• <code>vlan <i>vlan-id</i></code> — (Optional) Delete all entries based on the VLAN number from the address table, from 1 to 4093.</li> <li>• <code>interface</code> — (Optional) Clear the interface type: <ul style="list-style-type: none"> <li>◦ <code>ethernet <i>node/slot/port[:subport]</i></code> — Delete the Ethernet interface configuration from the address table.</li> <li>◦ <code>port-channel <i>channel-number</i></code> — Delete the port-channel interface configuration from the address table, from 1 to 128.</li> </ul> </li> </ul> |
| <b>Default</b>            | None                                                                                                                                                                                                                                                                                                                                                                                                                                                                                                                                                                                                                                                                                                                                                                                                                                                                                                                                                                                                                                             |
| <b>Command Mode</b>       | EXEC                                                                                                                                                                                                                                                                                                                                                                                                                                                                                                                                                                                                                                                                                                                                                                                                                                                                                                                                                                                                                                             |
| <b>Usage Information</b>  | <p>This command deletes only sticky and dynamic secure MAC address entries from the MAC address table. The <code>clear mac address-table dynamic</code> command deletes all dynamic MAC address entries including secure dynamic MAC addresses.</p> <p>Use the <code>all</code> parameter to remove all secure sticky and dynamic entries from the MAC address table.</p>                                                                                                                                                                                                                                                                                                                                                                                                                                                                                                                                                                                                                                                                        |
| <b>Example</b>            | <pre>OS10# clear mac address-table secure sticky vlan 1  OS10#clear mac address-table secure sticky interface port-channel 128  OS10#clear mac address-table secure sticky address 00:00:00:00:00:01 vlan 100</pre>                                                                                                                                                                                                                                                                                                                                                                                                                                                                                                                                                                                                                                                                                                                                                                                                                              |
| <b>Supported Releases</b> | 10.5.1.0 or later                                                                                                                                                                                                                                                                                                                                                                                                                                                                                                                                                                                                                                                                                                                                                                                                                                                                                                                                                                                                                                |

### errdisable recovery cause

Brings up an error-disabled interface automatically after the recovery timer expires.

**Syntax** `errdisable recovery cause {mac-learn-limit-violation | mac-move-violation}`

**Parameters**

- `mac-learn-limit-violation` — Brings up an error disabled interface that exceeded the maximum number of MAC addresses that it can learn.
- `mac-move-violation` — Brings up an error disabled interface that was brought down due to station move violation.

**Default** Automatic recovery is disabled

**Command Mode** CONFIGURATION

**Usage Information** The `no` version of this command disables automatic recovery.

**Example**

```
OS10(config-if-port-sec)# errdisable recovery cause mac-learn-limit-violation
```

**Supported Releases** 10.5.1.0 or later

## errdisable reset cause

Resets the error disabled state of interfaces.

**Syntax** `errdisable reset cause {all | mac-learn-limit-violation | mac-move-violation}`

**Parameters**

- `all` — Resets the error disabled state of all interfaces.
- `mac-learn-limit-violation` — Resets the error disabled state of interfaces that exceeded the maximum number of MAC addresses that it can learn.
- `mac-move-violation` — Resets the error disabled state of interfaces due to a station move violation.

**Default** None

**Command Mode** CONFIGURATION

**Usage Information** This command resets the error disabled state of all interfaces according to the option you select.

**Example**

```
OS10(config)# errdisable reset cause mac-learn-limit-violation
```

**Supported Releases** 10.5.1.0 or later

## mac-learn

Configures the number of MAC addresses an interface can learn.

**Syntax** `mac-learn {limit learn-limit-value | no-limit}`

**Parameters**

- `limit learn-limit-value` — Enter a value from 1 to 3072.
- `no-limit` — The interface learns the maximum number of MAC addresses that the system supports.

**Default** One MAC address

**Command Mode** CONFIGURATION-PORT-SECURITY

**Usage Information** After you enable port security on an interface, by default, the interface learns a maximum of one MAC address. Use the `mac-learn limit` command to configure the number of MAC addresses an interface can learn.

If the system contains more static MAC addresses than the MAC address learn limit, the system displays an error message. You can delete a few static MAC addresses or increase the number of MAC addresses the port can learn.

If the total number of dynamic MAC addresses on an interface is greater than the newly configured MAC learn limit, the dynamic MAC addresses are flushed.

**Example**

```
OS10(config-if-port-sec)# mac-learn limit 100
```

**Supported Releases**

10.5.1.0 or later

## mac-learn limit violation

Configures MAC address learning limit violation actions.

**Syntax**

```
mac-learn limit violation {drop | forward | log | shutdown}
```

**Parameters**

- **drop** — Drops the packet when an interface receives it from a new device after the learning limit is reached.
- **forward** — Forwards the packet when an interface receives it from a new device after the learning limit is reached.
- **log** — Displays a log message when an interface receives a packet from a new device after the learning limit is reached and drops the packet.
- **shutdown** — Shuts down the interface when it receives a packet from a new device after the learning limit is reached.

**Default**

Disabled

**Command Mode**

CONFIGURATION-PORT-SECURITY

**Usage Information**

The `no` version of this command disables MAC address learning limit violation actions.

**Example**

```
OS10(config-if-port-sec)# mac-learn limit violation drop
```

If you configure the system with the `mac-learn limit violation log` command, the system displays a log message similar to the following:

```
Jan 10 09:12:24: Learn limit violation occurred on eth 1/1/1: vlan-100:
MAC-00:00:07:00:04:89
```

**Supported Releases**

10.5.1.0 or later

## mac-move allow

Enables MAC address movement.

**Syntax**

```
mac-move allow
```

**Parameters**

None

**Default**

MAC address movement is disabled.

**Command Mode**

CONFIGURATION-PORT-SECURITY

**Usage Information**

MAC address movement is not allowed for secure static and sticky MAC addresses. By default, MAC address movement for dynamically-learned MAC address is disabled on the system.

The `no` version of this command disables MAC address movement.

**Example**

```
OS10(config-if-port-sec)# mac-move allow
```

**Supported Releases**

10.5.1.0 or later

## mac-move violation

Configures station move violation actions.

**Syntax**

```
mac-move violation {drop | log | shutdown-both | shutdown-offending | shutdown-original}
```

**Parameters**

- `drop` — Drops the received packet when an interface detects the same MAC address that the system has already learned on a different interface.
- `log` — Displays a log message when an interface detects the same MAC address that the system has already learned on a different interface.
- `shutdown-both` — Shuts down both interfaces that learned the same MAC address.
- `shutdown-offending` — Shuts down the interface which detects the same MAC address that the system has already learned on a different interface.
- `shutdown-original` — Shuts down the interface that originally learned the MAC address.

**Default**

The system displays a log message when a MAC address move violation occurs.

**Command Mode**

CONFIGURATION-PORT-SECURITY

**Usage Information**

The `no` version of this command disables MAC move violation actions.

**Example**

```
OS10(config-if-port-sec)# mac-move-violation log
```

If you configure the system with the `mac-move-violation log` command, the system displays a log message similar to the following:

```
MAC Move Violation occurred: originalInterface: ethernet 1/13/1,
offendingInterface: Ethernet 1/13/2,vlanId: 100, MACAddr:
00:00:07:00:04:15.
```

**Supported Releases**

10.5.1.0 or later

## mac address-table static

Configures a static entry for the Layer 2 MAC address table.

**Syntax**

```
mac address-table static mac-address vlan vlan-id interface {ethernet node/slot/port[:subport] | port-channel number}
```

**Parameters**

- `mac-address` — Enter the MAC address to add to the table in `nn:nn:nn:nn:nn:nn` format.
- `vlan vlan-id` — Enter the VLAN to apply the static MAC address to, from 1 to 4093.
- `interface` — Enter the interface type:
  - `ethernet node/slot/port[:subport]` — Enter the Ethernet information.
  - `port-channel channel-number` — Enter a port-channel interface number, from 1 to 128.

**Default**

Not configured

**Command Mode**

CONFIGURATION

**Usage Information**

If you configure the `switchport port-security` command on an interface, you can configure MAC address learning limit, sticky MAC address, and control MAC move.

The `no` version of this command resets the value to the default.



**Example (VLAN)**

```
OS10(config)# mac address-table static 34:17:eb:f2:ab:c6 vlan 1
interface ethernet 1/1/30
```

**Example (Port-Channel)**

```
OS10(config)# mac address-table static 34:17:eb:02:8c:33 vlan 10
interface port-channel 1
```

**Supported Releases**

10.2.0E or later

## show switchport port-security

Displays port security information of interfaces.

**Syntax**

```
show switchport port-security [interface {ethernet node/slot/port[:subport]
| port-channel port-channel-number}]
```

**Parameters**

- **interface** — Displays the interface type:
  - *ethernet node/slot/port[:subport]* — Displays the port security information of an Ethernet interface.
  - *port-channel channel-number* — Displays the port security information of an Ethernet interface, from 1 to 128.

**Default**

None

**Command Mode**

EXEC

**Usage Information**

This command displays port security information of all interfaces.

**Example (Address)**

```
OS10# show switchport port-security

Global Port-security status :Enable

Interface name : eth1/1/1

Port Security :Enabled
Port Status :Error-Disable
Mac learn limit :100
MAC-learn-limit-Violation action :Shutdown
Sticky :Disabled
Mac-move-allow :Not Allowed
mac-move-violation action :shutdown-both
Aging :Enabled
Total MAC Addresses :10
Secure static MAC Addresses :0
Sticky MAC Addresses :10
Secure Dynamic MAC addresses :0

Interface name : eth1/1/10

Port Security :Enabled
Port Status :Error-Disable
Mac learn limit :100
MAC-learn-limit-Violation action :Shutdown
Sticky :Disabled
Mac-move-allow :Not Allowed
mac-move-violation action :shutdown-both
Aging :Enabled
Total MAC Addresses :11
Secure static MAC Addresses :0
```

```
Sticky MAC Addresses :0
Secure Dynamic MAC addresses :11
```

```
OS10# show switchport port-security interface ethernet 1/1/1

Global Port-security status :Enable

Interface name : ethernet1/1/1

Port Security :Enabled
Port Status :Error-Disable
Mac-learn-limit :1024
MaC-learn-limit-Violation Action :Shutdown
Sticky :Enabled
Mac-move-allow :Not Allowed
Mac-move-violation :shutdown-both
Aging :Disbaled
Total MAC Addresses :10
Secure static MAC Addresses :0
Sticky MAC Addresses :10
Secure Dynamic MAC addresses :0

OS10# show switchport port-security interface port-channel 120

Interface name : port-channel 120

Port Security :Disabled
Port Status : Up
mac-learning-limit :1024
Mac-learn-limit-Violation Action :Flood
Sticky :Enabled
Mac-move-allow :Allowed
Mac-move-violation :shutdown-offending
Aging :Disabled
Total MAC Addresses :11
Secure static MAC Addresses :0
Sticky MAC Addresses :11
Secure Dynamic MAC addresses :0
```

**Supported Releases** 10.5.1.0 or later

## switchport port-security (interface)

Enables port security on an interface.

**Syntax** switchport port-security

**Parameters** None

**Default** Disabled

**Command Mode** INTERFACE

**Usage Information** After you enable port security on an interface, by default, the maximum number of MAC addresses that the interface can learn is one. This is applicable for both dynamic and static secure MAC addresses. After you enable port security on an interface, by default, sticky MAC addresses and MAC movement are disabled on the interface.

This command enables port security on an interface. If you disable the feature globally, this command does not take effect on an interface.

The no version of this command disables port security on an interface.

### Example

```
OS10(config-if-eth1/1/2)# switchport port-security
```

**Supported Releases** 10.5.1.0 or later

## switchport port-security (global)

Enables the port security feature on the system globally.

**Syntax** `switchport port-security`

**Parameters** None

**Default** Port security is enabled globally.

**Command Mode** ● CONFIGURATION

**Usage Information** After you enable the port security feature on the system globally, enable port security on the required interfaces using this command in INTERFACE CONFIGURATION mode.

The `no` version of this command disables the port security feature on the system.

### Example

```
OS10(config)# no switchport port-security
```

**Supported Releases** 10.5.1.0 or later

## sticky

Enables sticky MAC address learning or converts existing dynamic MAC addresses as sticky.

**Syntax** `sticky`

**Parameters** None

**Default** Disabled

**Command Mode** CONFIGURATION-PORT-SECURITY

**Usage Information** This command enables sticky MAC address learning or converts existing dynamic MAC addresses as sticky. Sticky MAC addresses persist system reloads.

For the sticky MAC feature to function, enable MAC address learning limit using the `mac learn-limit` command.

### Example

```
OS10(config-if-port-sec)# sticky
```

**Supported Releases** 10.5.1.0 or later

## aging

Enables the aging timer for dynamically-learned MAC addresses on an interface that is configured with port security.

**Syntax** `aging {off | on}`

**Parameters** None

**Default** Dynamically-learned MAC addresses on an interface that is configured with port security do not age out.

**Command Mode** CONFIGURATION-PORT-SECURITY

**Usage Information** Secure sticky MAC addresses never age out.

**Example**

```
OS10(config-if-port-sec)# aging on
```

**Supported Releases**

10.5.1.0 or later

## show mac address-table secure

Displays information about the secure MAC addresses in the MAC address table.

**Syntax**

```
show mac address-table secure {{dynamic | static | sticky} {vlan vlan-id | interface {ethernet node/slot/port[:subport] | port-channel}} | address mac-address}
```

**Parameters**

- `dynamic` — Displays secure dynamic MAC address table entries.
- `static` — Displays secure static MAC address table entries.
- `sticky` — Displays secure sticky MAC address table entries.
- `address` — Displays a specific MAC address table entry.
- `vlan vlan-id` — Displays all entries based on the VLAN number from the address table, from 1 to 4093.
- `interface` — Displays the interface type:
  - `ethernet node/slot/port[:subport]` — Displays the Ethernet interface configuration from the address table.
  - `port-channel channel-number` — Displays the port-channel interface configuration from the address table, from 1 to 128.

**Default**

None

**Command Mode**

EXEC

**Usage Information**

The system maintains secure static and sticky MAC address entries saved in the startup configuration file and deletes secure dynamic entries upon reboot.

**Example (Address)**

```
OS10# show MAC address-table secure sticky

VlanId MAC Address Type Interface

1 4c:76:25:e5:4f:51 sticky
ethernet1/1/5
1 4c:76:25:e5:4f:55 sticky
ethernet1/1/6
1 4c:76:25:e5:4f:59 sticky
ethernet1/1/7
```

**Supported Releases**

10.5.1.0 or later

## show errdisable

Displays information on errdisable configurations and port recovery status.

**Syntax**

```
show errdisable [detect | recovery]
```

**Parameters**

- `detect`—Displays whether error disable detection is enabled.
- `recovery`—Displays details of recovery cause, recovery interval, and recovery status of the error disabled port.

**Default**

None

**Command Mode**

EXEC

**Usage Information**

The `Errrdisable Cause` column displays one or more reasons for the error-disabled state of an interface. If an interface is put in to error disabled state for multiple reasons, the interface does not come up unless you enable automatic recovery for all reasons.

**Example**

```
OS10# show errrdisable detect
```

| Error-Disable Cause | Detect Status |
|---------------------|---------------|
| bpduguard           | Enabled       |

```
OS10# show errrdisable recovery
```

```
Error-Disable Recovery Timer Interval : 300 seconds
```

| Error-Disable Reason | Recovery Status |
|----------------------|-----------------|
| bpduguard            | Enabled         |
| MLL violation        | Enabled         |
| MAC-move-violation   | Enabled         |

| Left Interface  | Errrdisable Cause                     | Recovery Time (seconds) |
|-----------------|---------------------------------------|-------------------------|
| ethernet1/1/1:1 | bpduguard                             | 30                      |
| ethernet1/1/1:2 | bpduguard                             | 1                       |
| ethernet1/1/10  | bpduguard/mac-learning-limit/mac-move | 10                      |
| port-channel100 | Mac-learning-limit                    | 50                      |
| port-channel128 | mac-move                              | 49                      |

**Supported Releases**

10.4.2.0 or later

**show mac address-table count**

Displays the number of entries in the MAC address table.

**Syntax**

```
show mac address-table count [interface {ethernet slot/port:subport | port-channel number | vlan vlan-id}]
```

**Parameters**

- `interface` — Displays the interface type:
  - `ethernet node/slot/port[:subport]` — Displays the Ethernet interface configuration from the address table.
  - `port-channel channel-number` — Displays the port-channel interface configuration from the address table, from 1 to 128.
- `vlan vlan-id` — Displays information for a specific VLAN, from 1 to 4093.

**Defaults**

None

**Command Mode**

EXEC

**Usage Information**

None

**Example**

```
OS10# show MAC address-table count
MAC Entries for all vlans :
Dynamic Address : 10000
Total secure dynamic MAC addresses: 5000 of (10000)
Static Address (User-defined) Count : 5000
Total secure static MAC addresses:200 of (5000)
Total secure sticky MAC addresses :0
Total MAC Addresses in Use: 15000
```

**Supported  
Releases**

10.1.0E or later

# OpenFlow

Switches implement the control plane and data plane in the same hardware. Software-defined network (SDN) decouples the software (control plane) from the hardware (data plane). A centralized SDN controller handles the control plane traffic and hardware configuration for data plane flows.

The SDN controller is the "brain" of an SDN. The SDN controller uses north-bound application programming interfaces (APIs) to communicate with the business logic applications and south-bound APIs to set up controlled network devices, such as OS10 switches.

OpenFlow is an implementation of SDN. OpenFlow enables programmable networks. You can develop SDN controller network applications using representational state transfer (REST) or JAVA APIs (north-bound APIs) to business logic applications. The SDN controller uses OpenFlow south-bound APIs to communicate with the switches and relay information from business logic applications.

Advantages of an SDN include customization, accelerating new feature development, lower operating costs, and fostering an open, multi-vendor environment.

OS10 supports OpenFlow protocol versions 1.0 and 1.3.

OS10 supports OpenFlow-only mode. In this mode, the SDN controller controls data path of the switch. The OpenFlow pipeline processes all data packets.

**i** **NOTE:** When the switch is in OpenFlow mode, all Layer 2 (L2) and Layer 3 (L3) protocols are disabled. Link-level protocols such as Link Layer Discovery Protocol (LLDP), Dot1x, and Virtual Link Trunking (VLT) are disabled as well.

**i** **NOTE:** OpenFlow Hybrid mode is not supported.

## Supported Platforms

- S4048-ON
- S4048T-ON
- S4100-ON
- S4248FB-ON
- S4248FBL-ON
- S6010-ON
- Z9100-ON
- Z9264F-ON

**i** **NOTE:** S3048-ON is not supported.

OS10 OpenFlow implementation reserves VLANs 1 and 4095.

The following is a known OpenFlow restriction in OS10:

Converting the switch from OpenFlow mode back to Normal mode removes all OpenFlow configurations. The switch returns to the pre-Openflow status. The management, interface (maximum transmission unit (MTU) and LLDP), and authentication, authorization, and accounting (AAA) settings specified in the Normal mode are retained.

To start up the switch in Factory Default mode, you must:

1. Delete the startup configuration using the `delete startup-configuration` command.
2. Enter the `reload` command.

**i** **NOTE:** Do not use the `no openflow` or `no mode openflow-only` command.

```
OS10# delete startup-configuration
OS10# reload
```

## Configuration notes

All Dell EMC PowerSwitches except MX-Series, S4200-Series, S5200 Series, and Z9332F-ON:

The ONOS controller does not encode the DSCP flow entry values that are matched according to the Openflow 1.0 specification. Hence when you install a flow entry in OpenFlow 1.0, that matches the IP DSCP, the ONOS controller sets an incorrect flow-entry encoding value for IP DSCP.

## OpenFlow logical switch instance

In OpenFlow-only mode, you can configure only one logical switch instance. After you enable OpenFlow mode, create a logical switch instance. The logical switch instance is disabled by default. When the logical switch instance is enabled, the OpenFlow application starts the connection with the configured controller.

When you create an OpenFlow logical switch instance, all the physical interfaces are automatically added to it.

## OpenFlow controller

OS10 is qualified with the following SDN controllers:

- RYU
- Open Network Operating System (ONOS)

To establish a connection with the controller, configure the IPv4 address of the controller and port ID in the OpenFlow logical switch instance. The default port is 6653. You can connect controllers to the switch in OOB Connection mode. However, you can use any of the front-panel ports as the management interface using the `in-band` command. The inband port is removed from the OpenFlow switch instance and is not controlled by the controller.

The management port MTU is 1532 and the inband port MTU is 9216.

OpenFlow uses the Transmission Control Protocol (TCP) and Transport Layer Security (TLS) protocol for communication.

If the OpenFlow switch loses connection with the controller, the switch immediately enters Fail Secure mode. All the flows the controller installs are retained on the switch. The flow entries are removed based on the hard or idle timeout that you configure.

## OpenFlow version 1.3

This section provides information about OpenFlow version 1.3 specifications for OS10.

### Ports

An OpenFlow switch supports the following OpenFlow ports:

**Table 55. Supported port types**

| Port types            | Support       |
|-----------------------|---------------|
| Physical ports        | Supported     |
| Logical ports         | Not supported |
| <b>Reserved ports</b> |               |
| (Required) ALL        | Supported     |
| (Required) CONTROLLER | Supported     |
| (Required) TABLE      | Not supported |
| (Required) IN PORT    | Not supported |
| (Required) ANY        | Supported     |
| (Optional) LOCAL      | Not supported |
| (Optional) NORMAL     | Not supported |
| (Optional) FLOOD      | Not supported |



## Flow table

An OpenFlow flow table consists of flow entries. Each flow table entry contains the following fields:

**Table 56. Supported fields**

| Fields       | Support       |
|--------------|---------------|
| match_fields | Supported     |
| priority     | Supported     |
| counters     | Supported     |
| instructions | Supported     |
| timeouts     | Supported     |
| cookie       | Not supported |

## Group table

Not supported

## Meter table

Not supported

## Instructions

Each flow entry contains a set of instructions that execute when a packet matches the entry.

**Table 57. Supported instructions**

| Instruction                             | Support       |
|-----------------------------------------|---------------|
| (Optional) Meter meter id               | Not supported |
| (Optional) Apply-Actions action(s)      | Supported     |
| (Optional) Clear-Actions                | Not supported |
| (Required) Write-Actions action(s)      | Supported     |
| (Optional) Write-Metadata metadata/mask | Not supported |
| (Required) Goto-table next-table-id     | Not supported |

## Action set

An action set associates with each packet.

**Table 58. Supported action sets**

| Action set        | Support       |
|-------------------|---------------|
| copy TTL inwards  | Not supported |
| pop               | Not supported |
| push-MPLS         | Not supported |
| push-VLAN         | Not supported |
| copy TTL outwards | Not supported |

**Table 58. Supported action sets (continued)**

| Action set    | Support                      |
|---------------|------------------------------|
| decrement TTL | Not supported                |
| set           | Supported (selective fields) |
| qos           | Not supported                |
| group         | Not supported                |
| output        | Supported                    |

## Action types

An action type associates with each packet.

**Table 59. Supported action types**

| Action type      | Support                                                                                                                                                                                                                   |
|------------------|---------------------------------------------------------------------------------------------------------------------------------------------------------------------------------------------------------------------------|
| Output           | Supported                                                                                                                                                                                                                 |
| Set-queue        | Not supported                                                                                                                                                                                                             |
| Drop             | Supported                                                                                                                                                                                                                 |
| Group            | Not supported                                                                                                                                                                                                             |
| Push-tag/Pop-tag | Not supported                                                                                                                                                                                                             |
| Set-field        | Partially supported <ul style="list-style-type: none"> <li>• Source MAC—Supported</li> <li>• Destination MAC—Supported</li> <li>• VLAN ID—Supported</li> <li>• VLAN PCP—Supported</li> <li>• IP DSCP—Supported</li> </ul> |
| change-TTL       | Not supported                                                                                                                                                                                                             |

## Counters

Counters are used for statistical purposes.

**Table 60. Supported counters**

| Required/Optional     | Counter                          | Bits | Support   |
|-----------------------|----------------------------------|------|-----------|
| <b>Per flow table</b> |                                  |      |           |
| Required              | Reference count (active entries) | 32   | Supported |
| Optional              | Packet lookups                   | 64   | Supported |
| Optional              | Packet matches                   | 64   | Supported |
| <b>Per flow entry</b> |                                  |      |           |
| Optional              | Received packets                 | 64   | Supported |
| Optional              | Received bytes                   | 64   | Supported |
| Required              | Duration (seconds)               | 32   | Supported |
| Optional              | Duration (nanoseconds)           | 32   | Supported |
| <b>Per port</b>       |                                  |      |           |

**Table 60. Supported counters (continued)**

| <b>Required/Optional</b> | <b>Counter</b>                 | <b>Bits</b> | <b>Support</b> |
|--------------------------|--------------------------------|-------------|----------------|
| Required                 | Received packets               | 64          | Supported      |
| Required                 | Transmitted packets            | 64          | Supported      |
| Optional                 | Received bytes                 | 64          | Supported      |
| Optional                 | Transmitted bytes              | 64          | Supported      |
| Optional                 | Receive drops                  | 64          | Not supported  |
| Optional                 | Transmit drops                 | 64          | Not supported  |
| Optional                 | Receive errors                 | 64          | Supported      |
| Optional                 | Transmit errors                | 64          | Supported      |
| Optional                 | Receive frame alignment errors | 64          | Not supported  |
| Optional                 | Receive overrun errors         | 64          | Not supported  |
| Optional                 | Receive CRC errors             | 64          | Supported      |
| Optional                 | Collisions                     | 64          | Supported      |
| Required                 | Duration (seconds)             | 32          | Not supported  |
| Optional                 | Duration (nanoseconds)         | 32          | Not supported  |
| <b>Per queue</b>         |                                |             |                |
| Required                 | Transmit packets               | 64          | Not supported  |
| Optional                 | Transmit bytes                 | 64          | Not supported  |
| Optional                 | Transmit overrun errors        | 64          | Not supported  |
| Required                 | Duration (seconds)             | 32          | Not supported  |
| Optional                 | Duration (nanoseconds)         | 32          | Not supported  |
| <b>Per group</b>         |                                |             |                |
| Optional                 | Reference count (flow entries) | 32          | Not supported  |
| Optional                 | Packet count                   | 64          | Not supported  |
| Optional                 | Byte count                     | 64          | Not supported  |
| Required                 | Duration (seconds)             | 32          | Not supported  |
| Optional                 | Duration (nanoseconds)         | 32          | Not supported  |
| <b>Per group bucket</b>  |                                |             |                |
| Optional                 | Packet count                   | 64          | Not supported  |
| Optional                 | Byte count                     | 64          | Not supported  |
| <b>Per meter</b>         |                                |             |                |
| Optional                 | Flow count                     | 32          | Not supported  |
| Optional                 | Input packet count             | 64          | Not supported  |
| Optional                 | Input byte count               | 64          | Not supported  |
| Required                 | Duration (seconds)             | 32          | Not supported  |
| Optional                 | Duration (nanoseconds)         | 32          | Not supported  |
| <b>Per meter band</b>    |                                |             |                |

**Table 60. Supported counters (continued)**

| Required/Optional | Counter              | Bits | Support       |
|-------------------|----------------------|------|---------------|
| Optional          | In-band packet count | 64   | Not supported |
| Optional          | In-band byte count   | 64   | Not supported |

**Configuration notes**

Dell EMC PowerSwitch S4200-ON Series:

- In the show interface vlan command output, the VLAN octet counters are not displayed accurately.
- If a packet hits two ACL tables, the counter with higher priority statistics gets incremented and the other actions are merged and applied.

## OpenFlow protocol

The OpenFlow protocol supports three message types, each with multiple subtypes:

- Controller-to-switch
- Asynchronous
- Symmetric

**Controller-to-switch****Table 61. Supported controller-to-switch types**

| Controller-to-switch types | Supported/Not supported |
|----------------------------|-------------------------|
| Feature request            | Supported               |
| Configuration get          | Supported               |
| Configuration set          | Supported               |
| Modify-state               | Supported               |
| Read-state                 | Supported               |
| Packet-out                 | Supported               |
| Barrier                    | Supported               |
| Role-request               | Supported               |

**Asynchronous****Table 62. Supported asynchronous types**

| Asynchronous types | Supported/Not supported |
|--------------------|-------------------------|
| Packet-in          | Supported               |
| Flow-removed       | Supported               |
| Port-status        | Supported               |
| Error              | Supported               |

**Symmetric****Table 63. Supported symmetric types**

| Symmetric types | Supported/Not supported |
|-----------------|-------------------------|
| Hello           | Supported               |
| Echo            | Supported               |
| Experimenter    | Not supported           |

## Connection setup TCP

**Table 64. Supported modes**

| Modes                      | Supported/Not supported                                                                                                  |
|----------------------------|--------------------------------------------------------------------------------------------------------------------------|
| Connection interruption    | <ul style="list-style-type: none"> <li>fail-secure-mode—Supported</li> <li>fail-standalone-mode—Not supported</li> </ul> |
| TLS encryption             | Supported                                                                                                                |
| Multiple controller        | Not supported                                                                                                            |
| Auxiliary connections      | Not supported                                                                                                            |
| Number of logical switches | One                                                                                                                      |

## Supported controllers

REST APIs on

- RYU
- ONOS

## Flow table modification messages

**Table 65. Supported messages**

| Flow table modification messages | Supported/Not supported |
|----------------------------------|-------------------------|
| OFFPC_ADD=0                      | Supported               |
| OFFPC_MODIFY=1                   | Supported               |
| OFFPC_MODIFY_STRICT=2            | Supported               |
| OFFPC_DELETE=3                   | Supported               |
| OFPCPC_DELETE_STRICT=4           | Supported               |

## Message types

**Table 66. Supported message types**

| Message Type                  | Message                   | Support   |
|-------------------------------|---------------------------|-----------|
| Immutable messages            | OFPT_HELLO=0              | Supported |
|                               | OFPT_ERROR=1              | Supported |
|                               | OFPT_ECHO_REQUEST=2       | Supported |
|                               | OFPT_ECHO_REPLY=3         | Supported |
| Switch configuration messages | OFPT_FEATURES_REQUEST=5   | Supported |
|                               | OFPT_FEATURES_REPLY=6     | Supported |
|                               | OFPT_GET_CONFIG_REQUEST=7 | Supported |
|                               | OFPT_GET_CONFIG_REPLY=8   | Supported |
|                               | OFPT_SET_CONFIG=9         | Supported |
| Asynchronous messages         | OFPT_PACKET_IN=10         | Supported |

**Table 66. Supported message types (continued)**

| Message Type                                    | Message                          | Support       |
|-------------------------------------------------|----------------------------------|---------------|
|                                                 | OFPT_FLOW_REMOVED=11             | Supported     |
|                                                 | OFPT_PORT_STATUS=12              | Supported     |
| Controller command messages                     | OFPT_PACKET_OUT=13               | Supported     |
|                                                 | OFPT_FLOW_MOD=14                 | Supported     |
|                                                 | OFPT_GROUP_MOD=15                | Not supported |
|                                                 | OFPT_PORT_MOD=16                 | Supported     |
|                                                 | OFPT_TABLE_MOD=17                | Not supported |
| Multipart messages                              | OFPT_MULTIPART_REQUEST=18        | Supported     |
|                                                 | OFPT_MULTIPART_REPLY=19          | Supported     |
| Barrier messages                                | OFPT_BARRIER_REQUEST=20          | Supported     |
|                                                 | OFPT_BARRIER_REPLY=21            | Supported     |
| Queue configuration messages                    | OFPT_QUEUE_GET_CONFIG_REQUEST=22 | Not supported |
|                                                 | OFPT_QUEUE_GET_CONFIG_REPLY=23   | Not supported |
| Controller role change request messages         | OFPT_ROLE_REQUEST=24             | Not supported |
|                                                 | OFPT_ROLE_REPLY=25               | Not supported |
| Asynchronous message configuration              | OFPT_GET_ASYNC_REQUEST=26        | Not supported |
|                                                 | OFPT_GET_ASYNC_REPLY=27          | Not supported |
|                                                 | OFPT_SET_ASYNC=28                | Not supported |
| Meters and rate limiters configuration messages | OFPT_METER_MOD=29                | Not supported |

## Flow match fields

**Table 67. Supported fields**

| Flow match fields          | Supported/Not supported |
|----------------------------|-------------------------|
| OFPXMT_OFB_IN_PORT = 0     | Supported               |
| OFPXMT_OFB_IN_PHY_PORT = 1 | Not supported           |
| OFPXMT_OFB_METADATA = 2    | Not supported           |
| OFPXMT_OFB_ETH_DST = 3     | Supported               |
| OFPXMT_OFB_ETH_SRC = 4     | Supported               |
| OFPXMT_OFB_ETH_TYPE = 5    | Supported               |
| OFPXMT_OFB_VLAN VID = 6    | Supported               |
| OFPXMT_OFB_VLAN PCP = 7    | Supported               |

**Table 67. Supported fields (continued)**

| <b>Flow match fields</b>       | <b>Supported/Not supported</b> |
|--------------------------------|--------------------------------|
| OFPXMT_OFB_IP_DSCP = 8         | Supported                      |
| OFPXMT_OFB_IP_ECN = 9          | Supported                      |
| OFPXMT_OFB_IP_PROTO = 10       | Supported                      |
| OFPXMT_OFB_IPV4_SRC = 11       | Supported                      |
| OFPXMT_OFB_IPV4_DST = 12       | Supported                      |
| OFPXMT_OFB_TCP_SRC = 13        | Supported                      |
| OFPXMT_OFB_TCP_DST = 14        | Supported                      |
| OFPXMT_OFB_UDP_SRC = 15        | Supported                      |
| OFPXMT_OFB_UDP_DST = 16        | Supported                      |
| OFPXMT_OFB_SCTP_SRC = 17       | Not supported                  |
| OFPXMT_OFB_SCTP_DST = 18       | Not supported                  |
| OFPXMT_OFB_ICMPV4_TYPE = 19    | Supported                      |
| OFPXMT_OFB_ICMPV4_CODE = 20    | Supported                      |
| OFPXMT_OFB_ARP_OP = 21         | Not supported                  |
| OFPXMT_OFB_ARP_SPA = 22        | Not supported                  |
| OFPXMT_OFB_ARP_TPA = 23        | Not supported                  |
| OFPXMT_OFB_ARP_SHA = 24        | Not supported                  |
| OFPXMT_OFB_ARP_THA = 25        | Not supported                  |
| OFPXMT_OFB_IPV6_SRC = 26       | Not supported                  |
| OFPXMT_OFB_IPV6_DST = 27       | Not supported                  |
| OFPXMT_OFB_IPV6_FLABEL = 28    | Not supported                  |
| OFPXMT_OFB_ICMPV6_TYPE = 29    | Not supported                  |
| OFPXMT_OFB_ICMPV6_CODE = 30    | Not supported                  |
| OFPXMT_OFB_IPV6_ND_TARGET = 31 | Not supported                  |
| OFPXMT_OFB_IPV6_ND_SLL = 32    | Not supported                  |
| OFPXMT_OFB_IPV6_ND_TLL = 33    | Not supported                  |
| OFPXMT_OFB_MPLS_LABEL = 34     | Not supported                  |
| OFPXMT_OFB_MPLS_TC = 35        | Not supported                  |
| OFPXMT_OFB_MPLS_BOS = 36       | Not supported                  |

**Table 67. Supported fields (continued)**

| Flow match fields           | Supported/Not supported |
|-----------------------------|-------------------------|
| OFFXMT_OFB_PBB_ISID = 37    | Not supported           |
| OFFXMT_OFB_TUNNEL_ID = 38   | Not supported           |
| OFFXMT_OFB_IPV6_EXTHDR = 39 | Not supported           |

## Action structures

**Table 68. Supported action structures**

| Action structures        | Supported/Not supported |
|--------------------------|-------------------------|
| OFFPAT_OUTPUT = 0        | Supported               |
| OFFPAT_COPY_TTL_OUT = 11 | Not supported           |
| OFFPAT_COPY_TTL_IN = 12  | Not supported           |
| OFFPAT_SET_MPLS_TTL = 15 | Not supported           |
| OFFPAT_DEC_MPLS_TTL = 16 | Not supported           |
| OFFPAT_PUSH_VLAN = 17    | Not supported           |
| OFFPAT_POP_VLAN = 18     | Not supported           |
| OFFPAT_PUSH_MPLS = 19    | Not supported           |
| OFFPAT_POP_MPLS = 20     | Not supported           |
| OFFPAT_SET_QUEUE = 21    | Not supported           |
| OFFPAT_GROUP = 22        | Not supported           |
| OFFPAT_SET_NW_TTL = 23   | Not supported           |
| OFFPAT_DEC_NW_TTL = 24   | Not supported           |
| OFFPAT_SET_FIELD = 25    | Supported               |
| OFFPAT_PUSH_PBB = 26     | Not supported           |
| OFFPAT_POP_PBB = 27      | Not supported           |

## Capabilities supported by the data path

**Table 69. Supported capabilities**

| Capabilities               | Supported/Not supported |
|----------------------------|-------------------------|
| OFFPC_FLOW_STATS = 1 << 0  | Supported               |
| OFFPC_TABLE_STATS = 1 << 1 | Not supported           |
| OFFPC_PORT_STATS = 1 << 2  | Supported               |



**Table 69. Supported capabilities (continued)**

| Capabilities               | Supported/Not supported |
|----------------------------|-------------------------|
| OFPC_GROUP_STATS = 1 << 3  | Not supported           |
| OFPC_IP_REASM = 1 << 5     | Not supported           |
| OFPC_QUEUE_STATS = 1 << 6  | Not supported           |
| OFPC_PORT_BLOCKED = 1 << 8 | Not supported           |

## Multipart message types

**Table 70. Supported message types**

| Message type description            | Request/Reply Body                                                                                                                                                   | Message                   | Support       |
|-------------------------------------|----------------------------------------------------------------------------------------------------------------------------------------------------------------------|---------------------------|---------------|
| Description of this OpenFlow switch | <ul style="list-style-type: none"> <li>The request body is empty</li> <li>The reply body is struct ofp_desc</li> </ul>                                               | OFFPMP_DESC = 0           | Supported     |
| Individual flow statistics          | <ul style="list-style-type: none"> <li>The request body is struct ofp_flow_stats_request</li> <li>The reply body is an array of struct ofp_flow_stats</li> </ul>     | OFFPMP_FLOW = 1           | Supported     |
| Aggregate flow statistics           | <ul style="list-style-type: none"> <li>The request body is struct ofp_aggregate_stats_request</li> <li>The reply body is struct ofp_aggregate_stats_reply</li> </ul> | OFFPMP_AGGREGATE = 2      | Supported     |
| Flow table statistics               | <ul style="list-style-type: none"> <li>The request body is empty</li> <li>The reply body is an array of struct ofp_table_stats</li> </ul>                            | OFFPMP_TABLE = 3          | Supported     |
| Port statistics                     | <ul style="list-style-type: none"> <li>The request body is struct ofp_port_stats_request</li> <li>The reply body is an array of struct ofp_port_stats</li> </ul>     | OFFPMP_PORT_STATS = 4     | Supported     |
| Queue statistics for a port         | <ul style="list-style-type: none"> <li>The request body is struct ofp_queue_stats_request</li> <li>The reply body is an array of struct ofp_queue_stats</li> </ul>   | OFFPMP_QUEUE = 5          | Not supported |
| Group counter statistics            | <ul style="list-style-type: none"> <li>The request body is struct ofp_group_stats_request</li> <li>The reply is an array of struct ofp_group_stats</li> </ul>        | OFFPMP_GROUP = 6          | Not supported |
| Group description                   | <ul style="list-style-type: none"> <li>The request body is empty</li> <li>The reply body is an array of struct ofp_group_desc_stats</li> </ul>                       | OFFPMP_GROUP_DESC = 7     | Not supported |
| Group features                      | <ul style="list-style-type: none"> <li>The request body is empty</li> <li>The reply body is struct ofp_group_features</li> </ul>                                     | OFFPMP_GROUP_FEATURES = 8 | Not supported |

**Table 70. Supported message types (continued)**

| Message type description | Request/Reply Body                                                                                                                                                                                                                                                                                                                        | Message                    | Support       |
|--------------------------|-------------------------------------------------------------------------------------------------------------------------------------------------------------------------------------------------------------------------------------------------------------------------------------------------------------------------------------------|----------------------------|---------------|
| Meter statistics         | <ul style="list-style-type: none"> <li>The request body is struct ofp_meter_multipart_requests</li> <li>The reply body is an array of struct ofp_meter_stats</li> </ul>                                                                                                                                                                   | OFFPMP_METER = 9           | Not supported |
| Meter configuration      | <ul style="list-style-type: none"> <li>The request body is struct ofp_meter_multipart_requests</li> <li>The reply body is an array of struct ofp_meter_config</li> </ul>                                                                                                                                                                  | OFFPMP_METER_CONFIG = 10   | Not supported |
| Meter features           | <ul style="list-style-type: none"> <li>The request body is empty</li> <li>The reply body is struct ofp_meter_features</li> </ul>                                                                                                                                                                                                          | OFFPMP_METER_FEATURES = 11 | Not supported |
| Table features           | <ul style="list-style-type: none"> <li>The request body is empty or contains an array of struct ofp_table_features that includes the controller's desired view of the switch.<br/><br/>If the switch is unable to set the specified view an error is returned</li> <li>The reply body is an array of struct ofp_table_features</li> </ul> | OFFPMP_TABLE_FEATURES = 12 | Supported     |
| Port description         | <ul style="list-style-type: none"> <li>The request body is empty</li> <li>The reply body is an array of struct ofp_port</li> </ul>                                                                                                                                                                                                        | OFFPMP_PORT_DESC = 13      | Supported     |

## Switch description

The OFFPMP\_DESC multipart request type includes information about the switch manufacturer, hardware revision, software revision, serial number, and description.

**Table 71. Supported descriptions**

| Switch description              | Supported/Not supported |
|---------------------------------|-------------------------|
| char mfr_desc[DESC_STR_LEN]     | Supported               |
| char hw_desc[DESC_STR_LEN]      | Supported               |
| char sw_desc[DESC_STR_LEN]      | Supported               |
| char serial_num[SERIAL_NUM_LEN] | Supported               |
| char dp_desc[DESC_STR_LEN]      | Supported               |

## Property type

Table 72. Supported properties

| Property type                    | Supported/Not supported |
|----------------------------------|-------------------------|
| OFPTFPT_INSTRUCTIONS = 0         | Supported               |
| OFPTFPT_INSTRUCTIONS_MISS = 1    | Not supported           |
| OFPTFPT_NEXT_TABLES = 2          | Not supported           |
| OFPTFPT_NEXT_TABLES_MISS = 3     | Not supported           |
| OFPTFPT_WRITE_ACTIONS = 4        | Supported               |
| OFPTFPT_WRITE_ACTIONS_MISS = 5   | Not supported           |
| OFPTFPT_APPLY_ACTIONS = 6        | Supported               |
| OFPTFPT_APPLY_ACTIONS_MISS = 7   | Not supported           |
| OFPTFPT_MATCH = 8                | Supported               |
| OFPTFPT_WILDCARDS = 10           | Supported               |
| OFPTFPT_WRITE_SETFIELD = 12      | Supported               |
| OFPTFPT_WRITE_SETFIELD_MISS = 13 | Not supported           |
| OFPTFPT_APPLY_SETFIELD = 14      | Supported               |
| OFPTFPT_APPLY_SETFIELD_MISS = 15 | Not supported           |

## Group configuration

Table 73. Supported configurations

| Group configuration             | Supported/Not supported |
|---------------------------------|-------------------------|
| OFPGFC_SELECT_WEIGHT = 1 << 0   | Not supported           |
| OFPGFC_SELECT_LIVENESS = 1 << 1 | Not supported           |
| OFPGFC_CHAINING = 1 << 2        | Not supported           |
| OFPGFC_CHAINING_CHECKS = 1 << 3 | Not supported           |

## Controller roles

Table 74. Supported controller roles

| Controller roles        | Supported/Not supported |
|-------------------------|-------------------------|
| OFPCR_ROLE_NOCHANGE = 0 | Not supported           |
| OFPCR_ROLE_EQUAL = 1    | Supported               |
| OFPCR_ROLE_MASTER = 2   | Supported               |
| OFPCR_ROLE_SLAVE = 3    | Not supported           |

## Packet-in reasons

Table 75. Supported reasons

| Packet-in reasons    | Supported/Not supported |
|----------------------|-------------------------|
| OFPR_NO_MATCH = 0    | Supported               |
| OFPR_ACTION = 1      | Supported               |
| OFPR_INVALID_TTL = 2 | Not supported           |

## Flow-removed reasons

Table 76. Supported reasons

| Flow-removed reasons   | Supported/Not supported |
|------------------------|-------------------------|
| OFPRR_IDLE_TIMEOUT = 0 | Supported               |
| OFPRR_HARD_TIMEOUT = 1 | Supported               |
| OFPRR_DELETE = 2       | Supported               |
| OFPRR_GROUP_DELETE = 3 | Not supported           |

## Error types from switch to controller

Table 77. Supported error types

| Error types                      | Supported/Not supported |
|----------------------------------|-------------------------|
| OFPET_HELLO_FAILED = 0           | Supported               |
| OFPET_BAD_REQUEST = 1            | Supported               |
| OFPET_BAD_ACTION = 2             | Supported               |
| OFPET_BAD_INSTRUCTION = 3        | Supported               |
| OFPET_BAD_MATCH = 4              | Supported               |
| OFPET_FLOW_MOD_FAILED = 5        | Supported               |
| OFPET_GROUP_MOD_FAILED = 6       | Not supported           |
| OFPET_PORT_MOD_FAILED = 7        | Supported               |
| OFPET_TABLE_MOD_FAILED = 8       | Not supported           |
| OFPET_QUEUE_OP_FAILED = 9        | Not supported           |
| OFPET_SWITCH_CONFIG_FAILED = 10  | Not supported           |
| OFPET_ROLE_REQUEST_FAILED = 11   | Not supported           |
| OFPET_METER_MOD_FAILED = 12      | Not supported           |
| OFPET_TABLE_FEATURES_FAILED = 13 | Not supported           |

**Table 77. Supported error types (continued)**

| <b>Error types</b>                    | <b>Supported/Not supported</b> |
|---------------------------------------|--------------------------------|
| <b>Bad request code</b>               |                                |
| OFPBRC_BAD_VERSION = 0                | Supported                      |
| OFPBRC_BAD_TYPE = 1                   | Supported                      |
| OFPBRC_BAD_MULTIPART = 2              | Not supported                  |
| OFPBRC_BAD_EXPERIMENTER = 3           | Not supported                  |
| OFPBRC_BAD_EXP_TYPE = 4               | Not supported                  |
| OFPBRC_EPERM = 5                      | Not supported                  |
| OFPBRC_BAD_LEN = 6                    | Supported                      |
| OFPBRC_BUFFER_EMPTY = 7               | Not supported                  |
| OFPBRC_BUFFER_UNKNOWN = 8             | Not supported                  |
| OFPBRC_BAD_TABLE_ID = 9               | Supported                      |
| OFPBRC_IS_SLAVE = 10                  | Not supported                  |
| OFPBRC_BAD_PORT = 11                  | Supported                      |
| OFPBRC_BAD_PACKET = 12                | Not supported                  |
| OFPBRC_MULTIPART_BUFFER_OVERFLOW = 13 | Not supported                  |
| <b>Bad action code</b>                |                                |
| OFPBAC_BAD_TYPE = 0                   | Supported                      |
| OFPBAC_BAD_LEN = 1                    | Supported                      |
| OFPBAC_BAD_EXPERIMENTER = 2           | Not supported                  |
| OFPBAC_BAD_EXP_TYPE = 3               | Not supported                  |
| OFPBAC_BAD_OUT_PORT = 4               | Supported                      |
| OFPBAC_BAD_ARGUMENT = 5               | Supported                      |
| OFPBAC_EPERM = 6                      | Not supported                  |
| OFPBAC_TOO_MANY = 7                   | Supported                      |
| OFPBAC_BAD_QUEUE = 8                  | Not supported                  |
| OFPBAC_BAD_OUT_GROUP = 9              | Not supported                  |
| OFPBAC_MATCH_INCONSISTENT = 10        | Not supported                  |
| OFPBAC_UNSUPPORTED_ORDER = 11         | Not supported                  |
| OFPBAC_BAD_TAG = 12                   | Not supported                  |

**Table 77. Supported error types (continued)**

| <b>Error types</b>                   | <b>Supported/Not supported</b> |
|--------------------------------------|--------------------------------|
| OFPBAC_BAD_SET_TYPE = 13             | Not supported                  |
| OFPBAC_BAD_SET_LEN = 14              | Not supported                  |
| OFPBAC_BAD_SET_ARGUMENT = 15         | Supported                      |
| <b>Bad instruction code</b>          |                                |
| OFPBIC_UNKNOWN_INST = 0              | Not supported                  |
| OFPBIC_UNSUP_INST = 1                | Not supported                  |
| OFPBIC_BAD_TABLE_ID = 2              | Not supported                  |
| OFPBIC_UNSUP_METADATA = 3            | Not supported                  |
| OFPBIC_UNSUP_METADATA_MASK = 4       | Not supported                  |
| OFPBIC_BAD_EXPERIMENTER = 5          | Not supported                  |
| OFPBIC_BAD_EXP_TYPE = 6              | Not supported                  |
| OFPBIC_BAD_LEN = 7                   | Not supported                  |
| OFPBIC_EPERM = 8                     | Not supported                  |
| <b>Bad match code</b>                |                                |
| OFPBMC_BAD_TYPE = 0                  | Not supported                  |
| OFPBMC_BAD_LEN = 1                   | Not supported                  |
| OFPBMC_BAD_TAG = 2                   | Not supported                  |
| OFPBMC_BAD_DL_ADDR_MASK = 3          | Not supported                  |
| OFPBMC_BAD_NW_ADDR_MASK = 4          | Not supported                  |
| OFPBMC_BAD_WILDCARDS = 5             | Not supported                  |
| OFPBMC_BAD_FIELD = 6                 | Not supported                  |
| OFPBMC_BAD_VALUE = 7                 | Not supported                  |
| OFPBMC_BAD_MASK = 8                  | Not supported                  |
| OFPBMC_BAD_PREREQ = 9                | Not supported                  |
| OFPBMC_DUP_FIELD = 10                | Not supported                  |
| OFPBMC_EPERM = 11                    | Not supported                  |
| <b>Flow modification failed code</b> |                                |
| OFPFMFC_UNKNOWN = 0                  | Supported                      |

**Table 77. Supported error types (continued)**

| <b>Error types</b>                    | <b>Supported/Not supported</b> |
|---------------------------------------|--------------------------------|
| OFFPFMFC_TABLE_FULL = 1               | Supported                      |
| OFFPFMFC_BAD_TABLE_ID = 2             | Supported                      |
| OFFPFMFC_OVERLAP = 3                  | Supported                      |
| OFFPFMFC_EPERM = 4                    | Not supported                  |
| OFFPFMFC_BAD_TIMEOUT = 5              | Not supported                  |
| OFFPFMFC_BAD_COMMAND = 6              | Supported                      |
| OFFPFMFC_BAD_FLAGS = 7                | Not supported                  |
| <b>Group modification failed code</b> |                                |
| OFFPGMFC_GROUP_EXISTS = 0             | Not supported                  |
| OFFPGMFC_INVALID_GROUP = 1            | Not supported                  |
| OFFPGMFC_WEIGHT_UNSUPPORTED = 2       | Not supported                  |
| OFFPGMFC_OUT_OF_GROUPS = 3            | Not supported                  |
| OFFPGMFC_OUT_OF_BUCKETS = 4           | Not supported                  |
| OFFPGMFC_CHAINING_UNSUPPORTED = 5     | Not supported                  |
| OFFPGMFC_WATCH_UNSUPPORTED = 6        | Not supported                  |
| OFFPGMFC_LOOP = 7                     | Not supported                  |
| OFFPGMFC_UNKNOWN_GROUP = 8            | Not supported                  |
| OFFPGMFC_CHAINED_GROUP = 9            | Not supported                  |
| OFFPGMFC_BAD_TYPE = 10                | Not supported                  |
| OFFPGMFC_BAD_COMMAND = 11             | Not supported                  |
| OFFPGMFC_BAD_BUCKET = 12              | Not supported                  |
| OFFPGMFC_BAD_WATCH = 13               | Not supported                  |
| OFFPGMFC_EPERM = 14                   | Not supported                  |
| <b>Port modification failed code</b>  |                                |
| OFFPPMFC_BAD_PORT = 0                 | Supported                      |
| OFFPPMFC_BAD_HW_ADDR = 1              | Supported                      |
| OFFPPMFC_BAD_CONFIG = 2               | Not supported                  |
| OFFPPMFC_BAD_ADVERTISE = 3            | Not supported                  |
| OFFPPMFC_EPERM = 4                    | Not supported                  |

**Table 77. Supported error types (continued)**

| Error types                             | Supported/Not supported |
|-----------------------------------------|-------------------------|
| <b>Table modification failed code</b>   |                         |
| OFPTMFC_BAD_TABLE = 0                   | Supported               |
| OFPTMFC_BAD_CONFIG = 1                  | Not supported           |
| OFPTMFC_EPERM = 2                       | Not supported           |
| <b>Queue operation failed code</b>      |                         |
| OFFQOFC_BAD_PORT = 0                    | Supported               |
| OFFQOFC_BAD_QUEUE = 1                   | Not supported           |
| OFFQOFC_EPERM = 2                       | Not supported           |
| <b>Switch configuration failed code</b> |                         |
| OFFSCFC_BAD_FLAGS = 0                   | Not supported           |
| OFFSCFC_BAD_LEN = 1                     | Not supported           |
| OFFSCFC_EPERM = 2                       | Not supported           |
| <b>Role request failed code</b>         |                         |
| OFPRRFC_STALE = 0                       | Not supported           |
| OFPRRFC_UNSUP = 1                       | Not supported           |
| OFPRRFC_BAD_ROLE = 2                    | Not supported           |
| <b>Table features failed code</b>       |                         |
| OFPTFFC_BAD_TABLE = 0                   | Supported               |
| OFPTFFC_BAD_METADATA = 1                | Not supported           |
| OFPTFFC_BAD_TYPE = 2                    | Not supported           |
| OFPTFFC_BAD_LEN = 3                     | Not supported           |
| OFPTFFC_BAD_ARGUMENT = 4                | Not supported           |
| OFPTFFC_EPERM = 5                       | Not supported           |

## OpenFlow use cases

OS10 OpenFlow protocol support allows the flexibility of using vendor-neutral applications and to use applications that you create. For example, the OS10 OpenFlow implementation supports L2 applications similar to the ones found in the following websites:

- <https://github.com/osrg/ryu/tree/master/ryu/app> (only L2 applications are supported)
- <https://github.com/osrg/ryu/tree/master/ryu/app>



 **NOTE:** OS10 supports applications based on OpenFlow versions 1.0 and 1.3.

- **Switching loop removal**

Consider the case of a single broadcast domain where switching loops are common. This issue occurs because of redundant paths in an L2 network.

Switching loops create broadcast storms with broadcasts and multicasts being forwarded out of every switch port. Every switch in the network repeatedly re-broadcasts the messages and floods the entire network.

To solve broadcast storms in an OpenFlow network, a centralized controller makes all the control plane decisions and manages the switches. The controller has the complete view of the topology. MAC address learning is centralized. OpenFlow identifies the correct path and forwards the packets to the relevant switch thereby avoiding switching loops.

- **Reactive flow installation**

Consider the case of dynamic learning of flows for bidirectional traffic. Flows are learnt as and when a packet arrives.

With dynamic learning in an OpenFlow network, the OpenFlow switch receives a packet that does not match the flow table entries and sends the packet to the SDN controller to process it. The controller identifies the path the packet has to traverse and updates the flow table with a new entry. The controller also decides the caching time of the flow table entries.

## Configure OpenFlow

When you convert the switch from Normal mode to OpenFlow mode, the switch retains the management, interface, and AAA settings.

 **NOTE:** Ensure IP connectivity between the switch and the controller.

The following lists the minimum configuration you need to establish a connection between the OpenFlow controller and a logical switch instance:

1. Enter the OPENFLOW configuration mode.

```
OS10# configure terminal
OS10 (config)# openflow
OS10 (config-openflow)#
```

2. Enable the OpenFlow-only mode.

```
OS10 (config-openflow)# mode openflow-only
```

Reload the switch. Enter *yes* to enable OpenFlow-only mode.

 **NOTE:** When the switch starts up in OpenFlow mode, it disables all Layer 2 (L2) and Layer 3 (L3) protocols. Many CLI commands are not available in OpenFlow-only mode. For a list of available commands in OpenFlow-only mode, see [OpenFlow-only mode commands](#).

3. Configure a logical switch instance.

- a. Option 1; for Out of Band (OOB) management:

- i. Configure an IP address for the management port. Ensure that there is IP connectivity between the switch and the controller.

```
OS10# configure terminal
OS10 (config)# interface management 1/1/1
OS10 (conf-if-ma-1/1/1)# ip address 11.1.1.1/24
OS10 (conf-if-ma-1/1/1)# no shutdown
OS10 (conf-if-ma-1/1/1)# exit
```

- ii. Configure the logical switch instance, *of-switch-1*.

```
OS10# configure terminal
OS10 (config)# openflow
OS10 (config-openflow)# switch of-switch-1
```

- b. Option 2; for in-band management:

- i. Configure one of the front-panel ports as the management port.

```
OS10# configure terminal
OS10 (config)# openflow
OS10 (config-openflow)# in-band-mgmt interface ethernet 1/1/1
OS10 (config-openflow)#
```

- ii. Configure an IPv4 address on the front-panel management port.

```
OS10# configure terminal
OS10 (config)# interface ethernet 1/1/1
OS10 (conf-if-eth1/1/1)# ip address 11.1.1.1/24
OS10 (conf-if-eth1/1/1)# no shutdown
```

- iii. Configure the logical switch instance, *of-switch-1*.

```
OS10# configure terminal
OS10 (config)# openflow
OS10 (config-openflow)# switch of-switch-1
```

4. Configure one or more OpenFlow controllers with either IPv4 or IPv6 addresses to establish a connection with the logical switch instance. You can configure up to eight OpenFlow controllers.

```
OS10 (config-openflow-switch)# controller ipv4 ip-address port port-id
OS10 (config-openflow-switch)# controller ipv6 ipv6-address port port-id
```

```
OS10 (config-openflow-switch)# controller ipv4 10.1.1.1 port 6633
OS10 (config-openflow-switch)# controller ipv4 10.1.1.8 port 6633
OS10 (config-openflow-switch)# controller ipv4 10.1.1.12 port 6633
OS10 (config-openflow-switch)# controller ipv4 10.1.2.17 port 6633
OS10 (config-openflow-switch)# controller ipv4 10.1.23.12 port 6633
OS10 (config-openflow-switch)# controller ipv4 10.1.99.121 port 6633
OS10 (config-openflow-switch)# controller ipv6 2025::1 port 6633
OS10 (config-openflow-switch)# controller ipv6 2025::12 port 6633
```

where IP or IPv6 address is of the controller and port 6633 is for OpenFlow communication.

5. Enter the `no shutdown` command to enable the logical switch instance.

```
OS10 (config-openflow-switch) no shutdown
```

## Establish TLS connection

- Generate the switch and controller certificates from a server that supports public-key infrastructure (PKI). You need the following certificates:
  - Controller certificate
  - Switch certificate
  - Private key file to verify the switch certificate
- The certificates and private key files must be in the Privacy-Enhanced Mail (PEM) format.

For certificate-based authentication, you must establish a TLS connection between the switch and the controller before you configure OpenFlow on the switch. The following procedure explains how to install the controller and switch certificates on the OS10 switch. Refer to the controller documentation for information on how to install the certificates on the controller.

**i** **NOTE:** This procedure is optional. Use this procedure if you want to configure certificate-based authentication between the switch and the controller.

1. Log in to the OS10 switch with administrator credentials.
2. Enter the following command to copy the certificates to the OS10 switch.

In the following commands, the destination path and the destination file name on the OS10 switch, for example, `config://../openflow/cacert.pem`, remain the same in your deployment. Ensure that you enter the destination path and destination file names as specified in the following example:

```
OS10# copy scp://username:password@server-ip/full-path-to-the-certificates/controller-
```

```
cert.pem config://../openflow/cacert.pem
OS10# copy scp://username:password@server-ip/full-path-to-the-certificates/switch-
cert.pem config://../openflow/sc-cert.pem
OS10# copy scp://username:password@server-ip/full-path-to-the-certificates/switch-
privkey.pem config://../openflow/sc-privkey.pem
```

where *server-ip* refers to the server where you have stored the certificates, and *username* and *password* refers to the credentials you need to access the server with the certificates.

3. Perform the steps described in the [Configure OpenFlow protocol on the switch](#) topic to configure OpenFlow.

## OpenFlow commands

### controller

Configures an OpenFlow controller that the logical switch instance connects to.

**Syntax** `controller {ipv4 ipv4-address| ipv6 ipv6-address [port port-number] [security {none|tls}]}`

- Parameters**
- `ipv4 ipv4-address`—Enter `ipv4`, then the IP address of the controller.
  - `ipv6 ipv6-address`—Enter `ipv6`, then the IPv6 address of the controller.
  - `port port-number`—Enter the keyword, then the port number, from 1 to 65,535. The default port is 6653.
  - `security {none|tls}`—Specify the type of connection. The default is `security none`. The TCP connection is used.

**Default** TCP. The default port number is 6653.

**Command Mode** OPENFLOW SWITCH CONFIGURATION

**Usage Information** You can configure up to eight OpenFlow controllers.

If you specify the `security tls` option, the OpenFlow application looks for the following certificates and private key in the following locations specified for certificate-based authentication. For information about obtaining certificates and installing them on the switch and the controller, see [Establish TLS connection between the switch and the controller](#).

|                                                                                      |                                                                |
|--------------------------------------------------------------------------------------|----------------------------------------------------------------|
| <b>ca_cert<br/>(certificate that identifies the controller as being trustworthy)</b> | <code>/config/etc/opt/dell/os10/openflow/cacert.pem</code>     |
| <b>certificate<br/>(certificate that identifies the switch as being trustworthy)</b> | <code>/config/etc/opt/dell/os10/openflow/sc-cert.pem</code>    |
| <b>private key (the private key corresponding to the switch certificate)</b>         | <code>/config/etc/opt/dell/os10/openflow/sc-privkey.pem</code> |

**Example** The following example configures an OpenFlow controller with IP address 10.11.63.56 on port 6633 for the logical switch instance, of-switch-1:

```
OS10# configure terminal
OS10 (config)# openflow
OS10 (config-openflow)# switch of-switch-1
```

```
OS10 (config-openflow-switch)# controller ipv4 10.11.63.56 port 6633
OS10 (config-openflow-switch)#
```

The following example configures multiple OpenFlow controllers on port 6633 for the logical switch instance, of-switch-1:

```
OS10# configure terminal
OS10 (config)# openflow
OS10 (config-openflow)# switch of-switch-1
OS10 (config-openflow-switch)# controller ipv4 10.1.1.1 port 6633
OS10 (config-openflow-switch)# controller ipv4 10.1.1.8 port 6633
OS10 (config-openflow-switch)# controller ipv4 10.1.1.12 port 6633
OS10 (config-openflow-switch)# controller ipv4 10.1.2.17 port 6633
OS10 (config-openflow-switch)# controller ipv4 10.1.23.12 port 6633
OS10 (config-openflow-switch)# controller ipv4 10.1.99.121 port 6633
OS10 (config-openflow-switch)# controller ipv6 2025::1 port 6633
OS10 (config-openflow-switch)# controller ipv6 2025::12 port 6633
```

**Supported Releases** 10.4.1.0 or later

## dpid-mac-address

Specifies the MAC address bits of the datapath ID (DPID) of the logical switch instance.

**Syntax** `dpid-mac-address MAC-address`

**Parameters** `MAC-address`—48-bit MAC address in hexadecimal notation, nn:nn:nn:nn:nn:nn

**Default** MAC address

**Command Mode** OPENFLOW SWITCH CONFIGURATION

**Usage Information** The controller uses the DPID to identify the logical switch instance. The DPID is a 64-bit number that is sent to the controller in the `features_reply` message. The DPID is constructed from the instance ID, which is the most significant 16 bits (default to 0) and the DPID-MAC-ADDRESS, which is the least significant 48 bits. OS10 currently supports only one logical switch instance and the instance ID is automatically set to 0. This value is not configurable.

You can use this command to modify the MAC address bits of the DPID.

**Example** DPID MAC address is 00:00:00:00:00:0a.

```
OS10 (config)# openflow
OS10 (config-openflow)# switch of-switch-1
OS10 (config-openflow-switch)# dpid-mac-address 00:00:00:00:00:0a
OS10 (config-openflow-switch)#
```

**Supported Releases** 10.4.1.0 or later

## in-band-mgmt

Configures the front-panel ports as the management interface that the SDN controller connects to.

**Syntax** `in-band-mgmt interface ethernet node/slot/port[:subport]`

**Parameters** `node/slot/port[:subport]`—Enter the physical port information.

**Default** None

**Command Mode** OPENFLOW CONFIGURATION

**Usage Information**

Use this command to convert any one of the front-panel ports as the management interface. This port is not part of the OpenFlow logical switch instance. All the ports are L2 ports by default. If you configure one of the front-panel ports as the management interface, the port becomes an L3 port. You can configure an L3 IPv4 address only to the front-panel port that you have specified in this command. Ensure that you have IP connectivity between the specified port and the controller.

The `no` form of this command removes this configuration and the front-panel port becomes part of the OpenFlow logical switch instance.

**Example**

```
OS10# configure terminal
OS10(config)# openflow
OS10 (config-openflow)# in-band-mgmt interface ethernet 1/1/1
OS10 (config-openflow)# no shutdown
```

**Supported Releases**

10.4.1.0 or later

## max-backoff

Configures the time interval, in seconds, that the logical switch instance waits after requesting a connection with the OpenFlow controller.

**Syntax**

```
max-backoff interval
```

**Parameters**

*interval*—Enter the amount of time, in seconds, that the logical switch instance waits after it attempts to establish a connection with the OpenFlow controller, from 1 to 65,535.

**Default**

8 seconds

**Command Mode**

OPENFLOW SWITCH CONFIGURATION

**Usage Information**

If the interval time lapses, the logical switch instance re-attempts to establish a connection with the OpenFlow controller.

**Example**

```
OS10 (config)# openflow
OS10 (config-openflow)# switch of-switch-1
OS10 (config-openflow-switch)# max-backoff 25
OS10 (config-openflow-switch)#
```

**Supported Releases**

10.4.1.0 or later

## mode openflow-only

Enables OpenFlow-only mode on the switch.

**Syntax**

```
mode openflow-only
```

**Parameters**

None

**Default**

None

**Command Mode**

OPENFLOW CONFIGURATION

**Usage Information**

Use this command to enable OpenFlow-only mode. This command reloads the switch and boots to OpenFlow-only mode. This command deletes all L2 and L3 configurations. However, the system management and AAA configurations are retained.

The `no` form of this command prompts you to reload the switch. If you enter `yes`, the switch deletes all OpenFlow configurations, including the controller IP, port, certificates, and reloads, then returns to the Normal mode.

**NOTE:** For a list of available commands when the switch is in the OpenFlow-only mode, see [CLI commands available in the OpenFlow-only mode](#).

#### Example

```
OS10 (config-openflow)# mode openflow-only
OS10 (config-openflow)#
```

**Supported Releases** 10.4.1.0 or later

## openflow

Enters OPENFLOW configuration mode.

**Syntax** `openflow`

**Parameters** None

**Default** None

**Command Mode** CONFIGURATION

**Usage Information** All OpenFlow configurations are performed in this mode.

The `no` form of this command prompts a switch reload. If you enter `yes`, the system deletes all OpenFlow configurations and the switch returns to the normal mode after the reload.

#### Example

```
OS10# configure terminal
OS10(config)# openflow
OS10 (config-openflow)#
```

**Supported Releases** 10.4.1.0 or later

## probe-interval

Configures the echo request interval, in seconds, for the controller configured with the logical switch instance.

**Syntax** `probe-interval interval`

**Parameters** `interval`—Enter the amount of time, in seconds, between the `keepalive` messages, also known as echo requests, from 1 to 65,535.

**Default** 5 seconds

**Command Mode** OPENFLOW SWITCH CONFIGURATION

**Usage Information** None

#### Example

```
OS10 (config)# openflow
OS10 (config-openflow)# switch of-switch-1
OS10 (config-openflow-switch)# probe-interval 20
OS10 (config-openflow-switch)#
```

**Supported Releases** 10.4.1.0 or later

## protocol-version

Specifies protocol version the logical switch interface uses.

**Syntax** `protocol-version version`

**Parameters** `version`—Choose from one of the following:

- `negotiate`—Enter the keyword to negotiate versions 1.0 or 1.3 with the controller. The highest of the supported versions is selected.
- `1.0`—Specify the logical switch instance OpenFlow protocol version as 1.0.
- `1.3`—Specify the logical switch instance OpenFlow protocol version as 1.3.

**Default** `negotiate`

**Command Mode** OPENFLOW SWITCH CONFIGURATION

**Usage Information**

**NOTE:** Only use this command should be run when the logical switch instance is disabled. Use the `shutdown` command to disable the logical switch instance. After you run this command, enter the `no shutdown` command to enable the logical switch instance again.

- When you specify, `negotiate`, the switch negotiates versions 1.0 and 1.3 and selects the highest of the versions supported by the controller. The negotiation is based on the hello handshake described in the OpenFlow Specification 1.3.
- When you specify, `1.0`, the switch establishes a connection with the controller that supports version 1.0 only.
- When you specify, `1.3`, the switch establishes a connection with the controller that supports version 1.3 only.

**Example**

The following example shows a logical switch instance, `of-switch-1`, configured to interact with controllers that support the OpenFlow protocol version 1.3.

```
OS10 (config)# openflow
OS10 (config-openflow)# switch of-switch-1
OS10 (config-openflow-switch)# shutdown
OS10 (config-openflow-switch)# protocol-version 1.3
OS10 (config-openflow-switch)# no shutdown
OS10 (config-openflow-switch)#
```

**Supported Releases** 10.4.1.0 or later

## rate-limit packet\_in

Configures the maximum packet rate for the controller connection, and the maximum packets permitted in a burst sent to the controller in a second.

**Syntax** `rate-limit packet_in controller-packet-rate [burst maximum-packets-to-controller]`

**Parameters**

- `controller-packet-rate`—Rate in packets per second for the controller OpenFlow channel connection, from 100 to 268000000 seconds. The default is 0 seconds, disabled.
- `maximum-packets-to-controller`—Burst in packets for the controller OpenFlow channel connection, from 25 to 1073000. The default is 0 seconds, disabled. This parameter is optional. It is set to 25% of the configured rate value, if not configured.

**Default** Disabled

**Command Mode** OPENFLOW SWITCH CONFIGURATION

**Usage Information**

OpenFlow sets the specified rate and burst for the controller's connection with the logical switch instance. The actual rate and burst on the controller has a maximum of two times the configured values.

For example, when you configure a rate of 1000 PPS and a burst of 300 packet bursts per second, the packets can egress on the connection at rates of up to 2000 PPS and 600 packet bursts per second.

The `no` form of this command disables rate limiting on the controller connection.

**NOTE:** This command is a software rate limiting command and applies only to the OpenFlow channel connection between the controller and the logical switch instance. This command is not related to the switch's data-plane rate limits.

### Example

The following example configures a logical switch instance, `of-switch-1`, with an OpenFlow controller at a rate of 1000 PPS and packet bursts of 300 packets.

```
OS10 (config)# openflow
OS10 (config-openflow)# switch of-switch-1
OS10 (config-openflow-switch)# controller ipv4 10.11.63.56 port 6633
OS10 (config-openflow-switch)# rate-limit packet_in 1000 burst 300
OS10 (config-openflow-switch)#
```

### Supported Releases

10.4.1.0 or later

## show openflow

Displays general OpenFlow switch and the logical switch instance information.

**Syntax** show openflow

**Parameters** None

**Default** None

**Command Mode** EXEC

**Usage Information** None

### Example

```
OS10# show openflow

Manufacturer : DELL
Hardware Description :
Software Description : Dell Networking OS10-Premium, Dell
Networking Application Software Version: 10.4.9999EX
Serial Number :
Capabilities : port, table, flow
Switch mode : openflow-only
Match fields :
 Layer-1 : in-port
 Layer-2 : eth-src, eth-dst, eth-type, vlan-id, vlan-pcp
 Layer-3 : ipv4-src, ipv4-dst, ip-protocol, ip-dscp, ip-ecn
 Layer-4 : tcp-src, tcp-dst, udp-src, udp-dst, icmpv4-type, icmpv4-
code
Instructions : apply-actions, write-actions
Actions : output, set-field
Set field actions : eth-src, eth-dst, vlan-id, vlan-pcp, ip-
dscp
TLS parameters :
 certificate identifying trustworthy controller : /config/etc/opt/
dell/os10/openflow/cacert.pem
 certificate identifying trustworthy switch : /config/etc/opt/
dell/os10/openflow/sc-cert.pem
 private key : /config/etc/opt/
dell/os10/openflow/sc-privkey.pem
```

### Supported Releases

10.4.1.0 or later



## show openflow flows

Displays OpenFlow flows for a specific logical switch instance.

- Syntax** `show openflow switch logical-switch-name flows`
- Parameters** `logical-switch-name`—Enter the logical switch instance name to view flow information.
- Default** None
- Command Mode** EXEC
- Usage Information** None
- Example**

```
OS10# show openflow switch of-switch-1 flows
Logical switch name: of-switch-1
Total flows: 1
Flow: 0
 Table ID: 0, Table: Ingress ACL TCAM table
 Flow ID: 0
 Priority: 32768, Cookie: 0
 Hard Timeout: 0, Idle Timeout: 0
 Packets: 0, Bytes: 0
 Match Parameters:
 In Port: ethernet1/1/1
 EType: 0x800
 SMAC: 00:0b:c4:a8:22:b0/ff:ff:ff:ff:ff:ff
 DMAC: 00:0b:c4:a8:22:b1/ff:ff:ff:ff:ff:ff
 VLAN id: 2/4095
 VLAN PCP: 1
 IP DSCP: 4
 IP ECN: 1
 IP Proto: 1
 Src Ip: 10.0.0.1/255.255.255.255
 Dst Ip: 20.0.0.1/255.255.255.255
 ICMPv4 Type: 1
 ICMPv4 Code: 10
 L4 Src Port: *
 L4 Dst Port: *
 Apply-Actions: Output= ethernet1/1/2, ethernet1/1/3:1
 Write-Actions: Drop
```

**Supported Releases** 10.4.1.0 or later

## show openflow ports

Displays the OpenFlow ports for a specific logical switch instance.

- Syntax** `show openflow switch logical-switch-name ports`
- Parameters** `logical-switch-name`—Enter the name of the logical switch instance to view port information.
- Default** None
- Command Mode** EXEC
- Usage Information** None
- Example**

```
OS10# show openflow switch of-switch-1 ports
Logical switch name: of-switch-1
Interface Name of-port ID Config-State Link-State SPEED DUPLEX
AUTONEG TYPE
ethernet1/1/1 1 PORT_UP(CLI) LINK_UP 40GB FD
```

|                 |        |     |               |           |      |    |
|-----------------|--------|-----|---------------|-----------|------|----|
| YES             | COPPER |     |               |           |      |    |
| ethernet1/1/2   |        | 5   | PORT_UP (CLI) | LINK_UP   | 40GB | FD |
| YES             | COPPER |     |               |           |      |    |
| ethernet1/1/3:1 |        | 9   | PORT_UP (CLI) | LINK_UP   | 10GB | FD |
| NO              | FIBER  |     |               |           |      |    |
| ethernet1/1/3:2 |        | 10  | PORT_UP (CLI) | LINK_DOWN | 0MB  | FD |
| NO              | FIBER  |     |               |           |      |    |
| ethernet1/1/3:3 |        | 11  | PORT_UP (CLI) | LINK_DOWN | 0MB  | FD |
| NO              | FIBER  |     |               |           |      |    |
| ethernet1/1/3:4 |        | 12  | PORT_UP (CLI) | LINK_DOWN | 0MB  | FD |
| NO              | FIBER  |     |               |           |      |    |
| ethernet1/1/4   |        | 13  | PORT_UP (CLI) | LINK_UP   | 40GB | FD |
| YES             | COPPER |     |               |           |      |    |
| ethernet1/1/5:1 |        | 17  | PORT_UP (CLI) | LINK_UP   | 10GB | FD |
| NO              | FIBER  |     |               |           |      |    |
| ethernet1/1/5:2 |        | 18  | PORT_UP (CLI) | LINK_DOWN | 0MB  | FD |
| NO              | FIBER  |     |               |           |      |    |
| ethernet1/1/5:3 |        | 19  | PORT_UP (CLI) | LINK_DOWN | 0MB  | FD |
| NO              | FIBER  |     |               |           |      |    |
| ethernet1/1/5:4 |        | 20  | PORT_UP (CLI) | LINK_DOWN | 0MB  | FD |
| NO              | FIBER  |     |               |           |      |    |
| ethernet1/1/6   |        | 21  | PORT_UP (CLI) | LINK_DOWN | 0MB  | FD |
| NO              | NONE   |     |               |           |      |    |
| ethernet1/1/7   |        | 25  | PORT_UP (CLI) | LINK_DOWN | 0MB  | FD |
| NO              | NONE   |     |               |           |      |    |
| ethernet1/1/8   |        | 29  | PORT_UP (CLI) | LINK_DOWN | 0MB  | FD |
| YES             | COPPER |     |               |           |      |    |
| ethernet1/1/9   |        | 33  | PORT_UP (CLI) | LINK_DOWN | 0MB  | FD |
| NO              | NONE   |     |               |           |      |    |
| ethernet1/1/10  |        | 37  | PORT_UP (CLI) | LINK_DOWN | 0MB  | FD |
| NO              | NONE   |     |               |           |      |    |
| ethernet1/1/11  |        | 41  | PORT_UP (CLI) | LINK_UP   | 40GB | FD |
| YES             | COPPER |     |               |           |      |    |
| ethernet1/1/12  |        | 45  | PORT_UP (CLI) | LINK_UP   | 40GB | FD |
| YES             | COPPER |     |               |           |      |    |
| ethernet1/1/13  |        | 49  | PORT_UP (CLI) | LINK_DOWN | 0MB  | FD |
| NO              | NONE   |     |               |           |      |    |
| ethernet1/1/14  |        | 53  | PORT_UP (CLI) | LINK_DOWN | 0MB  | FD |
| NO              | NONE   |     |               |           |      |    |
| ethernet1/1/15  |        | 57  | PORT_UP (CLI) | LINK_DOWN | 0MB  | FD |
| NO              | NONE   |     |               |           |      |    |
| ethernet1/1/16  |        | 61  | PORT_UP (CLI) | LINK_DOWN | 0MB  | FD |
| NO              | NONE   |     |               |           |      |    |
| ethernet1/1/17  |        | 65  | PORT_UP (CLI) | LINK_DOWN | 0MB  | FD |
| NO              | NONE   |     |               |           |      |    |
| ethernet1/1/18  |        | 69  | PORT_UP (CLI) | LINK_DOWN | 0MB  | FD |
| NO              | NONE   |     |               |           |      |    |
| ethernet1/1/19  |        | 73  | PORT_UP (CLI) | LINK_DOWN | 0MB  | FD |
| NO              | NONE   |     |               |           |      |    |
| ethernet1/1/20  |        | 77  | PORT_UP (CLI) | LINK_DOWN | 0MB  | FD |
| NO              | NONE   |     |               |           |      |    |
| ethernet1/1/21  |        | 81  | PORT_UP (CLI) | LINK_DOWN | 0MB  | FD |
| NO              | NONE   |     |               |           |      |    |
| ethernet1/1/22  |        | 85  | PORT_UP (CLI) | LINK_DOWN | 0MB  | FD |
| NO              | NONE   |     |               |           |      |    |
| ethernet1/1/23  |        | 89  | PORT_UP (CLI) | LINK_DOWN | 0MB  | FD |
| NO              | NONE   |     |               |           |      |    |
| ethernet1/1/24  |        | 93  | PORT_UP (CLI) | LINK_DOWN | 0MB  | FD |
| NO              | NONE   |     |               |           |      |    |
| ethernet1/1/25  |        | 97  | PORT_UP (CLI) | LINK_DOWN | 0MB  | FD |
| NO              | COPPER |     |               |           |      |    |
| ethernet1/1/26  |        | 101 | PORT_UP (CLI) | LINK_DOWN | 0MB  | FD |
| NO              | COPPER |     |               |           |      |    |
| ethernet1/1/27  |        | 105 | PORT_UP (CLI) | LINK_DOWN | 0MB  | FD |
| NO              | NONE   |     |               |           |      |    |
| ethernet1/1/28  |        | 109 | PORT_UP (CLI) | LINK_DOWN | 0MB  | FD |
| NO              | NONE   |     |               |           |      |    |
| ethernet1/1/29  |        | 113 | PORT_UP (CLI) | LINK_DOWN | 0MB  | FD |
| NO              | NONE   |     |               |           |      |    |
| ethernet1/1/30  |        | 117 | PORT_UP (CLI) | LINK_DOWN | 0MB  | FD |
| NO              | NONE   |     |               |           |      |    |
| ethernet1/1/31  |        | 121 | PORT_UP (CLI) | LINK_DOWN | 0MB  | FD |

|                |      |     |               |           |     |    |  |
|----------------|------|-----|---------------|-----------|-----|----|--|
| NO             | NONE |     |               |           |     |    |  |
| ethernet1/1/32 |      | 125 | PORT_UP (CLI) | LINK_DOWN | OMB | FD |  |
| NO             | NONE |     |               |           |     |    |  |

**Supported Releases** 10.4.1.0 or later

## show openflow switch

Displays OpenFlow parameters for the switch instance.

**Syntax** show openflow switch

**Parameters** None

**Default** None

**Command Mode** EXEC

**Usage Information** None

### Example

```
OS10# show openflow switch
Logical switch name: of-switch-1
Internal switch instance ID: 0
Config state: true
Signal Version: negotiate
Data plane: secure
Max backoff (sec): 8
Probe Interval (sec): 5
DPID: 90:b1:1c:f4:a5:23
Switch Name : of-switch-1
Number of buffers: 0
Number of tables: 1
 Table ID: 0
 Table name: Ingress ACL TCAM table
 Max entries: 1000
 Active entries: 0
 Lookup count: 0
 Matched count: 0
Controllers:
 10.16.208.150:6633, Protocol: none,
 packet-in Rate limit (packet per second): 0
 packet-in Burst limit: 0
```

**Supported Releases** 10.4.1.0 or later

## show openflow switch controllers

Displays OpenFlow controllers for a specific logical switch instance.

**Syntax** show openflow switch *logical-switch-name* controllers

**Parameters** *logical-switch-name*—Enter the name of the logical switch instance to query.

**Default** None

**Command Mode** EXEC

**Usage Information** This command displays information for all active OpenFlow controllers.

## Example

```
OS10# show openflow switch ice controllers
Logical switch name: ice
Total Controllers: 2
 Controller: 1
 Target: 10.16.132.59:6653
 Protocol: TCP
 Connected: YES
 Role: Master
 Last_error: Connection timed out
 State: ACTIVE
 sec_since_disconnect: 0
 Controller: 2
 Target: [2001::2]:6653
 Protocol: TCP
 Connected: YES
 Role: Equal
 Last_error: Connection timed out
 State: ACTIVE
 sec_since_disconnect: 0
```

## Supported Releases

10.4.1.0 or later

# switch

Creates a logical switch instance or modifies an existing logical switch instance.

**Syntax** `switch logical-switch-name`

**Parameters** `logical-switch-name`—Enter the name of the logical switch instance that you want to create or modify, a maximum of 15 characters. OS10 supports only one instance of the logical switch.

**Default** None

**Command Mode** OPENFLOW CONFIGURATION

**Usage Information** You must configure a controller for the logical switch instance. The logical switch instance is disabled by default. To establish a connection with the controller, enable the logical switch instance using the `no shutdown` command. All physical and logical interfaces in the switch are assigned to the configured logical switch.

The `no` form of this command removes the logical switch instance.

 **NOTE:** OS10 supports only one instance of the logical switch. If you attempt to create a second logical switch instance, the following message appears:

```
% Warning: Only one Switch instance is supported
```

## Example

```
OS10# config terminal
OS10 (config)# openflow
OS10 (config-openflow)# switch of-switch-1
OS10 (config-openflow-switch)# no shutdown
```

## Supported Releases

10.4.1.0 or later

# OpenFlow-only mode commands

When you configure the switch to OpenFlow-only mode, only the following commands are available; all other commands are disabled.

 **NOTE:**

- The `ntp` subcommand under the `interface` command is not applicable when the switch is in OpenFlow mode.
- The `ip` and `ipv6` subcommands under the `interface` command are applicable only when you configure the interface as the management port using the `in-band-mgmt` command.
- The `ip` and `ipv6` commands must be used only in In-Band mode (using the `in-band-mgmt` command).

**Table 78. Modes and CLI commands**

| Mode          | Available CLI commands                                                                                                           |
|---------------|----------------------------------------------------------------------------------------------------------------------------------|
| CONFIGURATION | aaa                                                                                                                              |
|               | alias                                                                                                                            |
|               | banner                                                                                                                           |
|               | class-map                                                                                                                        |
|               | clock                                                                                                                            |
|               | control-plane                                                                                                                    |
|               | crypto                                                                                                                           |
|               | end                                                                                                                              |
|               | eula-consent                                                                                                                     |
|               | exec-timeout                                                                                                                     |
|               | exit                                                                                                                             |
|               | feature                                                                                                                          |
|               | help                                                                                                                             |
|               | host-description                                                                                                                 |
|               | hostname                                                                                                                         |
|               | interface                                                                                                                        |
|               | ip <ul style="list-style-type: none"> <li>• ip access-list</li> <li>• ip route</li> <li>• ip ssh</li> <li>• ip telnet</li> </ul> |
|               | ipv6 <ul style="list-style-type: none"> <li>• ip access-list</li> </ul>                                                          |
|               | line                                                                                                                             |
|               | logging                                                                                                                          |
|               | login                                                                                                                            |
|               | management                                                                                                                       |
|               | no                                                                                                                               |
|               | ntp                                                                                                                              |
|               | openflow                                                                                                                         |
|               | password-attributes                                                                                                              |
|               | policy-map                                                                                                                       |
| radius-server |                                                                                                                                  |
| rest          |                                                                                                                                  |

**Table 78. Modes and CLI commands (continued)**

| Mode                             | Available CLI commands                                                                                                                                                           |
|----------------------------------|----------------------------------------------------------------------------------------------------------------------------------------------------------------------------------|
|                                  | scale-profile<br>support-assist<br>system<br>tacacs-server<br>trust<br>username<br>userrole                                                                                      |
| EXEC                             | All commands<br>The following debug commands are not available: <ul style="list-style-type: none"> <li>• debug iscsi</li> <li>• debug radius</li> <li>• debug tacacs+</li> </ul> |
| LAG INTERFACE CONFIGURATION      | LAG is not supported.                                                                                                                                                            |
| LOOPBACK INTERFACE CONFIGURATION | Loopback interface is not supported.                                                                                                                                             |
| INTERFACE CONFIGURATION          | description<br>end<br>exit<br>ip<br>mtu<br>negotiation<br>ntp<br>show<br>shutdown                                                                                                |
| VLAN INTERFACE CONFIGURATION     | VLAN is not supported.                                                                                                                                                           |

# Access Control Lists

OS10 uses two types of access policies — hardware-based ACLs and software-based route-maps. Use an ACL to filter traffic and drop or forward matching packets. To redistribute routes that match configured criteria, use a route-map.

## ACLs

ACLs are a filter containing criterion to match; for example, examine internet protocol (IP), transmission control protocol (TCP), or user datagram protocol (UDP) packets, and an action to take such as forwarding or dropping packets at the NPU. ACLs permit or deny traffic based on MAC and/or IP addresses. The number of ACL entries is hardware-dependent.

ACLs have only two actions — forward or drop. Route-maps not only permit or block redistributed routes but also modify information associated with the route when it is redistributed into another protocol. When a packet matches a filter, the device drops or forwards the packet based on the filter's specified action. If the packet does not match any of the filters in the ACL, the packet drops, an implicit deny. ACL rules do not consume hardware resources until you apply the ACL to an interface.

ACLs process in sequence. If a packet does not match the criterion in the first filter, the second filter applies. If you configure multiple hardware-based ACLs, filter rules apply on the packet content based on the priority numeric processing unit (NPU) rule.

## Route maps

Route-maps are software-based protocol filtering redistributing routes from one protocol to another and used in decision criterion in route advertisements. A route-map defines which of the routes from the specified routing protocol redistributes into the target routing process, see [Route-maps](#).

Route-maps which have more than one match criterion, two or more matches within the same route-map sequence, have different match commands. Matching a packet against this criterion is an AND operation. If no match is found in a route-map sequence, the process moves to the next route-map sequence until a match is found, or until there are no more sequences. When a match is found, the packet forwards and no additional route-map sequences process. If you include a continue clause in the route-map sequence, the next route-map sequence also processes after a match is found.

## IP ACLs

An ACL filters packets based on the:

- IP protocol number
- Source and destination IP address
- Source and destination TCP port number
- Source and destination UDP port number

For ACL, TCP, and UDP filters, match criteria on specific TCP or UDP ports. For ACL TCP filters, you can also match criteria on established TCP sessions.

When creating an ACL, the sequence of the filters is important. You can assign sequence numbers to the filters as you enter them or OS10 can assign numbers in the order you create the filters. The sequence numbers display in the `show running-configuration` and `show ip access-lists [in | out]` command output.

Ingress and egress hot-lock ACLs allow you to append or delete new rules into an existing ACL without disrupting traffic flow. Existing entries in the content-addressable memory (CAM) shuffle to accommodate the new entries. Hot-lock ACLs are enabled by default and support ACLs on all platforms.

 **NOTE:** Hot-lock ACLs support ingress ACLs only.

## MAC ACLs

MAC ACLs filter traffic on the header of a packet. This traffic filtering is based on:

|                                  |                                                                                                                                         |
|----------------------------------|-----------------------------------------------------------------------------------------------------------------------------------------|
| <b>Source MAC packet address</b> | MAC address range—address mask in 3x4 dotted hexadecimal notation, and <i>any</i> to denote that the rule matches all source addresses. |
|----------------------------------|-----------------------------------------------------------------------------------------------------------------------------------------|

|                                       |                                                                                                                                              |
|---------------------------------------|----------------------------------------------------------------------------------------------------------------------------------------------|
| <b>Destination MAC packet address</b> | MAC address range—address-mask in 3x4 dotted hexadecimal notation, and <i>any</i> to denote that the rule matches all destination addresses. |
| <b>Packet protocol</b>                | Set by its <code>EtherType</code> field contents and assigned protocol number for all protocols.                                             |
| <b>VLAN ID</b>                        | Set in the packet header                                                                                                                     |
| <b>Class of service</b>               | Present in the packet header                                                                                                                 |

IPv4/IPv6 and MAC ACLs apply separately for inbound and outbound packets. You can assign an interface to multiple ACLs, with a limit of one ACL per packet direction per ACL type.

## Control-plane ACLs

OS10 offers control-plane ACLs to selectively restrict packets that are destined to the CPU port, thereby providing increased security. Control-plane ACLs offer:

- An option to protect the CPU from denial of service (DoS) attacks.
- Fine-grained control to allow or block traffic going to the CPU.

Control-plane ACLs apply on the front-panel and management ports. Control-plane ACLs are one of the following types:

- IP ACL
- IPv6 ACL
- MAC ACL

 **NOTE:** MAC ACL is applied only on packets that enter through the front-panel ports.

There is no implicit deny rule. If none of the configured conditions match, the default behavior is to permit. If you need to deny traffic that does not match any of the configured conditions, explicitly configure a deny statement.

The control-plane ACL is mutually exclusive with VTY ACL, the management ACL. VTY ACL provides secure access for session connection protocols, such as SSH or TELNET; however, control-plane ACLs permit or deny any TCP or UDP, including SSH and TELNET sessions, from specific hosts and networks, and also filters both IPv4 and IPv6 traffic.

### Configure control-plane ACL

To configure control-plane ACLs, use the existing ACL template and create the appropriate rules to permit or deny traffic as needed, similar to creating an access list for VTY ACLs. However, when you apply this control-plane ACL, you must apply it in CONTROL-PLANE mode instead of VTY mode. For example:

```
OS10# configure terminal
OS10(config)# control-plane
OS10(config-control-plane)# ip access-group acl_name in
```

where *acl\_name* is the name of the control-plane ACL, a maximum of 140 characters.

 **NOTE:** Apply control-plane ACLs on ingress traffic only.

### Configuration notes

The control-plane MAC ACL is not supported for management port on all platforms.

## Control-plane ACL qualifiers

This section lists the supported control-plane ACL rule qualifiers.

 **NOTE:** OS10 supports only the qualifiers listed below. Ensure that you use only these qualifiers in ACL rules.

- IPv4 qualifiers:
  - `DST_IP`—Destination IP address
  - `SRC_IP`—Source IP address
  - `IP_TYPE`—IP type
  - `IP_PROTOCOL`—Protocols such as TCP, UDP, and so on
  - `L4_DST_PORT`—Destination port number
- IPv6 qualifiers:



- `DST_IPv6`—Destination address
- `SRC_IPv6`—Source address
- `IP_TYPE`—IP Type; for example, IPv4 or IPv6
- `IP_PROTOCOL`—TCP, UDP, and so on
- `L4_DST_PORT`—Destination port
- MAC qualifiers:
  - `OUT_PORT`—Egress CPU port
  - `SRC_MAC`—Source MAC address
  - `DST_MAC`—Destination MAC address
  - `ETHER_TYPE`—Ethertype
  - `OUTER_VLAN_ID`—VLAN ID
  - `IP_TYPE`—IP type
  - `OUTER_VLAN_PRI`—DOT1P value

## IP fragment handling

OS10 supports a configurable option to explicitly deny IP-fragmented packets, particularly for the second and subsequent packets. This option extends the existing ACL command syntax with the `fragments` keyword for all L3 rules:

- Second and subsequent fragments are allowed because you cannot apply a L3 rule to these fragments. If the packet is denied eventually, the first fragment must be denied and the packet as a whole cannot be reassembled.
- The system applies implicit permit for the second and subsequent fragment before the *implicit* deny.
- If you configure an *explicit* deny, the second and subsequent fragments do not hit the implicit permit rule for fragments.

## IP fragments ACL

When a packet exceeds the maximum packet size, the packet is fragmented into a number of smaller packets that contain portions of the contents of the original packet. This packet flow begins with an initial packet that contains all of the L3 and Layer 4 (L4) header information contained in the original packet, and is followed by a number of packets that contain only the L3 header information.

This packet flow contains all of the information from the original packet distributed through packets that are small enough to avoid the maximum packet size limit. This provides a particular problem for ACL processing.

If the ACL filters based on L4 information, the non-initial packets within the fragmented packet flow will not match the L4 information, even if the original packet would have matched the filter. Because of this filtering, packets are not processed by the ACL.

The examples show denying second and subsequent fragments, and permitting all packets on an interface. These ACLs deny all second and subsequent fragments with destination IP 10.1.1.1, but permit the first fragment and non-fragmented packets with destination IP 10.1.1.1. The second example shows ACLs which permits all packets — both fragmented and non-fragmented — with destination IP 10.1.1.1.

### Deny second and subsequent fragments

```
OS10(config)# ip access-list ABC
OS10(conf-ipv4-acl)# deny ip any 10.1.1.1/32 fragments
OS10(conf-ipv4-acl)# permit ip any 10.1.1.1/32
```

### Permit all packets on interface

```
OS10(config)# ip access-list ABC
OS10(conf-ipv4-acl)# permit ip any 10.1.1.1/32
OS10(conf-ipv4-acl)# deny ip any 10.1.1.1/32 fragments
```

## L3 ACL rules

Use ACL commands for L3 packet filtering. TCP packets from host 10.1.1.1 with the TCP destination port equal to 24 are permitted, and all others are denied.

TCP packets that are first fragments or non-fragmented from host 10.1.1.1 with the TCP destination port equal to 24 are permitted, and all TCP non-first fragments from host 10.1.1.1 are permitted. All other IP packets that are non-first fragments are denied.

## Permit ACL with L3 information only

If a packet's L3 information matches the information in the ACL, the packet's fragment offset (FO) is checked:

- If a packet's FO > 0, the packet is permitted
- If a packet's FO = 0, the next ACL entry processes

## Deny ACL with L3 information only

If a packet's L3 information does not match the L3 information in the ACL, the packet's FO is checked:

- If a packet's FO > 0, the packet is denied
- If a packet's FO = 0, the next ACL line processes

## Permit all packets from host

```
OS10(config)# ip access-list ABC
OS10(conf-ipv4-acl)# permit tcp host 10.1.1.1 any eq 24
OS10(conf-ipv4-acl)# deny ip any any fragment
```

## Permit only first fragments and non-fragmented packets from host

```
OS10(config)# ip access-list ABC
OS10(conf-ipv4-acl)# permit tcp host 10.1.1.1 any eq 24
OS10(conf-ipv4-acl)# permit tcp host 10.1.1.1 any fragment
OS10(conf-ipv4-acl)# deny ip any any fragment
```

To log all packets denied and to override the implicit deny rule and the implicit permit rule for TCP/ UDP fragments, use a similar configuration. When an ACL filters packets, it looks at the FO to determine whether it is a fragment:

- FO = 0 means it is either the first fragment or the packet is a non-fragment
- FO > 0 means it is the fragments of the original packet

## Assign sequence number to filter

IP ACLs filter on source and destination IP addresses, IP host addresses, TCP addresses, TCP host addresses, UDP addresses, and UDP host addresses. Traffic passes through the filter by filter sequence. Configure the IP ACL by first entering IP ACCESS-LIST mode and then assigning a sequence number to the filter.

## User-provided sequence number

- Enter IP ACCESS LIST mode by creating an IP ACL in CONFIGURATION mode.

```
ip access-list access-list-name
```

- Configure a drop or forward filter in IPV4-ACL mode.

```
seq sequence-number {deny | permit | remark} {ip-protocol-number | icmp | ip |
protocol | tcp | udp} {source prefix | source mask | any | host} {destination mask |
any | host ip-address} [count [byte]] [fragments]
```

## Auto-generated sequence number

If you are creating an ACL with only one or two filters, you can let the system assign a sequence number based on the order you configure the filters. The system assigns sequence numbers to filters using multiples of ten values.

- Configure a deny or permit filter to examine IP packets in IPv4-ACL mode.

```
{deny | permit} {source mask | any | host ip-address} [count [byte]] [fragments]
```

- Configure a deny or permit filter to examine TCP packets in IPv4-ACL mode.

```
{deny | permit} tcp {source mask} | any | host ip-address}} [count [byte]] [fragments]
```

- Configure a deny or permit filter to examine UDP packets in IPv4-ACL mode.

```
{deny | permit} udp {source mask | any | host ip-address}} [count [byte]] [fragments]
```

### Assign sequence number to filter

```
OS10(config)# ip access-list acl1
OS10(conf-ipv4-acl)# seq 5 deny tcp any any capture session 1 count
```

### View ACLs and packets processed through ACL

```
OS10# show ip access-lists in
Ingress IP access-list acl1
Active on interfaces :
 ethernet1/1/5
seq 5 permit ip any any count (10000 packets)
```

## Delete ACL rule

Before release 10.4.2, deleting ACL rules required a sequence number.

After release 10.4.2 or later, you can also delete ACL rules using the `no` form of the CLI command without using a sequence number.

While deleting ACL rules, the following conditions apply:

- Enter the exact `no` form of the CLI command. Each ACL rule is an independent entity. For example, the rule, `deny ip any any` is different from `deny ip any any count`.

For example, if you configured the following rules:

```
deny ip 1.1.1.1/24 2.2.2.2/24
deny ip any any
```

Using the `no deny ip any any` command deletes only the `deny ip any any` rule.

To delete the `deny ip 1.1.1.1/24 2.2.2.2/24` rule, you must explicitly use the `no deny ip 1.1.1.1/24 2.2.2.2/24` command.

 **NOTE:** Wildcard option is not supported.

- You can no longer configure the same ACL rule multiple times using different sequence numbers. This option prevents duplicate rules from being entered in the system and taking up memory space.
- When you upgrade from a previous release to release 10.4.2 or later, the upgrade procedure removes all duplicate ACL rules and only one instance of an ACL rule remains in the system.

## L2 and L3 ACLs

Configure both L2 and L3 ACLs on an interface in L2 mode. Rules apply if you use both L2 and L3 ACLs on an interface.

- L3 ACL filters packets and then the L2 ACL filters packets
- Egress L3 ACL filters packets

Rules apply in order:

- Ingress L3 ACL
- Ingress L2 ACL
- Egress L3 ACL
- Egress L2 ACL

**i** | **NOTE:** In ingress ACLs, L2 has a higher priority than L3 and in egress ACLs, L3 has a higher priority than L2.

**Table 79. L2 and L3 targeted traffic**

| L2 ACL / L3 ACL | Targeted traffic |
|-----------------|------------------|
| Deny / Deny     | L3 ACL denies    |
| Deny / Permit   | L3 ACL permits   |
| Permit / Deny   | L3 ACL denies    |
| Permit / Permit | L3 ACL permits   |

## Assign and apply ACL filters

To filter an Ethernet interface, a port-channel interface, or a VLAN, assign an IP ACL filter to the corresponding interface. The IP ACL applies to all traffic entering a physical, port-channel, or VLAN interface. The traffic either forwards or drops depending on the criteria and actions you configure in the ACL filter.

To change the ACL filter functionality, apply the same ACL filters to different interfaces. For example, take ACL “ABCD” and apply it using the `in` keyword and it becomes an ingress ACL. If you apply the same ACL filter using the `out` keyword, it becomes an egress ACL.

You can apply an IP ACL filter to a physical, port-channel, or VLAN interface. The number of ACL filters allowed is hardware-dependent.

1. Enter the interface information in CONFIGURATION mode.

```
interface ethernet node/slot/port
```

2. Configure an IP address for the interface, placing it in L3 mode in INTERFACE mode.

```
ip address ip-address
```

3. Apply an IP ACL filter to traffic entering or exiting an interface in INTERFACE mode.

```
ip access-group access-list-name {in | out}
```

### Configure IP ACL

```
OS10(config)# interface ethernet 1/1/28
OS10(conf-if-eth1/1/28)# ip address 10.1.2.0/24
OS10(conf-if-eth1/1/28)# ip access-group abcd in
```

### View ACL filters applied to interface

```
OS10# show ip access-lists in
Ingress IP access-list acl1
Active on interfaces :
 ethernet1/1/28
seq 10 permit ip host 10.1.1.1 host 100.1.1.1 count (0 packets)
seq 20 deny ip host 20.1.1.1 host 200.1.1.1 count (0 packets)
seq 30 permit ip 10.1.2.0/24 100.1.2.0/24 count (0 packets)
seq 40 deny ip 20.1.2.0/24 200.1.2.0/24 count (0 packets)
seq 50 permit ip 10.0.3.0 255.0.255.0 any count (0 packets)
seq 60 deny ip 20.0.3.0 255.0.255.0 any count (0 packets)
seq 70 permit tcp any eq 1000 100.1.4.0/24 eq 1001 count (0 packets)
seq 80 deny tcp any eq 2100 200.1.4.0/24 eq 2200 count (0 packets)
seq 90 permit udp 10.1.5.0/28 eq 10000 any eq 10100 count (0 packets)
seq 100 deny tcp host 20.1.5.1 any rst psh count (0 packets)
```

```
seq 110 permit tcp any any fin syn rst psh ack urg count (0 packets)
seq 120 deny icmp 20.1.6.0/24 any fragment count (0 packets)
seq 130 permit 150 any any dscp 63 count (0 packets)
```

To view the number of packets matching the ACL, use the `count` option when creating ACL entries.

- Create an ACL that uses rules with the `count` option, see [Assign sequence number to filter](#).
- Apply the ACL as an inbound or outbound ACL on an interface in CONFIGURATION mode, and view the number of packets matching the ACL.

```
show ip access-list {in | out}
```

## Ingress ACL filters

To create an ingress ACL filter, use the `ip access-group` command in EXEC mode. To configure ingress, use the `in` keyword. Apply rules to the ACL with the `ip access-list acl-name` command. To view the access-list, use the `show access-lists` command.

1. Apply an ingress access-list on the interface in INTERFACE mode.

```
ip access-group access-group-name in
```

2. Return to CONFIGURATION mode.

```
exit
```

3. Create the access-list in CONFIGURATION mode.

```
ip access-list access-list-name
```

4. Create the rules for the access-list in ACCESS-LIST mode.

```
permit ip host ip-address host ip-address count
```

### Apply ACL rules to access-group and view access-list

```
OS10(config)# interface ethernet 1/1/28
OS10(conf-if-eth1/1/28)# ip access-group abcd in
OS10(conf-if-eth1/1/28)# exit
OS10(config)# ip access-list acl1
OS10(conf-ip4-acl)# permit ip host 10.1.1.1 host 100.1.1.1 count
```

### Configuration notes

Dell EMC PowerSwitch S4200-ON Series:

- The following applications require ACL tables: VLT, iSCSI, L2 ACL, L3 v4 ACL, L3 v6 ACL, PBR v4, PBR v6, QoS L2, QoS L3, FCoE. In ingress ACL, you can create ACL tables only for three applications at a time.
- In IPv6 ACL and PBR ACL, I4-destination-port, I4-source-port, flow label, and TCP flags are not supported.
- IP fragment supports only 2 options: non-fragment and head/non-head.

Dell EMC PowerSwitch S5200-ON Series:

When you configure QoS service-policy on an S5200-ON switch that is in a VLT setup with MAC and IP ACLs configured, an error appears. This issue occurs because of ACL group width limitation in the S5200-ON series switches. VLT, IP, MAC, and QoS ACLs require double-width ACL table slice. The S5200-ON series switches support only three applications that require double-wide ACL table slice at a time. An error appears because the QoS application configuration requires a fourth ACL table slice.

## Egress ACL filters

Egress ACL filters affect the traffic *leaving* the network. Configuring egress ACL filters onto physical interfaces protects the system infrastructure from a malicious and intentional attack by explicitly allowing only authorized traffic. These system-wide ACL filters eliminate the need to apply ACL filters onto each interface.

You can use an egress ACL filter to restrict egress traffic. For example, when you isolate denial of service (DoS) attack traffic to a specific interface, and apply an egress ACL filter to block the DoS flow from exiting the network, you protect downstream devices.

1. Apply an egress access-list on the interface in INTERFACE mode.

```
ip access-group access-group-name out
```

2. Return to CONFIGURATION mode.

```
exit
```

3. Create the access-list in CONFIGURATION mode.

```
ip access-list access-list-name
```

4. Create the rules for the access-list in ACCESS-LIST mode.

```
seq 10 deny ip any any count fragment
```

### Apply rules to ACL filter

```
OS10(config)# interface ethernet 1/1/29
OS10(conf-if-eth1/1/29)# ip access-group egress out
OS10(conf-if-eth1/1/29)# exit
OS10(config)# ip access-list egress
OS10(conf-ip4-acl)# seq 10 deny ip any any count fragment
```

### View IP ACL filter configuration

```
OS10# show ip access-lists out
Egress IP access-list abcd
Active on interfaces :
 ethernet1/1/29
seq 10 deny ip any any fragment count (100 packets)
```

### Configuration notes

Dell EMC PowerSwitch S4200-ON Series:

- You can create either Layer 2 ACL or Layer 3 ACL. You cannot create both the tables at a time.
- In egress L3 IPv4 ACL, the fragment, TCP flags, and DSCP fields are not supported.
- In egress ACLs, L2 user table is utilized only for switched packets and L3 user table is utilized only for routed packets.

## VTY ACLs

To limit Telnet and SSH connections to the switch, apply access lists on a virtual terminal line (VTY). See [Virtual terminal line ACLs](#) for more information.

For VTY ACLs, there is no implicit deny rule. If none of the configured conditions match, the default behavior is to permit. If you need to deny traffic that does not match any of the configured conditions, explicitly configure a deny statement.

## SNMP ACLs

To filter SNMP requests on the switch, assign access lists to an SNMP community. Both IPv4 and IPv6 access lists are supported to restrict IP source addresses. See [Restrict SNMP access](#) for more information.

 **NOTE:** SNMP ACL works only when the SNMP server is reachable through the default VRF.

## Clear access-list counters

Clear IPv4, IPv6, or MAC access-list counters for a specific access-list or all lists. The counter counts the number of packets that match each permit or deny statement in an access-list. To get a more recent count of packets matching an access-list, clear the counters to start at zero. If you do not configure an access-list name, all IP access-list counters clear.

To view access-list information, use the `show access-lists` command.

- Clear IPv4 access-list counters in EXEC mode.

```
clear ip access-list counters access-list-name
```

- Clear IPv6 access-list counters in EXEC mode.

```
clear ipv6 access-list counters access-list-name
```

- Clear MAC access-list counters in EXEC mode.

```
clear mac access-list counters access-list-name
```

## IP prefix-lists

IP prefix-lists control the routing policy. An IP prefix-list is a series of sequential filters that contain a matching criterion and an permit or deny action to process routes. The filters process in sequence so that if a route prefix does not match the criterion in the first filter, the second filter applies, and so on.

A route prefix is an IP address pattern that matches on bits within the IP address. The format of a route prefix is `A.B.C.D/x`, where `A.B.C.D` is a dotted-decimal address and `/x` is the number of bits that match the dotted decimal address.

When the route prefix matches a filter, the system drops or forwards the packet based on the filter's designated action. If the route prefix does not match any of the filters in the prefix-list, the route drops, an implicit deny.

For example, in `112.24.0.0/16`, the first 16 bits of the address `112.24.0.0` match all addresses between `112.24.0.0` to `112.24.255.255`. Use permit or deny filters for specific routes with the `le` (less or equal) and `ge` (greater or equal) parameters, where `x.x.x.x/x` represents a route prefix:

- To deny only `/8` prefixes, enter `deny x.x.x.x/x ge 8 le 8`
- To permit routes with the mask greater than `/8` but less than `/12`, enter `permit x.x.x.x/x ge 8 le 12`
- To deny routes with a mask less than `/24`, enter `deny x.x.x.x/x le 24`
- To permit routes with a mask greater than `/20`, enter `permit x.x.x.x/x ge 20`

The following rules apply to prefix-lists:

- A prefix-list without permit or deny filters allows all routes
- An *implicit deny* is assumed — the route drops for all route prefixes that do not match a permit or deny filter
- After a route matches a filter, the filter's action applies and no additional filters apply to the route

 **NOTE:** Use prefix-lists in processing routes for routing protocols such as open shortest path first (OSPF), route table manager (RTM), and border gateway protocol (BGP).

To configure a prefix-list, use commands in PREFIX-LIST and ROUTER-BGP modes. Create the prefix-list in PREFIX-LIST mode and assign that list to commands in ROUTER-BGP modes.

## Route-maps

Route-maps are a series of commands that contain a matching criterion and action. They change the packets meeting the matching criterion. ACLs and prefix-lists can only drop or forward the packet or traffic while route-maps process routes for route redistribution. For example, use a route-map to filter only specific routes and to add a metric.

- Route-maps also have an *implicit deny*. Unlike ACLs and prefix-lists where the packet or traffic drops, if a route does not match the route-map conditions, the route does not redistribute.
- Route-maps process routes for route redistribution. For example, to add a metric, a route-map can *filter* only specific routes. If the route does not match the conditions, the route-map decides where the packet or traffic drops. The route does not redistribute if it does not match.

- Route-maps use commands to decide what to do with traffic. To remove the match criteria in a route-map, use the `no match` command.
- In a BGP route-map, if you repeat the same match statements; for example, a match metric, with different values in the same sequence number, only the last match and set values are taken into account.

### Configure match metric

```
OS10(config)# route-map hello
OS10(config-route-map)# match metric 20
```

### View route-map

```
OS10(config-route-map)# do show route-map
route-map hello, permit, sequence 10
 Match clauses:
 metric 20
```

### Change match

```
OS10(config-route-map)# match metric 30
```

### View updated route-map

```
OS10(config-route-map)# do show route-map
route-map hello, permit, sequence 10
 Match clauses:
 metric 30
```

To filter the routes for redistribution, combine route-maps and IP prefix lists. The following table explains the action performed for multiple match commands under a single route-map.

**Table 80. Multiple match commands under a single route-map**

| Route-map clause | Prefix list | Incoming Route | Action                               |
|------------------|-------------|----------------|--------------------------------------|
| permit           | permit      | MATCH          | The route is permitted.              |
|                  | permit      | NO MATCH       | Continue with next route-map clause. |
|                  | deny        | MATCH          | Continue with next route-map clause. |
|                  | deny        | NO MATCH       | Continue with next route-map clause. |
| deny             | permit      | MATCH          | The route is denied.                 |
|                  | permit      | NO MATCH       | Continue with next route-map clause. |
|                  | deny        | MATCH          | Continue with next route-map clause. |
|                  | deny        | NO MATCH       | Continue with next route-map clause. |

### View both IP prefix-list and route-map configuration

```
OS10(config-router-bgp-neighbor-af)# do show ip prefix-list
ip prefix-list p1:
seq 1 deny 10.1.1.0/24
seq 10 permit 0.0.0.0/0 le 32
ip prefix-list p2:
seq 1 permit 10.1.1.0/24
seq 10 permit 0.0.0.0/0 le 32
```

### View route-map configuration

```
OS10(config-router-bgp-neighbor-af)# do show route-map
route-map test1, deny, sequence 10
 Match clauses:
 ip address prefix-list p1
 Set clauses:
route-map test2, permit, sequence 10
```



```

Match clauses:
ip address prefix-list p1
Set clauses:
route-map test3, deny, sequence 10
Match clauses:
ip address prefix-list p2
Set clauses:
route-map test4, permit, sequence 10
Match clauses:
ip address prefix-list p2
Set clauses:

```

## Match routes

Configure match criterion for a route-map. There is no limit to the number of `match` commands per route map, but keep the number of match filters in a route-map low. The `set` commands do not require a corresponding `match` command.

- Match routes with a specific metric value in ROUTE-MAP mode, from 0 to 4294967295.

```
match metric metric-value
```

- Match routes with a specific tag in ROUTE-MAP mode, from 0 to 4294967295.

```
match tag tag-value
```

- Match routes whose next hop is a specific interface in ROUTE-MAP mode.

```
match interface interface
```

- `ethernet` — Enter the Ethernet interface information.
- `port-channel` — Enter the port-channel number.
- `vlan` — Enter the VLAN ID number.

### Check match routes

```

OS10(config)# route-map test permit 1
OS10(conf-route-map)# match tag 250000
OS10(conf-route-map)# set weight 100

```

## Set conditions

There is no limit to the number of `set` commands per route map, but keep the number of set filters in a route-map low. The `set` commands do not require a corresponding `match` command.

- Enter the IP address in A.B.C.D format of the next-hop for a BGP route update in ROUTE-MAP mode.

```
set ip next-hop address
```

- Enter an IPv6 address in A::B format of the next-hop for a BGP route update in ROUTE-MAP mode.

```
set ipv6 next-hop address
```

- Enter the range value for the BGP route's LOCAL\_PREF attribute in ROUTE-MAP mode, from 0 to 4294967295.

```
set local-preference range-value
```

- Enter a metric value for redistributed routes in ROUTE-MAP mode, from 0 to 4294967295.

```
set metric {+ | - | metric-value}
```

- Enter an OSPF type for redistributed routes in ROUTE-MAP mode.

```
set metric-type {type-1 | type-2 | external | internal}
```

- Enter an ORIGIN attribute in ROUTE-MAP mode.

```
set origin {egp | igp | incomplete}
```

- Enter a tag value for the redistributed routes in ROUTE-MAP mode, from 0 to 4294967295.

```
set tag tag-value
```

- Enter a value as the route's weight in ROUTE-MAP mode, from 0 to 65535.

```
set weight value
```

#### Check set conditions

```
OS10(config)# route-map ip permit 1
OS10(conf-route-map)# match metric 2567
```

## Continue clause

Only BGP route-maps support the `continue` clause. When a match is found, `set` clauses run and the packet forwards — no route-map processing occurs. If you configure the `continue` clause without configuring a module, the next sequential module processes.

If you configure the `continue` command at the end of a module, the next module processes even after a match is found. The example shows a `continue` clause at the end of a route-map module — if a match is found in the route-map `test` module 10, module 30 processes.

#### Route-map continue clause

```
OS10(config)# route-map test permit 10
OS10(conf-route-map)# continue 30
```

## ACL flow-based monitoring

Flow-based monitoring conserves bandwidth by selecting only the required flow to mirror instead of mirroring entire packets from an interface. This feature is available for L2 and L3 ingress traffic. Specify flow-based monitoring using ACL rules. Flow-based monitoring copies incoming packets that match the ACL rules applied on the ingress port and forwards, or mirrors them to another port. The source port is the monitored port (MD), and the destination port is the monitoring port (MG).

When a packet arrives at a monitored port, the packet validates against the configured ACL rules. If the packet matches an ACL rule, the system examines the corresponding flow processor and performs the action specified for that port. If the mirroring action is set in the flow processor entry, the port details are sent to the destination port.

## Flow-based mirroring

Flow-based mirroring is a mirroring session in which traffic matches specified policies that mirrors to a destination port. Port-based mirroring maintains a database that contains all monitoring sessions, including port monitor sessions. The database has information regarding the sessions that are enabled or not enabled for flow-based monitoring. Flow-based mirroring is also known as policy-based mirroring.

To enable flow-based mirroring, use the `flow-based enable` command. Traffic with particular flows that traverse through the ingress interfaces are examined. Appropriate ACL rules apply in the ingress direction. By default, flow-based mirroring is not enabled.

To enable evaluation and replication of traffic traversing to the destination port, configure the `monitor` option using the `permit`, `deny`, or `seq` commands for ACLs assigned to the source or the monitored port (MD). Enter the keywords `capture session session-id` with the `seq`, `permit`, or `deny` command for the ACL rules to allow or drop IPv4, IPv6, ARP, UDP, EtherType, ICMP, and TCP packets.

#### IPV4-ACL mode

```
seq sequence-number {deny | permit} {source [mask] | any | host ip-address} [count [byte]]
[fragments] [threshold-in-msgs count] [capture session session-id]
```

If you configure the `flow-based enable` command and do not apply an ACL on the source port or the monitored port, both flow-based monitoring and port mirroring do not function. Flow-based monitoring is supported only for ingress traffic.

The `show monitor session session-id` command displays output that indicates if a particular session is enabled for flow-monitoring.

### View flow-based monitoring

```
OS10# show monitor session 1
S.Id Source Destination Dir SrcIP DstIP DSCP TTL State Reason

1 ethernet1/1/1 ethernet1/1/4 both N/A N/A N/A N/A true Is UP
```

### Traffic matching ACL rule

```
OS10# show ip access-lists in
Ingress IP access-list testflow
Active on interfaces :
 ethernet1/1/1
 seq 5 permit icmp any any capture session 1 count (0 packets)
 seq 10 permit ip 102.1.1.0/24 any capture session 1 count bytes (0 bytes)
 seq 15 deny udp any any capture session 2 count bytes (0 bytes)
 seq 20 deny tcp any any capture session 3 count bytes (0 bytes)
```

## Enable flow-based monitoring

Flow-based monitoring conserves bandwidth by mirroring only specified traffic, rather than all traffic on an interface. It is available for L2 and L3 ingress and egress traffic. Configure traffic to monitor using ACL filters.

1. Create a monitor session in MONITOR-SESSION mode.

```
monitor session session-number type {local | rspan-source}
```

2. Enable flow-based monitoring for the mirroring session in MONITOR-SESSION mode.

```
flow-based enable
```

3. Define ACL rules that include the keywords `capture session session-id` in CONFIGURATION mode. The system only considers port monitoring traffic that matches rules with the keywords `capture session`.

```
ip access-list
```

4. Apply the ACL to the monitored port in INTERFACE mode.

```
ip access-group access-list
```

### Enable flow-based monitoring

```
OS10(config)# monitor session 1 type local
OS10(conf-mon-local-1)# flow-based enable
OS10(config)# ip access-list testflow
OS10(conf-ipv4-acl)# seq 5 permit icmp any any capture session 1
OS10(conf-ipv4-acl)# seq 10 permit ip 102.1.1.0/24 any capture session 1 count byte
OS10(conf-ipv4-acl)# seq 15 deny udp any any capture session 2 count byte
OS10(conf-ipv4-acl)# seq 20 deny tcp any any capture session 3 count byte
OS10(conf-ipv4-acl)# exit
OS10(config)# interface ethernet 1/1/1
OS10(conf-if-eth1/1/1)# ip access-group testflow in
OS10(conf-if-eth1/1/1)# no shutdown
```

### View access-list configuration

```
OS10# show ip access-lists in
Ingress IP access-list testflow
Active on interfaces :
 ethernet1/1/1
 seq 5 permit icmp any any capture session 1 count (0 packets)
 seq 10 permit ip 102.1.1.0/24 any capture session 1 count bytes (0 bytes)
```

```
seq 15 deny udp any any capture session 2 count bytes (0 bytes)
seq 20 deny tcp any any capture session 3 count bytes (0 bytes)
```

### View monitor sessions

```
OS10(conf-if-eth1/1/1)# show monitor session all
S.Id Source Destination Dir SrcIP DstIP DSCP TTL State Reason

1 ethernet1/1/1 ethernet1/1/4 both N/A N/A N/A N/A true Is UP
```

## View ACL table utilization report

The `show acl-table-usage detail` command shows the ingress and egress ACL tables for the various features and their utilization.

The hardware pool area displays the ingress application groups (pools), the features mapped to each of these groups, and the amount of used and free space available in each of the pools. The amount of space required to store a single ACL rule in a pool depends on the keywidth of the TCAM slice.

The service pool displays the amount of used and free space for each of the features. The number of ACL rules configured for a feature is displayed in the configured rules column. The number of used rows depends on the number of ports the configured rules are applied on. Under Allocated pools, you can view the percentage of dedicated space reserved for a particular feature or the phrase Shared if you have not reserved space for each of the features individually, against the total number of pools allocated for the application group. In the example given below, the SYSTEM\_FLOW feature has 15 percentage of space reserved in ingress app-group-1 with a pool count of 1, which is represented by 15:1.

```
OS10# show acl-table-usage detail
Ingress ACL utilization
Hardware Pools

Pool ID App(s)
rows Max rows Used rows Free

0 SYSTEM_FLOW 49
975 1024
1 SYSTEM_FLOW 49
975 1024
2 USER_IPV4_ACL 3
1021 1024
3 USER_L2_ACL 2
1022 1024
4 USER_IPV6_ACL 2
510 512
5 USER_IPV6_ACL 2
510 512
6 FCOE 55
457 512
7 FCOE 55
457 512
8 ISCSI_SNOOPING 12
500 512
9 FREE 0
512 512
10 PBR_V6 1
511 512
11 PBR_V6 1
511 512

Service Pools

App Allocated pools App group Configured rules Used rows Free
rows Max rows

USER_L2_ACL Shared:1 G3 1 2
```

|                        |                    |           |                  |           |           |      |
|------------------------|--------------------|-----------|------------------|-----------|-----------|------|
| 1022                   | 1024               |           |                  |           |           |      |
| USER_IPV4_ACL          |                    | Shared:1  | G2               | 2         |           | 3    |
| 1021                   | 1024               |           |                  |           |           |      |
| USER_IPV6_ACL          |                    | Shared:2  | G4               | 1         |           | 2    |
| 510                    | 512                |           |                  |           |           |      |
| PBR_V6                 |                    | Shared:2  | G10              | 1         |           | 1    |
| 511                    | 512                |           |                  |           |           |      |
| SYSTEM_FLOW            |                    | Shared:2  | G0               | 49        |           | 49   |
| 975                    | 1024               |           |                  |           |           |      |
| ISCSI_SNOOPING         |                    | Shared:1  | G8               | 12        |           | 12   |
| 500                    | 512                |           |                  |           |           |      |
| FCOE                   |                    | Shared:2  | G6               | 55        |           | 55   |
| 457                    | 512                |           |                  |           |           |      |
| -----                  |                    |           |                  |           |           |      |
| Egress ACL utilization |                    |           |                  |           |           |      |
| Hardware Pools         |                    |           |                  |           |           |      |
| -----                  |                    |           |                  |           |           |      |
| Pool ID                | App(s)             |           |                  |           | Used rows | Free |
| rows                   | Max rows           |           |                  |           |           |      |
| -----                  |                    |           |                  |           |           |      |
| 0                      | USER_IPV4_EGRESS   |           |                  |           | 2         |      |
| 254                    | 256                |           |                  |           |           |      |
| 1                      | USER_L2_ACL_EGRESS |           |                  |           | 2         |      |
| 254                    | 256                |           |                  |           |           |      |
| 2                      | USER_IPV6_EGRESS   |           |                  |           | 2         |      |
| 254                    | 256                |           |                  |           |           |      |
| 3                      | USER_IPV6_EGRESS   |           |                  |           | 2         |      |
| 254                    | 256                |           |                  |           |           |      |
| -----                  |                    |           |                  |           |           |      |
| Service Pools          |                    |           |                  |           |           |      |
| -----                  |                    |           |                  |           |           |      |
| App                    | Allocated pools    | App group | Configured rules | Used rows | Free      |      |
| rows                   | Max rows           |           |                  |           |           |      |
| -----                  |                    |           |                  |           |           |      |
| USER_L2_ACL_EGRESS     | Shared:1           | G1        | 1                | 2         |           |      |
| 254                    | 256                |           |                  |           |           |      |
| USER_IPV4_EGRESS       | Shared:1           | G0        | 1                | 2         |           |      |
| 254                    | 256                |           |                  |           |           |      |
| USER_IPV6_EGRESS       | Shared:2           | G2        | 1                | 2         |           |      |
| 254                    | 256                |           |                  |           |           |      |

## Known behavior

- On the S4200-ON platform, the `show acl-table-usage detail` command output lists several hardware pools as available (FREE), but you will see an "ACL CAM table full" warning log when the system creates a new service pool. The system will not be able to create any new service pools. The existing groups, however, can continue to grow up to the maximum available pool space.
- On the S4200-ON platform, the `show acl-table usage detail` command output lists all the available hardware pools under Ingress ACL utilization table and none under the Egress ACL utilization table. The system allocates pool space for Egress ACL table only when you configure Egress ACLs. You can run the `show acl-table-usage detail` command again to view pool space allocated under Egress ACL utilization table as well.
- On S52xx-ON, Z91xx-ON, Z92xx-ON platforms, the number of Configured Rules listed under Service Pools for each of the features is the number of ACLs multiplied by the number of ports on which they are applied. This number is cumulative. You can view the Used rows and Free rows that indicate the actual amount of space that is utilized and available in the hardware.

# ACL logging

You can configure ACLs to filter traffic, drop or forward packets that match certain conditions. The ACL logging feature allows you to get additional information about packets that match an access control list entry (ACE) applied on an interface in inbound direction.

OS10 creates a log message that includes additional information about the packet, when a matching packet hits a log-enabled ACL entry.

ACL logging helps to administer and manage traffic that traverses your network and is useful for network supervision and maintenance activities.

High volumes of network traffic can result in large volume of logs, which can negatively impact system performance and efficiency.

You can specify the threshold after which a log is created and the interval at which the logs must be created.

The threshold defines how often a log message is created after an initial packet match. The default is 10 messages. This value is configurable and the range is from 1 to 100 messages.

By default, the interval is set to 5 minutes and logs are created every 5 minutes. During this interval, the system continues to examine the packets against the configured ACL rule and permits or denies traffic, but logging is halted temporarily. This value is configurable and the range is from 1 to 10 minutes.

For example, if you have configured a threshold value of 20 and an interval of 10 minutes, after an initial packet match, the 20th packet that matches the ACL entry is logged. The system then waits for the interval period of 10 minutes to elapse, during which time no logging occurs. Once the interval period elapses, the 20th packet that matches the ACL entry is logged again.

## Important notes

The ACL logging feature is:

- Applicable only for IPv4 and IPv6 user ACLs. MAC ACLs are not logged.
- Applicable only for user ACLs applied on interfaces in the inbound direction. Even though ACL logging cannot be enabled for outbound ACLs, ACL configuration is applied.

If you have enabled ACL logging, downgrade from release 10.4.3.0 to a previous release fails and the corresponding ACL rules are not applied. Before you downgrade, be sure to disable ACL logging or delete the startup configuration.

Dell EMC recommends that you do not enable logging for control plane protocol identical user ACL entry.

DELL EMC recommends a max scale of 128 log-enabled ACL entries. If logging cannot be enabled on further ACL entries, a syslog error message appears to indicate logging cannot be enabled. However, the ACL entries are applied.

## ACL commands

### clear ip access-list counters

Clears ACL counters for a specific access-list.

|                          |                                                                                                                                                                                                                                                                                                                                                                         |
|--------------------------|-------------------------------------------------------------------------------------------------------------------------------------------------------------------------------------------------------------------------------------------------------------------------------------------------------------------------------------------------------------------------|
| <b>Syntax</b>            | <code>clear ip access-list counters [access-list-name]</code>                                                                                                                                                                                                                                                                                                           |
| <b>Parameters</b>        | <code>access-list-name</code> — (Optional) Enter the name of the IP access-list to clear counters. A maximum of 140 characters.                                                                                                                                                                                                                                         |
| <b>Default</b>           | Not configured                                                                                                                                                                                                                                                                                                                                                          |
| <b>Command Mode</b>      | EXEC                                                                                                                                                                                                                                                                                                                                                                    |
| <b>Usage Information</b> | If you do not enter an access-list name, all IPv6 access-list counters clear. The counter counts the number of packets that match each permit or deny statement in an access-list. To get a more recent count of packets matching an access list, clear the counters to start at zero. To view access-list information, use the <code>show access-lists</code> command. |

**Example**

```
OS10# clear ip access-list counters
```

**Supported Releases**

10.2.0E or later

## clear ipv6 access-list counters

Clears IPv6 access-list counters for a specific access-list.

**Syntax**

```
clear ipv6 access-list counters [access-list-name]
```

**Parameters**

*access-list-name* — (Optional) Enter the name of the IPv6 access-list to clear counters. A maximum of 140 characters.

**Default**

Not configured

**Command Mode**

EXEC

**Usage Information**

If you do not enter an access-list name, all IPv6 access-list counters clear. The counter counts the number of packets that match each permit or deny statement in an access list. To get a more recent count of packets matching an access list, clear the counters to start at zero. To view access-list information, use the `show access-lists` command.

**Example**

```
OS10# clear ipv6 access-list counters
```

**Supported Releases**

10.2.0E or later

## clear mac access-list counters

Clears counters for a specific or all MAC access lists.

**Syntax**

```
clear mac access-list counters [access-list-name]
```

**Parameters**

*access-list-name* — (Optional) Enter the name of the MAC access list to clear counters. A maximum of 140 characters.

**Default**

Not configured

**Command Mode**

EXEC

**Usage Information**

If you do not enter an access-list name, all MAC access-list counters clear. The counter counts the number of packets that match each permit or deny statement in an access list. To get a more recent count of packets matching an access list, clear the counters to start at zero. To view access-list information, use the `show access-lists` command.

**Example**

```
OS10# clear mac access-list counters
```

**Supported Releases**

10.2.0E or later

## deny

Configures a filter to drop packets with a specific IP address.

**Syntax**

```
deny [protocol-number | icmp | ip | tcp | udp] [A.B.C.D | A.B.C.D/x | any | host ip-address] [A.B.C.D | A.B.C.D/x | any | host ip-address] [capture | count | dscp value | fragment | log]
```

**Parameters**

- *protocol-number* — (Optional) Enter the protocol number identified in the IP header, from 0 to 255.

- `icmp` — (Optional) Enter the ICMP address to deny.
- `ip` — (Optional) Enter the IP address to deny.
- `tcp` — (Optional) Enter the TCP address to deny.
- `udp` — (Optional) Enter the UDP address to deny.
- `A.B.C.D` — Enter the IP address in dotted decimal format.
- `A.B.C.D/x` — Enter the number of bits to match to the dotted decimal address.
- `any` — (Optional) Enter the keyword `any` to specify any source or destination IP address.
- `host ip-address` — (Optional) Enter the keyword and the IP address to use a host address only.
- `capture` — (Optional) Capture packets the filter processes.
- `count` — (Optional) Count packets the filter processes.
- `byte` — (Optional) Count bytes the filter processes.
- `dscp value` — (Optional) Deny a packet based on the DSCP values, from 0 to 63.
- `fragment` — (Optional) Use ACLs to control packet fragments.
- `log` — (Optional) Enables ACL logging. Information about packets that match an ACL rule are logged.

**Default** Not configured

**Command Mode** IPV4-ACL

**Usage Information** OS10 cannot count both packets and bytes; when you use the `count` `byte` options, only bytes increment. The `no` version of this command removes the filter.

**Example**

```
OS10(config)# ip access-list testflow
OS10(conf-ipv4-acl)# deny udp any any
```

**Supported Releases** 10.2.0E or later

## deny (IPv6)

Configures a filter to drop packets with a specific IPv6 address.

**Syntax** `deny [protocol-number | icmp | ipv6 | tcp | udp] [A::B | A::B/x | any | host ipv6-address] [A::B | A::B/x | any | host ipv6-address] [capture | count | dscp value | fragment | log]`

- Parameters**
- `protocol-number` — (Optional) Enter the protocol number identified in the IP header, from 0 to 255.
  - `icmp` — (Optional) Enter the ICMP address to deny.
  - `ipv6` — (Optional) Enter the IPv6 address to deny.
  - `tcp` — (Optional) Enter the TCP address to deny.
  - `udp` — (Optional) Enter the UDP address to deny.
  - `A::B` — Enter the IPv6 address in dotted decimal format.
  - `A::B/x` — Enter the number of bits to match to the IPv6 address.
  - `any` — (Optional) Enter the keyword `any` to specify any source or destination IP address.
  - `host ipv6-address` — (Optional) Enter the keyword and the IPv6 address to use a host address only.
  - `capture` — (Optional) Capture packets the filter processes.
  - `count` — (Optional) Count packets the filter processes.
  - `byte` — (Optional) Count bytes the filter processes.
  - `dscp value` — (Optional) Deny a packet based on the DSCP values, from 0 to 63.
  - `fragment` — (Optional) Use ACLs to control packet fragments.
  - `log` — (Optional) Enables ACL logging. Information about packets that match an ACL rule are logged.

**Default** Not configured

**Command Mode** IPV6-ACL



**Usage Information** OS10 cannot count both packets and bytes; when you use the `count` `byte` options, only bytes increment. The `no` version of this command removes the filter.

**Example**

```
OS10(config)# ipv6 access-list ipv6test
OS10(conf-ipv6-acl)# deny ipv6 any any capture session 1
```

**Supported Releases** 10.2.0E or later

## deny (MAC)

Configures a filter to drop packets with a specific MAC address.

**Syntax** `deny {nn:nn:nn:nn:nn:nn [00:00:00:00:00:00] | any} {nn:nn:nn:nn:nn:nn [00:00:00:00:00:00] | any} [protocol-number | capture | cos | count | vlan]`

- Parameters**
- `nn:nn:nn:nn:nn:nn` — Enter the MAC address of the network from or to which the packets are sent.
  - `00:00:00:00:00:00` — (Optional) Enter which bits in the MAC address must match. If you do not enter a mask, a mask of `00:00:00:00:00:00` applies.
  - `any` — (Optional) Set routes which are subject to the filter.
    - `protocol-number` — (Optional) MAC protocol number identified in the header, from 600 to ffff.
    - `capture` — (Optional) Capture packets the filter processes.
    - `cos` — (Optional) CoS value, from 0 to 7.
    - `count` — (Optional) Count packets the filter processes.
    - `vlan` — (Optional) VLAN number, from 1 to 4093.

**Default** Disabled

**Command Mode** MAC-ACL

**Usage Information** OS10 cannot count both packets and bytes; when you use the `count` `byte` options, only bytes increment. The `no` version of this command removes the filter.

**Example**

```
OS10(config)# mac access-list macacl
OS10(conf-mac-acl)# deny any any cos 7
OS10(conf-mac-acl)# deny any any vlan 2
```

**Supported Releases** 10.2.0E or later

## deny icmp

Configures a filter to drop all or specific Internet Control Message Protocol (ICMP) messages.

**Syntax** `deny icmp [A.B.C.D | A.B.C.D/x | any | host ip-address] [[A.B.C.D | A.B.C.D/x | any | host ip-address] [capture | count | dscp value | fragment | log]`

- Parameters**
- `A.B.C.D` — Enter the IP address in hexadecimal format separated by colons.
  - `A.B.C.D/x` — Enter the number of bits to match to the IP address.
  - `any` — (Optional) Enter the keyword `any` to specify any source or destination IP address.
  - `host ip-address` — (Optional) Enter the IP address to use a host address only.
  - `capture` — (Optional) Capture packets the filter processes.
  - `count` — (Optional) Count packets the filter processes.
  - `byte` — (Optional) Count bytes the filter processes.
  - `dscp value` — (Optional) Deny a packet based on the DSCP values, from 0 to 63.

- `fragment` — (Optional) Use ACLs to control packet fragments.
- `log` — (Optional) Enables ACL logging. Information about packets that match an ACL rule are logged.

**Default** Not configured

**Command Mode** IPV4-ACL

**Usage Information** OS10 cannot count both packets and bytes; when you use the `count` `byte` options, only bytes increment. The `no` version of this command removes the filter.

**Example**

```
OS10(config)# ip access-list egress
OS10(conf-ipv4-acl)# deny icmp any any capture session 1
```

**Supported Releases** 10.2.0E or later

## deny icmp (IPv6)

Configures a filter to drop all or specific ICMP messages.

**Syntax** `deny icmp [A::B | A::B/x | any | host ipv6-address] [A::B | A::B/x | any | host ipv6-address] [capture | count | dscp value | fragment | log]`

**Parameters**

- `A::B` — Enter the IPv6 address in hexadecimal format separated by colons.
- `A::B/x` — Enter the number of bits to match to the IPv6 address.
- `any` — (Optional) Enter the keyword `any` to specify any source or destination IP address.
- `host ipv6-address` — (Optional) Enter the IPv6 address to use a host address only.
- `capture` — (Optional) Capture packets the filter processes.
- `count` — (Optional) Count packets the filter processes.
- `byte` — (Optional) Count bytes the filter processes.
- `dscp value` — (Optional) Deny a packet based on the DSCP values, from 0 to 63.
- `fragment` — (Optional) Use ACLs to control packet fragments.
- `log` — (Optional) Enables ACL logging. Information about packets that match an ACL rule are logged.

**Default** Not configured

**Command Mode** IPV6-ACL

**Usage Information** OS10 cannot count both packets and bytes; when you use the `count` `byte` options, only bytes increment. The `no` version of this command removes the filter.

**Example**

```
OS10(config)# ipv6 access-list ipv6test
OS10(conf-ipv6-acl)# deny icmp any any capture session 1
```

**Supported Releases** 10.2.0E or later

## deny ip

Configures a filter to drop all or specific packets from an IPv4 address.

**Syntax** `deny ip [A.B.C.D | A.B.C.D/x | any | host ip-address] [[A.B.C.D | A.B.C.D/x | any | host ip-address] [capture | count [byte] | dscp value | fragment]`

**Parameters**

- `A.B.C.D` — Enter the IPv4 address in dotted decimal format.
- `A.B.C.D/x` — Enter the number of bits to match to the dotted decimal address.
- `any` — (Optional) Set all routes which are subject to the filter:
  - `capture` — (Optional) Capture packets the filter processes.

- `count` — (Optional) Count packets the filter processes.
- `byte` — (Optional) Count bytes the filter processes.
- `dscp value` — (Optional) Deny a packet based on the DSCP values, from 0 to 63.
- `fragment` — (Optional) Use ACLs to control packet fragments.
- `host ip-address` — (Optional) Enter the IPv4 address to use a host address only.

**Default** Not configured

**Command Mode** IPV4-ACL

**Usage Information** OS10 cannot count both packets and bytes; when you use the `count` `byte` options, only bytes increment. The `no` version of this command removes the filter.

**Example**

```
OS10(config)# ip access-list testflow
OS10(conf-ipv4-acl)# deny ip any any capture session 1 count
```

**Supported Releases** 10.2.0E or later

## deny ipv6

Configures a filter to drop all or specific packets from an IPv6 address.

**Syntax** `deny ipv6 [A::B | A::B/x | any | host ipv6-address] [A::B | A:B/x | any | host ipv6-address] [capture | count [byte] | dscp | fragment]`

**Parameters**

- `A::B` — (Optional) Enter the source IPv6 address from which the packet was sent and the destination address.
- `A::B/x` — (Optional) Enter the source network mask in /prefix format (/x) and the destination mask.
- `any` — (Optional) Set all routes which are subject to the filter:
  - `capture` — (Optional) Capture packets the filter processes.
  - `count` — (Optional) Count packets the filter processes.
  - `byte` — (Optional) Count bytes the filter processes.
  - `dscp value` — (Optional) Deny a packet based on the DSCP values, from 0 to 63.
  - `fragment` — (Optional) Use ACLs to control packet fragments.
- `host ipv6-address` — (Optional) Enter the IPv6 address to use a host address only.

**Default** Not configured

**Command Mode** IPV6-ACL

**Usage Information** OS10 cannot count both packets and bytes; when you use the `count` `byte` options, only bytes increment. The `no` version of this command removes the filter.

**Example**

```
OS10(config)# ipv6 access-list ipv6test
OS10(conf-ipv6-acl)# deny ipv6 any any capture session 1
```

**Supported Releases** 10.2.0E or later

## deny tcp

Configures a filter that drops Transmission Control Protocol (TCP) packets meeting the filter criteria.

**Syntax** `deny tcp [A.B.C.D | A.B.C.D/x | any | host ip-address [operator]] [[A.B.C.D | A.B.C.D/x | any | host ip-address [operator]] [ack | fin | psh | rst | syn | urg] [capture | count | dscp value | fragment | log]`

## Parameters

- `A.B.C.D` — Enter the IPv4 address in A.B.C.D format.
- `A.B.C.D/x` — Enter the number of bits to match in A.B.C.D/x format.
- `any` — (Optional) Enter the keyword `any` to specify any source or destination IP address.
- `host ip-address` — (Optional) Enter the keyword and the IPv4 address to use a host address only.
- `ack` — (Optional) Set the bit as acknowledgement.
- `fin` — (Optional) Set the bit as finish—no more data from sender.
- `psh` — (Optional) Set the bit as push.
- `rst` — (Optional) Set the bit as reset.
- `syn` — (Optional) Set the bit as synchronize.
- `urg` — (Optional) Set the bit set as urgent.
- `capture` — (Optional) Capture packets the filter processes.
- `count` — (Optional) Count packets the filter processes.
- `byte` — (Optional) Count bytes the filter processes.
- `dscp value` — (Optional) Deny a packet based on the DSCP values, from 0 to 63.
- `fragment` — (Optional) Use ACLs to control packet fragments.
- `log` — (Optional) Enables ACL logging. Information about packets that match an ACL rule are logged.
- `operator` — (Optional) Enter a logical operator to match the packets on the specified port number. The following options are available:
  - `eq` — Equal to
  - `gt` — Greater than
  - `lt` — Lesser than
  - `neq` — Not equal to
  - `range` — Range of ports, including the specified port numbers.

## Default

Not configured

## Command Mode

IPV4-ACL

## Usage

OS10 cannot count both packets and bytes; when you use the `count` `byte` options, only bytes increment. The `no` version of this command removes the filter.

## Information

## Example

```
OS10(config)# ip access-list testflow
OS10(conf-ipv4-acl)# deny tcp any any capture session 1
```

## Supported Releases

10.2.0E or later

## deny tcp (IPv6)

Configures a filter that drops TCP IPv6 packets meeting the filter criteria.

## Syntax

```
deny tcp [A::B | A::B/x | any | host ipv6-address [operator]] [A::B | A:B/x
| any | host ipv6-address [operator]] [ack | fin | psh | rst | syn | urg]
[capture | count | dscp value | fragment | log]
```

## Parameters

- `A::B` — Enter the IPv6 address in hexadecimal format separated by colons.
- `A::B/x` — Enter the number of bits to match to the IPv6 address.
- `any` — (Optional) Enter the keyword `any` to specify any source or destination IP address.
- `host ipv6-address` — (Optional) Enter the IPv6 address to use a host address only.
- `capture` — (Optional) Capture packets the filter processes.
- `count` — (Optional) Count packets the filter processes.
- `byte` — (Optional) Count bytes the filter processes.
- `dscp value` — (Optional) Deny a packet based on the DSCP values, from 0 to 63.
- `fragment` — (Optional) Use ACLs to control packet fragments.
- `log` — (Optional) Enables ACL logging. Information about packets that match an ACL rule are logged.

- *operator* — (Optional) Enter a logical operator to match the packets on the specified port number. The following options are available:
  - *eq* — Equal to
  - *gt* — Greater than
  - *lt* — Lesser than
  - *neq* — Not equal to
  - *range* — Range of ports, including the specified port numbers.

**Default** Not configured

**Command Mode** IPV6-ACL

**Usage Information** OS10 cannot count both packets and bytes; when you use the `count` `byte` options, only bytes increment. The `no` version of this command removes the filter.

**Example**

```
OS10(config)# ipv6 access-list ipv6test
OS10(conf-ipv6-acl)# deny tcp any any capture session 1
```

**Supported Releases** 10.2.0E or later

## deny udp

Configures a filter to drop User Datagram Protocol (UDP) packets meeting the filter criteria.

**Syntax** `deny udp [A.B.C.D | A.B.C.D/x | any | host ip-address [operator]] [A.B.C.D | A.B.C.D/x | any | host ip-address [operator]] [ack | fin | psh | rst | syn | urg] [capture | count | dscp value | fragment | log]`

**Parameters**

- *A.B.C.D* — Enter the IPv4 address in dotted decimal format.
- *A.B.C.D/x* — Enter the number of bits to match to the dotted decimal address.
- *any* — (Optional) Enter the keyword *any* to specify any source or destination IP address.
- *host ip-address* — (Optional) Enter the IPv4 address to use a host address only.
- *ack* — (Optional) Set the bit as acknowledgement.
- *fin* — (Optional) Set the bit as finish—no more data from sender.
- *psh* — (Optional) Set the bit as push.
- *rst* — (Optional) Set the bit as reset.
- *syn* — (Optional) Set the bit as synchronize.
- *urg* — (Optional) Set the bit set as urgent.
- *capture* — (Optional) Capture packets the filter processes.
- *count* — (Optional) Count packets the filter processes.
- *byte* — (Optional) Count bytes the filter processes.
- *dscp value* — (Optional) Deny a packet based on the DSCP values, from 0 to 63.
- *fragment* — (Optional) Use ACLs to control packet fragments.
- *log* — (Optional) Enables ACL logging. Information about packets that match an ACL rule are logged.
- *operator* — (Optional) Enter a logical operator to match the packets on the specified port number. The following options are available:
  - *eq* — Equal to
  - *gt* — Greater than
  - *lt* — Lesser than
  - *neq* — Not equal to
  - *range* — Range of ports, including the specified port numbers.

**Default** Not configured

**Command Mode** IPV4-ACL

**Usage Information** OS10 cannot count both packets and bytes; when you use the `count` `byte` options, only bytes increment. The `no` version of this command removes the filter.

**Example**

```
OS10(config)# ip access-list testflow
OS10(conf-ipv4-acl)# deny udp any any capture session 1
```

**Supported Releases** 10.2.0E or later

## deny udp (IPv6)

Configures a filter to drop UDP IPv6 packets that match filter criteria.

**Syntax** `deny udp [A::B | A::B/x | any | host ipv6-address [operator]] [A::B | A:B/x | any | host ipv6-address [operator]] [ack | fin | psh | rst | syn | urg] [capture | count | dscp value | fragment | log]`

**Parameters**

- `A::B` — Enter the IPv6 address in hexadecimal format separated by colons.
- `A::B/x` — Enter the number of bits to match to the IPv6 address.
- `any` — (Optional) Enter the keyword `any` to specify any source or destination IP address.
- `host ipv6-address` — (Optional) Enter the keyword and the IPv6 address to use a host address only.
- `ack` — (Optional) Set the bit as acknowledgement.
- `fin` — (Optional) Set the bit as finish—no more data from sender.
- `psh` — (Optional) Set the bit as push.
- `rst` — (Optional) Set the bit as reset.
- `syn` — (Optional) Set the bit as synchronize.
- `urg` — (Optional) Set the bit set as urgent.
- `capture` — (Optional) Capture packets the filter processes.
- `count` — (Optional) Count packets the filter processes.
- `byte` — (Optional) Count bytes the filter processes.
- `dscp value` — (Optional) Deny a packet based on the DSCP values, from 0 to 63.
- `fragment` — (Optional) Use ACLs to control packet fragments.
- `log` — (Optional) Enables ACL logging. Information about packets that match an ACL rule are logged.
- `operator` — (Optional) Enter a logical operator to match the packets on the specified port number. The following options are available:
  - `eq` — Equal to
  - `gt` — Greater than
  - `lt` — Lesser than
  - `neq` — Not equal to
  - `range` — Range of ports, including the specified port numbers.

**Default** Not configured

**Command Mode** IPV6-ACL

**Usage Information** OS10 cannot count both packets and bytes; when you use the `count` `byte` options, only bytes increment. The `no` version of this command removes the filter.

**Example**

```
OS10(config)# ipv6 access-list ipv6test
OS10(conf-ipv6-acl)# deny udp any any capture session 1
```

**Supported Releases** 10.2.0E or later

## description

Configures an ACL description.

**Syntax** `description text`

**Parameters** `text` — Enter the description text string. A maximum of 80 characters.

**Default** Disabled

**Command Modes** IPV4-ACL, IPV6-ACL, MAC-ACL

**Usage Information**

- To use special characters as a part of the description string, enclose the string in double quotes.
- To use comma as a part of the description string add double back slash before the comma.
- The `no` version of this command deletes the ACL description.

**Example**

```
OS10(conf-ipv4-acl)# description ipacltest
```

**Supported Releases** 10.2.0E or later

## ip access-group

Configures an IPv4 access group.

**Syntax** `ip access-group access-list-name {in | out}`

**Parameters**

- `access-list-name` — Enter the name of an IPv4 access list. A maximum of 140 characters.
- `in` — Apply the ACL to incoming traffic.
- `out` — Apply the ACL to outgoing traffic.

**Default** Not configured

**Command Mode** INTERFACE  
CONTROL-PLANE

**Usage Information** Use this command in the CONTROL-PLANE mode to apply a control-plane ACL. Control-plane ACLs are only applied on the ingress traffic. By default, the control-plane ACL is applied to the front-panel ports as well as the management port. The `no` version of this command deletes the IPv4 ACL configuration.

**Example**

```
OS10(conf-if-eth1/1/8)# ip access-group testgroup in
```

**Example (Control-plane ACL)**

```
OS10# configure terminal
OS10(config)# control-plane
OS10(config-control-plane)# ip access-group aaa-cp-acl in
```

**Supported Releases** 10.2.0E or later; 10.4.1 or later (control-plane ACL)

## ip access-list

Creates an IP access list to filter based on an IP address.

**Syntax** `ip access-list access-list-name`

**Parameters** `access-list-name` — Enter the name of an IPv4 access list. A maximum of 140 characters.

**Default** Not configured

**Command Mode** CONFIGURATION

**Usage Information** None

**Example**

```
OS10(config)# ip access-list acl1
```

**Supported Releases** 10.2.0E or later

## ip as-path access-list

Create an AS-path ACL filter for BGP routes using a regular expression.

**Syntax** `ip as-path access-list name {deny | permit} regexp-string`

**Parameters**

- `name` — Enter an access list name.
- `deny | permit` — Reject or accept a matching route.
- `regexp-string` — Enter a regular expression string to match an AS-path route attribute.

**Defaults** Not configured

**Command Mode** CONFIGURATION

**Usage Information** You can specify an access-list filter on inbound and outbound BGP routes. The ACL filter consists of regular expressions. If a regular expression matches an AS path attribute in a BGP route, the route is rejected or accepted. The AS path does not contain the local AS number. The `no` version of this command removes a single access list entry if you specify `deny` and a `regexp`. Otherwise, the entire access list is removed.

The question mark (?) character is not supported in the regular expressions. All other special characters are supported. When you are using backslash (\) or double quotes (") in the regular expression, precede these characters with backslash (\). For example, enter \\ or \".

**Example**

```
OS10(config)# ip as-path access-list abc deny 123
```

**Supported Release** 10.3.0E or later

## ip community-list standard deny

Creates a standard community list for BGP to deny access.

**Syntax** `ip community-list standard name deny {aa:nn | no-advertise | local-AS | no-export | internet}`

**Parameters**

- `name` — Enter the name of the standard community list used to identify one more deny groups of communities.
- `aa:nn` — Enter the community number in the format `aa:nn`, where `aa` is the number that identifies the autonomous system and `nn` is a number the identifies the community within the autonomous system.
- `no-advertise` — BGP does to not advertise this route to any internal or external peer.
- `local-AS` — BGP does not advertise this route to external peers.
- `no-export` — BGP does not advertise this route outside a BGP confederation boundary.
- `internet` — BGP does not advertise this route to an Internet community.

**Defaults** Not configured

**Command Mode** CONFIGURATION

**Usage Information** The `no` version of this command removes the community list.



**Example**

```
OS10(config)# ip community-list standard STD_LIST deny local-AS
```

**Supported Release**

10.3.0E or later

## ip community-list standard permit

Creates a standard community list for BGP to permit access.

**Syntax**

```
ip community-list standard name permit {aa:nn | no-advertise | local-as | no-export | internet}
```

**Parameters**

- **name** — Enter the name of the standard community list used to identify one more deny groups of communities.
- *aa:nn* — Enter the community number in the format *aa:nn*, where *aa* is the number that identifies the autonomous system and *nn* is a number the identifies the community within the autonomous system.
- *no-advertise* — BGP does not advertise this route to any internal or external peer.
- *local-as* — BGP does not advertise this route to external peers.
- *no-export* — BGP does not advertise this route outside a BGP confederation boundary
- *internet* — BGP does not advertise this route to an Internet community.

**Defaults**

Not configured

**Command Mode**

CONFIGURATION

**Usage**

The no version of this command removes the community list.

**Information****Example**

```
OS10(config)# ip community-list standard STD_LIST permit local-AS
```

**Supported Release**

10.3.0E or later

## ip extcommunity-list standard deny

Creates an extended community list for BGP to deny access.

**Syntax**

```
ip extcommunity-list standard name deny {4byteas-generic | rt | soo}
```

**Parameters**

- *name* — Enter the name of the community list used to identify one or more deny groups of extended communities.
- *4byteas-generic*—Enter the generic extended community then the keyword *transitive* or *non-transitive*.
- *rt* — Enter the route target.
- *soo* — Enter the route origin or site-of-origin.

**Defaults**

Not configured

**Command Mode**

CONFIGURATION

**Usage**

The no version of this command removes the extended community list.

**Information****Example**

```
OS10(config)# ip extcommunity-list standard STD_LIST deny 4byteas-generic transitive 1.65534:40
```

**Supported Release**

10.3.0E or later

## ip extcommunity-list standard permit

Creates an extended community list for BGP to permit access.

**Syntax** `ip extcommunity-list standard name permit {4byteas-generic | rt | soo}`

- Parameters**
- *name* — Enter the name of the community list used to identify one or more permit groups of extended communities.
  - *rt* — Enter the route target.
  - *soo* — Enter the route origin or site-of-origin.

**Defaults** Not configured

**Command Mode** CONFIGURATION

**Usage Information** The `no` version of this command removes the extended community list.

**Example**

```
OS10(config)# ip extcommunity-list standard STD_LIST permit 4byteas-generic transitive 1.65412:60
```

**Supported Release** 10.3.0E or later

## ip prefix-list description

Configures a description of an IP prefix list.

**Syntax** `ip prefix-list name description`

- Parameters**
- *name* — Enter the name of the prefix list.
  - *description* — Enter the description for the named prefix list.

**Defaults** Not configured

**Command Mode** CONFIGURATION

**Usage Information** The `no` version of this command removes the specified prefix list.

**Example**

```
OS10(config)# ip prefix-list TEST description TEST_LIST
```

**Supported Release** 10.3.0E or later

## ip prefix-list deny

Creates a prefix list to deny route filtering from a specified network address.

**Syntax** `ip prefix-list name deny [A.B.C.D/x [ge | le]] prefix-len`

- Parameters**
- *name* — Enter the name of the prefix list.
  - *A.B.C.D/x* — (Optional) Enter the source network address and mask in /prefix format (/x).
  - *ge* — Enter to indicate the network address is greater than or equal to the range specified.
  - *le* — Enter to indicate the network address is less than or equal to the range specified.
  - *prefix-len* — Enter the prefix length.

**Defaults** Not configured

**Command Mode** CONFIGURATION

**Usage Information** The no version of this command removes the specified prefix-list.

**Example**

```
OS10(config)# ip prefix-list denyprefix deny 10.10.10.2/16 le 30
```

**Supported Release** 10.3.0E or later

## ip prefix-list permit

Creates a prefix-list to permit route filtering from a specified network address.

**Syntax** `ip prefix-list name permit [A.B.C.D/x [ge | le]] prefix-len`

**Parameters**

- *name* — Enter the name of the prefix list.
- *A.B.C.D/x* — (Optional) Enter the source network address and mask in /prefix format (/x).
- *ge* — Enter to indicate the network address is greater than or equal to the range specified.
- *le* — Enter to indicate the network address is less than or equal to the range specified.
- *prefix-len* — Enter the prefix length.

**Defaults** Not configured

**Command Mode** CONFIGURATION

**Usage Information** The no version of this command removes the specified prefix-list.

**Example**

```
OS10(config)# ip prefix-list allowprefix permit 10.10.10.1/16 ge 10
```

**Supported Release** 10.3.0E or later

## ip prefix-list seq deny

Configures a filter to deny route filtering from a specified prefix list.

**Syntax** `ip prefix-list name seq num deny {A.B.C.D/x [ge | le] prefix-len}`

**Parameters**

- *name* — Enter the name of the prefix list.
- *num* — Enter the sequence list number.
- *A.B.C.D/x* — Enter the source network address and mask in /prefix format (/x).
- *ge* — Enter to indicate the network address is greater than or equal to the range specified.
- *le* — Enter to indicate the network address is less than or equal to the range specified.
- *prefix-len* — Enter the prefix length.

**Defaults** Not configured

**Command Mode** CONFIGURATION

**Usage Information** The no version of this command removes the specified prefix list.

**Example**

```
OS10(config)# ip prefix-list seqprefix seq 65535 deny 10.10.10.1/16 ge 10
```

**Supported Release** 10.3.0E or later

## ip prefix-list seq permit

Configures a filter to permit route filtering from a specified prefix list.

**Syntax** `ipv6 prefix-list [name] seq num permit A::B/x [ge | le] prefix-len`

- Parameters**
- *name* — Enter the name of the prefix list.
  - *num* — Enter the sequence list number.
  - *A.B.C.D/x* — Enter the source network address and mask in /prefix format (/x).
  - *ge* — Enter to indicate the network address is greater than or equal to the range specified.
  - *le* — Enter to indicate the network address is less than or equal to the range specified.
  - *prefix-len* — Enter the prefix length.

**Defaults** Not configured

**Command Mode** CONFIGURATION

**Usage Information** The no version of this command removes the specified prefix list.

**Example**

```
OS10(config)# ip prefix-list seqprefix seq 65535 permit 10.10.10.1/16 le 30
```

**Supported Release** 10.3.0E or later

## ipv6 access-group

Configures an IPv6 access group.

**Syntax** `ipv6 access-group access-list-name {in | out}`

- Parameters**
- *access-list-name* — Enter the name of an IPv6 ACL. A maximum of 140 characters.
  - *in* — Apply the ACL to incoming traffic.
  - *out* — Apply the ACL to outgoing traffic.

**Default** Not configured

**Command Mode** INTERFACE  
CONTROL-PLANE

**Usage Information** Use this command in the CONTROL-PLANE mode to apply a control-plane ACL. Control-plane ACLs are only applied on the ingress traffic. By default, the control-plane ACL is applied to the front-panel ports as well as the management port. The no version of this command deletes an IPv6 ACL configuration.

**Example**

```
OS10(conf-if-eth1/1/8)# ipv6 access-group test6 in
```

**Example (Control-plane ACL)**

```
OS10# configure terminal
OS10(config)# control-plane
OS10(config-control-plane)# ipv6 access-group aaa-cp-acl in
```

**Supported Releases** 10.2.0E or later; 10.4.1 or later (control-plane ACL)

## ipv6 access-list

Creates an IP access list to filter based on an IPv6 address.

**Syntax** `ipv6 access-list access-list-name`

|                          |                                                                                               |
|--------------------------|-----------------------------------------------------------------------------------------------|
| <b>Parameters</b>        | <i>access-list-name</i> — Enter the name of an IPv6 access list. A maximum of 140 characters. |
| <b>Default</b>           | Not configured                                                                                |
| <b>Command Mode</b>      | CONFIGURATION                                                                                 |
| <b>Usage Information</b> | None                                                                                          |
| <b>Example</b>           | <pre>OS10(config)# ipv6 access-list acl6</pre>                                                |
| <b>Supported Release</b> | 10.2.0E or later                                                                              |

## ipv6 prefix-list deny

Creates a prefix list to deny route filtering from a specified IPv6 network address.

|                          |                                                                                                                                                                                                                                                                                                                                                                                                                                       |
|--------------------------|---------------------------------------------------------------------------------------------------------------------------------------------------------------------------------------------------------------------------------------------------------------------------------------------------------------------------------------------------------------------------------------------------------------------------------------|
| <b>Syntax</b>            | <code>ipv6 prefix-list <i>prefix-list-name</i> deny {A::B/x [ge   le] <i>prefix-len</i>}</code>                                                                                                                                                                                                                                                                                                                                       |
| <b>Parameters</b>        | <ul style="list-style-type: none"> <li>• <i>prefix-list-name</i> — Enter the IPv6 prefix list name.</li> <li>• A::B/x — Enter the IPv6 address to deny.</li> <li>• ge — Enter to indicate the network address is greater than or equal to the range specified.</li> <li>• le — Enter to indicate the network address is less than or equal to the range specified.</li> <li>• <i>prefix-len</i> — Enter the prefix length.</li> </ul> |
| <b>Defaults</b>          | Not configured                                                                                                                                                                                                                                                                                                                                                                                                                        |
| <b>Command Mode</b>      | CONFIGURATION                                                                                                                                                                                                                                                                                                                                                                                                                         |
| <b>Usage Information</b> | The no version of this command removes the specified prefix list.                                                                                                                                                                                                                                                                                                                                                                     |
| <b>Example</b>           | <pre>OS10(config)# ipv6 prefix-list TEST deny AB10::1/128 ge 10 le 30</pre>                                                                                                                                                                                                                                                                                                                                                           |
| <b>Supported Release</b> | 10.3.0E or later                                                                                                                                                                                                                                                                                                                                                                                                                      |

## ipv6 prefix-list description

Configures a description of an IPv6 prefix-list.

|                          |                                                                                                                                                                                     |
|--------------------------|-------------------------------------------------------------------------------------------------------------------------------------------------------------------------------------|
| <b>Syntax</b>            | <code>ipv6 prefix-list name <i>description</i></code>                                                                                                                               |
| <b>Parameters</b>        | <ul style="list-style-type: none"> <li>• name — Enter the name of the IPv6 prefix-list.</li> <li>• <i>description</i> — Enter the description for the named prefix-list.</li> </ul> |
| <b>Defaults</b>          | Not configured                                                                                                                                                                      |
| <b>Command Mode</b>      | CONFIGURATION                                                                                                                                                                       |
| <b>Usage Information</b> | The no version of this command removes the specified prefix list.                                                                                                                   |
| <b>Example</b>           | <pre>OS10(config)# ipv6 prefix-list TEST description TEST_LIST</pre>                                                                                                                |
| <b>Supported Release</b> | 10.3.0E or later                                                                                                                                                                    |

## ipv6 prefix-list permit

Creates a prefix-list to permit route filtering from a specified IPv6 network address.

**Syntax** `ipv6 prefix-list prefix-list-name permit {A::B/x [ge | le] prefix-len}`

- Parameters**
- *prefix-list-name* — Enter the IPv6 prefix-list name.
  - A::B/x — Enter the IPv6 address to permit.
  - ge — Enter to indicate the network address is greater than or equal to the range specified.
  - le — Enter to indicate the network address is less than or equal to the range specified.
  - *prefix-len* — Enter the prefix length.

**Defaults** Not configured

**Command Mode** CONFIGURATION

**Usage Information** The no version of this command removes the specified prefix-list.

**Example**

```
OS10(config)# ipv6 prefix-list TEST permit AB20::1/128 ge 10 le 30
```

**Supported Release** 10.3.0E or later

## ipv6 prefix-list seq deny

Configures a filter to deny route filtering from a specified prefix-list.

**Syntax** `ipv6 prefix-list [name] seq num deny {A::B/x [ge | le] prefix-len}`

- Parameters**
- *name* — (Optional) Enter the name of the IPv6 prefix-list.
  - *num* — Enter the sequence number of the specified IPv6 prefix-list.
  - A::B/x — Enter the IPv6 address and mask in /prefix format (/x).
  - ge — Enter to indicate the network address is greater than or equal to the range specified.
  - le — Enter to indicate the network address is less than or equal to the range specified.
  - *prefix-len* — Enter the prefix length.

**Defaults** Not configured

**Command Mode** CONFIGURATION

**Usage Information** The no version of this command removes the specified prefix-list.

**Example**

```
OS10(config)# ipv6 prefix-list TEST seq 65535 deny AB20::1/128 ge 10
```

**Supported Release** 10.3.0E or later

## ipv6 prefix-list seq permit

Configures a filter to permit route filtering from a specified prefix-list.

**Syntax** `ipv6 prefix-list [name] seq num permit A::B/x [ge | le] prefix-len`

- Parameters**
- *name* — (Optional) Enter the name of the IPv6 prefix-list.
  - *num* — Enter the sequence number of the specified IPv6 prefix list.
  - A::B/x — Enter the IPv6 address and mask in /prefix format (/x).
  - ge — Enter to indicate the network address is greater than or equal to the range specified.

- *le* — Enter to indicate the network address is less than or equal to the range specified.
- *prefix-len* — Enter the prefix length.

|                          |                                                                                   |
|--------------------------|-----------------------------------------------------------------------------------|
| <b>Defaults</b>          | Not configured                                                                    |
| <b>Command Mode</b>      | CONFIGURATION                                                                     |
| <b>Usage Information</b> | The <code>no</code> version of this command removes the specified prefix-list.    |
| <b>Example</b>           | <pre>OS10(config)# ipv6 prefix-list TEST seq 65535 permit AB10::1/128 ge 30</pre> |
| <b>Supported Release</b> | 10.3.0E or later                                                                  |

## mac access-group

Configures a MAC access group.

|                                    |                                                                                                                                                                                                                                                                                          |
|------------------------------------|------------------------------------------------------------------------------------------------------------------------------------------------------------------------------------------------------------------------------------------------------------------------------------------|
| <b>Syntax</b>                      | <code>mac access-group access-list-name {in   out}</code>                                                                                                                                                                                                                                |
| <b>Parameters</b>                  | <ul style="list-style-type: none"> <li>• <i>access-list-name</i> — Enter the name of a MAC access list. A maximum of 140 characters.</li> <li>• <i>in</i> — Apply the ACL to incoming traffic.</li> <li>• <i>out</i> — Apply the ACL to outgoing traffic.</li> </ul>                     |
| <b>Default</b>                     | Not configured                                                                                                                                                                                                                                                                           |
| <b>Command Mode</b>                | CONFIGURATION<br>CONTROL-PLANE                                                                                                                                                                                                                                                           |
| <b>Usage Information</b>           | Use this command in the CONTROL-PLANE mode to apply a control-plane ACL. Control-plane ACLs are only applied on the ingress traffic. By default, the control-plane ACL is applied to the front-panel ports. The <code>no</code> version of this command resets the value to the default. |
| <b>Example</b>                     | <pre>OS10(config)# mac access-group maclist in OS10(conf-mac-acl)#</pre>                                                                                                                                                                                                                 |
| <b>Example (Control-plane ACL)</b> | <pre>OS10# configure terminal OS10(config)# control-plane OS10(config-control-plane)# mac access-group maclist in</pre>                                                                                                                                                                  |
| <b>Supported Releases</b>          | 10.2.0E or later; 10.4.1 or later (control-plane ACL)                                                                                                                                                                                                                                    |

## mac access-list

Creates a MAC access list to filter based on a MAC address.

|                          |                                                                                             |
|--------------------------|---------------------------------------------------------------------------------------------|
| <b>Syntax</b>            | <code>mac access-list access-list-name</code>                                               |
| <b>Parameters</b>        | <i>access-list-name</i> — Enter the name of a MAC access list. A maximum of 140 characters. |
| <b>Default</b>           | Not configured                                                                              |
| <b>Command Mode</b>      | CONFIGURATION                                                                               |
| <b>Usage Information</b> | None                                                                                        |
| <b>Example</b>           | <pre>OS10(config)# mac access-list maclist</pre>                                            |

**Supported Releases** 10.2.0E or later

## permit

Configures a filter to allow packets with a specific IPv4 address.

**Syntax** `permit [protocol-number | icmp | ip | tcp | udp] [A.B.C.D | A.B.C.D/x | any | host ip-address] [A.B.C.D | A.B.C.D/x | any | host ip-address] [capture | count | dscp value | fragment | log]`

- Parameters**
- *protocol-number* — (Optional) Enter the protocol number identified in the IP header, from 0 to 255.
  - *icmp* — (Optional) Enter the ICMP address to permit.
  - *ip* — (Optional) Enter the IPv4 address to permit.
  - *tcp* — (Optional) Enter the TCP address to permit.
  - *udp* — (Optional) Enter the UDP address to permit.
  - *A.B.C.D* — Enter the IPv4 address in dotted decimal format.
  - *A.B.C.D/x* — Enter the number of bits that must match the dotted decimal address.
  - *any* — (Optional) Enter the keyword *any* to specify any source or destination IP address.
  - *host ip-address* — (Optional) Enter the IPv4 address to use a host address only.
  - *capture* — (Optional) Capture packets the filter processes.
  - *count* — (Optional) Count packets the filter processes.
  - *byte* — (Optional) Count bytes the filter processes.
  - *dscp value* — (Optional) Permit a packet based on the DSCP values, from 0 to 63.
  - *fragment* — (Optional) Use ACLs to control packet fragments.
  - *log* — (Optional) Enables ACL logging. Information about packets that match an ACL rule are logged.

**Default** Not configured

**Command Mode** IPV4-ACL

**Usage Information** OS10 cannot count both packets and bytes; when you enter the `count` `byte` options, only bytes increment. The `no` version of this command removes the filter.

### Example

```
OS10(config)# ip access-list testflow
OS10(conf-ipv4-acl)# permit udp any any capture session 1
```

**Supported Releases** 10.2.0E or later

## permit (IPv6)

Configures a filter to allow packets with a specific IPv6 address.

**Syntax** `permit [protocol-number | icmp | ipv6 | tcp | udp] [A::B | A::B/x | any | host ipv6-address] [A::B | A:B/x | any | host ipv6-address] [capture | count | dscp value | fragment | log]`

- Parameters**
- *protocol-number* — (Optional) Enter the protocol number identified in the IPv6 header, from 0 to 255.
  - *icmp* — (Optional) Enter the ICMP address to permit.
  - *ipv6* — (Optional) Enter the IPv6 address to permit.
  - *tcp* — (Optional) Enter the TCP address to permit.
  - *udp* — (Optional) Enter the UDP address to permit.
  - *A::B* — Enter the IPv6 address in hexadecimal format separated by colons.
  - *A::B/x* — Enter the number of bits that must match the IPv6 address.



- `any` — (Optional) Enter the keyword `any` to specify any source or destination IP address.
- `host ip-address` — (Optional) Enter the IPv6 address to use a host address only.
- `capture` — (Optional) Capture packets the filter processes.
- `count` — (Optional) Count packets the filter processes.
- `byte` — (Optional) Count bytes the filter processes.
- `dscp value` — (Optional) Permit a packet based on the DSCP values, from 0 to 63.
- `fragment` — (Optional) Use ACLs to control packet fragments.
- `log` — (Optional) Enables ACL logging. Information about packets that match an ACL rule are logged.

**Default** Not configured

**Command Mode** IPV6-ACL

**Usage Information** OS10 cannot count both packets and bytes; when you enter the `count` `byte` options, only bytes increment. The `no` version of this command removes the filter.

**Example**

```
OS10(config)# ipv6 access-list ipv6test
OS10(conf-ipv6-acl)# permit udp any any capture session 1
```

**Supported Releases** 10.2.0E or later

## permit (MAC)

Configures a filter to allow packets with a specific MAC address.

**Syntax** `permit {nn:nn:nn:nn:nn:nn [00:00:00:00:00:00] | any} {nn:nn:nn:nn:nn:nn [00:00:00:00:00:00] | any} [protocol-number | capture | count [byte] | cos | vlan]`

**Parameters**

- `nn:nn:nn:nn:nn:nn` — Enter the MAC address.
- `00:00:00:00:00:00` — (Optional) Enter which bits in the MAC address must match. If you do not enter a mask, a mask of `00:00:00:00:00:00` applies.
- `any` — (Optional) Set which routes are subject to the filter:
  - `protocol-number` — Enter the MAC protocol number identified in the MAC header, from 600 to ffff.
  - `capture` — (Optional) Enter the capture packets the filter processes.
  - `count` — (Optional) Enter the count packets the filter processes.
  - `byte` — (Optional) Enter the count bytes the filter processes.
  - `cos` — (Optional) Enter the CoS value, from 0 to 7.
  - `vlan` — (Optional) Enter the VLAN number, from 1 to 4093.

**Default** Not configured

**Command Mode** MAC-ACL

**Usage Information** OS10 cannot count both packets and bytes; when you enter the `count` `byte` options, only bytes increment. The `no` version of this command removes the filter.

**Example**

```
OS10(config)# mac access-list macacl
OS10(conf-mac-acl)# permit 00:00:00:00:11:11 00:00:11:11:11:11 any cos 7
OS10(conf-mac-acl)# permit 00:00:00:00:11:11 00:00:11:11:11:11 any vlan 2
```

**Supported Releases** 10.2.0E or later

## permit icmp

Configures a filter to permit all or specific ICMP messages.

**Syntax** `permit icmp [A.B.C.D | A.B.C.D/x | any | host ip-address] [[A.B.C.D | A.B.C.D/x | any | host ip-address] [capture | count | dscp value | fragment | log]`

- Parameters**
- `A.B.C.D` — Enter the IPv4 address in dotted decimal format.
  - `A.B.C.D/x` — Enter the number of bits that must match the dotted decimal address.
  - `any` — (Optional) Enter the keyword `any` to specify any source or destination IP address.
  - `host ip-address` — (Optional) Enter the IPv4 address to use a host address only.
  - `capture` — (Optional) Capture packets the filter processes.
  - `count` — (Optional) Count packets the filter processes.
  - `byte` — (Optional) Count bytes the filter processes.
  - `dscp value` — (Optional) Permit a packet based on the DSCP values, from 0 to 63.
  - `fragment` — (Optional) Use ACLs to control packet fragments.
  - `log` — (Optional) Enables ACL logging. Information about packets that match an ACL rule are logged.

**Default** Not configured

**Command Mode** IPV4-ACL

**Usage Information** OS10 cannot count both packets and bytes; when you enter the `count` `byte` options, only bytes increment. The `no` version of this command removes the filter.

**Example**

```
OS10(config)# ip access-list testflow
OS10(conf-ipv4-acl)# permit icmp any any capture session 1
```

**Supported Releases** 10.2.0E or later

## permit icmp (IPv6)

Configures a filter to permit all or specific ICMP messages.

**Syntax** `permit icmp [A::B | A::B/x | any | host ipv6-address] [A::B | A:B/x | any | host ipv6-address] [capture | count | dscp value | fragment | log]`

- Parameters**
- `A::B` — Enter the IPv6 address in hexadecimal format separated by colons.
  - `A::B/x` — Enter the number of bits that must match the IPv6 address.
  - `any` — (Optional) Enter the keyword `any` to specify any source or destination IP address.
  - `host ipv6-address` — (Optional) Enter the IPv6 address to use a host address only.
  - `capture` — (Optional) Capture packets the filter processes.
  - `count` — (Optional) Count packets the filter processes.
  - `byte` — (Optional) Count bytes the filter processes.
  - `dscp value` — (Optional) Permit a packet based on the DSCP values, from 0 to 63.
  - `fragment` — (Optional) Use ACLs to control packet fragments.
  - `log` — (Optional) Enables ACL logging. Information about packets that match an ACL rule are logged.

**Default** Not configured

**Command Mode** IPV6-ACL

**Usage Information** OS10 cannot count both packets and bytes; when you enter the `count` `byte` options, only bytes increment. The `no` version of this command removes the filter.

**Example**

```
OS10(config)# ipv6 access-list ipv6test
OS10(conf-ipv6-acl)# permit icmp any any capture session 1
```

**Supported Releases** 10.2.0E or later

## permit ip

Configures a filter to permit all or specific packets from an IPv4 address.

**Syntax** `permit ip [A.B.C.D | A.B.C.D/x | any | host ip-address] [[A.B.C.D | A.B.C.D/x | any | host ip-address] [capture | count | dscp value | fragment | log]`

- Parameters**
- `A.B.C.D` — Enter the IPv4 address in dotted decimal format.
  - `A.B.C.D/x` — Enter the number of bits to match to the dotted decimal address.
  - `any` — (Optional) Enter the keyword `any` to specify any source or destination IP address.
  - `host ip-address` — (Optional) Enter the IPv4 address to use a host address only.
  - `capture` — (Optional) Capture packets the filter processes.
  - `count` — (Optional) Count packets the filter processes.
  - `byte` — (Optional) Count bytes the filter processes.
  - `dscp value` — (Optional) Permit a packet based on the DSCP values, from 0 to 63.
  - `fragments` — (Optional) Use ACLs to control packet fragments.
  - `log` — (Optional) Enables ACL logging. Information about packets that match an ACL rule are logged.

**Default** Not configured

**Command Mode** IPV4-ACL

**Usage Information** OS10 cannot count both packets and bytes; when you enter the `count byte` options, only bytes increment. The `no` version of this command removes the filter.

**Example**

```
OS10(conf-ipv4-acl)# permit ip any any capture session 1
```

**Supported Releases** 10.2.0E or later

## permit ipv6

Configures a filter to permit all or specific packets from an IPv6 address.

**Syntax** `permit ipv6 [A::B | A::B/x | any | host ipv6-address] [A::B | A:B/x | any | host ipv6-address] [capture | count | dscp value | fragment | log]`

- Parameters**
- `A::B` — (Optional) Enter the source IPv6 address from which the packet was sent and the destination address.
  - `A::B/x` — (Optional) Enter the source network mask in /prefix format (/x) and the destination mask.
  - `any` — (Optional) Enter the keyword `any` to specify any source or destination IP address.
  - `host ipv6-address` — Enter the IPv6 address to use a host address only.
  - `capture` — (Optional) Enter to capture packets the filter processes.
  - `count` — (Optional) Enter to count packets the filter processes.
  - `byte` — (Optional) Enter to count bytes the filter processes.
  - `dscp value` — (Optional) Enter to deny a packet based on the DSCP values, from 0 to 63.
  - `fragment` — (Optional) Enter to use ACLs to control packet fragments.
  - `log` — (Optional) Enables ACL logging. Information about packets that match an ACL rule are logged.

**Default** Not configured

**Command Mode** IPV6-ACL

**Usage Information** OS10 cannot count both packets and bytes; when you enter the `count` `byte` options, only bytes increment. The `no` version of this command removes the filter.

**Example**

```
OS10(conf-ipv6-acl)# permit ipv6 any any count capture session 1
```

**Supported Releases** 10.2.0E or later

## permit tcp

Configures a filter to permit TCP packets meeting the filter criteria.

**Syntax**

```
permit tcp [A.B.C.D | A.B.C.D/x | any | host ip-address [operator]]
[[A.B.C.D | A.B.C.D/x | any | host ip-address [operator]] [ack | fin | psh
| rst | syn | urg] [capture | count | dscp value | fragment | log]
```

### Parameters

- `A.B.C.D` — Enter the IPv4 address in dotted decimal format.
- `A.B.C.D/x` — Enter the number of bits that must match the dotted decimal address.
- `any` — (Optional) Enter the keyword `any` to specify any source or destination IP address.  
**NOTE:** The control-plane ACLs do not support the `any` parameter.
- `host ip-address` — (Optional) Enter the IPv4 address to use a host address only.
- `ack` — (Optional) Set the bit as acknowledgement.
- `fin` — (Optional) Set the bit as finish—no more data from sender.
- `psh` — (Optional) Set the bit as push.
- `rst` — (Optional) Set the bit as reset.
- `syn` — (Optional) Set the bit as synchronize.
- `urg` — (Optional) Set the bit set as urgent.
- `capture` — (Optional) Capture packets the filter processes.
- `count` — (Optional) Count packets the filter processes.
- `byte` — (Optional) Count bytes the filter processes.
- `dscp value` — (Optional) Permit a packet based on the DSCP values, 0 to 63.
- `fragment` — (Optional) Use ACLs to control packet fragments.
- `log` — (Optional) Enables ACL logging. Information about packets that match an ACL rule are logged.
- `operator` — (Optional) Enter a logical operator to match the packets on the specified port number. The following options are available:
  - `eq` — Equal to
  - `gt` — Greater than
  - `lt` — Lesser than
  - `neq` — Not equal to
  - `range` — Range of ports, including the specified port numbers.

**NOTE:** The control-plane ACLs support only the `eq` operator.

**Default** Not configured

**Command Mode** IPV4-ACL

**Usage Information** OS10 cannot count both packets and bytes; when you enter the `count` `byte` options, only bytes increment. The `no` version of this command removes the filter.

**Example**

```
OS10(conf-ipv4-acl)# permit tcp any any capture session 1
```

**Supported Releases** 10.2.0E or later

## permit tcp (IPv6)

Configures a filter to permit TCP packets meeting the filter criteria.

**Syntax** `permit tcp [A::B | A::B/x | any | host ipv6-address [eq | lt | gt | neq | range]] [A::B | A::B/x | any | host ipv6-address [eq | lt | gt | neq | range]] [ack | fin | psh | rst | syn | urg] [capture | count | dscp value | fragment | log]`

- Parameters**
- `A::B` — Enter the IPv6 address in hexadecimal format separated by colons.
  - `A::B/x` — Enter the number of bits that must match the IPv6 address.
  - `any` — (Optional) Enter the keyword `any` to specify any source or destination IP address.  
 **NOTE:** The control-plane ACLs do not support the `any` parameter.
  - `host ipv6-address` — (Optional) Enter the IPv6 address to use a host address only.
  - `capture` — (Optional) Capture packets the filter processes.
  - `count` — (Optional) Count packets the filter processes.
  - `byte` — (Optional) Count bytes the filter processes.
  - `dscp value` — (Optional) Permit a packet based on the DSCP values, from 0 to 63.
  - `fragment` — (Optional) Use ACLs to control packet fragments.
  - `log` — (Optional) Enables ACL logging. Information about packets that match an ACL rule are logged.

**Default** Not configured

**Command Mode** IPV6-ACL

**Usage Information** OS10 cannot count both packets and bytes; when you enter the `count` `byte` options, only bytes increment. The `no` version of this command removes the filter.

**Example**

```
OS10(config)# ipv6 access-list ipv6test
OS10(conf-ipv6-acl)# permit tcp any any capture session 1
```

**Supported Releases** 10.2.0E or later

## permit udp

Configures a filter that allows UDP packets meeting the filter criteria.

**Syntax** `permit udp [A.B.C.D | A.B.C.D/x | any | host ip-address [eq | lt | gt | neq | range]] [[A.B.C.D | A.B.C.D/x | any | host ip-address [eq | lt | gt | neq | range]] [ack | fin | psh | rst | syn | urg] [capture | count | dscp value | fragment | log]`

- Parameters**
- `A.B.C.D` — Enter the IPv4 address in dotted decimal format.
  - `A.B.C.D/x` — Enter the number of bits that must match the dotted decimal address.
  - `any` — (Optional) Enter the keyword `any` to specify any source or destination IP address.
  - `host ip-address` — (Optional) Enter the IPv4 address to use a host address only.
  - `ack` — (Optional) Set the bit as acknowledgement.
  - `fin` — (Optional) Set the bit as finish—no more data from sender.
  - `psh` — (Optional) Set the bit as push.
  - `rst` — (Optional) Set the bit as reset.
  - `syn` — (Optional) Set the bit as synchronize.
  - `urg` — (Optional) Set the bit set as urgent.
  - `capture` — (Optional) Capture packets the filter processes.
  - `count` — (Optional) Count packets the filter processes.
  - `byte` — (Optional) Count bytes filter processes.
  - `dscp value` — (Optional) Permit a packet based on the DSCP values, from 0 to 63.

- `fragment` — (Optional) Use ACLs to control packet fragments.
  - `log` — (Optional) Enables ACL logging. Information about packets that match an ACL rule are logged.
  - `operator` — (Optional) Enter a logical operator to match the packets on the specified port number. The following options are available:
    - `eq` — (Optional) Permit packets which are equal to.
    - `lt` — (Optional) Permit packets which are less than.
    - `gt` — (Optional) Permit packets which are greater than.
    - `neq` — (Optional) Permit packets which are not equal to.
    - `range` — (Optional) Permit packets with a specific source and destination address.
-  **NOTE:** The control-plane ACL supports only the `eq` operator.

**Default** Not configured

**Command Mode** IPv4-ACL

**Usage Information** OS10 cannot count both packets and bytes; when you enter the `count` `byte` options, only bytes increment. The `no` version of this command removes the filter.

**Example**

```
OS10(config)# ip access-list testflow
OS10(conf-ipv4-acl)# permit udp any any capture session 1
```

**Supported Releases** 10.2.0E or later

## permit udp (IPv6)

Configures a filter to permit UDP packets meeting the filter criteria.

**Syntax** `permit udp [A::B | A::B/x | any | host ipv6-address [operator]] [A::B | A::B/x | any | host ipv6-address [operator]] [ack | fin | psh | rst | syn | urg] [capture | count | dscp value | fragment | log]`

**Parameters**

- `A::B` — Enter the IPv6 address in hexadecimal format separated by colons.
- `A::B/x` — Enter the number of bits that must match the IPv6 address.
- `any` — (Optional) Enter the keyword `any` to specify any source or destination IP address.
  -  **NOTE:** The control-plane ACL supports only the `eq` operator.
- `host ipv6-address` — (Optional) Enter the keyword and the IPv6 address to use a host address only.
- `ack` — (Optional) Set the bit as acknowledgement.
- `fin` — (Optional) Set the bit as finish—no more data from sender.
- `psh` — (Optional) Set the bit as push.
- `rst` — (Optional) Set the bit as reset.
- `syn` — (Optional) Set the bit as synchronize.
- `urg` — (Optional) Set the bit set as urgent.
- `capture` — (Optional) Capture packets the filter processes.
- `count` — (Optional) Count packets the filter processes.
- `byte` — (Optional) Count bytes the filter processes.
- `dscp value` — (Optional) Permit a packet based on the DSCP values, from 0 to 63.
- `fragment` — (Optional) Use ACLs to control packet fragments.
- `log` — (Optional) Enables ACL logging. Information about packets that match an ACL rule are logged.
- `operator` — (Optional) Enter a logical operator to match the packets on the specified port number. The following options are available:
  - `eq` — Equal to
  - `gt` — Greater than
  - `lt` — Lesser than

- o `neq` — Not equal to
- o `range` — Range of ports, including the specified port numbers.

|                           |                                                                                                                                                                                                  |
|---------------------------|--------------------------------------------------------------------------------------------------------------------------------------------------------------------------------------------------|
| <b>Default</b>            | Not configured                                                                                                                                                                                   |
| <b>Command Mode</b>       | IPV6-ACL                                                                                                                                                                                         |
| <b>Usage Information</b>  | OS10 cannot count both packets and bytes; when you enter the <code>count</code> <code>byte</code> options, only bytes increment. The <code>no</code> version of this command removes the filter. |
| <b>Example</b>            | <pre>OS10(conf-ipv6-acl)# permit udp any any capture session 1 count</pre>                                                                                                                       |
| <b>Supported Releases</b> | 10.2.0E or later                                                                                                                                                                                 |

## remark

Specifies an ACL entry description.

|                           |                                                                                                                                                |
|---------------------------|------------------------------------------------------------------------------------------------------------------------------------------------|
| <b>Syntax</b>             | <code>remark description</code>                                                                                                                |
| <b>Parameters</b>         | <code>description</code> — Enter a description. A maximum of 80 characters.                                                                    |
| <b>Default</b>            | Not configured                                                                                                                                 |
| <b>Command Mode</b>       | IPV4-ACL                                                                                                                                       |
| <b>Usage Information</b>  | Configure up to 16777214 remarks for a given IPv4, IPv6, or MAC. The <code>no</code> version of the command removes the ACL entry description. |
| <b>Supported Releases</b> | 10.2.0E or later                                                                                                                               |

## seq deny

Assigns a sequence number to deny IPv4 addresses while creating the filter.

|                   |                                                                                                                                                                                                                                                                                                                                                                                                                                                                                                                                                                                                                                                                                                                                                                                                                                                                                                                                                                                                                                                                                                                                                                                                                                                                                                                                                                                                                                                                                                                                                                                                                      |
|-------------------|----------------------------------------------------------------------------------------------------------------------------------------------------------------------------------------------------------------------------------------------------------------------------------------------------------------------------------------------------------------------------------------------------------------------------------------------------------------------------------------------------------------------------------------------------------------------------------------------------------------------------------------------------------------------------------------------------------------------------------------------------------------------------------------------------------------------------------------------------------------------------------------------------------------------------------------------------------------------------------------------------------------------------------------------------------------------------------------------------------------------------------------------------------------------------------------------------------------------------------------------------------------------------------------------------------------------------------------------------------------------------------------------------------------------------------------------------------------------------------------------------------------------------------------------------------------------------------------------------------------------|
| <b>Syntax</b>     | <code>seq sequence-number deny [protocol-number   icmp   ip   tcp   udp] [A.B.C.D   A.B.C.D/x   any   host ip-address] [A.B.C.D   A.B.C.D/x   any   host ip-address] [capture   count   dscp value   fragment   log]</code>                                                                                                                                                                                                                                                                                                                                                                                                                                                                                                                                                                                                                                                                                                                                                                                                                                                                                                                                                                                                                                                                                                                                                                                                                                                                                                                                                                                          |
| <b>Parameters</b> | <ul style="list-style-type: none"> <li>• <code>sequence-number</code> — Enter the sequence number to identify the ACL for editing and sequencing number, from 1 to 16777214.</li> <li>• <code>protocol-number</code> — (Optional) Enter the protocol number, from 0 to 255.</li> <li>• <code>icmp</code> — (Optional) Enter the ICMP address to deny.</li> <li>• <code>ip</code> — (Optional) Enter the IPv4 address to deny.</li> <li>• <code>tcp</code> — (Optional) Enter the TCP address to deny.</li> <li>• <code>udp</code> — (Optional) Enter the UDP address to deny.</li> <li>• <code>A.B.C.D</code> — (Optional) Enter the IPv4 address in dotted decimal format.</li> <li>• <code>A.B.C.D/x</code> — (Optional) Enter the number of bits that must match the dotted decimal address.</li> <li>• <code>any</code> — (Optional) Enter the keyword <code>any</code> to specify any source or destination IP address.</li> <li>• <code>host ip-address</code> — (Optional) Enter the IPv4 address to use a host address only.</li> <li>• <code>capture</code> — (Optional) Capture packets the filter processes.</li> <li>• <code>count</code> — (Optional) Count packets the filter processes.</li> <li>• <code>byte</code> — (Optional) Count bytes the filter processes.</li> <li>• <code>dscp value</code> — (Optional) Permit a packet based on the DSCP values, from 0 to 63.</li> <li>• <code>fragment</code> — (Optional) Use ACLs to control packet fragments.</li> <li>• <code>log</code> — (Optional) Enables ACL logging. Information about packets that match an ACL rule are logged.</li> </ul> |
| <b>Default</b>    | Not configured                                                                                                                                                                                                                                                                                                                                                                                                                                                                                                                                                                                                                                                                                                                                                                                                                                                                                                                                                                                                                                                                                                                                                                                                                                                                                                                                                                                                                                                                                                                                                                                                       |

|                           |                                                                                                                                                                                                                                                                                                   |
|---------------------------|---------------------------------------------------------------------------------------------------------------------------------------------------------------------------------------------------------------------------------------------------------------------------------------------------|
| <b>Command Mode</b>       | IPV4-ACL                                                                                                                                                                                                                                                                                          |
| <b>Usage Information</b>  | OS10 cannot count both packets and bytes; when you enter the <code>count</code> <code>byte</code> options, only bytes increment. The <code>no</code> version of this command removes the filter, or use the <code>no seq sequence-number</code> command if you know the filter's sequence number. |
| <b>Example</b>            | <pre>OS10(config)# ip access-list testflow OS10(conf-ipv4-acl)# seq 10 deny tcp any any capture session 1 log</pre>                                                                                                                                                                               |
| <b>Supported Releases</b> | 10.2.0E or later                                                                                                                                                                                                                                                                                  |

## seq deny (IPv6)

Assigns a sequence number to deny IPv6 addresses while creating the filter.

|                           |                                                                                                                                                                                                                                                                                                                                                                                                                                                                                                                                                                                                                                                                                                                                                                                                                                                                                                                                                                                                                                                                                                                                                                                                                                                                                                                                                                                                                                                                                                                                                                                                                                         |
|---------------------------|-----------------------------------------------------------------------------------------------------------------------------------------------------------------------------------------------------------------------------------------------------------------------------------------------------------------------------------------------------------------------------------------------------------------------------------------------------------------------------------------------------------------------------------------------------------------------------------------------------------------------------------------------------------------------------------------------------------------------------------------------------------------------------------------------------------------------------------------------------------------------------------------------------------------------------------------------------------------------------------------------------------------------------------------------------------------------------------------------------------------------------------------------------------------------------------------------------------------------------------------------------------------------------------------------------------------------------------------------------------------------------------------------------------------------------------------------------------------------------------------------------------------------------------------------------------------------------------------------------------------------------------------|
| <b>Syntax</b>             | <code>seq sequence-number deny [protocol-number icmp   ip   tcp   udp] [A::B   A::B/x   any   host ipv6-address] [A::B   A::B/x   any   host ipv6-address] [capture   count   dscp value   fragment   log]</code>                                                                                                                                                                                                                                                                                                                                                                                                                                                                                                                                                                                                                                                                                                                                                                                                                                                                                                                                                                                                                                                                                                                                                                                                                                                                                                                                                                                                                       |
| <b>Parameters</b>         | <ul style="list-style-type: none"> <li>• <code>sequence-number</code> — Enter the sequence number to identify the route-map for editing and sequencing number, from 1 to 16777214.</li> <li>• <code>protocol-number</code> — (Optional) Enter the protocol number, from 0 to 255.</li> <li>• <code>icmp</code> — (Optional) Enter the ICMP address to deny.</li> <li>• <code>ip</code> — (Optional) Enter the IPv6 address to deny.</li> <li>• <code>tcp</code> — (Optional) Enter the TCP address to deny.</li> <li>• <code>udp</code> — (Optional) Enter the UDP address to deny.</li> <li>• <code>A::B</code> — Enter the IPv6 address in hexadecimal format separated by colons.</li> <li>• <code>A::B/x</code> — Enter the number of bits that must match the IPv6 address.</li> <li>• <code>any</code> — (Optional) Enter the keyword <code>any</code> to specify any source or destination IP address.</li> <li>• <code>host ipv6-address</code> — (Optional) Enter to use an IPv6 host address only.</li> <li>• <code>capture</code> — (Optional) Enter to capture packets the filter processes.</li> <li>• <code>count</code> — (Optional) Enter to count packets the filter processes.</li> <li>• <code>byte</code> — (Optional) Enter to count bytes the filter processes.</li> <li>• <code>dscp value</code> — (Optional) Enter to deny a packet based on the DSCP values, from 0 to 63.</li> <li>• <code>fragment</code> — (Optional) Enter to use ACLs to control packet fragments.</li> <li>• <code>log</code> — (Optional) Enables ACL logging. Information about packets that match an ACL rule are logged.</li> </ul> |
| <b>Default</b>            | Not configured                                                                                                                                                                                                                                                                                                                                                                                                                                                                                                                                                                                                                                                                                                                                                                                                                                                                                                                                                                                                                                                                                                                                                                                                                                                                                                                                                                                                                                                                                                                                                                                                                          |
| <b>Command Mode</b>       | IPV6-ACL                                                                                                                                                                                                                                                                                                                                                                                                                                                                                                                                                                                                                                                                                                                                                                                                                                                                                                                                                                                                                                                                                                                                                                                                                                                                                                                                                                                                                                                                                                                                                                                                                                |
| <b>Usage Information</b>  | OS10 cannot count both packets and bytes; when you enter the <code>count</code> <code>byte</code> options, only bytes increment. The <code>no</code> version of this command removes the filter, or use the <code>no seq sequence-number</code> command if you know the filter's sequence number.                                                                                                                                                                                                                                                                                                                                                                                                                                                                                                                                                                                                                                                                                                                                                                                                                                                                                                                                                                                                                                                                                                                                                                                                                                                                                                                                       |
| <b>Example</b>            | <pre>OS10(config)# ipv6 access-list ipv6test OS10(conf-ipv6-acl)# seq 5 deny ipv6 any any capture session 1 count log</pre>                                                                                                                                                                                                                                                                                                                                                                                                                                                                                                                                                                                                                                                                                                                                                                                                                                                                                                                                                                                                                                                                                                                                                                                                                                                                                                                                                                                                                                                                                                             |
| <b>Supported Releases</b> | 10.2.0E or later                                                                                                                                                                                                                                                                                                                                                                                                                                                                                                                                                                                                                                                                                                                                                                                                                                                                                                                                                                                                                                                                                                                                                                                                                                                                                                                                                                                                                                                                                                                                                                                                                        |



## seq deny (MAC)

Assigns a sequence number to a deny filter in a MAC access list while creating the filter.

|                           |                                                                                                                                                                                                                                                                                                                                                                                                                                                                                                                                                                                                                                                                                                                                                                                                                                                                                                                                                                                                                                                                      |
|---------------------------|----------------------------------------------------------------------------------------------------------------------------------------------------------------------------------------------------------------------------------------------------------------------------------------------------------------------------------------------------------------------------------------------------------------------------------------------------------------------------------------------------------------------------------------------------------------------------------------------------------------------------------------------------------------------------------------------------------------------------------------------------------------------------------------------------------------------------------------------------------------------------------------------------------------------------------------------------------------------------------------------------------------------------------------------------------------------|
| <b>Syntax</b>             | <code>seq sequence-number deny {nn:nn:nn:nn:nn:nn [00:00:00:00:00:00]   any} {nn:nn:nn:nn:nn:nn [00:00:00:00:00:00]   any} [protocol-number   capture   cos   count [byte]   vlan]</code>                                                                                                                                                                                                                                                                                                                                                                                                                                                                                                                                                                                                                                                                                                                                                                                                                                                                            |
| <b>Parameters</b>         | <ul style="list-style-type: none"><li>• <code>sequence-number</code> — Enter the sequence number to identify the route-map for editing and sequencing number, from 1 to 16777214.</li><li>• <code>nn:nn:nn:nn:nn:nn</code> — Enter the source MAC address.</li><li>• <code>00:00:00:00:00:00</code> — (Optional) Enter which bits in the MAC address must match. If you do not enter a mask, a mask of 00:00:00:00:00:00 applies.</li><li>• <code>any</code> — (Optional) Set all routes which are subject to the filter:<ul style="list-style-type: none"><li>◦ <code>protocol-number</code> — Protocol number identified in the MAC header, from 600 to ffff.</li><li>◦ <code>capture</code> — (Optional) Capture packets the filter processes.</li><li>◦ <code>cos</code> — (Optional) CoS value, from 0 to 7.</li><li>◦ <code>count</code> — (Optional) Count packets the filter processes.</li><li>◦ <code>byte</code> — (Optional) Count bytes the filter processes.</li><li>◦ <code>vlan</code> — (Optional) VLAN number, from 1 to 4093.</li></ul></li></ul> |
| <b>Default</b>            | Not configured                                                                                                                                                                                                                                                                                                                                                                                                                                                                                                                                                                                                                                                                                                                                                                                                                                                                                                                                                                                                                                                       |
| <b>Command Mode</b>       | CONFIG-MAC-ACL                                                                                                                                                                                                                                                                                                                                                                                                                                                                                                                                                                                                                                                                                                                                                                                                                                                                                                                                                                                                                                                       |
| <b>Usage Information</b>  | OS10 cannot count both packets and bytes; when you enter the <code>count byte</code> options, only bytes increment. The <code>no</code> version of this command removes the filter, or use the <code>no seq sequence-number</code> command if you know the filter's sequence number.                                                                                                                                                                                                                                                                                                                                                                                                                                                                                                                                                                                                                                                                                                                                                                                 |
| <b>Example</b>            | <pre>OS10(config)# mac access-list macacl OS10(conf-mac-acl)# seq 10 deny 00:00:00:00:11:11 00:00:11:11:11:11 any cos 7 OS10(conf-mac-acl)# seq 20 deny 00:00:00:00:11:11 00:00:11:11:11:11 any vlan 2</pre>                                                                                                                                                                                                                                                                                                                                                                                                                                                                                                                                                                                                                                                                                                                                                                                                                                                         |
| <b>Supported Releases</b> | 10.2.0E or later                                                                                                                                                                                                                                                                                                                                                                                                                                                                                                                                                                                                                                                                                                                                                                                                                                                                                                                                                                                                                                                     |

## seq deny icmp

Assigns a filter to deny ICMP messages while creating the filter.

|                   |                                                                                                                                                                                                                                                                                                                                                                                                                                                                                                                                                                                                                                                                                                                                                                                                                                                                                                                                                                                                                                                                                                                                                                                          |
|-------------------|------------------------------------------------------------------------------------------------------------------------------------------------------------------------------------------------------------------------------------------------------------------------------------------------------------------------------------------------------------------------------------------------------------------------------------------------------------------------------------------------------------------------------------------------------------------------------------------------------------------------------------------------------------------------------------------------------------------------------------------------------------------------------------------------------------------------------------------------------------------------------------------------------------------------------------------------------------------------------------------------------------------------------------------------------------------------------------------------------------------------------------------------------------------------------------------|
| <b>Syntax</b>     | <code>seq sequence-number deny icmp [A.B.C.D   A.B.C.D/x   any   host ip-address] [A.B.C.D   A.B.C.D/x   any   host ip-address] [capture   count   dscp value   fragment   log]</code>                                                                                                                                                                                                                                                                                                                                                                                                                                                                                                                                                                                                                                                                                                                                                                                                                                                                                                                                                                                                   |
| <b>Parameters</b> | <ul style="list-style-type: none"><li>• <code>sequence-number</code> — Enter the sequence number to identify the route-map for editing and sequencing number, from 1 to 16777214.</li><li>• <code>A.B.C.D</code> — Enter the IPv4 address in dotted decimal format.</li><li>• <code>A.B.C.D/x</code> — Enter the number of bits that must match the dotted decimal address.</li><li>• <code>any</code> — (Optional) Enter the keyword <code>any</code> to specify any source or destination IP address.</li><li>• <code>host ip-address</code> — (Optional) Enter the IPv4 address to use a host IP address only.</li><li>• <code>capture</code> — (Optional) Capture packets the filter processes.</li><li>• <code>count</code> — (Optional) Count packets the filter processes.</li><li>• <code>byte</code> — (Optional) Count bytes the filter processes.</li><li>• <code>dscp value</code> — (Optional) Deny a packet based on the DSCP values, from 0 to 63.</li><li>• <code>fragment</code> — (Optional) Use ACLs to control packet fragments.</li><li>• <code>log</code> — (Optional) Enables ACL logging. Information about packets that match an ACL rule are logged.</li></ul> |
| <b>Default</b>    | Not configured                                                                                                                                                                                                                                                                                                                                                                                                                                                                                                                                                                                                                                                                                                                                                                                                                                                                                                                                                                                                                                                                                                                                                                           |

|                           |                                                                                                                                                                                                                                                                                                   |
|---------------------------|---------------------------------------------------------------------------------------------------------------------------------------------------------------------------------------------------------------------------------------------------------------------------------------------------|
| <b>Command Mode</b>       | IPV4-ACL                                                                                                                                                                                                                                                                                          |
| <b>Usage Information</b>  | OS10 cannot count both packets and bytes; when you enter the <code>count</code> <code>byte</code> options, only bytes increment. The <code>no</code> version of this command removes the filter, or use the <code>no seq sequence-number</code> command if you know the filter's sequence number. |
| <b>Example</b>            | <pre>OS10(config)# ip access-list egress OS10(conf-ipv4-acl)# seq 5 deny icmp any any capture session 1 log</pre>                                                                                                                                                                                 |
| <b>Supported Releases</b> | 10.2.0E or later                                                                                                                                                                                                                                                                                  |

## seq deny icmp (IPv6)

Assigns a sequence number to deny ICMP messages while creating the filter.

|                           |                                                                                                                                                                                                                                                                                                                                                                                                                                                                                                                                                                                                                                                                                                                                                                                                                                                                                                                                                                                                                                                                                                                                                                                                      |
|---------------------------|------------------------------------------------------------------------------------------------------------------------------------------------------------------------------------------------------------------------------------------------------------------------------------------------------------------------------------------------------------------------------------------------------------------------------------------------------------------------------------------------------------------------------------------------------------------------------------------------------------------------------------------------------------------------------------------------------------------------------------------------------------------------------------------------------------------------------------------------------------------------------------------------------------------------------------------------------------------------------------------------------------------------------------------------------------------------------------------------------------------------------------------------------------------------------------------------------|
| <b>Syntax</b>             | <code>seq sequence-number deny icmp [A::B   A::B/x   any   host ipv6-address] [A::B   A::B/x   any   host ipv6-address] [capture   count   dscp value   fragment   log]</code>                                                                                                                                                                                                                                                                                                                                                                                                                                                                                                                                                                                                                                                                                                                                                                                                                                                                                                                                                                                                                       |
| <b>Parameters</b>         | <ul style="list-style-type: none"> <li>• <code>sequence-number</code> — Enter the sequence number to identify the route-map for editing and sequencing number, from 1 to 16777214.</li> <li>• <code>A::B</code> — Enter the IPv6 address in hexadecimal format separated by colons.</li> <li>• <code>A::B/x</code> — Enter the number of bits that must match the IPv6 address.</li> <li>• <code>any</code> — (Optional) Enter the keyword <code>any</code> to specify any source or destination IP address.</li> <li>• <code>host ipv6-address</code> — (Optional) Enter the IPv6 address to use a host address only.</li> <li>• <code>capture</code> — (Optional) Capture packets the filter processes.</li> <li>• <code>count</code> — (Optional) Count packets the filter processes.</li> <li>• <code>byte</code> — (Optional) Count bytes the filter processes.</li> <li>• <code>dscp value</code> — (Optional) Deny a packet based on the DSCP values, from 0 to 63.</li> <li>• <code>fragment</code> — (Optional) Use ACLs to control packet fragments.</li> <li>• <code>log</code> — (Optional) Enables ACL logging. Information about packets that match an ACL rule are logged.</li> </ul> |
| <b>Default</b>            | Not configured                                                                                                                                                                                                                                                                                                                                                                                                                                                                                                                                                                                                                                                                                                                                                                                                                                                                                                                                                                                                                                                                                                                                                                                       |
| <b>Command Mode</b>       | IPV6-ACL                                                                                                                                                                                                                                                                                                                                                                                                                                                                                                                                                                                                                                                                                                                                                                                                                                                                                                                                                                                                                                                                                                                                                                                             |
| <b>Usage Information</b>  | OS10 cannot count both packets and bytes; when you enter the <code>count</code> <code>byte</code> options, only bytes increment. The <code>no</code> version of this command removes the filter, or use the <code>no seq sequence-number</code> command if you know the filter's sequence number.                                                                                                                                                                                                                                                                                                                                                                                                                                                                                                                                                                                                                                                                                                                                                                                                                                                                                                    |
| <b>Example</b>            | <pre>OS10(config)# ipv6 access-list ipv6test OS10(conf-ipv6-acl)# seq 10 deny icmp any any capture session 1 log</pre>                                                                                                                                                                                                                                                                                                                                                                                                                                                                                                                                                                                                                                                                                                                                                                                                                                                                                                                                                                                                                                                                               |
| <b>Supported Releases</b> | 10.2.0E or later                                                                                                                                                                                                                                                                                                                                                                                                                                                                                                                                                                                                                                                                                                                                                                                                                                                                                                                                                                                                                                                                                                                                                                                     |

## seq deny ip

Assigns a sequence number to deny IPv4 addresses while creating the filter.

|                   |                                                                                                                                                                                                                                                                                  |
|-------------------|----------------------------------------------------------------------------------------------------------------------------------------------------------------------------------------------------------------------------------------------------------------------------------|
| <b>Syntax</b>     | <code>seq sequence-number deny ip [A.B.C.D   A.B.C.D/x   any   host ip-address] [A.B.C.D   A.B.C.D/x   any   host ip-address] [capture   count   dscp value   fragment   log]</code>                                                                                             |
| <b>Parameters</b> | <ul style="list-style-type: none"> <li>• <code>sequence-number</code> — Enter the sequence number to identify the route-map for editing and sequencing number, from 1 to 16777214.</li> <li>• <code>A.B.C.D</code> — Enter the IPv4 address in dotted decimal format.</li> </ul> |

- *A.B.C.D/x* — Enter the number of bits that must match the dotted decimal address.
- *any* — (Optional) Enter the keyword *any* to specify any source or destination IP address.
- *host ip-address* — (Optional) Enter the IPv4 address to use a host address only.
- *capture* — (Optional) Capture packets the filter processes.
- *count* — (Optional) Count packets the filter processes.
- *byte* — (Optional) Count bytes the filter processes.
- *dscp value* — (Optional) Deny a packet based on the DSCP values, from 0 to 63.
- *fragment* — (Optional) Use ACLs to control packet fragments.
- *log* — (Optional) Enables ACL logging. Information about packets that match an ACL rule are logged.

**Default** Not configured

**Command Mode** IPV4-ACL

**Usage Information** OS10 cannot count both packets and bytes; when you enter the *count* *byte* options, only bytes increment. The *no* version of this command removes the filter, or use the *no seq sequence-number* command if you know the filter's sequence number.

**Example**

```
OS10(config)# ip access-list egress
OS10(config-ipv4-acl)# seq 10 deny ip any any capture session 1 log
```

**Supported Releases** 10.2.0E or later

## seq deny ipv6

Assigns a filter to deny IPv6 addresses while creating the filter.

**Syntax** *seq sequence-number deny ip [A::B | A::B/x | any | host ipv6-address] [A::B | A:B/x | any | host ipv6-address] [capture | count | dscp value | fragment | log]*

- Parameters**
- *sequence-number* — Enter the sequence number to identify the route-map for editing and sequencing number, from 1 to 16777214.
  - *A::B* — Enter the IPv6 address in hexadecimal format separated by colons.
  - *A::B/x* — Enter the number of bits that must match the IPv6 address.
  - *any* — (Optional) Enter the keyword *any* to specify any source or destination address.
  - *host ip-address* — (Optional) Enter the IPv6 address to use a host address only.
  - *capture* — (Optional) Capture packets the filter processes.
  - *count* — (Optional) Count packets the filter processes.
  - *byte* — (Optional) Count bytes the filter processes.
  - *dscp value* — (Optional) Deny a packet based on the DSCP values, from 0 to 63.
  - *fragment* — (Optional) Use ACLs to control packet fragments.
  - *log* — (Optional) Enables ACL logging. Information about packets that match an ACL rule are logged.

**Default** Not configured

**Command Mode** IPV6-ACL

**Usage Information** OS10 cannot count both packets and bytes; when you enter the *count* *byte* options, only bytes increment. The *no* version of this command removes the filter, or use the *no seq sequence-number* command if you know the filter's sequence number.

**Example**

```
OS10(config)# ipv6 access-list ipv6test
OS10(conf-ipv6-acl)# seq 10 deny ipv6 any any capture session 1 log
```

**Supported Releases** 10.2.0E or later

## seq deny tcp

Assigns a filter to deny TCP packets while creating the filter.

**Syntax** `seq sequence-number deny tcp [A.B.C.D | A.B.C.D/x | any | host ip-address [operator]] [[A.B.C.D | A.B.C.D/x | any | host ip-address [operator]]] [ack | fin | psh | rst | syn | urg] [capture | count | dscp value | fragment | log]`

- Parameters**
- *sequence-number* — Enter the sequence number to identify the route-map for editing and sequencing number, from 1 to 16777214.
  - *A.B.C.D* — Enter the IPv4 address in dotted decimal format.
  - *A.B.C.D/x* — Enter the number of bits that must match the dotted decimal address.
  - *any* — (Optional) Enter the keyword *any* to specify any source or destination IP address.
  - *host ip-address* — (Optional) Enter the IPv4 address to use a host address only.
  - *ack* — (Optional) Set the bit as acknowledgement.
  - *fin* — (Optional) Set the bit as finish—no more data from sender.
  - *psh* — (Optional) Set the bit as push.
  - *rst* — (Optional) Set the bit as reset.
  - *syn* — (Optional) Set the bit as synchronize.
  - *urg* — (Optional) Set the bit set as urgent.
  - *capture* — (Optional) Capture packets the filter processes.
  - *count* — (Optional) Count packets the filter processes.
  - *byte* — (Optional) Count bytes the filter processes.
  - *dscp value* — (Optional) Deny a packet based on the DSCP values, from 0 to 63.
  - *fragment* — (Optional) Use ACLs to control packet fragments.
  - *log* — (Optional) Enables ACL logging. Information about packets that match an ACL rule are logged.
  - *operator* — (Optional) Enter a logical operator to match the packets on the specified port number. The following options are available:
    - *eq* — Equal to
    - *gt* — Greater than
    - *lt* — Lesser than
    - *neq* — Not equal to
    - *range* — Range of ports, including the specified port numbers.

**Default** Not configured

**Command Mode** IPV4-ACL

**Usage Information** OS10 cannot count both packets and bytes; when you enter the *count* *byte* options, only bytes increment. The *no* version of this command removes the filter, or use the *no seq sequence-number* command if you know the filter's sequence number.

**Example**

```
OS10(config)# ip access-list egress
OS10(conf-ipv4-acl)# seq 10 deny tcp any any capture session 1 log
```

**Supported Releases** 10.2.0E or later

## seq deny tcp (IPv6)

Assigns a filter to deny TCP packets while creating the filter.

**Syntax** `seq sequence-number deny tcp [A::B | A::B/x | any | host ipv6-address [operator]] [A::B | A::B/x | any | host ipv6-address [operator]] [ack | fin | psh | rst | syn | urg] [capture | count | dscp value | fragment | log]`

## Parameters

- *sequence-number* — Enter the sequence number to identify the route-map for editing and sequencing number, from 1 to 16777214.
- *A::B* — Enter the IPv6 address in hexadecimal format separated by colons.
- *A::B/x* — Enter the number of bits that must match the IPv6 address.
- *any* — (Optional) Enter the keyword *any* to specify any source or destination IP address.
- *host ip-address* — (Optional) Enter the IPv6 address to use a host address only.
- *ack* — (Optional) Set the bit as acknowledgement.
- *fin* — (Optional) Set the bit as finish—no more data from sender.
- *psh* — (Optional) Set the bit as push.
- *rst* — (Optional) Set the bit as reset.
- *syn* — (Optional) Set the bit as synchronize.
- *urg* — (Optional) Set the bit set as urgent.
- *capture* — (Optional) Capture packets the filter processes.
- *count* — (Optional) Count packets the filter processes.
- *byte* — (Optional) Count bytes the filter processes.
- *dscp value* — (Optional) Deny a packet based on the DSCP values, from 0 to 63.
- *fragment* — (Optional) Use ACLs to control packet fragments.
- *log* — (Optional) Enables ACL logging. Information about packets that match an ACL rule are logged.
- *operator* — (Optional) Enter a logical operator to match the packets on the specified port number. The following options are available:
  - *eq* — Equal to
  - *gt* — Greater than
  - *lt* — Lesser than
  - *neq* — Not equal to
  - *range* — Range of ports, including the specified port numbers.

## Default

Not configured

## Command Mode

IPV6-ACL

## Usage

### Information

OS10 cannot count both packets and bytes; when you enter the *count* *byte* options, only bytes increment. The *no* version of this command removes the filter, or use the *no seq sequence-number* command if you know the filter's sequence number.

## Example

```
OS10(config)# ipv6 access-list ipv6test
OS10(conf-ipv6-acl)# seq 10 deny tcp any any capture session 1 log
```

## Supported Releases

10.2.0E or later

## seq deny udp

Assigns a filter to deny UDP packets while creating the filter.

## Syntax

```
seq sequence-number deny udp [A.B.C.D | A.B.C.D/x | any | host ip-address
[operator]] [[A.B.C.D | A.B.C.D/x | any | host ip-address [operator]] [ack
| fin | psh | rst | syn | urg] [capture | count | dscp value | fragment |
log]
```

## Parameters

- *sequence-number* — Enter the sequence number to identify the route-map for editing and sequencing number, from 1 to 16777214.
- *A.B.C.D* — Enter the IPv4 address in dotted decimal format.
- *A.B.C.D/x* — Enter the number of bits that must match the dotted decimal address.
- *any* — (Optional) Enter the keyword *any* to specify any source or destination IP address.
- *host ip-address* — (Optional) Enter the IPv4 address to use a host address only.
- *ack* — (Optional) Set the bit as acknowledgment.

- *fin* — (Optional) Set the bit as finish—no more data from sender.
- *psh* — (Optional) Set the bit as push.
- *rst* — (Optional) Set the bit as reset.
- *syn* — (Optional) Set the bit as synchronize.
- *urg* — (Optional) Set the bit set as urgent.
- *capture* — (Optional) Capture packets the filter processes.
- *count* — (Optional) Count packets the filter processes.
- *byte* — (Optional) Count bytes the filter processes.
- *dscp value* — (Optional) Deny a packet based on the DSCP values, from 0 to 63.
- *fragment* — (Optional) Use ACLs to control packet fragments.
- *log* — (Optional) Enables ACL logging. Information about packets that match an ACL rule are logged.
- *operator* — (Optional) Enter a logical operator to match the packets on the specified port number. The following options are available:
  - *eq* — Equal to
  - *gt* — Greater than
  - *lt* — Lesser than
  - *neq* — Not equal to
  - *range* — Range of ports, including the specified port numbers.

**Default** Not configured

**Command Mode** IPv4-ACL

**Usage Information** OS10 cannot count both packets and bytes; when you enter the *count* *byte* options, only bytes increment. The *no* version of this command removes the filter, or use the *no seq sequence-number* command if you know the filter's sequence number.

**Example**

```
OS10(config)# ip access-list egress
OS10(conf-ipv4-acl)# seq 10 deny udp any any capture session 1 log
```

**Supported Releases** 10.2.0E or later

## seq deny udp (IPv6)

Assigns a filter to deny UDP packets while creating the filter.

**Syntax** *seq sequence-number deny udp [A::B | A::B/x | any | host ipv6-address [operator]] [A::B | A::B/x | any | host ipv6-address [operator]] [ack | fin | psh | rst | syn | urg] [capture | count | dscp value | fragment | log]*

- Parameters**
- *sequence-number* — Enter the sequence number to identify the route-map for editing and sequencing number, from 1 to 16777214.
  - *A::B* — Enter the IPv6 address in hexadecimal format separated by colons.
  - *A::B/x* — Enter the number of bits that must match the IPv6 address.
  - *any* — (Optional) Enter the keyword *any* to specify any source or destination IP address.
  - *host ipv6-address* — (Optional) Enter the IPv6 address to use a host address only.
  - *ack* — (Optional) Set the bit as acknowledgment.
  - *fin* — (Optional) Set the bit as finish—no more data from sender.
  - *psh* — (Optional) Set the bit as push.
  - *rst* — (Optional) Set the bit as reset.
  - *syn* — (Optional) Set the bit as synchronize.
  - *urg* — (Optional) Set the bit set as urgent.
  - *capture* — (Optional) Capture packets the filter processes.
  - *count* — (Optional) Count packets the filter processes.
  - *byte* — (Optional) Count bytes the filter processes.

- *dscp value* — (Optional) Deny a packet based on the DSCP values, from 0 to 63.
- *fragment* — (Optional) Use ACLs to control packet fragments.
- *log* — (Optional) Enables ACL logging. Information about packets that match an ACL rule are logged.
- *operator* — (Optional) Enter a logical operator to match the packets on the specified port number. The following options are available:
  - *eq* — Equal to
  - *gt* — Greater than
  - *lt* — Lesser than
  - *neq* — Not equal to
  - *range* — Range of ports, including the specified port numbers.

**Default** Not configured

**Command Mode** IPv6-ACL

**Usage Information** OS10 cannot count both packets and bytes; when you enter the *count* *byte* options, only bytes increment. The *no* version of this command removes the filter, or use the *no seq sequence-number* command if you know the filter's sequence number.

**Example**

```
OS10(config)# ipv6 access-list ipv6test
OS10(conf-ipv6-acl)# seq 10 deny udp any any capture session 1 log
```

**Supported Releases** 10.2.0E or later

## seq permit

Assigns a sequence number to permit packets while creating the filter.

**Syntax** *seq sequence-number permit [protocol-number A.B.C.D | A.B.C.D/x | any | host ip-address] [A.B.C.D | A.B.C.D/x | any | host ip-address] [capture | count | dscp value | fragment | log]*

- Parameters**
- *sequence-number* — Enter the sequence number to identify the route-map for editing and sequencing number, from 1 to 16777214.
  - *protocol-number* — (Optional) Enter the protocol number, from 0 to 255.
  - *A.B.C.D* — Enter the IPv4 address in dotted decimal format.
  - *A.B.C.D/x* — Enter the number of bits that must match the dotted decimal address.
  - *any* — (Optional) Enter the keyword *any* to specify any source or destination IP address.
  - *host ip-address* — (Optional) Enter the IPv4 address to use a host address only.
  - *capture* — (Optional) Capture packets the filter processes.
  - *count* — (Optional) Count packets the filter processes.
  - *byte* — (Optional) Count bytes the filter processes.
  - *dscp value* — (Optional) Permit a packet based on the DSCP values, from 0 to 63.
  - *fragment* — (Optional) Use ACLs to control packet fragments.
  - *log* — (Optional) Enables ACL logging. Information about packets that match an ACL rule are logged.

**Default** Not configured

**Command Mode** IPv4-ACL

**Usage Information** OS10 cannot count both packets and bytes; when you enter the *count* *byte* options, only bytes increment. The *no* version of this command removes the filter, or use the *no seq sequence-number* command if you know the filter's sequence number.

**Example**

```
OS10(config)# ip access-list testflow
OS10(conf-ipv4-acl)# seq 10 permit ip any any capture session 1 log
```

**Supported Releases** 10.2.0E or later

## seq permit (IPv6)

Assigns a sequence number to permit IPv6 packets, while creating a filter.

**Syntax** `seq sequence-number permit protocol-number [A::B | A::B/x | any | host ipv6-address] [A::B | A:B/x | any | host ipv6-address] [capture | count | dscp value | fragment | log]`

- Parameters**
- *sequence-number* — Enter the sequence number to identify the route-map for editing and sequencing number, from 1 to 16777214.
  - *protocol-number* — (Optional) Enter the protocol number, from 0 to 255.
  - *A::B* — Enter the IPv6 address in hexadecimal format separated by colons.
  - *A::B/x* — Enter the number of bits that must match the IPv6 address.
  - *any* — (Optional) Enter the keyword *any* to specify any source or destination IP address.
  - *host ipv6-address* — (Optional) Enter the IPv6 address to be used as the host address.
  - *capture* — (Optional) Enter to capture packets the filter processes.
  - *count* — (Optional) Enter to count packets the filter processes.
  - *byte* — (Optional) Enter to count bytes the filter processes.
  - *dscp value* — (Optional) Enter the DSCP value to permit a packet, from 0 to 63.
  - *fragment* — (Optional) Enter to use ACLs to control packet fragments.
  - *log* — (Optional) Enables ACL logging. Information about packets that match an ACL rule are logged.

**Default** Not configured

**Command Mode** IPV6-ACL

**Usage Information** OS10 cannot count both packets and bytes; when you enter the `count byte` options, only bytes increment. The `no` version of this command removes the filter, or use the `no seq sequence-number` command if you know the filter's sequence number.

### Example

```
OS10(config)# ipv6 access-list ipv6test
OS10(conf-ipv6-acl)# seq 10 permit ipv6 any any capture session 1 log
```

**Supported Releases** 10.2.0E or later

## seq permit (MAC)

Assigns a sequence number to permit MAC addresses while creating a filter.

**Syntax** `seq sequence-number permit {nn:nn:nn:nn:nn:nn [00:00:00:00:00:00] | any} {nn:nn:nn:nn:nn:nn [00:00:00:00:00:00] | any} [protocol-number | capture | cos | count [byte] | vlan]`

- Parameters**
- *sequence-number* — Enter the sequence number to identify the route-map for editing and sequencing, from 1 to 16777214.
  - *nn:nn:nn:nn:nn:nn* — Enter the MAC address of the network from or to which the packets were sent.
  - *00:00:00:00:00:00* — (Optional) Enter which bits in the MAC address must match. If you do not enter a mask, a mask of `00:00:00:00:00:00` applies.
  - *any* — (Optional) Set all routes to be subject to the filter:
    - *protocol-number* — (Optional) Enter the protocol number identified in the MAC header, from 600 to ffff.
    - *capture* — (Optional) Enter the capture packets the filter processes.



- o `cos` — (Optional) Enter the CoS value, from 0 to 7.
- o `count` — (Optional) Enter the count packets the filter processes.
- o `byte` — (Optional) Enter the count bytes the filter processes.
- o `vlan` — (Optional) Enter the VLAN number, from 1 to 4093.

**Default** Not configured

**Command Mode** MAC-ACL

**Usage Information** OS10 cannot count both packets and bytes; when you enter the `count` `byte` options, only bytes increment. The `no` version of this command removes the filter, or use the `no seq sequence-number` command if you know the filter's sequence number.

**Example**

```
OS10(config)# mac access-list macacl
OS10(conf-mac-acl)# seq 10 permit 00:00:00:00:11:11 00:00:11:11:11:11
any cos 7
OS10(conf-mac-acl)# seq 20 permit 00:00:00:00:11:11 00:00:11:11:11:11
any vlan 2
```

**Supported Releases** 10.2.0E or later

## seq permit icmp

Assigns a sequence number to allow ICMP messages while creating the filter

**Syntax** `seq sequence-number permit icmp [A.B.C.D | A.B.C.D/x | any | host ip-address] [A.B.C.D | A.B.C.D/x | any | host ip-address] [capture | count | dscp value | fragment | log]`

- Parameters**
- `sequence-number` — Enter the sequence number to identify the route-map for editing and sequencing number, from 1 to 16777214.
  - `A.B.C.D` — Enter the IPv4 address in dotted decimal format.
  - `A.B.C.D/x` — Enter the number of bits that must match the dotted decimal address.
  - `any` — (Optional) Enter the keyword `any` to specify any source or destination IP address.
  - `host ip-address` — (Optional) Enter the IPv4 address to use a host address only.
  - `capture` — (Optional) Capture packets the filter processes.
  - `count` — (Optional) Count packets the filter processes.
  - `byte` — (Optional) Count bytes the filter processes.
  - `dscp value` — (Optional) Permit a packet based on the DSCP values, from 0 to 63.
  - `fragment` — (Optional) Use ACLs to control packet fragments.
  - `log` — (Optional) Enables ACL logging. Information about packets that match an ACL rule are logged.

**Default** Not configured

**Command Mode** IPV4-ACL

**Usage Information** OS10 cannot count both packets and bytes; when you enter the `count` `byte` options, only bytes increment. The `no` version of this command removes the filter, or use the `no seq sequence-number` command if you know the filter's sequence number.

**Example**

```
OS10(config)# ip access-list egress
OS10(conf-ipv4-acl)# seq 5 permit icmp any any capture session 1 log
```

**Supported Releases** 10.2.0E or later

## seq permit icmp (IPv6)

Assigns a sequence number to allow ICMP messages while creating the filter.

|                           |                                                                                                                                                                                                                                                                                                                                                                                                                                                                                                                                                                                                                                                                                                                                                                                                                                                                                                                                                                                                                                                                                                                                                                                            |
|---------------------------|--------------------------------------------------------------------------------------------------------------------------------------------------------------------------------------------------------------------------------------------------------------------------------------------------------------------------------------------------------------------------------------------------------------------------------------------------------------------------------------------------------------------------------------------------------------------------------------------------------------------------------------------------------------------------------------------------------------------------------------------------------------------------------------------------------------------------------------------------------------------------------------------------------------------------------------------------------------------------------------------------------------------------------------------------------------------------------------------------------------------------------------------------------------------------------------------|
| <b>Syntax</b>             | <code>seq sequence-number permit icmp [A::B   A::B/x   any   host ipv6-address] [A::B   A:B/x   any   host ipv6-address] [capture   count   dscp value   fragment   log]</code>                                                                                                                                                                                                                                                                                                                                                                                                                                                                                                                                                                                                                                                                                                                                                                                                                                                                                                                                                                                                            |
| <b>Parameters</b>         | <ul style="list-style-type: none"><li>• <code>sequence-number</code> — Enter the sequence number to identify the route-map for editing and sequencing number, from 1 to 16777214.</li><li>• <code>A::B</code> — Enter the IPv6 address in hexadecimal format separated by colons.</li><li>• <code>A::B/x</code> — Enter the number of bits that must match the IPv6 address.</li><li>• <code>any</code> — (Optional) Enter the keyword <code>any</code> to specify any source or destination IP address.</li><li>• <code>host ipv6-address</code> — (Optional) Enter the IPv6 address to use a host address only.</li><li>• <code>capture</code> — (Optional) Capture packets the filter processes.</li><li>• <code>count</code> — (Optional) Count packets the filter processes.</li><li>• <code>byte</code> — (Optional) Count bytes the filter processes.</li><li>• <code>dscp value</code> — (Optional) Permit a packet based on the DSCP values, from 0 to 63.</li><li>• <code>fragment</code> — (Optional) Use ACLs to control packet fragments.</li><li>• <code>log</code> — (Optional) Enables ACL logging. Information about packets that match an ACL rule are logged.</li></ul> |
| <b>Default</b>            | Not configured                                                                                                                                                                                                                                                                                                                                                                                                                                                                                                                                                                                                                                                                                                                                                                                                                                                                                                                                                                                                                                                                                                                                                                             |
| <b>Command Mode</b>       | IPV6-ACL                                                                                                                                                                                                                                                                                                                                                                                                                                                                                                                                                                                                                                                                                                                                                                                                                                                                                                                                                                                                                                                                                                                                                                                   |
| <b>Usage Information</b>  | OS10 cannot count both packets and bytes; when you enter the <code>count byte</code> options, only bytes increment. The <code>no</code> version of this command removes the filter, or use the <code>no seq sequence-number</code> command if you know the filter's sequence number.                                                                                                                                                                                                                                                                                                                                                                                                                                                                                                                                                                                                                                                                                                                                                                                                                                                                                                       |
| <b>Example</b>            | <pre>OS10(config)# ipv6 access-list ipv6test OS10(conf-ipv6-acl)# seq 5 permit icmp any any capture session 1 log</pre>                                                                                                                                                                                                                                                                                                                                                                                                                                                                                                                                                                                                                                                                                                                                                                                                                                                                                                                                                                                                                                                                    |
| <b>Supported Releases</b> | 10.2.0E or later                                                                                                                                                                                                                                                                                                                                                                                                                                                                                                                                                                                                                                                                                                                                                                                                                                                                                                                                                                                                                                                                                                                                                                           |

## seq permit ip

Assigns a sequence number to allow packets while creating the filter.

|                     |                                                                                                                                                                                                                                                                                                                                                                                                                                                                                                                                                                                                                                                                                                                                                                                                                                                                                                                                                                                                                                                                                                                                                                                         |
|---------------------|-----------------------------------------------------------------------------------------------------------------------------------------------------------------------------------------------------------------------------------------------------------------------------------------------------------------------------------------------------------------------------------------------------------------------------------------------------------------------------------------------------------------------------------------------------------------------------------------------------------------------------------------------------------------------------------------------------------------------------------------------------------------------------------------------------------------------------------------------------------------------------------------------------------------------------------------------------------------------------------------------------------------------------------------------------------------------------------------------------------------------------------------------------------------------------------------|
| <b>Syntax</b>       | <code>seq sequence-number permit ip [A.B.C.D   A.B.C.D/x   any   host ip-address] [A.B.C.D   A.B.C.D/x   any   host ip-address] [capture   count   dscp value   fragment   log]</code>                                                                                                                                                                                                                                                                                                                                                                                                                                                                                                                                                                                                                                                                                                                                                                                                                                                                                                                                                                                                  |
| <b>Parameters</b>   | <ul style="list-style-type: none"><li>• <code>sequence-number</code> — Enter the sequence number to identify the route-map for editing and sequencing number, from 1 to 16777214.</li><li>• <code>A.B.C.D</code> — Enter the IPv4 address in dotted decimal format.</li><li>• <code>A.B.C.D/x</code> — Enter the number of bits that must match the dotted decimal address.</li><li>• <code>any</code> — (Optional) Enter the keyword <code>any</code> to specify any source or destination IP address.</li><li>• <code>host ip-address</code> — (Optional) Enter the IPv4 address to use a host address only.</li><li>• <code>capture</code> — (Optional) Capture packets the filter processes.</li><li>• <code>count</code> — (Optional) Count packets the filter processes.</li><li>• <code>byte</code> — (Optional) Count bytes the filter processes.</li><li>• <code>dscp value</code> — (Optional) Permit a packet based on the DSCP values, from 0 to 63.</li><li>• <code>fragment</code> — (Optional) Use ACLs to control packet fragments.</li><li>• <code>log</code> — (Optional) Enables ACL logging. Information about packets that match an ACL rule are logged.</li></ul> |
| <b>Default</b>      | Not configured                                                                                                                                                                                                                                                                                                                                                                                                                                                                                                                                                                                                                                                                                                                                                                                                                                                                                                                                                                                                                                                                                                                                                                          |
| <b>Command Mode</b> | IPV4-ACL                                                                                                                                                                                                                                                                                                                                                                                                                                                                                                                                                                                                                                                                                                                                                                                                                                                                                                                                                                                                                                                                                                                                                                                |

**Usage Information** OS10 cannot count both packets and bytes; when you enter the `count` `byte` options, only bytes increment. The `no` version of this command removes the filter, or use the `no seq sequence-number` command if you know the filter's sequence number.

**Example**

```
OS10(config)# ip access-list egress
OS10(conf-ipv4-acl)# seq 5 permit ip any any capture session 1 log
```

**Supported Releases** 10.2.0E or later

## seq permit ipv6

Assigns a sequence number to allow packets while creating the filter.

**Syntax** `seq sequence-number permit ipv6 [A::B | A::B/x | any | host ipv6-address] [A::B | A:B/x | any | host ipv6-address] [capture | count | dscp value | fragment | log]`

- Parameters**
- `sequence-number` — Enter the sequence number to identify the route-map for editing and sequencing number, from 1 to 16777214.
  - `A::B` — Enter the IPv6 address in hexadecimal format separated by colons.
  - `A::B/x` — Enter the number of bits that must match the IPv6 address.
  - `any` — (Optional) Enter the keyword `any` to specify any source or destination IP address.
  - `host ipv6-address` — (Optional) Enter the IPv6 address to use a host address only.
  - `capture` — (Optional) Capture packets the filter processes.
  - `count` — (Optional) Count packets the filter processes.
  - `byte` — (Optional) Count bytes the filter processes.
  - `dscp value` — (Optional) Permit a packet based on the DSCP values, from 0 to 63.
  - `fragment` — (Optional) Use ACLs to control packet fragments.
  - `log` — (Optional) Enables ACL logging. Information about packets that match an ACL rule are logged.

**Default** Not configured

**Command Mode** IPV6-ACL

**Usage Information** OS10 cannot count both packets and bytes; when you enter the `count` `byte` options, only bytes increment. The `no` version of this command removes the filter, or use the `no seq sequence-number` command if you know the filter's sequence number.

**Example**

```
OS10(config)# ipv6 access-list egress
OS10(conf-ipv6-acl)# seq 5 permit ipv6 any any capture session 1 log
```

**Supported Releases** 10.2.0E or later

## seq permit tcp

Assigns a sequence number to allow TCP packets while creating the filter.

**Syntax** `seq sequence-number permit tcp [A.B.C.D | A.B.C.D/x | any | host ip-address [operator]] [[A.B.C.D | A.B.C.D/x | any | host ip-address [operator]]] [ack | fin | psh | rst | syn | urg] [capture | count | dscp value | fragment | log]`

- Parameters**
- `sequence-number` — Enter the sequence number to identify the route-map for editing and sequencing number, from 1 to 16777214.
  - `A.B.C.D` — Enter the IPv4 address in dotted decimal format.
  - `A.B.C.D/x` — Enter the number of bits that must match the dotted decimal address.

- `any` — (Optional) Enter the keyword `any` to specify any source or destination IP address.
- `host ip-address` — (Optional) Enter the IPv4 address to use a host address only.
- `operator` — (Optional) Enter a logical operator to match the packets on the specified port number. The following options are available:
  - `eq` — Equal to
  - `gt` — Greater than
  - `lt` — Lesser than
  - `neq` — Not equal to
  - `range` — Range of ports, including the specified port numbers.
- `ack` — (Optional) Set the bit as acknowledgment.
- `fin` — (Optional) Set the bit as finish—no more data from sender.
- `psh` — (Optional) Set the bit as push.
- `rst` — (Optional) Set the bit as reset.
- `syn` — (Optional) Set the bit as synchronize.
- `urg` — (Optional) Set the bit set as urgent.
- `capture` — (Optional) Capture packets the filter processes.
- `count` — (Optional) Count packets the filter processes.
- `byte` — (Optional) Count bytes the filter processes.
- `dscp value` — (Optional) Permit a packet based on the DSCP values, from 0 to 63.
- `fragment` — (Optional) Use ACLs to control packet fragments.
- `log` — (Optional) Enables ACL logging. Information about packets that match an ACL rule are logged.

**Default** Not configured

**Command Mode** IPV4-ACL

**Usage Information** OS10 cannot count both packets and bytes; when you enter the `count byte` options, only bytes increment. The `no` version of this command removes the filter, or use the `no seq sequence-number` command if you know the filter's sequence number.

**Example**

```
OS10(config)# ip access-list egress
OS10(conf-ipv4-acl)# seq 5 permit tcp any any capture session 1 log
```

**Supported Releases** 10.2.0E or later

## seq permit tcp (IPv6)

Assigns a sequence number to allow TCP IPv6 packets while creating the filter.

**Syntax** `seq sequence-number permit tcp [A::B | A::B/x | any | host ipv6-address [operator]] [A::B | A::B/x | any | host ipv6-address [operator]] [ack | fin | psh | rst | syn | urg] [capture | count | dscp value | fragment | log]`

- Parameters**
- `sequence-number` — Enter the sequence number to identify the route-map for editing and sequencing number, from 1 to 16777214.
  - `A::B` — Enter the IPv6 address in hexadecimal format separated by colons.
  - `A::B/x` — Enter the number of bits that must match the IPv6 address.
  - `any` — (Optional) Enter the keyword `any` to specify any source or destination IP address.
  - `host ipv6-address` — (Optional) Enter the IPv6 address to use a host address only.
  - `operator` — (Optional) Enter a logical operator to match the packets on the specified port number. The following options are available:
    - `eq` — Equal to
    - `gt` — Greater than
    - `lt` — Lesser than

- `neq` — Not equal to
- `range` — Range of ports, including the specified port numbers.
- `ack` — (Optional) Set the bit as acknowledgment.
- `fin` — (Optional) Set the bit as finish—no more data from sender.
- `psh` — (Optional) Set the bit as push.
- `rst` — (Optional) Set the bit as reset.
- `syn` — (Optional) Set the bit as synchronize.
- `urg` — (Optional) Set the bit set as urgent.
- `capture` — (Optional) Capture packets the filter processes.
- `count` — (Optional) Count packets the filter processes.
- `byte` — (Optional) Count bytes the filter processes.
- `dscp value` — (Optional) Permit a packet based on the DSCP values, from 0 to 63.
- `fragment` — (Optional) Use ACLs to control packet fragments.
- `log` — (Optional) Enables ACL logging. Information about packets that match an ACL rule are logged.

**Default** Not configured

**Command Mode** IPV6-ACL

**Usage Information** OS10 cannot count both packets and bytes; when you enter the `count` `byte` options, only bytes increment. The `no` version of this command removes the filter, or use the `no seq sequence-number` command if you know the filter's sequence number.

**Example**

```
OS10(config)# ipv6 access-list egress
OS10(conf-ipv6-acl)# seq 5 permit tcp any any capture session 1 log
```

**Supported Releases** 10.2.0E or later

## seq permit udp

Assigns a sequence number to allow UDP packets while creating the filter.

**Syntax** `seq sequence-number permit udp [A.B.C.D | A.B.C.D/x | any | host ip-address [operator]] [[A.B.C.D | A.B.C.D/x | any | host ip-address [operator] ] [ack | fin | psh | rst | syn | urg] [capture | count | dscp value | fragment | log]`

- Parameters**
- `sequence-number` — Enter the sequence number to identify the route-map for editing and sequencing number, from 1 to 16777214.
  - `A.B.C.D` — Enter the IPv4 address in dotted decimal format.
  - `A.B.C.D/x` — Enter the number of bits that must match the dotted decimal address.
  - `any` — (Optional) Enter the keyword `any` to specify any source or destination IP address.
  - `host ip-address` — (Optional) Enter the IPv4 address to use a host address only.
  - `operator` — (Optional) Enter a logical operator to match the packets on the specified port number. The following options are available:
    - `eq` — Equal to
    - `gt` — Greater than
    - `lt` — Lesser than
    - `neq` — Not equal to
    - `range` — Range of ports, including the specified port numbers.
  - `ack` — (Optional) Set the bit as acknowledgment.
  - `fin` — (Optional) Set the bit as finish—no more data from sender.
  - `psh` — (Optional) Set the bit as push.
  - `rst` — (Optional) Set the bit as reset.
  - `syn` — (Optional) Set the bit as synchronize.

- `urg` — (Optional) Set the bit set as urgent.
- `capture` — (Optional) Capture packets the filter processes.
- `count` — (Optional) Count packets the filter processes.
- `byte` — (Optional) Count bytes the filter processes.
- `dscp value` — (Optional) Deny a packet based on the DSCP values, from 0 to 63.
- `fragment` — (Optional) Use ACLs to control packet fragments.
- `log` — (Optional) Enables ACL logging. Information about packets that match an ACL rule are logged.

**Default** Not configured

**Command Mode** IPV4-ACL

**Usage Information** OS10 cannot count both packets and bytes; when you enter the `count` `byte` options, only bytes increment. The `no` version of this command removes the filter, or use the `no seq sequence-number` command if you know the filter's sequence number.

**Example**

```
OS10(config)# ip access-list egress
OS10(conf-ipv4-acl)# seq 5 permit udp any any capture session 1 log
```

**Supported Releases** 10.2.0E or later

## seq permit udp (IPv6)

Assigns a sequence number to allow UDP IPv6 packets while creating a filter.

**Syntax** `seq sequence-number permit udp [A::B | A::B/x | any | host ipv6-address [operator]] [A::B | A::B/x | any | host ipv6-address [operator]] [ack | fin | psh | rst | syn | urg] [capture | count | dscp value | fragment | log]`

- Parameters**
- `sequence-number` — Enter the sequence number to identify the route-map for editing and sequencing number, from 1 to 16777214.
  - `A::B` — Enter the IPv6 address in hexadecimal format separated by colons.
  - `A::B/x` — Enter the number of bits that must match the IPv6 address.
  - `any` — (Optional) Enter the keyword `any` to specify any source or destination IP address.
  - `host ipv6-address` — (Optional) Enter the IPv6 address to use a host address only.
  - `operator` — (Optional) Enter a logical operator to match the packets on the specified port number. The following options are available:
    - `eq` — Equal to
    - `gt` — Greater than
    - `lt` — Lesser than
    - `neq` — Not equal to
    - `range` — Range of ports, including the specified port numbers.
  - `ack` — (Optional) Set the bit as acknowledgment.
  - `fin` — (Optional) Set the bit as finish—no more data from sender.
  - `psh` — (Optional) Set the bit as push.
  - `rst` — (Optional) Set the bit as reset.
  - `syn` — (Optional) Set the bit as synchronize.
  - `urg` — (Optional) Set the bit set as urgent.
  - `capture` — (Optional) Capture packets the filter processes.
  - `count` — (Optional) Count packets the filter processes.
  - `byte` — (Optional) Count bytes the filter processes.
  - `dscp value` — (Optional) Permit a packet based on the DSCP values, from 0 to 63.
  - `fragment` — (Optional) Use ACLs to control packet fragments.
  - `log` — (Optional) Enables ACL logging. Information about packets that match an ACL rule are logged.

**Default** Not configured

|                           |                                                                                                                                                                                                                                                                                                   |
|---------------------------|---------------------------------------------------------------------------------------------------------------------------------------------------------------------------------------------------------------------------------------------------------------------------------------------------|
| <b>Command Mode</b>       | IPV6-ACL                                                                                                                                                                                                                                                                                          |
| <b>Usage Information</b>  | OS10 cannot count both packets and bytes; when you enter the <code>count</code> <code>byte</code> options, only bytes increment. The <code>no</code> version of this command removes the filter, or use the <code>no seq sequence-number</code> command if you know the filter's sequence number. |
| <b>Example</b>            | <pre>OS10(config)# ipv6 access-list egress OS10(conf-ipv6-acl)# seq 5 permit udp any any capture session 1 log</pre>                                                                                                                                                                              |
| <b>Supported Releases</b> | 10.2.0E or later                                                                                                                                                                                                                                                                                  |

## show access-group

Displays IP, MAC, or IPv6 access-group information.

|                                           |                                                                                                                                                                                                                                                                                                                             |
|-------------------------------------------|-----------------------------------------------------------------------------------------------------------------------------------------------------------------------------------------------------------------------------------------------------------------------------------------------------------------------------|
| <b>Syntax</b>                             | <code>show {ip   mac   ipv6} access-group name</code>                                                                                                                                                                                                                                                                       |
| <b>Parameters</b>                         | <ul style="list-style-type: none"> <li>• <code>ip</code> — View IP access group information.</li> <li>• <code>mac</code> — View MAC access group information.</li> <li>• <code>ipv6</code> — View IPv6 access group information.</li> <li>• <code>access-group name</code> — Enter the name of the access group.</li> </ul> |
| <b>Default</b>                            | Not configured                                                                                                                                                                                                                                                                                                              |
| <b>Command Mode</b>                       | EXEC                                                                                                                                                                                                                                                                                                                        |
| <b>Usage Information</b>                  | None                                                                                                                                                                                                                                                                                                                        |
| <b>Example (IP)</b>                       | <pre>OS10# show ip access-group aaa Ingress IP access list aaa on ethernet1/1/1 Ingress IP access list aaa on ethernet1/1/2 Egress IP access list aaa on ethernet1/1/2</pre>                                                                                                                                                |
| <b>Example (MAC)</b>                      | <pre>OS10# show mac access-group bbb Ingress MAC access list aaa on ethernet1/1/1 Ingress MAC access list aaa on ethernet1/1/2 Egress MAC access list aaa on ethernet1/1/2</pre>                                                                                                                                            |
| <b>Example (IPv6)</b>                     | <pre>OS10# show ipv6 access-group ccc Ingress IPV6 access list aaa on ethernet1/1/1 Ingress IPV6 access list aaa on ethernet1/1/2 Egress IPV6 access list aaa on ethernet1/1/2</pre>                                                                                                                                        |
| <b>Example (Control-plane ACL - IP)</b>   | <pre>OS10# show ip access-group aaa-cp-acl Ingress IP access-list aaa-cp-acl on control-plane data mgmt</pre>                                                                                                                                                                                                               |
| <b>Example (Control-plane ACL - MAC)</b>  | <pre>OS10# show mac access-group aaa-cp-acl Ingress MAC access-list aaa-cp-acl on control-plane data</pre>                                                                                                                                                                                                                  |
| <b>Example (Control-plane ACL - IPv6)</b> | <pre>OS10# show ipv6 access-group aaa-cp-acl Ingress IPV6 access-list aaa-cp-acl on control-plane data mgmt</pre>                                                                                                                                                                                                           |
| <b>Supported Releases</b>                 | 10.2.0E or later; 10.4.1 or later (control-plane ACL)                                                                                                                                                                                                                                                                       |

## show access-lists

Displays IP, MAC, or IPv6 access-list information.

**Syntax** `show {ip | mac | ipv6} access-lists {in | out} access-list-name`

- Parameters**
- `ip` — View IP access list information.
  - `mac` — View MAC access list information.
  - `ipv6` — View IPv6 access list information.
  - `access-lists in | out` — Enter either access lists in or access lists out.
  - `access-list-name` — Enter the name of the access-list.

**Default** Not configured

**Command Mode** EXEC

**Usage Information** None

**Example (MAC In)**

```
OS10# show mac access-lists in
Ingress MAC access list aaa
Active on interfaces :
 ethernet1/1/1
 ethernet1/1/2
seq 10 permit any any
seq 20 permit 11:11:11:11:11:11 22:22:22:22:22:22 any monitor count
bytes (0 bytes)
```

**Example (MAC Out)**

```
OS10# show mac access-lists out
Egress MAC access list aaa
Active on interfaces :
 ethernet1/1/1
 ethernet1/1/2
seq 10 permit any any
seq 20 permit 11:11:11:11:11:11 22:22:22:22:22:22 any monitor count
bytes (0 bytes)
```

**Example (IP In)**

```
OS10# show ip access-lists in
Ingress IP access list aaaa
Active on interfaces :
 ethernet1/1/1
 ethernet1/1/2
seq 10 permit ip any any log
seq 20 permit tcp any any count (0 packets)
seq 30 permit udp any any count bytes (0 bytes)
```

**Example (IP Out)**

```
OS10# show ip access-lists out
Egress IP access list aaaa
Active on interfaces :
 ethernet1/1/1
 ethernet1/1/2
seq 10 permit ip any any
seq 20 permit tcp any any count (0 packets)
seq 30 permit udp any any count bytes (0 bytes)
```

**Example (IPv6 In)**

```
OS10# show ipv6 access-lists in
Ingress IPV6 access list bbb
Active on interfaces :
 ethernet1/1/1
 ethernet1/1/2
seq 10 permit any any
Ingress IPV6 access list ggg
Active on interfaces :
```



```
 ethernet 1/1/3
 seq 5 permit ipv6 11::/32 any log count (0 packets)
```

### Example (IPv6 Out)

```
OS10# show ipv6 access-lists out
Egress IPV6 access list bbb
Active on interfaces :
 ethernet1/1/1
 ethernet1/1/2
 seq 10 permit any any
Egress IPV6 access list ggg
Active on interfaces :
 ethernet 1/1/1
 seq 5 permit ipv6 11::/32 any count (0 packets)
```

### Example (IP In - Control-plane ACL)

```
OS10# show ip access-lists in
Ingress IP access-list aaa-cp-acl
Active on interfaces :
 control-plane data
 seq 10 permit ip any any
 control-plane mgmt
 seq 10 permit ip any any
```

### Example (IPv6 In - Control-plane ACL)

```
OS10# show ipv6 access-lists in
Ingress IPV6 access-list aaa-cp-acl
Active on interfaces :
 control-plane data
 seq 10 permit ipv6 any any
 control-plane mgmt
 seq 10 permit ipv6 any any
```

### Example (MAC In - Control-plane ACL)

```
OS10# show mac access-lists in
Ingress MAC access-list mac-cpl
Active on interfaces :
 control-plane data
 seq 10 deny any any count (159 packets)
```

### Supported Releases

10.2.0E or later; 10.4.1 or later (control-plane ACL)

## show acl-table-usage detail

Displays the ingress and egress ACL tables, the features that are used, and their space utilizations.

**Syntax** show acl-table-usage detail

**Parameters** None

**Default** None

**Command Mode** EXEC

### Usage Information

The hardware pool displays the ingress application groups (pools), the features mapped to each of these groups, and the amount of used and free space available in each of the pools. The amount of space required to store a single ACL rule in a pool depends on the keywidth of the TCAM slice.

The service pool displays the amount of used and free space for each of the features. The number of ACL rules configured for a feature is displayed in the configured rules column. The number of used rows depends on the number of ports the configured rules are applied on.

### Examples

Z9100-ON platform

```
OS10# show acl-table-usage detail
```

Ingress ACL utilization - Pipe 0

Hardware Pools

| Pool ID | App(s)        | Used rows | Free rows | Max rows |
|---------|---------------|-----------|-----------|----------|
| 0       | SYSTEM_FLOW   | 98        | 414       | 512      |
| 1       | SYSTEM_FLOW   | 98        | 414       | 512      |
| 2       | SYSTEM_FLOW   | 98        | 414       | 512      |
| 3       | USER_IPV4_ACL | 4         | 508       | 512      |
| 4       | USER_IPV4_ACL | 4         | 508       | 512      |
| 5       | FREE          | 0         | 512       | 512      |
| 6       | USER_IPV6_ACL | 4         | 508       | 512      |
| 7       | USER_IPV6_ACL | 4         | 508       | 512      |
| 8       | USER_IPV6_ACL | 4         | 508       | 512      |
| 9       | USER_L2_ACL   | 4         | 508       | 512      |
| 10      | USER_L2_ACL   | 4         | 508       | 512      |
| 11      | FREE          | 0         | 512       | 512      |

Service Pools

| App           | Allocated pools | App group | Configured rules |
|---------------|-----------------|-----------|------------------|
| Used rows     | Free rows       | Max rows  |                  |
| USER_L2_ACL   | Shared:2        | G9        | 1                |
| 2             | 254             | 256       |                  |
| USER_IPV4_ACL | Shared:2        | G3        | 1                |
| 2             | 254             | 256       |                  |
| USER_IPV6_ACL | Shared:3        | G6        | 1                |
| 2             | 254             | 256       |                  |
| SYSTEM_FLOW   | Shared:3        | G0        | 49               |
| 49            | 207             | 256       |                  |

Ingress ACL utilization - Pipe 1

Hardware Pools

| Pool ID | App(s)        | Used rows | Free rows | Max rows |
|---------|---------------|-----------|-----------|----------|
| 0       | SYSTEM_FLOW   | 98        | 414       | 512      |
| 1       | SYSTEM_FLOW   | 98        | 414       | 512      |
| 2       | SYSTEM_FLOW   | 98        | 414       | 512      |
| 3       | USER_IPV4_ACL | 0         | 512       | 512      |
| 4       | USER_IPV4_ACL | 0         | 512       | 512      |
| 5       | FREE          | 0         | 512       | 512      |
| 6       | USER_IPV6_ACL | 0         | 512       | 512      |
| 7       | USER_IPV6_ACL | 0         | 512       | 512      |
| 8       | USER_IPV6_ACL | 0         | 512       | 512      |
| 9       | USER_L2_ACL   | 0         | 512       | 512      |
| 10      | USER_L2_ACL   | 0         | 512       | 512      |
| 11      | FREE          | 0         | 512       | 512      |

Service Pools

| App         | Allocated pools | App group | Configured rules |
|-------------|-----------------|-----------|------------------|
| Used rows   | Free rows       | Max rows  |                  |
| SYSTEM_FLOW | Shared:3        | G0        | 49               |
| 49          | 207             | 256       |                  |

Ingress ACL utilization - Pipe 2

Hardware Pools

| Pool ID | App(s)      | Used rows | Free rows | Max rows |
|---------|-------------|-----------|-----------|----------|
| 0       | SYSTEM_FLOW | 98        | 414       | 512      |

|    |               |    |     |     |
|----|---------------|----|-----|-----|
| 1  | SYSTEM_FLOW   | 98 | 414 | 512 |
| 2  | SYSTEM_FLOW   | 98 | 414 | 512 |
| 3  | USER_IPV4_ACL | 0  | 512 | 512 |
| 4  | USER_IPV4_ACL | 0  | 512 | 512 |
| 5  | FREE          | 0  | 512 | 512 |
| 6  | USER_IPV6_ACL | 0  | 512 | 512 |
| 7  | USER_IPV6_ACL | 0  | 512 | 512 |
| 8  | USER_IPV6_ACL | 0  | 512 | 512 |
| 9  | USER_L2_ACL   | 0  | 512 | 512 |
| 10 | USER_L2_ACL   | 0  | 512 | 512 |
| 11 | FREE          | 0  | 512 | 512 |

-----  
Service Pools  
-----

| App         | Allocated pools | App group | Configured rules |
|-------------|-----------------|-----------|------------------|
| Used rows   | Free rows       | Max rows  |                  |
| SYSTEM_FLOW | Shared:3        | G0        | 49               |
| 49          | 207             | 256       |                  |

-----  
Ingress ACL utilization - Pipe 3  
Hardware Pools  
-----

| Pool ID | App(s)        | Used rows | Free rows | Max rows |
|---------|---------------|-----------|-----------|----------|
| 0       | SYSTEM_FLOW   | 98        | 414       | 512      |
| 1       | SYSTEM_FLOW   | 98        | 414       | 512      |
| 2       | SYSTEM_FLOW   | 98        | 414       | 512      |
| 3       | USER_IPV4_ACL | 0         | 512       | 512      |
| 4       | USER_IPV4_ACL | 0         | 512       | 512      |
| 5       | FREE          | 0         | 512       | 512      |
| 6       | USER_IPV6_ACL | 0         | 512       | 512      |
| 7       | USER_IPV6_ACL | 0         | 512       | 512      |
| 8       | USER_IPV6_ACL | 0         | 512       | 512      |
| 9       | USER_L2_ACL   | 0         | 512       | 512      |
| 10      | USER_L2_ACL   | 0         | 512       | 512      |
| 11      | FREE          | 0         | 512       | 512      |

-----  
Service Pools  
-----

| App         | Allocated pools | App group | Configured rules |
|-------------|-----------------|-----------|------------------|
| Used rows   | Free rows       | Max rows  |                  |
| SYSTEM_FLOW | Shared:3        | G0        | 49               |
| 49          | 207             | 256       |                  |

-----  
Egress ACL utilization  
Hardware Pools  
-----

| Pool ID   | App(s) | Free rows | Max rows |
|-----------|--------|-----------|----------|
| Used rows |        |           |          |
| 0         | FREE   |           |          |
| 0         | 256    | 256       |          |
| 1         | FREE   |           |          |
| 0         | 256    | 256       |          |
| 2         | FREE   |           |          |
| 0         | 256    | 256       |          |
| 3         | FREE   |           |          |
| 0         | 256    | 256       |          |

Service Pools

```

App Allocated pools App group Configured rules
Used rows Free rows Max rows

```

S6010-ON platform

```

OS10# show acl-table-usage detail
Ingress ACL utilization
Hardware Pools

```

| Pool ID | App(s)         | Used rows | Free rows | Max rows |
|---------|----------------|-----------|-----------|----------|
| 0       | SYSTEM_FLOW    | 49        | 975       | 1024     |
| 1       | SYSTEM_FLOW    | 49        | 975       | 1024     |
| 2       | USER_IPV4_ACL  | 3         | 1021      | 1024     |
| 3       | USER_L2_ACL    | 2         | 1022      | 1024     |
| 4       | USER_IPV6_ACL  | 2         | 510       | 512      |
| 5       | USER_IPV6_ACL  | 2         | 510       | 512      |
| 6       | FCOE           | 55        | 457       | 512      |
| 7       | FCOE           | 55        | 457       | 512      |
| 8       | ISCSI_SNOOPING | 12        | 500       | 512      |
| 9       | FREE           | 0         | 512       | 512      |
| 10      | PBR_V6         | 1         | 511       | 512      |
| 11      | PBR_V6         | 1         | 511       | 512      |

Service Pools

```

App Allocated pools App group Configured rules
Used rows Free rows Max rows

```

|                |          |      |    |
|----------------|----------|------|----|
| USER_L2_ACL    | Shared:1 | G3   | 1  |
| 2              | 1022     | 1024 |    |
| USER_IPV4_ACL  | Shared:1 | G2   | 2  |
| 3              | 1021     | 1024 |    |
| USER_IPV6_ACL  | Shared:2 | G4   | 1  |
| 2              | 510      | 512  |    |
| PBR_V6         | Shared:2 | G10  | 1  |
| 1              | 511      | 512  |    |
| SYSTEM_FLOW    | Shared:2 | G0   | 49 |
| 49             | 975      | 1024 |    |
| ISCSI_SNOOPING | Shared:1 | G8   | 12 |
| 12             | 500      | 512  |    |
| FCOE           | Shared:2 | G6   | 55 |
| 55             | 457      | 512  |    |

```

Egress ACL utilization
Hardware Pools

```

| Pool ID | App(s)             | Used rows | Free rows | Max rows |
|---------|--------------------|-----------|-----------|----------|
| 0       | USER_IPV4_EGRESS   | 2         | 254       | 256      |
| 1       | USER_L2_ACL_EGRESS | 2         | 254       | 256      |
| 2       | USER_IPV6_EGRESS   | 2         | 254       | 256      |
| 3       | USER_IPV6_EGRESS   | 2         | 254       | 256      |

Service Pools

```

App Allocated pools App group Configured rules

```

| Used rows          | Free rows | Max rows |    |   |
|--------------------|-----------|----------|----|---|
| USER_L2_ACL_EGRESS | Shared:1  |          | G1 | 1 |
| 2                  | 254       | 256      |    |   |
| USER_IPV4_EGRESS   | Shared:1  |          | G0 | 1 |
| 2                  | 254       | 256      |    |   |
| USER_IPV6_EGRESS   | Shared:2  |          | G2 | 1 |
| 2                  | 254       | 256      |    |   |

**Supported Releases** 10.4.2 and later

## show ip as-path-access-list

Displays the configured AS path access lists.

**Syntax** `show ip as-path-access-list [name]`

**Parameters** *name* — (Optional) Specify the name of the AS path access list.

**Defaults** None

**Command Mode** EXEC

**Usage Information** None

**Example**

```
OS10# show ip as-path-access-list
ip as-path access-list hello
 permit 123
 deny 35
```

**Supported Releases** 10.3.0E or later

## show ip community-list

Displays the configured IP community lists in alphabetic order.

**Syntax** `show ip community-list [name]`

**Parameters** *name* — (Optional) Enter the name of the standard IP community list. A maximum of 140 characters.

**Defaults** None

**Command Mode** EXEC

**Usage Information** None

**Example**

```
OS10# show ip community-list
Standard Community List hello
 deny local-AS
 permit no-export
 deny 1:1
```

**Supported Releases** 10.3.0E or later

## show ip extcommunity-list

Displays the configured IP external community lists in alphabetic order.

|                           |                                                                                                                  |
|---------------------------|------------------------------------------------------------------------------------------------------------------|
| <b>Syntax</b>             | <code>show ip extcommunity-list [name]</code>                                                                    |
| <b>Parameters</b>         | <i>name</i> — (Optional) Enter the name of the extended IP external community list. A maximum of 140 characters. |
| <b>Defaults</b>           | None                                                                                                             |
| <b>Command Mode</b>       | EXEC                                                                                                             |
| <b>Usage Information</b>  | None                                                                                                             |
| <b>Example</b>            | <pre>OS10# show ip extcommunity-list Standard Extended Community List hello   permit RT:1:1   deny S00:1:4</pre> |
| <b>Supported Releases</b> | 10.3.0E or later                                                                                                 |

## show ip prefix-list

Displays configured IPv4 or IPv6 prefix list information.

|                           |                                                                                                                                                                                                                                       |
|---------------------------|---------------------------------------------------------------------------------------------------------------------------------------------------------------------------------------------------------------------------------------|
| <b>Syntax</b>             | <code>show {ip   ipv6} prefix-list [prefix-name]</code>                                                                                                                                                                               |
| <b>Parameters</b>         | <ul style="list-style-type: none"><li>• <i>ip   ipv6</i>—(Optional) Displays information related to IPv4 or IPv6.</li><li>• <i>prefix-name</i> — Enter a text string for the prefix list name. A maximum of 140 characters.</li></ul> |
| <b>Defaults</b>           | None                                                                                                                                                                                                                                  |
| <b>Command Mode</b>       | EXEC                                                                                                                                                                                                                                  |
| <b>Usage Information</b>  | None                                                                                                                                                                                                                                  |
| <b>Example</b>            | <pre>OS10# show ip prefix-list ip prefix-list hello: seq 10 deny 1.2.3.4/24 seq 20 permit 3.4.4.5/32</pre>                                                                                                                            |
| <b>Example (IPv6)</b>     | <pre>OS10# show ipv6 prefix-list ipv6 prefix-list hello: seq 10 permit 1::1/64 seq 20 deny 2::2/64</pre>                                                                                                                              |
| <b>Supported Releases</b> | 10.3.0E or later                                                                                                                                                                                                                      |

## show logging access-list

Displays the ACL logging threshold and interval configuration.

|                     |                                       |
|---------------------|---------------------------------------|
| <b>Syntax</b>       | <code>show logging access-list</code> |
| <b>Parameters</b>   | None                                  |
| <b>Default</b>      | None                                  |
| <b>Command Mode</b> | EXEC                                  |

**Usage Information** None

**Example**

```
OS10# show logging access-list
ACL Logging
Threshold : 10
Interval : 5
```

**Supported Releases** 10.4.3.0 or later

## Route-map commands

### continue

Configures the next sequence of the route map.

**Syntax** `continue seq-number`

**Parameters** `seq-number` — Enter the next sequence number, from 1 to 65535.

**Default** Not configured

**Command Mode** ROUTE-MAP

**Usage Information** The no version of this command deletes a match.

**Example**

```
OS10(config)# route-map bgp
OS10(conf-route-map)# continue 65535
```

**Supported Releases** 10.3.0E or later

### match as-path

Configures a filter to match routes that have a certain AS path in their BGP paths.

**Syntax** `match as-path as-path-name`

**Parameters** `as-path-name` — Enter the name of an established AS-PATH ACL. A maximum of 140 characters.

**Default** Not configured

**Command Mode** ROUTE-MAP

**Usage Information** The no version of this command deletes a match AS path filter.

**Example**

```
OS10(config)# route-map bgp
OS10(conf-route-map)# match as-path pathtest1
```

**Supported Releases** 10.3.0E or later

### match community

Configures a filter to match routes that have a certain COMMUNITY attribute in their BGP path.

**Syntax** `match community community-list-name [exact-match]`

|                           |                                                                                                                                                                                                                                             |
|---------------------------|---------------------------------------------------------------------------------------------------------------------------------------------------------------------------------------------------------------------------------------------|
| <b>Parameters</b>         | <ul style="list-style-type: none"> <li>• <i>community-list-name</i> — Enter the name of a configured community list.</li> <li>• <i>exact-match</i> — (Optional) Select only those routes with the specified community list name.</li> </ul> |
| <b>Default</b>            | Not configured                                                                                                                                                                                                                              |
| <b>Command Mode</b>       | ROUTE-MAP                                                                                                                                                                                                                                   |
| <b>Usage Information</b>  | The <code>no</code> version of this command deletes the community match filter.                                                                                                                                                             |
| <b>Example</b>            | <pre>OS10(config)# route-map bgp OS10(conf-route-map)# match community commlist1 exact-match</pre>                                                                                                                                          |
| <b>Supported Releases</b> | 10.3.0E or later                                                                                                                                                                                                                            |

## match extcommunity

Configures a filter to match routes that have a certain EXTCOMMUNITY attribute in their BGP path.

|                           |                                                                                                                                                                                                                                                      |
|---------------------------|------------------------------------------------------------------------------------------------------------------------------------------------------------------------------------------------------------------------------------------------------|
| <b>Syntax</b>             | <code>match extcommunity <i>extcommunity-list-name</i> [<i>exact-match</i>]</code>                                                                                                                                                                   |
| <b>Parameters</b>         | <ul style="list-style-type: none"> <li>• <i>extcommunity-list-name</i> — Enter the name of a configured extcommunity list.</li> <li>• <i>exact-match</i> — (Optional) Select only those routes with the specified extcommunity list name.</li> </ul> |
| <b>Default</b>            | Not configured                                                                                                                                                                                                                                       |
| <b>Command Mode</b>       | ROUTE-MAP                                                                                                                                                                                                                                            |
| <b>Usage Information</b>  | The <code>no</code> version of this command deletes the extcommunity match filter.                                                                                                                                                                   |
| <b>Example</b>            | <pre>OS10(config)# route-map bgp OS10(conf-route-map)# match extcommunity extcommlist1 exact-match</pre>                                                                                                                                             |
| <b>Supported Releases</b> | 10.3.0E or later                                                                                                                                                                                                                                     |

## match interface

Configures a filter to match routes whose next-hop is the configured interface.

|                          |                                                                                                                                                                                                                                                                                                                                                                                                                                                                          |
|--------------------------|--------------------------------------------------------------------------------------------------------------------------------------------------------------------------------------------------------------------------------------------------------------------------------------------------------------------------------------------------------------------------------------------------------------------------------------------------------------------------|
| <b>Syntax</b>            | <code>match interface <i>interface</i></code>                                                                                                                                                                                                                                                                                                                                                                                                                            |
| <b>Parameters</b>        | <p><i>interface</i> — Interface type:</p> <ul style="list-style-type: none"> <li>• <code>ethernet <i>node/slot/port[:subport]</i></code> — Enter the Ethernet interface information as the next-hop interface.</li> <li>• <code>port-channel <i>id-number</i></code> — Enter the port-channel number as the next-hop interface, from 1 to 128.</li> <li>• <code>vlan <i>vlan-id</i></code> — Enter the VLAN number as the next-hop interface, from 1 to 4093.</li> </ul> |
| <b>Default</b>           | Not configured                                                                                                                                                                                                                                                                                                                                                                                                                                                           |
| <b>Command Mode</b>      | ROUTE-MAP                                                                                                                                                                                                                                                                                                                                                                                                                                                                |
| <b>Usage Information</b> | The <code>no</code> version of this command deletes the match.                                                                                                                                                                                                                                                                                                                                                                                                           |
| <b>Example</b>           | <pre>OS10(conf-route-map)# match interface ethernet 1/1/1 OS10(conf-if-eth1/1/1)#</pre>                                                                                                                                                                                                                                                                                                                                                                                  |



**Supported Releases** 10.2.0E or later

## match ip address

Configures a filter to match routes based on IP addresses specified in IP prefix lists.

**Syntax** `match ip address {prefix-list prefix-list-name | access-list-name}`

**Parameters**

- *prefix-list-name* — Enter the name of the configured prefix list. A maximum of 140 characters.
- *access-list-name* — Enter the name of the configured access list.

**Default** Not configured

**Command Mode** ROUTE-MAP

**Usage Information** The no version of this command deletes a match.

**Example**

```
OS10(config)# route-map bgp
OS10(conf-route-map)# match ip address prefix-list test10
```

**Supported Releases** 10.3.0E or later

## match ip next-hop

Configures a filter to match based on the next-hop IP addresses specified in IP prefix lists.

**Syntax** `match ip next-hop prefix-list prefix-list`

**Parameters** *prefix-list* — Enter the name of the configured prefix list. A maximum of 140 characters.

**Default** Not configured

**Command Mode** ROUTE-MAP

**Usage Information** The no version of this command deletes the match.

**Example**

```
OS10(config)# route-map bgp
OS10(conf-route-map)# match ip next-hop prefix-list test100
```

**Supported Releases** 10.3.0E or later

## match ipv6 address

Configures a filter to match routes based on IPv6 addresses specified in IP prefix lists.

**Syntax** `match ipv6 address {prefix-list prefix-list | access-list}`

**Parameters**

- *prefix-list* — Enter the name of the configured prefix list. A maximum of 140 characters.
- *access-list* — Enter the name of the access group or list.

**Default** Not configured

**Command Mode** ROUTE-MAP

**Usage Information** The no version of this command deletes the match.

### Example

```
OS10(config)# route-map bgp
OS10(conf-route-map)# match ipv6 address test100
```

**Supported Releases** 10.3.0E or later

## match ipv6 next-hop

Configures a filter to match based on the next-hop IPv6 addresses specified in IP prefix lists.

**Syntax** `match ipv6 next-hop prefix-list prefix-list`

**Parameters** *prefix-list* — Enter the name of the configured prefix list. A maximum of 140 characters.

**Default** Not configured

**Command Mode** ROUTE-MAP

**Usage Information** The no version of this command deletes the match.

### Example

```
OS10(config)# route-map bgp
OS10(conf-route-map)# match ipv6 next-hop prefix-list test100
```

**Supported Releases** 10.3.0E or later

## match metric

Configures a filter to match on a specific value.

**Syntax** `match metric metric-value`

**Parameters** *metric-value* — Enter a value to match the route metric against, from 0 to 4294967295.

**Default** Not configured

**Command Mode** ROUTE-MAP

**Usage Information** The no version of this command deletes the match.

### Example

```
OS10(conf-route-map)# match metric 429132
```

**Supported Releases** 10.2.0E or later

## match origin

Configures a filter to match routes based on the origin attribute of BGP.

**Syntax** `match origin {egp | igp | incomplete}`

**Parameters**

- *egp* — Match only remote EGP routes.
- *igp* — Match only on local IGP routes.
- *incomplete* — Match on unknown routes that are learned through some other means.

**Default** Not configured

**Command Mode** ROUTE-MAP

**Usage Information** The no version of this command deletes the match.

**Example**

```
OS10(config)# route-map bgp
OS10(conf-route-map)# match origin egp
```

**Supported Releases** 10.3.0E or later

## match route-type

Configures a filter to match routes based on how the route is defined.

**Syntax** `match route-type {{external {type-1 | type-2} | internal | local }`

**Parameters**

- `external` — Match only on external OSPF routes. Enter the keyword then one of the following:
  - `type-1` — Match only on OSPF Type 1 routes.
  - `type-2` — Match only on OSPF Type 2 routes.
- `internal` — Match only on routes generated within OSPF areas.
- `local` — Match only on routes generated locally.

**Default** Not configured

**Command Mode** ROUTE-MAP

**Usage Information** The no version of this command deletes the match.

**Example**

```
OS10(config)# route-map bgp
OS10(conf-route-map)# match route-type external type-1
```

**Supported Releases** 10.3.0E or later

## match tag

Configures a filter to redistribute only routes that match a specific tag value.

**Syntax** `match tag tag-value`

**Parameters** `tag-value` — Enter the tag value to match with the tag number, from 0 to 4294967295.

**Default** Not configured

**Command Mode** ROUTE-MAP

**Usage Information** The no version of this command deletes the match.

**Example**

```
OS10(conf-route-map)# match tag 656442
```

**Supported Releases** 10.2.0E or later

## route-map

Enables a route-map statement and configures its action and sequence number.

**Syntax** `route-map map-name [permit | deny | sequence-number]`

|                           |                                                                                                                                                                                                                                                                                                                                                                                                                                                   |
|---------------------------|---------------------------------------------------------------------------------------------------------------------------------------------------------------------------------------------------------------------------------------------------------------------------------------------------------------------------------------------------------------------------------------------------------------------------------------------------|
| <b>Parameters</b>         | <ul style="list-style-type: none"> <li>• <i>map-name</i> — Enter the name of the route-map. A maximum of 140 characters.</li> <li>• <i>sequence-number</i> — (Optional) Enter the number to identify the route-map for editing and sequencing number from 1 to 65535. The default is 10.</li> <li>• <i>permit</i> — (Optional) Set the route-map default as permit.</li> <li>• <i>deny</i> — (Optional) Set the route default as deny.</li> </ul> |
| <b>Default</b>            | Not configured                                                                                                                                                                                                                                                                                                                                                                                                                                    |
| <b>Command Mode</b>       | CONFIGURATION                                                                                                                                                                                                                                                                                                                                                                                                                                     |
| <b>Usage Information</b>  | <p> <b>NOTE:</b> Exercise caution when you delete route-maps — if you do not enter a sequence number, all route-maps with the same map-name are deleted.</p> <p>The <code>no</code> version of this command removes a route-map.</p>                                                                                                                             |
| <b>Example</b>            | <pre>OS10(config)# route-map routel permit 100 OS10(config-route-map)#</pre>                                                                                                                                                                                                                                                                                                                                                                      |
| <b>Supported Releases</b> | 10.2.0E or later                                                                                                                                                                                                                                                                                                                                                                                                                                  |

## set comm-list add

Add communities in the specified list to the COMMUNITY attribute in a matching inbound or outbound BGP route.

|                           |                                                                                                                                                                                                                                                                                             |
|---------------------------|---------------------------------------------------------------------------------------------------------------------------------------------------------------------------------------------------------------------------------------------------------------------------------------------|
| <b>Syntax</b>             | <code>set comm-list {community-list-name} add</code>                                                                                                                                                                                                                                        |
| <b>Parameters</b>         | <i>community-list-name</i> — Enter the name of an established community list. A maximum of 140 characters.                                                                                                                                                                                  |
| <b>Defaults</b>           | None                                                                                                                                                                                                                                                                                        |
| <b>Command Mode</b>       | ROUTE-MAP                                                                                                                                                                                                                                                                                   |
| <b>Usage Information</b>  | In a route map, use this <code>set</code> command to add a list of communities that pass a permit statement to the COMMUNITY attribute of a BGP route sent or received from a BGP peer. Use the <code>set comm-list delete</code> command to delete a community list from a matching route. |
| <b>Example</b>            | <pre>OS10(config)# route-map bgp OS10(conf-route-map)# set comm-list comlist1 add</pre>                                                                                                                                                                                                     |
| <b>Supported Releases</b> | 10.4.0E(R1) or later                                                                                                                                                                                                                                                                        |

## set comm-list delete

Remove communities in the specified list from the COMMUNITY attribute in a matching inbound or outbound BGP route.

|                          |                                                                                                                                                                                                                                                                                                                                                                                                                                                                                                                                                                                                                                                                                  |
|--------------------------|----------------------------------------------------------------------------------------------------------------------------------------------------------------------------------------------------------------------------------------------------------------------------------------------------------------------------------------------------------------------------------------------------------------------------------------------------------------------------------------------------------------------------------------------------------------------------------------------------------------------------------------------------------------------------------|
| <b>Syntax</b>            | <code>set comm-list {community-list-name} delete</code>                                                                                                                                                                                                                                                                                                                                                                                                                                                                                                                                                                                                                          |
| <b>Parameters</b>        | <i>community-list-name</i> — Enter the name of an established community list. A maximum of 140 characters.                                                                                                                                                                                                                                                                                                                                                                                                                                                                                                                                                                       |
| <b>Defaults</b>          | None                                                                                                                                                                                                                                                                                                                                                                                                                                                                                                                                                                                                                                                                             |
| <b>Command Mode</b>      | ROUTE-MAP                                                                                                                                                                                                                                                                                                                                                                                                                                                                                                                                                                                                                                                                        |
| <b>Usage Information</b> | Configure the community list you use in the <code>set comm-list delete</code> command so that each filter contains only one community. For example, the filter <code>deny 100:12</code> is acceptable, but the filter <code>deny 120:13 140:33</code> results in an error. If you configure the <code>set comm-list delete</code> command and the <code>set community</code> command in the same route map sequence, the deletion <code>set comm-list delete</code> command processes before the insertion <code>set community</code> command. To add communities in a community list to the COMMUNITY attribute in a BGP route, use the <code>set comm-list add</code> command. |

### Example

```
OS10(config)# route-map bgp
OS10(conf-route-map)# set comm-list comlist1 delete
```

**Supported Releases** 10.3.0E or later

## set community

Sets the community attribute in BGP updates.

**Syntax** `set community {none | community-number}`

**Parameters**

- `none` — Enter to remove the community attribute from routes meeting the route map criteria.
- `community-number` — Enter the community number in `aa:nn` format, where `aa` is the AS number, 2 bytes, and `nn` is a value specific to that AS.

**Default** Not configured

**Command Mode** ROUTE-MAP

**Usage Information** The `no` version of this command deletes a BGP COMMUNITY attribute assignment.

### Example

```
OS10(config)# route-map bgp
OS10(conf-route-map)# set community none
```

**Supported Releases** 10.3.0E or later

## set extcomm-list add

Add communities in the specified list to the EXTCOMMUNITY attribute in a matching inbound or outbound BGP route.

**Syntax** `set extcomm-list extcommunity-list-name add`

**Parameter** `extcommunity-list-name` — Enter the name of an established extcommunity list. A maximum of 140 characters.

**Defaults** None

**Command Mode** ROUTE-MAP

**Usage Information** In a route map, use this `set` command to add an extended list of communities that pass a permit statement to the EXTCOMMUNITY attribute of a BGP route sent or received from a BGP peer. Use the `set extcomm-list delete` command to delete an extended community list from a matching route.

### Example

```
OS10(config)# route-map bgp
OS10(conf-route-map)# set extcomm-list TestList add
```

**Supported Releases** 10.4.0E(R1) or later

## set extcomm-list delete

Remove communities in the specified list from the EXTCOMMUNITY attribute in a matching inbound or outbound BGP route.

**Syntax** `set extcomm-list extcommunity-list-name delete`

**Parameter** `extcommunity-list-name` — Enter the name of an established extcommunity list. A maximum of 140 characters.

|                           |                                                                                                                                             |
|---------------------------|---------------------------------------------------------------------------------------------------------------------------------------------|
| <b>Defaults</b>           | None                                                                                                                                        |
| <b>Command Mode</b>       | ROUTE-MAP                                                                                                                                   |
| <b>Usage Information</b>  | To add communities in an extcommunity list to the EXTCOMMUNITY attribute in a BGP route, use the <code>set extcomm-list add</code> command. |
| <b>Example</b>            | <pre>OS10(config)# route-map bgp OS10(conf-route-map)# set extcomm-list TestList delete</pre>                                               |
| <b>Supported Releases</b> | 10.3.0E or later                                                                                                                            |

## set extcommunity

Sets the extended community attributes in a route map for BGP updates.

|                           |                                                                                                                                                                                                                                                                                                                                                                                      |
|---------------------------|--------------------------------------------------------------------------------------------------------------------------------------------------------------------------------------------------------------------------------------------------------------------------------------------------------------------------------------------------------------------------------------|
| <b>Syntax</b>             | <code>set extcommunity rt {asn2:nn   asn4:nnnn   ip-addr:nn}</code>                                                                                                                                                                                                                                                                                                                  |
| <b>Parameters</b>         | <ul style="list-style-type: none"> <li>• <code>asn2:nn</code> — Enter an AS number in 2-byte format; for example, 1-65535:1-4294967295.</li> <li>• <code>asn4:nnnn</code> — Enter an AS number in 4-byte format; for example, 1-4294967295:1-65535 or 1-65535.1-65535:1-65535.</li> <li>• <code>ip-addr:nn</code> — Enter an AS number in dotted format, from 1 to 65535.</li> </ul> |
| <b>Default</b>            | Not configured                                                                                                                                                                                                                                                                                                                                                                       |
| <b>Command Mode</b>       | ROUTE-MAP                                                                                                                                                                                                                                                                                                                                                                            |
| <b>Usage Information</b>  | The <code>no</code> version of this command deletes the <code>set</code> clause from a route map.                                                                                                                                                                                                                                                                                    |
| <b>Example</b>            | <pre>OS10(config)# route-map bgp OS10(conf-route-map)# set extcommunity rt 10.10.10.2:325</pre>                                                                                                                                                                                                                                                                                      |
| <b>Supported Releases</b> | 10.3.0E or later                                                                                                                                                                                                                                                                                                                                                                     |

## set local-preference

Sets the preference value for the AS path.

|                           |                                                                                                                                                                                                                                                                            |
|---------------------------|----------------------------------------------------------------------------------------------------------------------------------------------------------------------------------------------------------------------------------------------------------------------------|
| <b>Syntax</b>             | <code>set local-preference value</code>                                                                                                                                                                                                                                    |
| <b>Parameters</b>         | <code>value</code> — Enter a number as the LOCAL_PREF attribute value, from 0 to 4294967295.                                                                                                                                                                               |
| <b>Default</b>            | Not configured                                                                                                                                                                                                                                                             |
| <b>Command Mode</b>       | ROUTE-MAP                                                                                                                                                                                                                                                                  |
| <b>Usage Information</b>  | This command changes the LOCAL_PREF attribute for routes meeting the route map criteria. To change the LOCAL_PREF for all routes, use the <code>bgp default local-preference</code> command. The <code>no</code> version of this command removes the LOCAL_PREF attribute. |
| <b>Example</b>            | <pre>OS10(conf-route-map)# set local-preference 200</pre>                                                                                                                                                                                                                  |
| <b>Supported Releases</b> | 10.2.0E or later                                                                                                                                                                                                                                                           |

## set metric

Set a metric value for a routing protocol.

|                           |                                                                                                                                                                                                                                                                                                                                                                                                                                                                                                                            |
|---------------------------|----------------------------------------------------------------------------------------------------------------------------------------------------------------------------------------------------------------------------------------------------------------------------------------------------------------------------------------------------------------------------------------------------------------------------------------------------------------------------------------------------------------------------|
| <b>Syntax</b>             | <code>set metric [+   -] metric-value</code>                                                                                                                                                                                                                                                                                                                                                                                                                                                                               |
| <b>Parameters</b>         | <ul style="list-style-type: none"><li>• <code>+</code> — (Optional) Add a metric value to the redistributed routes.</li><li>• <code>-</code> — (Optional) Subtract a metric value from the redistributed routes.</li><li>• <code>metric-value</code> — Enter a new metric value, from 0 to 4294967295.</li></ul>                                                                                                                                                                                                           |
| <b>Default</b>            | Not configured                                                                                                                                                                                                                                                                                                                                                                                                                                                                                                             |
| <b>Command Mode</b>       | ROUTE-MAP                                                                                                                                                                                                                                                                                                                                                                                                                                                                                                                  |
| <b>Usage Information</b>  | To establish an absolute metric, do not enter a plus or minus sign before the metric value. To establish a relative metric, enter a plus or minus sign immediately preceding the metric value. The value is added to or subtracted from the metric of any routes matching the route map. You cannot use both an absolute metric and a relative metric within the same route map sequence. Setting either metric overrides any previously configured value. The <code>no</code> version of this command removes the filter. |
| <b>Example (Absolute)</b> | <pre>OS10(conf-route-map)# set metric 10</pre>                                                                                                                                                                                                                                                                                                                                                                                                                                                                             |
| <b>Example (Relative)</b> | <pre>OS10(conf-route-map)# set metric -25</pre>                                                                                                                                                                                                                                                                                                                                                                                                                                                                            |
| <b>Supported Releases</b> | 10.2.0E or later                                                                                                                                                                                                                                                                                                                                                                                                                                                                                                           |

## set metric-type

Set the metric type for the a redistributed routel.

|                          |                                                                                                                                                                                                                                                                                                                                                                                                                                                                                                                                                                                                                                                                                                                                                                                                                                                                                                                                                                                                                                                                                                                                                                                                                                                                                                                                                                  |
|--------------------------|------------------------------------------------------------------------------------------------------------------------------------------------------------------------------------------------------------------------------------------------------------------------------------------------------------------------------------------------------------------------------------------------------------------------------------------------------------------------------------------------------------------------------------------------------------------------------------------------------------------------------------------------------------------------------------------------------------------------------------------------------------------------------------------------------------------------------------------------------------------------------------------------------------------------------------------------------------------------------------------------------------------------------------------------------------------------------------------------------------------------------------------------------------------------------------------------------------------------------------------------------------------------------------------------------------------------------------------------------------------|
| <b>Syntax</b>            | <code>set metric-type {type-1   type-2   external}</code>                                                                                                                                                                                                                                                                                                                                                                                                                                                                                                                                                                                                                                                                                                                                                                                                                                                                                                                                                                                                                                                                                                                                                                                                                                                                                                        |
| <b>Parameters</b>        | <ul style="list-style-type: none"><li>• <code>type-1</code> — Adds a route to an existing community.</li><li>• <code>type-2</code> — Sends a route in the local AS.</li><li>• <code>external</code> — Disables advertisement to peers.</li></ul>                                                                                                                                                                                                                                                                                                                                                                                                                                                                                                                                                                                                                                                                                                                                                                                                                                                                                                                                                                                                                                                                                                                 |
| <b>Default</b>           | Not configured                                                                                                                                                                                                                                                                                                                                                                                                                                                                                                                                                                                                                                                                                                                                                                                                                                                                                                                                                                                                                                                                                                                                                                                                                                                                                                                                                   |
| <b>Command Mode</b>      | ROUTE-MAP                                                                                                                                                                                                                                                                                                                                                                                                                                                                                                                                                                                                                                                                                                                                                                                                                                                                                                                                                                                                                                                                                                                                                                                                                                                                                                                                                        |
| <b>Usage Information</b> | <ul style="list-style-type: none"><li>• <b>BGP</b><p>Affects BGP behavior only in outbound route maps and has no effect on other types of route maps. If the route map contains both a <code>set metric-type</code> and a <code>set metric</code> clause, the <code>set metric</code> clause takes precedence. If you enter the <code>internal</code> metric type in a BGP outbound route map, BGP sets the MED of the advertised routes to the IGP cost of the next hop of the advertised route. If the cost of the next hop changes, BGP is not forced to readvertise the route.</p><ul style="list-style-type: none"><li>◦ <code>external</code> — Reverts to the normal BGP rules for propagating the MED, the default.</li><li>◦ <code>internal</code> — Sets the MED of a received route that is being propagated to an external peer equal to the IGP costs of the indirect next hop.</li></ul></li><li>• <b>OSPF</b><ul style="list-style-type: none"><li>◦ <code>external</code> — Sets the cost of the external routes so that it is equal to the sum of all internal costs and the external cost.</li><li>◦ <code>internal</code> — Sets the cost of the external routes so that it is equal to the external cost alone, the default.</li></ul></li></ul> <p>The <code>no</code> version of this command removes the set clause from a route map.</p> |
| <b>Example</b>           | <pre>OS10(conf-route-map)# set metric-type internal</pre>                                                                                                                                                                                                                                                                                                                                                                                                                                                                                                                                                                                                                                                                                                                                                                                                                                                                                                                                                                                                                                                                                                                                                                                                                                                                                                        |

**Supported Releases** 10.2.0E or later

## set next-hop

Sets an IPv4 or IPv6 address as the next-hop.

**Syntax** `set {ip | ipv6} next-hop ip-address`

**Parameters** `ip-address` — Enter the IPv4 or IPv6 address for the next-hop.

**Default** Not configured

**Command Mode** ROUTE-MAP

**Usage Information** If you apply a route-map with the `set next-hop` command in ROUTER-BGP mode, it takes precedence over the `next-hop-self` command used in ROUTER-NEIGHBOR mode. In a route-map configuration, to configure more than one next-hop entry, use multiple `set {ip | ipv6} next-hop` commands. When you apply a route-map for redistribution or route updates in ROUTER-BGP mode, configure only one next-hop. Configure multiple next-hop entries only in a route-map used for other features, such as policy-based routing (PBR). The `no` version of this command deletes the setting.

**Example**

```
OS10(conf-route-map)# set ip next-hop 10.10.10.2
```

**Example (IPv6)**

```
OS10(conf-route-map)# set ipv6 next-hop 11AA:22CC::9
```

**Supported Releases** 10.2.0E or later

## set origin

Set the origin of the advertised route.

**Syntax** `set origin {egp | igp | incomplete}`

**Parameters**

- `egp` — Enter to add to existing community.
- `igp` — Enter to send inside the local-AS.
- `incomplete` — Enter to not advertise to peers.

**Default** Not configured

**Command Mode** ROUTE-MAP

**Usage Information** The `no` version of this command deletes the `set` clause from a route map.

**Example**

```
OS10(conf-route-map)# set origin egp
```

**Supported Releases** 10.2.0E or later

## set tag

Sets a tag for redistributed routes.

**Syntax** `set tag tag-value`

**Parameters** `tag-value` — Enter a tag number for the route to redistribute, from 0 to 4294967295.

**Default** Not configured



|                           |                                                                                      |
|---------------------------|--------------------------------------------------------------------------------------|
| <b>Command Mode</b>       | CONFIGURATION                                                                        |
| <b>Usage Information</b>  | The <code>no</code> version of this command deletes the set clause from a route map. |
| <b>Example</b>            | <pre>OS10(conf-route-map)# set tag 23</pre>                                          |
| <b>Supported Releases</b> | 10.2.0E or later                                                                     |

## set weight

Set the BGP weight for the routing table.

|                           |                                                                                                                   |
|---------------------------|-------------------------------------------------------------------------------------------------------------------|
| <b>Syntax</b>             | <code>set weight <i>weight</i></code>                                                                             |
| <b>Parameters</b>         | <i>weight</i> — Enter a number as the weight the route uses to meet the route map specification, from 0 to 65535. |
| <b>Default</b>            | Default router-originated is 32768 — all other routes are 0.                                                      |
| <b>Command Mode</b>       | ROUTE-MAP                                                                                                         |
| <b>Usage Information</b>  | The <code>no</code> version of the command deletes the set clause from the route map.                             |
| <b>Example</b>            | <pre>OS10(conf-route-map)# set weight 200</pre>                                                                   |
| <b>Supported Releases</b> | 10.2.0E or later                                                                                                  |

## show route-map

Displays the current route map configurations.

|                           |                                                                                                                                                                                                                                                                                                     |
|---------------------------|-----------------------------------------------------------------------------------------------------------------------------------------------------------------------------------------------------------------------------------------------------------------------------------------------------|
| <b>Syntax</b>             | <code>show route-map [<i>map-name</i>]</code>                                                                                                                                                                                                                                                       |
| <b>Parameters</b>         | <i>map-name</i> — (Optional) Specify the name of a configured route map. A maximum of 140 characters.                                                                                                                                                                                               |
| <b>Defaults</b>           | None                                                                                                                                                                                                                                                                                                |
| <b>Command Mode</b>       | EXEC                                                                                                                                                                                                                                                                                                |
| <b>Usage Information</b>  | None                                                                                                                                                                                                                                                                                                |
| <b>Example</b>            | <pre>OS10# show route-map route-map abc, permit, sequence 10   Match clauses:     ip address (access-lists): hello     as-path abc     community hello     metric 2     origin egp     route-type external type-1     tag 10   Set clauses:     metric-type type-1     origin igp     tag 100</pre> |
| <b>Supported Releases</b> | 10.3.0E or later                                                                                                                                                                                                                                                                                    |

## Quality of service

Quality of service (QoS) reserves network resources for highly critical application traffic with precedence over less critical application traffic. QoS prioritizes different types of traffic and ensures quality of service.

You can control the following traffic flow parameters: Delay, Bandwidth, Jitter, and Drop.

Different QoS features control the traffic flow parameters, as the traffic traverses a network device from ingress to egress interfaces.



## Configure quality of service

Network traffic processes based on classification & policies that apply to the traffic.

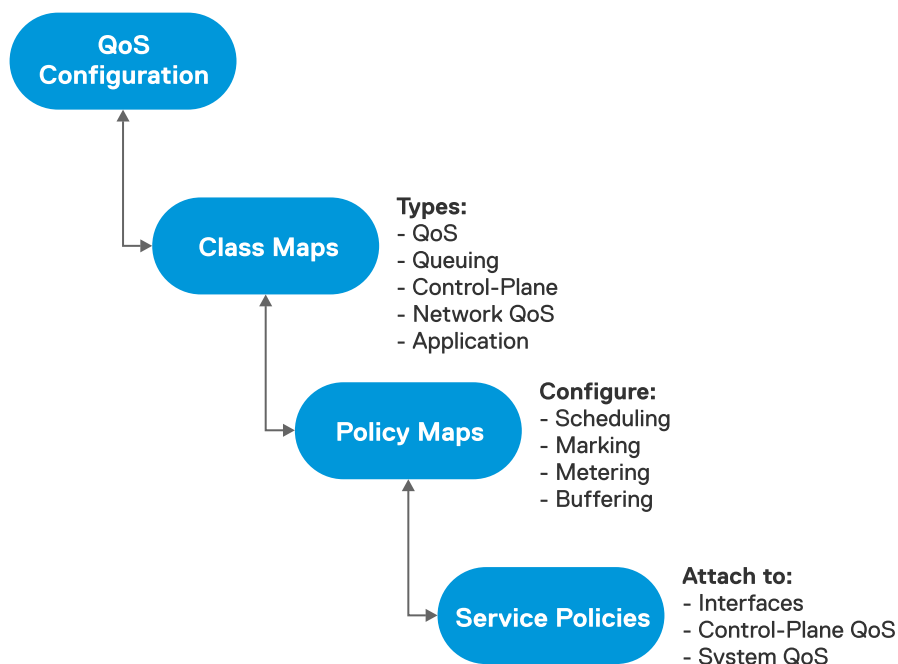

Configuring QoS is a three-step process:

1. Create class-maps to classify the traffic flows. The following are the different types of class-maps:
  - qos (default)—Classifies ingress data traffic.
  - queuing —Classifies egress queues.
  - control-plane—Classifies control-plane traffic.
  - network-qos—Classifies traffic-class IDs for ingress buffer configurations.
  - application —Classifies application-type traffic. The reserved policy-map **policy-iscsi** defines the actions for **class-iscsi** traffic.
2. Create policy-maps to define the policies for the classified traffic flows. The following are the different types of policy-maps:
  - qos (default)—Defines the following actions on the traffic classified based on **qos** class-map:
    - Policing
    - Marking with a traffic class ID
    - Modifying packet fields such as CoS and DSCP
  - queuing —Defines the following actions on the egress queues classified based on **queuing** class-map:
    - Shaping
    - Assigning bandwidth for queues
    - Assigning strict priority for queues
    - Buffering configuration for queues
    - Weighted random early detection (WRED)/Explicit congestion notification (ECN) configuration on queues
  - control-plane—Defines the policing of control queues for rate-limiting the **control-plane** traffic on CPU queues.
  - network-qos—Defines the Ingress buffer configuration for selected traffic-classes matched based on **network-qos** class-map.
  - application —Defines the following actions for the **application** classified traffic:
    - Modifying packet fields such as CoS and DSCP.
    - Marking traffic class IDs.
3. Apply the policy-maps to the port interface, system for all interfaces, or control-plane traffic as follows:
  - Apply control-plane polices in Control-Plane mode.
  - Apply QoS and network-QoS policies in the input direction on physical interfaces or in System-QoS mode.
  - Apply queuing policies in the output direction on physical interfaces or in System-QoS mode.
  - Apply an application type policy-map in System-QoS mode.

When you apply a policy at the system level (System-QoS mode), the policy is effective on all the ports in the system. However, the interface-level policy takes precedence over the system-level policy.

# Ingress traffic classification

Ingress traffic can either be data or control traffic.

OS10 groups network traffic into different traffic classes, from class 0 to 7 based on various parameters. Grouping traffic into different classes helps to identify and prioritize traffic as it goes through the switch.

 **NOTE:** Traffic class is also called as QoS group.

By default, OS10 does not classify data traffic. OS10 assigns the default traffic class ID 0 to all data traffic.

OS10 implicitly classifies all control traffic such as STP, OSPF, ICMP, and so on, and forwards the traffic to control plane applications. See [Control-plane policing](#) for more information.

## Data traffic classification

You can classify the data traffic based on ACL or trust.

ACL-based classification consumes significant amount of network processor resources. Trust-based classification classifies traffic in a pre-defined way without using network processor resources.

## Trust based classification

OS10 supports classification based on the 802.1p CoS field (L2) or DSCP field (L3).

### 802.1p CoS trust map:

Trust the 802.1p CoS field to mark with a traffic-class ID and color for the CoS flow. Weighted random early detection (WRED) uses color to define drop-probabilities and thresholds for egress traffic. See [Color traffic](#) for more information. By default, 802.1p priority level 0 is assigned traffic class (TC) ID 1 and 802.1p priority level 1 is assigned TC 0. The rest of the 802.1p priority levels (2 through 7) are assigned the respective TC IDs.

**Table 81. Default 802.1p CoS trust map**

| CoS | Traffic class ID | Color |
|-----|------------------|-------|
| 0   | 1                | G     |
| 1   | 0                | G     |
| 2   | 2                | G     |
| 3   | 3                | G     |
| 4   | 4                | G     |
| 5   | 5                | G     |
| 6   | 6                | G     |
| 7   | 7                | G     |

 **NOTE:** You cannot modify the default CoS trust map.

### User-defined 802.1p CoS trust map

You can override the default mapping by creating a dot1p trust map. All the unspecified dot1p entries map to the default traffic class ID 0.

#### Configure user-defined 802.1p CoS trust map

1. Create a dot1p trust map.

```
OS10(config)# trust dot1p-map example-dot1p-trustmap-name
OS10(config-tmap-dot1p-map) #
```

2. Define the set of dot1p values mapped to traffic-class, the qos-group ID.

```
OS10(config-tmap-dot1p-map)# qos-group 3 dot1p 0-4
OS10(config-tmap-dot1p-map)# qos-group 5 dot1p 5-7
```

3. Verify the map entries.

```
OS10# show qos maps type trust-map-dot1p example-dot1p-trustmap-name

DOT1P Priority to Traffic-Class Map : example-dot1p-trustmap-name
Traffic-Class DOT1P Priority

3 0-4
5 5-7
```

4. Apply the map on a specific interface or on system-qos, global level.

- Interface level

```
OS10(conf-if-eth1/1/1)# trust-map dot1p example-dot1p-trustmap-name
```

**NOTE:** In the interface level, the `no` version of the command returns the configuration to the system-qos level. If there is no configuration available at the system-qos level, the configuration returns to default mapping.

- System-qos level

```
OS10(config-sys-qos)# trust-map dot1p example-dot1p-trustmap-name
```

**Apply CoS trust map**

After you create a trust map, you must apply the trust map at the interface or system-qos level. To apply the trust map on a specific interface or on system-qos (global) level:

- Interface level

```
OS10(conf-if-eth1/1/1)# trust-map dot1p example-dot1p-trustmap-name
```

**NOTE:** In the interface level, the `no` version of the command returns the configuration to system-qos level. If there is no configuration available at the system-qos level, then the configuration returns to default mapping.

- System-qos level

```
OS10(config-sys-qos)# trust-map dot1p example-dot1p-trustmap-name
```

**DSCP trust map:**

Assign a predefined and reserved trust classification in the policy map for the DSCP flow. Weighted random early detection (WRED) uses the color assigned to a particular traffic to determine the drop-probability and threshold.

**Table 82. Default DSCP trust map**

| DSCP values | Traffic class ID | Color |
|-------------|------------------|-------|
| 0-3         | 0                | G     |
| 4-7         | 0                | Y     |
| 8-11        | 1                | G     |
| 12-15       | 1                | Y     |
| 16-19       | 2                | G     |
| 20-23       | 2                | Y     |
| 24-27       | 3                | G     |
| 28-31       | 3                | Y     |

**Table 82. Default DSCP trust map (continued)**

| DSCP values | Traffic class ID | Color |
|-------------|------------------|-------|
| 32-35       | 4                | G     |
| 36-39       | 4                | Y     |
| 40-43       | 5                | G     |
| 44-47       | 5                | Y     |
| 48-51       | 6                | G     |
| 52-55       | 6                | Y     |
| 56-59       | 7                | G     |
| 60-62       | 7                | Y     |
| 63          | 7                | R     |

 **NOTE:** You cannot modify the default DSCP trust map.

### User-defined DSCP trust map

You can override the default mapping by creating a user-defined DSCP trust map. All the unspecified DSCP entries map to the default traffic class ID 0 and color G.

### Configure user-defined DSCP trust map

1. Create a DSCP trust map.

```
OS10(config)# trust dscp-map example-dscp-trustmap-name
OS10(config-tmap-dscp-map)#
```

2. Define the set of dscp values mapped to traffic-class, the qos-group ID.

```
OS10(config-tmap-dscp-map)# qos-group 3 dscp 0-15
OS10(config-tmap-dscp-map)# qos-group 5 dscp 16-30
```

3. Verify the map entries.

```
OS10# show qos maps type trust-map-dscp example-dscp-trustmap-name

DSCP Priority to Traffic-Class Map : example-dscp-trustmap-name
Traffic-Class DSCP Priority

3 0-15
5 16-30
```

4. Apply the map on a specific interface or on system-qos global level.

- Interface level

```
OS10(conf-if-eth1/1/1)# trust-map dscp example-dscp-trustmap-name
```

- System-qos level

```
OS10(config-sys-qos)# trust-map dscp example-dscp-trustmap-name
```

### Apply DSCP trust map

You must apply the trust map at the interface or system-qos level. To apply the trust map on a specific interface or on system-qos (global) level:

- Interface level

```
OS10(config-if-eth1/1/1)# trust-map dscp example-dscp-trustmap-name
```

- System-qos level

```
OS10(config-sys-qos)# trust-map dscp example-dscp-trustmap-name
```

## ACL-based classification

Classify the ingress traffic by matching the packet fields using ACL entries.

Classify the traffic flows based on QoS-specific fields or generic fields, using IP or MAC ACLs. Create a class-map template to match the fields.

OS10 allows matching *any* of the fields or *all* the fields based on the match type you configure in the class-map.

Use the access-group match filter to match MAC or IP ACLs. You can configure a maximum of four access-group filters in a class-map:

- 802.1p CoS
- VLAN ID (802.1Q)
- DSCP + ECN
- IP precedence

OS10 supports configuring a range of or comma-separated values of match filters, except for VLAN ID. When you apply the same match filter with new values, the system overwrites the previous values with the new values.

### Configure ACL based classification

1. Create a class-map of type qos.

```
OS10(config)# class-map type qos example-cmap-cos
```

2. Define the field to match:

```
OS10(config-cmap-qos)# match cos 3
```

3. Create a qos-type policy-map to refer the classes to.

```
OS10(config)# policy-map type qos example-pmap-cos
```

4. Refer the class-maps in the policy-map and define the required action for the flows.

```
OS10# configure terminal
OS10(config)# class-map type qos example-cmap-cos
OS10(config-cmap-qos)# match cos 3
OS10(config-cmap-qos)# exit
OS10(config)# policy-map type qos example-pmap-cos
OS10(config-pmap-qos)# class example-cmap-cos
OS10(config-pmap-c-qos)# set qos-group 3
```

5. Apply the qos-type policy-map globally or to an interface. In this example, the policy-map is applied to an interface.

```
OS10# configure terminal
OS10(config)# interface ethernet 1/1/14
OS10(config-if-eth1/1/14)# service-policy input type qos example-pmap-cos
```

If the traffic that arrives at the interface matches the 802.1p criteria that you have configured, it is assigned to TC 3 or qos group 3.

## ACL-based classification with trust

This section describes how to configure ACL based classification when you configure trust-based classification.

If you configure ACL-based classification for a set of DSCP/COS values as well as trust-based classification on a particular port, the ACL-based classification takes precedence over trust-based classification.

1. Create a user defined dscp or dot1p trust-map.

```
OS10(config)# trust dscp-map userdef-dscp
OS10(config-tmap-dscp-map)# qos-group 3 dscp 15
OS10(config-tmap-dscp-map)# qos-group 5 dscp 30
```

2. Apply user-defined trust map to an interface or in system QoS.

```
OS10(conf-if-eth1/1/1)# trust-map dscp userdef-dscp

or

OS10(config)# system qos
OS10(config-sys-qos)# trust-map dscp userdef-dscp
```

3. Create a class-map and attach it to a policy where trust is configured. This example uses 802.1p cos to define the match criteria. You can use dscp or other access group match filters. If the 802.1p traffic matches the defined criteria, the `set qos-group 1` command assigns the traffic to TC 1.

```
OS10(config)# class-map type qos example-class-map
OS10(config-cmap-qos)# match cos 1
OS10(config-cmap-qos)# exit

OS10(config)# policy-map type qos example-policy-map
OS10(config-pmap-qos)# class example-class-map
OS10(config-pmap-c-qos)# set qos-group 1
```

4. Attach the policy map to an interface or in system QoS mode.

```
OS10(config)# interface ethernet 1/1/1
OS10(conf-if-eth1/1/1)# service-policy input type qos example-policy-map

or

OS10(config)# system qos
OS10(config-sys-qos)# service-policy input type qos example-policy-map
```

In this example, DSCP 15 flow is mapped to traffic class 3 or qos-group 3 and DSCP 30 flow is mapped to TC 5 or qos-group 5. The rest of the DSCP flows are mapped based on the trust that is configured.

## Control-plane policing

Control-plane policing (CoPP) increases security on the system by protecting the route processor from unnecessary traffic and giving priority to important control plane and management traffic. CoPP uses a dedicated control plane configuration through the QoS CLIs to set rate-limiting capabilities for control plane packets.

If the rate of control packets towards the CPU is higher than the packet rate that the CPU can handle, CoPP provides a method to selectively drop some of the control traffic so that the CPU can process high-priority control traffic. You can use CoPP to rate-limit traffic through each CPU port queue of the network processor (NPU).

CoPP applies policy actions on all control-plane traffic. The control-plane class map does not use any match criteria. To enforce rate-limiting or rate policing on control-plane traffic, create policy maps. You can use the `control-plane` command to attach the CoPP service policies directly to the control-plane.

Starting from release 10.4.2, the default rate limits have changed from 12 CPU queues and the protocols mapped to each CPU queue are changed.

**NOTE:** When you upgrade from a previous release to release 10.4.2 and you have CoPP policy with rate limits configured in the previous release, the CoPP policies are automatically remapped based on the new CoPP protocol mappings to queues. For example:

- You have a CoPP policy configured for queue 5 in release 10.4.1, which is for ARP Request, ICMPv6-RS-NS, iSCSI snooping, and iSCSI-COS.
- After upgrade to release 10.4.2, the CoPP policy for queue 5 is remapped based on the new CoPP protocol mappings to queues as follows:
  - ARP Request is mapped to queue 6



- o ICMPv6-RS-NS is mapped to queue 5
- o iSCSI is mapped to queue 0

The rate limit configuration in CoPP policy before upgrade is automatically remapped to queues 6, 5, and 0 respectively after upgrade.

For example, in release 10.4.1, the following policy configuration is applied on queue 5, which in 10.4.1 is mapped to ARP\_REQ, ICMPV6\_RS, ICMPV6\_NS, and ISCSI protocols:

```
policy-map type control-plane test
!
class test
 set qos-group 5
 police cir 300 pir 300
```

After upgrade to release 10.4.2, the policy configuration appears as follows:

```
policy-map type control-plane test
!
class test_Remapped_0
 set qos-group 0
 police cir 300 pir 300
!
class test_Remapped_5
 set qos-group 5
 police cir 300 pir 300
!
class test_Remapped_6
 set qos-group 6
 police cir 300 pir 300
```

In release 10.4.2, ARP\_REQ is mapped to queue 6, ICMPV6\_RS and ICMPV6\_NS are mapped to queue 5, and ISCSI is mapped to queue 0.

By default, CoPP traffic towards the CPU is classified into different queues as shown below.

**Table 83. CoPP: Protocol mappings to queues - prior to release 10.4.2**

| Queue | Protocol                                             |
|-------|------------------------------------------------------|
| 0     | IPv6                                                 |
| 1     | —                                                    |
| 2     | IGMP                                                 |
| 3     | VLT, NDS                                             |
| 4     | ICMPv6, ICMPv4                                       |
| 5     | ARP Request, ICMPV6-RS-NS, ISCSI snooping, ISCSI-COS |
| 6     | ICMPv6-RA-NA, SSH, TELNET, TACACS, NTP, FTP          |
| 7     | RSTP,PVST, MSTP,LACP                                 |
| 8     | Dot1X,LLDP, FCOE-FPORT                               |
| 9     | BGPv4, OSPFv6                                        |
| 10    | DHCPv6, DHCPv4, VRRP                                 |
| 11    | OSPF Hello, OpenFlow                                 |

The following table lists the CoPP protocol mappings to queues, and default rate limits and buffer sizes on the S4148FE-ON platform. The number of control-plane queues is dependent on the hardware platform.

**Table 84. CoPP: Protocol mappings to queues, and default rate limits and buffer sizes - from release 10.4.2 and later**

| Queue | Protocols                     | Minimum rate limit (in pps) | Maximum rate limit (in pps) | Minimum guaranteed buffer (in bytes) | Static shared limit (in bytes) |
|-------|-------------------------------|-----------------------------|-----------------------------|--------------------------------------|--------------------------------|
| 0     | ISCSI UNKNOWN UNICAST         | 600                         | 600                         | 1664                                 | 20800                          |
| 1     | SFlow                         | 1000                        | 1000                        | 1664                                 | 20800                          |
| 2     | IGMP, MLD, PIM control        | 400                         | 400                         | 1664                                 | 48880                          |
| 3     | VLT, NDS                      | 600                         | 1000                        | 1664                                 | 48880                          |
| 4     | IPv6 ICMP, IPv4 ICMP          | 500                         | 1000                        | 1664                                 | 20800                          |
| 5     | ICMPv6 RS, RA, NS, NA         | 500                         | 1000                        | 1664                                 | 48880                          |
| 6     | ARP request Serviceability    | 500                         | 1000                        | 1664                                 | 48880                          |
| 7     | ARP response                  | 500                         | 1000                        | 1664                                 | 48880                          |
| 8     | SSH, TELNET, NTP, FTP, TACACS | 500                         | 500                         | 1664                                 | 20800                          |
| 9     | FCoE                          | 600                         | 600                         | 1664                                 | 48880                          |
| 10    | LACP                          | 600                         | 1000                        | 1664                                 | 48880                          |
| 11    | RSTP, PVST, MSTP              | 400                         | 400                         | 1664                                 | 48880                          |
| 12    | DOT1X, LLDP, FEED             | 500                         | 500                         | 1664                                 | 48880                          |
| 13    | IPv6 OSPF, IPV4_OSPF          | 600                         | 1000                        | 1664                                 | 48880                          |
| 14    | OSPF_HELLO                    | 600                         | 1000                        | 1664                                 | 48880                          |
| 15    | BGP                           | 600                         | 1000                        | 1664                                 | 48880                          |
| 16    | IPv4 DHCP, IPv6 DHCP          | 500                         | 500                         | 1664                                 | 48880                          |
| 17    | VRRP                          | 600                         | 1000                        | 1664                                 | 48880                          |
| 18    | BFD                           | 700                         | 700                         | 1664                                 | 48880                          |
| 19    | Remote CPS, OpenFlow          | 700                         | 1000                        | 1664                                 | 48880                          |
| 20    | MCAST data                    | 100                         | 100                         | 1664                                 | 20800                          |
| 21    | ACL logging                   | 100                         | 100                         | 1664                                 | 20800                          |
| 22    | MCAST known data              | 100                         | 100                         | 1664                                 | 20800                          |
| 23    | PTP                           | 300                         | 6400                        | TBD                                  | TBD                            |
| 24    | Port Security                 | 100                         | 100                         | TBD                                  | TBD                            |

For information about the current protocol to queue mapping and the rate-limit configured per queue, see [show control-plane info](#).

## Configure control-plane policing

Rate-limiting the protocol CPU queues requires configuring control-plane type QoS policies.

- Create QoS policies, class maps and policy maps, for the desired CPU-bound queue.
- Associate the QoS policy with a particular rate-limit.
- Assign the QoS service policy to control plane queues.

By default, the peak information rate (`pir`) and committed information rate (`cir`) values are in packets per second (pps) for control plane. CoPP for CPU queues converts the input rate from kilobits per second (kbps) to packets per second (pps), assuming 64 bytes is the average packet size, and applies that rate to the corresponding queue – One kbps is roughly equivalent to two pps.

1. Create a `control-plane` type class-map and configure a name for the class-map in CONFIGURATION mode.

```
class-map type control-plane example-copp-class-map-name
```

2. Return to CONFIGURATION mode.

```
exit
```

3. Create an input policy-map to assign the QoS policy to the desired service queues in CONFIGURATION mode.

```
policy-map type control-plane example-copp-policy-map-name
```

4. Associate a policy-map with a class-map in POLICY-MAP mode.

```
class example-copp-class-map-name
```

5. Configure marking for a specific queue number in POLICY-MAP-CLASS-MAP mode. Use the `show control-plane info` command to view the list of control-plane queues.

```
set qos-group queue-number
```

6. Configure rate policing on incoming traffic in POLICY-MAP-CLASS-MAP mode.

```
police {cir committed-rate | pir peak-rate}
```

- `cir committed-rate`—Enter a committed rate value in pps, from 0 to 4000000.
- `pir peak rate` — Enter a peak-rate value in pps, from 0 to 40000000.

### Create QoS policy for CoPP

```
OS10(config)# class-map type control-plane example-copp-class-map-name
OS10(config-cmap-control-plane)# exit
OS10(config)# policy-map type control-plane example-copp-policy-map-name
OS10(config-pmap-control-plane)# class example-copp-class-map-name
OS10(config-pmap-c)# set qos-group 2
OS10(config-pmap-c)# police cir 100 pir 100
```

### View policy-map

```
OS10(config)# do show policy-map
Service-policy (control-plane) input: example-copp-policy-map-name
Class-map (control-plane): example-copp-class-map-name
 set qos-group 2
 police cir 100 bc 100 pir 100 be 100
```

### Configuration notes

Dell EMC PowerSwitch S4200-ON Series:

- Shaping does not support traffic less than 468 kbps. Configure the shaping rates in multiples of 468.
- In System Flow ACL, ARP request and ARP response packets share the same CPU queue.

- CPU queues support shaping instead of rate limiting.
- Port shaping, storm control rate shaping, and CoPP rates are converted to kbps internally, even when configured in pps.

## Assign service-policy

Rate controlling the traffic towards CPU requires configuring the **control-plane** type policy. To enable CoPP, apply the defined policy-map to CONTROL-PLANE mode.

1. Enter CONTROL-PLANE mode from CONFIGURATION mode.

```
control-plane
```

2. Define an input type service-policy and configure a name for the service policy in CONTROL-PLANE mode.

```
service-policy input example-copp-policy-map-name
```

### Assign control-plane service-policy

```
OS10(config)# control-plane
OS10(conf-control-plane)# service-policy input example-copp-policy-map-name
```

### View control-plane service-policy

```
OS10(conf-control-plane)# do show qos control-plane
Service-policy (input): example-copp-policy-map-name
```

## Re-map protocols to queues

On switches that have a fewer number of queues, multiple protocols are mapped to a single queue. OS10 allows you to re-map the protocols to available queues depending on your needs.

**NOTE:** This feature is not supported on the S4200-ON and S5100-ON series platforms.

For example, if your deployment does not need multicast protocols, re-map the multicast protocols to another queue. And use the original multicast queue, queue 2 for other protocols or applications that you need.

If the protocols or applications that your deployment needs share the same queue, re-map some of them to other queues that are mapped to protocols or applications that are not required.

If your deployment uses only a few protocols or applications, you can re-map these protocols or applications to individual queues. Also, you can change the buffer settings for the remaining queues that are mapped to unused protocols or applications. Ensure that you transfer the allocated buffer space from such queues to the common pool, which is used for lossy or lossless traffic.

If you re-map the protocols or applications to different queues when the system is operational, then until queue transition completes, egress traffic flows through queue 0.

The following show commands display protocol-to-queue mapping:

- `show control-plane info default` — Displays the default protocol-to-queue mapping.
- `show control-plane info` — Displays the currently configured protocol-to-queue mapping.

**NOTE:** You cannot re-map protocols and applications to queues that are mapped to CPS, port security, and Precision Time Protocol (PTP):

- CPS — Queue 19
- Port security — Queue 23
- PTP — Queue 24

The following error message appears when you re-map protocols, applications, or both to an invalid queue:

```
% Error: QOS : Invalid copp protocol queue mapping
```

## Configure protocol to queue remapping

You can re-map protocols or applications to queues that are mapped to unused protocols or applications.

The `show control-plane info default` command output displays default protocol-to-queue mapping. VRRP is mapped to queue 17 by default.

1. Create a control-plane type class-map.

```
OS10(config)# class-map type control-plane example-cmap-protocol-queue-remap
```

2. Apply the match criteria by specifying the names of the protocols or applications. In this example, VRRP is re-mapped to queue 4.

```
OS10(config-cmap-control-plane)# match vrrp
```

**i** **NOTE:** You cannot configure the same protocols or application groups under multiple class-maps within the same policy-map.

3. Create a control-plane type policy-map and add the class-map to the policy-map.

```
OS10(config)# policy-map type control-plane example-pmap-protocol-queue-remap
OS10(config-pmap-control-plane)# class example-cmap-protocol-queue-remap
```

4. Map the policy to the queue.

```
OS10(config-pmap-c)# set qos-group 4
```

5. Apply the policy-map in control-plane mode.

```
OS10(config)# control-plane
OS10(config-control-plane)# service-policy input example-pmap-protocol-queue-remap
```

In this example, VRRP is mapped to queue 4 from queue 17. The `show control-plane info` command output displays the current configuration.

```
OS10# show control-plane info
Queue Min Rate Limit(in pps) Max Rate Limit(in pps) Protocols
0 600 600 ISCSI UNKNOWN UNICAST
1 1000 1000 SFLOW
2 400 400 IGMP MLD PIM
3 600 1000 VLT NDS
4 500 1000 IPV6_ICMP IPV4_ICMP VRRP
5 500 1000 ICMPV6_RS ICMPV6_NS ICMPV6_RA
ICMPV6_NA
6 500 1000 ARP_REQ SERVICEABILITY
7 500 1000 ARP_RESP
8 500 500 SSH TELNET TACACS NTP FTP
9 600 600 FCOE
10 600 1000 LACP
11 400 400 RSTP PVST MSTP
12 500 500 DOT1X LLDP FEFD
13 600 1000 IPV6_OSPF IPV4_OSPF
14 600 1000 OSPF_HELLO
15 600 1000 BGP
16 500 500 IPV6_DHCP IPV4_DHCP
17 600 1000
18 700 700 BFD
19 700 1000 OPEN_FLOW REMOTE CPS
20 100 100 MCAST_DATA
21 100 100 ACL_LOGGING
22 100 100 MCAST_KNOWN_DATA
23 300 6400 PTP
24 100 100 PORT_SECURITY
```

## View configuration

Use show commands to display the protocol traffic assigned to each control-plane queue and the current rate-limit applied to each queue. Use the show command output to verify the CoPP configuration.

### View CoPP configuration

```
OS10# show qos control-plane
Service-policy (input): example-copp-policy-map-name
```

### View CMAP1 configuration

```
OS10# show class-map type control-plane example-copp-class-map-name
Class-map (control-plane): example-copp-class-map-name (match-any)
```

### View CoPP service-policy

```
OS10# show policy-map type control-plane
Service-policy(control-plane) input: example-copp-policy-map-name
Class-map (control-plane): example-copp-class-map-name
 set qos-group 2
 police cir 100 bc 100 pir 100 be 100
```

### View CoPP information

```
OS10# show control-plane info
Queue Min Rate Limit(in pps) Max Rate Limit(in pps)
Protocols
0 600 600 ISCSI UNKNOWN UNICAST
1 1000 1000 SFLOW
2 400 400 IGMP MLD PIM
3 600 1000 VLT NDS
4 500 1000 IPV6_ICMP IPV4_ICMP
5 500 1000 ICMPV6_RS ICMPV6_NS ICMPV6_RA
ICMPV6_NA
6 500 1000 ARP_REQ SERVICEABILITY
7 500 1000 ARP_RESP
8 500 500 SSH TELNET TACACS NTP FTP
9 600 600 FCOE
10 600 1000 LACP
11 400 400 RSTP PVST MSTP
12 500 500 DOT1X LLDP
13 600 1000 IPV6_OSPF IPV4_OSPF
14 600 1000 OSPF_HELLO
15 600 1000 BGP
16 500 500 IPV6_DHCP IPV4_DHCP
17 600 1000 VRRP
18 700 700 BFD
19 700 1000 OPEN_FLOW REMOTE CPS
20 300 300 MCAST DATA
21 100 100 ACL LOGGING
22 300 300 MCAST KNOWN DATA
```

### View CoPP statistics

```
OS10# show control-plane statistics
Queue Packets Bytes Dropped Packets
Dropped Bytes
0 26 1768 0 0
1 0 0 0 0
2 0 0 0 0
3 0 0 0 0
4 36 3816 0 0
5 36 3096 0 0
6 919 58816 0 0
7 67 4288 0 0
8 0 0 0 0
9 0 0 0 0
10 0 0 0 0
11 80662 5539376 0 0
```

|    |      |        |   |   |
|----|------|--------|---|---|
| 12 | 2779 | 462189 | 0 | 0 |
| 13 | 0    | 0      | 0 | 0 |
| 14 | 1265 | 108790 | 0 | 0 |
| 15 | 422  | 36075  | 0 | 0 |
| 16 | 0    | 0      | 0 | 0 |
| 17 | 0    | 0      | 0 | 0 |
| 18 | 0    | 0      | 0 | 0 |
| 19 | 0    | 0      | 0 | 0 |

## Egress traffic classification

Egress traffic is classified into different queues based on the traffic-class ID marked on the traffic flow.

Set the traffic class ID for a flow by enabling trust or by classifying ingress traffic and mark it with a traffic class ID using a policy map. By default, the value of traffic class ID for all the traffic is 0.

The order of precedence for a qos-map is:

1. Interface-level map
2. System-qos-level map
3. Default map

**Table 85. Default mapping of traffic class ID to queue**

| Traffic class ID | Queue ID |
|------------------|----------|
| 0                | 0        |
| 1                | 1        |
| 2                | 2        |
| 3                | 3        |
| 4                | 4        |
| 5                | 5        |
| 6                | 6        |
| 7                | 7        |

### User-defined QoS map

You can override the default mapping by creating a QoS map.

#### Configure user-defined QoS map

1. Create a QoS map.

```
OS10(config)# qos-map traffic-class tc-q-map
```

2. Define the set of traffic class values mapped to a queue.

```
OS10(config-qos-map)# queue 3 qos-group 0-3
```

3. Verify the map entries.

```
OS10# show qos maps type tc-queue
Traffic-Class to Queue Map: tc-q-map
Queue Traffic-Class

3 0-3
```

4. Apply the map on a specific interface or on a system-QoS global level.

- Interface level

```
OS10(conf-if-eth1/1/1)# qos-map traffic-class tc-q-map
```

- System-qos level

```
OS10(config-sys-qos)# qos-map traffic-class tc-q-map
```

### Choose all traffic classified for a queue

1. Create a queuing type class-map to match queue 5.

```
OS10(config)# class-map type queuing q5
```

2. Define the queue to match.

```
OS10(config-cmap-queuing)# match queue 5
```

## Policing traffic

Use policing to limit the rate of ingress traffic flow. The flow can be all the ingress traffic on a port or a particular flow defined using a QoS class-map.

In addition, use policing to color the traffic:

- When traffic arrives at a rate less than the committed rate, the color is green.
- When traffic propagates at an average rate greater than or equal to the committed rate and less than peak-rate, the color is yellow.
- When the traffic rate is above the configured peak-rate, the traffic drops to guarantee a bandwidth limit for an ingress traffic flow.

Peak rate is the maximum rate for traffic arriving or leaving an interface under normal traffic conditions. Peak burst size indicates the maximum size of unused peak bandwidth that is aggregated. This aggregated bandwidth enables brief durations of burst traffic that exceeds the peak rate.

Interface rate policing limits the rate of traffic that is received on an interface.

### Configure Interface rate policing

1. Create a QoS type empty class-map to match all the traffic.

```
OS10(config)# class-map example-cmap-all-traffic
```

2. Create a QoS type policy-map to define a policer.

```
OS10(config)# policy-map example-interface-policer
OS10(config-pmap-qos)# class example-cmap-all-traffic
OS10(config-pmap-c-qos)# police cir 4000 pir 6000
```

3. Apply the QoS type policy-map to an interface.

```
OS10(config)# interface ethernet 1/1/14
OS10(conf-if-eth1/1/14)# service-policy input type qos example-interface-policer
```

Flow rate policing controls the rate of flow of traffic.

### Configure flow rate policing

1. Create a QoS type class-map to match the traffic flow.

```
OS10(config)# class-map example-cmap-cos3
OS10(config-cmap-qos)# match cos 3
```

2. Create a QoS type policy-map to define a policer, and optionally assign a traffic class ID for the CoS flow to redirect the policed traffic to a nondefault queue.

```
OS10(config)# policy-map example-flow-policer
OS10(config-pmap-qos)# class example-cmap-cos3
```



```
OS10(config-pmap-c-qos)# set qos-group 3
OS10(config-pmap-c-qos)# police cir 4000 pir 6000
```

3. Apply the QoS type policy-map to an interface.

```
OS10(config)# interface ethernet 1/1/15
OS10(conf-if-eth1/1/15)# service-policy input type qos example-flow-policer
```

## Mark Traffic

You can select a flow and mark it with a traffic class ID. Traffic class IDs identify the traffic flow when the traffic reaches egress for queue scheduling.

### Mark traffic

1. Create a QoS type class-map to match the traffic flow.

```
OS10(config)# class-map cmap-cos3
OS10(config-cmap-qos)# match cos 3
```

2. Create a QoS type policy-map to mark it with a traffic class ID and assign it to the CoS flow.

```
OS10(config)# policy-map cos3-TC3
OS10(config-pmap-qos)# class cmap-cos3
OS10(config-pmap-c-qos)# set qos-group 3
```

## Color traffic

You can select a traffic flow and mark it with a color. Color the traffic flow based on:

- Metering. See [Policing traffic](#).
- Default trust. See [Trust-based classification](#).
- DSCP, ECN capable traffic (ECT), or non-ECT capable traffic. Use the `set color` command to color traffic based on DSCP, ECN capable, or non-ECT capable traffic.

Traffic policing and traffic coloring using DSCP values are mutually exclusive. You cannot configure both at the same time. Policing and marking using DSCP values take precedence over trust-based classification. Trust-based classification has the lowest priority.

### Color traffic based on DSCP, ECT, or non-ECT

1. Create a QoS type class-map to match the traffic flow.

```
OS10(config)# class-map type qos example-cmap-dscp-3-ect
OS10(config-cmap-qos)# match ip dscp 3
```

2. Create a QoS type policy-map to color the traffic flow.

```
OS10(config)# policy-map type qos example-pmap-ect-color
OS10(config-pmap-qos)# class example-cmap-dscp-3-ect
OS10(config-pmap-c-qos)# set qos-group 3
OS10(config-pmap-c-qos)# set color yellow
```

## Modify packet fields

You can modify the value of CoS or DSCP fields.

1. Create a QoS type class-map to match a traffic flow.

```
OS10(config)# class-map cmap-dscp-3
OS10(config-cmap-qos)# match ip dscp 3
```

2. Modify the policy-map to update the DSCP field.

```
OS10(config)# policy-map modify-dscp
OS10(config-pmap-qos)# class cmap-dscp-3
OS10(config-pmap-c-qos)# set qos-group 3
OS10(config-pmap-c-qos)# set dscp 10
```

## Shaping traffic

You can shape the rate of egress traffic. When you enable rate shaping, the system buffers all traffic exceeding the specified rate until the buffer memory is exhausted. Rate shaping uses all buffers reserved for an interface or queue and shares buffer memory, until it reaches the configured threshold.

### Configure traffic shaping

1. Enter the `queuing` type policy-map and configure a policy-map name in CONFIGURATION mode.

```
policy-map type queuing policy-map-name
```

2. Enter a class name to apply to the shape rate in POLICY-MAP-QUEUEING mode. A maximum of 32 characters.

```
class class-name
```

3. (Optional) Configure rate shaping on a specific queue by matching the corresponding qos-group in the class-map. If you do not configure the `match qos-group` command, rate shaping applies to all queues.

```
match qos-group queue-number
```

4. Enter a minimum and maximum shape rate value in POLICY-MAP-QUEUEING-CLASS mode.

```
shape {min {kbps | mbps | pps}min-value} {max {kbps | mbps | pps}max-value}
```

- 0 to 40000000—kilobits per second kilobits per second—kbps
- 0 to 40000 — megabits per second—mbps
- 1 to 268000000 — in packets per second (pps)

## Bandwidth allocation

You can allocate relative bandwidth to limit large flows and prioritize smaller flows. Allocate the relative amount of bandwidth to nonpriority queues when priorities queues are consuming maximum link bandwidth.

Weighted Deficit Round Robin (WDRR) is a scheduling method that uses a deficit counter to allocate bandwidth for traffic flows.

Schedule each egress queue of an interface per Weighted Deficit Round Robin (WDRR) or by strict-priority (SP), which are mutually exclusive. If the `bandwidth percent` command is present, you cannot configure the `priority` command.

1. Create a `queuing` type class-map and configure a name for the class-map in CONFIGURATION mode.

```
class-map type queuing example-que-cmap-name
```

2. Apply the match criteria for the queue in CLASS-MAP mode.

```
match queue queue-number
```

3. Return to CONFIGURATION mode.

```
exit
```

4. Create a `queuing` type policy-map and configure a policy-map name in CONFIGURATION mode.

```
policy-map type queuing example-que-pmap-name
```

5. Configure a queuing class in POLICY-MAP mode.

```
class example-que-cmap-name
```

6. Assign a bandwidth percent, from 1 to 100 to nonpriority queues in POLICY-MAP-CLASS-MAP mode.

```
bandwidth percent value
```

### Configure bandwidth allocation

```
OS10(config)# class-map type queuing example-que-cmap-name
OS10(config-cmap-queuing)# match queue 5
OS10(config-cmap-queuing)# exit
OS10(config)# policy-map type queuing example-que-pmap-name
OS10(config-pmap-queuing)# class example-que-cmap-name
OS10(config-pmap-c-que)# bandwidth percent 80
```

### View class-map

```
OS10(conf-cmap-queuing)# do show class-map
Class-map (queuing): example-que-cmap-name
Match: queue 5
```

### View policy-map

```
OS10(conf-pmap-c-que)# do show policy-map
Service-policy (queuing) output: example-que-pmap-name
Class-map (queuing): example-que-cmap-name
bandwidth percent 80
```

## Strict priority queuing

OS10 uses queues for egress QoS policy types. Enable strict priority to dequeue all packets from the assigned queue before servicing any other queues. When you assign more than one queue strict priority, the highest number queue receives the highest priority. You can configure strict priority to any number of queues. By default, all queues schedule traffic per WDRR.

Use the `priority` command to assign the priority to a single unicast queue—this configuration supersedes the `bandwidth percent` configuration. A queue with priority enabled can starve other queues for the same egress interface.

### Create class-map

1. Create a class-map and configure a name for the class-map in CONFIGURATION mode.

```
class-map type queuing class-map-name
```

2. Configure a match criteria in CLASS-MAP mode.

```
match queue queue-id
```

### Define a policy-map

1. Define a policy-map and create a policy-map name CONFIGURATION mode.

```
policy-map type queuing policy-map-name
```

2. Create a queuing class and configure a name for the policy-map in POLICY-MAP mode.

```
class class-map-name
```

3. Set the scheduler as strict priority in POLICY-MAP-CLASS-MAP mode.

```
priority
```

### Apply policy-map

1. Apply the policy-map to the interface in INTERFACE mode or all interfaces in SYSTEM-QOS mode.

```
system qos
```

OR

```
interface ethernet node/slot/port[:subport]
```

2. Enter the output service-policy in SYSTEM-QOS mode or INTERFACE mode.

```
service-policy {output} type {queuing} policy-map-name
```

### Enable strict priority on class-map and apply the policy-map globally

```
OS10(config)# class-map type queuing example-cmap-strictpriority
OS10(config-cmap-queuing)# match queue 7
OS10(config-cmap-queuing)# exit
OS10(config)# policy-map type queuing example-pmap-strictpriority
OS10(config-pmap-queuing)# class example-cmap-strictpriority
OS10(config-pmap-c-que)# priority
OS10(config-pmap-c-que)# exit
OS10(config-pmap-queuing)# exit
OS10(config)# system qos
OS10(config-sys-qos)# service-policy output type queuing example-pmap-strictpriority
```

### Enable strict priority on interface

**NOTE:** You can apply a policy-map globally in SYSTEM-QOS mode or apply it on the interface. OS10 does not support applying the same policy-map in SYSTEM-QOS mode as well as at the interface level.

However, you can apply a different queuing policy-map in SYSTEM-QOS mode or at the interface level. In this case, the policy-map applied at the interface takes precedence over the policy-map applied globally.

```
OS10(config)# interface ethernet 1/1/5
OS10(conf-if-eth1/1/5)# service-policy output type queuing example-pmap-strictpriority
```

### View policy-map

```
OS10(conf-if-eth1/1/5)# do show policy-map
Service-policy(queuing) output: example-pmap-strictpriority
Class-map(queuing): example-cmap-strictpriority
priority
```

### Configuration notes

Dell EMC PowerSwitch S4200-ON Series:

If PFC is provisioned, the control packets injected by CPU shares queue-7 while egressing on a front panel interface. If queues other than queue-7 are provisioned as strict priority, it is recommended to provision queue-7 as strict priority too, to reduce latency or loss of control packets.

## Rate adjustment

QoS features such as policing and shaping do not include overhead fields such as Preamble, smart frame delimiter (SFD), inter-frame gap (IFG), and so on. For rate calculations, these feature only include the frame length between the destination MAC address (DMAC) and the CRC field.

You can optionally include the following overhead fields in rate calculations by enabling rate adjustment:

- Preamble—7 bytes
- Start frame delimiter—1 byte
- Destination MAC address—6 bytes
- Source MAC address—6 bytes
- Ethernet type/length—2 bytes
- Payload—variable
- Cyclic redundancy check—4 bytes

- Inter-frame gap—variable

The rate adjustment feature is disabled by default. To enable rate adjustment, use the `qos-rate-adjust value_of_rate_adjust` command. For example:

```
qos-rate-adjust 8
```

If you have configured WDRR and shaping on a particular queue, the queue can become congested. You should configure the QoS rate adjust value considering the overhead field size to avoid traffic drops on uncongested queues.

If you have multiple streams within a queue, you must find the overhead size for the different streams and the QoS rate adjust value should be the highest overhead size from among the various streams within that queue.

Consider the example where you have configured WDRR and shaping on a queue that has two different traffic streams, TS1 and TS2, that uses preamble, SFD, and IFG overhead fields:

- If the IFG in TS1 uses 16 bytes, QoS rate adjust value should be 24 (preamble + SFD requires 8 bytes and IFG 16 bytes).
- If the IFG in TS2 uses 12 bytes, QoS rate adjust value should be 20 (preamble + SFD requires 8 bytes and IFG 12 bytes).

In this case, the highest QoS rate adjust value between the two streams is 24 bytes. Hence, you must configure the QoS rate adjust value as 24.

 **NOTE:** This feature is not supported on the S4200-ON Series platforms.

## Buffer management

OS10 devices distribute the total available buffer resources into two buffer pools at ingress direction and three buffer pools at egress direction of all physical ports.

You can map a single traffic class or a group of traffic classes to a priority group. All ports in a system are allocated a certain amount of buffers from corresponding pools based on the configuration state of each priority-group or queue. The remaining buffers in the pool are shared across all similarly configured ports.

The following buffer pools are available:

- Ingress buffer pools:
  - Lossy pool (default)
  - Lossless pool
    - PFC—For all platforms
    - LLFC—For all platforms except the S4200-ON series switches
- Egress buffer pools:
  - Lossy pool (default)
  - Lossless pool
    - PFC—For all platforms
    - LLFC—For all platforms except the S4200-ON series switches
  - CPU pool (CPU control traffic)

The following terms are used in this section:

- Default buffer—By default, the system allocates a certain amount of default buffer to all the ports.
- Reserved buffer—The system reserves a dedicated amount of buffer to a port or a priority group (at ingress) and a port or a queue (at egress).
- Shared buffer—Is the total available buffer space minus the reserved buffer space. Shared buffer is used for CPU control traffic and is dynamically allocated to the ports when memory space is needed.
- Alpha value—Is a configurable value from 0 to 10 that determines the dynamic shared buffer threshold, and maintains dynamic buffer space during congestion events.
- Xoff threshold (transmit off)—When the system reaches the Xoff threshold, to prevent traffic loss, the system pauses and does not accept any further packets.
- Xon threshold (transmit on)—When the system reaches the Xon threshold, the system resumes and accepts the packets.

For example, when all ports are allocated as reserved buffers from the lossy (default) pool, the remaining buffers in the lossy pool are shared across all ports, except the CPU port.

When you enable priority flow control (PFC) on the ports, all the PFC-enabled queues and priority-groups use the buffers from the lossless pool.

You must use the network QoS policy type to configure PFC on the ports.

OS10 dedicates a separate buffer pool for CPU traffic. All default reserved buffers for the CPU port queues are from the CPU pool. The remaining buffers are shared across all CPU queues. You can modify the buffer settings of CPU queues.

You can configure the size of the CPU pool using the `control-plane-buffer-size` command.

OS10 allows configuration of buffers per priority-group and queue for each port.

Buffer-usage accounting happens for ingress packets on ingress pools and egress packets on egress pool. You can configure ingress-packet buffer accounting per priority-group and egress-packet buffer accounting per queue level.

### Configuration notes

Dell EMC PowerSwitch S4200-ON Series:

- Provisioning LLFC is not supported when deep buffer mode is enabled.
- Stop the traffic before applying or modifying the LLFC configuration.

## Configure ingress buffer

By default, all traffic classes map to the default priority group (PG) 7 for ingress buffers. The buffer reservation is based on the default priority group ID 7. All buffers are part of the default pool and all ports share buffers from the default pool. When you configure a network qos policy map, a new priority group is created for which buffers are assigned from the lossless pool. The rest of the traffic classes that are not mapped to any PFC-related PGs, use the default buffer.

The reserved buffer size is 9360 bytes for the speed of 10G, 25G, 40G, 50G, and 100G. The supported speed varies for different platforms.

**Table 86. Maximum buffer size**

| Platforms          | Max buffer size |
|--------------------|-----------------|
| S4000              | 12 MB           |
| S6010-ON, S4048-ON | 16 MB           |
| S4100-ON Series    | 12 MB           |
| S4200-ON Series    | 6 GB            |
| S5200-ON Series    | 32 MB           |
| Z9100-ON           | 16 MB           |
| Z9264F-ON          | 42 MB           |

The following table lists the values allocated for the default ingress buffers on the S4100-ON series platform. These values may differ for different platforms and speeds. Use the `show qos ingress buffers` command to view the default ingress buffers on your switch.

**Table 87. Default ingress buffers on the S4100-ON series platform**

| Speed                               | 10G | 25G | 40G | 50G | 100G |
|-------------------------------------|-----|-----|-----|-----|------|
| Reserved buffers for PG 7 (default) | 9KB | 9KB | 9KB | 9KB | 9KB  |

The following lists the link-level flow control (LLFC) buffer settings for default priority group 7:

**Table 88. Default setting for LLFC**

| Speed                   | 10G  | 25G  | 40G  | 50G  | 100G  |
|-------------------------|------|------|------|------|-------|
| Default reserved buffer | 9KB  | 9KB  | 18KB | 18KB | 36KB  |
| Default Xon threshold   | 36KB | 45KB | 75KB | 91KB | 142KB |
| Default Xoff threshold  | 9KB  | 9KB  | 9KB  | 9KB  | 9KB   |

**Table 88. Default setting for LLFC (continued)**

| Speed                                                        | 10G | 25G | 40G | 50G | 100G |
|--------------------------------------------------------------|-----|-----|-----|-----|------|
| <b>Default dynamic shared buffer threshold (alpha value)</b> | 9KB | 9KB | 9KB | 9KB | 9KB  |

**NOTE:** The supported speed varies for different platforms. After the reserved buffers are used, each LLFC starts consuming shared buffers from the lossless pool with the alpha value determining the threshold except for the S4200-ON series platform.

The following table lists the priority flow control (PFC) buffer settings per PFC priority group:

**Table 89. Default settings for PFC**

| Speed                                                        | 10G  | 25G  | 40G  | 50G  | 100G  |
|--------------------------------------------------------------|------|------|------|------|-------|
| <b>Default reserved buffer for S4000, S4048-ON, S6010-ON</b> | 9KB  | NA   | 9KB  | NA   | NA    |
| <b>Default reserved buffer for S41xx, Z9100-ON</b>           | 9KB  | 9KB  | 18KB | 18KB | 36KB  |
| <b>Default Xoff threshold</b>                                | 36KB | 45KB | 75KB | 91KB | 142KB |
| <b>Default Xon threshold</b>                                 | 9KB  | 9KB  | 9KB  | 9KB  | 9KB   |
| <b>Default dynamic share buffer threshold (alpha value)</b>  | 9KB  | 9KB  | 9KB  | 9KB  | 9KB   |

**NOTE:** The supported speed varies for different platforms. After the reserved buffers are used, each PFC starts consuming shared buffers from the lossless pool with the alpha value determining the threshold.

You can override the default priority group settings when you enable LLFC or PFC.

1. Create a network-qos type class-map to match the traffic classes. For LLFC, match all the traffic classes from 0 to 7. For PFC, match the required traffic class.

```
OS10(config)# class-map type network-qos example-cmap-in-buffer
OS10 (config-cmap-nqos)# match qos-group 0-7
```

2. Create network-qos type policy-map to define the actions for traffic classes, such as a buffer configuration and threshold.

```
OS10(config)# policy-map type network-qos example-pmap-in-buffer
OS10 (config-pmap-network-qos)# class example-cmap-in-buffer
OS10 (config-pmap-c-nqos)# pause buffer-size 300 pause-threshold 200 resume-threshold 100
OS10 (config-pmap-c-nqos)# queue-limit thresh-mode dynamic 5
```

## Configure egress buffer

All port queues are allocated with reserved buffers. When the reserved buffers are consumed, each queue starts using the shared buffers from the default pool.

The following table lists the values allocated for the default egress buffers on the S4100-ON series platform. These values may differ for different platforms and speeds. Use the `show qos egress buffers` command to view the default egress buffers on your switch.

**Table 90. Default egress buffers on the S4100-ON series platform**

| Speed                                               | 10G        | 25G        | 40G        | 50G        | 100G       |
|-----------------------------------------------------|------------|------------|------------|------------|------------|
| Reserved buffers for each queue of a port (default) | 1664 bytes | 1664 bytes | 1664 bytes | 1664 bytes | 1664 bytes |

The default dynamic shared buffer threshold is 8.

1. Create a queuing type class-map to match the queue.

```
OS10(config)# class-map type queuing example-cmap-eg-buffer
OS10(config-cmap-queuing)# match queue 1
```

2. Create a queuing type policy-map to define the actions for queues, such as a buffer configuration and threshold.

```
OS10(config)# policy-map type queuing example-pmap-eg-buffer
OS10(config-pmap-queuing)# class example-cmap-eg-buffer
OS10(config-pmap-c-que)# queue-limit queue-len 200 thresh-mode dynamic 5
```

## Deep Buffer mode

**NOTE:** This feature is supported only on the S4200-ON series.

OS10 provides the flexibility to configure the buffer mode based on your system requirements.

The S4200-ON series switch comes with a default deep buffer size of 4.63 GB. You can use the `hardware deep-buffer-mode` command to enhance the deep buffer size to 6.24 GB. For information about how to configure deep buffer mode, see [Configure Deep Buffer mode](#). The following lists the total buffer availability in the different modes:

**Table 91. Buffer availability in different modes**

| Platform        | Default deep buffer | Enhanced deep buffer |
|-----------------|---------------------|----------------------|
| S4200-ON series | 4.63 GB             | 6.24 GB              |

Deep Buffer mode takes effect only after saving it in the startup configuration and reloading the switch.

**NOTE:** Disabling the Deep Buffer mode configuration during runtime is not supported.

## Configuration notes

1. When the switch is in Deep Buffer mode, the PFC and LLFC features are not available. The following commands are not supported:

- `priority-flow-control mode on`—Configure Priority Flow Control mode on an interface.
- `service-policy input type network-qos policy-name`—Apply a network service policy on an interface.
- `flowcontrol transmit on`—Configure flow control transmit.
- `pfc-max-buffer-size size`—Configure maximum buffer size for PFC.
- `pfc-shared-buffer-size size`—Configure shared buffer size for PFC.

**NOTE:** To view the PFC, LLFC, or service policy configured on the interfaces, use `show running-configuration` command. Use `interface range` command to disable network QoS-related configurations before enabling Deep Buffer mode.

2. The other QoS features such as traffic classification, policing, marking, shaping, priority queuing, and scheduling are supported in Deep Buffer mode.

## Configure Deep Buffer mode

By default, Deep Buffer mode is disabled. To configure Deep Buffer mode on a switch, enable the mode, save the configuration, and reload the switch for the feature to take effect.

**NOTE:** Disable all the network QoS configurations; for example, PFC and LLFC, before configuring the Deep Buffer mode.

To configure Deep Buffer mode:

1. Enable Deep Buffer mode in CONFIGURATION mode.

```
hardware deep-buffer-mode
```



After you configure Deep Buffer mode, the system displays a warning stating that the configuration takes effect only after saving it in the startup configuration and reloading the switch.

**NOTE:** To disable Deep Buffer mode, use the `no` form of the command. Disabling Deep Buffer mode takes effect only after saving it in the startup configuration and reloading the switch.

2. Save Deep Buffer mode in the startup configuration in EXEC mode.

```
write memory
```

3. Reload the switch in EXEC mode.

```
reload
```

### Configure Deep Buffer mode

The configuration shows how to enable Deep Buffer mode in a switch.

```
OS10# configure terminal
OS10(config)# hardware deep-buffer-mode
% Warning: Deep buffer mode configuration will be applied only after a save and reload.
OS10(config)# exit
OS10# write memory
OS10# reload

Proceed to reboot the system? [confirm yes/no]: Y
```

To view Deep Buffer mode status, use the `show hardware deep-buffer-mode` command. The `show` command output displays the status of Deep Buffer mode in the current boot and the next boot.

The following is Deep Buffer mode status before enabling it, the default setting:

```
OS10# show hardware deep-buffer-mode
Deep Buffer Mode Configuration Status

Current-boot Settings : Disabled
Next-boot Settings : Disabled
```

The following is Deep Buffer mode status after saving the configuration in the startup configuration:

```
OS10# show hardware deep-buffer-mode
Deep Buffer Mode Configuration Status

Current-boot Settings : Disabled
Next-boot Settings : Enabled
```

The following is Deep Buffer mode status after the switch reloads:

```
OS10# show hardware deep-buffer-mode
Deep Buffer Mode Configuration Status

Current-boot Settings : Enabled
Next-boot Settings : Enabled
```

## Congestion avoidance

Congestion avoidance anticipates and takes necessary actions to avoid congestion. The following mechanisms avoid congestion:

- **Tail drop**—Packets are buffered at traffic queues. When the buffers are exhausted or reach the configured threshold, excess packets drop. By default, OS10 uses tail drop for congestion avoidance.
- **Random early detection (RED)**—In tail drop, different flows are not considered in buffer utilization. When multiple hosts start retransmission, tail drop causes TCP global re-synchronization. Instead of waiting for the queue to get filled up completely, RED starts dropping excess packets with a certain drop-probability when the average queue length exceeds the

configured minimum threshold. The early drop ensures that only some of TCP sources slow down, which avoids global TCP re-synchronization.

- **Weighted random early detection (WRED)**—This allows different drop-probabilities and thresholds for each color — red, yellow, green — of traffic. You can configure the drop characteristics for three different flows by assigning the colors to the flow. Assign colors to a particular flow or traffic using various methods, such as ingress policing, qos input policy-maps, and so on.
- **Explicit congestion notification (ECN)**—This is an extension of WRED. Instead of dropping the packets when the average queue length crosses the minimum threshold values, ECN marks the Congestion Experienced (CE) bit of the ECN field in a packet as ECN-capable traffic (ECT).

1. Configure a WRED profile in CONFIGURATION mode.

```
OS10(config)# wred example-wred-prof
```

2. Configure WRED threshold parameters for different colors in WRED CONFIGURATION mode.

```
OS10(config-wred)# random-detect color yellow minimum-threshold 100 maximum-threshold 300 drop-probability 40
```

3. Configure the exponential weight value for the WRED profile in WRED CONFIGURATION mode.

```
OS10(config-wred)# random-detect weight 4
```

4. Enable ECN.

```
OS10(config-wred)# random-detect ecn
```

5. Enable WRED/ECN on a queue.

```
OS10(config)# class-map type queuing example-cmap-wred
OS10(config-cmap-queuing)# match queue 2
OS10(config-cmap-queuing)# exit
OS10(config)# policy-map type queuing example-pmap-wred
OS10(config-pmap-queuing)# class example-cmap-wred
OS10(config-pmap-c-que)# random-detect example-wred-prof
```

6. Enable WRED/ECN on a port.

```
OS10(config)# interface ethernet 1/1/1
OS10(conf-if-eth1/1/1)# random-detect example-wred-prof
```

7. Enable WRED/ECN on a service-pool.

```
OS10(config)# system qos
OS10(config-sys-qos)# random-detect pool 0 example-wred-prof
```

**i NOTE:** On the S4200-ON Series platform, enable ECN globally only. Also, apply ECN configurations only at the queue level. You cannot configure ECN at the interface or service-pool levels. If you try to apply the ECN configuration at the interface or service-pool levels, the configuration is not accepted.

To enable ECN globally:

1. Configure a WRED profile in CONFIGURATION mode.

```
OS10(config)# wred example-wred-prof-1
```

2. Configure WRED threshold parameters for different colors in WRED CONFIGURATION mode.

```
OS10(config-wred)# random-detect color yellow minimum-threshold 100 maximum-threshold 300 drop-probability 40
```

3. Configure the exponential weight value for the WRED profile in WRED CONFIGURATION mode.

```
OS10(config-wred)# random-detect weight 4
```

4. Configure the ECN threshold parameters in WRED CONFIGURATION mode.

```
OS10(config-wred)# random-detect ecn minimum-threshold 100 maximum-threshold 300 drop-probability 40
```

5. Exit WRED CONFIGURATION mode.

```
OS10(config-wred)#exit
```

6. Create a QoS class-map.

```
OS10(config)# class-map type queuing example-cmap-wred-1
OS10(config-cmap-queuing)# match queue 2
```

7. Enter QOS POLICY-MAP mode and create a queuing policy type.

```
OS10(config)#policy-map type queuing example-pmap-wred-1
OS10(config-pmap-queuing)# class example-cmap-wred-1
```

8. Assign a WRED profile to the specified queue.

```
OS10(config-pmap-c-que)#random-detect example-wred-prof-1
```

9. Exit CLASS MAP and POLICY MAP modes.

```
OS10(config-pmap-c-que)#exit
OS10(config-pmap-queuing)#exit
```

10. Enter SYSTEM QOS mode.

```
OS10(config)#configure system-qos
```

11. Enable ECN globally.

```
OS10(config-sys-qos)#random-detect ecn
```

After you enable ECN globally, ECN marks the CE bit of the ECN field in a packet as ECT.

In the S4200-ON Series platform, configure separate thresholds for ECN capable traffic (ECT). If you enable ECN, ECT is marked based on the configured ECN threshold and non-ECT drops based on the WRED thresholds.

## Storm control

Traffic storms created by packet flooding or other reasons may degrade the performance of the network. The storm control feature allows you to control unknown unicast, multicast, and broadcast traffic on L2 and L3 physical interfaces.

OS10 devices monitor the current level of the traffic rate at fixed intervals, compares the traffic rate with the configured levels, and drops excess traffic.

By default, storm control is disabled on all interfaces. Enable storm control using the `storm-control { broadcast | multicast | unknown-unicast } rate-in-pps` command in INTERFACE mode.

 **NOTE:** This feature is not supported on the Z9332F-ON platform.

- Enable broadcast storm control with a rate of 1000 packets per second (pps) on Ethernet 1/1/1.

```
OS10(conf-if-eth1/1/1)# storm-control broadcast 1000
```

## RoCE for faster access and lossless connectivity

Remote Direct Memory Access (RDMA) enables memory transfers between two computers in a network without involving the CPU of either computer.

RDMA networks provide high bandwidth and low latency without appreciable CPU overhead for improved application performance, storage and data center utilization, and simplified network management. RDMA was traditionally supported only in an InfiniBand environment. Currently, RDMA over Converged Ethernet (RoCE) is also implemented in data centers that use Ethernet or a mixed-protocol environment.

OS10 devices support RoCE v1 and RoCE v2 protocols.

- RoCE v1 – An Ethernet layer protocol that allows for communication between two hosts that are in the same Ethernet broadcast domain.
- RoCE v2 – An Internet layer protocol that allows RoCE v2 packets to be routed, called Routed RoCE (RRoCE).

To enable RoCE, configure the QoS service policy on the switch in ingress and egress directions on all the interfaces. For more information about this configuration, see [Configure RoCE on the switch](#).

## Configure RoCE on the switch

To configure RoCE, classify the ingress and egress traffic as lossy and lossless traffic. Based on the classification, assign the ECN threshold and bandwidth for the respective queues. For RoCEv1, ECN threshold configuration is not required.

### Configuration notes

- Use the `trust-map` or `policy-map` CLI commands to configure dot1p and DSCP traffic-class markings. For RoCEv2, classification is based only on DSCP.
- Use the `qos-map` CLI command to apply the traffic class to queues.
- Use the `network-type` policy-map to classify any of the priority values as lossless and fine-tune the respective buffer value depending on traffic congestion.
- Adjust the ECN threshold based on the traffic pattern.
- Use the `queuing-type` policy-map to modify the bandwidth allocation for lossy and lossless queues.
- If you are using RoCEv1, only bandwidth allocation is required. ECN and ECN queue association are not required.
- To ensure lossless traffic flow, configure PFC on all lossless interfaces.

The following example describes the steps to configure RoCE on the switch. This configuration example uses priority 3 for RoCE.

1. Enter CONFIGURATION mode.

```
OS10# configure terminal
OS10 (config)#
```

2. Enable the Data Center Bridging Exchange protocol (DCBX). See [Data center bridging exchange \(DCBX\)](#) for more information.

```
OS10 (config)# dcbx enable
```

3. Create a VLAN. In this example, VLAN 55 switches the RoCE traffic. You can configure any value from 1 to 4093.

```
OS10 (config)# interface vlan 55
OS10 (conf-if-vl-55)# no shutdown
```

4. Apply the dot1p trust globally or at the interface level. In this example, the dot1p trust is applied globally.

#### NOTE:

- If PFC configuration is not enabled on all the ports in the switch, do not apply dot1p trust globally. Apply the dot1p trust on the specific interfaces.
- For RoCEv1, use the `trust-map dot1p default` command or the user-defined `trust-map dot1p` configuration.
- For RoCEv2, use the `trust-map dscp default` command or the user-defined `trust-map dscp` configuration.

```
OS10 (config)# system qos
OS10 (config-sys-qos)# trust-map dot1p default
```

5. Create a network-qos type class-map and policy-map for priority flow control (PFC). This configuration fine tunes the buffer settings for the particular priority.

```
OS10 (config)# class-map type network-qos pfcdot1p3
OS10 (config-cmap-nqos)# match qos-group 3

OS10 (config)# policy-map type network-qos policy_pfcdot1p3
OS10 (config-pmap-network-qos)# class pfcdot1p3
OS10 (config-pmap-c-nqos)# pause
OS10 (config-pmap-c-nqos)# pfc-cos 3
```

**NOTE:** When you use the `pause` command without any parameters, the system uses the default buffer settings. To modify the buffer settings, use the `pause` command and specify the buffer size, pause threshold, and resume threshold. See [Priority flow control](#) and the `pause` command for more information.

6. Create queuing-type class-maps and policy-map for enhanced transmission selection (ETS), bandwidth, and ECN configurations. See [Enhanced transmission selection](#) and [Bandwidth allocation](#) for more information.

#### Bandwidth configuration for RoCEv1:

```
OS10 (config)# class-map type queuing Q0
OS10 (config-cmap-queuing)# match queue 0
OS10 (config)# class-map type queuing Q3
OS10 (config-cmap-queuing)# match queue 3
```

```
OS10 (config)# policy-map type queuing policy_2Q
OS10 (config-pmap-queuing)# class Q0
OS10 (config-pmap-c-que)# bandwidth percent 30
OS10 (config-pmap-c-que)# exit
OS10 (config-pmap-queuing)# class Q3
OS10 (config-pmap-c-que)# bandwidth percent 70
```

#### Bandwidth and ECN configuration for RoCEv2 with ECN queue association:

```
OS10 (config)# class-map type queuing Q0
OS10 (config-cmap-queuing)# match queue 0
OS10 (config)# class-map type queuing Q3
OS10 (config-cmap-queuing)# match queue 3
```

```
OS10(config)# wred wred_ecn
OS10(config-wred)# random-detect ecn
OS10(config-wred)# random-detect color green minimum-threshold 1000 maximum-threshold
2000 drop-probability 100
OS10(config-wred)# random-detect color yellow minimum-threshold 500 maximum-threshold
1000 drop-probability 100
OS10(config-wred)# random-detect color red minimum-threshold 100 maximum-threshold
500 drop-probability 100
OS10(config-wred)# exit
```

```
OS10(config)# policy-map type queuing policy_2Q
OS10(config-pmap-queuing)# class Q0
OS10(config-pmap-c-que)# bandwidth percent 30
OS10(config-pmap-c-que)# exit
OS10(config-pmap-queuing)# class Q3
OS10(config-pmap-c-que)# bandwidth percent 70
OS10(config-pmap-c-que)# random-detect wred_ecn
OS10(config-pmap-c-que)# end
OS10#
```

7. Create a QoS map for ETS to map the lossy and lossless traffic to the respective queues.

```
OS10 (config)# qos-map traffic-class 2Q
OS10(config-qos-map)# queue 0 qos-group 0-2, 4-7
OS10(config-qos-map)# queue 3 qos-group 3
```

8. Perform the following configurations on all switch interfaces where you want to support RoCE:

- For RoCEv1:

- a. Enter INTERFACE mode and enter the `no shutdown` command.

```
OS10# configure terminal
OS10 (config)# interface ethernet 1/1/1
OS10 (conf-if-eth1/1/1)# no shutdown
```

- b. Change the switch port mode to Trunk mode.

```
OS10 (conf-if-eth1/1/1)# switchport mode trunk
```

- c. Specify the allowed VLANs on the trunk port.

```
OS10 (conf-if-eth1/1/1)# switchport trunk allowed vlan 55
```

- d. Apply the network-qos type policy-map to the interface.

```
OS10 (conf-if-eth1/1/1)# service-policy input type network-qos policy_pfcdot1p3
```

- e. Apply the queuing policy to egress traffic on the interface.

```
OS10 (conf-if-eth1/1/1)# service-policy output type queuing policy_2Q
```

- f. Enable ETS on the interface.

```
OS10 (conf-if-eth1/1/1)# ets mode on
```

- g. Apply the qos-map for ETS configurations on the interface.

```
OS10 (conf-if-eth1/1/1)# qos-map traffic-class 2Q
```

- h. Enable PFC on the interface.

```
OS10 (conf-if-eth1/1/1)# priority-flow-control mode on
```

- For RoCEv2:

- a. Enter INTERFACE mode and enter the no shutdown command.

```
OS10#configure terminal
OS10 (config)# interface ethernet 1/1/1
OS10 (conf-if-eth1/1/1)# no shutdown
```

- b. Apply the network-qos type policy-map to the interface.

```
OS10 (conf-if-eth1/1/1)# service-policy input type network-qos policy_pfcdot1p3
```

- c. Apply the queuing policy to egress traffic on the interface.

```
OS10 (conf-if-eth1/1/1)# service-policy output type queuing policy_2Q
```

- d. Enable ETS on the interface.

```
OS10 (conf-if-eth1/1/1)# ets mode on
```

- e. Apply the qos-map for ETS configurations on the interface.

```
OS10 (conf-if-eth1/1/1)# qos-map traffic-class 2Q
```

- f. Enable PFC on the interface.

```
OS10 (conf-if-eth1/1/1)# priority-flow-control mode on
```

### View configuration and statistics

Use the following show commands to view the configuration and statistics:

- To view the PFC and ETS configuration details at the interface level, use the show qos interface command:

```
OS10# show qos interface ethernet 1/1/4
```

- To view the buffer allocation for the ingress interface, use the show qos ingress buffers command:

```
OS10# show qos ingress buffers interface ethernet 1/1/4
```

- To view the buffer utilization at the ingress interface, use the show qos ingress buffer-stats command:

```
OS10# show qos ingress buffer-stats interface ethernet 1/1/4
```

- To view the buffer allocation for the egress interface, use the show qos egress buffers command:

```
OS10# show qos egress buffers interface ethernet 1/1/4
```

- To view the buffer utilization at the egress interface, use the `show qos egress buffer-stats` command:

```
OS10# show qos egress buffer-stats interface ethernet 1/1/4
```

- To view the PFC configuration, operational status, and statistics on the interface, use the `show interface interface-name priority-flow-control details` command:

```
OS10(config)# show interface ethernet 1/1/15 priority-flow-control details
```

- To view the ECN markings on an interface, use the `show queuing statistics interface interface-name wred` command:

```
OS10# show queuing statistics interface ethernet 1/1/1 wred
```

- To view any egress packet loss, use the `show queuing statistics` command:

 **NOTE:** There should not be any packet drops in lossless queues.

```
OS10# show queuing statistics interface ethernet 1/1/1
```

- To view qos map details such as dot1p or DSCP to traffic class mapping and traffic class to queue mapping, use the `show qos maps` command:

```
OS10# show qos maps
```

## RoCE for VXLAN over VLT

OS10 supports RoCE for VXLAN in a VLT setup. Configuring RoCE with VXLAN is similar to configuring RoCE without VXLAN. When you configure VXLAN and span that across a VLT topology, apply the configuration on all interfaces across the VLT topology where you want to support RoCE.

For more information about how to configure RoCE, see the [Configure RoCE on the switch](#) section.

### Sample configuration of RoCE for VXLAN over VLT

The following describes a topology where RoCE is enabled with VXLAN over VLT. SW1 is configured as VTEP1 and is the upstream switch that connects to the outer network. VLT peer 1 and VLT peer 2 form a VLT topology and are also configured as VTEP 2. A top-of-rack (ToR) switch is connected to the VLT peers through a VLT port channel. The ToR is the downstream switch for end devices, such as, virtual machines.

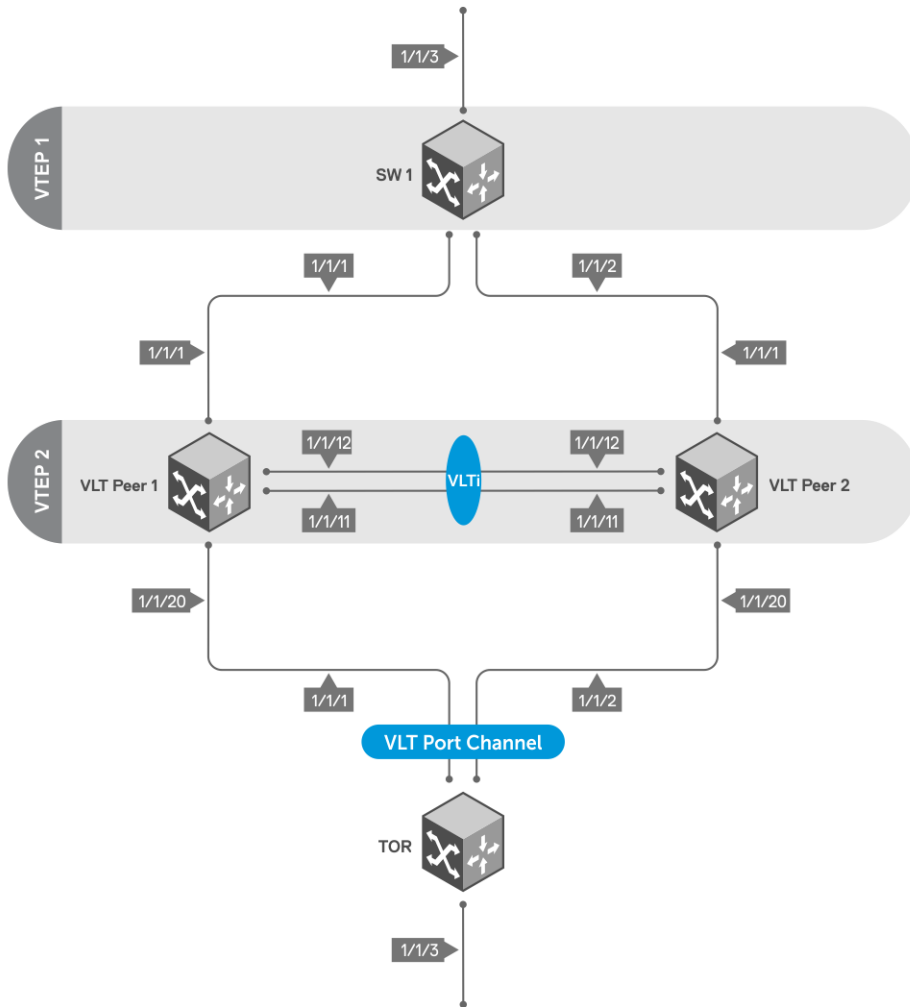

The following examples show each device in this network and their respective configuration:

### SW1 configuration

#### VXLAN configuration — SW1

```

OS10# configure terminal
OS10(config)# interface vlan 3000
OS10(conf-if-vl-3000)# exit
OS10(config)# interface vlan 200
OS10(conf-if-vl-200)# exit
OS10(config)# interface loopback 1
OS10(conf-if-lo-1)# ip address 1.1.1.1/32
OS10(conf-if-lo-1)# exit
OS10(config)# router ospf 1
OS10(config-router-ospf-1)# router-id 8.8.8.8
OS10(config-router-ospf-1)# exit
OS10(config)# interface vlan 3000
OS10(conf-if-vl-3000)# ip ospf 1 area 0
OS10(conf-if-vl-3000)# exit
OS10(config)# interface loopback 1
OS10(conf-if-lo-1)# ip ospf 1 area 0
OS10(conf-if-lo-1)# exit
OS10(config)# interface ethernet 1/1/1
OS10(conf-if-eth1/1/1)# switchport mode trunk
OS10(conf-if-eth1/1/1)# switchport trunk allowed vlan 3000
OS10(conf-if-eth1/1/1)# exit
OS10(config)# interface ethernet 1/1/2
OS10(conf-if-eth1/1/2)# switchport mode trunk
OS10(conf-if-eth1/1/2)# switchport trunk allowed vlan 3000
OS10(conf-if-eth1/1/2)# exit

```



```

OS10(config)# configure terminal
OS10(config)# nve
OS10(conf-nve)# source-interface loopback 1
OS10(conf-nve)# exit
OS10(config)# virtual-network 5
OS10(conf-vn-5)# vxlan-vni 1000
OS10(conf-vn-vxlan-vni)# remote-vtep 2.2.2.2
OS10(conf-vn-vxlan-vni-remote-vtep)# exit
OS10(conf-vn-vxlan-vni)# exit
OS10(conf-vn-5)# exit
OS10(config)# interface vlan 200
OS10(conf-if-vl-200)# virtual-network 5
OS10(conf-if-vl-200)# end
OS10#
OS10# configure terminal
OS10(config)# interface ethernet 1/1/3
OS10(conf-if-eth1/1/3)# switchport mode trunk
OS10(conf-if-eth1/1/3)# switchport trunk allowed vlan 200
OS10(conf-if-eth1/1/3)# end

```

### PFC configuration — SW1

```

OS10# configure terminal
OS10(config)# trust dot1p-map t1
OS10(config-tmap-dot1p-map)# qos-group 0 dot1p 0
OS10(config-tmap-dot1p-map)# qos-group 1 dot1p 1
OS10(config-tmap-dot1p-map)# qos-group 2 dot1p 2
OS10(config-tmap-dot1p-map)# qos-group 3 dot1p 3
OS10(config-tmap-dot1p-map)# qos-group 4 dot1p 4
OS10(config-tmap-dot1p-map)# qos-group 5 dot1p 5
OS10(config-tmap-dot1p-map)# qos-group 6 dot1p 6
OS10(config-tmap-dot1p-map)# qos-group 7 dot1p 7
OS10(config-tmap-dot1p-map)# end
OS10# configure terminal
OS10(config)# class-map type network-qos c5
OS10(config-cmap-nqos)# match qos-group 5
OS10(config-cmap-nqos)# exit
OS10(config)# policy-map type network-qos p5
OS10(config-pmap-network-qos)# class c5
OS10(config-pmap-c-nqos)# pause
OS10(config-pmap-c-nqos)# pfc-cos 5
OS10(config-pmap-c-nqos)# end
OS10# configure terminal
OS10(config)# interface range ethernet 1/1/3,1/1/1,1/1/2
OS10(conf-range-eth1/1/3,1/1/1,1/1/2)# flowcontrol receive off
OS10(conf-range-eth1/1/3,1/1/1,1/1/2)# priority-flow-control mode on
OS10(conf-range-eth1/1/3,1/1/1,1/1/2)# ets mode on
OS10(conf-range-eth1/1/3,1/1/1,1/1/2)# service-policy input type network-qos p5
OS10(conf-range-eth1/1/3,1/1/1,1/1/2)# trust-map dot1p t1

```

### LLFC configuration — SW1

Instead of PFC, you can configure LLFC as follows:

```

OS10(config)# configure terminal
OS10(config)# class-map type network-qos llfc
OS10(config-cmap-nqos)# match qos-group 0-7
OS10(config-cmap-nqos)# exit
OS10(config)# policy-map type network-qos llfc
OS10(config-pmap-network-qos)# class llfc
OS10(config-pmap-c-nqos)# pause buffer-size 100 pause-threshold 50 resume-threshold 10
OS10(config-pmap-c-nqos)# end
OS10#
OS10# configure terminal
OS10(config)# interface range ethernet 1/1/1,1/1/2,1/1/3
OS10(conf-range-eth1/1/1,1/1/2,1/1/3)# flowcontrol transmit on
OS10(conf-range-eth1/1/1,1/1/2,1/1/3)# flowcontrol receive on
OS10(conf-range-eth1/1/1,1/1/2,1/1/3)# service-policy input type network-qos llfc
OS10(conf-range-eth1/1/1,1/1/2,1/1/3)# end

```

## WRED and ECN configuration — SW1

```
OS10# configure terminal
OS10(config)# wred w1
OS10(config-wred)# random-detect ecn
OS10(config-wred)# random-detect color green minimum-threshold 100 maximum-threshold 500
drop-probability 100
OS10(config-wred)# random-detect color yellow minimum-threshold 100 maximum-threshold
500 drop-probability 100
OS10(config-wred)# random-detect color red minimum-threshold 100 maximum-threshold 500
drop-probability 100
OS10(config-wred)# exit
OS10(config)# class-map type queuing cq
OS10(config-cmap-queuing)# match queue 5
OS10(config-cmap-queuing)# exit
OS10(config)# policy-map type queuing pq
OS10(config-pmap-queuing)# class cq
OS10(config-pmap-c-que)# random-detect w1
OS10(config-pmap-c-que)# end
OS10# configure terminal
OS10(config)# interface range ethernet 1/1/3,1/1/1,1/1/2
OS10(conf-range-eth1/1/3,1/1/1,1/1/2)# flowcontrol receive off
OS10(conf-range-eth1/1/3,1/1/1,1/1/2)# priority-flow-control mode on
OS10(conf-range-eth1/1/3,1/1/1,1/1/2)# ets mode on
OS10(conf-range-eth1/1/3,1/1/1,1/1/2)# service-policy input type network-qos p5
OS10(conf-range-eth1/1/3,1/1/1,1/1/2)# service-policy output type queuing pq
OS10(conf-range-eth1/1/3,1/1/1,1/1/2)# trust-map dot1p t1
OS10(conf-range-eth1/1/3,1/1/1,1/1/2)# end
```

## Enable DCBx — SW1

```
OS10# configure terminal
OS10(config)# dcbx enable
```

## Configuration on VLT peer 1

### VLT configuration — VLT peer 1

```
OS10# configure terminal
OS10(config)# interface range ethernet 1/1/12,1/1/11
OS10(conf-range-eth1/1/12,1/1/11)# no switchport mode
OS10(conf-range-eth1/1/12,1/1/11)# no switchport
OS10(conf-range-eth1/1/12,1/1/11)# no negotiation
OS10(conf-range-eth1/1/12,1/1/11)# exit
OS10(config)# vlt-domain 1
OS10(conf-vlt-1)# discovery-interface ethernet 1/1/12
OS10(conf-vlt-1)# discovery-interface ethernet 1/1/11
OS10(conf-vlt-1)# vlt-mac aa:bb:cc:dd:ee:ff
OS10(conf-vlt-1)# end
OS10#
OS10# configure terminal
OS10(config)# interface port-channel 2
OS10(conf-if-po-2)# vlt-port-channel 20
OS10(conf-if-po-2)# no shutdown
OS10(conf-if-po-2)# exit
OS10(config)# interface range ethernet 1/1/20
OS10(conf-range-eth1/1/20)# channel-group 2 mode active
OS10(conf-range-eth1/1/20)# exit
```

### VXLAN configuration — VLT peer 1

```
OS10(config)# configure terminal
OS10(config)# interface vlan 3000
OS10(conf-if-vl-3000)# ip address 5.5.5.2/24
OS10(conf-if-vl-3000)# exit
OS10(config)# interface vlan 200
OS10(conf-if-vl-200)# exit
OS10(config)# interface loopback1
OS10(conf-if-lo-1)# no shutdown
OS10(conf-if-lo-1)# ip address 2.2.2.2/11
OS10(conf-if-lo-1)# exit
OS10(config)# router ospf 1
```

```

OS10(config-router-ospf-1)# router-id 9.9.9.9
OS10(config-router-ospf-1)# exit
OS10(config)# interface loopback 1
OS10(conf-if-lo-1)# ip ospf 1 area 0
OS10(conf-if-lo-1)#
OS10(conf-if-lo-1)# configure terminal
OS10(config)# interface vlan 3000
OS10(conf-if-vl-3000)# ip ospf 1 area 0
OS10(conf-if-vl-3000)# end
OS10# configure terminal
OS10(config)# interface ethernet 1/1/1
OS10(conf-if-eth1/1/1)# switchport mode trunk
OS10(conf-if-eth1/1/1)# switchport trunk allowed vlan 3000
OS10(conf-if-eth1/1/1)# exit
OS10(config)# nve
OS10(conf-nve)# source-interface loopback 1
OS10(conf-nve)# exit
OS10(config)# virtual-network 5
OS10(conf-vn-5)# vxlan-vni 1200
OS10(conf-vn-vxlan-vni)# remote-vtep 1.1.1.1
OS10(conf-vn-vxlan-vni-remote-vtep)# exit
OS10(conf-vn-vxlan-vni)# exit
OS10(conf-vn-5)# exit
OS10(config)# interface vlan 200
OS10(conf-if-vl-200)# virtual-network 5
OS10(conf-if-vl-200)# end
OS10#
OS10# configure terminal
OS10(config)# interface port-channel 2
OS10(conf-if-po-2)# switchport mode trunk
OS10(conf-if-po-2)# switchport trunk allowed vlan 200
OS10(conf-if-po-2)# end

```

### PFC configuration — VLT peer 1

```

OS10# configure terminal
OS10(config)# trust dot1p-map t1
OS10(config-tmap-dot1p-map)# qos-group 0 dot1p 0
OS10(config-tmap-dot1p-map)# qos-group 1 dot1p 1
OS10(config-tmap-dot1p-map)# qos-group 2 dot1p 2
OS10(config-tmap-dot1p-map)# qos-group 3 dot1p 3
OS10(config-tmap-dot1p-map)# qos-group 4 dot1p 4
OS10(config-tmap-dot1p-map)# qos-group 5 dot1p 5
OS10(config-tmap-dot1p-map)# qos-group 6 dot1p 6
OS10(config-tmap-dot1p-map)# qos-group 7 dot1p 7
OS10(config-tmap-dot1p-map)# end
OS10# configure terminal
OS10(config)# class-map type network-qos c5
OS10(config-cmap-nqos)# match qos-group 5
OS10(config-cmap-nqos)# exit
OS10(config)# policy-map type network-qos p5
OS10(config-pmap-network-qos)# class c5
OS10(config-pmap-c-nqos)# pause
OS10(config-pmap-c-nqos)# pfc-cos 5
OS10(config-pmap-c-nqos)# end
OS10# configure terminal
OS10(config)# interface range ethernet 1/1/1,1/1/20,1/1/11,1/1/12
OS10(conf-range-eth1/1/1,1/1/20,1/1/11,1/1/12)# flowcontrol receive off
OS10(conf-range-eth1/1/1,1/1/20,1/1/11,1/1/12)# priority-flow-control mode on
OS10(conf-range-eth1/1/1,1/1/20,1/1/11,1/1/12)# ets mode on
OS10(conf-range-eth1/1/1,1/1/20,1/1/11,1/1/12)# service-policy input type network-qos p5
OS10(conf-range-eth1/1/1,1/1/20,1/1/11,1/1/12)# trust-map dot1p t1
OS10(conf-range-eth1/1/1,1/1/20,1/1/11,1/1/12)# end

```

### LLFC configuration — VLT peer 1

Instead of PFC, you can configure LLFC as follows:

```

OS10# configure terminal
OS10(config)# class-map type network-qos llfc
OS10(config-cmap-nqos)# match qos-group 0-7
OS10(config-cmap-nqos)# exit

```

```

OS10(config)# policy-map type network-qos llfc
OS10(config-pmap-network-qos)# class llfc
OS10(config-pmap-c-nqos)# pause buffer-size 120 pause-threshold 50 resume-threshold 12
OS10(config-pmap-c-nqos)# end
OS10# configure terminal
OS10(config)# interface range ethernet 1/1/1,1/1/20,1/1/31,1/1/32
OS10(conf-range-eth1/1/1,1/1/20,1/1/31,1/1/32)# flowcontrol transmit on
OS10(conf-range-eth1/1/1,1/1/20,1/1/31,1/1/32)# flowcontrol receive on
OS10(conf-range-eth1/1/1,1/1/20,1/1/31,1/1/32)# service-policy input type network-qos
llfc
OS10(conf-range-eth1/1/1,1/1/20,1/1/31,1/1/32)# end

```

### WRED/ECN configuration — VLT peer 1

```

OS10# configure terminal
OS10(config)# wred w1
OS10(config-wred)# random-detect ecn
OS10(config-wred)# random-detect color green minimum-threshold 120 maximum-threshold 500
drop-probability 100
OS10(config-wred)# random-detect color yellow minimum-threshold 120 maximum-threshold
500 drop-probability 100
OS10(config-wred)# random-detect color red minimum-threshold 120 maximum-threshold 500
drop-probability 100
OS10(config-wred)# exit
OS10(config)# class-map type queuing cq
OS10(config-cmap-queuing)# match queue 5
OS10(config-cmap-queuing)# exit
OS10(config)# policy-map type queuing pq
OS10(config-pmap-queuing)# class cq
OS10(config-pmap-c-que)# random-detect w1
OS10(config-pmap-c-que)# end
OS10# configure terminal
OS10(config)# interface range ethernet 1/1/1,1/1/20,1/1/12,1/1/11
OS10(conf-range-eth1/1/1,1/1/20,1/1/12,1/1/11)# service-policy input type network-qos p5
OS10(conf-range-eth1/1/1,1/1/20,1/1/12,1/1/11)# service-policy output type queuing pq
OS10(conf-range-eth1/1/1,1/1/20,1/1/12,1/1/11)# trust-map dot1p t1
OS10(conf-range-eth1/1/1,1/1/20,1/1/12,1/1/11)# flowcontrol receive off
OS10(conf-range-eth1/1/1,1/1/20,1/1/12,1/1/11)# priority-flow-control mode on
OS10(conf-range-eth1/1/1,1/1/20,1/1/12,1/1/11)# ets mode on
OS10(conf-range-eth1/1/1,1/1/20,1/1/12,1/1/11)# end

```

### Enable DCBx — VLT peer 1

```

OS10# configure terminal
OS10(config)# dcbx enable

```

### Configuration on VLT peer 2

#### VLT configuration — VLT peer 2

```

OS10# configure terminal
OS10(config)# interface range ethernet 1/1/11,1/1/12
OS10(conf-range-eth1/1/11,1/1/12)# no switchport mode
OS10(conf-range-eth1/1/11,1/1/12)# no switchport
OS10(conf-range-eth1/1/11,1/1/12)# no negotiation
OS10(conf-range-eth1/1/11,1/1/12)# exit
OS10(config)# vlt-domain 1
OS10(conf-vlt-1)# discovery-interface ethernet 1/1/11
OS10(conf-vlt-1)# discovery-interface ethernet 1/1/12
OS10(conf-vlt-1)# vlt-mac aa:bb:cc:dd:ee:ff
OS10(conf-vlt-1)# end
OS10#
OS10# configure terminal
OS10(config)# interface port-channel 2
OS10(conf-if-po-2)# vlt-port-channel 20
OS10(conf-if-po-2)# no shutdown
OS10(conf-if-po-2)# exit

```

## VXLAN configuration — VLT peer 2

```
OS10(config)# configure terminal
OS10(config)# interface vlan 3000
OS10(conf-if-vl-3000)# ip address 5.5.5.3/24
OS10(conf-if-vl-3000)# exit
OS10(config)# interface vlan 200
OS10(conf-if-vl-200)# exit
OS10(config)# interface loopback 1
OS10(conf-if-lo-1)# no shutdown
OS10(conf-if-lo-1)# ip address 2.2.2.2/32
OS10(conf-if-lo-1)# exit
OS10(config)# router ospf 1
OS10(config-router-ospf-1)# router-id 10.10.10.10
OS10(config-router-ospf-1)# exit
OS10(config)# interface loopback 1
OS10(conf-if-lo-1)# ip ospf 1 area 0
OS10(conf-if-lo-1)# configure terminal
OS10(config)# interface vlan 3000
OS10(conf-if-vl-3000)# ip ospf 1 area 0
OS10(conf-if-vl-3000)# end
OS10# configure terminal
OS10(config)# interface ethernet 1/1/1
OS10(conf-if-eth1/1/1)# switchport mode trunk
OS10(conf-if-eth1/1/1)# switchport trunk allowed vlan 3000
OS10(conf-if-eth1/1/1)# exit
OS10(config)# nve
OS10(conf-nve)# source-interface loopback 1
OS10(conf-nve)# exit
OS10(config)# virtual-network 5
OS10(conf-vn-5)# vxlan-vni 1000
OS10(conf-vn-vxlan-vni)# remote-vtep 1.1.1.1
OS10(conf-vn-vxlan-vni-remote-vtep)# exit
OS10(conf-vn-vxlan-vni)# exit
OS10(conf-vn-5)# exit
OS10(config)# interface vlan 200
OS10(conf-if-vl-200)# virtual-network 5
OS10(conf-if-vl-200)# end
OS10#
OS10# configure terminal
OS10(config)# interface port-channel 2
OS10(conf-if-po-2)# switchport mode trunk
OS10(conf-if-po-2)# switchport trunk allowed vlan 200
OS10(conf-if-po-2)# end
```

## PFC configuration — VLT peer 2

```
OS10# configure terminal
OS10(config)# trust dot1p-map t1
OS10(config-tmap-dot1p-map)# qos-group 0 dot1p 0
OS10(config-tmap-dot1p-map)# qos-group 1 dot1p 1
OS10(config-tmap-dot1p-map)# qos-group 2 dot1p 2
OS10(config-tmap-dot1p-map)# qos-group 3 dot1p 3
OS10(config-tmap-dot1p-map)# qos-group 4 dot1p 4
OS10(config-tmap-dot1p-map)# qos-group 5 dot1p 5
OS10(config-tmap-dot1p-map)# qos-group 6 dot1p 6
OS10(config-tmap-dot1p-map)# qos-group 7 dot1p 7
OS10(config-tmap-dot1p-map)# end
OS10# configure terminal
OS10(config)# class-map type network-qos c5
OS10(config-cmap-nqos)# match qos-group 5
OS10(config-cmap-nqos)# exit
OS10(config)# policy-map type network-qos p5
OS10(config-pmap-network-qos)# class c5
OS10(config-pmap-c-nqos)# pause
OS10(config-pmap-c-nqos)# pfc-cos 5
OS10(config-pmap-c-nqos)# end
OS10# configure terminal
OS10(config)# interface range ethernet 1/1/1,1/1/20,1/1/11,1/1/12
OS10(conf-range-eth1/1/1,1/1/20,1/1/11,1/1/12)# flowcontrol receive off
OS10(conf-range-eth1/1/1,1/1/20,1/1/11,1/1/12)# priority-flow-control mode on
OS10(conf-range-eth1/1/1,1/1/20,1/1/11,1/1/12)# ets mode on
```

```

OS10(config-range-eth1/1/1,1/1/20,1/1/11,1/1/12)# service-policy input type network-qos p5
OS10(config-range-eth1/1/1,1/1/20,1/1/11,1/1/12)# trust-map dot1p t1
OS10(config-range-eth1/1/1,1/1/20,1/1/11,1/1/12)# end

```

## LLFC configuration — VLT peer 2

Instead of PFC, you can configure LLFC as follows:

```

OS10# configure terminal
OS10(config)# class-map type network-qos llfc
OS10(config-cmap-nqos)# match qos-group 0-7
OS10(config-cmap-nqos)# exit
OS10(config)# policy-map type network-qos llfc
OS10(config-pmap-network-qos)# class llfc
OS10(config-pmap-c-nqos)# pause buffer-size 50 pause-threshold 30 resume-threshold 10
OS10(config-pmap-c-nqos)# end
OS10# configure terminal
OS10(config)# interface range ethernet 1/1/1,1/1/20,1/1/11,1/1/12
OS10(config-range-eth1/1/1,1/1/20,1/1/11,1/1/12)# flowcontrol transmit on
OS10(config-range-eth1/1/1,1/1/20,1/1/11,1/1/12)# flowcontrol receive on
OS10(config-range-eth1/1/1,1/1/20,1/1/11,1/1/12)# service-policy input type network-qos
llfc
OS10(config-range-eth1/1/1,1/1/20,1/1/11,1/1/12)# end

```

## WRED/ECN configuration — VLT peer 2

```

OS10# configure terminal
OS10(config)# wred w1
OS10(config-wred)# random-detect ecn
OS10(config-wred)# random-detect color green minimum-threshold 100 maximum-threshold 500
drop-probability 100
OS10(config-wred)# random-detect color yellow minimum-threshold 100 maximum-threshold
500 drop-probability 100
OS10(config-wred)# random-detect color red minimum-threshold 100 maximum-threshold 500
drop-probability 100
OS10(config-wred)# exit
OS10(config)# class-map type queuing cq
OS10(config-cmap-queuing)# match queue 5
OS10(config-cmap-queuing)# exit
OS10(config)# policy-map type queuing pq
OS10(config-pmap-queuing)# class cq
OS10(config-pmap-c-que)# random-detect w1
OS10(config-pmap-c-que)# end
OS10# configure terminal
OS10(config)# interface range ethernet 1/1/1,1/1/20,1/1/11,1/1/12
OS10(config-range-eth1/1/1,1/1/20,1/1/11,1/1/12)# flowcontrol receive off
OS10(config-range-eth1/1/1,1/1/20,1/1/11,1/1/12)# priority-flow-control mode on
OS10(config-range-eth1/1/1,1/1/20,1/1/11,1/1/12)# ets mode on
OS10(config-range-eth1/1/1,1/1/20,1/1/11,1/1/12)# service-policy input type network-qos p5
OS10(config-range-eth1/1/1,1/1/20,1/1/11,1/1/12)# service-policy output type queuing pq
OS10(config-range-eth1/1/1,1/1/20,1/1/11,1/1/12)# trust-map dot1p t1
OS10(config-range-eth1/1/1,1/1/20,1/1/11,1/1/12)# end

```

## Enable DCBx — VLT peer 2

```

OS10# configure terminal
OS10(config)# dcbx enable

```

## Configuration on ToR device

### System configuration — ToR device

```

NOS# configure terminal
NOS(config)# interface vlan 200
NOS(config-if-vl-200)# no shutdown
NOS(config-if-vl-200)# exit
NOS(config)# interface port-channel 2
NOS(config-if-po-2)# no shutdown
NOS(config-if-po-2)# exit
NOS(config)# interface range ethernet 1/1/1,1/1/2
NOS(config-range-eth1/1/1,1/1/2)# channel-group 2 mode active
NOS(config-range-eth1/1/1,1/1/2)# end

```

```

NOS#
NOS# configure terminal
NOS(config)# interface ethernet 1/1/3
NOS(conf-if-eth1/1/3)# switchport mode trunk
NOS(conf-if-eth1/1/3)# switchport trunk allowed vlan 200
NOS(conf-if-eth1/1/3)# end
NOS#
NOS# configure terminal
NOS(config)# interface port-channel 2
NOS(conf-if-po-2)# switchport mode trunk
NOS(conf-if-po-2)# switchport trunk allowed vlan 200
NOS(conf-if-po-2)# end

```

### PFC configuration — ToR device

```

NOS# configure terminal
NOS(config)# trust dot1p-map t1
NOS(config-tmap-dot1p-map)# qos-group 0 dot1p 0
NOS(config-tmap-dot1p-map)# qos-group 1 dot1p 1
NOS(config-tmap-dot1p-map)# qos-group 2 dot1p 2
NOS(config-tmap-dot1p-map)# qos-group 3 dot1p 3
NOS(config-tmap-dot1p-map)# qos-group 4 dot1p 4
NOS(config-tmap-dot1p-map)# qos-group 5 dot1p 5
NOS(config-tmap-dot1p-map)# qos-group 6 dot1p 6
NOS(config-tmap-dot1p-map)# qos-group 7 dot1p 7
NOS(config-tmap-dot1p-map)# configure terminal
NOS(config)# class-map type network-qos pfc5
NOS(config-cmap-nqos)# match qos-group 5
NOS(config-cmap-nqos)# exit
NOS(config)# policy-map type network-qos policy5
NOS(config-pmap-network-qos)# class pfc5
NOS(config-pmap-c-nqos)# pause
NOS(config-pmap-c-nqos)# pfc-cos 5
NOS(config-pmap-c-nqos)# end
NOS#
NOS# configure terminal
NOS(config)# interface range ethernet 1/1/1,1/1/2,1/1/3
NOS(conf-range-eth1/1/1,1/1/2,1/1/3)# flowcontrol receive off
NOS(conf-range-eth1/1/1,1/1/2,1/1/3)# service-policy input type network-qos policy5
NOS(conf-range-eth1/1/1,1/1/2,1/1/3)# trust-map dot1p t1
NOS(conf-range-eth1/1/1,1/1/2,1/1/3)# priority-flow-control mode on
NOS(conf-range-eth1/1/1,1/1/2,1/1/3)# ets mode on
NOS(conf-range-eth1/1/1,1/1/2,1/1/3)# end

```

### LLFC configuration — ToR device

Instead of PFC, you can configure LLFC as follows:

```

NOS# configure terminal
NOS(config)# class-map type network-qos llfc
NOS(config-cmap-nqos)# match qos-group 0-7
NOS(config-cmap-nqos)# exit
NOS(config)# policy-map type network-qos llfc
NOS(config-pmap-network-qos)# class llfc
NOS(config-pmap-c-nqos)# pause buffer-size 100 pause-threshold 50 resume-threshold 10
NOS(config-pmap-c-nqos)# end
NOS# configure terminal
NOS(config)# interface range ethernet 1/1/1,1/1/2,1/1/3
NOS(conf-range-eth1/1/1,1/1/2,1/1/3)# flowcontrol transmit on
NOS(conf-range-eth1/1/1,1/1/2,1/1/3)# flowcontrol receive on
NOS(conf-range-eth1/1/1,1/1/2,1/1/3)# service-policy input type network-qos llfc
NOS(conf-range-eth1/1/1,1/1/2,1/1/3)# end

```

### WRED/ECN configuration — ToR device

```

NOS# configure terminal
NOS(config)# wred w1
NOS(config-wred)# random-detect ecn
NOS(config-wred)# random-detect color green minimum-threshold 100 maximum-threshold 500
drop-probability 100
NOS(config-wred)# random-detect color yellow minimum-threshold 100 maximum-threshold 500
drop-probability 100

```

```

NOS(config-wred)# random-detect color red minimum-threshold 100 maximum-threshold 500
drop-probability 100
NOS(config-wred)# exit
NOS(config)# class-map type queuing cq
NOS(config-cmap-queuing)# match queue 5
NOS(config-cmap-queuing)# exit
NOS(config)# policy-map type queuing pq
NOS(config-pmap-queuing)# class cq
NOS(config-pmap-c-que)# random-detect w1
NOS(config-pmap-c-que)# end
NOS# configure terminal
NOS(config)# interface range ethernet 1/1/1,1/1/2,1/1/3
NOS(conf-range-eth1/1/1,1/1/2,1/1/3)# flowcontrol receive off
NOS(conf-range-eth1/1/1,1/1/2,1/1/3)# priority-flow-control mode on
NOS(conf-range-eth1/1/1,1/1/2,1/1/3)# ets mode on
NOS(conf-range-eth1/1/1,1/1/2,1/1/3)# service-policy input type network-qos policy5
NOS(conf-range-eth1/1/1,1/1/2,1/1/3)# service-policy output type queuing pq
NOS(conf-range-eth1/1/1,1/1/2,1/1/3)# trust-map dot1p t1
NOS(conf-range-eth1/1/1,1/1/2,1/1/3)# end

```

### Enable DCBx — ToR device

```

OS10# configure terminal
OS10(config)# dcbx enable

```

## Buffer statistics tracking

OS10 offers the Buffer Statistics Tracking (BST) feature to observe buffer usage across the switch without any impact to performance. This feature maintains separate sets of counters for buffer usage accounting:

- Ingress priority-group
- Ingress service-pool
- Ingress shared-headroom-pool
- Egress queue
- Egress service-pool

You can obtain a snapshot of the buffer statistics for the different buffer objects, such as a snapshot of all ingress priority-groups associated to a port, all egress unicast queues bound to a port, and so on.

You can enable BST at the global level. OS10 tracks buffer utilization and provides the maximum peak statistics value over a period of time and the current value of the monitored BST counter.

Use the `buffer-statistics-tracking` command in SYSTEM-QOS mode to enable BST:

```

OS10# configure terminal
OS10(config)# configure system-qos
OS10(config-sys-qos)# buffer-statistics-tracking

```

### Clear the counter

You can choose to reset the peak buffer utilization value and determine a new peak buffer utilization value. Use the `clear qos statistics type buffer-statistics-tracking` command to clear the tracked value and to refresh this counter.

BST tracks peak buffer utilization over a period of time. At any given point in time, the peak buffer usage from the past is displayed.

For example, if you enable BST at time T0 and use the `show` command to view the peak buffer utilization value at time T1, the peak usage between T0 and T1 is displayed. If you view the peak buffer utilization again at time T2, the peak usage between T0 and T2 is displayed. However, if you clear the counter using the `clear qos statistics type buffer-statistics-tracking` command at time T3 and view the peak buffer utilization at time T4, the peak usage between T3 and T4 is displayed.

**NOTE:** When BST is enabled, if you make any configuration changes that affect the priority group or priority mapping configuration, such as removal of class map, addition of class map to policy map (nqos), and so on, be sure to clear the buffer statistics using the `clear qos statistics type buffer-statistics-tracking` command to view the actual peak buffer utilization for the current configuration.

Advantages of BST include:



- Detecting microburst congestions
- Monitoring buffer utilization and historical trends
- Determining optimal sizes and thresholds for the ingress or egress shared buffers and headroom on a given port or queue based on real-time data

**i** **NOTE:** BST is not supported on the S4248F-ON platforms.

After you disable BST, be sure to clear the counter using the `clear qos statistics type buffer-statistics-tracking` command.

## Port to port-pipe and MMU mapping

A port pipe handles network traffic to and from a set of front-end I/O ports. On the Z9100-ON, Z9264F-ON, and MX9116n platforms, interfaces are shared across port pipes and port pipes are shared across Memory Management Units (MMUs).

As interfaces span across port pipes, Dell EMC Networking recommends spreading ingress and egress interfaces across different port pipes for optimal performance. To find the port to port-pipe and MMU mapping, use the `show qos port-map details` command.

### Z9100-ON output example:

```
OS10# show qos port-map details
```

| Interface  | Port Pipe | Ingress MMU | Egress MMU | Oper Status |
|------------|-----------|-------------|------------|-------------|
| Eth 1/1/1  | 1         | 2, 3        | 0, 2       | up          |
| Eth 1/1/2  | 1         | 2, 3        | 0, 2       | up          |
| Eth 1/1/3  | 1         | 2, 3        | 0, 2       | up          |
| Eth 1/1/4  | 1         | 2, 3        | 0, 2       | up          |
| Eth 1/1/5  | 2         | 2, 3        | 1, 3       | up          |
| Eth 1/1/6  | 2         | 2, 3        | 1, 3       | up          |
| Eth 1/1/7  | 2         | 2, 3        | 1, 3       | up          |
| Eth 1/1/8  | 2         | 2, 3        | 1, 3       | up          |
| Eth 1/1/9  | 1         | 2, 3        | 0, 2       | up          |
| Eth 1/1/10 | 1         | 2, 3        | 0, 2       | up          |
| Eth 1/1/11 | 1         | 2, 3        | 0, 2       | up          |
| Eth 1/1/12 | 1         | 2, 3        | 0, 2       | up          |
| Eth 1/1/13 | 2         | 2, 3        | 1, 3       | down        |
| Eth 1/1/14 | 2         | 2, 3        | 1, 3       | down        |
| Eth 1/1/15 | 2         | 2, 3        | 1, 3       | down        |
| Eth 1/1/16 | 2         | 2, 3        | 1, 3       | down        |
| Eth 1/1/17 | 3         | 0, 1        | 1, 3       | down        |
| Eth 1/1/18 | 3         | 0, 1        | 1, 3       | down        |
| Eth 1/1/19 | 3         | 0, 1        | 1, 3       | down        |
| Eth 1/1/20 | 3         | 0, 1        | 1, 3       | down        |

|            |   |      |      |      |
|------------|---|------|------|------|
| Eth 1/1/21 | 0 | 0, 1 | 0, 2 | down |
| Eth 1/1/22 | 0 | 0, 1 | 0, 2 | down |
| Eth 1/1/23 | 0 | 0, 1 | 0, 2 | down |
| Eth 1/1/24 | 0 | 0, 1 | 0, 2 | down |
| Eth 1/1/25 | 3 | 0, 1 | 1, 3 | up   |
| Eth 1/1/26 | 3 | 0, 1 | 1, 3 | down |
| Eth 1/1/27 | 3 | 0, 1 | 1, 3 | down |
| Eth 1/1/28 | 3 | 0, 1 | 1, 3 | down |
| Eth 1/1/29 | 0 | 0, 1 | 0, 2 | down |
| Eth 1/1/30 | 0 | 0, 1 | 0, 2 | down |
| Eth 1/1/31 | 0 | 0, 1 | 0, 2 | down |
| Eth 1/1/32 | 0 | 0, 1 | 0, 2 | down |
| Eth 1/1/33 | 1 | 2, 3 | 0, 2 | up   |
| Eth 1/1/34 | 2 | 2, 3 | 1, 3 | up   |

View information for a single interface:

```
OS10# show qos port-map details interface ethernet 1/1/1
```

| Interface | Port Pipe | Ingress MMU | Egress MMU | Oper Status |
|-----------|-----------|-------------|------------|-------------|
| Eth 1/1/1 | 1         | 2, 3        | 0, 2       | up          |

#### Z9264F-ON output example:

```
OS10# show qos port-map details
```

| Interface    | Port Pipe | Ingress MMU | Egress MMU | Oper Status |
|--------------|-----------|-------------|------------|-------------|
| Eth 1/1/1:1  | 0         | 0, 1        | 0, 2       | up          |
| Eth 1/1/3:1  | 1         | 2, 3        | 0, 2       | up          |
| Eth 1/1/3:2  | 1         | 2, 3        | 0, 2       | up          |
| Eth 1/1/3:3  | 1         | 2, 3        | 0, 2       | up          |
| Eth 1/1/3:4  | 1         | 2, 3        | 0, 2       | up          |
| Eth 1/1/5:1  | 1         | 2, 3        | 0, 2       | down        |
| Eth 1/1/5:2  | 1         | 2, 3        | 0, 2       | down        |
| Eth 1/1/5:3  | 1         | 2, 3        | 0, 2       | down        |
| Eth 1/1/5:4  | 1         | 2, 3        | 0, 2       | down        |
| Eth 1/1/7:1  | 1         | 2, 3        | 0, 2       | down        |
| Eth 1/1/7:2  | 1         | 2, 3        | 0, 2       | down        |
| Eth 1/1/7:3  | 1         | 2, 3        | 0, 2       | down        |
| Eth 1/1/7:4  | 1         | 2, 3        | 0, 2       | down        |
| Eth 1/1/9:1  | 0         | 0, 1        | 0, 2       | down        |
| Eth 1/1/9:2  | 0         | 0, 1        | 0, 2       | down        |
| Eth 1/1/9:3  | 0         | 0, 1        | 0, 2       | down        |
| Eth 1/1/9:4  | 0         | 0, 1        | 0, 2       | down        |
| Eth 1/1/11:1 | 0         | 0, 1        | 0, 2       | up          |
| Eth 1/1/11:2 | 0         | 0, 1        | 0, 2       | up          |
| Eth 1/1/11:3 | 0         | 0, 1        | 0, 2       | up          |
| Eth 1/1/11:4 | 0         | 0, 1        | 0, 2       | up          |
| Eth 1/1/13:1 | 0         | 0, 1        | 0, 2       | up          |
| Eth 1/1/13:2 | 0         | 0, 1        | 0, 2       | up          |
| Eth 1/1/13:3 | 0         | 0, 1        | 0, 2       | up          |
| Eth 1/1/13:4 | 0         | 0, 1        | 0, 2       | up          |

|              |   |      |      |      |
|--------------|---|------|------|------|
| Eth 1/1/15   | 1 | 2, 3 | 0, 2 | down |
| Eth 1/1/16   | 1 | 2, 3 | 0, 2 | down |
| Eth 1/1/17:1 | 2 | 2, 3 | 1, 3 | up   |
| Eth 1/1/19:1 | 3 | 0, 1 | 1, 3 | down |
| Eth 1/1/19:2 | 3 | 0, 1 | 1, 3 | down |
| Eth 1/1/19:3 | 3 | 0, 1 | 1, 3 | down |
| Eth 1/1/19:4 | 3 | 0, 1 | 1, 3 | down |
| Eth 1/1/21:1 | 3 | 0, 1 | 1, 3 | down |
| Eth 1/1/21:2 | 3 | 0, 1 | 1, 3 | down |
| Eth 1/1/21:3 | 3 | 0, 1 | 1, 3 | down |
| Eth 1/1/21:4 | 3 | 0, 1 | 1, 3 | down |
| Eth 1/1/23   | 3 | 0, 1 | 1, 3 | down |
| Eth 1/1/24   | 3 | 0, 1 | 1, 3 | down |
| Eth 1/1/25:1 | 2 | 2, 3 | 1, 3 | down |
| Eth 1/1/25:2 | 2 | 2, 3 | 1, 3 | down |
| Eth 1/1/25:3 | 2 | 2, 3 | 1, 3 | down |
| Eth 1/1/25:4 | 2 | 2, 3 | 1, 3 | down |
| Eth 1/1/27:1 | 2 | 2, 3 | 1, 3 | down |
| Eth 1/1/27:2 | 2 | 2, 3 | 1, 3 | down |
| Eth 1/1/27:3 | 2 | 2, 3 | 1, 3 | down |
| Eth 1/1/27:4 | 2 | 2, 3 | 1, 3 | down |
| Eth 1/1/29:1 | 2 | 2, 3 | 1, 3 | down |
| Eth 1/1/29:2 | 2 | 2, 3 | 1, 3 | down |
| Eth 1/1/29:3 | 2 | 2, 3 | 1, 3 | down |
| Eth 1/1/29:4 | 2 | 2, 3 | 1, 3 | down |
| Eth 1/1/31   | 3 | 0, 1 | 1, 3 | down |
| Eth 1/1/32   | 3 | 0, 1 | 1, 3 | down |
| Eth 1/1/33   | 0 | 0, 1 | 0, 2 | down |
| Eth 1/1/34   | 0 | 0, 1 | 0, 2 | down |
| Eth 1/1/35:1 | 1 | 2, 3 | 0, 2 | down |
| Eth 1/1/35:2 | 1 | 2, 3 | 0, 2 | down |
| Eth 1/1/35:3 | 1 | 2, 3 | 0, 2 | down |
| Eth 1/1/35:4 | 1 | 2, 3 | 0, 2 | down |
| Eth 1/1/37:1 | 1 | 2, 3 | 0, 2 | down |
| Eth 1/1/37:2 | 1 | 2, 3 | 0, 2 | down |
| Eth 1/1/37:3 | 1 | 2, 3 | 0, 2 | down |
| Eth 1/1/37:4 | 1 | 2, 3 | 0, 2 | down |
| Eth 1/1/39:1 | 1 | 2, 3 | 0, 2 | down |
| Eth 1/1/39:2 | 1 | 2, 3 | 0, 2 | down |
| Eth 1/1/39:3 | 1 | 2, 3 | 0, 2 | down |
| Eth 1/1/39:4 | 1 | 2, 3 | 0, 2 | down |
| Eth 1/1/41:1 | 0 | 0, 1 | 0, 2 | up   |
| Eth 1/1/41:2 | 0 | 0, 1 | 0, 2 | up   |
| Eth 1/1/41:3 | 0 | 0, 1 | 0, 2 | up   |
| Eth 1/1/41:4 | 0 | 0, 1 | 0, 2 | up   |
| Eth 1/1/43   | 0 | 0, 1 | 0, 2 | down |
| Eth 1/1/44   | 0 | 0, 1 | 0, 2 | down |
| Eth 1/1/45   | 0 | 0, 1 | 0, 2 | down |
| Eth 1/1/46   | 0 | 0, 1 | 0, 2 | down |
| Eth 1/1/47   | 1 | 2, 3 | 0, 2 | down |
| Eth 1/1/48   | 1 | 2, 3 | 0, 2 | down |
| Eth 1/1/49   | 2 | 2, 3 | 1, 3 | down |
| Eth 1/1/50   | 2 | 2, 3 | 1, 3 | down |
| Eth 1/1/51:1 | 3 | 0, 1 | 1, 3 | down |
| Eth 1/1/51:2 | 3 | 0, 1 | 1, 3 | down |
| Eth 1/1/51:3 | 3 | 0, 1 | 1, 3 | down |
| Eth 1/1/51:4 | 3 | 0, 1 | 1, 3 | down |
| Eth 1/1/53   | 3 | 0, 1 | 1, 3 | down |
| Eth 1/1/54   | 3 | 0, 1 | 1, 3 | down |
| Eth 1/1/55   | 3 | 0, 1 | 1, 3 | down |
| Eth 1/1/56   | 3 | 0, 1 | 1, 3 | down |
| Eth 1/1/57:1 | 2 | 2, 3 | 1, 3 | down |
| Eth 1/1/57:2 | 2 | 2, 3 | 1, 3 | down |
| Eth 1/1/57:3 | 2 | 2, 3 | 1, 3 | down |
| Eth 1/1/57:4 | 2 | 2, 3 | 1, 3 | down |
| Eth 1/1/59   | 2 | 2, 3 | 1, 3 | down |
| Eth 1/1/60   | 2 | 2, 3 | 1, 3 | down |
| Eth 1/1/61   | 2 | 2, 3 | 1, 3 | down |
| Eth 1/1/62   | 2 | 2, 3 | 1, 3 | down |
| Eth 1/1/63   | 3 | 0, 1 | 1, 3 | down |
| Eth 1/1/64   | 3 | 0, 1 | 1, 3 | down |
| Eth 1/1/65   | 2 | 2, 3 | 1, 3 | down |
| Eth 1/1/66   | 1 | 2, 3 | 0, 2 | down |

View information for a single interface:

```
OS10# show qos port-map details interface ethernet 1/1/1
```

| Interface   | Port Pipe | Ingress MMU | Egress MMU | Oper Status |
|-------------|-----------|-------------|------------|-------------|
| Eth 1/1/1:1 | 0         | 0, 1        | 0, 2       | up          |

#### MX9116n output example:

```
OS10# show qos port-map details
```

| Interface    | Port Pipe | Ingress MMU | Egress MMU | Oper Status |
|--------------|-----------|-------------|------------|-------------|
| Eth 1/1/1    | 3         | 0, 1        | 1, 3       | down        |
| Eth 1/1/2    | 3         | 0, 1        | 1, 3       | down        |
| Eth 1/1/3    | 3         | 0, 1        | 1, 3       | down        |
| Eth 1/1/4    | 3         | 0, 1        | 1, 3       | down        |
| Eth 1/1/5    | 3         | 0, 1        | 1, 3       | down        |
| Eth 1/1/6    | 3         | 0, 1        | 1, 3       | down        |
| Eth 1/1/7    | 3         | 0, 1        | 1, 3       | down        |
| Eth 1/1/8    | 3         | 0, 1        | 1, 3       | down        |
| Eth 1/1/9    | 1         | 2, 3        | 0, 2       | down        |
| Eth 1/1/10   | 1         | 2, 3        | 0, 2       | down        |
| Eth 1/1/11   | 1         | 2, 3        | 0, 2       | down        |
| Eth 1/1/12   | 1         | 2, 3        | 0, 2       | down        |
| Eth 1/1/13   | 1         | 2, 3        | 0, 2       | down        |
| Eth 1/1/14   | 1         | 2, 3        | 0, 2       | down        |
| Eth 1/1/15   | 1         | 2, 3        | 0, 2       | down        |
| Eth 1/1/16   | 1         | 2, 3        | 0, 2       | down        |
| Eth 1/1/17:1 | 3         | 0, 1        | 1, 3       | down        |
| Eth 1/1/17:2 | 3         | 0, 1        | 1, 3       | down        |
| Eth 1/1/17:3 | 3         | 0, 1        | 1, 3       | down        |
| Eth 1/1/17:4 | 3         | 0, 1        | 1, 3       | down        |
| Eth 1/1/18:1 | 1         | 2, 3        | 0, 2       | down        |
| Eth 1/1/18:2 | 1         | 2, 3        | 0, 2       | down        |
| Eth 1/1/18:3 | 1         | 2, 3        | 0, 2       | down        |
| Eth 1/1/18:4 | 1         | 2, 3        | 0, 2       | down        |
| Eth 1/1/19:1 | 3         | 0, 1        | 1, 3       | down        |
| Eth 1/1/19:2 | 3         | 0, 1        | 1, 3       | down        |
| Eth 1/1/19:3 | 3         | 0, 1        | 1, 3       | down        |
| Eth 1/1/19:4 | 3         | 0, 1        | 1, 3       | down        |
| Eth 1/1/20:1 | 1         | 2, 3        | 0, 2       | down        |
| Eth 1/1/20:2 | 1         | 2, 3        | 0, 2       | down        |
| Eth 1/1/20:3 | 1         | 2, 3        | 0, 2       | down        |
| Eth 1/1/20:4 | 1         | 2, 3        | 0, 2       | down        |
| Eth 1/1/21:1 | 3         | 0, 1        | 1, 3       | down        |
| Eth 1/1/21:2 | 3         | 0, 1        | 1, 3       | down        |
| Eth 1/1/21:3 | 3         | 0, 1        | 1, 3       | down        |
| Eth 1/1/21:4 | 3         | 0, 1        | 1, 3       | down        |
| Eth 1/1/22:1 | 1         | 2, 3        | 0, 2       | down        |
| Eth 1/1/22:2 | 1         | 2, 3        | 0, 2       | down        |
| Eth 1/1/22:3 | 1         | 2, 3        | 0, 2       | down        |
| Eth 1/1/22:4 | 1         | 2, 3        | 0, 2       | down        |
| Eth 1/1/23:1 | 3         | 0, 1        | 1, 3       | down        |
| Eth 1/1/23:2 | 3         | 0, 1        | 1, 3       | down        |
| Eth 1/1/23:3 | 3         | 0, 1        | 1, 3       | down        |
| Eth 1/1/23:4 | 3         | 0, 1        | 1, 3       | down        |
| Eth 1/1/24:1 | 1         | 2, 3        | 0, 2       | down        |
| Eth 1/1/24:2 | 1         | 2, 3        | 0, 2       | down        |
| Eth 1/1/24:3 | 1         | 2, 3        | 0, 2       | down        |
| Eth 1/1/24:4 | 1         | 2, 3        | 0, 2       | down        |
| Eth 1/1/25:1 | 3         | 0, 1        | 1, 3       | down        |
| Eth 1/1/25:2 | 3         | 0, 1        | 1, 3       | down        |
| Eth 1/1/25:3 | 3         | 0, 1        | 1, 3       | down        |
| Eth 1/1/25:4 | 3         | 0, 1        | 1, 3       | down        |
| Eth 1/1/26:1 | 1         | 2, 3        | 0, 2       | down        |
| Eth 1/1/26:2 | 1         | 2, 3        | 0, 2       | down        |
| Eth 1/1/26:3 | 1         | 2, 3        | 0, 2       | down        |
| Eth 1/1/26:4 | 1         | 2, 3        | 0, 2       | down        |

|              |   |      |      |      |
|--------------|---|------|------|------|
| Eth 1/1/27:1 | 3 | 0, 1 | 1, 3 | down |
| Eth 1/1/27:2 | 3 | 0, 1 | 1, 3 | down |
| Eth 1/1/27:3 | 3 | 0, 1 | 1, 3 | down |
| Eth 1/1/27:4 | 3 | 0, 1 | 1, 3 | down |
| Eth 1/1/28:1 | 1 | 2, 3 | 0, 2 | down |
| Eth 1/1/28:2 | 1 | 2, 3 | 0, 2 | down |
| Eth 1/1/28:3 | 1 | 2, 3 | 0, 2 | down |
| Eth 1/1/28:4 | 1 | 2, 3 | 0, 2 | down |
| Eth 1/1/29:1 | 0 | 0, 1 | 0, 2 | down |
| Eth 1/1/29:2 | 0 | 0, 1 | 0, 2 | down |
| Eth 1/1/29:3 | 0 | 0, 1 | 0, 2 | down |
| Eth 1/1/29:4 | 0 | 0, 1 | 0, 2 | down |
| Eth 1/1/30:1 | 2 | 2, 3 | 1, 3 | down |
| Eth 1/1/30:2 | 2 | 2, 3 | 1, 3 | down |
| Eth 1/1/30:3 | 2 | 2, 3 | 1, 3 | down |
| Eth 1/1/30:4 | 2 | 2, 3 | 1, 3 | down |
| Eth 1/1/31:1 | 0 | 0, 1 | 0, 2 | down |
| Eth 1/1/31:2 | 0 | 0, 1 | 0, 2 | down |
| Eth 1/1/31:3 | 0 | 0, 1 | 0, 2 | down |
| Eth 1/1/31:4 | 0 | 0, 1 | 0, 2 | down |
| Eth 1/1/32:1 | 2 | 2, 3 | 1, 3 | down |
| Eth 1/1/32:2 | 2 | 2, 3 | 1, 3 | down |
| Eth 1/1/32:3 | 2 | 2, 3 | 1, 3 | down |
| Eth 1/1/32:4 | 2 | 2, 3 | 1, 3 | down |
| Eth 1/1/33:1 | 0 | 0, 1 | 0, 2 | down |
| Eth 1/1/33:2 | 0 | 0, 1 | 0, 2 | down |
| Eth 1/1/33:3 | 0 | 0, 1 | 0, 2 | down |
| Eth 1/1/33:4 | 0 | 0, 1 | 0, 2 | down |
| Eth 1/1/34:1 | 2 | 2, 3 | 1, 3 | down |
| Eth 1/1/34:2 | 2 | 2, 3 | 1, 3 | down |
| Eth 1/1/34:3 | 2 | 2, 3 | 1, 3 | down |
| Eth 1/1/34:4 | 2 | 2, 3 | 1, 3 | down |
| Eth 1/1/35   | 0 | 0, 1 | 0, 2 | down |
| Eth 1/1/36   | 2 | 2, 3 | 1, 3 | down |
| Eth 1/1/37   | 0 | 0, 1 | 0, 2 | down |
| Eth 1/1/38   | 2 | 2, 3 | 1, 3 | down |
| Eth 1/1/39   | 0 | 0, 1 | 0, 2 | down |
| Eth 1/1/40   | 2 | 2, 3 | 1, 3 | down |
| Eth 1/1/41:1 | 2 | 2, 3 | 1, 3 | up   |
| Eth 1/1/41:2 | 2 | 2, 3 | 1, 3 | up   |
| Eth 1/1/41:3 | 2 | 2, 3 | 1, 3 | up   |
| Eth 1/1/41:4 | 2 | 2, 3 | 1, 3 | up   |
| Eth 1/1/42:1 | 0 | 0, 1 | 0, 2 | up   |
| Eth 1/1/42:2 | 0 | 0, 1 | 0, 2 | up   |
| Eth 1/1/42:3 | 0 | 0, 1 | 0, 2 | up   |
| Eth 1/1/42:4 | 0 | 0, 1 | 0, 2 | up   |
| Eth 1/1/43:1 | 2 | 2, 3 | 1, 3 | down |
| Eth 1/1/43:2 | 2 | 2, 3 | 1, 3 | down |
| Eth 1/1/43:3 | 2 | 2, 3 | 1, 3 | down |
| Eth 1/1/43:4 | 2 | 2, 3 | 1, 3 | down |
| Eth 1/1/44:1 | 0 | 0, 1 | 0, 2 | up   |
| Eth 1/1/44:2 | 0 | 0, 1 | 0, 2 | up   |
| Eth 1/1/44:3 | 0 | 0, 1 | 0, 2 | up   |
| Eth 1/1/44:4 | 0 | 0, 1 | 0, 2 | up   |

View information for a single interface:

```
OS10# show qos port-map details interface ethernet 1/1/1
```

| Interface | Port Pipe | Ingress MMU | Egress MMU | Oper Status |
|-----------|-----------|-------------|------------|-------------|
| Eth 1/1/1 | 3         | 0, 1        | 1, 3       | down        |

# QoS commands

## bandwidth

Assigns a percentage of weight to the queue.

|                           |                                                                                                        |
|---------------------------|--------------------------------------------------------------------------------------------------------|
| <b>Syntax</b>             | <code>bandwidth percent value</code>                                                                   |
| <b>Parameters</b>         | <code>percent value</code> — Enter the percentage assignment of bandwidth to the queue, from 1 to 100. |
| <b>Default</b>            | Not configured                                                                                         |
| <b>Command Mode</b>       | POLICY-MAP CLASS-MAP                                                                                   |
| <b>Usage Information</b>  | If you configure this command, you cannot use the <code>priority</code> command for the class.         |
| <b>Example</b>            | <pre>OS10(config-pmap-c-que)# bandwidth percent 70</pre>                                               |
| <b>Supported Releases</b> | 10.2.0E or later                                                                                       |

## buffer-statistics-tracking

Enables or disables buffer statistics tracking feature globally.

|                           |                                                                                                                                                                                                                                        |
|---------------------------|----------------------------------------------------------------------------------------------------------------------------------------------------------------------------------------------------------------------------------------|
| <b>Syntax</b>             | <code>buffer-statistics-tracking</code>                                                                                                                                                                                                |
| <b>Parameters</b>         | None                                                                                                                                                                                                                                   |
| <b>Default</b>            | Disabled                                                                                                                                                                                                                               |
| <b>Command Mode</b>       | SYSTEM-QOS                                                                                                                                                                                                                             |
| <b>Usage Information</b>  | The <code>no</code> form of the command disables buffer statistics tracking feature globally. After you disable BST, be sure to clear the counter using the <code>clear qos statistics type buffer-statistics-tracking</code> command. |
| <b>Example</b>            | <pre>OS10# configure terminal OS10(config)# system qos OS10(config-sys-qos)# buffer-statistics-tracking</pre>                                                                                                                          |
| <b>Supported Releases</b> | 10.4.3.0 or later                                                                                                                                                                                                                      |

## class

Creates a QoS class for a type of policy-map.

|                     |                                                                                                     |
|---------------------|-----------------------------------------------------------------------------------------------------|
| <b>Syntax</b>       | <code>class class-name</code>                                                                       |
| <b>Parameters</b>   | <code>class-name</code> — Enter a name for the class-map. A maximum of 32 characters.               |
| <b>Default</b>      | Not configured                                                                                      |
| <b>Command Mode</b> | POLICY-MAP-QUEUEING<br>POLICY-MAP-QOS<br>POLICY-MAP-NQOS<br>POLICY-MAP-CP<br>POLICY-MAP-APPLICATION |

**Usage Information** If you define a class-map under a policy-map, the `qos`, `queuing`, or `control-plane` type is the same as the policy-map. You must create this map in advance. The only exception to this rule is when the policy-map type is `trust`, where the class type must be `qos`.

**Example**

```
OS10(conf-pmap-qos)# class c1
```

**Supported Releases** 10.2.0E or later

## class-map

Creates a QoS class-map that filters traffic to match packets to the corresponding policy created for your network.

**Syntax** `class-map [type {qos | queuing | control-plane}] [{match-any | match-all}] class-map-name`

- Parameters**
- `type` — Enter a class-map type.
  - `qos` — Enter a `qos` type class-map.
  - `queuing` — Enter a `queuing` type class-map.
  - `control-plane` — Enter a `control-plane` type class-map.
  - `match-all` — Determines how packets are evaluated when multiple match criteria exist. Enter the keyword to determine that all packets must meet the match criteria to be assigned to a class.
  - `match-any` — Determines how packets are evaluated when multiple match criteria exist. Enter the keyword to determine that packets must meet at least one of the match criteria to be assigned to a class.
  - `class-map-name` — Enter a class-map name. A maximum of 32 characters.

- Defaults**
- `qos` — class-map type
  - `match-any` — class-map filter

**Command Mode** CLASS-MAP-QOS

**Usage Information** Apply `match-any` or `match-all` class-map filters to `control-plane`, `qos`, and `queuing` type class-maps.

**Example**

```
OS10(config)# class-map type qos match-all c1
OS10(conf-cmap-qos)#
```

**Command History** 10.2.0E or later

## clear qos statistics

Clears all QoS-related statistics in the system, including PFC counters.

**Syntax** `clear qos statistics`

**Parameters** None

**Default** Not configured

**Command Mode** EXEC

**Usage Information** None

**Example**

```
OS10# clear qos statistics
```

**Supported Releases** 10.2.0E or later

## clear qos statistics type

Clears all queue counters, including PFC, for control-plane, qos, and queuing.

|                                |                                                                                                                                                                                                                                                                                                                                                                                                                                                                                                                                                                                                                                                                                                                                                              |
|--------------------------------|--------------------------------------------------------------------------------------------------------------------------------------------------------------------------------------------------------------------------------------------------------------------------------------------------------------------------------------------------------------------------------------------------------------------------------------------------------------------------------------------------------------------------------------------------------------------------------------------------------------------------------------------------------------------------------------------------------------------------------------------------------------|
| <b>Syntax</b>                  | <code>clear qos statistics type {{qos   queuing   control-plane   buffer-statistics-tracking} [interface ethernet <i>node/slot/port[:subport]]}</i></code>                                                                                                                                                                                                                                                                                                                                                                                                                                                                                                                                                                                                   |
| <b>Parameters</b>              | <ul style="list-style-type: none"><li>• <code>qos</code>—Clears qos type statistics.</li><li>• <code>queuing</code>—Clears queuing type statistics.</li><li>• <code>control-plane</code>—Clears control-plane type statistics.</li><li>• <code>buffer-statistics-tracking</code>—Clears the peak buffer usage count statistics on all interfaces and service pools.<br/> <b>NOTE:</b> This command does not clear the ingress service-pool statistics on the Z9100-ON platform.</li><li>• <code>interface ethernet <i>node-id/slot/port-id</i> [:subport]</code> — Clears QoS statistics for an Ethernet interface configured for qos, queuing, or control-plane.</li></ul> |
| <b>Default</b>                 | Not configured                                                                                                                                                                                                                                                                                                                                                                                                                                                                                                                                                                                                                                                                                                                                               |
| <b>Command Mode</b>            | EXEC                                                                                                                                                                                                                                                                                                                                                                                                                                                                                                                                                                                                                                                                                                                                                         |
| <b>Usage Information</b>       | None                                                                                                                                                                                                                                                                                                                                                                                                                                                                                                                                                                                                                                                                                                                                                         |
| <b>Example</b>                 | <pre>OS10# clear qos statistics type qos interface ethernet 1/1/5</pre>                                                                                                                                                                                                                                                                                                                                                                                                                                                                                                                                                                                                                                                                                      |
| <b>Example (control-plane)</b> | <pre>OS10# clear qos statistics type control-plane interface ethernet 1/1/7</pre>                                                                                                                                                                                                                                                                                                                                                                                                                                                                                                                                                                                                                                                                            |
| <b>Example (queuing)</b>       | <pre>OS10# clear qos statistics type queuing interface ethernet 1/1/2</pre>                                                                                                                                                                                                                                                                                                                                                                                                                                                                                                                                                                                                                                                                                  |
| <b>Example (BST)</b>           | <pre>OS10# clear qos statistics type buffer-statistics-tracking</pre>                                                                                                                                                                                                                                                                                                                                                                                                                                                                                                                                                                                                                                                                                        |
| <b>Supported Releases</b>      | 10.2.0E or later                                                                                                                                                                                                                                                                                                                                                                                                                                                                                                                                                                                                                                                                                                                                             |

## control-plane

Enters CONTROL-PLANE mode.

|                             |                                                                                                                            |
|-----------------------------|----------------------------------------------------------------------------------------------------------------------------|
| <b>Syntax</b>               | <code>control-plane</code>                                                                                                 |
| <b>Parameters</b>           | None                                                                                                                       |
| <b>Default</b>              | Not configured                                                                                                             |
| <b>Command Mode</b>         | CONTROL-PLANE                                                                                                              |
| <b>Usage Information</b>    | If you attach an access-list to the class-map type of control-plane, the access-list ignores the permit and deny keywords. |
| <b>Example (class-map)</b>  | <pre>OS10(config)# class-map type control-plane c1 OS10(config-cmap-control-plane)#</pre>                                  |
| <b>Example (policy-map)</b> | <pre>OS10(config)# policy-map type control-plane p1 OS10(config-pmap-control-plane)#</pre>                                 |
| <b>Supported Releases</b>   | 10.2.0E or later                                                                                                           |



## control-plane-buffer-size

Configures the buffer size for the CPU pool.

|                           |                                                                                                                                                                                                                                                                                                                                                                                                                                                                                                                                                                                                                                           |
|---------------------------|-------------------------------------------------------------------------------------------------------------------------------------------------------------------------------------------------------------------------------------------------------------------------------------------------------------------------------------------------------------------------------------------------------------------------------------------------------------------------------------------------------------------------------------------------------------------------------------------------------------------------------------------|
| <b>Syntax</b>             | <code>control-plane-buffer-size size-of-buffer-pool</code>                                                                                                                                                                                                                                                                                                                                                                                                                                                                                                                                                                                |
| <b>Parameters</b>         | <code>size-of-buffer-pool</code> —Enter the buffer size in KB, from 620 KB to 900 KB.                                                                                                                                                                                                                                                                                                                                                                                                                                                                                                                                                     |
| <b>Default</b>            | None                                                                                                                                                                                                                                                                                                                                                                                                                                                                                                                                                                                                                                      |
| <b>Command Mode</b>       | SYSTEM-QOS                                                                                                                                                                                                                                                                                                                                                                                                                                                                                                                                                                                                                                |
| <b>Usage Information</b>  | This command configures the buffer size of the CPU pool. The system allocates a buffer size for the CPU pool from the total system buffer. A minimum guaranteed buffer is allocated for each of the CPU queues and the rest is available for shared usage. The size of the buffer pool varies based on the number of CPU queues and buffer usage by each queue, but it cannot be less than the aggregate of the minimum guaranteed buffer allocated for each of the CPU queues. The <code>no</code> version of this command removes the buffer size configured for the CPU pool and returns the buffer size to the default value, 620 KB. |
| <b>Example</b>            | <pre>OS10(config-sys-qos)# control-plane-buffer-size 900</pre>                                                                                                                                                                                                                                                                                                                                                                                                                                                                                                                                                                            |
| <b>Supported Releases</b> | 10.4.2.0 and later                                                                                                                                                                                                                                                                                                                                                                                                                                                                                                                                                                                                                        |

## flowcontrol

Enables or disables link-level flow control on an interface.

|                           |                                                                                                                                                                                                                                                                                                                                                                                                                                                                                                                                                                                                                                                                                                                                                                                                     |
|---------------------------|-----------------------------------------------------------------------------------------------------------------------------------------------------------------------------------------------------------------------------------------------------------------------------------------------------------------------------------------------------------------------------------------------------------------------------------------------------------------------------------------------------------------------------------------------------------------------------------------------------------------------------------------------------------------------------------------------------------------------------------------------------------------------------------------------------|
| <b>Syntax</b>             | <code>flowcontrol [receive   transmit] [on   off]</code>                                                                                                                                                                                                                                                                                                                                                                                                                                                                                                                                                                                                                                                                                                                                            |
| <b>Parameters</b>         | <ul style="list-style-type: none"><li>• <code>receive</code> — (Optional) Indicates the port can receive flow control packets from a remote device.</li><li>• <code>transmit</code> — (Optional) Indicates the local port can send flow control packets to a remote device.</li><li>• <code>on</code> — (Optional) When used with <code>receive</code>, allows the local port to receive flow control traffic. When used with <code>transmit</code>, allows the local port to send flow control traffic to the remote device.</li><li>• <code>off</code> — (Optional) When used with <code>receive</code>, ignores the flow control traffic sent to the local port. When used with <code>transmit</code>, disables the local port from sending flow control traffic to the remote device.</li></ul> |
| <b>Default</b>            | Disabled ( <code>off</code> )                                                                                                                                                                                                                                                                                                                                                                                                                                                                                                                                                                                                                                                                                                                                                                       |
| <b>Command Mode</b>       | INTERFACE                                                                                                                                                                                                                                                                                                                                                                                                                                                                                                                                                                                                                                                                                                                                                                                           |
| <b>Usage Information</b>  | The <code>no</code> version of this command returns the value to the default.                                                                                                                                                                                                                                                                                                                                                                                                                                                                                                                                                                                                                                                                                                                       |
| <b>Example</b>            | <pre>OS10(conf-if-eth1/1/2)# flowcontrol transmit on</pre>                                                                                                                                                                                                                                                                                                                                                                                                                                                                                                                                                                                                                                                                                                                                          |
| <b>Supported Releases</b> | 10.3.0E or later                                                                                                                                                                                                                                                                                                                                                                                                                                                                                                                                                                                                                                                                                                                                                                                    |

## hardware deep-buffer-mode

Configures Deep Buffer mode.

|                      |                                        |
|----------------------|----------------------------------------|
| <b>Syntax</b>        | <code>hardware deep-buffer-mode</code> |
| <b>Parameters</b>    | None                                   |
| <b>Defaults</b>      | Disabled                               |
| <b>Command Modes</b> | CONFIGURATION                          |

**Usage Information** Applicable only for the S4200-ON series switches. Deep Buffer mode configuration takes effect only after you save it in the startup configuration and reboot the switch. The `no` version of this command disables Deep Buffer mode.

**Example**

```
OS10(config)# hardware deep-buffer-mode
```

**Supported Releases** 10.4.3.0 or later

## match

Configures match criteria for the QoS policy.

**Syntax**

```
match {cos cos-number | ip [access-group name name | dscp dscp-value [ecn ecn-value] | precedence value] | ip-any [dscp dscp-value [ecn ecn-value] | precedence value] | ipv6 [access-group name name | dscp dscp-value [ecn ecn-value] | precedence value] | mac access-group acl-name | not [cos | ip | ip-any | ipv6] | vlan vlan-id | protocol-or-application-name}
```

- Parameters**
- `cos cos-number` — Enter a queue number for the CoS match criteria, from 0 to 7.
  - `ip` — Enter the IPv4 match criteria.
  - `access-group name name` — (Optional) Enter the IPv4 access-group name.
  - `dscp dscp-value` — (Optional) Enter a DSCP value for L3 DSCP match criteria, from 0 to 63.
  - `ecn ecn-value` — (Optional) Enter a ECN value for ECN bit match criteria, from 0 to 3.
  - `precedence value` — (Optional) Enter a precedence value for L3 precedence match criteria, from 0 to 7.
  - `ip-any` — Enter the IPv4 or IPv6 match criteria.
  - `dscp dscp-value` — (Optional) Enter a DSCP value for L3 DSCP match criteria, from 0 to 63.
  - `ecn ecn-value` — (Optional) Enter a ECN value for ECN bit match criteria, from 0 to 3.
  - `precedence value` — (Optional) Enter a precedence value for L3 precedence match criteria, from 0 to 7.
  - `ipv6` — Enter the IPv6 match criteria.
  - `access-group name name` — (Optional) Enter the IPv6 access-group name.
  - `dscp dscp-value` — (Optional) Configure a DSCP value for L3 DSCP match criteria, from 0 to 63.
  - `ecn ecn-value` — (Optional) Enter a ECN value for ECN bit match criteria, from 0 to 3.
  - `mac access-group name name` — Enter an access-group name for the MAC access-list match criteria. A maximum of 140 characters.
  - `dscp dscp-value` — Enter a DSCP value for marking the DSCP packets, from 0 to 63.
  - `not` — Enter the IP or CoS to negate the match criteria.
  - `vlan vlan-id` — Enter a VLAN number for VLAN match criteria, from 1 to 4093.
  - `protocol-or-application-name` — Enter the name of the protocol or application that you want to move from one queue to another.

**Default** Not configured

**Command Mode** CLASS-MAP

**Usage Information** In a `match-any` class, you can enter multiple match criteria. In a `match-all` class, if the match case is `access-group`, no other match criteria is allowed. If you attach the access-list to `class-map type control-plane` or `qos`, the access-list (IPv4, IPv6) ignores the `permit` and `deny` keywords.

**Example 1**

```
OS10(conf-cmap-qos)# match ip access-group name ag1
OS10(config-cmap-qos)# match ipv6 access-group name ACLv6
```

**Example 2**

```
OS10(config)# class-map type control-plane example-queue-remap
OS10(config-cmap-control-plane)# match vrrp
```

**Supported Releases** 10.2.0E or later

## match cos

Matches a cost of service (CoS) value to L2 dot1p packets.

**Syntax** `match [not] cos cos-value`

**Parameters**

- *cos-value* — Enter a CoS value, from 0 to 7.
- *not* — Enter *not* to cancel the match criteria.

**Default** Not configured

**Command Modes** CLASS-MAP

**Usage Information** You cannot have two match statements with the same filter-type. If you enter two match statements with the same filter-type, the second statement overwrites the first statement.

**Example**

```
OS10(conf-cmap-qos)# match cos 3
```

**Supported Releases** 10.2.0E or later

## match dscp

Configures a DSCP value as a match criteria for a class-map.

**Syntax** `match [not] {ip | ipv6 | ip-any } dscp [dscp-value] [ecn ecn-value]`

**Parameters**

- *not* — (Optional) Enter to cancel a previously applied match criteria.
- *ip* — Enter to use IPv4 as the match protocol.
- *ipv6* — Enter to use IPv6 as the match protocol.
- *ip-any* — Enter to use both IPv4 and IPv6 as the match protocol.
- *dscp dscp-value* — Enter a DSCP value in single numbers, comma separated, or a hyphenated range, from 0 to 63.
- *ecn ecn-value* — (Optional) Enter a ECN value for ECN bit match criteria, from 0 to 3.

**Default** Not configured

**Command Mode** CLASS-MAP

**Usage Information** You cannot enter two match statements with the same filter-type. If you enter two match statements with the same filter-type, the second statement overwrites the first statement. The *match-all* option in a class-map does not support *ip-any*. Select either *ip* or *IPv6* for the *match-all* criteria. If you select *ip-any*, you cannot select *ip* or *ipv6* for the same filter type.

**Example**

```
OS10(conf-cmap-qos)# match ip-any dscp 17-20
```

**Supported Releases** 10.2.0E or later

## match precedence

Configures IP precedence values as a match criteria.

**Syntax** `match [not] {ip | ipv6 | ip-any} precedence precedence-list`

**Parameters**

- *not* — Enter to cancel a previously applied match precedence rule.

- `ip` — Enter to use IPv4 as the match precedence rule.
- `ipv6` — Enter to use IPv6 as the match precedence rule.
- `ip-any` — Enter to use both IPv4 and IPv6 as the match precedence rule.
- `precedence precedence-list` — Enter a precedence-list value, from 0 to 7.

**Default** Not configured

**Command Mode** CLASS-MAP

**Usage Information** You cannot enter two match statements with the same filter-type. If you enter two match statements with the same filter-type, the second statement overwrites the first statement.

**Example**

```
OS10(conf-cmap-qos)# match not ipv6 precedence 3
```

**Supported Releases** 10.2.0E or later

## match queue

Configures a match criteria for a queue.

**Syntax** `match queue queue-number`

**Parameters** `queue-number` — Enter a queue number, from 0 to 7.

**Default** Not configured

**Command Mode** CLASS-MAP

**Usage Information** You can configure this command only when the class-map type is `queuing`. You cannot enter two match statements with the same filter-type. If you enter two match statements with the same filter-type, the second statement overwrites the first statement.

**Example**

```
OS10(conf-cmap-queuing)# match queue 1
```

**Supported Releases** 10.2.0E or later

## match vlan

Configures a match criteria based on the VLAN ID number.

**Syntax** `match vlan vlan-id`

**Parameters** `vlan-id` — Enter a VLAN ID number, from 1 to 4093.

**Default** Not configured

**Command Mode** CLASS-MAP

**Usage Information** You cannot enter two match statements with the same filter-type. If you enter two match statements with the same filter-type, the second statement overwrites the first statement.

**Example**

```
OS10(conf-cmap-qos)# match vlan 100
```

**Supported Releases** 10.2.0E or later

## mtu

Calculates the buffer size allocation for matched flows.

|                           |                                                                               |
|---------------------------|-------------------------------------------------------------------------------|
| <b>Syntax</b>             | <code>mtu size</code>                                                         |
| <b>Parameters</b>         | <code>size</code> — Enter the size of the buffer (1500 to 9216).              |
| <b>Default</b>            | 9216                                                                          |
| <b>Command Mode</b>       | POLICY-MAP-CLASS-MAP                                                          |
| <b>Usage Information</b>  | The <code>no</code> version of this command returns the value to the default. |
| <b>Example</b>            | <pre>OS10(conf-pmap-nqos-c)# mtu 2500</pre>                                   |
| <b>Supported Releases</b> | 10.3.0E or later                                                              |

## pause

Enables a pause based on buffer limits for the port to start or stop communication to the peer.

|                                           |                                                                                                                                                                                                                                                                                                                                                                                                                                                                                                                                                                                                                                                                                                                    |
|-------------------------------------------|--------------------------------------------------------------------------------------------------------------------------------------------------------------------------------------------------------------------------------------------------------------------------------------------------------------------------------------------------------------------------------------------------------------------------------------------------------------------------------------------------------------------------------------------------------------------------------------------------------------------------------------------------------------------------------------------------------------------|
| <b>Syntax</b>                             | <code>pause [buffer-size size pause-threshold xoff-size resume-threshold xon-size]</code>                                                                                                                                                                                                                                                                                                                                                                                                                                                                                                                                                                                                                          |
| <b>Parameters</b>                         | <ul style="list-style-type: none"><li>• <code>buffer-size size</code> — (Optional) Enter the ingress buffer size used as a guaranteed buffer in KB, default values: 10G–45KB, 40G–93KB.</li><li>• <code>pause-threshold xoff-size</code> — (Optional) Enter the buffer limit for the port to start or initiate a pause to the peer in KB, default values: 10G–9KB, 40G–18KB.</li><li>• <code>resume-threshold xon-size</code> — (Optional) Enter the buffer limit for the port to stop or cancel sending a pause to the peer in KB (defaults 10G–9KB, 40G–9KB).</li></ul>                                                                                                                                          |
| <b>Default</b>                            | See parameter values                                                                                                                                                                                                                                                                                                                                                                                                                                                                                                                                                                                                                                                                                               |
| <b>Command Mode</b>                       | POLICY-MAP-CLASS-MAP                                                                                                                                                                                                                                                                                                                                                                                                                                                                                                                                                                                                                                                                                               |
| <b>Usage Information</b>                  | Only use this command under the <code>network-qos</code> policy type. Buffer-size, pause-thresholds, and resume-thresholds vary based on platform. Add the policy-map with <code>pause</code> to system-qos to service an input to enable <code>pause</code> on all ports, based on a per-port link-level Flow-Control or Priority Flow-Control enable mode. The <code>xoff</code> and <code>xon</code> threshold settings for link-level flow-control are applied on ports where all traffic classes must be mapped to a single PG. Platform-specific default values are based on MTU sizes of 9216 and cable length of 100 meters. The <code>no</code> version of this command returns the value to the default. |
| <b>Example</b>                            | <pre>OS10(conf-pmap-c-nqos)# pause buffer-size 45 pause-threshold 25 resume-threshold 10</pre>                                                                                                                                                                                                                                                                                                                                                                                                                                                                                                                                                                                                                     |
| <b>Example (global and shared buffer)</b> | <pre>OS10(config)# policy-map type network-qos nqGlobalpolicy1 OS10(conf-cmap-nqos)# class CLASS-NAME OS10(conf-cmap-nqos-c)# pause buffer-size 45 pause-threshold 30 resume-threshold 30  OS10(config)# policy-map type network-qos nqGlobalpolicy1 OS10(conf-cmap-nqos)# class type network-qos nqclass1 OS10(conf-cmap-nqos-c)# pause buffer-size 45 pause-threshold 30 resume-threshold 10</pre>                                                                                                                                                                                                                                                                                                               |
| <b>Supported Releases</b>                 | 10.3.0E or later                                                                                                                                                                                                                                                                                                                                                                                                                                                                                                                                                                                                                                                                                                   |

## pfc-cos

Configures priority flow-control for cost of service (CoS).

|                                              |                                                                                                                                                                                                                                                                                                                                                                                                                                                                                                                                                                                                                                                                                                                                                                                                                                                                   |
|----------------------------------------------|-------------------------------------------------------------------------------------------------------------------------------------------------------------------------------------------------------------------------------------------------------------------------------------------------------------------------------------------------------------------------------------------------------------------------------------------------------------------------------------------------------------------------------------------------------------------------------------------------------------------------------------------------------------------------------------------------------------------------------------------------------------------------------------------------------------------------------------------------------------------|
| <b>Syntax</b>                                | <code>pfc-cos cos-value</code>                                                                                                                                                                                                                                                                                                                                                                                                                                                                                                                                                                                                                                                                                                                                                                                                                                    |
| <b>Parameters</b>                            | <code>cos-value</code> — Enter a single, comma-delimited, or hyphenated range of CoS values for priority flow-control to enable, from 0 to 7.<br> <b>NOTE:</b> The range 0-7 is invalid. All other ranges, including 0-6 and 1-7 are valid.                                                                                                                                                                                                                                                                                                                                                                                                                                                                                                                                      |
| <b>Default</b>                               | Not configured                                                                                                                                                                                                                                                                                                                                                                                                                                                                                                                                                                                                                                                                                                                                                                                                                                                    |
| <b>Command Mode</b>                          | POLICY-MAP-CLASS-MAP                                                                                                                                                                                                                                                                                                                                                                                                                                                                                                                                                                                                                                                                                                                                                                                                                                              |
| <b>Usage Information</b>                     | To configure link-level flow-control, do not configure <code>pfc-cos</code> for the matched class for this policy. Add the policy-map with the <code>pfc-cos</code> configuration to <code>system-qos</code> to service an input to enable priority flow-control behavior on all ports, based on a per-port Priority Flow-Control Enable mode. Add the policy-map with the <code>pfc-cos</code> configuration to interface configurations to service at input and enable Priority Flow-Control on that particular port, based on the port's Priority Flow-Control Enable mode. If you configure 40G to 10G mode on interfaces and <code>pause (no drop)</code> is enabled on <code>system-qos</code> , all queues may or may not drop traffic based on the availability of buffers. The <code>no</code> version of this command returns the value to the default. |
| <b>Example</b>                               | <pre>OS10(conf-pmap-c-nqos)# pfc-cos 0-2</pre>                                                                                                                                                                                                                                                                                                                                                                                                                                                                                                                                                                                                                                                                                                                                                                                                                    |
| <b>Example (global buffer/shared buffer)</b> | <pre>OS10(config)# policy-map type network-qos nqGlobalpolicy1 OS10(conf-cmap-nqos)# class CLASS-NAME OS10(conf-cmap-nqos-c)# pause buffer-size 45 pause-threshold 25 resume-threshold 10 OS10(conf-cmap-nqos-c)# pfc-cos 0-2 OS10(conf-cmap-nqos-c)# queue-limit 140</pre>                                                                                                                                                                                                                                                                                                                                                                                                                                                                                                                                                                                       |
| <b>Supported Releases</b>                    | 10.3.0E or later                                                                                                                                                                                                                                                                                                                                                                                                                                                                                                                                                                                                                                                                                                                                                                                                                                                  |

## pfc-max-buffer-size

Configures the maximum buffer size for priority flow-control enabled flows.

|                           |                                                                                                                                                          |
|---------------------------|----------------------------------------------------------------------------------------------------------------------------------------------------------|
| <b>Syntax</b>             | <code>pfc-max-buffer-size max-buffer-size</code>                                                                                                         |
| <b>Parameters</b>         | <code>max-buffer-size</code> — Enter the maximum buffer size in KB.                                                                                      |
| <b>Default</b>            | None                                                                                                                                                     |
| <b>Command Mode</b>       | SYSTEM-QOS                                                                                                                                               |
| <b>Usage Information</b>  | This command configures the maximum size of the lossless buffer pool. The <code>no</code> version of this command removes the maximum buffer size limit. |
| <b>Example</b>            | <pre>OS10(config-sys-qos)# pfc-max-buffer-size 2000</pre>                                                                                                |
| <b>Supported Releases</b> | 10.4.0E(R1) or later                                                                                                                                     |

## pfc-shared-buffer-size

Changes the shared buffers size limit for priority flow-control enabled flows.

|                   |                                                                                                      |
|-------------------|------------------------------------------------------------------------------------------------------|
| <b>Syntax</b>     | <code>pfc-shared-buffer-size buffer-size</code>                                                      |
| <b>Parameters</b> | <code>buffer-size</code> — Enter the size of the priority flow-control buffer in KB, from 0 to 8911. |

|                           |                                                                               |
|---------------------------|-------------------------------------------------------------------------------|
| <b>Default</b>            | 832 KB                                                                        |
| <b>Command Mode</b>       | SYSTEM-QOS                                                                    |
| <b>Usage Information</b>  | The <code>no</code> version of this command returns the value to the default. |
| <b>Example</b>            | <pre>OS10 (conf-sys-qos)# pfc-shared-buffer-size 2000</pre>                   |
| <b>Supported Releases</b> | 10.3.0E or later                                                              |

## pfc-shared-headroom-buffer-size

Configures the shared headroom size for absorbing the packets after pause frames generate.

**NOTE:** This command is available only on the following platforms:

- S5212F-ON, S5224F-ON, S5232F-ON, S5248F-ON, S5296F-ON
- Z9100-ON
- Z9264F-ON

|                           |                                                                                                                                                                                                                                                                                                                                                                                                                                    |
|---------------------------|------------------------------------------------------------------------------------------------------------------------------------------------------------------------------------------------------------------------------------------------------------------------------------------------------------------------------------------------------------------------------------------------------------------------------------|
| <b>Syntax</b>             | <code>pfc-shared-headroom-buffer-size headroom-buffer-size</code>                                                                                                                                                                                                                                                                                                                                                                  |
| <b>Parameters</b>         | <code>headroom-buffer-size</code> — Enter the size of the priority flow-control headroom buffer in KB, from 1 to 3399.                                                                                                                                                                                                                                                                                                             |
| <b>Default</b>            | 1024 KB                                                                                                                                                                                                                                                                                                                                                                                                                            |
| <b>Command Mode</b>       | SYSTEM-QOS                                                                                                                                                                                                                                                                                                                                                                                                                         |
| <b>Usage Information</b>  | All PFC-enabled priority groups can use the shared headroom space. Headroom is the buffer space that absorbs the incoming packets after the PFC frames reach the sender. After the threshold is reached, PFC frames generate towards the sender. The packets sent by the sender after the PFC frames generate are absorbed into the Headroom buffer. The <code>no</code> version of this command returns the value to the default. |
| <b>Example</b>            | <pre>OS10 (conf-sys-qos)# pfc-shared-headroom-buffer-size 2000</pre>                                                                                                                                                                                                                                                                                                                                                               |
| <b>Supported Releases</b> | 10.4.0E(R1) or later                                                                                                                                                                                                                                                                                                                                                                                                               |

## police

Configures traffic policing on incoming traffic.

|                     |                                                                                                                                                                                                                                                                                                                                                                                                                                                                                                                                                                                |
|---------------------|--------------------------------------------------------------------------------------------------------------------------------------------------------------------------------------------------------------------------------------------------------------------------------------------------------------------------------------------------------------------------------------------------------------------------------------------------------------------------------------------------------------------------------------------------------------------------------|
| <b>Syntax</b>       | <code>police {cir committed-rate [bc committed-burst-size]} {pir peak-rate [be peak-burst-size]}</code>                                                                                                                                                                                                                                                                                                                                                                                                                                                                        |
| <b>Parameters</b>   | <ul style="list-style-type: none"> <li>• <code>cir committed-rate</code> — Enter a committed rate value in kilo bits per second, from 0 to 4000000.</li> <li>• <code>bc committed-burst-size</code> — (Optional) Enter the committed burst size in packets for control plane policing and in KB for data packets, from 16 to 200000.</li> <li>• <code>pir peak-rate</code> — Enter a peak-rate value in kilo bits per second, from 0 to 40000000.</li> <li>• <code>be peak-burst-size</code> — (Optional) Enter a peak burst size in kilo bytes, from 16 to 200000.</li> </ul> |
| <b>Defaults</b>     | <ul style="list-style-type: none"> <li>• <code>bc committed-burst-size</code> value is 200 KB for control plane and 100 KB for all other class-map types</li> <li>• <code>be peak-burst-size</code> value is 200 KB for control plane and 100 KB for all other class-map types</li> </ul>                                                                                                                                                                                                                                                                                      |
| <b>Command Mode</b> | POLICY-MAP-CLASS-MAP                                                                                                                                                                                                                                                                                                                                                                                                                                                                                                                                                           |

**Usage Information** If you do not provide the peak-rate `pir` values, the committed-rate `cir` values are taken as the `pir` values. Only the ingress QoS policy type supports this command. For control-plane policing, the rate values are in pps.

**Example**

```
OS10(conf-pmap-c-qos)# police cir 5 bc 30 pir 20 be 40
```

**Supported Releases** 10.2.0E or later

## policy-map

Enters QoS POLICY-MAP mode and creates or modifies a QoS policy-map.

**Syntax** `policy-map policy-map-name [type {qos | queuing | control-plane | application | network-qos }]`

- Parameters**
- `policy-map-name` — Enter a class name for the policy-map. A maximum of 32 characters.
  - `type` — Enter the policy-map type.
    - `qos` — Create a qos policy-map type.
    - `queuing` — Create a queuing policy-map type.
    - `control-plane` — Create a control-plane policy-map type.
    - `application` — Create an application policy-map type.
    - `network-qos` — Create a network-qos policy-map type.

**Defaults** `qos = class-map type and match-any = class-map filter`

**Command Mode** CONFIGURATION

**Usage Information** The `no` version of this command deletes a policy-map.

**Example**

```
OS10(config)# policy-map p1
```

**Example (Queuing)**

```
OS10(config)# policy-map type queuing p1
```

**Supported Releases** 10.2.0E or later

## priority

Sets the scheduler as a strict priority.

**Syntax** `priority`

**Parameters** None

**Default** WDRR — when priority is mentioned, it moves to SP with default level 1.

**Command Mode** POLICY-MAP-CLASS-MAP

**Usage Information** If you use this command, bandwidth is not allowed. Only the egress QoS policy type supports this command.

**Example**

```
OS10(config-pmap-c-que)# priority
```

**Supported Releases** 10.2.0E or later



## priority-flow-control mode

Enables or disables Priority Flow-Control mode on an interface.

|                           |                                                                                                                                                                                                                                                                                                                                                                                               |
|---------------------------|-----------------------------------------------------------------------------------------------------------------------------------------------------------------------------------------------------------------------------------------------------------------------------------------------------------------------------------------------------------------------------------------------|
| <b>Syntax</b>             | <code>priority-flow-control mode [on]</code>                                                                                                                                                                                                                                                                                                                                                  |
| <b>Parameters</b>         | <ul style="list-style-type: none"><li>• <code>on</code> — (Optional) Enables Priority Flow-Control mode.</li></ul>                                                                                                                                                                                                                                                                            |
| <b>Default</b>            | Disabled                                                                                                                                                                                                                                                                                                                                                                                      |
| <b>Command Mode</b>       | INTERFACE                                                                                                                                                                                                                                                                                                                                                                                     |
| <b>Usage Information</b>  | Before enabling priority flow-control on a interface, verify a matching <code>network-qos</code> type policy is configured with the <code>pfccos</code> value for an interface. Use this command to disable priority flow-control if you are not using a <code>network-qos</code> type policy for an interface. The <code>no</code> version of this command returns the value to the default. |
| <b>Example</b>            | <pre>OS10(conf-if-eth1/1/2)# priority-flow-control mode on</pre>                                                                                                                                                                                                                                                                                                                              |
| <b>Supported Releases</b> | 10.3.0E or later                                                                                                                                                                                                                                                                                                                                                                              |

## qos-group dot1p

Configures a dot1p trust map to the traffic class.

|                           |                                                                                                                                                                                                                                                                                                                                                                                                                                                           |
|---------------------------|-----------------------------------------------------------------------------------------------------------------------------------------------------------------------------------------------------------------------------------------------------------------------------------------------------------------------------------------------------------------------------------------------------------------------------------------------------------|
| <b>Syntax</b>             | <code>qos-group tc-list [dot1p values]</code>                                                                                                                                                                                                                                                                                                                                                                                                             |
| <b>Parameters</b>         | <ul style="list-style-type: none"><li>• <code>qos-group tc-list</code> — Enter the traffic single value class ID, from 0 to 7.</li><li>• <code>dot1p values</code> — (Optional) Enter either single, comma-delimited, or a hyphenated range of dot1p values, from 0 to 7.</li></ul>                                                                                                                                                                       |
| <b>Default</b>            | 0                                                                                                                                                                                                                                                                                                                                                                                                                                                         |
| <b>Command Mode</b>       | TRUST-MAP                                                                                                                                                                                                                                                                                                                                                                                                                                                 |
| <b>Usage Information</b>  | If the trust map does not define dot1p values to any traffic class, those flows map to the default traffic class 0. If some of the dot1p values are already mapped to an existing traffic class, you see an error. You must have a 1:1 dot1p-to-traffic class mapping for PFC-enabled CoS values. You must also have a common dot1p trust map for all interfaces using DCB. The <code>no</code> version of this command returns the value to the default. |
| <b>Example</b>            | <pre>OS10(conf-tmap-dot1p-qos)# qos-group 5 dot1p 5</pre>                                                                                                                                                                                                                                                                                                                                                                                                 |
| <b>Supported Releases</b> | 10.3.0E or later                                                                                                                                                                                                                                                                                                                                                                                                                                          |

## qos-group dscp

Configures a DSCP trust map to the traffic class.

|                     |                                                                                                                                                                                                                                                                                    |
|---------------------|------------------------------------------------------------------------------------------------------------------------------------------------------------------------------------------------------------------------------------------------------------------------------------|
| <b>Syntax</b>       | <code>qos-group tc-list [dscp values]</code>                                                                                                                                                                                                                                       |
| <b>Parameters</b>   | <ul style="list-style-type: none"><li>• <code>qos-group tc-list</code> — Enter the traffic single value class ID, from 0 to 7.</li><li>• <code>dscp values</code> — (Optional) Enter either single, comma-delimited, or a hyphenated range of DSCP values, from 0 to 63.</li></ul> |
| <b>Default</b>      | 0                                                                                                                                                                                                                                                                                  |
| <b>Command Mode</b> | TRUST-MAP                                                                                                                                                                                                                                                                          |

**Usage Information** If the trust map does not define DSCP values to any traffic class, those flows map to the default traffic class 0. If some of the DSCP values are already mapped to an existing traffic class, you will see an error. The `no` version of this command returns the value to the default.

**Example**

```
OS10(config-tmap-dscp-qos)# qos-group 5 dscp 42
```

**Supported Releases** 10.3.0E or later

## qos-map traffic-class

Creates a user-defined trust map for queue mapping.

**Syntax** `qos-map traffic-class map-name`

**Parameters** `map-name` — Enter the name of the queue trust map. A maximum of 32 characters.

**Default** Not configured

**Command Mode** CONFIGURATION

**Usage Information** If applied on the interface or system level, the traffic class routes all traffic to the mapped queue. The `no` version of this command returns the value to the default.

**Example**

```
OS10(config)# qos-map traffic-class queue-map1
OS10(config-qos-map)# queue 1 qos-group 5
OS10(config-qos-map)# queue 2 qos-group 6
OS10(config-qos-map)# queue 3 qos-group 7
OS10(config-qos-map)#
```

**Supported Releases** 10.3.0E or later

## qos-rate-adjust

Configures additional number of data bytes to add to overhead fields per frame for rate calculations.

**Syntax** `qos-rate-adjust [value-of-adjust]`

**Parameters** `value-of-adjust`—Number of bytes to add to overhead fields in each frame, from 1 to 31.

**Default** 0

**Command Mode** CONFIGURATION

**Usage Information** The `no` form of this command removes the rate adjustment configuration and is the same as using the `qos-rate-adjust 0` command.

**Example**

```
OS10(config)# qos-rate-adjust 10
```

**Supported Releases** 10.4.3.0 or later

## queue-limit

Configures static or dynamic shared buffer thresholds.

**Syntax** `queue-limit {queue-len value | thresh-mode [dynamic threshold-alpha-value | static threshold-value]}`

**Parameters**

- `queue-len value` — Enter the guaranteed size for the queue, from 0 to 8911.

- 45 KB (10G)/111 KB (40G) if the queue is priority flow control enabled
- 2 KB (10G)/8 KB (40G) if the queue is lossy/link-level flow control
- If this is a priority flow-control queue, this configuration is invalid
- Only supported for POLICY-MAP-CLASS-MAP (`pmap-c-queue`) mode
- `thresh-mode` — (Optional) Buffer threshold mode.
- `dynamic thresh-alpha-value` — (Optional) Enter the value indexes to calculate the shared threshold to the enabled dynamic shared buffer threshold, from 0 to 10. Defaults:
  - 0 = 1/128
  - 1 = 1/64
  - 2 = 1/32
  - 3 = 1/16
  - 4 = 1/8
  - 5 = 1/4
  - 6 = 1/2
  - 7 = 1
  - 8 = 2
  - 9 = 4
  - 10 = 8
- `static thresh-value` — (Optional) Enter the static shared buffer threshold value in Bytes, from 1 to 65535.

**Default** Not configured

**Command Mode** POLICY-MAP-CLASS-MAP

**Usage Information** Use the `queue-len value` parameter to set the minimum guaranteed queue length for a queue. The `no` version of this command returns the value to the default.

**Example**

```
OS10(config)# policy-map type network-qos nqGlobalpolicy1
OS10(conf-cmap-nqos)# class type network-qos nqclass1
OS10(conf-cmap-nqos-c)# pause buffer-size 45 pause-threshold 30 resume-
threshold 10
OS10(conf-cmap-nqos-c)# queue-limit 150
```

**Example (queue)**

```
OS10(config)# policy-map type queuing pmap1
OS10(config-pmap-queuing)# class cmap1
OS10(config-pmap-c-que)# queue-limit queue-len 100
OS10(config-pmap-c-que)# queue-limit thresh-mode static 50
```

**Supported Releases** 10.3.0E or later

## queue bandwidth

Configures a bandwidth for a given queue on interface.

**Syntax** `queue queue-number bandwidth bandwidth-percentage`

- Parameters**
- `queue-number` — Enter the queue number.
  - `bandwidth-percentage` — Enter the percentage of bandwidth.

**Default** Not configured

**Command Mode** POLICY-MAP-CLASS-MAP

**Usage Information** The `no` version of this command removes the bandwidth from the queue.

**Example** None

**Supported Releases** 10.4.0E(R1) or later

## queue qos-group

Configures a dot1p traffic class to a queue.

|                           |                                                                                                                                                                                                                                                                                          |
|---------------------------|------------------------------------------------------------------------------------------------------------------------------------------------------------------------------------------------------------------------------------------------------------------------------------------|
| <b>Syntax</b>             | <code>queue number [qos-group dot1p-values]</code>                                                                                                                                                                                                                                       |
| <b>Parameters</b>         | <ul style="list-style-type: none"><li>• <code>queue number</code> — Enter the traffic single value queue ID, from 0 to 7.</li><li>• <code>qos-group dot1p-values</code> — (Optional) Enter either single, comma-delimited, or a hyphenated range of dot1p values, from 0 to 7.</li></ul> |
| <b>Default</b>            | 0                                                                                                                                                                                                                                                                                        |
| <b>Command Mode</b>       | TRUST-MAP                                                                                                                                                                                                                                                                                |
| <b>Usage Information</b>  | If the trust map does not define traffic class values to a queue, those flows map to the default queue 0. If some of the traffic class values are already mapped to an existing queue, you see an error. The <code>no</code> version of this command returns the value to the default.   |
| <b>Example</b>            | <pre>OS10(conf-tmap-tc-queue-qos)# queue 2 qos-group 5</pre>                                                                                                                                                                                                                             |
| <b>Supported Releases</b> | 10.3.0E or later                                                                                                                                                                                                                                                                         |

## queue qos-group (Z9332F-ON)

Configure mapping for different traffic class types to different queues.

|                           |                                                                                                                                                                                                                                                                                                                                                                                                                       |
|---------------------------|-----------------------------------------------------------------------------------------------------------------------------------------------------------------------------------------------------------------------------------------------------------------------------------------------------------------------------------------------------------------------------------------------------------------------|
| <b>Syntax</b>             | <code>queue number qos-group traffic-class-number type {unicast   multicast}</code>                                                                                                                                                                                                                                                                                                                                   |
| <b>Parameters</b>         | <ul style="list-style-type: none"><li>• <code>queue number</code> — Enter the traffic single value queue ID, from 0 to 7. Multicast Queue ranges from 0 to 2.</li><li>• <code>qos-group traffic-class-number</code> — Enter the traffic class number, either single, comma-delimited, or hyphenated-range</li><li>• <code>type unicast   multicast</code> — Select either a unicast or multicast queue type</li></ul> |
| <b>Default</b>            | NA                                                                                                                                                                                                                                                                                                                                                                                                                    |
| <b>Command Mode</b>       | CONFIGURATION (config-qos-map)                                                                                                                                                                                                                                                                                                                                                                                        |
| <b>Usage Information</b>  | The command applies to Z9332F-ON. The <code>no</code> version of this command returns the value to the default.                                                                                                                                                                                                                                                                                                       |
| <b>Example</b>            | <pre>OS10(config-qos-map)# queue 2 qos-group 2-5 type unicast</pre>                                                                                                                                                                                                                                                                                                                                                   |
| <b>Supported Releases</b> | 10.5.0 or later                                                                                                                                                                                                                                                                                                                                                                                                       |

## random-detect (interface)

Assigns a WRED profile to the specified interface.

|                          |                                                                                          |
|--------------------------|------------------------------------------------------------------------------------------|
| <b>Syntax</b>            | <code>random-detect wred-profile</code>                                                  |
| <b>Parameters</b>        | <code>wred-profile</code> — Enter the name of an existing WRED profile.                  |
| <b>Default</b>           | Not configured                                                                           |
| <b>Command Mode</b>      | INTERFACE                                                                                |
| <b>Usage Information</b> | The <code>no</code> version of this command removes the WRED profile from the interface. |

**Example**

```
OS10(config)# interface ethernet 1/1/1
OS10(conf-if-eth1/1/1)# random-detect test_wred
```

**Supported Releases**

10.4.0E(R1) or later

## random-detect (queue)

Assigns a WRED profile to the specified queue.

**Syntax**

```
random-detect wred-profile-name
```

**Parameters**

*wred-profile-name* — Enter the name of an existing WRED profile.

**Default**

Not configured

**Command Mode**

PMAP-C-QUE

**Usage Information**

The no version of this command removes the WRED profile from the queue.

**Example**

```
OS10(config)# policy-map type queuing p1
OS10(config-pmap-queuing)# class c1
OS10(config-pmap-c-que)# random-detect test_wred
```

**Supported Releases**

10.4.0E(R1) or later

## random-detect color

Configures the threshold of WRED profile for available colors.

**Syntax**

```
random-detect color color-name minimum-threshold minimum-value maximum-
threshold maximum-value drop-probability drop-rate
```

**Parameters**

- *color-name* — Enter the color of drop precedence for the WRED profile. The available options are green, yellow, and red.
- *minimum-value* — Enter the minimum threshold value for the specified color, from 1 to 12480.
- *maximum-value* — Enter the maximum threshold value for the specified color, from 1 to 12480.
- *drop-rate* — Enter the rate of drop precedence in percentage, from 0 to 100.

**Default**

Not configured

**Command Mode**

WRED CONFIGURATION

**Usage Information**

The no version of this command removes the WRED profile.

**Example**

```
OS10(config)# wred test_wred
OS10(config-wred)# random-detect color green minimum-threshold 100
maximum-threshold 300 drop-probability 40
```

**Supported Releases**

10.4.0E(R1) or later

## random-detect ecn

Enables explicit congestion notification (ECN) for the WRED profile.

**Syntax**

```
random-detect ecn
```

|                          |                                              |
|--------------------------|----------------------------------------------|
| <b>Parameters</b>        | None                                         |
| <b>Default</b>           | Not configured                               |
| <b>Command Mode</b>      | WRED CONFIGURATION                           |
| <b>Usage Information</b> | The no version of this command disables ECN. |

**Example**

```
OS10(config)# wred test_wred
OS10(config-wred)# random-detect ecn
```

|                           |                      |
|---------------------------|----------------------|
| <b>Supported Releases</b> | 10.4.0E(R1) or later |
|---------------------------|----------------------|

## random-detect ecn

Enables ECN for the system globally.

|                     |                                |
|---------------------|--------------------------------|
| <b>Syntax</b>       | <code>random-detect ecn</code> |
| <b>Default</b>      | Not configured                 |
| <b>Command Mode</b> | SYSTEM QOS                     |

**Usage Information** The no version of this command disables ECN globally.

 **NOTE:** This command enables ECN globally and is supported only on the S4200-ON Series platform. In the SYSTEM QOS mode, this command is not available on other platforms. Also, you can configure ECN only per queue; you cannot configure ECN on an interface or service pool on the S4200-ON Series platform.

**Example**

```
applicableOS10(config)# system-qos
OS10(config-sys-qos)# random-detect ecn
```

|                           |                   |
|---------------------------|-------------------|
| <b>Supported Releases</b> | 10.4.1.0 or later |
|---------------------------|-------------------|

## random-detect pool

Assigns a WRED profile to the specified global buffer pool.

|                     |                                                                                                                                                                                              |
|---------------------|----------------------------------------------------------------------------------------------------------------------------------------------------------------------------------------------|
| <b>Syntax</b>       | <code>random-detect pool <i>pool-value</i> <i>wred-profile-name</i></code>                                                                                                                   |
| <b>Parameters</b>   | <ul style="list-style-type: none"> <li>• <i>pool-value</i> — Enter the pool value, from 0 to 1.</li> <li>• <i>wred-profile-name</i> — Enter the name of an existing WRED profile.</li> </ul> |
| <b>Default</b>      | Not configured                                                                                                                                                                               |
| <b>Command Mode</b> | SYSTEM-QOS                                                                                                                                                                                   |

**Usage Information** The no version of this command removes the WRED profile from the interface.

**Example**

```
OS10(config)# system qos
OS10(config-sys-qos)# random-detect pool 0 test_wred
```

|                           |                      |
|---------------------------|----------------------|
| <b>Supported Releases</b> | 10.4.0E(R1) or later |
|---------------------------|----------------------|

## random-detect weight

Configures the exponential weight value used to calculate the average queue depth for the WRED profile.

|                           |                                                                                              |
|---------------------------|----------------------------------------------------------------------------------------------|
| <b>Syntax</b>             | <code>random-detect weight weight-value</code>                                               |
| <b>Parameters</b>         | <code>weight-value</code> — Enter a value for the weight, from 1 to 15.                      |
| <b>Default</b>            | Not configured                                                                               |
| <b>Command Mode</b>       | WRED CONFIGURATION                                                                           |
| <b>Usage Information</b>  | The <code>no</code> version of this command removes the weight factor from the WRED profile. |
| <b>Example</b>            | <pre>OS10(config)# wred test_wred OS10(config-wred)# random-detect weight 10</pre>           |
| <b>Supported Releases</b> | 10.4.0E(R1) or later                                                                         |

## service-policy

Configures the input and output service policies.

|                           |                                                                                                                                                                                                                                                                                                                                                                                                                                                                                                                                                                                                                                                                                                                                                                                                                                                                                                                                                 |
|---------------------------|-------------------------------------------------------------------------------------------------------------------------------------------------------------------------------------------------------------------------------------------------------------------------------------------------------------------------------------------------------------------------------------------------------------------------------------------------------------------------------------------------------------------------------------------------------------------------------------------------------------------------------------------------------------------------------------------------------------------------------------------------------------------------------------------------------------------------------------------------------------------------------------------------------------------------------------------------|
| <b>Syntax</b>             | <code>service-policy {input   output} [type {qos   queuing   network-qos}] policy-map-name</code>                                                                                                                                                                                                                                                                                                                                                                                                                                                                                                                                                                                                                                                                                                                                                                                                                                               |
| <b>Parameters</b>         | <ul style="list-style-type: none"><li>• <code>input</code>—Enter to assign a QoS policy to the interface input.</li><li>• <code>output</code>—Enter to assign a QoS policy to the interface output.</li><li>• <code>qos</code>—Enter to assign a <code>qos</code> type policy-map.</li><li>• <code>queuing</code>—Enter to assign the <code>queuing</code> type policy-map.</li><li>• <code>network-qos</code>—Enter to assign the <code>network-qos</code> type policy-map.</li><li>• <code>policy-map-name</code>—Enter the policy-map name up to a maximum of 32 characters.</li></ul>                                                                                                                                                                                                                                                                                                                                                       |
| <b>Default</b>            | Not configured                                                                                                                                                                                                                                                                                                                                                                                                                                                                                                                                                                                                                                                                                                                                                                                                                                                                                                                                  |
| <b>Command Mode</b>       | INTERFACE                                                                                                                                                                                                                                                                                                                                                                                                                                                                                                                                                                                                                                                                                                                                                                                                                                                                                                                                       |
| <b>Usage Information</b>  | Attach only one policy-map to the interface input and output for each <code>qos</code> and <code>queuing</code> policy-map type. You can attach four service-policies to the system QoS—one each for <code>qos</code> , <code>queuing</code> , and <code>network-qos</code> type policy-maps. When you configure interface-level policies and system-level policies, the interface-level policy takes precedence over the system-level policy.<br><br> <b>NOTE:</b> Apply the <code>service-policy input type network-qos</code> command only on the applicable interfaces instead of the SYSTEM-QoS mode. Applying this command in the global SYSTEM-QoS mode might cause CRC errors on the remote end fiber channel devices. You can apply this command on all downstream and upstream interfaces using the <code>interface range ethernet</code> command. |
| <b>Example</b>            | <pre>OS10(conf-if-eth1/1/7)# service-policy input type qos p1</pre>                                                                                                                                                                                                                                                                                                                                                                                                                                                                                                                                                                                                                                                                                                                                                                                                                                                                             |
| <b>Supported Releases</b> | 10.2.0E or later                                                                                                                                                                                                                                                                                                                                                                                                                                                                                                                                                                                                                                                                                                                                                                                                                                                                                                                                |

## set cos

Sets a cost of service (CoS) value to mark L2 802.1p (dot1p) packets.

|               |                                |
|---------------|--------------------------------|
| <b>Syntax</b> | <code>set cos cos-value</code> |
|---------------|--------------------------------|

|                           |                                                                                                                                                                                                                                                           |
|---------------------------|-----------------------------------------------------------------------------------------------------------------------------------------------------------------------------------------------------------------------------------------------------------|
| <b>Parameters</b>         | <i>cos-value</i> — Enter a CoS value, from 0 to 7.                                                                                                                                                                                                        |
| <b>Default</b>            | Not configured                                                                                                                                                                                                                                            |
| <b>Command Mode</b>       | POLICY-MAP-CLASS-MAP                                                                                                                                                                                                                                      |
| <b>Usage Information</b>  | You cannot enter two set statements with the same action-type. If you enter two set statements with the same action-type, the second statement overwrites the first. When class-map type is <i>qos</i> , the qos-group corresponds to data queues 0 to 7. |
| <b>Example</b>            | <pre>OS10(conf-pmap-c-qos)# set cos 6</pre>                                                                                                                                                                                                               |
| <b>Supported Releases</b> | 10.2.0E or later                                                                                                                                                                                                                                          |

## set dscp

Sets the drop precedence for incoming packets based on their DSCP value and color map profile.

|                           |                                                                                                                                                                                                                                                                                                                                                                                            |
|---------------------------|--------------------------------------------------------------------------------------------------------------------------------------------------------------------------------------------------------------------------------------------------------------------------------------------------------------------------------------------------------------------------------------------|
| <b>Syntax</b>             | <code>set dscp <i>dscp-value</i> [color {red   yellow}]</code>                                                                                                                                                                                                                                                                                                                             |
| <b>Parameters</b>         | <ul style="list-style-type: none"> <li>• <i>dscp-value</i> — Enter a DSCP value, from 0 to 63.</li> <li>• <i>color</i> — (Optional) — Enter to apply a color map profile.</li> <li>• <i>red</i> — (Optional) Enter to mark the packets to drop.</li> <li>• <i>yellow</i> — (Optional) Enter to mark the packets to deliver to the egress queue.</li> </ul>                                 |
| <b>Default</b>            | Not configured                                                                                                                                                                                                                                                                                                                                                                             |
| <b>Command Mode</b>       | POLICY-MAP-CLASS-MAP                                                                                                                                                                                                                                                                                                                                                                       |
| <b>Usage Information</b>  | This command supports only <i>qos</i> ingress policy type. Packets marked as <i>color yellow</i> deliver to the egress queue, then the egress queue transmits the packets with the available bandwidth. If bandwidth is not available, the packets drop. All packets marked as <i>color red</i> drop. When class-map type is <i>qos</i> , the qos-group corresponds to data queues 0 to 7. |
| <b>Example</b>            | <pre>OS10(conf-pmap-c-qos)# set dscp 10</pre>                                                                                                                                                                                                                                                                                                                                              |
| <b>Supported Releases</b> | 10.2.0E or later                                                                                                                                                                                                                                                                                                                                                                           |

## set qos-group

Configures marking for the QoS-group queues.

|                           |                                                                                                                                                                                                                                                                                    |
|---------------------------|------------------------------------------------------------------------------------------------------------------------------------------------------------------------------------------------------------------------------------------------------------------------------------|
| <b>Syntax</b>             | <code>set qos-group <i>queue-number</i></code>                                                                                                                                                                                                                                     |
| <b>Parameters</b>         | <i>queue-number</i> — Enter a queue number, from 0 to 7.                                                                                                                                                                                                                           |
| <b>Default</b>            | Not configured                                                                                                                                                                                                                                                                     |
| <b>Command Mode</b>       | POLICY-MAP-CLASS-MAP                                                                                                                                                                                                                                                               |
| <b>Usage Information</b>  | This command supports only the <i>qos</i> or <i>control-plane</i> ingress policy type. When the class-map type is <i>control-plane</i> , the qos-group corresponds to CPU queues 0 to 11. When the class-map type is <i>qos</i> , the qos-group corresponds to data queues 0 to 7. |
| <b>Example</b>            | <pre>OS10(conf-pmap-c-qos)# set qos-group 7</pre>                                                                                                                                                                                                                                  |
| <b>Supported Releases</b> | 10.2.0E or later                                                                                                                                                                                                                                                                   |



## shape

Shapes the outgoing traffic rate.

|                           |                                                                                                                                                                                                                                                                                                                                                                                                                                                                                                                                                                                                                                                                                                                                                                                     |
|---------------------------|-------------------------------------------------------------------------------------------------------------------------------------------------------------------------------------------------------------------------------------------------------------------------------------------------------------------------------------------------------------------------------------------------------------------------------------------------------------------------------------------------------------------------------------------------------------------------------------------------------------------------------------------------------------------------------------------------------------------------------------------------------------------------------------|
| <b>Syntax</b>             | <code>shape {min {kbps   mbps   pps} min-value [burst-size]} {max {kbps   mbps   pps} max-value [max-burst-size]}</code>                                                                                                                                                                                                                                                                                                                                                                                                                                                                                                                                                                                                                                                            |
| <b>Parameters</b>         | <ul style="list-style-type: none"><li>• <code>min</code> — Enter the minimum committed rate in unit in kbps, mbps, or pps.</li><li>• <code>kbps</code> — Enter the committed rate unit in kilobits per second, from 0 to 40000000.</li><li>• <code>mbps</code> — Enter the committed rate unit in megabits per second, from 0 to 40000.</li><li>• <code>pps</code> — Enter the committed rate unit in packets per second, from 1 to 268000000.</li><li>• <code>burst-size</code> — Enter the burst size in kilobites per packet, from 0 to 10000 or 1 to 1073000.</li><li>• <code>max</code> — Enter the maximum peak rate in kbps, mbps, or pps.</li><li>• <code>max-burst-size</code> — Enter the burst size in kilobites per packets, from 0 to 10000 or 1 to 1073000.</li></ul> |
| <b>Default</b>            | Maximum burst size is 50 kb or 200 packets                                                                                                                                                                                                                                                                                                                                                                                                                                                                                                                                                                                                                                                                                                                                          |
| <b>Command Mode</b>       | POLICY-MAP-CLASS-MAP                                                                                                                                                                                                                                                                                                                                                                                                                                                                                                                                                                                                                                                                                                                                                                |
| <b>Usage Information</b>  | This command only supports the ingress QoS policy type. You must enter both the minimum and maximum values. If you enter the rate value in pps, the burst provided is in packets. If you enter the rate in kbps or mbps, the burst is provided in kb. If you enter the minimum rate in pps, you must also enter the maximum rate in pps.                                                                                                                                                                                                                                                                                                                                                                                                                                            |
| <b>Example</b>            | <pre>OS10(conf-pmap-c-que)# shape min kbps 11 max kbps 44</pre>                                                                                                                                                                                                                                                                                                                                                                                                                                                                                                                                                                                                                                                                                                                     |
| <b>Supported Releases</b> | 10.2.0E or later                                                                                                                                                                                                                                                                                                                                                                                                                                                                                                                                                                                                                                                                                                                                                                    |

## show class-map

Displays configuration details of all existing class-maps.

|                           |                                                                                                                                                                                                                                                                                                                                                                                                                                                                                                                                                                                                                               |
|---------------------------|-------------------------------------------------------------------------------------------------------------------------------------------------------------------------------------------------------------------------------------------------------------------------------------------------------------------------------------------------------------------------------------------------------------------------------------------------------------------------------------------------------------------------------------------------------------------------------------------------------------------------------|
| <b>Syntax</b>             | <code>show class-map [type {control-plane   qos   queuing   network-qos} class-map-name]</code>                                                                                                                                                                                                                                                                                                                                                                                                                                                                                                                               |
| <b>Parameters</b>         | <ul style="list-style-type: none"><li>• <code>type</code> — Enter the policy-map type — <code>qos</code>, <code>queuing</code>, or <code>control-plane</code>.</li><li>• <code>qos</code> — Displays all policy-maps of <code>qos</code> type.</li><li>• <code>queuing</code> — Displays all policy-maps of <code>queuing</code> type.</li><li>• <code>network-qos</code> — Displays all policy-maps of <code>network-qos</code> type.</li><li>• <code>control-plane</code> — Displays all policy-maps of <code>control-plane</code> type.</li><li>• <code>class-map-name</code> — Displays the QoS class-map name.</li></ul> |
| <b>Default</b>            | Not configured                                                                                                                                                                                                                                                                                                                                                                                                                                                                                                                                                                                                                |
| <b>Command Mode</b>       | EXEC                                                                                                                                                                                                                                                                                                                                                                                                                                                                                                                                                                                                                          |
| <b>Usage Information</b>  | This command displays all class-maps of <code>qos</code> , <code>queuing</code> , <code>network-qos</code> , or <code>control-plane</code> type. The <code>class-map-name</code> parameter displays all details of a configured class-map name.                                                                                                                                                                                                                                                                                                                                                                               |
| <b>Example</b>            | <pre>OS10# show class-map type qos c1 Class-map (qos): c1 (match-all) Match(not): ip-any dscp 10</pre>                                                                                                                                                                                                                                                                                                                                                                                                                                                                                                                        |
| <b>Supported Releases</b> | 10.2.0E or later                                                                                                                                                                                                                                                                                                                                                                                                                                                                                                                                                                                                              |

## show control-plane buffers

Displays the pool type, reserved buffer size, and the maximum threshold value for each of the CPU queues.

**Syntax** `show control-plane buffers`

**Parameters** None

**Default** None

**Command Mode** EXEC

**Usage Information** None

### Example

```
OS10# show control-plane buffers
queue-number pool-type rsvd-buf-size threshold-mode threshold-value

0 lossy 1664 static
20800
1 lossy 1664 static
20800
2 lossy 1664 static
48880
3 lossy 9216 static
48880
4 lossy 1664 static
20800
5 lossy 1664 static
48880
6 lossy 1664 static
48880
7 lossy 1664 static
48880
8 lossy 1664 static
48880
9 lossy 9216 static
48880
10 lossy 1664 static
48880
11 lossy 1664 static
48880
12 lossy 1664 static
48880
13 lossy 9216 static
48880
14 lossy 1664 static
48880
15 lossy 9216 static
48880
16 lossy 1664 static
48880
17 lossy 1664 static
48880
18 lossy 1664 static
48880
19 lossy 1664 static
48880
20 lossy 1664 static
20800
21 lossy 1664 static
20800
22 lossy 1664 static
20800
```

**Supported Releases** 10.4.2 and later

## show control-plane buffer-stats

Displays the control plane buffer statistics for each of the CPU queues.

**Syntax** `show control-plane buffer-stats`

**Parameters** None

**Default** A predefined default profile exists.

**Command Mode** EXEC

**Usage Information** None

### Example

```
OS10# show control-plane buffer-stats
Queue TX TX Used reserved Used
shared pckts bytes buffers

0 0 0 0
0
1 0 0 0
0
2 0 0 0
0
3 0 0 0
0
4 0 0 0
0
5 0 0 0
0
6 3 204 0
0
7 6 408 0
0
8 0 0 0
0
9 0 0 0
0
10 0 0 0
0
11 0 0 0
0
12 0 0 0
0
13 0 0 0
0
14 0 0 0
0
15 0 0 0
0
16 0 0 0
0
17 0 0 0
0
18 0 0 0
0
19 0 0 0
0
20 0 0 0
0
21 0 0 0
0
22 0 0 0
0
```

**Supported Releases** 10.4.2 and later

## show control-plane info

Displays control-plane queue mapping and rate limits.

|                          |                                                                                                                                                                 |
|--------------------------|-----------------------------------------------------------------------------------------------------------------------------------------------------------------|
| <b>Syntax</b>            | <code>show control-plane info [default]</code>                                                                                                                  |
| <b>Parameters</b>        | <code>default</code> —Enter the keyword <code>default</code> to view the default protocol-to-queue mapping and default rate limits for the particular platform. |
| <b>Default</b>           | Not configured                                                                                                                                                  |
| <b>Command Mode</b>      | EXEC                                                                                                                                                            |
| <b>Usage Information</b> | Monitors statistics for the control-plane and to troubleshoot CoPP.                                                                                             |

### Example

```
OS10# show control-plane info
Queue Min Rate Limit(in pps) Max Rate Limit(in pps) Protocols
0 600 600 ISCSIUNKNOWN
UNICAST
1 1000 1000 SFLOW
2 400 400 IGMP MLD PIM
3 600 1000 VLT NDS
4 500 1000 IPV6_ICMP
IPV4_ICMP
5 500 1000 ICMPV6_RS
ICMPV6_NS ICMPV6_RA ICMPV6_NA
6 500 1000 ARP_REQ
SERVICEABILITY
7 500 1000 ARP_RESP
8 500 500 SSH TELNET
TACACS NTP FTP
9 600 600 FCOE
10 600 1000 LACP
11 400 400 RSTP PVST MSTP
12 500 500 DOT1X LLDP FEFD
13 600 1000 IPV6_OSPF
IPV4_OSPF
14 600 1000 OSPF_HELLO
15 600 1000 BGP
16 500 500 IPV6_DHCP
IPV4_DHCP
17 600 1000 VRRP
18 700 700 BFD
19 700 1000 OPEN_FLOW
REMOTE CPS
20 300 300 MCAST DATA
21 100 100 ACL LOGGING
22 300 300 MCAST KNOWN
DATA
23 300 6400 PTP
24 100 100 PORT_SECURITY
```

|                           |                  |
|---------------------------|------------------|
| <b>Supported Releases</b> | 10.2.0E or later |
|---------------------------|------------------|

## show control-plane statistics

Displays counters of all the CPU queue statistics.

|                     |                                            |
|---------------------|--------------------------------------------|
| <b>Syntax</b>       | <code>show control-plane statistics</code> |
| <b>Parameters</b>   | None                                       |
| <b>Default</b>      | Not configured                             |
| <b>Command Mode</b> | EXEC                                       |

**Usage Information**

None

**Example**

```
OS10# show control-plane statistics
Queue Packets Bytes Dropped Packets Dropped Bytes
0 0 0 0 0
1 0 0 0 0
2 0 0 0 0
3 0 0 0 0
4 0 0 0 0
5 0 0 0 0
6 3 204 0 0
7 6 408 0 0
8 0 0 0 0
9 0 0 0 0
10 0 0 0 0
11 0 0 0 0
12 0 0 0 0
13 0 0 0 0
14 0 0 0 0
15 0 0 0 0
16 0 0 0 0
17 0 0 0 0
18 0 0 0 0
19 0 0 0 0
20 0 0 0 0
21 0 0 0 0
22 0 0 0 0
OS10#
```

**Supported Releases**

10.2.0E or later

## show hardware deep-buffer-mode

Displays the status of Deep buffer mode in the current and next boot of the switch.

**Syntax** `show hardware deep-buffer-mode`

**Parameters** None

**Defaults** Not configured

**Command Modes** EXEC

**Usage Information** Applicable only for the S4200-ON series switches.

**Example** Example: default setting

```
OS10# show hardware deep-buffer-mode
Deep Buffer Mode Configuration Status

Current-boot Settings : Disabled
Next-boot Settings : Disabled
```

Example: saved to startup configuration

```
OS10# show hardware deep-buffer-mode
Deep Buffer Mode Configuration Status

Current-boot Settings : Disabled
Next-boot Settings : Enabled
```

Example: switch reloaded

```
OS10# show hardware deep-buffer-mode
Deep Buffer Mode Configuration Status

Current-boot Settings : Enabled

Next-boot Settings : Enabled
```

**Supported Releases** 10.4.3.0 or later

## show interface priority-flow-control

Displays the priority flow-control, operational status, CoS bitmap, and statistics per port.

**Syntax** `show interface ethernet node/slot/port[:subport] priority-flow-control [details]`

**Parameters** `details` — (Optional) Displays all priority flow control information for an interface.

**Default** Not configured

**Command Mode** EXEC

**Usage Information** None

### Example (Details)

```
OS10# show interface ethernet 1/1/14 priority-flow-control details

ethernet1/1/14
Admin Mode: On
Operstatus: On
PFC Priorities: 0,4,7
Total Rx PFC Frames: 300
Total Tx PFC Frames: 200
Cos Rx Tx

0 0 0
1 0 0
2 0 0
3 300 200
4 0 0
5 0 0
6 0 0
7 0 0
```

**Supported Releases** 10.3.0E or later

## show qos interface

Displays the QoS configuration applied to a specific interface.

**Syntax** `show qos interface ethernet node/slot/port[:subport]`

**Parameters** `node/slot/port[:subport]` — Enter the Ethernet interface information.

**Default** Not configured

**Command Mode** EXEC

**Usage Information** None

## Example

```
OS10# show qos interface ethernet 1/1/10
Ethernet 1/1/10
 unknown-unicast-storm-control : 100 pps
 multicast-storm-control : 200 pps
 broadcast-storm-control : Disabled
 flow-control-rx: Enabled
 flow-control-tx: Disabled
 Service-policy (Input)(qos): p1
```

**Supported Releases** 10.2.0E or later

## show policy-map

Displays information on all existing policy-maps.

**Syntax** `show policy-map type {control-plane | qos | queuing | network-qos} [policy-map-name]`

- Parameters**
- `type` — Enter the policy-map type — qos, queuing, or control-plane.
  - `qos` — Displays all policy-maps of qos type.
  - `queuing` — Displays all policy-maps configured of queuing type.
  - `network-qos` — Displays all policy-maps configured of network-qos type.
  - `control-plane` — Displays all policy-maps of control-plane type.
  - `policy-map-name` — Displays the QoS policy-map name details.

**Default** Not configured

**Command Mode** EXEC

**Usage Information** None

## Example

```
OS10# show policy-map
Service-policy(qos) input: p1
 Class-map (qos): c1
 set qos-group 1
Service-policy(qos) input: p2
 Class-map (qos): c2
 set qos-group 2
```

**Supported Releases** 10.2.0E or later

## show qos control-plane

Displays the QoS configuration applied to the control-plane.

**Syntax** `show qos control-plane`

**Parameters** None

**Default** Not configured

**Command Mode** EXEC

**Usage Information** Monitors statistics for the control-plane and troubleshoots CoPP.

## Example

```
OS10# show qos control-plane
Service-policy (Input): p1
```

**Supported Releases** 10.2.0E or later

## show qos egress buffers interface

Displays egress buffer configurations.

**Syntax** `show qos egress buffers interface [interface node/slot/port[:subport]]`

- Parameters**
- `interface` — (Optional) Enter the interface type.
  - `node/slot/port[:subport]` — (Optional) Enter the port information.

**Default** Not configured

**Command Mode** EXEC

**Usage Information** None

**Example**

```
OS10# show qos egress buffers interface ethernet 1/1/1
Interface : ethernet1/1/1
Speed : 0
queue-number pool-type rsvd-buf-size threshold-mode threshold-value

0 lossy 1664 dynamic 8
1 lossy 1664 dynamic 8
2 lossy 1664 dynamic 8
3 lossless 0 static 12479488
4 lossy 1664 dynamic 8
5 lossy 1664 dynamic 8
6 lossy 1664 dynamic 8
7 lossy 1664 dynamic 8
```

**Supported Releases** 10.3.0E or later

## show qos egress buffer-statistics-tracking

Displays egress queue-level peak buffer usage count in bytes for queues on a given interface.

**Syntax** `show qos egress buffer-statistics-tracking interface ethernet [node/slot/port] [[mcast | ucast] queue {all | [0-7]}] [detail]`

- Parameters**
- `node/slot/port`—Enter the port information.
  - `[[mcast | ucast] queue {all | [0-7]}]`—Enter the `mcast` or `ucast` keyword to view the egress queue peak buffer utilization for multicast or unicast queues respectively. Enter the `all` keyword to specify all queues, or enter the queue number.
  - `detail`—Displays per MMU instance-level statistics in platforms with multiple MMU instances such as the Z9100-ON series, Z9200-ON series, and MX9116n.

**Default** Not applicable

**Command Mode** EXEC

**Usage Information** None

**Example**

```
OS10# show qos egress buffer-statistics-tracking interface ethernet 1/1/1
Interface : ethernet1/1/1
Speed : 0
QType Queue Total buffers
 peak count

Unicast 0 0
Unicast 1 0
Unicast 2 0
Unicast 3 0
```



```

Unicast 4 0
Unicast 5 0
Unicast 6 0
Unicast 7 0
Multicast 0 0
Multicast 1 0
Multicast 2 0
Multicast 3 0
Multicast 4 0
Multicast 5 0
Multicast 6 0
Multicast 7 0

```

**Supported Releases** 10.4.3.0 or later

## show qos egress buffer-stats interface

Displays the buffers statistics for the egress interface.

**Syntax** `show qos egress buffer-stats interface [interface node/slot/port[:subport]] [detail]`

**Parameters**

- *interface* — (Optional) Enter the interface type.
- *node/slot/port[:subport]* — (Optional) Enter the port information.
- *detail* — Displays per MMU egress buffer statistics in platforms with multiple MMU instances such as Z9100-ON, Z9264F-ON, and MX9116n.

**Default** Not configured

**Command Mode** EXEC

**Usage Information** None

### Example

```

OS10# show qos egress buffer-stats interface ethernet 1/1/1
Interface : ethernet1/1/1
Speed : 0
Queue TX TX Used reserved Used shared
 pckts bytes buffers

0 0 0 0 0
1 0 0 0 0
2 0 0 0 0
3 0 0 0 0
4 0 0 0 0
5 0 0 0 0
6 0 0 0 0
7 0 0 0 0
OS10#

```

**Supported Releases** 10.3.0E or later

## show qos headroom-pool buffer-statistics-tracking

Displays headroom-pool level peak buffer usage count in bytes.

**Syntax** `show qos headroom-pool buffer-statistics-tracking [detail]`

**Parameters** *detail*—Displays headroom-pool statistics per memory management unit (MMU) instance in platforms with multiple MMU instances such as the Z9100-ON, Z9264F-ON, and MX9116n.

**Default** Not configured

**Command Mode** EXEC

**Usage Information** Supported platforms include Z9100-ON series, Z9200-ON series, S5200-ON series, and MX9116n.

**Example**

```
OS10# show qos headroom-pool buffer-statistics-tracking
Headroom Pool Buffers-Usage

0 0
1 0
2 0
3 0
```

**Supported Releases** 10.4.3.0 or later

## show qos ingress buffers interface

Displays interface buffer configurations.

**Syntax** `show qos ingress buffers interface [interface node/slot/port[:subport]]`

**Parameters**

- *interface* — (Optional) Enter the interface type.
- *node/slot/port[:subport]* — (Optional) Enter the port information.

**Default** Not configured

**Command Mode** EXEC

**Usage Information** None

**Example**

```
OS10(config)# show qos ingress buffer interface ethernet 1/1/1
Interface ethernet 1/1/1
Speed 40G

PG# PRIORITIES qos group Reserved Shared buffer ALLOTTED (Kb)
shared buffer id buffers MODE XOFF XON
threshold threshold

0 4 4 35 DYNAMIC 9
9 8
1 3 3 35 DYNAMIC 9
9 8
2 - - 0 STATIC 0
0 0
3 - - 0 STATIC 0
0 0
4 - - 0 STATIC 0
0 0
5 - - 0 STATIC 0
0 0
6 - - 0 STATIC 0
0 0
7 - 0-2,5-7 8 STATIC 0
0 0
```

**Supported Releases** 10.3.0E or later

## show qos ingress buffer-statistics-tracking

Displays ingress priority group level peak buffer usage count in bytes for the given priority group on a given interface.

|                          |                                                                                                                                                                                                                                                                                                                                                                                                                        |
|--------------------------|------------------------------------------------------------------------------------------------------------------------------------------------------------------------------------------------------------------------------------------------------------------------------------------------------------------------------------------------------------------------------------------------------------------------|
| <b>Syntax</b>            | <code>show qos ingress buffer-statistics-tracking interface ethernet [node/slot/port] [priority-group {0-7}] [detail]</code>                                                                                                                                                                                                                                                                                           |
| <b>Parameters</b>        | <ul style="list-style-type: none"><li>• <code>node/slot/port</code>—Enter the port information.</li><li>• <code>[priority-group {0-7}]</code>—Enter the <code>priority-group</code> keyword, followed by the group number.</li><li>• <code>detail</code>—Displays per MMU instance-level statistics in platforms with multiple MMU instances such as the Z9100-ON series, Z9200-ON series, and MX9116n.</li></ul>      |
| <b>Default</b>           | Not applicable                                                                                                                                                                                                                                                                                                                                                                                                         |
| <b>Command Mode</b>      | EXEC                                                                                                                                                                                                                                                                                                                                                                                                                   |
| <b>Usage Information</b> | When BST is enabled, if you make any configuration changes that affect the priority group or priority mapping configuration, such as removal of class map, addition of class map to policy map (nqos), and so on, be sure to clear the buffer statistics using the <code>clear qos statistics type buffer-statistics-tracking</code> command to view the actual peak buffer utilization for the current configuration. |

### Example

```
OS10# show qos ingress buffer-statistics-tracking interface ethernet
1/1/1
Interface : ethernet1/1/1
Speed : 0
Priority Peak shared Peak HDRM
Group buffers buffers

0 0 0
1 0 0
2 0 0
3 0 0
4 0 0
5 0 0
6 0 0
7 0 0
```

**Supported Releases** 10.4.3.0 or later

## show qos ingress buffer-stats interface

Displays the buffers statistics for the ingress interface.

|                          |                                                                                                                                                                                                                                                                                                                                                                                                    |
|--------------------------|----------------------------------------------------------------------------------------------------------------------------------------------------------------------------------------------------------------------------------------------------------------------------------------------------------------------------------------------------------------------------------------------------|
| <b>Syntax</b>            | <code>show qos ingress buffer-stats interface [interface node/slot/port[:subport]] [detail]</code>                                                                                                                                                                                                                                                                                                 |
| <b>Parameters</b>        | <ul style="list-style-type: none"><li>• <code>interface</code> — (Optional) Enter the interface type.</li><li>• <code>node/slot/port[:subport]</code> — (Optional) Enter the port information.</li><li>• <code>detail</code> — (Optional) Displays per MMU instance level statistics in platforms with multiple MMU instances such as the Z9100-ON series, Z9200-ON series, and MX9116n.</li></ul> |
| <b>Default</b>           | Not configured                                                                                                                                                                                                                                                                                                                                                                                     |
| <b>Command Mode</b>      | EXEC                                                                                                                                                                                                                                                                                                                                                                                               |
| <b>Usage Information</b> | None                                                                                                                                                                                                                                                                                                                                                                                               |
| <b>Example</b>           | <pre>OS10(config)# show qos ingress buffer-stats interface ethernet 1/1/15 Interface : ethernet1/1/15 Speed : 10G Priority Used reserved   Used shared   Used HDRM</pre>                                                                                                                                                                                                                           |

| Group | buffers | buffers | buffers |
|-------|---------|---------|---------|
| 0     | 9360    | 681824  | 35984   |
| 1     | 0       | 0       | 0       |
| 2     | 0       | 0       | 0       |
| 3     | 0       | 0       | 0       |
| 4     | 0       | 0       | 0       |
| 5     | 0       | 0       | 0       |
| 6     | 0       | 0       | 0       |
| 7     | 0       | 0       | 0       |

**Supported Releases** 10.3.0E or later

## show qos maps

Displays the active system trust map.

**Syntax** `show qos maps type {tc-queue | trust-map-dot1p | trust-map dscp} trust-map-name`

- Parameters**
- `dot1p` — Enter to view the dot1p trust map.
  - `dscp` — Enter to view the DSCP trust map.
  - `tc-queue`—Enter to view the traffic class to queue map.
  - `trust-map` — Enter the name of the trust map.

**Default** Not configured

**Command Mode** EXEC

**Usage Information** None

### Example (dot1p)

```
OS10# show qos maps type tc-queue queue-map1
Traffic-Class to Queue Map: queue-map1
Queue Traffic-Class

1 5
2 6
3 7

OS10# show qos maps type trust-map-dot1p dot1p-trustmap1
DOT1P Priority to Traffic-Class Map : dot1p-trustmap1
Traffic-Class DOT1P Priority

0 2
1 3
2 4
3 5
4 6
5 7
6 1

OS10# show qos maps type trust-map-dscp dscp-trustmap1
DSCP Priority to Traffic-Class Map : dscp-trustmap1
Traffic-Class DSCP Priority

0 8-15
2 16-23
1 0-7

OS10# show qos maps
Traffic-Class to Queue Map: queue-map1
Queue Traffic-Class

1 5
2 6
3 7
DOT1P Priority to Traffic-Class Map : map1
Traffic-Class DOT1P Priority
```

```

DOT1P Priority to Traffic-Class Map : dot1p-trustmap1
Traffic-Class DOT1P Priority

0 2
1 3
2 4
3 5
4 6
5 7
6 1
DSCP Priority to Traffic-Class Map : dscp-trustmap1
Traffic-Class DSCP Priority

0 8-15
1 16-23
2 0-7
Default Dot1p Priority to Traffic-Class Map
Traffic-Class DOT1P Priority

0 1
1 0
2 2
3 3
4 4
5 5
6 6
7 7
Default Dscp Priority to Traffic-Class Map
Traffic-Class DSCP Priority

0 0-7
1 8-15
2 16-23
3 24-31
4 32-39
5 40-47
6 48-55
7 56-63
Default Traffic-Class to Queue Map
Traffic-Class Queue number

0 0
1 1
2 2
3 3
4 4
5 5
6 6
7 7
OS10#

```

### Example (dscp)

```

OS10# show qos trust-map dscp new-dscp-map

new-dscp-map
qos-group Dscp
 Id

0 0-7
1 8-15
2 16-23
3 24-31
4 32-39
5 40-47
6 48-55
7 56-63

```

### Supported Releases

10.3.0E or later

## show qos maps (Z9332F-ON)

Displays the QoS maps configuration of the dot1p-to-traffic class, DSCP-to-traffic class, and traffic-class to queue mapping in the device.

**Syntax** `show qos maps type tc-queue`

- Parameters**
- `qos` — Enter to view either an ingress or egress QoS configuration
  - `maps` — Enter to view QoS mapping information
  - `type`— (Optional)Enter to view Qos map types
  - `tc-queue` — Enter to view the traffic class-to-queue map

**Default** NA

**Command Mode** EXEC

**Usage Information** The command applies to the Z9332F-ON only. The command provides priority-to-traffic-class and traffic-class-to-queue mapping, both default and user configured. The `Type` column displays the queue type corresponding to the traffic-class-to-queue map entry. For platforms other than Z9332F-ON, the `Both` displays in the `Type` column to indicate that the mapping applies to both unicast and multicast queues.

### Example

```
show qos maps type tc-queue
Traffic-Class to Queue Map: sundar
Queue Traffic-Class Type

2 2-5 Unicast
0-2 0 Multicast
```

**Supported Releases** 10.5.0 or later

## show qos port-map details

Displays port to port pipe and MMU mapping.

**Syntax** `show qos port-map details [interface interface-type]`

**Parameters** `interface interface-type` — (Optional) Enter the keyword `interface` and the interface type.

**Default** Not configured

**Command Mode** EXEC

**Usage Information** On the Z9100-ON, Z9264F-ON, and MX9116n platforms, interfaces are shared across port pipes and port pipes are shared across Memory Management Units (MMUs). As interfaces span port pipes, Dell EMC Networking recommends using interfaces from same port pipes for both ingress and egress for optimal performance. To find the port to port-pipe and MMU mapping, use the `show qos port-map details` command.

**Example** Z9100-ON switch:

```
OS10# show qos port-map details

Interface Port Pipe Ingress MMU Egress MMU Oper Status

Eth 1/1/1 1 2, 3 0, 2 up
Eth 1/1/2 1 2, 3 0, 2 up
Eth 1/1/3 1 2, 3 0, 2 up
```

|            |   |      |      |      |
|------------|---|------|------|------|
| Eth 1/1/4  | 1 | 2, 3 | 0, 2 | up   |
| Eth 1/1/5  | 2 | 2, 3 | 1, 3 | up   |
| Eth 1/1/6  | 2 | 2, 3 | 1, 3 | up   |
| Eth 1/1/7  | 2 | 2, 3 | 1, 3 | up   |
| Eth 1/1/8  | 2 | 2, 3 | 1, 3 | up   |
| Eth 1/1/9  | 1 | 2, 3 | 0, 2 | up   |
| Eth 1/1/10 | 1 | 2, 3 | 0, 2 | up   |
| Eth 1/1/11 | 1 | 2, 3 | 0, 2 | up   |
| Eth 1/1/12 | 1 | 2, 3 | 0, 2 | up   |
| Eth 1/1/13 | 2 | 2, 3 | 1, 3 | down |
| Eth 1/1/14 | 2 | 2, 3 | 1, 3 | down |
| Eth 1/1/15 | 2 | 2, 3 | 1, 3 | down |
| Eth 1/1/16 | 2 | 2, 3 | 1, 3 | down |
| Eth 1/1/17 | 3 | 0, 1 | 1, 3 | down |
| Eth 1/1/18 | 3 | 0, 1 | 1, 3 | down |
| Eth 1/1/19 | 3 | 0, 1 | 1, 3 | down |
| Eth 1/1/20 | 3 | 0, 1 | 1, 3 | down |
| Eth 1/1/21 | 0 | 0, 1 | 0, 2 | down |
| Eth 1/1/22 | 0 | 0, 1 | 0, 2 | down |
| Eth 1/1/23 | 0 | 0, 1 | 0, 2 | down |
| Eth 1/1/24 | 0 | 0, 1 | 0, 2 | down |
| Eth 1/1/25 | 3 | 0, 1 | 1, 3 | up   |
| Eth 1/1/26 | 3 | 0, 1 | 1, 3 | down |
| Eth 1/1/27 | 3 | 0, 1 | 1, 3 | down |
| Eth 1/1/28 | 3 | 0, 1 | 1, 3 | down |
| Eth 1/1/29 | 0 | 0, 1 | 0, 2 | down |
| Eth 1/1/30 | 0 | 0, 1 | 0, 2 | down |
| Eth 1/1/31 | 0 | 0, 1 | 0, 2 | down |
| Eth 1/1/32 | 0 | 0, 1 | 0, 2 | down |
| Eth 1/1/33 | 1 | 2, 3 | 0, 2 | up   |
| Eth 1/1/34 | 2 | 2, 3 | 1, 3 | up   |

View information for a single interface:

```
OS10# show qos port-map details interface ethernet 1/1/1
```

```

```

| Interface | Port Pipe | Ingress MMU | Egress MMU | Oper Status |
|-----------|-----------|-------------|------------|-------------|
|-----------|-----------|-------------|------------|-------------|

```

```

|           |   |      |      |    |
|-----------|---|------|------|----|
| Eth 1/1/1 | 1 | 2, 3 | 0, 2 | up |
|-----------|---|------|------|----|

Z9264F-ON switch:

OS10# show qos port-map details

| Interface    | Port Pipe | Ingress MMU | Egress MMU | Oper Status |
|--------------|-----------|-------------|------------|-------------|
| Eth 1/1/1:1  | 0         | 0, 1        | 0, 2       | up          |
| Eth 1/1/3:1  | 1         | 2, 3        | 0, 2       | up          |
| Eth 1/1/3:2  | 1         | 2, 3        | 0, 2       | up          |
| Eth 1/1/3:3  | 1         | 2, 3        | 0, 2       | up          |
| Eth 1/1/3:4  | 1         | 2, 3        | 0, 2       | up          |
| Eth 1/1/5:1  | 1         | 2, 3        | 0, 2       | down        |
| Eth 1/1/5:2  | 1         | 2, 3        | 0, 2       | down        |
| Eth 1/1/5:3  | 1         | 2, 3        | 0, 2       | down        |
| Eth 1/1/5:4  | 1         | 2, 3        | 0, 2       | down        |
| Eth 1/1/7:1  | 1         | 2, 3        | 0, 2       | down        |
| Eth 1/1/7:2  | 1         | 2, 3        | 0, 2       | down        |
| Eth 1/1/7:3  | 1         | 2, 3        | 0, 2       | down        |
| Eth 1/1/7:4  | 1         | 2, 3        | 0, 2       | down        |
| Eth 1/1/9:1  | 0         | 0, 1        | 0, 2       | down        |
| Eth 1/1/9:2  | 0         | 0, 1        | 0, 2       | down        |
| Eth 1/1/9:3  | 0         | 0, 1        | 0, 2       | down        |
| Eth 1/1/9:4  | 0         | 0, 1        | 0, 2       | down        |
| Eth 1/1/11:1 | 0         | 0, 1        | 0, 2       | up          |
| Eth 1/1/11:2 | 0         | 0, 1        | 0, 2       | up          |
| Eth 1/1/11:3 | 0         | 0, 1        | 0, 2       | up          |
| Eth 1/1/11:4 | 0         | 0, 1        | 0, 2       | up          |
| Eth 1/1/13:1 | 0         | 0, 1        | 0, 2       | up          |
| Eth 1/1/13:2 | 0         | 0, 1        | 0, 2       | up          |
| Eth 1/1/13:3 | 0         | 0, 1        | 0, 2       | up          |
| Eth 1/1/13:4 | 0         | 0, 1        | 0, 2       | up          |
| Eth 1/1/15   | 1         | 2, 3        | 0, 2       | down        |
| Eth 1/1/16   | 1         | 2, 3        | 0, 2       | down        |
| Eth 1/1/17:1 | 2         | 2, 3        | 1, 3       | up          |
| Eth 1/1/19:1 | 3         | 0, 1        | 1, 3       | down        |
| Eth 1/1/19:2 | 3         | 0, 1        | 1, 3       | down        |
| Eth 1/1/19:3 | 3         | 0, 1        | 1, 3       | down        |
| Eth 1/1/19:4 | 3         | 0, 1        | 1, 3       | down        |
| Eth 1/1/21:1 | 3         | 0, 1        | 1, 3       | down        |
| Eth 1/1/21:2 | 3         | 0, 1        | 1, 3       | down        |
| Eth 1/1/21:3 | 3         | 0, 1        | 1, 3       | down        |
| Eth 1/1/21:4 | 3         | 0, 1        | 1, 3       | down        |
| Eth 1/1/23   | 3         | 0, 1        | 1, 3       | down        |
| Eth 1/1/24   | 3         | 0, 1        | 1, 3       | down        |
| Eth 1/1/25:1 | 2         | 2, 3        | 1, 3       | down        |
| Eth 1/1/25:2 | 2         | 2, 3        | 1, 3       | down        |
| Eth 1/1/25:3 | 2         | 2, 3        | 1, 3       | down        |
| Eth 1/1/25:4 | 2         | 2, 3        | 1, 3       | down        |
| Eth 1/1/27:1 | 2         | 2, 3        | 1, 3       | down        |
| Eth 1/1/27:2 | 2         | 2, 3        | 1, 3       | down        |
| Eth 1/1/27:3 | 2         | 2, 3        | 1, 3       | down        |
| Eth 1/1/27:4 | 2         | 2, 3        | 1, 3       | down        |
| Eth 1/1/29:1 | 2         | 2, 3        | 1, 3       | down        |
| Eth 1/1/29:2 | 2         | 2, 3        | 1, 3       | down        |
| Eth 1/1/29:3 | 2         | 2, 3        | 1, 3       | down        |
| Eth 1/1/29:4 | 2         | 2, 3        | 1, 3       | down        |
| Eth 1/1/31   | 3         | 0, 1        | 1, 3       | down        |
| Eth 1/1/32   | 3         | 0, 1        | 1, 3       | down        |
| Eth 1/1/33   | 0         | 0, 1        | 0, 2       | down        |
| Eth 1/1/34   | 0         | 0, 1        | 0, 2       | down        |
| Eth 1/1/35:1 | 1         | 2, 3        | 0, 2       | down        |
| Eth 1/1/35:2 | 1         | 2, 3        | 0, 2       | down        |
| Eth 1/1/35:3 | 1         | 2, 3        | 0, 2       | down        |
| Eth 1/1/35:4 | 1         | 2, 3        | 0, 2       | down        |
| Eth 1/1/37:1 | 1         | 2, 3        | 0, 2       | down        |
| Eth 1/1/37:2 | 1         | 2, 3        | 0, 2       | down        |
| Eth 1/1/37:3 | 1         | 2, 3        | 0, 2       | down        |



|              |   |      |      |      |
|--------------|---|------|------|------|
| Eth 1/1/37:4 | 1 | 2, 3 | 0, 2 | down |
| Eth 1/1/39:1 | 1 | 2, 3 | 0, 2 | down |
| Eth 1/1/39:2 | 1 | 2, 3 | 0, 2 | down |
| Eth 1/1/39:3 | 1 | 2, 3 | 0, 2 | down |
| Eth 1/1/39:4 | 1 | 2, 3 | 0, 2 | down |
| Eth 1/1/41:1 | 0 | 0, 1 | 0, 2 | up   |
| Eth 1/1/41:2 | 0 | 0, 1 | 0, 2 | up   |
| Eth 1/1/41:3 | 0 | 0, 1 | 0, 2 | up   |
| Eth 1/1/41:4 | 0 | 0, 1 | 0, 2 | up   |
| Eth 1/1/43   | 0 | 0, 1 | 0, 2 | down |
| Eth 1/1/44   | 0 | 0, 1 | 0, 2 | down |
| Eth 1/1/45   | 0 | 0, 1 | 0, 2 | down |
| Eth 1/1/46   | 0 | 0, 1 | 0, 2 | down |
| Eth 1/1/47   | 1 | 2, 3 | 0, 2 | down |
| Eth 1/1/48   | 1 | 2, 3 | 0, 2 | down |
| Eth 1/1/49   | 2 | 2, 3 | 1, 3 | down |
| Eth 1/1/50   | 2 | 2, 3 | 1, 3 | down |
| Eth 1/1/51:1 | 3 | 0, 1 | 1, 3 | down |
| Eth 1/1/51:2 | 3 | 0, 1 | 1, 3 | down |
| Eth 1/1/51:3 | 3 | 0, 1 | 1, 3 | down |
| Eth 1/1/51:4 | 3 | 0, 1 | 1, 3 | down |
| Eth 1/1/53   | 3 | 0, 1 | 1, 3 | down |
| Eth 1/1/54   | 3 | 0, 1 | 1, 3 | down |
| Eth 1/1/55   | 3 | 0, 1 | 1, 3 | down |
| Eth 1/1/56   | 3 | 0, 1 | 1, 3 | down |
| Eth 1/1/57:1 | 2 | 2, 3 | 1, 3 | down |
| Eth 1/1/57:2 | 2 | 2, 3 | 1, 3 | down |
| Eth 1/1/57:3 | 2 | 2, 3 | 1, 3 | down |
| Eth 1/1/57:4 | 2 | 2, 3 | 1, 3 | down |
| Eth 1/1/59   | 2 | 2, 3 | 1, 3 | down |
| Eth 1/1/60   | 2 | 2, 3 | 1, 3 | down |
| Eth 1/1/61   | 2 | 2, 3 | 1, 3 | down |
| Eth 1/1/62   | 2 | 2, 3 | 1, 3 | down |
| Eth 1/1/63   | 3 | 0, 1 | 1, 3 | down |
| Eth 1/1/64   | 3 | 0, 1 | 1, 3 | down |
| Eth 1/1/65   | 2 | 2, 3 | 1, 3 | down |
| Eth 1/1/66   | 1 | 2, 3 | 0, 2 | down |

View information for a single interface:

```
OS10# show qos port-map details interface ethernet 1/1/1
```

| Interface   | Port Pipe | Ingress MMU | Egress MMU | Oper Status |
|-------------|-----------|-------------|------------|-------------|
| Eth 1/1/1:1 | 0         | 0, 1        | 0, 2       | up          |

MX9116n fabric engine:

```
OS10# show qos port-map details
```

| Interface    | Port Pipe | Ingress MMU | Egress MMU | Oper Status |
|--------------|-----------|-------------|------------|-------------|
| Eth 1/1/1    | 3         | 0, 1        | 1, 3       | down        |
| Eth 1/1/2    | 3         | 0, 1        | 1, 3       | down        |
| Eth 1/1/3    | 3         | 0, 1        | 1, 3       | down        |
| Eth 1/1/4    | 3         | 0, 1        | 1, 3       | down        |
| Eth 1/1/5    | 3         | 0, 1        | 1, 3       | down        |
| Eth 1/1/6    | 3         | 0, 1        | 1, 3       | down        |
| Eth 1/1/7    | 3         | 0, 1        | 1, 3       | down        |
| Eth 1/1/8    | 3         | 0, 1        | 1, 3       | down        |
| Eth 1/1/9    | 1         | 2, 3        | 0, 2       | down        |
| Eth 1/1/10   | 1         | 2, 3        | 0, 2       | down        |
| Eth 1/1/11   | 1         | 2, 3        | 0, 2       | down        |
| Eth 1/1/12   | 1         | 2, 3        | 0, 2       | down        |
| Eth 1/1/13   | 1         | 2, 3        | 0, 2       | down        |
| Eth 1/1/14   | 1         | 2, 3        | 0, 2       | down        |
| Eth 1/1/15   | 1         | 2, 3        | 0, 2       | down        |
| Eth 1/1/16   | 1         | 2, 3        | 0, 2       | down        |
| Eth 1/1/17:1 | 3         | 0, 1        | 1, 3       | down        |

|              |   |      |      |      |
|--------------|---|------|------|------|
| Eth 1/1/17:2 | 3 | 0, 1 | 1, 3 | down |
| Eth 1/1/17:3 | 3 | 0, 1 | 1, 3 | down |
| Eth 1/1/17:4 | 3 | 0, 1 | 1, 3 | down |
| Eth 1/1/18:1 | 1 | 2, 3 | 0, 2 | down |
| Eth 1/1/18:2 | 1 | 2, 3 | 0, 2 | down |
| Eth 1/1/18:3 | 1 | 2, 3 | 0, 2 | down |
| Eth 1/1/18:4 | 1 | 2, 3 | 0, 2 | down |
| Eth 1/1/19:1 | 3 | 0, 1 | 1, 3 | down |
| Eth 1/1/19:2 | 3 | 0, 1 | 1, 3 | down |
| Eth 1/1/19:3 | 3 | 0, 1 | 1, 3 | down |
| Eth 1/1/19:4 | 3 | 0, 1 | 1, 3 | down |
| Eth 1/1/20:1 | 1 | 2, 3 | 0, 2 | down |
| Eth 1/1/20:2 | 1 | 2, 3 | 0, 2 | down |
| Eth 1/1/20:3 | 1 | 2, 3 | 0, 2 | down |
| Eth 1/1/20:4 | 1 | 2, 3 | 0, 2 | down |
| Eth 1/1/21:1 | 3 | 0, 1 | 1, 3 | down |
| Eth 1/1/21:2 | 3 | 0, 1 | 1, 3 | down |
| Eth 1/1/21:3 | 3 | 0, 1 | 1, 3 | down |
| Eth 1/1/21:4 | 3 | 0, 1 | 1, 3 | down |
| Eth 1/1/22:1 | 1 | 2, 3 | 0, 2 | down |
| Eth 1/1/22:2 | 1 | 2, 3 | 0, 2 | down |
| Eth 1/1/22:3 | 1 | 2, 3 | 0, 2 | down |
| Eth 1/1/22:4 | 1 | 2, 3 | 0, 2 | down |
| Eth 1/1/23:1 | 3 | 0, 1 | 1, 3 | down |
| Eth 1/1/23:2 | 3 | 0, 1 | 1, 3 | down |
| Eth 1/1/23:3 | 3 | 0, 1 | 1, 3 | down |
| Eth 1/1/23:4 | 3 | 0, 1 | 1, 3 | down |
| Eth 1/1/24:1 | 1 | 2, 3 | 0, 2 | down |
| Eth 1/1/24:2 | 1 | 2, 3 | 0, 2 | down |
| Eth 1/1/24:3 | 1 | 2, 3 | 0, 2 | down |
| Eth 1/1/24:4 | 1 | 2, 3 | 0, 2 | down |
| Eth 1/1/25:1 | 3 | 0, 1 | 1, 3 | down |
| Eth 1/1/25:2 | 3 | 0, 1 | 1, 3 | down |
| Eth 1/1/25:3 | 3 | 0, 1 | 1, 3 | down |
| Eth 1/1/25:4 | 3 | 0, 1 | 1, 3 | down |
| Eth 1/1/26:1 | 1 | 2, 3 | 0, 2 | down |
| Eth 1/1/26:2 | 1 | 2, 3 | 0, 2 | down |
| Eth 1/1/26:3 | 1 | 2, 3 | 0, 2 | down |
| Eth 1/1/26:4 | 1 | 2, 3 | 0, 2 | down |
| Eth 1/1/27:1 | 3 | 0, 1 | 1, 3 | down |
| Eth 1/1/27:2 | 3 | 0, 1 | 1, 3 | down |
| Eth 1/1/27:3 | 3 | 0, 1 | 1, 3 | down |
| Eth 1/1/27:4 | 3 | 0, 1 | 1, 3 | down |
| Eth 1/1/28:1 | 1 | 2, 3 | 0, 2 | down |
| Eth 1/1/28:2 | 1 | 2, 3 | 0, 2 | down |
| Eth 1/1/28:3 | 1 | 2, 3 | 0, 2 | down |
| Eth 1/1/28:4 | 1 | 2, 3 | 0, 2 | down |
| Eth 1/1/29:1 | 0 | 0, 1 | 0, 2 | down |
| Eth 1/1/29:2 | 0 | 0, 1 | 0, 2 | down |
| Eth 1/1/29:3 | 0 | 0, 1 | 0, 2 | down |
| Eth 1/1/29:4 | 0 | 0, 1 | 0, 2 | down |
| Eth 1/1/30:1 | 2 | 2, 3 | 1, 3 | down |
| Eth 1/1/30:2 | 2 | 2, 3 | 1, 3 | down |
| Eth 1/1/30:3 | 2 | 2, 3 | 1, 3 | down |
| Eth 1/1/30:4 | 2 | 2, 3 | 1, 3 | down |
| Eth 1/1/31:1 | 0 | 0, 1 | 0, 2 | down |
| Eth 1/1/31:2 | 0 | 0, 1 | 0, 2 | down |
| Eth 1/1/31:3 | 0 | 0, 1 | 0, 2 | down |
| Eth 1/1/31:4 | 0 | 0, 1 | 0, 2 | down |
| Eth 1/1/32:1 | 2 | 2, 3 | 1, 3 | down |
| Eth 1/1/32:2 | 2 | 2, 3 | 1, 3 | down |
| Eth 1/1/32:3 | 2 | 2, 3 | 1, 3 | down |
| Eth 1/1/32:4 | 2 | 2, 3 | 1, 3 | down |
| Eth 1/1/33:1 | 0 | 0, 1 | 0, 2 | down |
| Eth 1/1/33:2 | 0 | 0, 1 | 0, 2 | down |
| Eth 1/1/33:3 | 0 | 0, 1 | 0, 2 | down |
| Eth 1/1/33:4 | 0 | 0, 1 | 0, 2 | down |
| Eth 1/1/34:1 | 2 | 2, 3 | 1, 3 | down |
| Eth 1/1/34:2 | 2 | 2, 3 | 1, 3 | down |
| Eth 1/1/34:3 | 2 | 2, 3 | 1, 3 | down |
| Eth 1/1/34:4 | 2 | 2, 3 | 1, 3 | down |
| Eth 1/1/35   | 0 | 0, 1 | 0, 2 | down |

|              |   |      |      |      |
|--------------|---|------|------|------|
| Eth 1/1/36   | 2 | 2, 3 | 1, 3 | down |
| Eth 1/1/37   | 0 | 0, 1 | 0, 2 | down |
| Eth 1/1/38   | 2 | 2, 3 | 1, 3 | down |
| Eth 1/1/39   | 0 | 0, 1 | 0, 2 | down |
| Eth 1/1/40   | 2 | 2, 3 | 1, 3 | down |
| Eth 1/1/41:1 | 2 | 2, 3 | 1, 3 | up   |
| Eth 1/1/41:2 | 2 | 2, 3 | 1, 3 | up   |
| Eth 1/1/41:3 | 2 | 2, 3 | 1, 3 | up   |
| Eth 1/1/41:4 | 2 | 2, 3 | 1, 3 | up   |
| Eth 1/1/42:1 | 0 | 0, 1 | 0, 2 | up   |
| Eth 1/1/42:2 | 0 | 0, 1 | 0, 2 | up   |
| Eth 1/1/42:3 | 0 | 0, 1 | 0, 2 | up   |
| Eth 1/1/42:4 | 0 | 0, 1 | 0, 2 | up   |
| Eth 1/1/43:1 | 2 | 2, 3 | 1, 3 | down |
| Eth 1/1/43:2 | 2 | 2, 3 | 1, 3 | down |
| Eth 1/1/43:3 | 2 | 2, 3 | 1, 3 | down |
| Eth 1/1/43:4 | 2 | 2, 3 | 1, 3 | down |
| Eth 1/1/44:1 | 0 | 0, 1 | 0, 2 | up   |
| Eth 1/1/44:2 | 0 | 0, 1 | 0, 2 | up   |
| Eth 1/1/44:3 | 0 | 0, 1 | 0, 2 | up   |
| Eth 1/1/44:4 | 0 | 0, 1 | 0, 2 | up   |

View information for a single interface:

```
OS10# show qos port-map details interface ethernet 1/1/1
```

| Interface | Port Pipe | Ingress MMU | Egress MMU | Oper Status |
|-----------|-----------|-------------|------------|-------------|
| Eth 1/1/1 | 3         | 0, 1        | 1, 3       | down        |

**Supported Releases** 10.5.0 or later

## show qos-rate-adjust

Displays the status of the rate adjust limit for policing and shaping.

**Syntax** show qos-rate-adjust

**Parameters** None

**Default** Not configured

**Command Mode** EXEC

**Usage Information** Not applicable for the S4200-ON series switches.

### Example

```
OS10# show qos-rate-adjust
QoS Rate adjust configured for Policer and Shaper (in bytes) : 10
```

**Supported Releases** 10.4.3.0 or later

## show qos service-pool buffer-statistics-tracking

Displays service-pool level peak buffer usage count in bytes.

**Syntax** show qos service-pool buffer-statistics-tracking [detail]

**Parameters** detail—Displays service-pool level peak buffer utilization per memory management unit (MMU) instance in platforms with multiple MMU instances such as the Z9100-ON, Z9264F-ON, and MX9116n.

**Default** Not configured

**Command Mode** EXEC

**Usage Information** None

**Example**

```
OS10# show qos service-pool buffer-statistics-tracking
Service Pool Ingress Buffers Egress Buffers

0 0 0
1 0 0
2 0 0
3 0 0
```

**Supported Releases** 10.4.3.0 or later

## show qos system

Displays the QoS configuration applied to the system.

**Syntax** show qos system

**Parameters** None

**Default** Not configured

**Command Mode** EXEC

**Usage Information** View and verify system-level service-policy configuration information.

**Example**

```
show qos system
ETS Mode : off
ECN Mode : off
buffer-statistics-tracking : off
```

**Supported Releases** 10.4.1.0 or later

## show qos system buffers

Displays the system buffer configurations and utilization.

**Syntax** show qos system {ingress | egress} buffers [detail]

**Parameters** detail — Displays system buffers per MMU level in platforms that support multiple MMU instances such as the Z9100-ON, Z9264F-ON, and MX9116n.

**Default** Not configured

**Command Mode** EXEC

**Usage Information** None

**Example**

```
OS10# show qos system ingress buffer
All values are in kb
Total buffers - 12187
 Total lossless buffers - 0
 Maximum lossless buffers - 5512
 Total shared lossless buffers - 0
 Total used shared lossless buffers -
 Total lossy buffers - 11567
 Total shared lossy buffers - 11192
 Total used shared lossy buffers - 0
```

The following command is supported on platforms such as the Z9100-ON, Z9264F-ON, and MX9116n:

```
OS10# show qos system ingress buffer detail
All values are in kb
Total buffers - 43008
 Total lossless buffers - 0
 Maximum lossless buffers - 23312
 Total shared lossless buffers - 0
 Total used shared lossless buffers -
 Total lossy buffers - 42388
 Total shared lossy buffers - 39974
 Total used shared lossy buffers - 0
 MMU 0
 Total lossy buffers - 10597
 Total shared lossy buffers - 10012
 Total used shared lossy buffers - 0
 MMU 1
 Total lossy buffers - 10597
 Total shared lossy buffers - 10012
 Total used shared lossy buffers - 0
 MMU 2
 Total lossy buffers - 10597
 Total shared lossy buffers - 9993
 Total used shared lossy buffers - 0
 MMU 3
 Total lossy buffers - 10597
 Total shared lossy buffers - 9993
 Total used shared lossy buffers - 0
```

```
OS10# show qos system egress buffer
All values are in kb
Total buffers - 12187
 Total lossless buffers - 0
 Total shared lossless buffers - 0
 Total used shared lossless buffers -
 Total lossy buffers - 11567
 Total shared lossy buffers - 9812
 Total used shared lossy buffers - 0
 Total CPU buffers - 620
 Total shared CPU buffers - 558
 Total used shared CPU buffers - 0
```

The following command is supported on platforms such as the Z9100-ON, Z9264F-ON, and MX9116n:

```
OS10# show qos system egress buffer detail
All values are in kb
Total buffers - 43008
 Total lossless buffers - 0
 Total shared lossless buffers - 0
 Total used shared lossless buffers -
 Total lossy buffers - 42388
 Total shared lossy buffers - 33938
 Total used shared lossy buffers - 0
 MMU 0
 Total lossy buffers - 10597
 Total shared lossy buffers - 8484
 Total used shared lossy buffers - 0
 MMU 1
 Total lossy buffers - 10597
 Total shared lossy buffers - 8484
 Total used shared lossy buffers - 0
 MMU 2
 Total lossy buffers - 10597
 Total shared lossy buffers - 8484
 Total used shared lossy buffers - 0
 MMU 3
 Total lossy buffers - 10597
 Total shared lossy buffers - 8484
 Total used shared lossy buffers - 0
```

**Supported Releases** 10.3.0E or later

## show qos wred-profile

Displays the details of WRED profile configuration.

**Syntax** `show qos wred-profile [wred-profile-name]`

**Parameters** `wred-profile-name` — (Optional) Enter the Ethernet interface information.

**Default** Not configured

**Command Mode** EXEC

**Usage Information** None

**Example**

```
OS10# show qos wred-profile
Profile Name | Green | Yellow | Red |
-----|-----|-----|-----|-----|-----|-----|-----|-----|-----|
| MIN MAX DROP-RATE | MIN MAX DROP-RATE | MIN MAX DROP-RATE | WEIGHT | ECN |
| KB KB % | KB KB % | KB KB % | | |
-----|-----|-----|-----|-----|-----|-----|-----|-----|
wred_prof | 100 1000 100 | 50 100 100 | 50 100 100 | | |
-----|-----|-----|-----|-----|-----|-----|-----|-----|
```

**Example (S4200)**  
— When ECN is enabled globally.

```
OS10#show qos wred-profile wred_prof1
Wred-profile-name gmin-thd gmax-thd gmax-drop-rate ymin-thd ymax-thd ymax-drop-rate rmin-thd rmax-thd
-----|-----|-----|-----|-----|-----|-----|-----|-----|-----|
wred_prof1 0 0 0 1 10 40 0 0 0
-----|-----|-----|-----|-----|-----|-----|-----|-----|-----|

S4200 o/p

OS10# show qos wred-profile
Profile Name | Green | Yellow | Red |
-----|-----|-----|-----|-----|-----|-----|-----|-----|-----|
| MIN MAX DROP-RATE | MIN MAX DROP-RATE | MIN MAX DROP-RATE | WEIGHT | ECN |
| KB KB % | KB KB % | KB KB % | | |
-----|-----|-----|-----|-----|-----|-----|-----|-----|-----|
profile1 | 10 100 100 | | | | | Off |
-----|-----|-----|-----|-----|-----|-----|-----|-----|-----|
profile2 | | | | | | On |
-----|-----|-----|-----|-----|-----|-----|-----|-----|-----|
Color Blind ECN Thd| 100 1000 100 | | | | | |
-----|-----|-----|-----|-----|-----|-----|-----|-----|-----|
```

**Supported Releases**

## show queuing statistics

Displays QoS queuing statistics information.

**Syntax** `show queuing statistics interface ethernet node/slot/port[:subport] [wred | queue number]`

**Parameters**

- `node/slot/port[:subport]` — Enter the Ethernet interface information.
- `queue number` — Enter the GoS queue number, from 0 to 7.

**Default** Not configured

**Command Mode** EXEC

**Usage Information** Use this command to view all queuing counters. WRED counters are available only at the port level.

### Example

```
OS10# show queuing statistics interface ethernet 1/1/1
Interface ethernet1/1/1
Queue Packets Bytes Dropped-
Packets Dropped-Bytes
0 0 0 0
0
1 0 0 0
0
2 0 0 0
0
3 0 0 0
0
4 0 0 0
0
5 0 0 0
0
6 0 0 0
0
7 0 0 0
0
```

### Example (wred)

```
OS10# show queuing statistics interface ethernet 1/1/1 wred
Interface ethernet1/1/1 (All queues)
Description Packets
Bytes
Output 0
Dropped 0
Green Drop 0
Yellow Drop 0
Red Drop 0
ECN marked count 0
```

### Example (queue)

```
OS10# show queuing statistics interface ethernet 1/1/1 queue 3
Interface ethernet1/1/1
Queue Packets Bytes Dropped-
Packets Dropped-Bytes
3 0 0
0
```

**Supported Releases** 10.2.0E or later

## system qos

Enters SYSTEM-QOS mode to configure system-level QoS configurations.

**Syntax** system qos

**Parameters** None

**Default** Not configured

**Command Mode** CONFIGURATION

**Usage Information** None

### Example

```
OS10(config)# system qos
OS10(config-sys-qos)#
```

**Supported Releases** 10.2.0E or later

## trust dot1p-map

Creates a user-defined trust map for dot1p flows.

**Syntax** `trust dot1p-map map-name`

**Parameters** *map-name* — Enter the name of the dot1p trust map. A maximum of 32 characters.

**Default** Not configured

**Command Mode** CONFIGURATION

**Usage Information** If you enable trust, traffic obeys the dot1p map. `default-dot1p-trust` is a reserved trust-map name. The `no` version of this command returns the value to the default.

**Example**

```
OS10(config)# trust dot1p-map map1
OS10(config-tmap-dot1p-map)# qos-group 4 dot1p 5
```

**Supported Releases** 10.3.0E or later

## trust dscp-map

Creates a user-defined trust map for DSCP flows.

**Syntax** `trust dscp-map map-name`

**Parameters** *map-name* — Enter the name of the DSCP trust map. A maximum of 32 characters.

**Default** Not configured

**Command Mode** CONFIGURATION

**Usage Information** If you enable trust, traffic obeys this trust map. `default-dscp-trust` is a reserved trust-map name. The `no` version of this command returns the value to the default.

**Example**

```
OS10(config)# trust dscp-map dscp-trust1
```

**Supported Releases** 10.3.0E or later

## trust-map

Configures trust map on an interface or on a system QoS.

**Syntax** `trust-map {dot1p | dscp} {default | trust-map-name}`

**Parameters**

- `dot1p` — Apply dot1p trust map.
- `dscp` — Apply dscp trust map.
- `default` — Apply default dot1p or dscp trust map.
- *trust-map-name* — Enter the name of trust map.

**Default** Disabled

**Command Mode** INTERFACE  
SYSTEM-QoS

**Usage Information** Use the `show qos maps type [tc-queue | trust-map-dot1p | trust-map-dscp] [trust-map-name]` command to view the current trust mapping. You must change the trust map only



during no traffic flow. Verify the correct policy maps are applied. The `no` version of this command returns the value to the default. The `no` version of this command removes the applied trust map from the interface or system QoS.

### Example

```
OS10(config)# interface ethernet 1/1/10
OS10(conf-if-eth1/1/10)# trust-map dot1p default
OS10(conf-if-eth1/1/10)# trust-map dot1p d1

OS10(config)# interface ethernet 1/1/2
OS10(conf-if-eth1/1/2)# trust-map dscp default
OS10(conf-if-eth1/1/2)# trust-map dscp d2
```

```
OS10(config)# system qos
OS10(config-sys-qos)# trust-map dot1p default
OS10(config-sys-qos)# trust-map dscp d2
```

### Supported Releases

10.4.1.0 or later

## wred

Configures a weighted random early detection (WRED) profile.

### Syntax

`wred wred-profile-name`

### Parameters

`wred-profile-name` — Enter a name for the WRED profile.

### Default

Not configured

### Command Mode

CONFIGURATION

### Usage Information

The `no` version of this command removes the WRED profile.

### Example

```
OS10(config)# wred test_wred
OS10(config-wred)#
```

### Supported Releases

10.4.0E(R1) or later

# Virtual Link Trunking

Virtual Link Trunking (VLT) is a Layer 2 aggregation protocol used between an end device such as a server and two or more connected network devices. VLT helps to aggregate ports terminating on multiple switches. OS10 currently supports VLT port channel terminations on two different switches.

VLT:

- Provides node-level redundancy by using the same port channel terminating on multiple upstream nodes.
- Provides a loop-free topology
- Eliminates STP-blocked ports
- Optimizes bandwidth utilization by using all available uplink bandwidth
- Guarantees fast convergence if either a link or device fails
- Enhances optimized forwarding with Virtual Router Redundancy Protocol (VRRP)
- Optimizes routing with VLT peer routing for Layer-3 VLANs
- Provides link-level resiliency
- Assures high availability

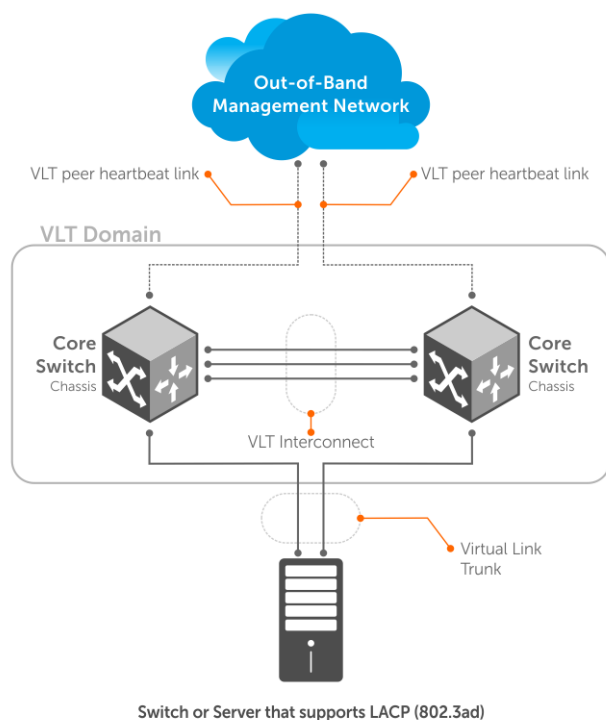

VLT presents a single logical L2 domain from the perspective of attached devices that have a virtual link trunk terminating on separate nodes in the VLT domain. The two VLT nodes are independent Layer2/ Layer3 (L2/L3) switches for devices in the upstream network. L2/L3 control plane protocols and system management features function normally in both the VLT nodes.

External switches or servers supporting LACP see the two VLT switches as a single virtual switch. Hence, VLT configurations must be identical on both the switches in the VLT domain.

|                                    |                                                                                                                                                 |
|------------------------------------|-------------------------------------------------------------------------------------------------------------------------------------------------|
| <b>VLT physical ports</b>          | 802.1p, 802.1q, LLDP, flow control, port monitoring, and jumbo frames are supported on VLT physical ports.                                      |
| <b>System management protocols</b> | All system management protocols are supported on VLT ports—SNMP, AAA, ACL, DNS, FTP, SSH, system log, NTP, RADIUS, SCP, and LLDP.               |
| <b>L3 VLAN connectivity</b>        | Enable L3 VLAN connectivity, VLANs assigned with an IP address, on VLT peers by configuring a VLAN interface for the same VLAN on both devices. |

|                                       |                                                                                                                                                                                                                                                                                                                                                                                             |
|---------------------------------------|---------------------------------------------------------------------------------------------------------------------------------------------------------------------------------------------------------------------------------------------------------------------------------------------------------------------------------------------------------------------------------------------|
| <b>Optimized forwarding with VRRP</b> | To ensure the same behavior on both sides of the VLT nodes, VRRP requires state information coordination. VRRP Active-Active mode optimizes L3 forwarding over VLT. By default, VRRP Active-Active mode is enabled on all the VLAN interfaces. VRRP Active-Active mode enables each peer to locally forward L3 packets, resulting in reduced traffic flow between peers over the VLTi link. |
| <b>Spanning-Tree Protocol</b>         | VLT ports support RSTP, RPVST+, and MSTP.                                                                                                                                                                                                                                                                                                                                                   |
| <b>Multicast</b>                      | IGMP snooping and MLD snooping are supported on VLT ports.                                                                                                                                                                                                                                                                                                                                  |

 **NOTE:** 802.1x and DHCP snooping are not supported on VLT ports.

## Terminology

|                                |                                                                                                                                                                                                                                                 |
|--------------------------------|-------------------------------------------------------------------------------------------------------------------------------------------------------------------------------------------------------------------------------------------------|
| <b>VLT domain</b>              | The domain includes VLT peer devices, VLT interconnects, and all port channels in the VLT connected to the attached devices. It is also the configuration mode that you must use to assign VLT global parameters.                               |
| <b>VLT interconnect (VLTi)</b> | The link between VLT peer switches used to synchronize operating states.                                                                                                                                                                        |
| <b>VLT peer device</b>         | A pair of devices connected using a dedicated port channel—the VLTi. You must configure VLT peers separately.                                                                                                                                   |
| <b>Discovery interface</b>     | Interfaces on VLT peers in the VLT interconnect (VLTi) link.                                                                                                                                                                                    |
| <b>VLT MAC address</b>         | Unique MAC address that you assign to the VLT domain. A VLT MAC address is a common address in both VLT peers. If you do not configure a VLT MAC address, the MAC address of the primary peer is used as the VLT MAC address across both peers. |
| <b>VLT node priority</b>       | The priority based on which the primary and secondary VLT nodes are determined. If priority is not configured, the VLT node with the lowest MAC address is elected as the primary VLT node.                                                     |
| <b>VLT port channel</b>        | A combined port channel between an attached device and VLT peer switches.                                                                                                                                                                       |
| <b>VLT port channel ID</b>     | Groups port channel interfaces on VLT peers into a single virtual-link trunk connected to an attached device. Assign the same port channel ID to port channel interfaces on both peers that you bundle together.                                |
| <b>Orphan ports</b>            | Ports that are not part of the VLT port channel but members of the spanned VLANs. The term spanned VLAN refers to a VLAN that is configured on both the VLT peers.                                                                              |

## VLT domain

A VLT domain includes the VLT peer devices, VLTi, and all VLT port channels that connect to the attached devices. It is also the configuration mode that you must use to assign VLT global parameters.

 **NOTE:** OS10 switches that belong to the same group and have the same port media type can be part of the same VLT domain. For example, you can have S5224F-ON and S5248F-ON as part of the same domain. However, switches that belong to the same group with different port media types cannot be part of the same VLT domain. For example, S4148F-ON and S4148T-ON cannot be part of the same domain.

- Each VLT domain must have a unique MAC address that you create or that VLT creates automatically.
- VLAN ID 4094 is reserved as an internal control VLAN for the VLT domain. IPv6 addressing is used on this control VLAN for VLT peer-to-peer communication.
- ARP, IPv6 neighbors, and MAC tables synchronize between the VLT peer nodes.
- VLT peer devices operate as separate nodes with independent control and data planes for devices that attach to non-VLT ports.
- One node in the VLT domain takes a primary role, and the other node takes the secondary role. In a VLT domain with two nodes, the VLT assigns the primary node role to the node with the lowest MAC address by default. You can override the default primary election mechanism by assigning priorities to each node using the `primary-priority` command.

- If the primary peer fails, the secondary peer takes the primary role. If the primary peer (with the lower priority) later comes back online, it is assigned the secondary role (there is no preemption).
- In a VLT domain, the peer network devices must run the same OS10 software version.
  - **NOTE:** A temporary exception is allowed during the upgrade process. See the *Dell EMC SmartFabric OS 10.5.0.x Release Notes* for more information.
- Configure the same VLT domain ID on peer devices. If a VLT domain ID mismatch occurs on VLT peers, the VLTi does not activate.
- In a VLT domain, VLT peers support connections to network devices that connect to only one peer.
- When you configure a VLT domain, the system generates a VLT Unit-ID. You cannot change the VLT Unit-ID. To identify the VLT node in a VLT domain, use the `show vlt` command.

## VLT interconnect

A VLT interconnect (VLTi) synchronizes states between VLT peers. OS10 automatically adds VLTi ports to VLANs spanned across VLT peers, but does not add VLTi ports to VLANs configured on only one peer.

- VLAN ID 4094 is reserved as an internal control VLAN for the VLT domain, and it is not user configurable.
- Port-channel 1000 is reserved for the VLTi link and is not user configurable.
- The VLTi synchronizes L2 and L3 control-plane information across the two nodes. The VLTi is used for data traffic only when there is a link failure that requires VLTi to reach the final destination.
- Traffic with an unknown destination MAC address, multicast, or broadcast traffic can cause flooding across the VLTi.
- MAC, ARP, IPv6 neighbors that are learnt over VLANs on VLT peer nodes synchronize using the VLTi.
- LLDP, flow control, port monitoring, and jumbo frame features are supported on a VLTi. By default, VLTi ports are set to the maximum supported MTU value.

## Graceful LACP with VLT

When a VLT node is reloaded, all its interfaces including VLT port channel interfaces go down. Top-of-Rack (ToR) devices that are connected at the other end of the VLT port channel interfaces could take a considerable amount of time to detect the interface status change and switch the traffic towards the other active VLT node. Using LACP PDUs, the graceful LACP feature enables VLT nodes to inform ToR devices ahead of taking down the member ports of its VLT port channel interfaces. Thus, the graceful LACP feature enables the ToR devices to switch the traffic to the other active VLT node.

Graceful LACP is supported in these scenarios:

- When a VLT node is reloaded
- When the secondary VLT node detects that the VLTi link is down but the heartbeat is functional

Graceful LACP is enabled by default and you cannot disable it.

The following shows the normal behavior of a VLT setup where data flows through the optimal path to its destination:

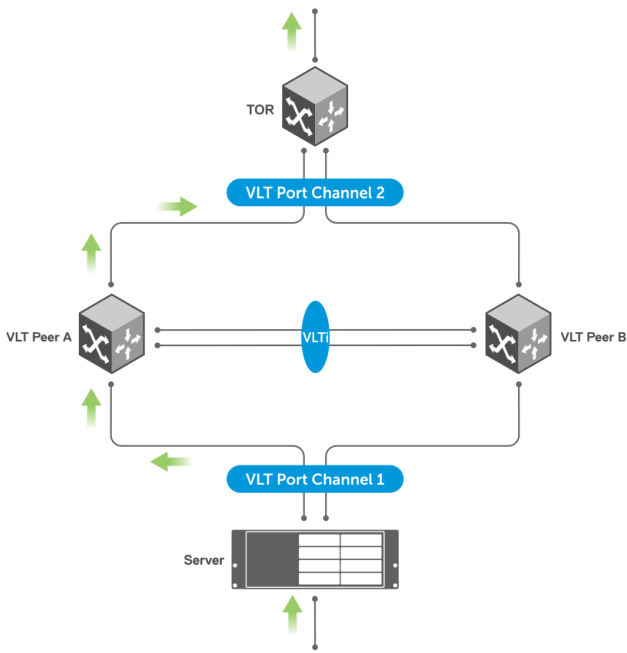

The following shows a scenario where VLT Peer A is being reloaded or going down:

Until LACP convergence happens, the server continues to forward traffic to VLT Peer A resulting in traffic loss for a longer time interval.

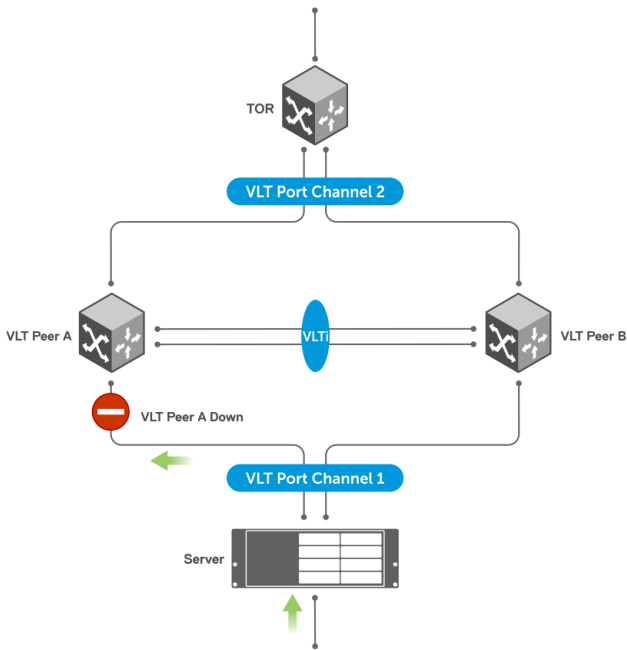

With graceful LACP, VLT Peer A sends graceful LACP PDUs out to all VLT member ports, as shown:

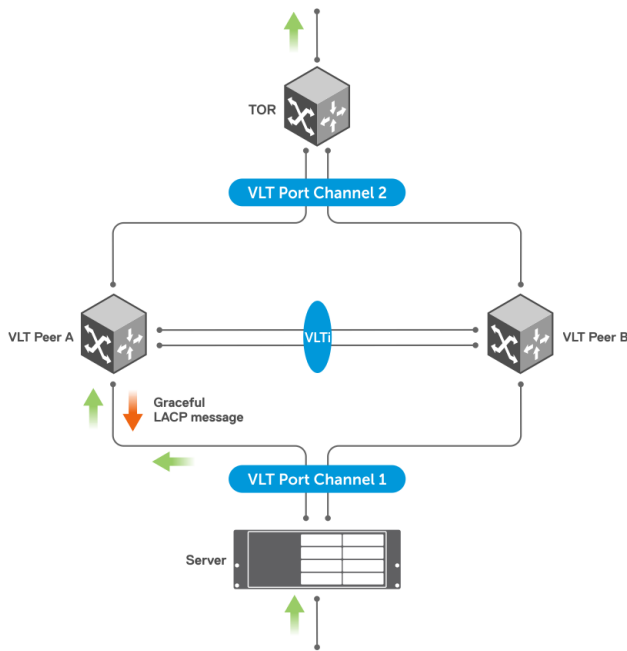

These PDUs notify the server to direct the traffic to VLT Peer B hence minimizing traffic loss.

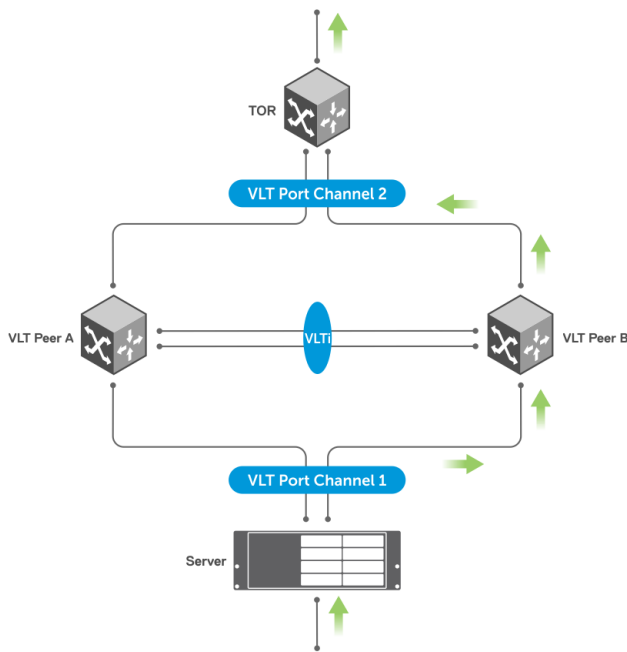

## Configure VLT

Verify that both VLT peer devices are running the same operating system version. For VRRP operation, configure VRRP groups and L3 routing on each VLT peer.

Configure the following settings on each VLT peer device separately:

1. To prevent loops in a VLT domain, Dell EMC Networking recommends enabling STP globally using the `spanning-tree mode` command. Enabling STP prevents accidental loops that faulty wiring causes.
2. Create a VLT domain by configuring the same domain ID on each peer using the `vlt-domain` command.
3. (Optional) To override the default VLT primary election mechanism based on the system MAC addresses of the VLT nodes, configure a VLT node priority for each of the VLT nodes using the `primary-priority` command. Enter a lower priority value for the desired primary VLT peer and a higher priority value for the desired secondary VLT peer.

**NOTE:** If a VLT peer is reloaded, it automatically becomes the secondary peer regardless of the VLT primary-priority setting.

- Configure VLTi interfaces with the `no switchport` command.
- Configure the VLTi interfaces on each peer using the `discovery-interface` command. After you configure both sides of the VLTi, the primary and secondary roles in the VLT domain are automatically assigned if primary priority is not configured.
- NOTE:** Dell EMC recommends that you disable flow-control on discovery interfaces. Use the `no flowcontrol receive` and `no flowcontrol transmit` commands to disable flow-control.
- (Optional) Manually reconfigure the default VLT MAC address. Configure the same VLT MAC address in both VLT peers. The manual configuration minimizes the time required to synchronize the default MAC address of the VLT domain on both peer devices when one peer switch reboots.
- (Optional) Configure a nondefault time interval to delay bringing up VLT ports in the secondary VLT peer after reload or when VLTi comes up after a shutdown or failure. The default time interval is 90 seconds.
- Configure the VLT heartbeat backup link using the `backup destination {ip-address | ipv6 ipv6-address} [vrf management] [interval interval-time]` command.
- Configure VLT port channels between VLT peers and an attached device using the `vlt-port-channel` command. Assign the same VLT port channel ID from 1 to 128 to interfaces on different peers that you bundle together. The peer interfaces appear as a single VLT port channel to downstream devices.
- Connect peer devices in a VLT domain to an attached access device or server.

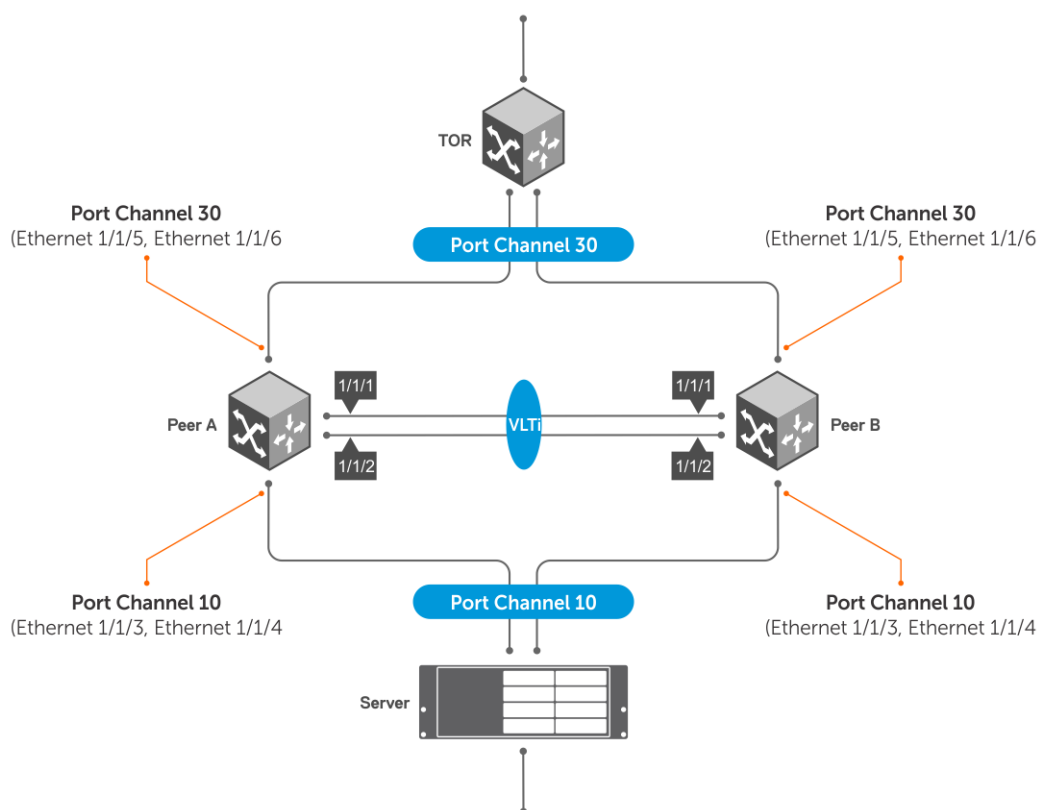

## Configure a Spanning Tree Protocol

Dell EMC Networking recommends configuring one of the supported spanning tree protocols (MSTP, RSTP, or RPVST+) on both VLT peers.

Use a spanning tree protocol for initial loop prevention during the VLT startup phase and for orphan ports. Configure the spanning tree protocol in the network before you configure VLT on peer switches.

**NOTE:** RPVST+ is enabled by default.

## RPVST+ configuration

Configure RPVST+ on both the VLT peers. This creates an RPVST+ instance for every VLAN configured in the system. With RPVST+ configured on both VLT nodes, OS10 supports a maximum of 60 VLANs. The RPVST+ instances in the primary VLT peer control the VLT port channels on both the primary and secondary peers.

**NOTE:** RPVST+ is the default STP mode running on the switch. Use the following command only if you have another variant of the STP running on the switch.

- Enable RPVST+ on each peer node in CONFIGURATION mode.

```
spanning-tree mode rapid-pvst
```

### Configure RPVST+ — peer 1

```
OS10(config)# spanning-tree mode rapid-pvst
```

### Configure RPVST+ — peer 2

```
OS10(config)# spanning-tree mode rapid-pvst
```

### View RPVST+ information on VLTi

```
OS10# show spanning-tree virtual-interface

VFP(VirtualFabricPort) of vlan 100 is Designated Blocking
Edge port: No (default)
Link type: point-to-point (auto)
Boundary: No, Bpdu-filter: Disable, Bpdu-Guard: Disable, Shutdown-on-Bpdu-Guard-
violation: No
Root-Guard: Disable, Loop-Guard: Disable
Bpdus (MRecords) Sent: 7, Received: 9
Interface
Name PortID Prio Cost Sts Cost Designated
ID PortID

VFP(VirtualFabricPort) 0.1 0 1 BLK 0 4196
90b1.1cf4.a602 0.1
```

**NOTE:** To view all other ports, use the `show spanning-tree active` command.

### View RPVST+ information on VLTi in detail

```
OS10# show spanning-tree virtual-interface detail
Port 1 (VFP(VirtualFabricPort)) of vlan1 is designated Forwarding
Port path cost 1, Port priority 0, Port Identifier 0.1
Designated root priority: 4097, address: 90:b1:1c:f4:a6:02
Designated bridge priority: 4097, address: 90:b1:1c:f4:a6:02
Designated port ID: 0.1, designated path cost: 0
Number of transitions to forwarding state: 1
Edge port: No (default)
Link Type: Point-to-Point
BPDU Sent: 202, Received: 42
Port 1 (VFP(VirtualFabricPort)) of vlan100 is designated Forwarding
Port path cost 1, Port priority 0, Port Identifier 0.1
Designated root priority: 4196, address: 90:b1:1c:f4:a6:02
Designated bridge priority: 4196, address: 90:b1:1c:f4:a6:02
Designated port ID: 0.1, designated path cost: 0
Number of transitions to forwarding state: 1
Edge port: No (default)
Link Type: Point-to-Point
BPDU Sent: 101, Received: 21
```



## RSTP configuration

- Enable RSTP on each peer node in CONFIGURATION mode.

```
spanning-tree mode rstp
```

### Configure RSTP — peer 1

```
OS10(config)# spanning-tree mode rstp
```

### Configure RSTP — peer 2

```
OS10(config)# spanning-tree mode rstp
```

### View VLTi-specific STP information

```
OS10# show spanning-tree virtual-interface
VFP(VirtualFabricPort) of RSTP 1 is Designated Forwarding
Edge port: No (default)
Link type: point-to-point (auto)
Boundary: No, Bpdu-filter: Disable, Bpdu-Guard: Disable, Shutdown-on-Bpdu-Guard-
violation: No
Root-Guard: Disable, Loop-Guard: Disable
Bpdus (MRecords) Sent: 11, Received: 7
Interface
Name PortID Prio Cost Sts Cost Bridge ID Designated

VFP(VirtualFabricPort) 0.1 0 1 FWD 0 32768 0078.7614.6062 0.1
```

 **NOTE:** To view all other ports, use the `show spanning-tree active` command.

### View STP virtual interface detail

```
OS10# show spanning-tree virtual-interface detail
Port 1 (VFP(VirtualFabricPort)) of RSTP 1 is designated Forwarding
Port path cost 1, Port priority 0, Port Identifier 0.1
Designated root priority: 32768, address: 00:78:76:14:60:62
Designated bridge priority: 32768, address: 00:78:76:14:60:62
Designated port ID: 0.1, designated path cost: 0
Number of transitions to forwarding state: 1
Edge port: No (default)
Link Type: Point-to-Point
BPDU Sent: 15, Received: 5
```

## MSTP configuration

When you enable Multiple Spanning Tree Protocol (MSTP) on VLT nodes, configure both VLT peer nodes in the same MST region to avoid network loops. Ensure that the VLAN-to-instance mappings, region name, and revision ID are the same on both VLT peer nodes.

 **NOTE:** OS10 supports a maximum of 64 MST instances.

To configure MSTP over VLT, follow these steps on both VLT peer nodes:

1. Enable MSTP.  
CONFIGURATION mode  
`spanning-tree mode mst`
2. Enter MST configuration mode.  
CONFIGURATION mode  
`spanning tree mst configuration`
3. Create an MST instance and add multiple VLANs as required.  
`MULTIPLE-SPANNING-TREE`

```
instance instance-number vlan from-vlan-id - to-vlan-id
```

4. Configure the MST revision number, from 0 to 65535.

```
MULTIPLE-SPANNING-TREE
revision revision-number
```

5. Configure the MST region name.

```
MULTIPLE-SPANNING-TREE
name name-string
```

The following example shows that both VLT nodes are configured with the same MST VLAN-to-instance mapping.

#### VLT Peer 1 configuration

```
OS10(config)# spanning-tree mode mst
OS10(config)# spanning-tree mst configuration
OS10(conf-mst)# instance 1 vlan 2-10
OS10(conf-mst)# revision 10
OS10(conf-mst)# name ExampleMSTregion
```

#### VLT Peer 2 configuration

```
OS10(config)# spanning-tree mode mst
OS10(config)# spanning-tree mst configuration
OS10(conf-mst)# instance 1 vlan 2-10
OS10(conf-mst)# revision 10
OS10(conf-mst)# name ExampleMSTregion
```

The following example shows MSTP information on VLTi:

**NOTE:** To view all the other ports, use the `show spanning-tree active` or `show spanning-tree msti` command.

```
OS10# show spanning-tree virtual-interface
VFP(VirtualFabricPort) of MSTI 0 is Designated Forwarding
Edge port: No (default)
Link type: point-to-point (auto)
Boundary: Yes, Bpdu-filter: Disable, Bpdu-Guard: Disable, Shutdown-on-Bpdu-Guard-violation: No
Root-Guard: Disable, Loop-Guard: Disable
Bpdus (MRecords) Sent: 387, Received: 16
Interface
Name PortID Prio Cost Sts Cost Bridge ID Designated
PortID

-VFP(VirtualFabricPort) 0.1 0 1 FWD 0 32768
3417.ebf2.a8c4 0.1

VLT-LAG -1(vlt-portid-1) of MSTI 0 is in Designated Forwarding
Edge port: No (default)
Link type: point-to-point (auto)
Boundary: No, Bpdu-filter: Disable, Bpdu-Guard: Disable,
Shutdown-on-Bpdu-Guard-violation: No
Root-Guard: Disable, Loop-Guard: Disable
Bpdus (MRecords) Sent: 1234, Received: 123

Virtual
Interface
Name PortID Prio Cost Sts Cost Designated
PortID Bridge ID

-

VLT-LAG -1(vlt-portid1) 128.2001 128 2000000 FWD 0 32768
90b1.1cf4.a523 128.2001
```

**NOTE:** To view all other ports, use the `show spanning-tree active` command.

The following example shows MSTP information on VLTi in detail:

```
OS10# show spanning-tree virtual-interface detail
Port 1 (VFP(VirtualFabricPort)) of MSTI 0 is designated Forwarding
Port path cost 0, Port priority 128, Port Identifier 128.1
Designated root priority: 32768, address: 34:17:44:55:66:7f
Designated bridge priority: 32768, address: 90:b1:1c:f4:a5:23
Designated port ID: 128.1, designated path cost: 0
```

```
Number of transitions to forwarding state: 1
Edge port: No (default)
Link Type: Point-to-Point
BPDU Sent: 2714, Received: 1234
```

```
Port 2001 (VLT-LAG -1(vlt-portid-1)) of MSTI 0 is designated Forwarding
Port path cost 200000, Port priority 128, Port Identifier 128.2001
Designated root priority: 32768, address: 34:17:44:55:66:7f
Designated bridge priority: 32768, address: 90:b1:1c:f4:a5:23
Designated port ID: 128.2001, designated path cost: 0
Number of transitions to forwarding state: 1
Edge port: No (default)
Link Type: Point-to-Point
BPDU Sent: 2714, Received: 1234
```

## Create the VLT domain

A VLT domain requires an ID number. Configure the same VLT domain ID on both peers. For more information, see the [VLT domain](#) section. The `no vlt-domain` command disables VLT. Disabling VLT can cause loops in the network. Hence, use the `no` form of the command cautiously.

1. Configure a VLT domain and enter VLT-DOMAIN mode. Configure the same VLT domain ID on each peer, from 1 to 255.

```
vlt-domain domain-id
```

2. Repeat the steps on the VLT peer to create the VLT domain.

### Peer 1

```
OS10(config)# vlt-domain 1
OS10(conf-vlt-1)#
```

### Peer 2

```
OS10(config)# vlt-domain 1
OS10(conf-vlt-1)#
```

## Configure the VLTi

Before you configure the VLTi on peer interfaces, remove each interface from L2 mode with the `no switchport` command. For more information, see the [VLT interconnect](#) section.

1. Enter the VLT domain ID to enter from CONFIGURATION mode.

```
vlt-domain domain-id
```

2. Configure one or a hyphen-separated range of VLT peer interfaces to become a member of the VLTi in INTERFACE mode.

```
discovery-interface {ethernet node/slot/port[:subport] | ethernet node/slot/
port[:subport] -node/slot/port[:subport]}
```

3. Repeat the steps on the VLT peer.

### Peer 1

```
OS10(config)# interface ethernet 1/1/1
OS10(conf-if-eth1/1/1)# no switchport
OS10(conf-if-eth1/1/1)# exit
OS10(config)# interface ethernet 1/1/2
OS10(conf-if-eth1/1/2)# no switchport
OS10(conf-if-eth1/1/2)# exit
OS10(config)# vlt-domain 1
OS10(conf-vlt-1)# discovery-interface ethernet1/1/1
OS10(conf-vlt-1)# discovery-interface ethernet1/1/2
```

## Peer 2

```
OS10(config)# interface ethernet 1/1/1
OS10(conf-if-eth1/1/1)# no switchport
OS10(conf-if-eth1/1/1)# exit
OS10(config)# interface ethernet 1/1/2
OS10(conf-if-eth1/1/2)# no switchport
OS10(conf-if-eth1/1/2)# exit
OS10(config)# vlt-domain 1
OS10(conf-vlt-1)# discovery-interface ethernet1/1/1-1/1/2
```

## Configure the VLT MAC address

You can manually configure the VLT MAC address.

Configure the same VLT MAC address on both the VLT peer switches to avoid any unpredictable behavior during a VLT failover. For example, when a unit is down or when the VLTi is reset. If you do not configure a VLT MAC address, the MAC address of the primary peer is used as the VLT MAC address across all peers.

Use the `vlt-mac mac-address` to configure the MAC address in both the VLT peers.

### Example configuration:

```
OS10(config)# vlt-domain 1
OS10(conf-vlt-1)# vlt-mac 00:00:00:00:00:02
```

 **NOTE:** Dell EMC Networking recommends configuring the VLT MAC address manually on both the VLT peer switches. Use the same MAC address on both peers.

## Configure the delay restore timer

When the secondary VLT node boots, it waits for a pre-configured amount of time (delay restore) to restore the VLT port status. This delay enables VLT peers to complete the control data information exchange.

If the peer VLT device was up at the time the VLTi link failed, the system delays bringing up the VLT ports after reload or peer-link restoration between the VLT peer switches.

When both the VLT peers are up and running, and if the VLTi fails with the VLT heartbeat up, the secondary peer brings down the VLT ports. When the VLTi comes up, the secondary peer does not bring up its VLT ports immediately. The VLT ports are brought up only after the VLT port restoration timer expires. The delay restore timer enables both VLT peers to synchronize the control information with each other.

The default timer is 90 seconds. You can use the `delay-restore seconds` command to modify the duration of the timer.

### Example:

```
OS10(config)# vlt-domain 1
OS10(conf-vlt-1)# delay-restore 100
```

## Configure the VLT peer liveness check

The VLT peer liveness mechanism checks for the availability of the peer node. The system sends periodic keep-alive messages to detect the liveness of the peer node. You must use a different link other than the VLTi for the peer liveness check. This link is referred to as the VLT backup link.

 **NOTE:** Dell EMC Networking recommends using the OOB management network connection for the VLT backup link.

If the VLTi goes down, the backup link helps to differentiate the VLTi link failure from a peer node failure. If all links in the VLTi fail, the VLT nodes exchange node liveness information through the backup link.

Based on the node liveness information:

- If only the VLTi link fails, but the peer is alive, the secondary VLT peer shuts down its VLT ports.
- If the primary VLT node fails, both the VLTi and heartbeat fail, and the current secondary peer takes over the primary role.

Configure the VLT backup link using the `backup destination {ip-address | ipv6 ipv6-address} [vrf management] [interval interval-time]`. The interval range is from 1 to 30 seconds. The default interval is 30 seconds. Irrespective of the interval that is configured, when the VLTi link fails, the system checks for the heartbeat connection without waiting for the timed intervals, thus allowing faster convergence.

**NOTE:** The VLT domain and the backup parameters are auto-configured in the SmartFabric Services mode from release 10.5.0 onwards.

**Example configuration:**

```
OS10(config)# vlt-domain 1
OS10(conf-vlt-1)# backup destination 10.16.151.110 vrf management interval 20

OS10(config)# vlt-domain 1
OS10(conf-vlt-1)# backup destination ipv6 1::1 vrf management interval 20
```

The following examples describe different cases where the VLT backup link is used:

In the following figure, the backup link is not configured:

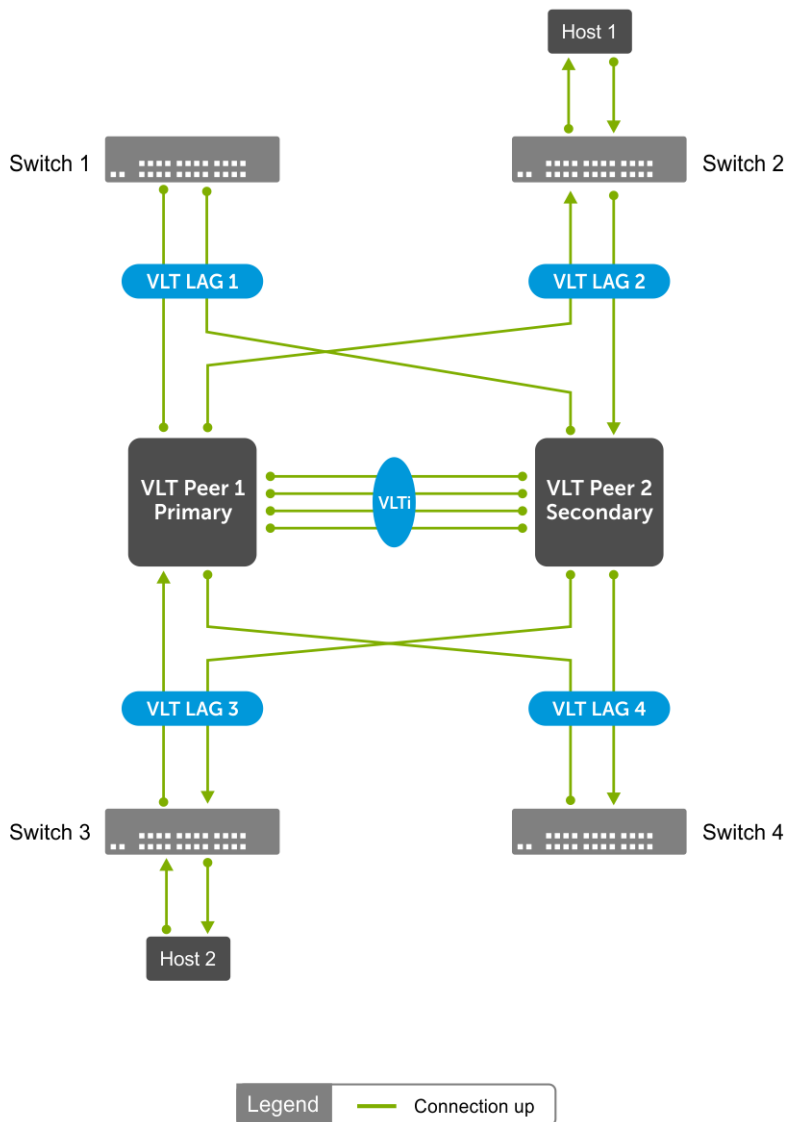

**Support for new streams during VLTi failure**

If the VLTi fails, MAC addresses that are learned after the failure are not synchronized with VLT peers. Thus, instead of unicast, the VLTi failure causes a continuous traffic flood.

If the VLTi links fail, MAC and ARP synchronization does not happen, and it causes the system to flood L2 packets and drop L3 packets.

For example, as shown, after the VLTi is down, VLT peer1 learns the MAC address of Host 2:

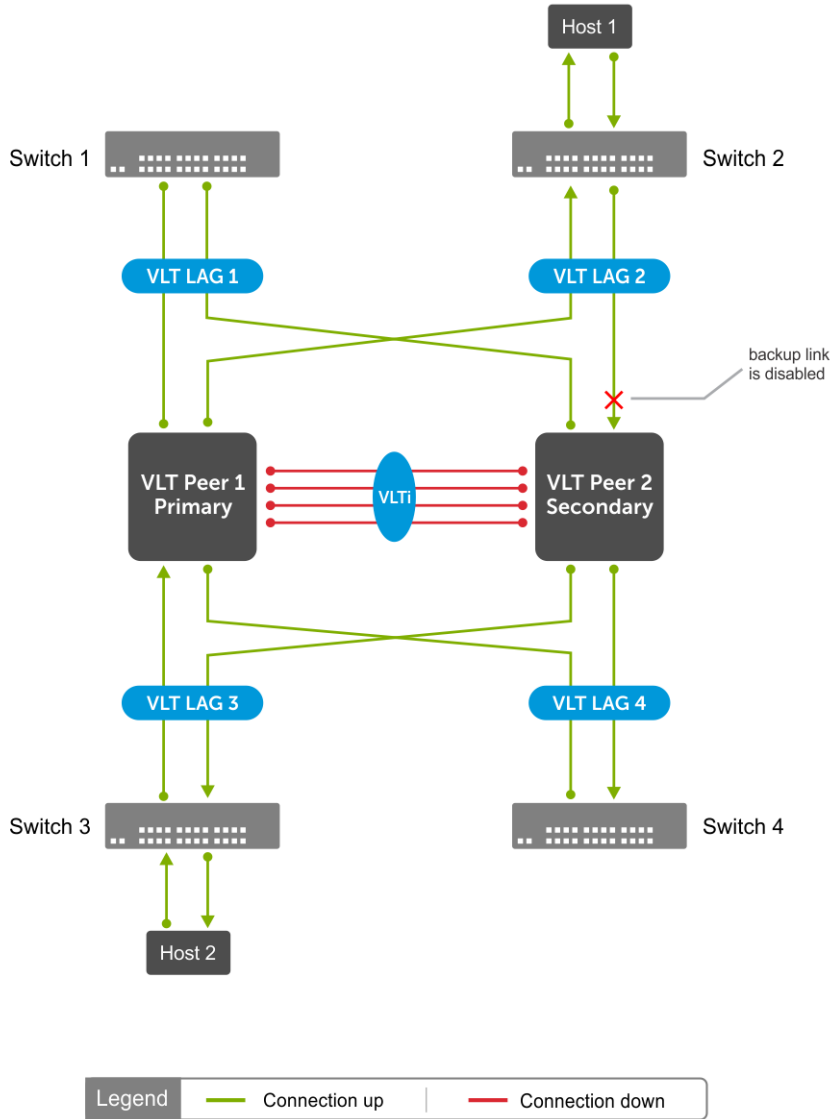

VLT Peer 2 is not synchronized with the MAC address of Host 2 because the VLTi link is down. When traffic from Host 1 is sent to VLT Peer 2, VLT Peer 2 floods the traffic.

When the VLT backup link is enabled, the secondary VLT Peer 2 identifies the node liveliness through the backup link. If the primary is up, the secondary peer brings down VLT port channels. The traffic from Host 1 reaches VLT Peer 1 and then reaches the destination, Host 2. In this case, the traffic is unicasted instead of flooding, as shown:

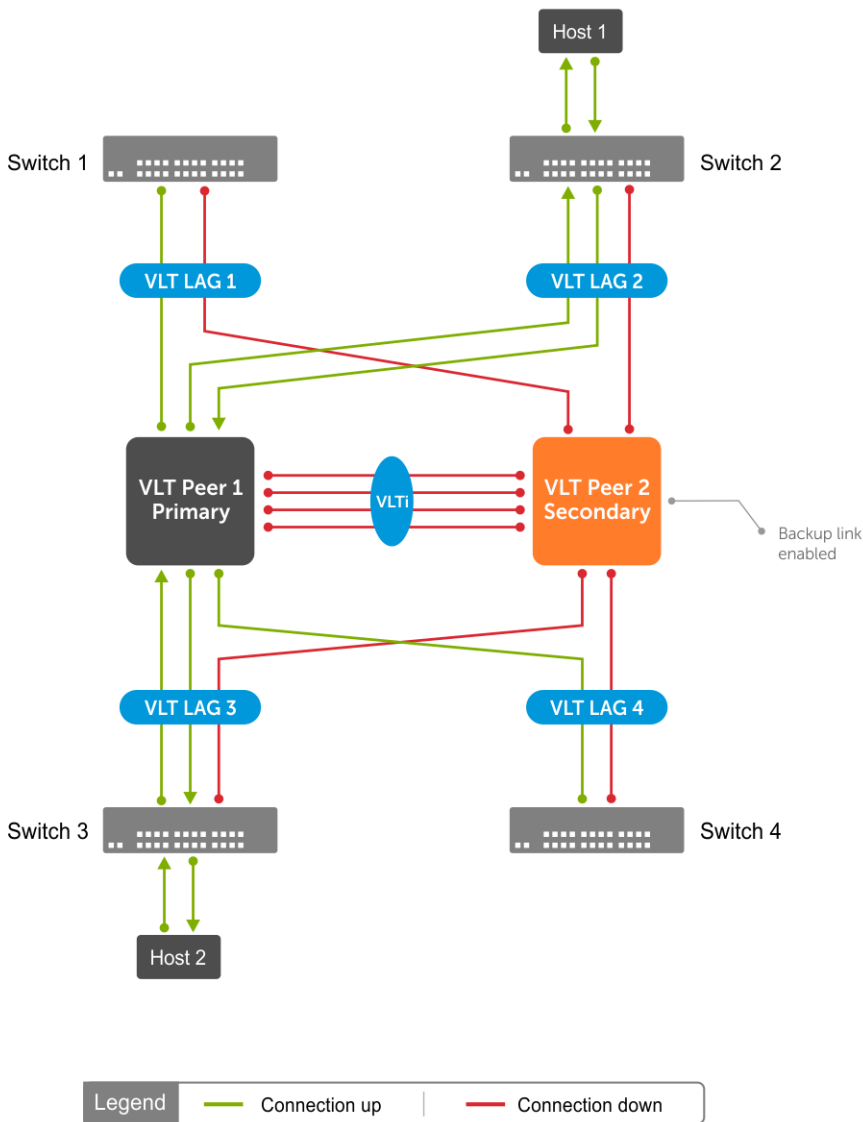

### Role of VLT backup link in the prevention of loops during VLTi failure

When the VLTi is down, STP may fail to detect any loops in the system. This failure creates a data loop in an L2 network.

As shown, STP is running in all three switches:

In the steady state, VLT Peer 1 is elected as the root bridge. When the VLTi is down, both the VLT nodes become primary. In this state, VLT Peer 2 sends STP BPDU to TOR assuming that TOR sends BPDU to VLT Peer 1. Due to this, VLT Peer 2 does not receive BPDU on the VLT port, but receives TOR BPDU from the orphan port. The STP in VLT Peer 2 assumes that there is no loop in the system and opens up both the VLT and the orphan ports. Opening up both the VLT and orphan ports creates a data loop and brings down the system.

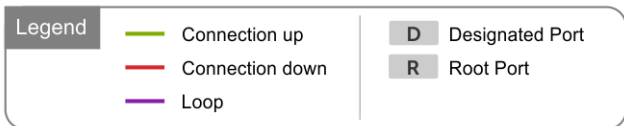
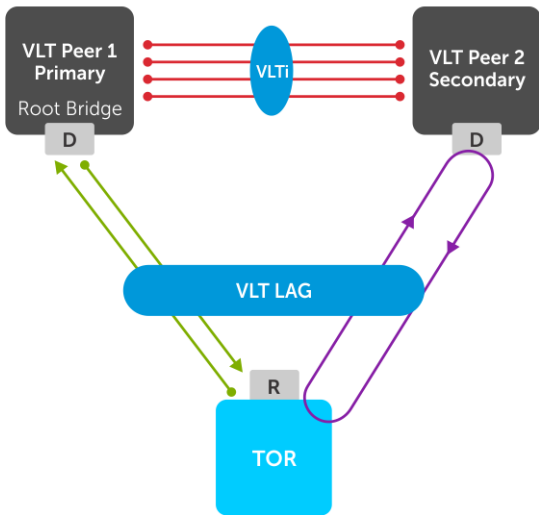

When the VLT backup link is enabled, the secondary VLT peer identifies the node liveliness of primary through the backup link. If the primary VLT peer is up, the secondary VLT peer brings down the VLT port channels. In this scenario, the STP opens up the orphan port and there is no loop in the system, as shown:

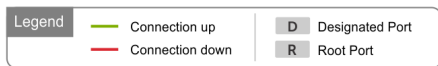
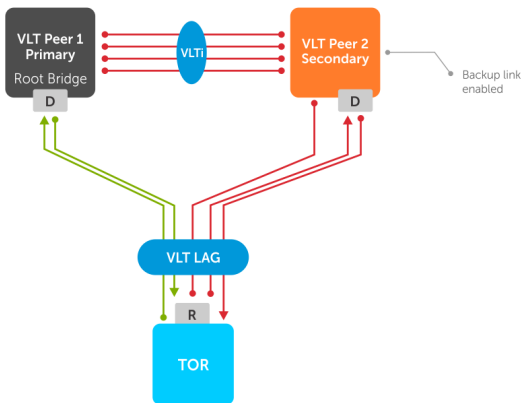

## Configure a VLT port channel

A VLT port channel, also known as a virtual link trunk, links an attached device and VLT peer switches. OS10 supports a maximum of 128 VLT port channels per node.

1. Enter the port channel ID number on the VLT peer in INTERFACE mode, from 1 to 128.

```
interface port-channel id-number
```

2. Assign the same ID to a VLT port channel on each VLT peer. The peers are seen as a single switch to downstream devices.

```
vlt-port-channel vlt-port-channel-id
```

3. Repeat the steps on the VLT peer.



### Configure VLT port channel — peer 1

```
OS10(config)# interface port-channel 20
OS10(conf-if-po-20)# vlt-port-channel 20
```

### Configure VLT port channel — peer 2

```
OS10(config)# interface port-channel 20
OS10(conf-if-po-20)# vlt-port-channel 20
```

## Configure VLT peer routing

VLT peer routing enables optimized routing where packets destined for the L3 endpoint of the VLT peer are locally routed. VLT supports unicast routing of both IPv4 and IPv6 traffic.

To enable VLT unicast routing, both VLT peers must be in L3 mode. The VLAN configuration must be symmetrical on both peers. You cannot configure the same VLAN as L2 on one node and as L3 on the other node.

1. Enter the VLT domain ID in CONFIGURATION mode, from 1 to 255.

```
vlt-domain domain-id
```

2. Enable peer-routing in VLT-DOMAIN mode.

```
peer-routing
```

3. Repeat the steps on the VLT peer.

### Configure unicast routing — peer 1

```
OS10(config)# vlt-domain 1
OS10(conf-vlt-1)# peer-routing
```

### Configure unicast routing — peer 2

```
OS10(config)# vlt-domain 1
OS10(conf-vlt-1)# peer-routing
```

## Configure VRRP Active-Active mode

To enable optimized L3 forwarding over VLT, use VRRP Active-Active mode. By default, VRRP Active-Active mode is enabled on the VLAN interfaces. In this mode, each peer locally forwards L3 traffic, eliminating traffic flow across the VLTi link.

Configure the same static and dynamic L3 routing on each peer to ensure that L3 reachability and routing tables are the same on both peers.

1. Enable VRRP Active-Active mode in VLAN-INTERFACE mode.

```
vrrp mode active-active
```

2. Configure VRRP on the L3 VLAN that spans both peers.
3. Repeat the steps on the VLT peer.

### Configure VRRP active-active mode — peer 1

```
OS10(conf-if-vl-10)# vrrp mode active-active
```

 **NOTE:** VRRP active-active is the default mode.

### Configure VRRP active-active mode — peer 2

```
OS10(conf-if-vl-10)# vrrp mode active-active
```

# Migrate VMs across data centers with eVLT

OS10 switches support movement of virtual machines (VMs) across data centers using VRRP Active-Active mode.

Configure symmetric VRRP with the same VRRP group ID and virtual IP in VLANs stretched or spanned across data centers. VMs use the VRRP Virtual IP address of the VLAN as Gateway IP. As the VLAN configurations are symmetric across data centers, you can move the VMs from one data center to another.

You must assign the same VRRP group IDs to the VLANs in L3 mode, with VRRP in Active-Active mode.

The following figure shows a sample configuration with two data centers:

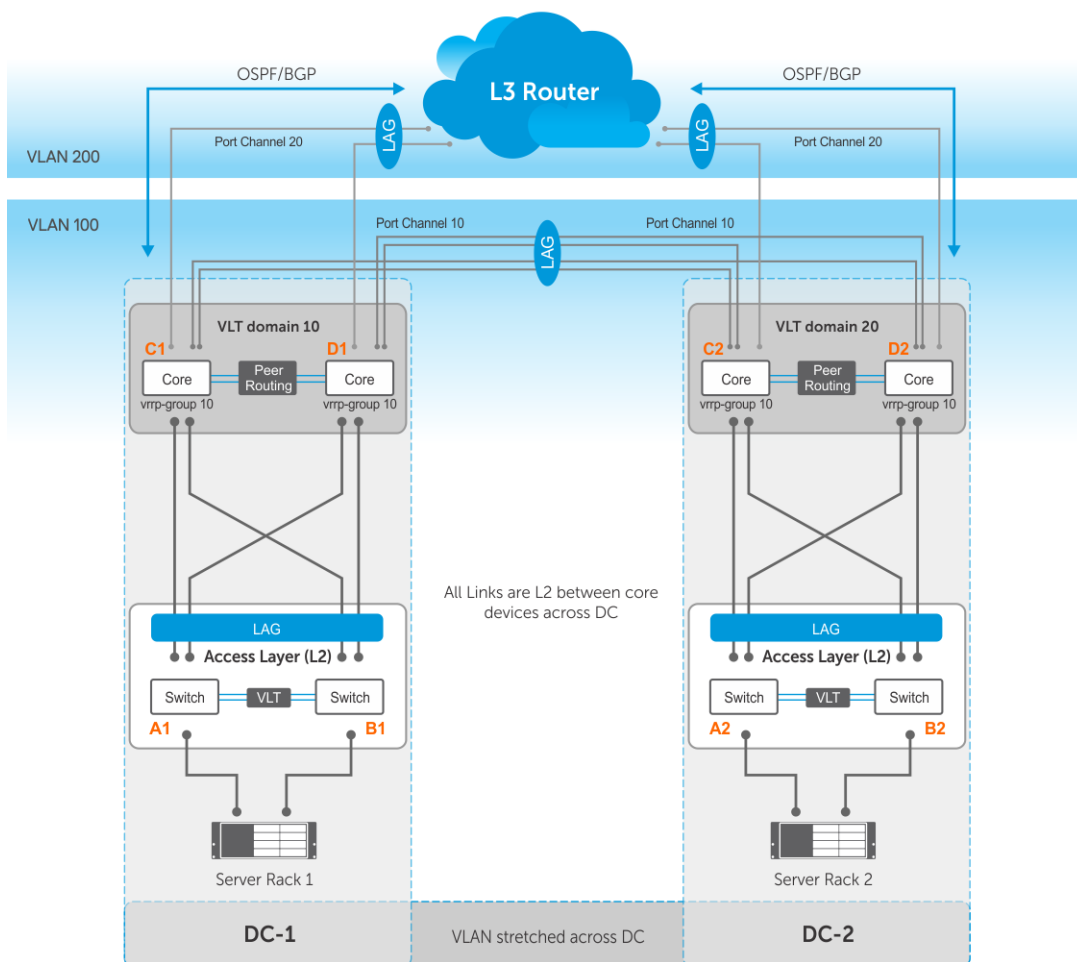

- Server racks, Rack 1 and Rack 2, are part of data centers DC1 and DC2, respectively.
- Rack 1 is connected to devices A1 and B1 in L2 network segment.
- Rack 2 is connected to devices A2 and B2 in L2 network segment.
- A VLT port channel is present between A1 and B1 as well as A2 and B2.
- A1 and B1 connect to core routers, C1 and D1 with VLT routing enabled.
- A2 and B2 connect to core routers, C2 and D2, with VLT routing enabled.
- The data centers are connected through a direct link or eVLT.
- The core routers C1 and D1 in the local VLT domain connect to the core routers C2 and D2 in the remote VLT domain using VLT links.
- The core routers C1 and D1 in local VLT domain along with C2 and D2 in the remote VLT domain are part of an L3 cloud.
- The core routers C1, D1, C2, D2 are in a VRRP group with the same vrrp-group ID.

When a virtual machine running in Server Rack 1 migrates to Server Rack 2, L3 packets for that VM are routed without interruption.

## Sample configuration of C1:

- **Configure VRRP on L2 links between core routers:**

```
C1(config)# interface vlan 100
C1(conf-if-vl-100)# ip address 10.10.100.1/24
C1(conf-if-vl-100)# vrrp-group 10
C1(conf-vlan100-vrid-10)# priority 250
C1(conf-vlan100-vrid-10)# virtual-address 10.10.100.5
```

- **Configure VLT port channel for VLAN 100:**

```
C1(config)# interface port-channel 10
C1(conf-if-po-10)# vlt-port-channel 10
C1(conf-if-po-10)# switchport mode trunk
C1(conf-if-po-10)# switchport trunk allowed vlan 100
C1(conf-if-po-10)# exit
```

- **Add members to port channel 10:**

```
C1(config)# interface ethernet 1/1/3
C1(conf-if-eth1/1/3)# channel-group 10
C1(conf-if-eth1/1/3)# exit
C1(config)# interface ethernet 1/1/4
C1(conf-if-eth1/1/4)# channel-group 10
C1(conf-if-eth1/1/4)# exit
```

- **Configure OSPF on L3 side of core router:**

```
C1(config)# router ospf 100
C1(config-router-ospf-100)# redistribute connected
C1(config-router-ospf-100)# exit
C1(config)# interface vlan 200
C1(conf-if-vl-200)# ip ospf 100 area 0.0.0.0
```

- **Configure VLT port channel for VLAN 200:**

```
C1(config)# interface port-channel 20
C1(conf-if-po-20)# vlt-port-channel 20
C1(conf-if-po-20)# switchport mode trunk
C1(conf-if-po-20)# switchport trunk allowed vlan 200
C1(conf-if-po-20)# exit
```

- **Add members to port channel 20:**

```
C1(config)# interface ethernet 1/1/5
C1(conf-if-eth1/1/5)# channel-group 20
C1(conf-if-eth1/1/5)# exit
C1(config)# interface ethernet 1/1/6
C1(conf-if-eth1/1/6)# channel-group 20
C1(conf-if-eth1/1/6)# exit
```

#### Sample configuration of D1:

- **Configure VRRP on L2 links between core routers:**

```
D1(config)# interface vlan 100
D1(conf-if-vl-100)# ip address 10.10.100.2/24
D1(conf-if-vl-100)# vrrp-group 10
D1(conf-vlan100-vrid-10)# virtual-address 10.10.100.5
```

- **Configure VLT port channel for VLAN 100:**

```
D1(config)# interface port-channel 10
D1(conf-if-po-10)# vlt-port-channel 10
D1(conf-if-po-10)# switchport mode trunk
D1(conf-if-po-10)# switchport trunk allowed vlan 100
D1(conf-if-po-10)# exit
```

- **Add members to port channel 10:**

```
D1(config)# interface ethernet 1/1/3
D1(conf-if-eth1/1/3)# channel-group 10
D1(conf-if-eth1/1/3)# exit
```

```
D1(config)# interface ethernet 1/1/4
D1(conf-if-eth1/1/4)# channel-group 10
D1(conf-if-eth1/1/4)# exit
```

- **Configure OSPF on L3 side of core router:**

```
D1(config)# router ospf 100
D1(config-router-ospf-100)# redistribute connected
D1(conf-router-ospf-100)# exit
D1(config)# interface vlan 200
D1(conf-if-vl-200)# ip ospf 100 area 0.0.0.0
```

- **Configure VLT port channel for VLAN 200:**

```
D1(config)# interface port-channel 20
D1(conf-if-po-20)# vlt-port-channel 20
D1(conf-if-po-20)# switchport mode trunk
D1(conf-if-po-20)# switchport trunk allowed vlan 200
D1(conf-if-po-20)# exit
```

- **Add members to port channel 20:**

```
D1(config)# interface ethernet 1/1/5
D1(conf-if-eth1/1/5)# channel-group 20
D1(conf-if-eth1/1/5)# exit
D1(config)# interface ethernet 1/1/6
D1(conf-if-eth1/1/6)# channel-group 20
D1(conf-if-eth1/1/6)# exit
```

### Sample configuration of C2:

- **Configure VRRP on L2 links between core routers:**

```
C2(config)# interface vlan 100
C2(conf-if-vl-100)# ip address 10.10.100.3/24
C2(conf-if-vl-100)# vrrp-group 10
C2(conf-vlan100-vrid-10)# virtual-address 10.10.100.5
```

- **Configure VLT port channel for VLAN 100:**

```
C2(config)# interface port-channel 10
C2(conf-if-po-10)# vlt-port-channel 10
C2(conf-if-po-10)# switchport mode trunk
C2(conf-if-po-10)# switchport trunk allowed vlan 100
C2(conf-if-po-10)# exit
```

- **Add members to port channel 10:**

```
C2(config)# interface ethernet 1/1/3
C2(conf-if-eth1/1/3)# channel-group 10
C2(conf-if-eth1/1/3)# exit
C2(config)# interface ethernet 1/1/4
C2(conf-if-eth1/1/4)# channel-group 10
C2(conf-if-eth1/1/4)# exit
```

- **Configure OSPF on L3 side of core router:**

```
C2(config)# router ospf 100
C2(config-router-ospf-100)# redistribute connected
C2(conf-router-ospf-100)# exit
C2(config)# interface vlan 200
C2(conf-if-vl-200)# ip ospf 100 area 0.0.0.0
```

- **Configure VLT port channel for VLAN 200:**

```
C2(config)# interface port-channel 20
C2(conf-if-po-20)# vlt-port-channel 20
C2(conf-if-po-20)# switchport mode trunk
C2(conf-if-po-20)# switchport trunk allowed vlan 200
C2(conf-if-po-20)# exit
```

- **Add members to port channel 20:**

```
C2(config)# interface ethernet 1/1/5
C2(conf-if-eth1/1/5)# channel-group 20
C2(conf-if-eth1/1/5)# exit
C2(config)# interface ethernet 1/1/6
C2(conf-if-eth1/1/6)# channel-group 20
C2(conf-if-eth1/1/6)# exit
```

**Sample configuration of D2:**

- **Configure VRRP on L2 links between core routers:**

```
D2(config)# interface vlan 100
D2(conf-if-vl-100)# ip address 10.10.100.4/24
D2(conf-if-vl-100)# vrrp-group 10
D2(conf-vlan100-vrid-10)# virtual-address 10.10.100.5
```

- **Configure VLT port channel for VLAN 100:**

```
D2(config)# interface port-channel 10
D2(conf-if-po-10)# vlt-port-channel 10
D2(conf-if-po-10)# switchport mode trunk
D2(conf-if-po-10)# switchport trunk allowed vlan 100
D2(conf-if-po-10)# exit
```

- **Add members to port channel 10:**

```
D2(config)# interface ethernet 1/1/3
D2(conf-if-eth1/1/3)# channel-group 10
D2(conf-if-eth1/1/3)# exit
D2(config)# interface ethernet 1/1/4
D2(conf-if-eth1/1/4)# channel-group 10
D2(conf-if-eth1/1/4)# exit
```

- **Configure OSPF on L3 side of core router:**

```
D2(config)# router ospf 100
D2(config-router-ospf-100)# redistribute connected
D2(config-router-ospf-100)# exit
D2(config)# interface vlan 200
D2(conf-if-vl-200)# ip ospf 100 area 0.0.0.0
```

- **Configure VLT port channel for VLAN 200:**

```
D2(config)# interface port-channel 20
D2(conf-if-po-20)# vlt-port-channel 20
D2(conf-if-po-20)# switchport mode trunk
D2(conf-if-po-20)# switchport trunk allowed vlan 200
D2(conf-if-po-20)# exit
```

- **Add members to port channel 20:**

```
D2(config)# interface ethernet 1/1/5
D2(conf-if-eth1/1/5)# channel-group 20
D2(conf-if-eth1/1/5)# exit
D2(config)# interface ethernet 1/1/6
D2(conf-if-eth1/1/6)# channel-group 20
D2(conf-if-eth1/1/6)# exit
```

# View VLT information

To monitor the operation or verify the configuration of a VLT domain, use a VLT `show` command on primary and secondary peers.

- View detailed information about the VLT domain configuration in EXEC mode, including VLTi status, local and peer MAC addresses, peer-routing status, and VLT peer parameters.

```
show vlt domain-id
```

- View the role of the local and remote VLT peer in EXEC mode.

```
show vlt domain-id role
```

- View any mismatches in the VLT configuration in EXEC mode.

```
show vlt domain-id mismatch
```

- View detailed information about VLT ports in EXEC mode.

```
show vlt domain-id vlt-port-detail
```

- View the current configuration of all VLT domains in EXEC mode.

```
show running-configuration vlt
```

## VLT commands

### backup destination

Configures the VLT backup link for heartbeat timers.

**Syntax** `backup destination {ip-address | ipv6 ipv6-address} [vrf management] [interval interval-time]`

- Parameters**
- `ip-address` — Enter the IPv4 address of the backup link.
  - `ipv6-address` — Enter the IPv6 address of the backup link.
  - `vrf management` — (Optional) Configure the management VRF instance for the backup IPv4 or IPv6 address.
  - `interval interval-time` — (Optional) Enter the time in seconds to configure the heartbeat interval.

**Default** Not configured

**Command Mode** VLT-DOMAIN

**Usage Information** The `no` version of this command removes the IP address from the backup link.

**Example**

```
OS10(config)# vlt-domain 1
OS10(conf-vlt-1)# backup destination 10.16.151.110 vrf management
interval 30
```

```
OS10(config)# vlt-domain 1
OS10(conf-vlt-1)# backup destination ipv6 1::1 vrf management interval 30
```

**Supported Releases** 10.3.1E or later

## delay-restore

Configures a time interval to delay bringing up the VLT ports after reload or peer-link restoration between the VLT peer switches.

|                           |                                                                                                                                                                                                                                                                                                                                                                                            |
|---------------------------|--------------------------------------------------------------------------------------------------------------------------------------------------------------------------------------------------------------------------------------------------------------------------------------------------------------------------------------------------------------------------------------------|
| <b>Syntax</b>             | <code>delay-restore seconds</code>                                                                                                                                                                                                                                                                                                                                                         |
| <b>Parameters</b>         | <code>seconds</code> — Enter a delay time, in seconds, to delay bringing up VLT ports after the VLTi link is detected, from 1 to 1200.                                                                                                                                                                                                                                                     |
| <b>Default</b>            | 90 seconds                                                                                                                                                                                                                                                                                                                                                                                 |
| <b>Command Mode</b>       | VLT-DOMAIN                                                                                                                                                                                                                                                                                                                                                                                 |
| <b>Usage Information</b>  | Use this command to delay the system from bringing up the VLT port for a brief period to allow the exchange of control information, such as, MAC and ARP tables between VLT peers. If the peer VLT device was up at the time the VLTi link failed, use this command after you reload a VLT device. The <code>no</code> version of this command resets the delay time to the default value. |
| <b>Example</b>            | <pre>OS10(conf-vlt-1)# delay-restore 100</pre>                                                                                                                                                                                                                                                                                                                                             |
| <b>Supported Releases</b> | 10.3.0E or later                                                                                                                                                                                                                                                                                                                                                                           |

## discovery-interface

Configures the interface to discover and connect to a VLT peer in the VLT interconnect (VLTi) link between peers.

|                           |                                                                                                                                                                                                                                                                                                                                                                                                                                                                                                                               |
|---------------------------|-------------------------------------------------------------------------------------------------------------------------------------------------------------------------------------------------------------------------------------------------------------------------------------------------------------------------------------------------------------------------------------------------------------------------------------------------------------------------------------------------------------------------------|
| <b>Syntax</b>             | <code>discovery-interface {ethernet node/slot/port[:subport]}</code>                                                                                                                                                                                                                                                                                                                                                                                                                                                          |
| <b>Parameters</b>         | <code>ethernet</code> — Enter the Ethernet interface information for the port on a VLT peer. You can also enter a range of interfaces separated by hyphens and commas.                                                                                                                                                                                                                                                                                                                                                        |
| <b>Default</b>            | None                                                                                                                                                                                                                                                                                                                                                                                                                                                                                                                          |
| <b>Command Mode</b>       | VLT-DOMAIN                                                                                                                                                                                                                                                                                                                                                                                                                                                                                                                    |
| <b>Usage Information</b>  | The VLT node discovery service automatically connects the discovery port to its peer node port and creates VLTi interfaces. The <code>no</code> version of this command disables the discovery-interface configuration.<br> <b>NOTE:</b> Dell EMC recommends that you disable flow-control on discovery interfaces. Use the <code>no flowcontrol receive</code> and <code>no flowcontrol transmit</code> commands to disable flow-control. |
| <b>Example</b>            | <pre>OS10(config)# vlt-domain 1 OS10(conf-vlt-1)# discovery-interface ethernet 1/1/15  OS10(conf-if-eth1/1/15)# no flowcontrol receive OS10(conf-if-eth1/1/15)# no flowcontrol transmit</pre>                                                                                                                                                                                                                                                                                                                                 |
| <b>Example (range)</b>    | <pre>OS10(config)# vlt-domain 2 OS10(conf-vlt-2)# discovery-interface ethernet 1/1/1-1/1/2  OS10(conf-if-eth1/1/1)# no flowcontrol receive OS10(conf-if-eth1/1/1)# no flowcontrol transmit  OS10(conf-if-eth1/1/2)# no flowcontrol receive OS10(conf-if-eth1/1/2)# no flowcontrol transmit</pre>                                                                                                                                                                                                                              |
| <b>Supported Releases</b> | 10.2.0E or later                                                                                                                                                                                                                                                                                                                                                                                                                                                                                                              |

## peer-routing

Enables optimized routing where packets destined for the L3 endpoint of the VLT peer are locally routed.

|                           |                                                                    |
|---------------------------|--------------------------------------------------------------------|
| <b>Syntax</b>             | <code>peer-routing</code>                                          |
| <b>Parameters</b>         | None                                                               |
| <b>Default</b>            | Disabled                                                           |
| <b>Command Mode</b>       | VLT-DOMAIN                                                         |
| <b>Usage Information</b>  | The <code>no</code> version of this command disables peer routing. |
| <b>Example</b>            | <pre>OS10(conf-vlt-1)# peer-routing</pre>                          |
| <b>Supported Releases</b> | 10.2.0E or later                                                   |

## peer-routing-timeout

Configures the delay after which, the system disables peer routing when the peer is not available. This command supports both IPv6 and IPv4 routing.

|                           |                                                                                                                                                                                                                                                                               |
|---------------------------|-------------------------------------------------------------------------------------------------------------------------------------------------------------------------------------------------------------------------------------------------------------------------------|
| <b>Syntax</b>             | <code>peer-routing-timeout value</code>                                                                                                                                                                                                                                       |
| <b>Parameters</b>         | <i>value</i> — Enter the timeout value in seconds, from 0 to 65535.                                                                                                                                                                                                           |
| <b>Default</b>            | 0                                                                                                                                                                                                                                                                             |
| <b>Command Mode</b>       | VLT-DOMAIN                                                                                                                                                                                                                                                                    |
| <b>Usage Information</b>  | When the timer expires, the system checks to see if the VLT peer is available. If the VLT peer is not available, the system disables peer-routing on the peer. If you do not configure the timer, the system does not disable peer-routing even when the peer is unavailable. |
| <b>Example</b>            | <pre>OS10(conf-vlt-1)# peer-routing-timeout 120</pre>                                                                                                                                                                                                                         |
| <b>Supported Releases</b> | 10.3.0E or later                                                                                                                                                                                                                                                              |

## primary-priority

Configures the priority when selecting the primary and secondary VLT peers during the election.

|                          |                                                                                                                                                                                                                                                                                                                                                                                                                                                                                                                                                                                                                                                                                                                                                                                                                                                                                                                                                         |
|--------------------------|---------------------------------------------------------------------------------------------------------------------------------------------------------------------------------------------------------------------------------------------------------------------------------------------------------------------------------------------------------------------------------------------------------------------------------------------------------------------------------------------------------------------------------------------------------------------------------------------------------------------------------------------------------------------------------------------------------------------------------------------------------------------------------------------------------------------------------------------------------------------------------------------------------------------------------------------------------|
| <b>Syntax</b>            | <code>primary-priority value</code>                                                                                                                                                                                                                                                                                                                                                                                                                                                                                                                                                                                                                                                                                                                                                                                                                                                                                                                     |
| <b>Parameters</b>        | <i>value</i> — Enter a lower value than the priority value of the remote peer. The range is from 1 to 65535. The default value is 32768.                                                                                                                                                                                                                                                                                                                                                                                                                                                                                                                                                                                                                                                                                                                                                                                                                |
| <b>Default</b>           | 32768.                                                                                                                                                                                                                                                                                                                                                                                                                                                                                                                                                                                                                                                                                                                                                                                                                                                                                                                                                  |
| <b>Command Mode</b>      | VLT-DOMAIN                                                                                                                                                                                                                                                                                                                                                                                                                                                                                                                                                                                                                                                                                                                                                                                                                                                                                                                                              |
| <b>Usage Information</b> | <ul style="list-style-type: none"><li>After you configure a VLT domain on each peer switch and connect the two VLT peers on each side of the VLT interconnect, the system elects a primary and secondary VLT peer device. To configure the primary and secondary roles before the election process, use the <code>primary-priority</code> command. Enter a lower value on the primary peer and a higher value on the secondary peer. If the primary peer fails, the secondary peer (with the higher priority) takes the primary role. If the primary peer (with the lower priority) later comes back online, it is assigned the secondary role; there is no preemption.</li><li>If the priority values configured on the two VLT peers are equal, VLT uses the default primary election mechanism based on the values of the system MAC addresses of the two nodes. The VLT peer with the lowest system MAC address assumes the primary role.</li></ul> |



- If the heartbeat is up and the VLTi link goes down between the VLT peers, both the VLT peers retain their primary and secondary roles. However, the VLT port channel on the secondary VLT peer shuts down.

**NOTE:** When you configure a priority for VLT peers using this command, the configuration does not take effect immediately. The primary priority configuration comes into effect the next time election is triggered.

#### Example

```
OS10(conf-vlt-1)#primary-priority 2
```

#### Supported Releases

10.4.1.0 or later

## show running-configuration vlt

Displays current configuration of all VLT domains.

**Syntax** show running-configuration vlt

**Parameter** None

**Default** Not configured

**Command Mode** EXEC

**Usage Information** None

#### Example

```
OS10# show running-configuration vlt
!
vlt domain 1
 peer-routing
 discovery-interface ethernet1/1/17
!
interface port-channel1
 vlt-port-channel 1
!
interface port-channel2
 vlt-port-channel 2
!
interface port-channel3
 vlt-port-channel 3
```

#### Supported Releases

10.2.0E or later

## show spanning-tree virtual-interface

Displays STP, RPVST+, and MSTP information specific to the VLTi.

**Syntax** show spanning-tree virtual-interface [detail]

**Parameters** detail—(Optional) Displays detailed output.

**Default** Not configured

**Command Mode** EXEC

**Usage Information** None

#### Example

```
OS10# show spanning-tree virtual-interface
VFP(VirtualFabricPort) of RSTP 1 is Designated Forwarding
Edge port: No (default)
Link type: point-to-point (auto)
```

```
Boundary: No, Bpdu-filter: Disable, Bpdu-Guard: Disable, Shutdown-on-Bpdu-Guard-violation: No
Root-Guard: Disable, Loop-Guard: Disable
Bpdus (MRecords) Sent: 11, Received: 7
Interface
Name PortID Prio Cost Sts Cost Bridge ID Designated
PortID

VFP(VirtualFabricPort) 0.1 0 1 FWD 0 32768 0078.7614.6062 0.1
```

```
OS10# show spanning-tree virtual-interface
```

```
VFP(VirtualFabricPort) of vlan 100 is Designated Blocking
Edge port: No (default)
Link type: point-to-point (auto)
Boundary: No, Bpdu-filter: Disable, Bpdu-Guard: Disable, Shutdown-on-Bpdu-Guard-violation: No
Root-Guard: Disable, Loop-Guard: Disable
Bpdus (MRecords) Sent: 7, Received: 9
Interface
Name PortID Prio Cost Sts Cost Bridge ID Designated
PortID

VFP(VirtualFabricPort) 0.1 0 1 BLK 0 4196 90b1.1cf4.a602 0.1
```

### Example (detail)

```
OS10# show spanning-tree virtual-interface detail
Port 1 (VFP(VirtualFabricPort)) of RSTP 1 is designated Forwarding
Port path cost 1, Port priority 0, Port Identifier 0.1
Designated root priority: 32768, address: 00:78:76:14:60:62
Designated bridge priority: 32768, address: 00:78:76:14:60:62
Designated port ID: 0.1, designated path cost: 0
Number of transitions to forwarding state: 1
Edge port: No (default)
Link Type: Point-to-Point
BPDU Sent: 15, Received: 5
```

```
OS10# show spanning-tree virtual-interface detail
Port 1 (VFP(VirtualFabricPort)) of vlan1 is designated Forwarding
Port path cost 1, Port priority 0, Port Identifier 0.1
Designated root priority: 4097, address: 90:b1:1c:f4:a6:02
Designated bridge priority: 4097, address: 90:b1:1c:f4:a6:02
Designated port ID: 0.1, designated path cost: 0
Number of transitions to forwarding state: 1
Edge port: No (default)
Link Type: Point-to-Point
BPDU Sent: 202, Received: 42
Port 1 (VFP(VirtualFabricPort)) of vlan100 is designated Forwarding
Port path cost 1, Port priority 0, Port Identifier 0.1
Designated root priority: 4196, address: 90:b1:1c:f4:a6:02
Designated bridge priority: 4196, address: 90:b1:1c:f4:a6:02
Designated port ID: 0.1, designated path cost: 0
Number of transitions to forwarding state: 1
Edge port: No (default)
Link Type: Point-to-Point
BPDU Sent: 101, Received: 21
```

### Example (MSTP information)

```
OS10# show spanning-tree virtual-interface
VFP(VirtualFabricPort) of MSTI 0 is Designated Forwarding
Edge port: No (default)
Link type: point-to-point (auto)
Boundary: Yes, Bpdu-filter: Disable, Bpdu-Guard: Disable, Shutdown-on-Bpdu-Guard-violation: No
Root-Guard: Disable, Loop-Guard: Disable
Bpdus (MRecords) Sent: 387, Received: 16
Interface
Name PortID Prio Cost Sts Cost Bridge ID Designated
PortID

VFP(VirtualFabricPort) 0.1 0 1 FWD 0 32768 3417.ebf2.a8c4 0.1

VLT-LAG -1(vlt-portid-1) of MSTI 0 is in Designated Forwarding
Edge port: No (default)
Link type: point-to-point (auto)
Boundary: No, Bpdu-filter: Disable, Bpdu-Guard: Disable,
Shutdown-on-Bpdu-Guard-violation: No
Root-Guard: Disable, Loop-Guard: Disable
Bpdus (MRecords) Sent: 1234, Received: 123

Virtual
Interface
Name PortID Prio Cost Sts Cost Bridge ID Designated
PortID

VLT-LAG -1(vlt-portid1) 128.2001 128 2000000 FWD 0 32768 90b1.1cf4.a523 128.2001
```

## Example (MSTP information on VLT)

```
OS10# show spanning-tree virtual-interface detail
Port 1 (VFP(VirtualFabricPort)) of MSTI 0 is designated Forwarding
Port path cost 0, Port priority 128, Port Identifier 128.1
Designated root priority: 32768, address: 34:17:44:55:66:7f
Designated bridge priority: 32768, address: 90:b1:1c:f4:a5:23
Designated port ID: 128.1, designated path cost: 0
Number of transitions to forwarding state: 1
Edge port: No (default)
Link Type: Point-to-Point
BPDU Sent: 2714, Received: 1234

Port 2001 (VLT-LAG -1(vlt-portid-1)) of MSTI 0 is designated Forwarding
Port path cost 200000, Port priority 128, Port Identifier 128.2001
Designated root priority: 32768, address: 34:17:44:55:66:7f
Designated bridge priority: 32768, address: 90:b1:1c:f4:a5:23
Designated port ID: 128.2001, designated path cost: 0
Number of transitions to forwarding state: 1
Edge port: No (default)
Link Type: Point-to-Point
BPDU Sent: 2714, Received: 1234
```

## Supported Releases

10.3.0E or later

## show vlt

Displays information on a VLT domain.

### Syntax

```
show vlt domain-id delay-restore-orphan-port
```

### Parameter

- *domain-id* — Enter a VLT domain ID, from 1 to 255.
- *delay-restore orphan-port* - Enter the *delay-restore orphan-port* keyword to display the delay-restore orphan-port status.

### Default

Not configured

### Command Mode

EXEC

### Usage Information

In the following example, the status of the VLT node should be up. If you see the *role* for this VLT node listed as *primary*, the role on the peer node should be listed as *secondary*.

### Example

```
OS10# show vlt 255
Domain ID : 255
Unit ID : 1
Role : primary
Version : 2.0
Local System MAC address : 34:17:eb:3a:bd:80
Role priority : 1
VLT MAC address : aa:bb:cc:dd:ee:ff
IP address : fda5:74c8:b79e:1::1
Delay-Restore timer : 100 seconds
Peer-Routing : Enabled
Peer-Routing-Timeout timer : 9999 seconds
VLTi Link Status
 port-channell1000 : up

VLT Peer Unit ID System MAC Address Status IP Address Version

 2 34:17:eb:3a:c2:80 up fda5:74c8:b79e:1::2 2.0

WHEN VLT DELAY-RESTORE TIMER IS RUNNING:

OUTPUT1 - Configurations enabled on discontinuous interfaces
OS10# show vlt 1 delay-restore-orphan-port
```

```

VLT Delay-Restore timer : 90 seconds
Remaining time : 60 seconds
Delay-Restore Orphan-Port enabled interfaces :
Eth1/1/10-1/1/15,1/1/17,1/1/20
Po10-15,17,20
Delay-Restore Orphan-Port Ignore VLTi Fail enabled interfaces :
Eth1/1/12-1/1/14,1/1/20
Po10-12,Po17

WHEN DELAY-RESTORE TIMER HAS EXPIRED/NOT-RUNNING:
OS10# show vlt 1 delay-restore-orphan-port
VLT Delay-Restore timer : 90 seconds
Delay-Restore Orphan-Port enabled interfaces : Eth1/1/8
Eth1/1/10
Po1
Po4
Delay-Restore Orphan-Port Ignore VLTi Fail enabled interfaces : Eth1/1/10
Po4

```

**Supported Releases** 10.2.0E or later

## show vlt backup-link

Displays detailed status of the heartbeat

**Syntax** `show vlt domain-id backup-link`

**Parameters** *domain-id* — Enter the VLT domain ID.

**Default** Not configured

**Command Mode** EXEC

**Usage Information** None

### Example

```

OS10# show vlt 255 backup-link
VLT Backup Link

Destination : 10.16.208.164
Peer Heartbeat status : Up
Heartbeat interval : 1
Heartbeat timeout : 3

```

**Supported Releases** 10.3.1E or later

## show vlt mac-inconsistency

Displays inconsistencies in dynamic MAC addresses learned between VLT peers across spanned-VLANs.

**Syntax** `show vlt mac-inconsistency`

**Parameters** None

**Default** Not configured

**Command Mode** EXEC

**Usage Information** Use this command to check for a mismatch of MAC address table entries between VLT peers. Use this command only when you observe network convergence issues. To verify VLT configuration mismatch issues on peer switches, use the `show vlt domain-name mismatch` command.

Use this command if there are traffic convergence issues.

### Example

```
OS10# show vlt-mac-inconsistency
Checking Vlan 228 .. Found 7 inconsistencies .. Progress 100%
VLAN 128

MAC 00:00:00:00:00:02 is missing from Node(s) 2
VLAN 1

MAC 00:a0:c9:00:00:18 is missing from Node(s) 2
MAC 00:a0:c9:00:00:20 is missing from Node(s) 2
VLAN 131

MAC 00:00:00:00:00:02 is missing from Node(s) 2
VLAN 132

MAC 00:00:00:00:00:02 is missing from Node(s) 2
VLAN 135

MAC 00:00:00:00:00:02 is missing from Node(s) 2
VLAN 137

MAC 00:00:00:00:00:02 is missing from Node(s) 2

Run "show vlt mismatch ..." commands to identify configuration issues
```

**Supported Releases** 10.2.0E or later

## show vlt mismatch

Displays mismatches in a VLT domain configuration.

**Syntax** `show vlt id mismatch [dhcp-snooping | peer-routing | vlan | vlt-vlan vlt-port-id | relay]`

### Parameters

- `id` — Enter the VLT domain ID, from 1 to 255.
- `dhcp-snooping` — Display mismatches in a DHCP snooping configuration in a VLT domain.
- `peer-routing` — Display mismatches in the peer-routing configuration.
- `vlan` — Display mismatches in a VLAN configuration in the VLT domain.
- `vlt-vlan vlt-port-id` — Display mismatches in the VLT port configuration, from 1 to 4095.
- `virtual-network` — Display mismatches in virtual network configurations between VLT peers.
- `dhcp-relay` — Displays the mismatch (if any) between the VLT peers for DHCP relay options configuration across the VLT peers.

**Default** Not configured

**Command Mode** EXEC

**Usage Information**

The \* in the mismatch output indicates a local node entry.

The show vlt mismatch dhcp-relay command displays the mismatch in the global ip dhcp-relay information-option command.

The show vlt mismatch dhcp-relay command displays the presence or absence of interface level ip dhcp-relay information-option command.

**Example (no mismatch)**

```
OS10# show vlt 1 mismatch
Peer-routing mismatch:
No mismatch

VLAN mismatch:
No mismatch

VLT VLAN mismatch:
No mismatch
```

**Example (mismatch)**

```
OS10# show vlt 1 mismatch
Peer-routing mismatch:
VLT Unit ID Peer-routing

* 1 Enabled
 2 Disabled

VLAN mismatch:
No mismatch

VLT VLAN mismatch:
VLT ID : 1
VLT Unit ID Mismatch VLAN List

* 1 1
 2 2
VLT ID : 2
VLT Unit ID Mismatch VLAN List

* 1 1
 2 2
```

**Example (mismatch peer routing)**

```
OS10# show vlt 1 mismatch peer-routing
Peer-routing mismatch:
VLT Unit ID Peer-routing

* 1 Enabled
 2 Disabled
```

**Example (mismatch VLAN)**

```
OS10# show vlt 1 mismatch vlan
VLT Unit ID Mismatch VLAN List

* 1 -
 2 4
```

**Example (mismatch VLT VLAN)**

```
OS10# show vlt 1 mismatch vlt-vlan
VLT ID : 1
VLT Unit ID Mismatch VLAN List

* 1 1
 2 2
VLT ID : 2
VLT Unit ID Mismatch VLAN List

* 1 1
 2 2
```

**Example  
(mismatch —  
Virtual Network  
(VN) name not  
available in the  
peer)**

```
OS10# show vlt all mismatch virtual-network
Virtual Network Name Mismatch:
VLT Unit ID Mismatch Virtual Network List

1 10,104
* 2 -
```

**Example  
(mismatch of  
VLTi and VLAN)**

```
OS10# show vlt all mismatch virtual-network
Virtual Network: 100
VLT Unit ID Configured VLTi-Vlans

1 101
* 2 100
```

**Example  
(mismatch of VN  
mode)**

```
OS10# show vlt all mismatch virtual-network
Virtual Network: 102
VLT Unit ID Configured Virtual Network Mode

1 PV
* 2 Attached
```

**Example  
(mismatch of  
port and VLAN  
list)**

```
OS10# show vlt all mismatch virtual-network
Virtual Network: 102
VLT Unit ID Mismatch (VLT Port,Vlan) List

1 -
* 2 (vlt-port-channel10,vlan99)

Virtual Network: 103
VLT Unit ID Mismatch (VLT Port,Vlan) List

1 (vlt-port-channel10,vlan103)
* 2 (vlt-port-channel10,vlan104)
```

**Example  
(mismatch of  
untagged  
interfaces)**

```
OS10# show vlt all mismatch virtual-network
Virtual Network: 104
VLT Unit ID Mismatch Untagged VLT Port-channel List

1 10
* 2 -
```

**Example  
(Anycast MAC  
address)**

```
show vlt 1 mismatch virtual-network

Interface virtual-network Anycast-mac mismatch:
VLT Unit ID Anycast-MAC

1 00:01:02:03:04:051
* 2 00:01:02:03:04:055
```

**Example  
(Anycast MAC  
address not  
available on one  
of the peers)**

```
show vlt 1 mismatch virtual-network

Interface virtual-network Anycast-mac mismatch:
VLT Unit ID Anycast-MAC

1 00:01:02:03:04:051
* 2 -
```

**Example (Virtual  
network  
interface anycast  
IP address)**

```
show vlt 1 mismatch virtual-network

Interface virtual-network Anycast-IP mismatch:
```

```

Virtual-network: 10
VLT Unit ID Anycast-IP

 1 10.16.128.25
* 2 10.16.128.20

Virtual-network: 20
VLT Unit ID Anycast-IP

 1 10.16.128.26
* 2 10.16.128.30

```

**Example  
(Anycast IP  
addresses not  
configured on  
one of the virtual  
networks on both  
peers)**

```

show vlt 1 mismatch virtual-network
Interface virtual-network Anycast-IP mismatch:

Virtual-network: 10
VLT Unit ID Anycast-IP

 1 10.16.128.25
* 2 ABSENT

Virtual-network: 20
VLT Unit ID Anycast-IP

 1 ABSENT
* 2 10.16.128.30

```

**Example (Virtual  
network  
mismatch and  
Anycast IP  
addresses  
mismatch)**

```

Interface virtual-network Anycast-IP mismatch:

Virtual-network: 10
VLT Unit ID Anycast-IP

 1 10.16.128.25
* 2 10.16.128.20

Virtual-network: 20
VLT Unit ID Anycast-IP

 1 10.16.128.26
* 2 ABSENT

Virtual-network: 30
VLT Unit ID Anycast-IP

 1 ABSENT
* 2 10.16.128.30

```

**Example  
(Displays  
multicast routing  
mismatches)**

```

OS10# show vlt mismatch
Multicast routing mismatches:

PIM spanned status

Vlan status V4 V6
VlanId Local Peer Local Peer
Vlan 5 Inactive Active Inactive Inactive
Vlan 25 Active Inactive Inactive Active

```



**Example  
(mismatch dhcp-relay)**

```
OS10# show vlt 1 mismatch dhcp-relay
DHCP Relay Mismatch:
Global Relay Configuration Mismatch

VLT Unit ID Option-82 Link-Selection Server-Override VSS

* 1 Enabled - - -
- 2 Disabled - -
Interface Relay Configuration Mismatch

Interface: virtual-network10000
VLT Unit ID Option-82 Server-Override VSS Source

* 1 Disabled - - -
- 2 Enabled - -
- - - - -
OS10#
```

**Supported  
Releases**

10.2.0E or later

## show vlt role

Displays the VLT role of the local peer.

**Syntax** `show vlt id role`**Parameters** *id* — Enter the VLT domain ID, from 1 to 255.**Default** Not configured**Command Mode** EXEC**Usage Information** The \* in the mismatch output indicates a local mismatch.**Example**

```
OS10# show vlt 1 role
VLT Unit ID Role

* 1 primary
 2 secondary
```

**Supported  
Releases**

10.2.0E or later

## show vlt vlt-port-detail

Displays detailed status information about the VLT ports.

**Syntax** `show vlt id vlt-port-detail`**Parameters** *id* — Enter a VLT domain ID, from 1 to 255.**Default** Not configured**Command Mode** EXEC**Usage Information** The \* in the mismatch output indicates a local mismatch.**Example**

```
OS10# show vlt 1 vlt-port-detail
Vlt-port-channel ID : 1
```

| VLT Unit ID | Port-Channel  | Status | Configured ports | Active ports |
|-------------|---------------|--------|------------------|--------------|
| * 1         | port-channel1 | down   | 2                | 0            |
| 2           | port-channel1 | down   | 2                | 0            |
| VLT ID : 2  |               |        |                  |              |
| VLT Unit ID | Port-Channel  | Status | Configured ports | Active ports |
| * 1         | port-channel2 | down   | 1                | 0            |
| 2           | port-channel2 | down   | 1                | 0            |
| VLT ID : 3  |               |        |                  |              |
| VLT Unit ID | Port-Channel  | Status | Configured ports | Active ports |
| 2           | port-channel3 | down   | 1                | 0            |

**Supported Releases** 10.2.0E or later

## vlt-domain

Creates a VLT domain.

**Syntax** `vlt-domain domain-id`

**Parameter** `domain-id` — Enter a VLT domain ID on each peer, from 1 to 255.

**Default** None

**Command Mode** CONFIGURATION

**Usage Information** Configure the same VLT domain ID on each peer. If a VLT domain ID mismatch occurs on VLT peers, the VLTi link between peers does not activate. The `no` version of this command disables VLT.

**Example**

```
OS10(config)# vlt-domain 1
```

**Supported Releases** 10.2.0E or later

## vlt-port-channel

Configures the ID used to map interfaces on VLT peers into a single VLT port-channel.

**Syntax** `vlt-port-channel vlt-port-channel-id`

**Parameters** `vlt-port-channel-id` — Enter a VLT port-channel ID, from 1 to 128.

**Default** Not configured

**Command Mode** PORT-CHANNEL INTERFACE

**Usage Information** Assign the same VLT port-channel ID to interfaces on VLT peers to create a VLT port-channel. The `no` version of this command removes the VLT port-channel ID configuration.

**Example (peer 1)**

```
OS10(conf-if-po-10)# vlt-port-channel 1
```

**Example (peer 2)**

```
OS10(conf-if-po-20)# vlt-port-channel 1
```

**Supported Releases** 10.2.0E or later

## vlt-mac

Configures a MAC address for all peer switches in a VLT domain.

|                           |                                                                                                                                                                                                                                                                                                                                                                                                                                                                                                                                                                                                                                                                                                                     |
|---------------------------|---------------------------------------------------------------------------------------------------------------------------------------------------------------------------------------------------------------------------------------------------------------------------------------------------------------------------------------------------------------------------------------------------------------------------------------------------------------------------------------------------------------------------------------------------------------------------------------------------------------------------------------------------------------------------------------------------------------------|
| <b>Syntax</b>             | <code>vlt-mac mac-address</code>                                                                                                                                                                                                                                                                                                                                                                                                                                                                                                                                                                                                                                                                                    |
| <b>Parameters</b>         | <code>mac-address</code> — Enter a MAC address for the topology in nn:nn:nn:nn:nn:nn format.                                                                                                                                                                                                                                                                                                                                                                                                                                                                                                                                                                                                                        |
| <b>Default</b>            | Not configured                                                                                                                                                                                                                                                                                                                                                                                                                                                                                                                                                                                                                                                                                                      |
| <b>Command Mode</b>       | VLT-DOMAIN                                                                                                                                                                                                                                                                                                                                                                                                                                                                                                                                                                                                                                                                                                          |
| <b>Usage Information</b>  | <p>Use this command to minimize the time required to synchronize the default MAC address of the VLT domain on both peer devices when one peer switch reboots. If you do not configure a VLT MAC address, the MAC address of the primary peer is used as the VLT MAC address across all peers. This configuration must be symmetrical in all the peer switches to avoid any unpredictable behavior. For example, unit down or VLTi reset. The <code>no</code> version of this command disables the VLT MAC address configuration.</p> <p><b>NOTE:</b> Configure the VLT MAC address as symmetrical in all the VLT peer switches to avoid any unpredictable behavior when any unit is down or when VLTi is reset.</p> |
| <b>Example</b>            | <pre>OS10(conf-vlt-1)# vlt-mac 00:00:00:00:00:02</pre>                                                                                                                                                                                                                                                                                                                                                                                                                                                                                                                                                                                                                                                              |
| <b>Supported Releases</b> | 10.2.0E or later                                                                                                                                                                                                                                                                                                                                                                                                                                                                                                                                                                                                                                                                                                    |

## vrrp mode active-active

Enables the VRRP peers to locally forward L3 traffic in a VLAN interface.

|                           |                                                                                                                                                                                                                                                                                                                                                                                              |
|---------------------------|----------------------------------------------------------------------------------------------------------------------------------------------------------------------------------------------------------------------------------------------------------------------------------------------------------------------------------------------------------------------------------------------|
| <b>Syntax</b>             | <code>vrrp mode active-active</code>                                                                                                                                                                                                                                                                                                                                                         |
| <b>Parameters</b>         | None                                                                                                                                                                                                                                                                                                                                                                                         |
| <b>Default</b>            | Enabled                                                                                                                                                                                                                                                                                                                                                                                      |
| <b>Command Mode</b>       | VLAN INTERFACE                                                                                                                                                                                                                                                                                                                                                                               |
| <b>Usage Information</b>  | <p>This command is applicable only for VLAN interfaces.</p> <p>In a non-VLT network, the backup VRRP gateway forwards L3 traffic. If you want to use VRRP groups on VLANs without VLT topology, disable the Active-Active functionality, to ensure that only the active VRRP gateway forwards L3 traffic.</p> <p>The <code>no</code> version of this command disables the configuration.</p> |
| <b>Example</b>            | <pre>OS10(conf-if-vl-10)# vrrp mode active-active</pre>                                                                                                                                                                                                                                                                                                                                      |
| <b>Supported Releases</b> | 10.2.0E or later                                                                                                                                                                                                                                                                                                                                                                             |

## Uplink Failure Detection

Uplink failure detection (UFD) indicates the loss of upstream connectivity to servers connected to the switch.

A switch provides upstream connectivity for devices, such as servers. If the switch loses upstream connectivity, the downstream devices also lose connectivity. However, the downstream devices do not generally receive an indication that the upstream connectivity was lost because connectivity to the switch is still operational. To solve this issue, use UFD.

UFD associates downstream interfaces with upstream interfaces. When upstream connectivity fails, the switch operationally disables its downstream links. Failures on the downstream links allow downstream devices to recognize the loss of upstream connectivity. This allows the downstream servers to select alternate paths, if available, to send traffic to upstream devices.

UFD creates an association between upstream and downstream interfaces known as *uplink-state group*. An interface in an uplink-state group can be a physical Ethernet or fibre channel interface or a port-channel.

An enabled uplink-state group tracks the state of all assigned upstream interfaces. The failure of upstream interfaces results in automatic disabling of downstream interfaces in the uplink-state group, as shown in the following illustration. If only one of the upstream interfaces in an uplink-state group goes down, a specific number of downstream interfaces in the same uplink-state group go down. You can configure the number of downstream interfaces that go down based on the traffic conditions from the server to the upstream interfaces. This avoids overloading traffic on upstream ports.

By default, if all the upstream interfaces in an uplink-state group go down, all the downstream interfaces in the same uplink-state group are set into a link-down state.

In addition, in an uplink-state group, you can configure automatic recovery of downstream ports when there is a change in the link status of uplink interfaces.

You can also bring up downstream interfaces that are in an UFD-disabled error state manually.

### UFD Topology

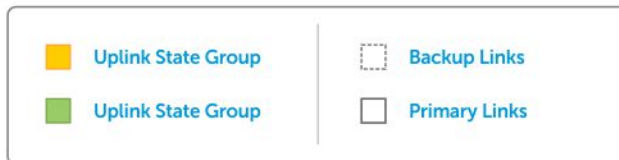
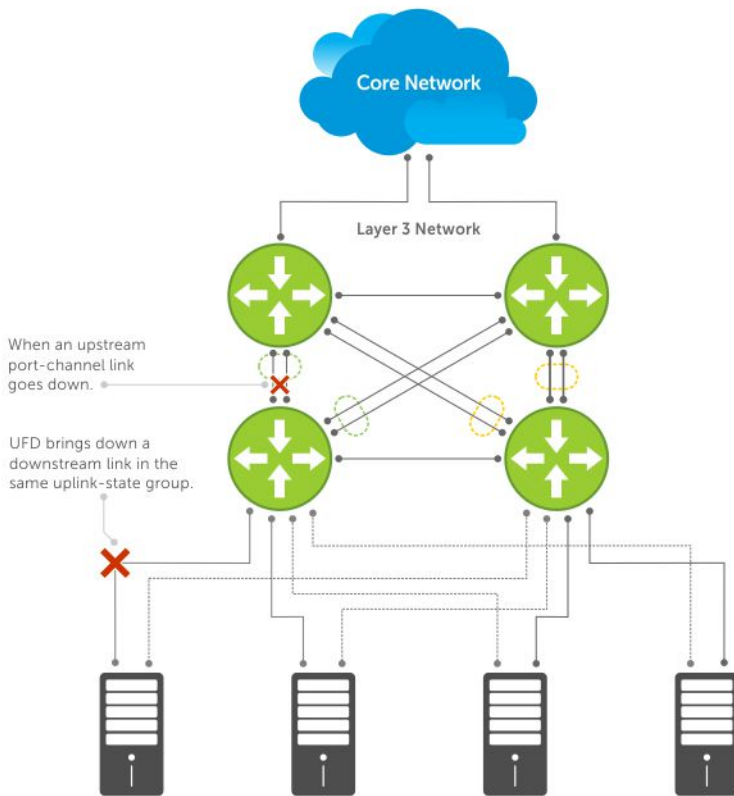

## Configure uplink failure detection

Consider the following before configuring an uplink-state group:

- An uplink-state group is considered to be operationally up if it has at least one upstream interface in the Link-Up state.
- An uplink-state group is considered to be operationally down if it has no upstream interfaces in the Link-Up state.
- You can assign a physical port or a port channel to an uplink-state group.
- You can assign an interface to only one uplink-state group at a time.
- You can designate the uplink-state group as either an upstream or downstream interface, but not both.
- You can configure multiple uplink-state groups and operate them concurrently.
- You cannot assign both a port channel and its members to an uplink-state group, which would make the group inactive. The port channels and individual ports that are not part of any port channel can coexist as members of an uplink-state group.
- If one of the upstream interfaces in an uplink-state group goes down, you can set the downstream ports in an operationally down state with an *UFD Disabled error* status. You can configure the system to disable either a user-configurable set of downstream ports or all the downstream ports in the group.
- The downstream ports are disabled in order starting from the lowest numbered port to the highest numbered port.
- When an upstream interface in an uplink-state group that was down comes up, the set of UFD-disabled downstream ports that were down due to that particular upstream interface are brought up, and the *UFD Disabled error* clears in those downstream ports.
- If you disable an uplink-state group, the downstream interfaces are not disabled, regardless of the state of the upstream interfaces.

- If you do not assign upstream interfaces to an uplink-state group, the downstream interfaces are not disabled.

### Configuration:

1. Create an uplink-state group in CONFIGURATION mode.

```
uplink-state-group group-id
```

2. Configure the upstream and downstream interfaces in UPLINK-STATE-GROUP mode.

```
upstream {interface-type | interface-range[track-vlt-status] | VLTi}
downstream {interface-type | interface-range}
```

3. (Optional) Disable uplink-state group tracking in UPLINK-STATE-GROUP mode.

```
no enable
```

4. (Optional) Provide a descriptive name for the uplink-state group in UPLINK-STATE-GROUP mode.

```
name string
```

5. Configure the number of downstream interfaces to disable, when an upstream interface goes down in UPLINK-STATE-GROUP mode.

```
downstream disable links{number | all}
```

6. (Optional) Enable auto-recovery of downstream interfaces that are disabled in UPLINK-STATE-GROUP mode.

```
downstream auto-recover
```

7. (Optional) Configure the timer to defer the UFD actions on downstream ports in UPLINK-STATE-GROUP mode. When you have configured to track the VLT status in a VLT network, if VLT port-channel is an upstream member of uplink-state group, then the defer timer triggers when the VLT status goes operationally down instead of the operational status of the peer port-channel.

```
defer-time timer
```

8. (Optional) Clear the UFD error disabled state of downstream interfaces in EXEC mode.

```
clear ufd-disable
```

### Configure uplink state group

```
OS10(config)# uplink-state-group 1
OS10(conf-uplink-state-group-1)# upstream ethernet 1/1/7:1
OS10(conf-uplink-state-group-1)# downstream ethernet 1/1/1-1/1/5
OS10(conf-uplink-state-group-1)# downstream ethernet 1/1/9:2-1/1/9:3
OS10(conf-uplink-state-group-1)# enable
OS10(conf-uplink-state-group-1)# name UFDGROUP1
OS10(conf-uplink-state-group-1)# defer-time 10
OS10(conf-uplink-state-group-1)# no downstream auto-recover
OS10(conf-uplink-state-group-1)# downstream disable links 2
```

### View uplink state group configuration

```
OS10#show uplink-state-group 1

Uplink State Group: 1 Status: Enabled,down
```

```
OS10# show uplink-state-group 1 detail

(Up): Interface up (Dwn): Interface down (Dis): Interface disabled

Uplink State Group : 1 Status : Enabled,up Name : UFDGROUP1
Defer Time : 10 second(s)
Upstream Interfaces : Eth 1/1/7:1(Up)
Downstream Interfaces: Eth 1/1/1(Dwn) Eth 1/1/2(Dwn) Eth 1/1/3(Dwn) Eth 1/1/4(Dwn)
```

```
Eth 1/1/5(Dwn) Eth 1/1/9:2(Dwn) Eth 1/1/9:3(Dwn)
```

```
OS10#show uplink-state-group 1 detail
```

```
(Up): Interface up (Dwn): Interface down (Dis): Interface disabled (NA): Not Available
```

```
*: VLT port-channel, V: VLT status, P: Peer Operational status ^: Tracking status
```

```
Uplink State Group : 1 Name: iscsi_group, Status: Enabled, Up
Upstream Interfaces : eth1/1/35(Up) *po10(V:Up, ^P:Dwn) VLTi(NA)
Downstream Interfaces : eth1/1/2(Up) *po20(V: Up,P: Up)
```

```
OS10#show uplink-state-group 2 detail
```

```
(Up): Interface up (Dwn): Interface down (Dis): Interface disabled (NA): Not Available
```

```
*: VLT port-channel, V: VLT status, P: Peer Operational status ^: Tracking status
```

```
Uplink State Group : 1 Name: iscsi_group, Status: Enabled, Up
Upstream Interfaces : eth1/1/36(Up) *po30(^V:Up, P:Dwn) VLTi(Up)
Downstream Interfaces : eth1/1/4(Up) *po20(V: Up,P: Up)
```

```
OS10(conf-uplink-state-group-1)# show configuration
```

```
!
uplink-state-group 1
 downstream ethernet1/1/1-1/1/5
 downstream ethernet1/1/9:2-1/1/9:3
 upstream ethernet1/1/7:1
```

## Uplink failure detection on VLT

When you create uplink-state group in a switch operating in VLT mode, ensure that all the nodes in the VLT setup have same configuration for uplink state groups with VLT port-channel as member. If both the VLT peers do not have the same UFD configuration, the UFD does not work properly.

When you configure VLT port-channel as upstream member in the uplink state group and configure to track the VLT status, the system tracks the fabric Status of VLT. When the fabric status goes down, the uplink state group in each VLT node disables the downstream VLT port-channel local to the node.

When you configure to track the VLT status, the system places the downstream members of the Uplink State Group in error disabled state or clears them from the error disabled state based on the operational status of the VLT port-channel.

When you do not track the VLT status, the system tracks the operational status of port-channel.

Track the VLT status using the `upstream interface-type track-vlt-status` command in UPLINK-STATE-GROUP mode.

To configure VLTi link as member of Uplink State Group, use the `upstream VLTi` command in UPLINK-STATE-GROUP mode. You cannot configure VLTi Link as downstream member in an uplink-state group as UFD may disable the VLTi Link when the upstream members are operationally down. You cannot track the VLT status for an upstream VLTi member.

The following table describes various scenarios when you apply UFD on a VLT network:

**Table 92. UFD on VLT network**

| Event                                             | VLT action on primary node | VLT action on secondary node                                                                               | UFD action                                                                                                                  |
|---------------------------------------------------|----------------------------|------------------------------------------------------------------------------------------------------------|-----------------------------------------------------------------------------------------------------------------------------|
| VLTi Link is operationally down with heartbeat up | No action                  | VLT module sends VLT port-channel disable request to Interface Manager (IFM) for both uplink and downlink. | UFD receives operationally down of upstream VLT port-channel and sends error-disable of downstream VLT port-channel to IFM. |

**Table 92. UFD on VLT network (continued)**

| <b>Event</b>                                                                                                 | <b>VLT action on primary node</b>                           | <b>VLT action on secondary node</b>                                                                                                     | <b>UFD action</b>                                                                                                                                                                                                                                                   |
|--------------------------------------------------------------------------------------------------------------|-------------------------------------------------------------|-----------------------------------------------------------------------------------------------------------------------------------------|---------------------------------------------------------------------------------------------------------------------------------------------------------------------------------------------------------------------------------------------------------------------|
| VLTi Link is operationally up with heartbeat up                                                              | No action                                                   | VLT module sends VLT port-channel enable request to Interface Manager (IFM) for both uplink and downlink.                               | UFD receives operationally up of upstream VLT port-channel and sends clear error-disable of downstream VLT port-channel to IFM.                                                                                                                                     |
| Reboot of VLT secondary peer                                                                                 | No action                                                   | After reboot, runs the delay restore timer. Both the upstream and downstream VLT port-channel remains disabled until the timer expires. | UFD error-disables the downstream VLT port-channel as the upstream VLT port-channel is operationally down. After the timer expires, UFD receives operationally up of upstream VLT port-channel and sends clear error-disable of downstream VLT port-channel to IFM. |
| Reboot of VLT primary peer                                                                                   | Primary becomes secondary peer and runs delay restore timer | Secondary becomes primary                                                                                                               | UFD error-disables the downstream VLT port-channel as the upstream VLT port-channel is operationally down. After the timer expires, UFD receives operationally up of upstream VLT port-channel and sends clear error-disable of downstream VLT port-channel to IFM. |
| Discovery interface added to UFD group                                                                       | Invalid configuration                                       | Invalid configuration                                                                                                                   | Invalid configuration                                                                                                                                                                                                                                               |
| UFD group member configured as discovery interface                                                           | Invalid configuration                                       | Invalid configuration                                                                                                                   | Invalid configuration                                                                                                                                                                                                                                               |
| UFD group member made as VLT port-channel                                                                    | No action                                                   | No action                                                                                                                               | UFD uses fabric status to track the UFD group status.                                                                                                                                                                                                               |
| VLT port-channel added as member of UFD group                                                                | No action                                                   | No action                                                                                                                               | UFD uses fabric status to track the UFD group status.                                                                                                                                                                                                               |
| VLT port-channel configuration removed from the port-channel interface which is upstream member of UFD group | No action                                                   | No action                                                                                                                               | Stops tracking the fabric status for the UFD group. Starts tracking the local port-channel operational status, which is upstream member of the UFD group.                                                                                                           |
| Fabric Status is operationally up                                                                            | No action                                                   | No action                                                                                                                               | Enables the downstream members, that is clears the error-disabled state.                                                                                                                                                                                            |
| Fabric Status is operationally down                                                                          | No action                                                   | No action                                                                                                                               | Disables the downstream members, that is sets the error-disabled state.                                                                                                                                                                                             |



## Sample configurations of UFD on VLT

The following examples show some of the uplink-state groups on VLT.

In the following illustration, both the upstream and downstream members are part of VLT port-channels. The uplink-state group includes both the VLT port-channels as members.

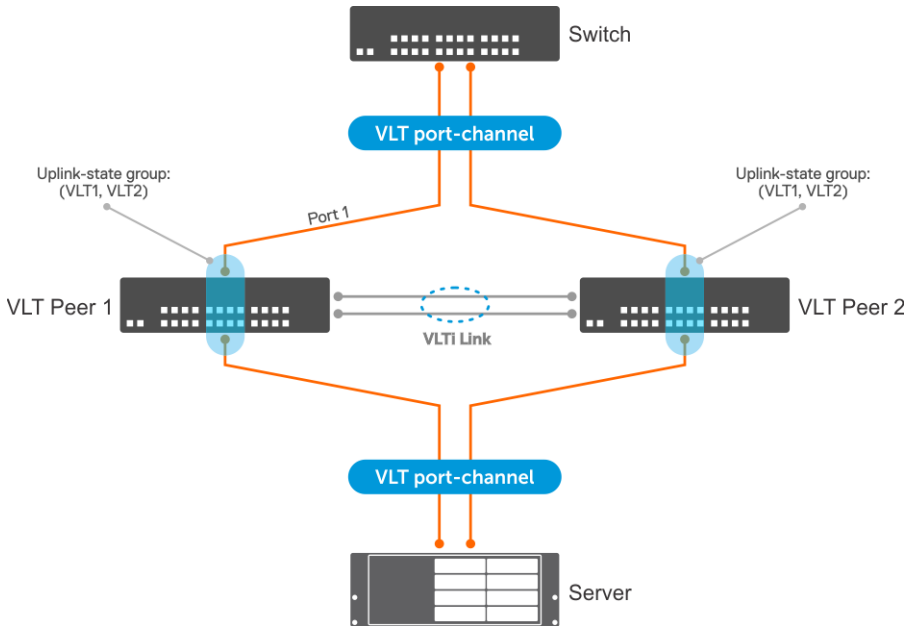

In the following example, the upstream member is part of VLT port-channel and the downstream member is an orphan port. The uplink-state group includes the VLT port-channel, VLT node, and the downstream port. The configuration is symmetric on both the VLT nodes.

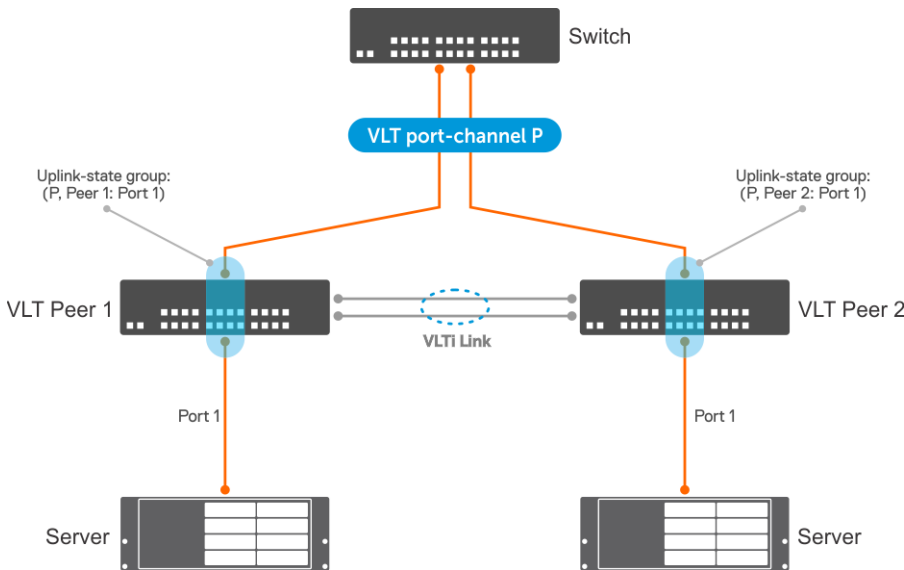

In the following example, the downstream member is part of VLT port-channel and the upstream member is an orphan port. The uplink-state group includes the VLT port-channel, VLT node, and the upstream port. The configuration is symmetric on both the VLT nodes.

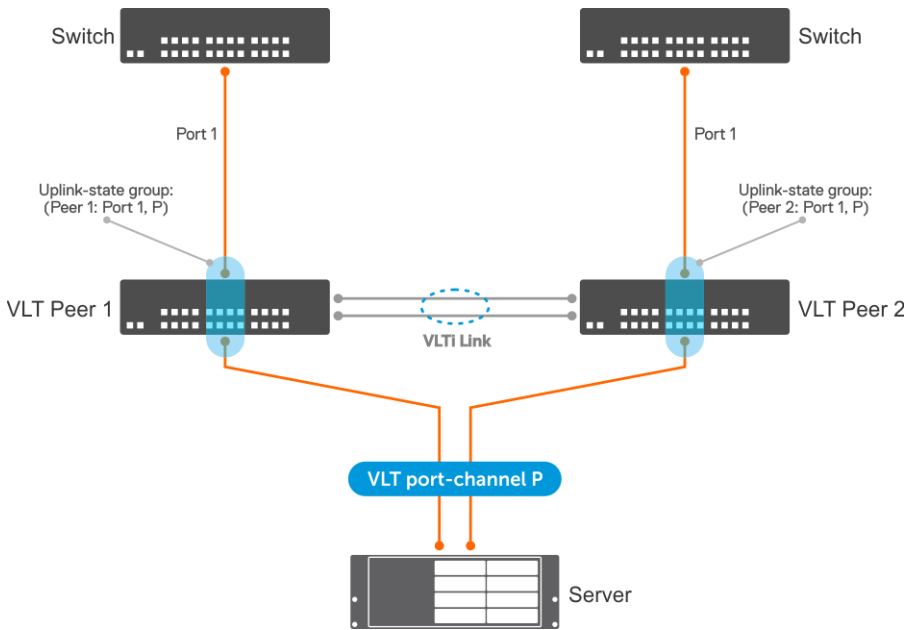

OS10 does not support adding a VLTi link member to the uplink-state group. You can add the VLTi link as upstream member to an uplink-state group using the `upstream VLTi` command. If the VLTi link is not available in the system, OS10 allows adding the VLTi link as an upstream member. In this case, UFD starts tracking the operational status of the VLTi link when the link is available. Until the VLTi link is available, the `show uplink-state-group details` command displays the status of the link as `NA`.

In the following example, both the VLT port-channel connected to the switch and the VLTi Link are upstream members. The VLT port-channel connected to the server is a downstream member. The UFD tracks the operational status of the peer port-channel.

**NOTE:** You cannot configure a VLTi link as a downstream member in an uplink-state group. If you configure, UFD disables the VLTi link when the upstream members are operationally down, which affects the VLT functionality.

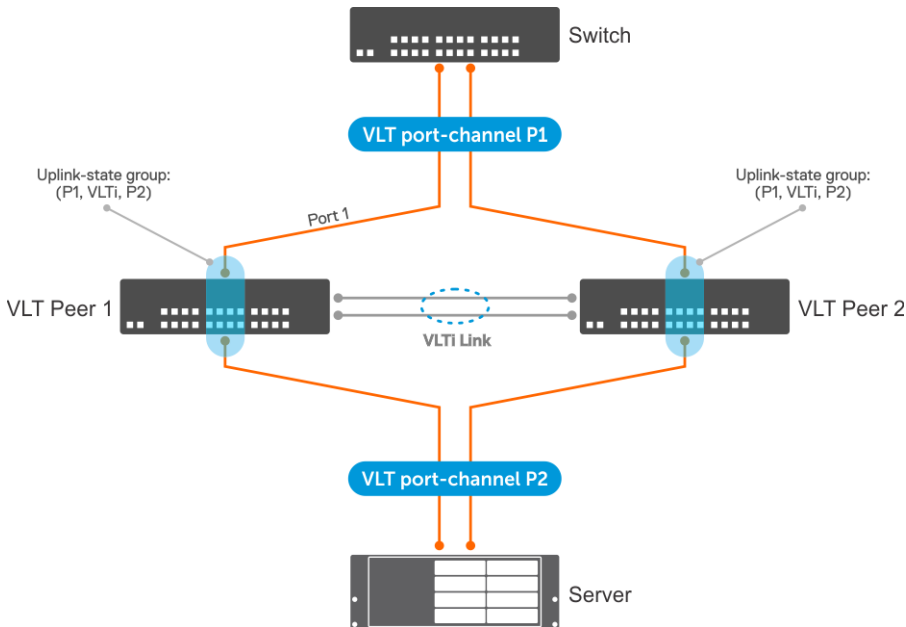

# UFD commands

## clear ufd-disable

Overrides the uplink-state group configuration and brings up the downstream interfaces.

|                           |                                                                                                                                                                                                                                                                                                                                               |
|---------------------------|-----------------------------------------------------------------------------------------------------------------------------------------------------------------------------------------------------------------------------------------------------------------------------------------------------------------------------------------------|
| <b>Syntax</b>             | <code>clear ufd-disable {interface <i>interface-type</i>   uplink-state-group <i>group-id</i>}</code>                                                                                                                                                                                                                                         |
| <b>Parameters</b>         | <ul style="list-style-type: none"><li>• <i>interface-type</i> — Enter the interface type.</li><li>• <i>group-id</i> — Enter the uplink state group ID, from 1 to 32.</li></ul>                                                                                                                                                                |
| <b>Default</b>            | None                                                                                                                                                                                                                                                                                                                                          |
| <b>Command Mode</b>       | EXEC                                                                                                                                                                                                                                                                                                                                          |
| <b>Usage Information</b>  | This command manually brings up a disabled downstream interface that is in an UFD-disabled error state. After the downstream interface is up, it is not disabled until there are changes in the upstream interfaces. This command does not affect downstream interfaces that are already up or interfaces that are not part of the UFD group. |
| <b>Example</b>            | <pre>OS10# clear ufd-disable interface ethernet 1/1/2 OS10# clear ufd-disable uplink-state-group 1</pre>                                                                                                                                                                                                                                      |
| <b>Supported Releases</b> | 10.4.0E(R3) or later                                                                                                                                                                                                                                                                                                                          |

## defer-time

Configures the timer to defer UFD actions on downstream ports.

|                           |                                                                                                                                                                                        |
|---------------------------|----------------------------------------------------------------------------------------------------------------------------------------------------------------------------------------|
| <b>Syntax</b>             | <code>defer-time <i>timer</i></code>                                                                                                                                                   |
| <b>Parameters</b>         | <i>timer</i> — Enter the timer value in seconds, ranging from 1 to 120.                                                                                                                |
| <b>Default</b>            | Disabled                                                                                                                                                                               |
| <b>Command Mode</b>       | UPLINK-STATE-GROUP                                                                                                                                                                     |
| <b>Usage Information</b>  | You can view configured timer details using the <code>show uplink-state-group [<i>group-id</i>] detail</code> command. The <code>no</code> version of this command disables the timer. |
| <b>Example</b>            | <pre>OS10(config)# uplink-state-group 1 OS10(conf-uplink-state-group-1)# defer-time 120</pre>                                                                                          |
| <b>Supported Releases</b> | 10.4.1.0 or later                                                                                                                                                                      |

## downstream

Adds an interface or a range of interfaces as a downstream interface to the uplink-state group.

|                          |                                                                                                                                                                                                   |
|--------------------------|---------------------------------------------------------------------------------------------------------------------------------------------------------------------------------------------------|
| <b>Syntax</b>            | <code>downstream {<i>interface-type</i>   <i>interface-range</i>}</code>                                                                                                                          |
| <b>Parameters</b>        | <ul style="list-style-type: none"><li>• <i>interface-type</i> — Enter the interface type as Ethernet or port-channel.</li><li>• <i>interface-range</i> — Enter the range of interfaces.</li></ul> |
| <b>Default</b>           | None                                                                                                                                                                                              |
| <b>Command Mode</b>      | UPLINK-STATE-GROUP                                                                                                                                                                                |
| <b>Usage Information</b> | You cannot assign an interface that is already a member of an uplink-state group to another group. The <code>no</code> version of this command removes the interface from the uplink-state group. |

**Example**

```
OS10(config)# uplink-state-group 1
OS10(conf-uplink-state-group-1)# downstream ethernet 1/1/1
```

**Supported Releases**

10.4.0E(R3) or later

## downstream auto-recover

Enables auto-recovery of the disabled downstream interfaces.

**Syntax**

`downstream auto-recover`

**Parameters**

None

**Default**

Enabled

**Command Mode**

UPLINK-STATE-GROUP

**Usage Information**

The `no` version of this command disables the auto-recovery of downstream interfaces.

**Example**

```
OS10(config)# uplink-state-group 1
OS10(conf-uplink-state-group-1)# no downstream auto-recover
```

**Supported Releases**

10.4.1.0 or later

## downstream disable links

Configures the number of downstream interfaces to disable when an upstream interface in the uplink-state group goes down.

**Syntax**

`downstream disable links{number | all}`

**Parameters**

- *number*—Enter the number of downstream interfaces to disable, from 1 to 1024.
- *all*—Enter `all` to disable all the downstream interfaces.

**Default**

Not configured

**Command Mode**

UPLINK-STATE-GROUP

**Usage Information**

The `no` version of this command reverts the settings to the default state.

**Example**

```
OS10(config)# uplink-state-group 1
OS10(conf-uplink-state-group-1)# downstream disable links 2
```

**Supported Releases**

10.4.1.0 or later

## enable

Enables tracking of an uplink-state group.

**Syntax**

`enable`

**Parameters**

None

**Default**

Disabled

**Command Mode**

UPLINK-STATE-GROUP

**Usage Information**

The `no` version of this command disables tracking of an uplink-state group.

### Example

```
OS10 (config)# uplink-state-group 1
OS10 (conf-uplink-state-group-1)# enable
```

### Supported Releases

10.4.0E(R3) or later

## name

Configures a descriptive name for the uplink-state group.

### Syntax

`name string`

### Parameters

`string` — Enter a description for the uplink-state group. A maximum of 32 characters.

### Default

Not configured

### Command Mode

UPLINK-STATE-GROUP

### Usage Information

The `no` version of this command removes the descriptive name.

### Example

```
OS10 (config)# uplink-state-group 1
OS10 (conf-uplink-state-group-1)# name test_ufd_group
```

### Supported Releases

10.4.0E(R3) or later

## show running-configuration uplink-state-group

Displays the running configuration specific to uplink-state groups.

### Syntax

`show running-configuration uplink-state-group [group-id]`

### Parameters

`group-id` — Enter the uplink group ID. The running configuration of the specified group ID displays.

### Default

Not configured

### Command Mode

EXEC

### Usage Information

None

### Example

```
OS10# show running-configuration uplink-state-group
!
uplink-state-group 1
 downstream ethernet1/1/8:1-1/1/8:4
 upstream ethernet1/1/9:1-1/1/9:4
 upstream port-channel1-3
```

### Supported Releases

10.4.0E(R3) or later

## show uplink-state-group

Displays the configured uplink-state status.

### Syntax

`show uplink-state-group [group-id] [detail]`

### Parameters

- `group-id` — Enter the uplink group ID. The status of the specified group ID displays.
- `detail` — Displays detailed information on the status of the uplink-state groups.

### Default

Not configured

**Command Mode** EXEC

**Usage Information** None

**Example**

```
OS10# show uplink-state-group

Uplink State Group: 9, Status: Enabled,down
```

```
OS10# show uplink-state-group 9

Uplink State Group: 9, Status: Enabled,down
OS10#
```

**Example (detail)**

```
OS10# show uplink-state-group detail

(Up): Interface up (Dwn): Interface down (Dis): Interface disabled

Uplink State Group : 1 Status : Enabled,up Name : UFDGROUP1
Defer Time : 10 second(s)
Upstream Interfaces : Eth 1/1/7:1(Up)
Downstream Interfaces: Eth 1/1/1(Dwn) Eth 1/1/2(Dwn) Eth
1/1/3(Dwn) Eth 1/1/4(Dwn)
 Eth 1/1/5(Dwn) Eth 1/1/9:2(Dwn) Eth
1/1/9:3(Dwn)
```

```
OS10# show uplink-state-group 2 detail

(Up): Interface up (Dwn): Interface down (Dis): Interface disabled

Uplink State Group : 2 Status : Enabled,down Name: UFDGROUP
Upstream Interfaces : Eth 1/1/6(Dwn) Eth 1/1/10(Dwn) Eth
1/1/11(Dwn) Eth 1/1/12(Dwn)
 Eth 1/1/13(Dwn) Eth 1/1/14(Dwn) Eth 1/1/15(Dwn)
Downstream Interfaces: Eth 1/1/16(Dis) Eth 1/1/17(Dis) Eth
1/1/18(Dis) Eth 1/1/19(Dis)
 Eth 1/1/20(Dis)
```

**Example (detail with VLTi and VLT status tracked)**

```
OS10#show uplink-state-group 1 detail

(Up): Interface up (Dwn): Interface down (Dis): Interface disabled (NA):
Not Available

*: VLT port-channel, V: VLT status, P: Peer Operational status ^:
Tracking status

Uplink State Group : 1 Name: iscsi_group, Status: Enabled, Up
Upstream Interfaces : eth1/1/35(Up) *po10(V:Up, ^P:Dwn) VLTi(NA)
Downstream Interfaces : eth1/1/2(Up) *po20(V: Up,P: Up)
```

```
OS10#show uplink-state-group 2 detail

(Up): Interface up (Dwn): Interface down (Dis): Interface disabled (NA):
Not Available

*: VLT port-channel, V: VLT status, P: Peer Operational status ^:
Tracking status

Uplink State Group : 1 Name: iscsi_group, Status: Enabled, Up
Upstream Interfaces : eth1/1/36(Up) *po30(^V:Up, P:Dwn) VLTi(Up)
Downstream Interfaces : eth1/1/4(Up) *po20(V: Up,P: Up)
```

**Supported Releases** 10.4.0E(R3) or later

## uplink-state-group

Creates an uplink-state group and enables upstream link tracking.

|                           |                                                                                     |
|---------------------------|-------------------------------------------------------------------------------------|
| <b>Syntax</b>             | <code>uplink-state-group group-id</code>                                            |
| <b>Parameters</b>         | <code>group-id</code> — Enter a unique ID for the uplink-state group, from 1 to 32. |
| <b>Default</b>            | None                                                                                |
| <b>Command Mode</b>       | CONFIGURATION                                                                       |
| <b>Usage Information</b>  | The <code>no</code> version of this command removes the uplink-state group.         |
| <b>Example</b>            | <pre>OS10(config)# uplink-state-group 1</pre>                                       |
| <b>Supported Releases</b> | 10.4.0E(R3) or later                                                                |

## upstream

Adds an interface or a range of interfaces as an upstream interface to the uplink-state group.

|                           |                                                                                                                                                                                                                                                                                                                                                                                                                                                         |
|---------------------------|---------------------------------------------------------------------------------------------------------------------------------------------------------------------------------------------------------------------------------------------------------------------------------------------------------------------------------------------------------------------------------------------------------------------------------------------------------|
| <b>Syntax</b>             | <code>upstream {interface-type   interface-range [ track-vlt-status ]   VLTi}</code>                                                                                                                                                                                                                                                                                                                                                                    |
| <b>Parameters</b>         | <ul style="list-style-type: none"><li>• <code>interface-type</code> — Enter the interface type as Ethernet or port-channel.</li><li>• <code>interface-range</code> — Enter the range of interfaces.</li><li>• <code>VLTi</code>—Configures VLTi Link as member of uplink state group.</li><li>• <code>track-vlt-status</code>—(Optional) Tracks the VLT status for the upstream member. This option applies only for port-channel interfaces.</li></ul> |
| <b>Default</b>            | When you add an upstream member without the <code>track-vlt-status</code> option, the operational status is tracked by default.                                                                                                                                                                                                                                                                                                                         |
| <b>Command Mode</b>       | UPLINK-STATE-GROUP                                                                                                                                                                                                                                                                                                                                                                                                                                      |
| <b>Usage Information</b>  | You cannot assign an interface that is already a member of an uplink-state group to another group. The <code>no</code> version of this command removes the interface from the uplink-state group.                                                                                                                                                                                                                                                       |
| <b>Example</b>            | <pre>OS10(config)# uplink-state-group 1 OS10(conf-uplink-state-group-1)# upstream ethernet 1/1/45-1/1/48  OS10(conf-uplink-state-group-1)# upstream VLTi  OS10(conf-uplink-state-group-1)# upstream port-channel 10 track-vlt-status</pre>                                                                                                                                                                                                              |
| <b>Supported Releases</b> | 10.4.0E(R3) or later                                                                                                                                                                                                                                                                                                                                                                                                                                    |

## Converged data center services

OS10 supports converged data center services, including IEEE 802.1 data center bridging (DCB) extensions to classic Ethernet. DCB provides I/O consolidation in a data center network. Each network device carries multiple traffic classes while ensuring lossless delivery of storage traffic with best-effort for local area network (LAN) traffic and latency-sensitive scheduling of service traffic.

- 802.1Qbb — Priority flow control
- 802.1Qaz — Enhanced transmission selection
- Data Center Bridging Exchange (DCBX) protocol

DCB enables the convergence of LAN and storage area network (SAN) traffic over a shared physical network in end-to-end links from servers to storage devices. In a converged network, all server, storage, and networking devices are DCB-enabled. DCB supports fibre channel over Ethernet (FCoE) and iSCSI transmission of storage data. DCB is not supported on interfaces with link-level flow control (LLFC) enabled.

|                                                         |                                                                                                                                                                                                                    |
|---------------------------------------------------------|--------------------------------------------------------------------------------------------------------------------------------------------------------------------------------------------------------------------|
| <b>Priority flow control (PFC)</b>                      | Use priority-based flow control to ensure lossless transmission of storage traffic, while transmitting other traffic classes that perform better without flow control, see <a href="#">Priority flow control</a> . |
| <b>Enhanced transmission selection (ETS)</b>            | Assign bandwidth to 802.1p class of service (CoS)-based traffic classes. Use ETS to increase preferred traffic-class throughput during network congestion, see <a href="#">Enhanced transmission selection</a> .   |
| <b>Data Center Bridging Exchange protocol (DCBX)</b>    | Configure the DCBX protocol DCB neighbors use to discover and exchange configuration information for plug-and-play capability, see <a href="#">Data center bridging eXchange</a> .                                 |
| <b>Internet small computer system interface (iSCSI)</b> | Use iSCSI auto-configuration and detection of storage devices, monitor iSCSI sessions, and apply QoS policies on iSCSI traffic, see <a href="#">Internet small computer system interface</a> .                     |

### Configuration notes

All Dell EMC PowerSwitches except MX-Series, S4200-Series, S5200 Series, and Z9332F-ON:

When you do not enable PFC on some of the port channel members between the FIP snooping bridge (FSB) and NPIV proxy gateway (NPG), FCoE sessions are not established. You should enable all the members of a port channel with PFC, for the FCoE sessions to establish.

## Priority flow control

In a converged data-center network, to ensure that no frames are lost due to congestion, use PFC. PFC uses the 802.1p priority in the Ethernet header to pause priority-specific traffic that is sent from a transmitting device. The 802.1p priority is also known as the class of service (CoS) or dot1p priority value.

When PFC detects congestion of a dot1p traffic class, it sends a pause frame for the priority traffic to the transmitting device. In this way, PFC ensures that the switch does not drop specified priority traffic.

PFC enhances the existing 802.3x pause capability to enable flow control based on 802.1p priorities. Instead of stopping all traffic on a link, as performed by the 802.3x pause mechanism, PFC pauses traffic for 802.1p traffic types. For example, when LAN traffic congestion occurs on an interface, PFC ensures lossless flows of storage and server traffic while allowing for lossy best-effort transmission of other traffic.

**NOTE:** Ethernet traffic ingressing from ETS and PFC enabled interfaces will always queue through queue 0, irrespective of the network type configured on VLAN.

PFC handles traffic congestion by pausing prioritized dot1p traffic on an ingress interface and allowing other dot1p traffic best-effort, also known as lossy data transmission.



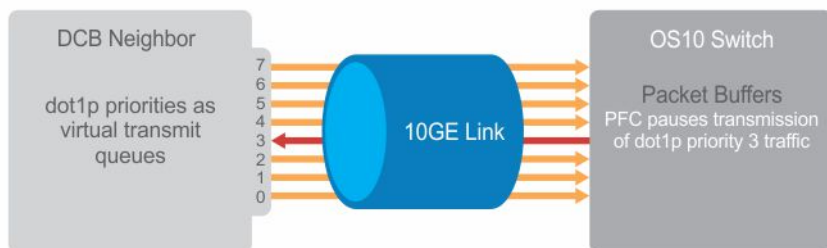

## Configuration notes

Dell EMC PowerSwitch S4200-ON Series:

- Provisioning PFC is not supported when deep buffer mode is enabled.
- Configure the traffic class ID to queue mapping policy on egress interfaces.
- You cannot enable PFC on all the physical interfaces, when you have split the ports to multiple breakout interfaces. For more information, see the 'PFC configuration notes' section in the Dell EMC SmartFabric OS10 User Guide.
- When you add or remove the PFC configuration on an interface, the interface gets flapped. Stop the traffic before applying or modifying the PFC configuration.

## PFC configuration notes

- PFC is supported for 802.1p, dot1p priority traffic, from 0 to 7. FCoE traffic traditionally uses dot1p priority 3 — iSCSI storage traffic uses dot1p priority 4.
- Configure PFC for ingress traffic by using network-qos class and policy maps. For more information, see [Quality of service](#). PFC-enabled traffic queues are treated as lossless queues. Configure the same network-qos policy map on all PFC-enabled ports. Configure required bandwidth for lossless traffic using ETS queuing (output) policies on egress interfaces.
- In a network-qos policy-class map, use commands to generate PFC pause frames for matching class-map priorities:
  - Send pause frames for matching class-map traffic during congestion using the `pause` command.
  - (Optional) Enter user-defined values for the reserved ingress buffer-size of PFC class-map traffic, and the thresholds that are used to send XOFF and XON pause frames using the `pause [buffer-size kilobytes pause-threshold kilobytes resume-threshold kilobytes]` command.
  - Configure the matching dot1p values used to send pause frames using the `pfc-cos` command.
  - (Optional) Set the static and dynamic thresholds that determine the shared buffers available for PFC class-map traffic queues using the `queue-limit thresh-mode` command.
- By default, the lossy ingress buffer handles all ingress traffic. When you enable PFC, dot1p ingress traffic competes for shared buffers in the lossless pool instead of the shared lossy pool. The number of lossless queues that are supported on an interface depends on the amount of available free memory in the lossy pool.
- Use the `priority-flow-control mode on` command to enable PFC for FCoE and iSCSI traffic; for example, priority 3 and 4.
- Enable DCBX on interfaces to detect and autoconfigure PFC/ETS parameters from peers.
- PFC and 802.3x LLFC are disabled by default on an interface. You cannot enable PFC and LLFC simultaneously. LLFC ensures lossy traffic in best-effort transmission. Enable PFC to enable guarantee lossless FCoE and iSCSI traffic. PFC manages buffer congestion by pausing specified ingress dot1p traffic; LLFC pauses all data transmission on an interface. To enable LLFC, use the `flowcontrol [receive | transmit] [on | off]` command.
- SYSTEM-QOS mode applies a service policy globally on all interfaces:
  - Create and apply a 1-to-1 802.1p-priority-to-traffic-class mapping on an interface or all interfaces in INTERFACE or SYSTEM-QOS mode.
  - Create and apply a 1-to-1 traffic-class-to-queue mapping on an interface or all interfaces in INTERFACE or SYSTEM-QOS mode.

### Configure dot1p priority to traffic class mapping

Decide if you want to use the default 802.1p priority-to-traffic class (`qos-group`) mapping or configure a new map. The default dot1p to traffic class map in OS10 is shown below.

```
Dot1p Priority : 0 1 2 3 4 5 6 7
Traffic Class : 1 0 2 3 4 5 6 7
```

- Apply the default trust map specifying that dot1p values are trusted in SYSTEM-QOS or INTERFACE mode.

```
trust-map dot1p default
```

### Configure a non-default dot1p-priority-to-traffic class mapping

1. Configure a trust map of dot1p traffic classes in CONFIGURATION mode. A trust map does not modify ingress dot1p values in output flows.

Assign a `qos-group` to trusted dot1p values in TRUST mode using 1-to-1 mappings. Dot1p priorities are 0 to 7. For a PFC traffic class, map only one dot1p value to a `qos-group` number; for Broadcom-based NPU platforms, the `qos-group` number and the dot1p value must be the same. A `qos-group` number is used only internally to classify ingress traffic classes.

```
trust dot1p-map dot1p-map-name
 qos-group {0-7} dot1p {0-7}
exit
```

2. Apply the `trust dot1p-map` policy to ingress traffic in SYSTEM-QOS or INTERFACE mode.

```
trust-map dot1p trust-policy-map-name
```

### Configure traffic-class-queue mapping

**i** **NOTE:** Z9332F-ON has different configurations for queue mapping. For more information, see *Configure traffic-class to queue mapping for Z9332F-ON*.

Decide if you want to use the default traffic-class-queue mapping or configure a nondefault traffic-class-to-queue mapping.

```
Traffic Class : 0 1 2 3 4 5 6 7
Queue : 0 1 2 3 4 5 6 7
```

If you are using the default traffic-class-to-queue map, no further configuration steps are necessary.

1. Create a traffic-class-to-queue map in CONFIGURATION mode. Assign a traffic class (`qos-group`) to a queue in QOS-MAP mode using 1-to-1 mappings. For a PFC traffic class, map only one `qos-group` value to a queue number. A `qos-group` number is used only internally to classify ingress traffic.

```
qos-map traffic-class tc-queue-map-name
 queue {0-7} qos-group {0-7}
exit
```

2. Apply the traffic-class-queue map in SYSTEM-QOS or INTERFACE mode.

```
qos-map traffic-class tc-queue-map-name
```

### Configure traffic-class to queue mapping for Z9332F-ON

The Z9332F-ON supports 12 queues per Ingress Traffic Manager (ITM) in the front-panel ports. The 12 queues are divided into eight unicast (UC) and four multicast (MC) combinations. For multicast queues, MCQ index 0 to 2 are used for MC flows. MCQ index 3 sends control packets from the CPU.

By default, multicast traffic map in the following order:

TC0-TC2 : Q0

TC3-TC5 : Q1

TC6-TC7 : Q2

You can map different traffic classes of UC and MC traffics to different queues, based on the requirement.

### Configure TC-to-queue mapping

```
OS10# show qos maps
Traffic-Class to Queue Map: sundar

Queue Traffic Class Type

3 1-3 Unicast
4 4,6,0 Unicast
```

### Default TC-to-queue mapping format

The following is the format for Z9332F-ON:

```
Default Traffic-Class to Queue Map
```

| Traffic Class | Queue Number | Type      |
|---------------|--------------|-----------|
| 0             | 0            | Unicast   |
| 0-2           | 0            | Multicast |
| 1             | 1            | Unicast   |
| 3-5           | 1            | Multicast |
| 2             | 2            | Unicast   |
| 6-7           | 2            | Multicast |
| 3             | 3            | Unicast   |
| 4             | 4            | Unicast   |
| 5             | 5            | Unicast   |
| 6             | 6            | Unicast   |
| 7             | 7            | Unicast   |

The following is the default TC-to-Queue Mapping format:

```
Default Traffic-Class to Queue Map
```

| Traffic-Class | Queue number | Type |
|---------------|--------------|------|
| 0             | 0            | Both |
| 1             | 1            | Both |
| 2             | 2            | Both |
| 3             | 3            | Both |
| 4             | 4            | Both |
| 5             | 5            | Both |
| 6             | 6            | Both |
| 7             | 7            | Both |

### View the interface PFC configuration

```
OS10# show interface ethernet 1/1/1 priority-flow-control details
ethernet1/1/1
Admin Mode : true
Operstatus: true
PFC Priorities: 4
Total Rx PFC Frames: 0
Total Tx PFC frames: 0
Cos Rx Tx

0 0 0
1 0 0
2 0 0
3 0 0
4 0 0
5 0 0
6 0 0
7 0 0
```

## Configure PFC

PFC provides a pause mechanism that is based on the 802.1p priorities in ingress traffic. PFC prevents frame loss due to network congestion. Configure PFC lossless buffers, and enable pause frames for dot1p traffic on a per-interface basis. Repeat the PFC configuration on each PFC-enabled interface. PFC is disabled by default.

Decide if you want to use the default dot1p-priority-to-traffic class mapping and the default traffic-class-to-queue mapping. To change the default settings, see [PFC configuration notes](#).

Configuration steps:

1. Create PFC, dot1p traffic classes.
2. Configure ingress buffers for PFC traffic.
3. Apply a service policy and enable PFC.

4. (Optional) Configure the PFC shared buffer for lossless traffic.

### Create PFC dot1p traffic classes

1. Create a `network-qos` class map to classify PFC traffic classes in CONFIGURATION mode, from 1 to 7. Specify the traffic classes using the `match qos-group` command. QoS-groups map 1:1 to traffic classes 1 to 7; for example, `qos-group 1` corresponds to traffic class 1. Enter a single value, a hyphen-separated range, or multiple `qos-group` values separated by commas in CLASS-MAP mode.

```
class-map type network-qos class-map-name
 match qos-group {1-7}
 exit
```

2. (Optional) Repeat Step 1 to configure additional PFC traffic-class class-maps.

### Configure pause and ingress buffers for PFC traffic

For the default ingress queue settings and the default dot1p priority-queue mapping, see [PFC configuration notes](#).

1. Create a `network-qos` policy map in CONFIGURATION mode.

```
policy-map type network-qos policy-map-name
```

2. Associate the policy-map with a `network-qos` class map in POLICY-MAP mode.

```
class class-map-name
```

3. Configure default values for ingress buffers used for the `network-qos` class maps in POLICY-CLASS-MAP mode.

```
pause
```

(Optional) Change the default values for the ingress-buffer size that is reserved for the `network-qos` class-map traffic and the thresholds that are used to send XOFF and XON pause frames in kilobytes.

```
pause [buffer-size kilobytes {pause-threshold kilobytes | resume-threshold kilobytes}]
```

4. Enable the PFC pause function for dot1p traffic in POLICY-CLASS-MAP mode. The dot1p values must be the same as the `qos-group` traffic class numbers in the class-map in Step 2. Enter a single dot1p value, from 1 to 7, a hyphen-separated range, or multiple dot1p values separated by commas.

```
pfc-cos dot1p-priority
```

5. (Optional) Set the static and dynamic thresholds that are used to limit the shared buffers that are allocated to PFC traffic-class queues. Configure a static, fixed queue-limit (in kilobytes) or a dynamic threshold (weight 1-10; default 9) based on the available PFC shared buffers.

```
queue-limit thresh-mode {static kilobytes | dynamic weight}
```

6. (Optional) Repeat Steps 2–4 to configure PFC on additional traffic classes.

### Apply service policy and enable PFC

1. Apply the PFC service policy on an ingress interface or interface range in INTERFACE mode.

```
interface ethernet node/slot/port[:subport]
 service-policy input type network-qos policy-map-name
```

```
interface range ethernet node/slot/port[:subport]-node/slot/port[:subport]
 service-policy input type network-qos policy-map-name
```

2. Enable PFC without DCBX for FCoE and iSCSI traffic in INTERFACE mode.

```
priority-flow-control mode on
```

### Configure PFC

PFC is enabled on traffic classes with dot1p 3 and 4 traffic. The two traffic classes require different ingress queue processing. In the network-qos pp1 policy map, class cc1 uses customized PFC buffer size and pause frame settings; class cc2 uses the default settings.

```

OS10(config)# system qos
OS10(config-sys-qos)# trust-map dot1p default

OS10(config)# system qos
OS10(config-sys-qos)# exit

OS10(config)# class-map type network-qos cc1
OS10(config-cmap-nqos)# match qos-group 3
OS10(config-cmap-nqos)# exit

OS10(config)# class-map type network-qos cc2
OS10(config-cmap-nqos)# match qos-group 4
OS10(config-cmap-nqos)# exit

OS10(config)# policy-map type network-qos pp1
OS10(config-pmap-network-qos)# class cc1
OS10(config-pmap-c-nqos)# pause buffer-size 30 pause-threshold 20 resume-threshold 10
OS10(config-pmap-c-nqos)#pfc-cos 3
OS10(config-pmap-c-nqos)#exit
OS10(config-pmap-network-qos)# class cc2
OS10(config-pmap-c-nqos)# pause
OS10(config-pmap-c-nqos)#pfc-cos 4
OS10(config-pmap-c-nqos)#exit

OS10(config)# interface ethernet 1/1/1
OS10(conf-if-eth1/1/1)# service-policy input type network-qos pp1

OS10(conf-if-eth1/1/1)# priority-flow-control mode on
OS10(conf-if-eth1/1/1)# no shutdown

```

**View PFC configuration and operational status**

```

OS10(conf-if-eth1/1/1)# do show interface ethernet 1/1/1 priority-flow-control details
ethernet1/1/1
Admin Mode : true
Operstatus: true
PFC Priorities: 3,4
Total Rx PFC Frames: 300
Total Tx PFC frames: 200
Cos Rx Tx

0 0 0
1 0 0
2 0 0
3 300 200
4 0 0
5 0 0
6 0 0
7 0 0

```

**View PFC ingress buffer configuration**

```

OS10# show qos ingress buffers interface ethernet 1/1/1
Interface : ethernet1/1/1
Speed : 0
Priority-grp Reserved Shared-buffer Shared-buffer
XOFF
 XON
 no buffer-size mode threshold
threshold
d threshold

0 - - -
-
-

```

|   |   |      |        |          |
|---|---|------|--------|----------|
| 1 | - | -    | -      | -        |
| - | - | -    | -      | -        |
| 2 | - | -    | -      | -        |
| - | - | -    | -      | -        |
| 3 | - | -    | -      | -        |
| - | - | -    | -      | -        |
| 4 | - | -    | -      | -        |
| - | - | -    | -      | -        |
| 5 | - | -    | -      | -        |
| - | - | -    | -      | -        |
| 6 | - | -    | -      | -        |
| - | - | -    | -      | -        |
| 7 | - | 9360 | static | 12779520 |
| - | - | -    | -      | -        |

### View PFC system buffer configuration

```

OS10# show qos system ingress buffer
All values are in kb
Total buffers - 12187
 Total lossless buffers - 0
 Maximum lossless buffers - 5512
 Total shared lossless buffers - 0
 Total used shared lossless buffers -
 Total lossy buffers - 11567
 Total shared lossy buffers - 11192
 Total used shared lossy buffers - 0

OS10# show qos system egress buffer
All values are in kb
Total buffers - 12187
 Total lossless buffers - 0
 Total shared lossless buffers - 0
 Total used shared lossless buffers -
 Total lossy buffers - 11567
 Total shared lossy buffers - 9812
 Total used shared lossy buffers - 0
 Total CPU buffers - 620
 Total shared CPU buffers - 558
 Total used shared CPU buffers - 0

```

### View PFC ingress buffer statistics

```

OS10(config)# show qos ingress buffer-stats interface ethernet 1/1/15
Interface : ethernet1/1/15
Speed : 10G
Priority Used reserved Used shared Used HDRM
Group buffers buffers buffers

0 9360 681824 35984
1 0 0 0
2 0 0 0
3 0 0 0
4 0 0 0
5 0 0 0
6 0 0 0
7 0 0 0

```

## PFC commands

## pause

Configures the ingress buffer size and buffer threshold limit for pause and resume operations.

**Syntax** `pause [buffer-size kilobytes pause-threshold kilobytes resume-threshold kilobytes]`

- Parameters**
- `buffer-size kilobytes` — Enter the reserved (guaranteed) ingress-buffer size in kilobytes for PFC dot1p traffic, from 0 to 7787.
  - `pause-threshold kilobytes` — Enter the buffer threshold limit (in kilobytes) to send pause frames to a transmitting device to temporarily halt the data transmission, from 0 to 7787.
  - `resume-threshold kilobytes` — Enter the threshold limit (in kilobytes) at which a request is sent to the transmitting device to resume sending traffic, from 0 to 7787.

**Defaults** The default ingress-buffer size reserved for PFC traffic classes, and the pause and resume thresholds vary according to the interface type. The default egress buffer that is reserved for PFC traffic classes is 0 on all interface types.

**Table 93. Port defaults**

| Port Speed                  | 10G Port | 25G Port | 40G Port | 50G Port | 100G Port |
|-----------------------------|----------|----------|----------|----------|-----------|
| PFC reserved ingress buffer | 45 KB    | 54 KB    | 93 KB    | 111 KB   | 178 KB    |
| PFC pause threshold         | 9 KB     | 9 KB     | 18 KB    | 18 KB    | 36 KB     |
| PFC resume threshold        | 9 KB     | 9 KB     | 9 KB     | 9 KB     | 9 KB      |

**Command Mode** POLICY-CLASS NETWORK-QOS

**Usage Information** Use the `pause` command without optional parameters to apply the default ingress-buffer size, and pause (XON) and resume (XOFF) thresholds. Default values for the `buffer-size`, `pause-threshold` and `resume-threshold` parameters vary across interface types and port speeds. The default values are based on the default MTU size of 9216 bytes. Use the optional `queue-limit thresh-mode` command to change the number of shared buffers available to PFC traffic-class queues in the policy-class-map.

**Example**

```
OS10(config)# policy-map type network-qos pp1
OS10(conf-pmap-network-qos)# class ccl
OS10(conf-pmap-c-nqos)# pause buffer-size 30 pause-threshold 20 resume-
threshold 10
```

**Supported Releases** 10.3.0E or later

## pfc-cos

Configures the matching dot1p values that are used to send PFC pause frames.

**Syntax** `pfc-cos dot1p-priority`

**Parameters** `dot1p-priority` — Enter the dot1p priority value for a PFC traffic class, from 1 to 7. Use a comma (,) to separate multiple values or a hyphen ( - ) to specify a range of values; for example, 0, 3, 7, or 3-6.

**Default** Not configured

**Command Mode** POLICY-CLASS NETWORK-QOS

**Usage Information** When you enter PFC-enabled dot1p priorities with `pfc-cos`, the dot1p values must be the same as the `match qos-group` (traffic class) numbers in the network-qos class map that is used to define the PFC traffic class, see [Configure PFC Example](#). A `qos-group` number is used only internally to classify ingress traffic classes. For the default dot1p-priority-to-traffic-class mapping and how to configure a nondefault

mapping, see [PFC configuration notes](#). A PFC traffic class requires a 1-to-1 mapping — only one dot1p value is mapped to a qos-group number.

#### Example

```
OS10(config)# class-map type network-qos ccl
OS10(conf-cmap-nqos)# match qos-group 3
OS10(conf-cmap-nqos)# exit
```

#### Example (policy-map)

```
OS10(config)# policy-map type network-qos pp1
OS10(conf-pmap-network-qos)# class ccl
OS10(conf-pmap-c-nqos)# pfc-cos 3
```

#### Supported Releases

10.3.0E or later

## pfc-shared-buffer-size

Configures the number of shared buffers available for PFC-enabled traffic on the switch.

#### Syntax

`pfc-shared-buffer-size kilobytes`

#### Parameter

*kilobytes* — Enter the total amount of shared buffers available to PFC-enabled dot1p traffic in kilobytes, from 0 to 7787.

#### Default

832KB

#### Command Mode

SYSTEM-QOS

#### Usage Information

By default, the lossy ingress buffer handles all ingress traffic. When you enable PFC, dot1p ingress traffic competes for shared buffers in the lossless pool instead of the shared lossy pool. Use this command to increase or decrease the shared buffer that is allowed for PFC-enabled flows. The configured number of shared buffers is reserved for PFC flows only after you enable PFC on an interface using the `priority-flow-control mode on` command.

#### Example

```
OS10(config)# system qos
OS10(conf-sys-qos)# pfc-shared-buffer-size 1024
```

#### Supported Releases

10.3.0E or later

## priority-flow-control

Enables PFC on ingress interfaces.

#### Syntax

`priority-flow-control {mode on}`

#### Parameter

`mode on` — Enable PFC for FCoE and iSCSI traffic on an interface without enabling DCBX.

#### Default

Disabled

#### Command Mode

INTERFACE

#### Usage Information

Before you enable PFC, apply a network-qos policy-class map with the specific PFC dot1p priority values to the interface. In the PFC network-qos policy-class map, use the default `buffer-size` values if you are not sure about the `pause-threshold` and `resume-threshold` settings that you want to use. You cannot enable PFC and LLFC simultaneously on an interface. The `no` version of this command disables PFC on an interface. When you disable PFC, delete the PFC network-qos policy-class map applied to the interface.

#### Example

```
OS10(conf-if-eth1/1/1)# priority-flow-control mode on
```

#### Supported Releases

10.3.0E or later



## queue-limit

Sets the static and dynamic thresholds that are used to limit the shared-buffer size of PFC traffic-class queues.

|                           |                                                                                                                                                                                                                                                                                                                                                                                                                                                                                                                                                                                                                                      |
|---------------------------|--------------------------------------------------------------------------------------------------------------------------------------------------------------------------------------------------------------------------------------------------------------------------------------------------------------------------------------------------------------------------------------------------------------------------------------------------------------------------------------------------------------------------------------------------------------------------------------------------------------------------------------|
| <b>Syntax</b>             | <code>queue-limit {thresh-mode [static <i>kilobytes</i>   dynamic <i>weight</i>]}</code>                                                                                                                                                                                                                                                                                                                                                                                                                                                                                                                                             |
| <b>Parameters</b>         | <ul style="list-style-type: none"><li>• <code>thresh-mode</code> — Specifies the Buffer threshold mode.</li><li>• <code>static <i>kilobytes</i></code> — Enter the static followed by the fixed shared-buffer limit available for PFC traffic-class queues in kilobytes, from 0 to 7787. The value of this parameter must be within the maximum amount tuned by the <code>pfc-shared-buffer-size</code> command.</li><li>• <code>dynamic <i>weight</i></code> — Enter the dynamic followed by the weight value used to dynamically determine the shared-buffer limit available for PFC traffic-class queues, from 1 to 10.</li></ul> |
| <b>Default</b>            | Dynamic weight of 9 and static shared-buffer limit of 12,479,488 kilobytes.                                                                                                                                                                                                                                                                                                                                                                                                                                                                                                                                                          |
| <b>Command Mode</b>       | POLICY-CLASS NETWORK-QOS                                                                                                                                                                                                                                                                                                                                                                                                                                                                                                                                                                                                             |
| <b>Usage Information</b>  | To tune the amount of shared buffers available for the static limit of PFC traffic-class queues on the switch, use the <code>pfc-shared-buffer-size</code> command. The current amount of available shared buffers determines the dynamic queue-limit.                                                                                                                                                                                                                                                                                                                                                                               |
| <b>Example</b>            | <pre>OS10(config)# policy-map type network-qos ppl OS10(conf-pmap-network-qos)# class ccl OS10(conf-pmap-c-nqos)# queue-limit thresh-mode static 1024</pre>                                                                                                                                                                                                                                                                                                                                                                                                                                                                          |
| <b>Supported Releases</b> | 10.3.0E or later                                                                                                                                                                                                                                                                                                                                                                                                                                                                                                                                                                                                                     |

## show interface priority-flow-control

Displays PFC operational status, configuration, and statistics on an interface.

|                          |                                                                                                                                                                                                                                                                                                                                                                                                              |
|--------------------------|--------------------------------------------------------------------------------------------------------------------------------------------------------------------------------------------------------------------------------------------------------------------------------------------------------------------------------------------------------------------------------------------------------------|
| <b>Syntax</b>            | <code>show interface [ethernet <i>node/slot/port[:subport]</i>] priority-flow-control [details]</code>                                                                                                                                                                                                                                                                                                       |
| <b>Parameters</b>        | <code>ethernet <i>node/slot/port[:subport]</i></code> - Specifies the Ethernet interface along with the slot number and port number. The slot number is from 1 to 255, and the port number is from 1 to 128.                                                                                                                                                                                                 |
| <b>Default</b>           | Not configured                                                                                                                                                                                                                                                                                                                                                                                               |
| <b>Command Mode</b>      | EXEC                                                                                                                                                                                                                                                                                                                                                                                                         |
| <b>Usage Information</b> | Use the <code>details</code> option to display PFC statistics on received/transmitted frames for each dot1p CoS value. Use the <code>clear qos statistics interface ethernet 1/1/1</code> command to delete PFC statistics and restart the counter.                                                                                                                                                          |
| <b>Example (details)</b> | <pre>OS10(config)# show interface ethernet 1/1/15 priority-flow-control details  ethernet1/1/15 Admin Mode : true Operstatus: true PFC Priorities: 3 Total Rx PFC Frames: 0 Total Tx PFC frames: 587236 Cos      Rx      Tx ----- 0        0        0 1        0        0 2        0        0 3        0        587236 4        0        0 5        0        0 6        0        0 7        0        0</pre> |

## Supported Releases

10.3.0E or later

# Enhanced transmission selection

ETS provides customized bandwidth allocation to 802.1p classes of traffic. Assign different amounts of bandwidth to Ethernet, FCoE, or iSCSI traffic classes that require different bandwidth, latency, and best-effort treatment during network congestion.

ETS divides traffic into different priority groups using their 802.1p priority value. To ensure that each traffic class is correctly prioritized and receives the required bandwidth, configure bandwidth and queue scheduling for each priority group. To prioritize low-latency storage and server-cluster traffic, allocate more bandwidth to a priority group. To rate-limit best-effort LAN traffic, allocate less bandwidth to a different priority group.

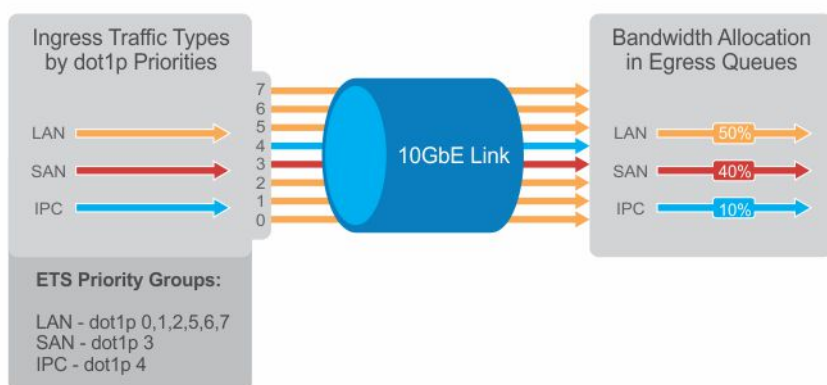

## ETS configuration notes

- ETS is supported on Layer2 (L2) 802.1p priority (dot1p 0 to 7) and Layer 3 (L3) DSCP (0 to 63) traffic. FCoE traffic uses dot1p priority 3 — iSCSI storage traffic uses dot1p priority 4.
- Apply these maps and policies on interfaces:
  - Trust maps — OS10 interfaces do not honor the L2 and L3 priority fields in ingress traffic by default. Create a trust map to honor dot1p and DSCP classes of lossless traffic. A trust map does not change ingress dot1p and DSCP values in egress flows. In a trust map, assign a `qos-group` traffic class to trusted dot1p/DSCP values. A qos-group number is used only internally to schedule classes of ingress traffic.
  - QoS map — Create a QoS map to assign trusted dot1p and DSCP traffic classes to lossless queues.
  - Ingress trust policy — Configure a service policy to trust dot1p values in ingress traffic.
  - Egress queuing policy — Configure ETS for egress traffic by assigning bandwidth to match lossless queues in `queuing` class and policy maps.
- Apply both PFC network-qos (input) and ETS queuing (output) policies on an interface to ensure lossless transmission.
- An ETS-enabled interface operates with dynamic weighted round-robin (DWRR) or strict-priority scheduling.
- OS10 control traffic is sent to control queues, which have a strict-priority that is higher than data traffic queues. ETS-allocated bandwidth is not supported on a strict-priority queue. A strict priority queue receives bandwidth only from DCBX type, length, values (TLVs).
- The CEE/IEEE2.5 versions of ETS TLVs are supported. ETS configurations are received in a TLV from a peer.

## Configure ETS

ETS provides traffic prioritization for lossless storage, latency-sensitive, and best-effort data traffic on the same link.

- Configure classes of dot1p and DSCP traffic, and assign them to lossless queues.
- Allocate guaranteed bandwidth to each lossless queue. If another queue does not use its share, an ETS queue can exceed the amount of allocated bandwidth.

ETS is disabled by default on all interfaces.

1. Configure trust maps of dot1p and DSCP values in CONFIGURATION mode. A trust map does not modify ingress values in output flows. Assign a qos-group, traffic class from 0 to 7, to trusted dot1p/DSCP values in TRUST mode. A qos-group number is used only internally to schedule classes of ingress traffic. Enter multiple dot1p and dscp values in a hyphenated range or separated by commas.

```
trust dot1p-map dot1p-map-name
 qos-group {0-7} dot1p {0-7}
 exit
trust dscp-map dscp-map-name
 qos-group {0-7} dscp {0-63}
 exit
```

2. Configure a QoS map with trusted traffic-class (qos-group) to lossless-queue mapping in CONFIGURATION mode. Assign one or more qos-groups, from 0 to 7, to a specified queue in QOS-MAP mode. Enter multiple qos-group values in a hyphenated range or separated by commas. Enter multiple queue qos-group entries, if necessary.

```
qos-map traffic-class queue-map-name
 queue {0-7} qos-group {0-7}
 exit
```

3. Apply the default trust map specifying that dot1p and dscp values are trusted in SYSTEM-QOS or INTERFACE mode.

```
trust-map {dot1p | dscp} default
```

4. Create a queuing class map for each ETS queue in CONFIGURATION mode. Enter match queue criteria in CLASS-MAP mode.

```
class-map type queuing class-map-name
 match queue {0-7}
 exit
```

5. Create a queuing policy map in CONFIGURATION mode. Enter POLICY-CLASS-MAP mode and configure the percentage of bandwidth that is allocated to each traffic class-queue mapping. The sum of all DWRR-allocated bandwidth across ETS queues must be 100%, not including the strict-priority queue. Otherwise, QoS automatically adjusts bandwidth percentages so that ETS queues always receive 100% bandwidth. The remaining non-ETS queues receive 1% bandwidth each.

```
policy-map type queuing policy-map-name
 class class-map-name
 bandwidth percent {1-100}
```

(Optional) To configure a queue as strict-priority, use the priority command. Packets scheduled to a strict priority queue are transmitted before packets in nonpriority queues.

```
policy-map type queuing policy-map-name
 class class-map-name
 priority
```

6. Apply the trust maps for dot1p and DSCP values, and the traffic class-queue mapping globally on the switch in SYSTEM-QOS mode or on an interface or interface range in INTERFACE mode.

```
system qos
 trust-map dot1p dot1p-map-name
 trust-map dscp dscp-map-name
 qos-map traffic-class queue-map-name
```

Or

```
interface {ethernet node/slot/port[:subport] | range ethernet node/slot/
port[:subport]-node/slot/port[:subport]}
 trust-map dot1p dot1p-map-name
 trust-map dscp dscp-map-name
 qos-map traffic-class queue-map-name
```

7. Apply the qos trust policy to ingress traffic in SYSTEM-QOS or INTERFACE mode.

```
service-policy input type qos trust-policy-map-name
```

8. Apply the queuing policy to egress traffic in SYSTEM-QOS or INTERFACE mode.

```
service-policy output type queuing policy-map-name
```

9. Enable ETS globally in SYSTEM-QOS mode or on an interface/interface range in INTERFACE mode.

**NOTE:** If you have not enabled PFC on all the interfaces, this configuration at the global level is not required. Enable ETS on the specific interfaces.

```
ets mode on
```

## Configure ETS

```
OS10(config)# trust dot1p-map dot1p_map1
OS10(config-trust-dot1pmap)# qos-group 0 dot1p 0-3
OS10(config-trust-dot1pmap)# qos-group 1 dot1p 4-7
OS10(config-trust-dot1pmap)# exit

OS10(config)# trust dscp-map dscp_map1
OS10(config-trust-dscpmap)# qos-group 0 dscp 0-31
OS10(config-trust-dscpmap)# qos-group 1 dscp 32-63
OS10(config-trust-dscpmap)# exit

OS10(config)# qos-map traffic-class tc-q-map1
OS10(config-qos-tcmap)# queue 0 qos-group 0
OS10(config-qos-tcmap)# queue 1 qos-group 1
OS10(config-qos-tcmap)# exit

OS10(config)# system qos
OS10(config-sys-qos)# trust-map dot1p default

OS10(config)# class-map type queuing c1
OS10(config-cmap-queuing)# match queue 0
OS10(config-cmap-queuing)# exit
OS10(config)# class-map type queuing c2
OS10(config-cmap-queuing)# match queue 1
OS10(config-cmap-queuing)# exit

OS10(config)# policy-map type queuing p1
OS10(config-pmap-queuing)# class c1
OS10(config-pmap-queuing)# bandwidth percent 30
OS10(config-pmap-queuing)# exit
OS10(config)# policy-map type queuing p2
OS10(config-pmap-queuing)# class c2
OS10(config-pmap-queuing)# bandwidth percent 70
OS10(config-pmap-queuing)# exit

OS10(config)# system qos
OS10(config-sys-qos)# trust-map dot1p dot1p_map1
OS10(config-sys-qos)# trust-map dscp dscp_map1
OS10(config-sys-qos)# qos-map traffic-class tc-q-map1
OS10(config-sys-qos)# ets mode on
OS10(config-sys-qos)# service-policy output type queuing p1
```

## View ETS configuration

```
OS10# show qos interface ethernet 1/1/1
Interface
unknown-unicast-storm-control : Disabled
multicast-storm-control : Disabled
broadcast-storm-control : Disabled
flow-control-rx : Disabled
flow-control-tx : Disabled
ets mode : Disabled
Dot1p-tc-mapping : dot1p_map1
```

```
Dscp-tc-mapping : dscp_map1
tc-queue-mapping : tc-q-map1
```

### View GoS maps: traffic-class to queue mapping

```
OS10# show qos maps
Traffic-Class to Queue Map: tc-q-map1
 queue 0 qos-group 0
 queue 1 qos-group 1
Traffic-Class to Queue Map: dot1p_map1
 qos-group 0 dot1p 0-3
 qos-group 1 dot1p 4-7
DSCP Priority to Traffic-Class Map : dscp_map1
 qos-group 0 dscp 0-31
 qos-group 1 dscp 32-63
```

## ETS commands

### ets mode on

Enables ETS on an interface.

**Syntax**               ets mode on

**Parameter**           None

**Default**              Disabled

**Command Mode**       INTERFACE

**Usage Information**   Enable ETS on all switch interfaces in SYSTEM-QOS mode or on an interface or interface range in INTERFACE mode. The no version of this command disables ETS.

**Example**

```
OS10(config-sys-qos)# ets mode on
```

**Supported Releases**   10.3.0E or later

## Data center bridging eXchange

Data center bridging eXchange (DCBX) allows a switch to:

- Discover DCBX-enabled peers automatically.
- Detects misconfiguration in the DCBX-enabled peers.

In a converged data center network, DCBX provides plug-and-play capability for server, storage, and networking devices in an end-to-end solution. DCBX also ensures the consistent and efficient operation.

DCBX uses link layer discovery protocol (LLDP) to mediate automatic negotiation and device settings exchange, such as PFC and ETS. DCBX uses LLDP TLVs to perform DCB parameter exchange:

- PFC configuration and application-priority configuration
- ETS configuration and ETS recommendation

This sample DCBX topology shows two 40GbE ports on a switch that are used as uplinks to top-of-rack (ToR) switches. The ToR switches are part of a fiber channel storage network.

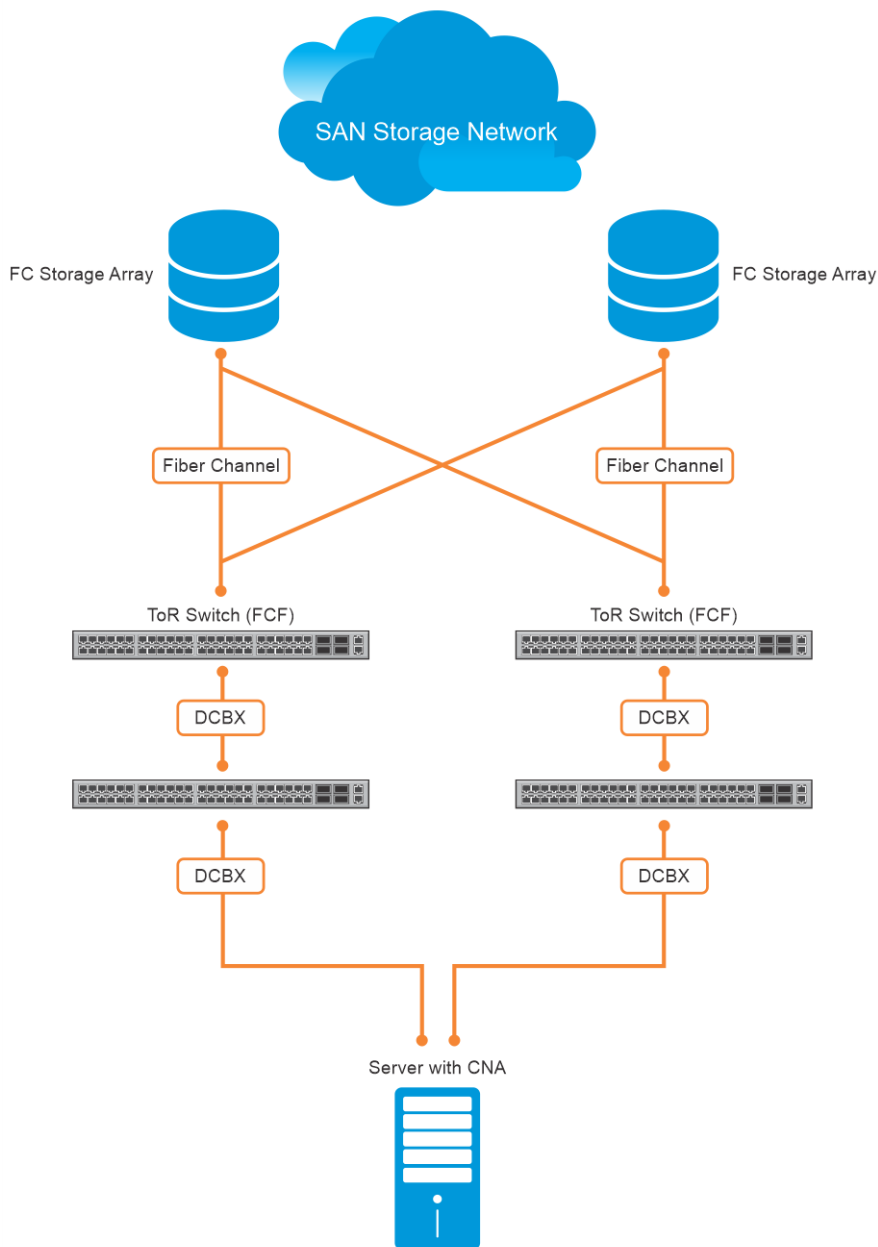

## DCBX configuration notes

- DCBX is a prerequisite for using DCB features, such as PFC and ETS, to exchange link-level configurations in a converged network.
- DCBX, when deployed in topologies, enables lossless operation for FCoE or iSCSI traffic. In these scenarios, all network devices in the topology must have DCBX-enabled.
- DCBX uses LLDP to advertise and automatically negotiate the administrative state and PFC or ETS configuration with directly connected DCB peers. DCBX cannot run if LLDP is disabled on an interface. Enable LLDP on all the DCBX port. For more information about LLDP, see [Link Layer Discovery Protocol](#).
- By default, DCBX is disabled globally. Enable DCBX globally on a switch to activate the exchange of DCBX TLV messages with PFC, ETS, and iSCSI configurations.
- By default, DCBX is enabled on the physical interfaces except on the management interface.
- You can manually reconfigure DCBX settings on an individual interface. For example, you can disable DCBX on an interface using the `no lldp tlv-select dcbxp` command or change the DCBX version using the `dcbx version` command.
- For DCBX to be operational, DCBX must be enabled both globally and on the interface. If the `show lldp dcbx interface` command returns the message DCBX feature not enabled, DCBX is not enabled at both levels.

- OS10 supports DCBX versions CEE and IEEE2.5.
- If ETS and PFC are enabled, DCBX advertises ETS configuration, ETS recommendation, and PFC configuration. When you configure application-specific parameters such as FCoE or iSCSI to be advertised, DCBX advertises the respective Application Priority TLVs.
- A DCBX-enabled port operates only in a manual role. In this mode, the port operates only with user-configured settings and does not autoconfigure with DCB settings that are received from a DCBX peer. When you enable DCBX, the port advertises its PFC and ETS configurations to peer devices but does not accept external, or propagate internal, DCB configurations.
  - ① **NOTE:** OS10 does not support autoupstream and autodownstream DCBX port roles. Hence, DCBX-enabled port autoconfiguration is not supported.
- DCBX detects a misconfiguration on a peer device when DCB features are not compatibly configured with the local switch.
  - ① **NOTE:** Misconfiguration detection is feature-specific because some DCB features support asymmetric (nonidentical) configurations.

## Verify DCBX configuration

Verify the DCBX, PFC, and ETS configurations on an interface, using the appropriate commands.

### View DCBX configuration

```
OS10# show lldp dcbx detail | no-more
E-ETS Configuration TLV enabled e-ETS Configuration TLV disabled
R-ETS Recommendation TLV enabled r-ETS Recommendation TLV disabled
P-PFC Configuration TLV enabled p-PFC Configuration TLV disabled
F-Application priority for FCOE enabled f-Application Priority for FCOE disabled
I-Application priority for iSCSI enabled i-Application Priority for iSCSI disabled

-

Interface ethernet1/1/1
 Port Role is Manual
 DCBX Operational Status is Disabled
 Reason: Port Shutdown
 Is Configuration Source? FALSE
 Local DCBX Compatibility mode is AUTO
 Local DCBX Configured mode is AUTO
 Peer Operating version is Not Detected
 Local DCBX TLVs Transmitted: erpfi
 0 Input PFC TLV pkts, 0 Output PFC TLV pkts, 0 Error PFC pkts
 0 Input ETS Conf TLV Pkts, 0 Output ETS Conf TLV Pkts, 0 Error ETS Conf TLV Pkts
 0 Input ETS Reco TLV pkts, 0 Output ETS Reco TLV pkts, 0 Error ETS Reco TLV Pkts
 0 Input Appln Priority TLV pkts, 0 Output Appln Priority TLV pkts, 0 Error Appln
Priority TLV Pkts

Total DCBX Frames transmitted 0
Total DCBX Frames received 0
Total DCBX Frame errors 0
Total DCBX Frames unrecognized 0

Interface ethernet1/1/2
 Port Role is Manual
 DCBX Operational Status is Disabled
 Reason: Port Shutdown
 Is Configuration Source? FALSE
 Local DCBX Compatibility mode is AUTO
 Local DCBX Configured mode is AUTO
 Peer Operating version is Not Detected
 Local DCBX TLVs Transmitted: erpfi
 0 Input PFC TLV pkts, 0 Output PFC TLV pkts, 0 Error PFC pkts
 0 Input ETS Conf TLV Pkts, 0 Output ETS Conf TLV Pkts, 0 Error ETS Conf TLV Pkts
 0 Input ETS Reco TLV pkts, 0 Output ETS Reco TLV pkts, 0 Error ETS Reco TLV Pkts
 0 Input Appln Priority TLV pkts, 0 Output Appln Priority TLV pkts, 0 Error Appln
Priority TLV Pkts

Total DCBX Frames transmitted 0
Total DCBX Frames received 0
Total DCBX Frame errors 0
Total DCBX Frames unrecognized 0
```

```
Interface ethernet1/1/3
 Port Role is Manual
 DCBX Operational Status is Disabled
 Reason: Port Shutdown
 Is Configuration Source? FALSE
 Local DCBX Compatibility mode is AUTO
 Local DCBX Configured mode is AUTO
 Peer Operating version is Not Detected
 Local DCBX TLVs Transmitted: erpfi
 0 Input PFC TLV pkts, 0 Output PFC TLV pkts, 0 Error PFC pkts
 0 Input ETS Conf TLV Pkts, 0 Output ETS Conf TLV Pkts, 0 Error ETS Conf TLV Pkts
 0 Input ETS Reco TLV pkts, 0 Output ETS Reco TLV pkts, 0 Error ETS Reco TLV Pkts
 0 Input Appln Priority TLV pkts, 0 Output Appln Priority TLV pkts, 0 Error Appln
Priority TLV Pkts
```

```
Total DCBX Frames transmitted 0
Total DCBX Frames received 0
Total DCBX Frame errors 0
Total DCBX Frames unrecognized 0
```

```
Interface ethernet1/1/4
 Port Role is Manual
 DCBX Operational Status is Disabled
 Reason: Port Shutdown
 Is Configuration Source? FALSE
 Local DCBX Compatibility mode is AUTO
 Local DCBX Configured mode is AUTO
 Peer Operating version is Not Detected
 Local DCBX TLVs Transmitted: erpfi
 0 Input PFC TLV pkts, 0 Output PFC TLV pkts, 0 Error PFC pkts
 0 Input ETS Conf TLV Pkts, 0 Output ETS Conf TLV Pkts, 0 Error ETS Conf TLV Pkts
 0 Input ETS Reco TLV pkts, 0 Output ETS Reco TLV pkts, 0 Error ETS Reco TLV Pkts
 0 Input Appln Priority TLV pkts, 0 Output Appln Priority TLV pkts, 0 Error Appln
Priority TLV Pkts
```

```
Total DCBX Frames transmitted 0
Total DCBX Frames received 0
Total DCBX Frame errors 0
Total DCBX Frames unrecognized 0
```

```
Interface ethernet1/1/5
 Port Role is Manual
 DCBX Operational Status is Disabled
 Reason: Port Shutdown
 Is Configuration Source? FALSE
 Local DCBX Compatibility mode is AUTO
 Local DCBX Configured mode is AUTO
 Peer Operating version is Not Detected
 Local DCBX TLVs Transmitted: erpfi
 0 Input PFC TLV pkts, 0 Output PFC TLV pkts, 0 Error PFC pkts
 0 Input ETS Conf TLV Pkts, 0 Output ETS Conf TLV Pkts, 0 Error ETS Conf TLV Pkts
 0 Input ETS Reco TLV pkts, 0 Output ETS Reco TLV pkts, 0 Error ETS Reco TLV Pkts
 0 Input Appln Priority TLV pkts, 0 Output Appln Priority TLV pkts, 0 Error Appln
Priority TLV Pkts
```

```
Total DCBX Frames transmitted 0
Total DCBX Frames received 0
Total DCBX Frame errors 0
Total DCBX Frames unrecognized 0
```

```
Interface ethernet1/1/6
 Port Role is Manual
 DCBX Operational Status is Disabled
 Reason: Port Shutdown
 Is Configuration Source? FALSE
 Local DCBX Compatibility mode is AUTO
 Local DCBX Configured mode is AUTO
 Peer Operating version is Not Detected
 Local DCBX TLVs Transmitted: erpfi
 0 Input PFC TLV pkts, 0 Output PFC TLV pkts, 0 Error PFC pkts
 0 Input ETS Conf TLV Pkts, 0 Output ETS Conf TLV Pkts, 0 Error ETS Conf TLV Pkts
 0 Input ETS Reco TLV pkts, 0 Output ETS Reco TLV pkts, 0 Error ETS Reco TLV Pkts
 0 Input Appln Priority TLV pkts, 0 Output Appln Priority TLV pkts, 0 Error Appln
```



#### Priority TLV Pkts

```
Total DCBX Frames transmitted 0
Total DCBX Frames received 0
Total DCBX Frame errors 0
Total DCBX Frames unrecognized 0
```

<output truncated for brevity>

View DCBX configuration on an interface:

```
OS10# show lldp dcbx interface ethernet 1/1/15
```

```
E-ETS Configuration TLV enabled e-ETS Configuration TLV disabled
R-ETS Recommendation TLV enabled r-ETS Recommendation TLV disabled
P-PFC Configuration TLV enabled p-PFC Configuration TLV disabled
F-Application priority for FCOE enabled f-Application Priority for FCOE disabled
I-Application priority for iSCSI enabled i-Application Priority for iSCSI disabled
```

```

-
Interface ethernet1/1/15
 Port Role is Manual
 DCBX Operational Status is Enabled
 Is Configuration Source? FALSE
 Local DCBX Compatibility mode is CEE
 Local DCBX Configured mode is CEE
 Peer Operating version is CEE
 Local DCBX TLVs Transmitted: ErPFI
```

#### Local DCBX Status

```

DCBX Operational Version is 0
DCBX Max Version Supported is 0
Sequence Number: 14
Acknowledgment Number: 5
Protocol State: In-Sync
```

#### Peer DCBX Status

```

DCBX Operational Version is 0
DCBX Max Version Supported is 255
Sequence Number: 5
Acknowledgment Number: 14
 220 Input PFC TLV pkts, 350 Output PFC TLV pkts, 0 Error PFC pkts
 220 Input PG TLV Pkts, 396 Output PG TLV Pkts, 0 Error PG TLV Pkts
 71 Input Appln Priority TLV pkts, 80 Output Appln Priority TLV pkts, 0 Error Appln
Priority TLV Pkts
```

```
Total DCBX Frames transmitted 538
Total DCBX Frames received 220
Total DCBX Frame errors 0
Total DCBX Frames unrecognized 0
```

#### View DCBX PFC TLV status

```
OS10# show lldp dcbx interface ethernet 1/1/15 pfc detail
```

```
Interface ethernet1/1/15
 Admin mode is on
 Admin is enabled, Priority list is 4,5,6,7
 Remote is enabled, Priority list is 4,5,6,7
 Remote Willing Status is disabled
 Local is enabled, Priority list is 4,5,6,7
 Oper status is init
 PFC DCBX Oper status is Up
 State Machine Type is Feature
 PFC TLV Tx Status is enabled
 Application Priority TLV Parameters :

 iSCSI TLV Tx Status is enabled
```

Local ISCSI PriorityMap is 0x10  
Remote ISCSI PriorityMap is 0x10

220 Input TLV pkts, 350 Output TLV pkts, 0 Error pkts  
71 Input Appln Priority TLV pkts, 80 Output Appln Priority TLV pkts, 0 Error Appln  
Priority TLV Pkts

### View DCBX ETS TLV status

OS10# show lldp dcbx interface ethernet 1/1/15 ets detail

Interface ethernet1/1/15  
Max Supported PG is 8  
Number of Traffic Classes is 8  
Admin mode is on

Admin Parameters :

-----  
Admin is enabled

| PG-grp | Priority# | Bandwidth | TSA |
|--------|-----------|-----------|-----|
| 0      | 0,1,2,3   | 70%       | ETS |
| 1      | 4,5,6,7   | 30%       | ETS |
| 2      |           | 0%        | SP  |
| 3      |           | 0%        | SP  |
| 4      |           | 0%        | SP  |
| 5      |           | 0%        | SP  |
| 6      |           | 0%        | SP  |
| 7      |           | 0%        | SP  |
| 15     |           | 0%        | SP  |

Remote Parameters :

-----  
Remote is enabled

| PG-grp | Priority# | Bandwidth | TSA |
|--------|-----------|-----------|-----|
| 0      | 0,1,2,3   | 70%       | ETS |
| 1      | 4,5,6,7   | 30%       | ETS |
| 2      |           | 0%        | SP  |
| 3      |           | 0%        | SP  |
| 4      |           | 0%        | SP  |
| 5      |           | 0%        | SP  |
| 6      |           | 0%        | SP  |
| 7      |           | 0%        | SP  |
| 15     |           | 0%        | SP  |

Remote Willing Status is disabled

Local Parameters :

-----  
Local is enabled

| PG-grp | Priority# | Bandwidth | TSA |
|--------|-----------|-----------|-----|
| 0      | 0,1,2,3   | 70%       | ETS |
| 1      | 4,5,6,7   | 30%       | ETS |
| 2      |           | 0%        | SP  |
| 3      |           | 0%        | SP  |
| 4      |           | 0%        | SP  |
| 5      |           | 0%        | SP  |
| 6      |           | 0%        | SP  |
| 7      |           | 0%        | SP  |
| 15     |           | 0%        | SP  |

Oper status is init  
ETS DCBX Oper status is Up  
State Machine Type is Feature  
Conf TLV Tx Status is enabled  
Reco TLV Tx Status is disabled

220 Input Conf TLV Pkts, 396 Output Conf TLV Pkts, 0 Error Conf TLV Pkts

## DCBX commands

### dcbx enable

Enables DCBX globally on all interfaces.

**Syntax** `dcbx enable`

**Parameters** None

**Default** Disabled

**Command Mode** CONFIGURATION

**Usage Information** DCBX is disabled at a global level and enabled at an interface level by default. For DCBX to be operational, DCBX must be enabled at both the global and interface levels. Enable DCBX globally using the `dcbx enable` command to activate the exchange of DCBX TLV messages with PFC, ETS, and iSCSI configurations. To configure the TLVs advertised by a DCBX-enabled port, change the DCBX version, or disable DCBX on an interface, use DCBX interface-level commands. DCBX allows peers to advertise a DCB configuration using LLDP and self-configure with compatible settings. If you disable DCBX globally on a switch, you can reenabling it to ensure consistent operation of peers in a converged data center network.

**Example**

```
OS10(config)# dcbx enable
```

**Supported Releases** 10.3.0E or later

### dcbx tlv-select

Configures the DCB TLVs advertised by a DCBX-enabled port.

**Syntax** `dcbx tlv-select {[ets-conf] [ets-reco] [pfc]}`

**Parameters**

- `ets-conf` — Advertise ETS configuration TLVs.
- `ets-reco` — Advertise ETS recommendation TLVs.
- `pfc` — Advertise PFC TLVs.

**Default** Enabled

**Command Mode** INTERFACE

**Usage Information** A DCBX-enabled port advertises all TLVs to DCBX peers by default. If PFC or ETS TLVs advertisement is disabled, enter the command to reenabling the TLVs advertisements. You can enable multiple TLV options, such as `ets-conf`, `ets-reco`, and `pfc` with the same command.

**Example**

```
OS10(config-if-eth1/1/2)# dcbx tlv-select ets-conf pfc
```

**Supported Releases** 10.3.0E or later

### dcbx version

Configures the DCBX version that is used on a port interface.

**Syntax** `dcbx version {auto | cee | ieee}`

**Parameters**

- `auto` — Select the DCBX version automatically based on the peer response.
- `cee` — Set the DCBX version to CEE.
- `ieee` — Set the DCBX version to IEEE 802.1Qaz.

**Default** Auto

|                           |                                                                                                                                                                                                                                            |
|---------------------------|--------------------------------------------------------------------------------------------------------------------------------------------------------------------------------------------------------------------------------------------|
| <b>Command Mode</b>       | INTERFACE                                                                                                                                                                                                                                  |
| <b>Usage Information</b>  | In Auto mode, a DCBX-enabled port detects an incompatible DCBX version on a peer device port and automatically reconfigures a compatible version on the local port. The <code>no</code> version of this command disables the DCBX version. |
| <b>Example</b>            | <pre>OS10(conf-if-eth1/1/2)# dcbx version cee</pre>                                                                                                                                                                                        |
| <b>Supported Releases</b> | 10.3.0E or later                                                                                                                                                                                                                           |

## debug dcbx

Enables DCBX debugging.

|                            |                                                                                                                                                                                                                                                                                                                                                                                      |
|----------------------------|--------------------------------------------------------------------------------------------------------------------------------------------------------------------------------------------------------------------------------------------------------------------------------------------------------------------------------------------------------------------------------------|
| <b>Syntax</b>              | <code>debug dcbx {all   events   tlv} [interface ethernet <i>node/slot/port</i>]</code>                                                                                                                                                                                                                                                                                              |
| <b>Parameters</b>          | <ul style="list-style-type: none"> <li>• <code>all</code>—Enables all DCBX debugging logs.</li> <li>• <code>events</code>—Enables DCBX-event-related logs.</li> <li>• <code>tlv</code>—Enables DCBX TLV-related logs.</li> <li>• <code>interface ethernet <i>node/slot/port</i></code>—Enter the interface information for which you want to collect the DCBX debug logs.</li> </ul> |
| <b>Defaults</b>            | Disabled                                                                                                                                                                                                                                                                                                                                                                             |
| <b>Command Mode</b>        | EXEC                                                                                                                                                                                                                                                                                                                                                                                 |
| <b>Security and Access</b> | Netadmin and sysadmin                                                                                                                                                                                                                                                                                                                                                                |
| <b>Usage Information</b>   | <p>Before you use the <code>debug dcbx</code> command, ensure that you run the following commands:</p> <ul style="list-style-type: none"> <li>• <code>logging enable</code></li> <li>• <code>logging console enable</code></li> <li>• <code>terminal monitor</code></li> </ul> <p>OS10 does not support the interface range option with this command.</p>                            |
| <b>Example</b>             | <pre>OS10# debug dcbx tlv</pre>                                                                                                                                                                                                                                                                                                                                                      |
| <b>Supported Releases</b>  | 10.5.1.0 or later                                                                                                                                                                                                                                                                                                                                                                    |

## lldp tlv-select dcbxp

Enables and disables DCBX on a port interface.

|                          |                                                                                                                                                                                                                                                                                                                                                                                                                                                       |
|--------------------------|-------------------------------------------------------------------------------------------------------------------------------------------------------------------------------------------------------------------------------------------------------------------------------------------------------------------------------------------------------------------------------------------------------------------------------------------------------|
| <b>Syntax</b>            | <code>lldp tlv-select dcbxp</code>                                                                                                                                                                                                                                                                                                                                                                                                                    |
| <b>Parameters</b>        | None                                                                                                                                                                                                                                                                                                                                                                                                                                                  |
| <b>Default</b>           | Enabled interface level; disabled global level                                                                                                                                                                                                                                                                                                                                                                                                        |
| <b>Command Mode</b>      | INTERFACE                                                                                                                                                                                                                                                                                                                                                                                                                                             |
| <b>Usage Information</b> | DCBX must be enabled at both the global and interface levels. Enable DCBX globally using the <code>dcbx enable</code> command to activate the exchange of DCBX TLV messages with PFC, ETS, and iSCSI configurations. To configure the TLVs advertised by a DCBX-enabled port, change the DCBX version, or disable DCBX on an interface, use DCBX interface-level commands. The <code>no</code> version of this command disables DCBX on an interface. |
| <b>Example</b>           | <pre>OS10(conf-if-eth1/1/1)# lldp tlv-select dcbxp</pre>                                                                                                                                                                                                                                                                                                                                                                                              |

**Supported Releases** 10.3.0E or later

## show debug dcbx

Displays the list of debug options that are enabled for DCBX.

**Syntax** show debug dcbx

**Parameters** None

**Command Mode** EXEC

**Usage Information** None

### Example

```
OS10# show debug dcbx
Dcbx debug settings:

debug dcbx all
 no debug dcbx events interface mgmt
 debug dcbx pdu in interface ethernet 1/1/1
```

**Supported Releases** 10.5.1.0 or later

## show lldp dcbx

Displays the DCBX configuration and PFC or ETS TLV status on an interface.

**Syntax** show lldp dcbx {detail | ets detail | pfc detail | interface ethernet *node/slot/port[:subport]* [ets detail | pfc detail]}

- Parameters**
- detail — Display DCBX configuration information of all the interfaces in detail.
  - interface ethernet *node/slot/port[:subport]* — Enter interface information.
  - ets detail — Display the ETS TLV status and operation with DCBX peers.
  - pfc detail — Display the PFC TLV status and operation with DCBX peers.

**Default** Not configured

**Command Mode** EXEC

**Usage Information** Enable DCBX before using this command. DCBX advertises all TLVs — PFC, ETS Recommendation, ETS Configuration, DCBXP, and basic TLVs by default.

 **NOTE:** In the command output, the `Is configuration source` parameter always displays `False`. `Configuration source` is the type of port role that is not supported.

### Example (DCBX detail)

```
OS10# show lldp dcbx detail | no-more
E-ETS Configuration TLV enabled e-ETS Configuration TLV disabled
R-ETS Recommendation TLV enabled r-ETS Recommendation TLV disabled
P-PFC Configuration TLV enabled p-PFC Configuration TLV disabled
F-Application priority for FCOE f-Application Priority for FCOE
 enabled disabled
I-Application priority for iSCSI i-Application Priority for iSCSI
 enabled disabled

Interface ethernet1/1/1
 Port Role is Manual
 DCBX Operational Status is Disabled
 Reason: Port Shutdown
 Is Configuration Source? FALSE
 Local DCBX Compatibility mode is AUTO
```

```

Local DCBX Configured mode is AUTO
Peer Operating version is Not Detected
Local DCBX TLVs Transmitted: erpfi
0 Input PFC TLV pkts, 0 Output PFC TLV pkts, 0 Error PFC pkts
0 Input ETS Conf TLV Pkts, 0 Output ETS Conf TLV Pkts,
0 Error ETS Conf TLV Pkts
0 Input ETS Reco TLV pkts, 0 Output ETS Reco TLV pkts,
0 Error ETS Reco TLV Pkts
0 Input Appln Priority TLV pkts, 0 Output Appln Priority TLV pkts,
0 Error Appln Priority TLV Pkts

Total DCBX Frames transmitted 0
Total DCBX Frames received 0
Total DCBX Frame errors 0
Total DCBX Frames unrecognized 0

Interface ethernet1/1/2
Port Role is Manual
DCBX Operational Status is Disabled
Reason: Port Shutdown
Is Configuration Source? FALSE
Local DCBX Compatibility mode is AUTO
Local DCBX Configured mode is AUTO
Peer Operating version is Not Detected
Local DCBX TLVs Transmitted: erpfi
0 Input PFC TLV pkts, 0 Output PFC TLV pkts, 0 Error PFC pkts
0 Input ETS Conf TLV Pkts, 0 Output ETS Conf TLV Pkts,
0 Error ETS Conf TLV Pkts
0 Input ETS Reco TLV pkts, 0 Output ETS Reco TLV pkts,
0 Error ETS Reco TLV Pkts
0 Input Appln Priority TLV pkts, 0 Output Appln Priority TLV pkts,
0 Error Appln Priority TLV Pkts

Total DCBX Frames transmitted 0
Total DCBX Frames received 0
Total DCBX Frame errors 0
Total DCBX Frames unrecognized 0

Interface ethernet1/1/3
Port Role is Manual
DCBX Operational Status is Disabled
Reason: Port Shutdown
Is Configuration Source? FALSE
Local DCBX Compatibility mode is AUTO
Local DCBX Configured mode is AUTO
Peer Operating version is Not Detected
Local DCBX TLVs Transmitted: erpfi
0 Input PFC TLV pkts, 0 Output PFC TLV pkts, 0 Error PFC pkts
0 Input ETS Conf TLV Pkts, 0 Output ETS Conf TLV Pkts,
0 Error ETS Conf TLV Pkts
0 Input ETS Reco TLV pkts, 0 Output ETS Reco TLV pkts,
0 Error ETS Reco TLV Pkts
0 Input Appln Priority TLV pkts, 0 Output Appln Priority TLV pkts,
0 Error Appln Priority TLV Pkts

Total DCBX Frames transmitted 0
Total DCBX Frames received 0
Total DCBX Frame errors 0
Total DCBX Frames unrecognized 0

<output truncated for brevity>

```

**Example  
(interface)**

```

OS10# show lldp dcbx interface ethernet 1/1/15
E-ETS Configuration TLV enabled e-ETS Configuration TLV disabled
R-ETS Recommendation TLV enabled r-ETS Recommendation TLV disabled
P-PFC Configuration TLV enabled p-PFC Configuration TLV disabled
F-Application priority for FCOE f-Application Priority for FCOE
enabled disabled
I-Application priority for iSCSI i-Application Priority for iSCSI
enabled disabled

```

```

Interface ethernet1/1/15
 Port Role is Manual
 DCBX Operational Status is Enabled
 Is Configuration Source? FALSE
 Local DCBX Compatibility mode is IEEEv2.5
 Local DCBX Configured mode is IEEEv2.5
 Peer Operating version is IEEEv2.5
 Local DCBX TLVs Transmitted: ERPfI
 5 Input PFC TLV pkts, 2 Output PFC TLV pkts, 0 Error PFC pkts
 5 Input ETS Conf TLV Pkts, 2 Output ETS Conf TLV Pkts,
 0 Error ETS Conf TLV Pkts
 5 Input ETS Reco TLV pkts, 2 Output ETS Reco TLV pkts,
 0 Error ETS Reco TLV Pkts
 5 Input Appln Priority TLV pkts, 2 Output Appln Priority TLV pkts,
 0 Error Appln Priority TLV Pkts

Total DCBX Frames transmitted 8
Total DCBX Frames received 20
Total DCBX Frame errors 0
Total DCBX Frames unrecognized 0

```

**Example (ETS detail on an interface)**

```

OS10# show lldp dcbx interface ethernet 1/1/15 ets detail
Interface ethernet1/1/15
Max Supported PG is 8
Number of Traffic Classes is 8
Admin mode is on

Admin Parameters :

Admin is enabled

PG-grp Priority# Bandwidth TSA

0 0,1,2,3 70% ETS
1 4,5,6,7 30% ETS
2 0% 0% SP
3 0% 0% SP
4 0% 0% SP
5 0% 0% SP
6 0% 0% SP
7 0% 0% SP

Remote Parameters :

Remote is enabled

PG-grp Priority# Bandwidth TSA

0 0,1,2,3 70% ETS
1 4,5,6,7 30% ETS
2 0% 0% SP
3 0% 0% SP
4 0% 0% SP
5 0% 0% SP
6 0% 0% SP
7 0% 0% SP

Remote Willing Status is disabled
Local Parameters :

Local is enabled

PG-grp Priority# Bandwidth TSA

0 0,1,2,3 70% ETS
1 4,5,6,7 30% ETS
2 0% 0% SP
3 0% 0% SP
4 0% 0% SP

```

```

5 0% SP
6 0% SP
7 0% SP

Oper status is init
ETS DCBX Oper status is Up
State Machine Type is Asymmetric
Conf TLV Tx Status is enabled
Reco TLV Tx Status is enabled

5 Input Conf TLV Pkts, 2 Output Conf TLV Pkts, 0 Error Conf TLV Pkts
5 Input Reco TLV Pkts, 2 Output Reco TLV Pkts, 0 Error Reco TLV Pkts

```

### Example (PFC detail)

```

OS10# show lldp dcbx interface ethernet 1/1/15 pfc detail
Interface ethernet1/1/15
 Admin mode is on
 Admin is enabled, Priority list is 4,5,6,7
 Remote is enabled, Priority list is 4,5,6,7
 Remote Willing Status is disabled
 Local is enabled, Priority list is 4,5,6,7
 Oper status is init
 PFC DCBX Oper status is Up
 State Machine Type is Symmetric
 PFC TLV Tx Status is enabled
 Application Priority TLV Parameters :

 ISCSI TLV Tx Status is enabled
 Local ISCSI PriorityMap is 0x10
 Remote ISCSI PriorityMap is 0x10

 5 Input TLV pkts, 2 Output TLV pkts, 0 Error pkts
 5 Input Appln Priority TLV pkts, 2 Output Appln Priority TLV pkts,
 0 Error Appln Priority TLV Pkts

```

### Supported Releases

10.3.0E or later

## Internet small computer system interface

iSCSI is a TCP/IP-based protocol that establishes and manages connections between servers and storage devices in a data center network. After you enable iSCSI, iSCSI optimization automatically detects Dell EMC EqualLogic storage arrays that are directly attached to switch ports. To support storage arrays where autodetection is not supported, manually configure iSCSI optimization using the `iscsi profile-storage name` command.

iSCSI optimization enables a switch to autodetect Dell EMC iSCSI storage arrays and autoconfigure switch ports to improve storage traffic throughput. The switch monitors iSCSI sessions and applies QoS policies on iSCSI traffic. iSCSI optimization operates with or without DCBX over an Ethernet network.

- iSCSI uses the current flow-control configuration by default. If you do not configure flow-control, iSCSI autoconfigures flow control settings so that receive-only is enabled and transmit-only is disabled.
- The switch monitors and tracks active iSCSI sessions, including port information and iSCSI session information.
- A user-configured iSCSI CoS profile applies to all iSCSI traffic. Use classifier rules to direct the iSCSI data traffic to queues with preferential QoS treatment over other data passing through the switch. Preferential treatment helps to avoid session interruptions during times of congestion that would otherwise cause dropped iSCSI packets.



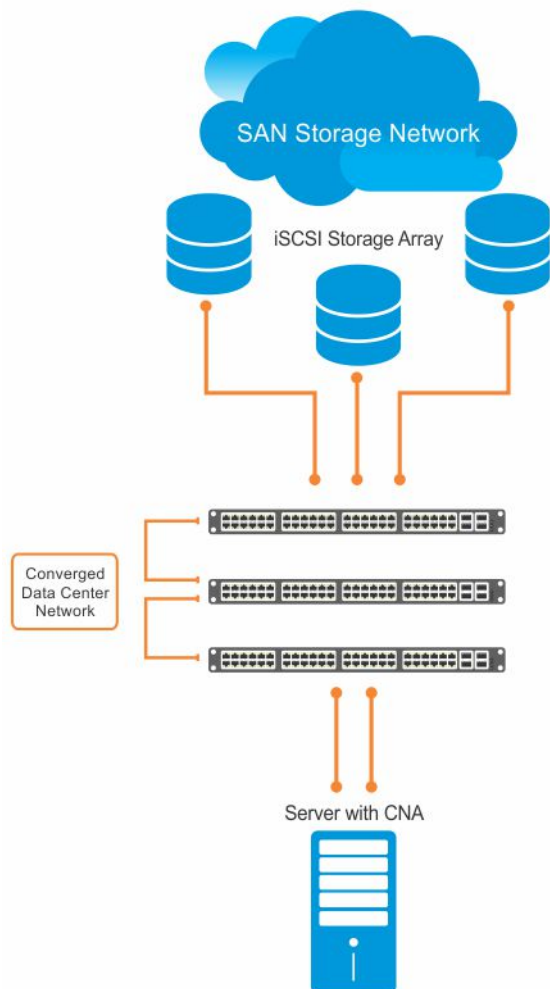

In an iSCSI session, a switch connects CNA servers (iSCSI initiators) to a storage array (iSCSI targets) in a SAN or TCP/IP network. iSCSI optimization running on the switch uses dot1p priority-queue assignments to ensure that iSCSI traffic receives priority treatment.

## iSCSI configuration notes

- Enable iSCSI optimization so the switch autodetects and autoconfigures Dell EMC EqualLogic storage arrays that are directly connected to an interface. iSCSI automatically configures switch parameters after connection to a storage device is verified. Enable an interface to support a storage device that is directly connected to a port, but not automatically detected by iSCSI.
- Enable iSCSI session monitoring and the aging time for iSCSI sessions. iSCSI monitoring sessions listen on TCP ports 860 and 3260 by default.
- Configure the CoS/DSCP values applied to ingress iSCSI flows — create a `class-iscsi` class map in POLICY-CLASS-MAP mode.
- Enable LLDP to use iSCSI. The DCBX application TLV carries information about the dot1p priorities to use when sending iSCSI traffic. This informational TLV is packaged in LLDP PDUs. You can reconfigure the 802.1p priority bits advertised in the TLVs.

## Configure iSCSI optimization

The iSCSI protocol provides storage traffic TCP/IP transport between servers and storage arrays in a network using iSCSI commands.

1. Configure an interface or interface range to detect a connected storage device.

```
interface ethernet node/slot/port:[subport]
interface range ethernet node/slot/port:[subport]-node/slot/port[:subport]
```

2. Enable the interface to support a storage device that is directly connected to the port and not automatically detected by iSCSI. Use this command for storage devices that do not support LLDP. The switch autodetects and autoconfigures Dell EMC EqualLogic storage arrays that are directly connected to an interface when you enable iSCSI optimization.

```
iscsi profile-storage storage-device-name
```

3. Configure DCBX to use LLDP to send iSCSI application TLVs with dot1p priorities for iSCSI traffic in INTERFACE mode.

```
lldp tlv-select dcbxp-appln iscsi
```

4. Return to CONFIGURATION mode.

```
exit
```

5. (Optional) If necessary, reconfigure the iSCSI TCP ports and IP addresses of target storage devices in CONFIGURATION mode. Separate TCP port numbers with a comma, from 0 to 65535; default 860 and 3260.

```
iscsi target port tcp-port1 [tcp-port2, ..., tcp-port16] [ip-address ip-address]
```

6. Configure the QoS policy applied to ingress iSCSI flows. Apply the service policy to ingress interfaces in CONFIGURATION mode.

(Optional) Reset the default CoS dot1p priority, the default is 4 and/or the trusted DCSP value that is used for iSCSI traffic. Assign an internal qos-group queue, from 0 to 7, to dot1p, from 0 to 7, and DSCP, from 0 to 63, values in POLICY-CLASS-MAP mode.

```
class-map type application class-iscsi
policy-map type application policy-iscsi
 class class-iscsi
 set qos-group traffic-class-number
 set cos dot1p-priority
 set dscp dscp-value
 end
service-policy type application policy-iscsi
```

7. Enable iSCSI monitoring sessions on TCP ports in CONFIGURATION mode.

```
iscsi session-monitoring enable
```

8. (Optional) Set the aging time for the length of iSCSI monitoring sessions in CONFIGURATION mode, 5 to 43,200 minutes; default 10.

```
iscsi aging time [minutes]
```

9. (Optional) Reconfigure the dot1p priority bits advertised in iSCSI application TLVs in CONFIGURATION mode. The default bitmap is 0x10 (dot1p 4). The default dot1p 4 value is sent in iSCSI application TLVs only if you enabled the PFC pause for dot1p 4 traffic using the pfc-cos dot1p-priority command.

If you do not configure an iscsi priority-bits dot1p value and you configure a set cos value in Step 6, the set cos value is sent in iSCSI application TLVs. If you configure neither the iscsi priority-bits nor the set cos value, the default dot1p 4 advertises.

```
iscsi priority-bits dot1p-bitmap
```

10. Enable iSCSI auto-detection and autoconfiguration on the switch in CONFIGURATION mode.

```
iscsi enable
```

### Configure iSCSI optimization

```
OS10(config)# interface ethernet 1/1/1
OS10(conf-if-eth1/1/1)# iscsi profile-storage compellent
OS10(conf-if-eth1/1/1)# lldp tlv-select dcbxp-appln iscsi
OS10(conf-if-eth1/1/1)# exit
```

```

OS10(config)# iscsi target port 3261 ip-address 10.1.1.1
OS10(config)# policy-map type application policy-iscsi
OS10(config-pmap-application)# class class-iscsi
OS10 (config-pmap-c-app)# set qos-group 4
OS10 (config-pmap-c-app)# set cos 4
OS10 (config-pmap-c-app)# exit
OS10(config-pmap-application)# exit

OS10(config)# system qos
OS10(config-sys-qos)# service-policy type application policy-iscsi
OS10(config-sys-qos)# exit

OS10(config)# iscsi session-monitoring enable
OS10(config)# iscsi aging time 15
OS10(config)# iscsi priority-bits 0x20
OS10(config)# iscsi enable

```

## View iSCSI optimization

```

OS10# show iscsi
iSCSI Auto configuration is Enabled
iSCSI session monitoring is Enabled
iSCSI COS qos-group 4 remark dot1p 4
Session aging time 15
Maximum number of connections is 100
Port IP Address

3260
860
3261 10.1.1.1

```

```

OS10# show iscsi session detailed
Session 1

Target:iqn.2001-05.com.equallogic:0-8a0906-00851a00c-98326939fba510a1-517
Initiator:iqn.1991-05.com.microsoft:win-rlkpjo4jun2
Up Time:00:00:18:12(DD:HH:MM:SS)
Time for aging out:29:23:59:35(DD:HH:MM:SS)
ISID:400001370000
Initiator Initiator Target Target Connection
IP Address TCP Port IP Address TCP Port ID

10.10.10.210 54748 10.10.10.40 3260 1

Session 2

Target:iqn.2001-05.com.equallogic:0-8a0906-01251a00c-8ab26939fbd510a1-518
Initiator:iqn.1991-05.com.microsoft:win-rlkpjo4jun2
Up Time:00:00:16:02(DD:HH:MM:SS)
Time for aging out:29:23:59:35(DD:HH:MM:SS)
ISID:400001370000
Initiator Initiator Target Target Connection
IP Address TCP Port IP Address TCP Port ID

10.10.10.210 54835 10.10.10.40 3260 1

```

```

OS10# show iscsi storage-devices
Interface Name Storage Device Name Auto Detected Status

ethernet1/1/23 EQL-MEM true

```

## Configuration notes

All Dell EMC PowerSwitches except MX-Series, S4200-Series, S5200 Series, and Z9332F-ON:

- Do not change the description of a Dell SC series storage device; for example, Storage Center 65849 SC9000 Version 07.02.01.138. If you change the description, the SC storage device is not detected by the iSCSI autoconfiguration.
- iSCSI auto-configuration on OS10 switch ports is not supported with Compellent storage arrays that use QLE4062 network adapters. To manually configure iSCSI, use the `iscsi profile-storage storage-device-name` command.

- Starting from release 10.4.1.1, when you perform a fresh installation of OS10, iSCSI autoconfig is enabled and flowcontrol receive is set to on. However, when you upgrade from an earlier release to release 10.4.1.1 or later, the existing iSCSI configuration is retained and the flowcontrol receive could be set to on or off, depending on the iSCSI configuration before the upgrade.
- When you re-configure the iSCSI TCP ports and IP addresses of target storage devices at the same time using the `iscsi target port` command, iSCSI optimization may fail on interfaces connected to the devices. To successfully enable iSCSI optimization, enter only the new TCP port number(s) in the command and do not specify an IP address
- On an S3048-ON switch, iSCSI auto-configuration is disabled, by default. You must manually enable iSCSI optimization on the switch using the `iscsi enable` command.

## iSCSI synchronization on VLT

An iSCSI session is learned on a VLT LAG during the following scenarios:

- If the iSCSI session receives control packets, as login-request or login-response, on the VLT LAG.
- If the iSCSI session does not receive control packets but receives data packets on the VLT LAG. This happens when you enable iSCSI session monitoring after the iSCSI session starts.

The information learned about iSCSI sessions on VLT LAGs synchronizes with the VLT peers.

iSCSI session synchronization happens based on various scenarios:

- If the iSCSI login request is received on an interface that belongs to a VLT LAG, the information synchronizes with VLT peer and the connection associates with the interface.
- Any updates to connections, including aging updates that are learned on VLT LAG members synchronizes with the VLT peer.
- If the iSCSI login request is received on a non-VLT interface, followed by a response from a VLT interface, the connection is associated with the VLT LAG interface and the information about the session synchronizes with the VLT peer.
- When a VLT interconnect comes up, information about iSCSI sessions learned on the VLT LAG exchanges between the VLT-peers.

## iSCSI commands

### iscsi aging

Sets the aging time for monitored iSCSI sessions.

|                           |                                                                                                                                                                                    |
|---------------------------|------------------------------------------------------------------------------------------------------------------------------------------------------------------------------------|
| <b>Syntax</b>             | <code>iscsi aging [time <i>minutes</i>]</code>                                                                                                                                     |
| <b>Parameters</b>         | <code>time <i>minutes</i></code> — Enter the aging time in minutes allowed for monitoring iSCSI sessions, from 5 to 43,200.                                                        |
| <b>Default</b>            | 10 minutes                                                                                                                                                                         |
| <b>Command Mode</b>       | CONFIGURATION                                                                                                                                                                      |
| <b>Usage Information</b>  | Configure the aging time that is allowed for monitored iSCSI sessions on TCP ports before the session closes. The <code>no</code> version of this command disables the aging time. |
| <b>Example</b>            | <pre>OS10(config)# iscsi aging time 30</pre>                                                                                                                                       |
| <b>Supported Releases</b> | 10.3.0E or later                                                                                                                                                                   |

### iscsi enable

Enables iSCSI autodetection of attached storage arrays and switch autoconfiguration.

|                  |                           |
|------------------|---------------------------|
| <b>Syntax</b>    | <code>iscsi enable</code> |
| <b>Parameter</b> | None                      |
| <b>Default</b>   | None                      |

|                           |                                                                                                                                                                                                                                                                                                                                                                                                                                                                                                                                                                                                                                           |
|---------------------------|-------------------------------------------------------------------------------------------------------------------------------------------------------------------------------------------------------------------------------------------------------------------------------------------------------------------------------------------------------------------------------------------------------------------------------------------------------------------------------------------------------------------------------------------------------------------------------------------------------------------------------------------|
| <b>Command Mode</b>       | CONFIGURATION                                                                                                                                                                                                                                                                                                                                                                                                                                                                                                                                                                                                                             |
| <b>Usage Information</b>  | iSCSI optimization automatically detects storage arrays and autoconfigures switch ports with the iSCSI parameters that are received from a connected device. The <code>no</code> version of this command disables iSCSI autodetection.<br><br>Starting from release 10.4.1.1, when you perform a fresh installation of OS10, iSCSI autoconfig is enabled and flow control receive is set to on. However, when you upgrade from an earlier release to release 10.4.1.1 or later, the existing iSCSI configuration is retained and the flow control receive could be set to on or off, depending on the iSCSI configuration before upgrade. |
| <b>Example</b>            | <pre>OS10(config)# iscsi enable</pre>                                                                                                                                                                                                                                                                                                                                                                                                                                                                                                                                                                                                     |
| <b>Supported Releases</b> | 10.3.0E or later                                                                                                                                                                                                                                                                                                                                                                                                                                                                                                                                                                                                                          |

## iscsi priority-bits

Resets the priority bitmap that is advertised in iSCSI application TLVs.

|                           |                                                                                                                                                                                                                                                                                                                                                                                                                                                                                                         |
|---------------------------|---------------------------------------------------------------------------------------------------------------------------------------------------------------------------------------------------------------------------------------------------------------------------------------------------------------------------------------------------------------------------------------------------------------------------------------------------------------------------------------------------------|
| <b>Syntax</b>             | <code>iscsi priority-bits {priority-bitmap}</code>                                                                                                                                                                                                                                                                                                                                                                                                                                                      |
| <b>Parameter</b>          | <i>priority-bitmap</i> — Enter a bitmap value for the dot1p priority advertised for iSCSI traffic in iSCSI application TLVs (0x1 to 0xff).                                                                                                                                                                                                                                                                                                                                                              |
| <b>Default</b>            | 0x10 (dot1p 4)                                                                                                                                                                                                                                                                                                                                                                                                                                                                                          |
| <b>Command Mode</b>       | CONFIGURATION                                                                                                                                                                                                                                                                                                                                                                                                                                                                                           |
| <b>Usage Information</b>  | iSCSI traffic uses dot1p priority 4 in frame headers by default. Use this command to reconfigure the dot1p-priority bits advertised in iSCSI application TLVs. Enter only one dot1p-bitmap value — setting more than one bitmap value with this command is not supported. The default dot1p 4 value advertises only if you enabled PFC pause frames for dot1p 4 traffic using the <code>pfc-cos dot1p-priority</code> command. The <code>no</code> version of this command resets to the default value. |
| <b>Example</b>            | <pre>OS10(config)# iscsi priority-bits 0x20</pre>                                                                                                                                                                                                                                                                                                                                                                                                                                                       |
| <b>Supported Releases</b> | 10.3.0E or later                                                                                                                                                                                                                                                                                                                                                                                                                                                                                        |

## iscsi profile-storage

Configures a port for direct connection to a storage device that is not automatically detected by iSCSI.

|                           |                                                                                                                                                                                                                                                    |
|---------------------------|----------------------------------------------------------------------------------------------------------------------------------------------------------------------------------------------------------------------------------------------------|
| <b>Syntax</b>             | <code>iscsi profile-storage storage-device-name</code>                                                                                                                                                                                             |
| <b>Parameter</b>          | <i>storage-device-name</i> — Enter a user-defined name of a storage array that iSCSI does not automatically detect.                                                                                                                                |
| <b>Default</b>            | Not configured                                                                                                                                                                                                                                     |
| <b>Command Mode</b>       | INTERFACE                                                                                                                                                                                                                                          |
| <b>Usage Information</b>  | Configure directly attached storage arrays that iSCSI supports if they are not automatically detected. This command is required for storage devices that do not support LLDP. The <code>no</code> version of this command disables the connection. |
| <b>Example</b>            | <pre>OS10(conf-if-eth1/1/2)# iscsi profile-storage compellant</pre>                                                                                                                                                                                |
| <b>Supported Releases</b> | 10.3.0E or later                                                                                                                                                                                                                                   |

## iscsi session-monitoring enable

Enables iSCSI session monitoring.

|                           |                                                                                                                                                                                                                                                                                                                                              |
|---------------------------|----------------------------------------------------------------------------------------------------------------------------------------------------------------------------------------------------------------------------------------------------------------------------------------------------------------------------------------------|
| <b>Syntax</b>             | <code>iscsi session-monitoring enable</code>                                                                                                                                                                                                                                                                                                 |
| <b>Parameter</b>          | None                                                                                                                                                                                                                                                                                                                                         |
| <b>Default</b>            | Disabled                                                                                                                                                                                                                                                                                                                                     |
| <b>Command Mode</b>       | CONFIGURATION                                                                                                                                                                                                                                                                                                                                |
| <b>Usage Information</b>  | To configure the aging timeout in iSCSI monitoring sessions, use the <code>iscsi aging time</code> command. To configure the TCP ports that listen for connected storage devices in iSCSI monitoring sessions use the <code>iscsi target port</code> command. The <code>no</code> version of this command disables iSCSI session monitoring. |
| <b>Example</b>            | <pre>OS10(config)# iscsi session-monitoring enable</pre>                                                                                                                                                                                                                                                                                     |
| <b>Supported Releases</b> | 10.3.0E or later                                                                                                                                                                                                                                                                                                                             |

## iscsi target port

Configures the TCP ports that are used to monitor iSCSI sessions with target storage devices.

|                           |                                                                                                                                                                                                                                                                                                                                          |
|---------------------------|------------------------------------------------------------------------------------------------------------------------------------------------------------------------------------------------------------------------------------------------------------------------------------------------------------------------------------------|
| <b>Syntax</b>             | <code>iscsi target port tcp-port1 [tcp-port2, ..., tcp-port16] [ip-address ip-address]</code>                                                                                                                                                                                                                                            |
| <b>Parameters</b>         | <ul style="list-style-type: none"><li><code>tcp-port</code> — Enter one or more TCP port numbers, from 0 to 65535. Separate TCP port numbers with a comma.</li><li><code>ip-address ip-address</code> — (Optional) Enter the IP address in A.B.C.D format of a storage array whose iSCSI traffic is monitored on the TCP port.</li></ul> |
| <b>Default</b>            | 3260,860                                                                                                                                                                                                                                                                                                                                 |
| <b>Command Mode</b>       | CONFIGURATION                                                                                                                                                                                                                                                                                                                            |
| <b>Usage Information</b>  | You can configure a maximum of 16 TCP ports to monitor iSCSI traffic from target storage devices. The <code>no</code> version of this command including the IP address deletes a TCP port from iSCSI monitoring.                                                                                                                         |
| <b>Example</b>            | <pre>OS10(config)# iscsi target port 26,40</pre>                                                                                                                                                                                                                                                                                         |
| <b>Supported Releases</b> | 10.3.0E or later                                                                                                                                                                                                                                                                                                                         |

## lldp tlv-select dcbxp-appln iscsi

Enables a port to advertise iSCSI application TLVs to DCBX peers.

|                          |                                                                                                                                                                                                                                                                                                                                                                                                                                                                                                                                                                                                                                                                |
|--------------------------|----------------------------------------------------------------------------------------------------------------------------------------------------------------------------------------------------------------------------------------------------------------------------------------------------------------------------------------------------------------------------------------------------------------------------------------------------------------------------------------------------------------------------------------------------------------------------------------------------------------------------------------------------------------|
| <b>Syntax</b>            | <code>lldp tlv-select dcbxp-appln iscsi</code>                                                                                                                                                                                                                                                                                                                                                                                                                                                                                                                                                                                                                 |
| <b>Parameter</b>         | None                                                                                                                                                                                                                                                                                                                                                                                                                                                                                                                                                                                                                                                           |
| <b>Default</b>           | iSCSI application TLVs are advertised to DCBX peers.                                                                                                                                                                                                                                                                                                                                                                                                                                                                                                                                                                                                           |
| <b>Command Mode</b>      | INTERFACE                                                                                                                                                                                                                                                                                                                                                                                                                                                                                                                                                                                                                                                      |
| <b>Usage Information</b> | DCB devices use DCBX to exchange iSCSI configuration information with peers and self-configure. iSCSI parameters exchange in time, length, and value (TLV) messages. DCBX requires LLDP enabled to advertise iSCSI application TLVs. iSCSI application TLVs advertise the PFC dot1p priority-bitmap configured using the <code>iscsi priority-bits</code> command to DCBX peers. If you do not configure an iSCSI dot1p-bitmap value, iSCSI application TLVs advertise dot1p 4 by default only if you configure dot1p 4 as a PFC priority using the <code>pfc-cos</code> command. The <code>no</code> version of this command disables iSCSI TLV transmission. |

**Example**

```
OS10(conf-if-eth1/1/1)# lldp tlv-select dcbxp-appln iscsi
```

**Supported Releases**

10.3.0E or later

## show iscsi

Displays the current configured iSCSI settings.

**Syntax** show iscsi

**Parameters** None

**Command Mode** EXEC

**Usage Information** This command output displays global iSCSI configuration settings. To view target and initiator information use the `show iscsi session` command.

**Example**

```
OS10# show iscsi
iSCSI Auto configuration is Enabled
iSCSI session monitoring is Enabled
iSCSI COS qos-group 4 remark dot1p 4
Session aging time 15
Maximum number of connections is 256
Port IP Address

3260
860
3261 10.1.1.1
```

**Supported Releases**

10.3.0E or later

## show iscsi session

Displays information about active iSCSI sessions.

**Syntax** show iscsi session [detailed]

**Parameter** detailed — Displays a detailed version of the active iSCSI sessions.

**Command Mode** EXEC

**Usage Information** In an iSCSI session, `Target` is the storage device, and `Initiator` is the server that is connected to the storage device.

**Example**

```
OS10# show iscsi session
```

**Example (detailed)**

```
OS10# show iscsi session detailed
Session 1

Target:iqn.2001-05.com.equallogic:0-8a0906-00851a00c-98326939fba510a1-517
Initiator:iqn.1991-05.com.microsoft:win-rlkpjo4jun2
Up Time:00:00:18:12 (DD:HH:MM:SS)
Time for aging out:29:23:59:35 (DD:HH:MM:SS)
ISID:400001370000
Initiator Initiator Target Target Connection
IP Address TCP Port IP Address TCP Port ID

10.10.10.210 54748 10.10.10.40 3260 1

Session 2

Target:iqn.2001-05.com.equallogic:0-8a0906-01251a00c-8ab26939fbd510a1-518
```

```

Initiator:ign.1991-05.com.microsoft:win-rlkpjo4jun2
Up Time:00:00:16:02 (DD:HH:MM:SS)
Time for aging out:29:23:59:35 (DD:HH:MM:SS)
ISID:400001370000
Initiator Initiator Target Target Connection
IP Address TCP Port IP Address TCP Port ID

10.10.10.210 54835 10.10.10.40 3260 1

```

**Supported Releases** 10.3.0E or later

## show iscsi storage-devices

Displays information about the storage arrays directly attached to OS10 ports.

**Syntax** `show iscsi storage-devices`

**Parameters** None

**Command Mode** EXEC

**Usage Information** The command output displays the storage device connected to each switch port and whether iSCSI automatically detects it.

### Example

```

OS10# show iscsi storage-devices
Interface Name Storage Device Name Auto Detected Status

ethernet1/1/23 EQL-MEM true

```

**Supported Releases** 10.3.0E or later

## Converged network DCB example

A converged data center network carries multiple SAN, server, and LAN traffic types that are sensitive to different aspects of data transmission. For example, storage traffic is sensitive to packet loss, while server traffic is latency-sensitive. In a single converged link, all traffic types coexist without imposing restrictions on other performances. DCB allows iSCSI and FCoE SAN traffic to coexist with server and LAN traffic on the same network. DCB features reduce or avoid dropped frames, retransmission, and network congestion.

DCB provides lossless transmission of FCoE and iSCSI storage traffic using:

- Separate traffic classes for the different service needs of network applications.
- PFC flow control to pause data transmission and avoid dropping packets during congestion.
- ETS bandwidth allocation to guarantee a percentage of shared bandwidth to bursty traffic, while allowing each traffic class to exceed its allocated bandwidth if another traffic class is not using its share.
- DCBX discovery of peers, including PFC, ETS, and other DCB settings parameter exchange, mismatch detection, and remote configuration of DCB parameters.
- iSCSI application protocol TLV information in DCBX advertisements to communicate iSCSI support to peer ports.

This example shows how to configure a DCB converged network in which:

- DCBx is enabled globally to ensure the exchange of DCBx, PFC, ETS, and iSCSI configurations between DCBx-enabled devices.
- PFC is configured to ensure lossless traffic for dot1p priority 4, 5, 6, and 7 traffic.
- ETS allocates 30% bandwidth for dot1p priority 0, 1, 2, and 3 traffic and 70% bandwidth for priority 4, 5, 6, and 7 traffic.
- iSCSI is configured to use dot1p priority 6 for iSCSI traffic, and advertise priority 6 in iSCSI application TLVs.

### 1. DCBX configuration (global)



Configure DCBX globally on a switch to enable the exchange of DCBX TLV messages with PFC, ETS, and iSCSI configurations.

```
OS10# configure terminal
OS10(config)# dcbx enable
```

## 2. PFC configuration (global)

PFC is enabled on traffic classes with dot1p 4, 5, 6, and 7 traffic. All the traffic classes use the default PFC pause settings for shared buffer size and pause frames in ingress queue processing in the network-qos policy map. The `trust-map dot1p default` honors (trusts) all dot1p ingress traffic.

```
OS10(config)# class-map type network-qos test4
OS10(config-cmap-nqos)# match qos-group 4
OS10(config-cmap-nqos)# exit
OS10(config)# class-map type network-qos test5
OS10(config-cmap-nqos)# match qos-group 5
OS10(config-cmap-nqos)# exit
OS10(config)# class-map type network-qos test6
OS10(config-cmap-nqos)# match qos-group 6
OS10(config-cmap-nqos)# exit
OS10(config)# class-map type network-qos test7
OS10(config-cmap-nqos)# match qos-group 7
OS10(config-cmap-nqos)# exit

OS10(config)# policy-map type network-qos test
OS10(config-pmap-network-qos)# class test4
OS10(config-pmap-c-nqos)# pause
OS10(config-pmap-c-nqos)# pfc-cos 4
OS10(config-pmap-c-nqos)# exit
OS10(config-pmap-network-qos)# class test5
OS10(config-pmap-c-nqos)# pause
OS10(config-pmap-c-nqos)# pfc-cos 5
OS10(config-pmap-c-nqos)# exit
OS10(config-pmap-network-qos)# class test6
OS10(config-pmap-c-nqos)# pause
OS10(config-pmap-c-nqos)# pfc-cos 6
OS10(config-pmap-c-nqos)# exit
OS10(config-pmap-network-qos)# class test7
OS10(config-pmap-c-nqos)# pause
OS10(config-pmap-c-nqos)# pfc-cos 7
OS10(config-pmap-c-nqos)# exit
OS10(config-pmap-network-qos)# exit

OS10(config)# system qos
OS10(config-sys-qos)# trust-map dscp default
```

## 3. PFC configuration (interface)

Apply the service policies with dot1p trust and PFC configurations to an interface.

```
OS10(config)# interface ethernet 1/1/53
OS10(conf-if-eth1/1/53)# no shutdown
OS10(conf-if-eth1/1/53)# service-policy input type network-qos test
OS10(conf-if-eth1/1/53)# trust-map dot1p default
OS10(conf-if-eth1/1/53)# priority-flow-control mode on
OS10(conf-if-eth1/1/53)# end
```

## 4. ETS configuration (global)

A trust dot1p-map assigns dot1p 0, 1, 2, and 3 traffic to qos-group 0, and dot1p 4, 5, 6, and 7 traffic to qos-group 1. A qos-map traffic-class map assigns the traffic class in qos-group 0 to queue 0, and qos-group 1 traffic to queue 1. A queuing policy map assigns 30% of interface bandwidth to queue 0, and 70% of bandwidth to queue 1.

```
OS10(config)# trust dot1p-map tmap1
OS10(config-tmap-dot1p-map)# qos-group 0 dot1p 0-3
OS10(config-tmap-dot1p-map)# qos-group 1 dot1p 4-7
OS10(config-tmap-dot1p-map)# exit

OS10(config)# qos-map traffic-class tmap2
OS10(config-qos-map)# queue 0 qos-group 0
OS10(config-qos-map)# queue 1 qos-group 1
```

```

OS10(config-qos-map)# exit

OS10(config)# class-map type queuing cmap1
OS10(config-cmap-queuing)# match queue 0
OS10(config-cmap-queuing)# exit
OS10(config)# class-map type queuing cmap2
OS10(config-cmap-queuing)# match queue 1
OS10(config-cmap-queuing)# exit

OS10(config)# policy-map type queuing pmap1
OS10(config-pmap-queuing)# class cmap1
OS10(config-pmap-c-que)# bandwidth percent 30
OS10(config-pmap-c-que)# exit
OS10(config-pmap-queuing)# class cmap2
OS10(config-pmap-c-que)# bandwidth percent 70
OS10(config-pmap-c-que)# end

OS10(config)# system qos
OS10(config-sys-qos)# trust-map dot1p default

```

## 5. ETS configuration (interface and global)

Apply the service policies with dot1p trust and ETS configurations to an interface or on all switch interfaces. Only one qos-map traffic-class map is supported on a switch.

```

OS10(config)# interface ethernet 1/1/53
OS10(conf-if-eth1/1/53)# trust-map dot1p tmap1
OS10(conf-if-eth1/1/53)# qos-map traffic-class tmap2
OS10(conf-if-eth1/1/53)# trust-map dot1p default
OS10(conf-if-eth1/1/53)# service-policy output type queuing pmap1
OS10(conf-if-eth1/1/53)# ets mode on
OS10(conf-if-eth1/1/53)# end

```

```

OS10(config)# system qos
OS10(config-sys-qos)# trust-map dot1p tmap1
OS10(config-sys-qos)# qos-map traffic-class tmap2
OS10(config-sys-qos)# trust-map dot1p default
OS10(config-sys-qos)# service-policy output type queuing pmap1
OS10(config-sys-qos)# ets mode on

```

## 6. Verify DCB configuration

```

OS10(conf-if-eth1/1/53)# show configuration
!
interface ethernet1/1/53
 switchport access vlan 1
 no shutdown
 service-policy input type network-qos test
 trust-map dot1p default
 service-policy output type queuing pmap1
 ets mode on
 qos-map traffic-class tmap2
 trust-map dot1p tmap1
 priority-flow-control mode on

```

## 7. Verify DCBX operational status

```

OS10(conf-if-eth1/1/53)# do show lldp dcbx interface ethernet 1/1/53
E-ETS Configuration TLV enabled e-ETS Configuration TLV disabled
R-ETS Recommendation TLV enabled r-ETS Recommendation TLV disabled
P-PFC Configuration TLV enabled p-PFC Configuration TLV disabled
F-Application priority for FCOE enabled f-Application Priority for FCOE disabled
I-Application priority for iSCSI enabled i-Application Priority for iSCSI disabled

Interface ethernet1/1/53
Port Role is Manual
DCBX Operational Status is Enabled
Is Configuration Source? FALSE
Local DCBX Compatibility mode is IEEEv2.5
Local DCBX Configured mode is AUTO

```

```

Peer Operating version is IEEEv2.5
Local DCBX TLVs Transmitted: ERPfI
4 Input PFC TLV pkts, 3 Output PFC TLV pkts, 0 Error PFC pkts
2 Input ETS Conf TLV Pkts, 27 Output ETS Conf TLV Pkts, 0 Error ETS Conf TLV Pkts
2 Input ETS Reco TLV pkts, 27 Output ETS Reco TLV pkts, 0 Error ETS Reco TLV Pkts

Total DCBX Frames transmitted 0
Total DCBX Frames received 0
Total DCBX Frame errors 0
Total DCBX Frames unrecognized 0

```

## 8. Verify PFC configuration and operation

```

OS10(conf-if-eth1/1/53)# do show lldp dcbx interface ethernet 1/1/53 pfc detail

Interface ethernet1/1/53
Admin mode is on
Admin is enabled, Priority list is 4,5,6,7
Remote is enabled, Priority list is 4,5,6,7
Remote Willing Status is disabled
Local is enabled, Priority list is 4,5,6,7
Oper status is init
PFC DCBX Oper status is Up
State Machine Type is Symmetric
PFC TLV Tx Status is enabled
Application Priority TLV Parameters :

ISCSI TLV Tx Status is enabled
Local ISCSI PriorityMap is 0x10
Remote ISCSI PriorityMap is 0x10

4 Input TLV pkts, 3 Output TLV pkts, 0 Error pkts
4 Input Appln Priority TLV pkts, 3 Output Appln Priority TLV pkts,
0 Error Appln Priority TLV Pkts

```

## 9. Verify ETS configuration and operation

```

OS10(conf-if-eth1/1/53)# do show lldp dcbx interface ethernet 1/1/53 ets detail

Interface ethernet1/1/53
Max Supported PG is 8
Number of Traffic Classes is 8
Admin mode is on

Admin Parameters :

Admin is enabled

PG-grp Priority# Bandwidth TSA

0 0,1,2,3, 30% ETS
1 4,5,6,7 70% ETS
2 0% 0% ETS
3 0% 0% ETS
4 0% 0% ETS
5 0% 0% ETS
6 0% 0% ETS
7 0% 0% ETS

Remote Parameters :

Remote is enabled
PG-grp Priority# Bandwidth TSA

0 0,1,2,3, 30% ETS
1 4,5,6,7 70% ETS
2 0% 0% SP
3 0% 0% SP
4 0% 0% SP
5 0% 0% SP
6 0% 0% SP
7 0% 0% SP

```

```
Remote Willing Status is disabled
Local Parameters :
```

```

Local is enabled
```

| PG-grp | Priority# | Bandwidth | TSA |
|--------|-----------|-----------|-----|
| 0      | 0,1,2,3,  | 30%       | ETS |
| 1      | 4,5,6,7   | 70%       | ETS |
| 2      |           | 0%        | ETS |
| 3      |           | 0%        | ETS |
| 4      |           | 0%        | ETS |
| 5      |           | 0%        | ETS |
| 6      |           | 0%        | ETS |
| 7      |           | 0%        | ETS |

```
Oper status is init
ETS DCBX Oper status is Up
State Machine Type is Asymmetric
Conf TLV Tx Status is enabled
Reco TLV Tx Status is enabled
```

```
2 Input Conf TLV Pkts, 27 Output Conf TLV Pkts, 0 Error Conf TLV Pkts
2 Input Reco TLV Pkts, 27 Output Reco TLV Pkts, 0 Error Reco TLV Pkts
```

## 10. iSCSI optimization configuration (global)

This example accepts the default settings for aging time and TCP ports that are used in monitored iSCSI sessions. A Compellent storage array is connected to the port. The policy-iscsi policy map sets the CoS dot1p priority that is used for iSCSI traffic to 6 globally on the switch. By default, iSCSI traffic uses priority 4. The `iscsi priority-bits 0x40` command sets the advertised dot1p priority that is used by iSCSI traffic in application TLVs to 6. Hexadecimal 0x40 is binary 0 1 0 0 0 0 0 0.

```
OS10(config-if-eth1/1/53)# iscsi profile-storage compellent
OS10(config-if-eth1/1/53)# lldp tlv-select dcbxp-appln iscsi
OS10(config-if-eth1/1/53)# exit

OS10(config)# iscsi target port 3261 ip-address 10.1.1.1
OS10(config)# policy-map type application policy-iscsi
OS10(config-pmap-application)# class class-iscsi
OS10(config-pmap-c-app)# set qos-group 6
OS10(config-pmap-c-app)# set cos 6
OS10(config-pmap-c-app)# exit
OS10(config-pmap-application)# exit

OS10(config)# system qos
OS10(config-sys-qos)# service-policy type application policy-iscsi
OS10(config-sys-qos)# exit

OS10(config)# iscsi session-monitoring enable
OS10(config)# iscsi priority-bits 0x40
OS10(config)# iscsi enable
```

## 11. Verify iSCSI optimization (global)

After you enable iSCSI optimization, the iSCSI application priority TLV parameters are added in the `show` command output to verify a PFC configuration.

```
OS10(config-if-eth1/1/53)# do show lldp dcbx interface ethernet 1/1/53 pfc detail

Interface ethernet1/1/53
 Admin mode is on
 Admin is enabled, Priority list is 4,5,6,7
 Remote is enabled, Priority list is 4,5,6,7
 Remote Willing Status is disabled
 Local is enabled, Priority list is 4,5,6,7
 Oper status is init
 PFC DCBX Oper status is Up
 State Machine Type is Symmetric
 PFC TLV Tx Status is enabled
 Application Priority TLV Parameters :
```

```

ISCSI TLV Tx Status is enabled
Local ISCSI PriorityMap is 0x40
Remote ISCSI PriorityMap is 0x10

4 Input TLV pkts, 3 Output TLV pkts, 0 Error pkts
4 Input Appln Priority TLV pkts, 3 Output Appln Priority TLV pkts, 0 Error Appln
Priority TLV Pkts

```

## 12. DCBX configuration (interface)

This example shows how to configure and verify different DCBX versions.

```

OS10(conf-if-eth1/1/53)# dcbx version cee
OS10(conf-if-eth1/1/53)# show configuration
!
interface ethernet1/1/53
 switchport access vlan 1
 no shutdown
 dcbx version cee
 service-policy input type network-qos test
 trust-map dotlp default
 service-policy output type queuing pmapl
 ets mode on
 qos-map traffic-class tmap2
 trust-map dotlp tmap1
 priority-flow-control mode on

OS10(conf-if-eth1/1/53)# do show lldp dcbx interface ethernet 1/1/53
E-ETS Configuration TLV enabled e-ETS Configuration TLV disabled
R-ETS Recommendation TLV enabled r-ETS Recommendation TLV disabled
P-PFC Configuration TLV enabled p-PFC Configuration TLV disabled
F-Application priority for FCOE enabled f-Application Priority for FCOE disabled
I-Application priority for iSCSI enabled i-Application Priority for iSCSI disabled

Interface ethernet1/1/53
 Port Role is Manual
 DCBX Operational Status is Enabled
 Is Configuration Source? FALSE
 Local DCBX Compatibility mode is CEE
 Local DCBX Configured mode is CEE
 Peer Operating version is CEE
 Local DCBX TLVs Transmitted: ErPfi

Local DCBX Status

DCBX Operational Version is 0
DCBX Max Version Supported is 0
Sequence Number: 2
Acknowledgment Number: 1
Protocol State: In-Sync

Peer DCBX Status

DCBX Operational Version is 0
DCBX Max Version Supported is 0
Sequence Number: 1
Acknowledgment Number: 2
 3 Input PFC TLV pkts, 3 Output PFC TLV pkts, 0 Error PFC pkts
 3 Input PG TLV Pkts, 3 Output PG TLV Pkts, 0 Error PG TLV Pkts
 3 Input Appln Priority TLV pkts, 3 Output Appln Priority TLV pkts,
 0 Error Appln Priority TLV Pkts

Total DCBX Frames transmitted 3
Total DCBX Frames received 3
Total DCBX Frame errors 0
Total DCBX Frames unrecognized

```

```
OS10(conf-if-eth1/1/53)# dcbx version cee
OS10(conf-if-eth1/1/53)# show configuration
!
interface ethernet1/1/53
 switchport access vlan 1
 no shutdown
 dcbx version ieee
 service-policy input type network-qos test
 trust-map dot1p default
 service-policy output type queuing pmap1
 ets mode on
 qos-map traffic-class tmap2
 trust-map dot1p tmap1
 priority-flow-control mode on

OS10(conf-if-eth1/1/53)# do show lldp dcbx interface ethernet 1/1/53
E-ETS Configuration TLV enabled e-ETS Configuration TLV disabled
R-ETS Recommendation TLV enabled r-ETS Recommendation TLV disabled
P-PFC Configuration TLV enabled p-PFC Configuration TLV disabled
F-Application priority for FCOE enabled f-Application Priority for FCOE disabled
I-Application priority for iSCSI enabled i-Application Priority for iSCSI disabled

Interface ethernet1/1/53
 Port Role is Manual
 DCBX Operational Status is Enabled
 Is Configuration Source? FALSE
 Local DCBX Compatibility mode is IEEEv2.5
 Local DCBX Configured mode is IEEEv2.5
 Peer Operating version is IEEEv2.5
 Local DCBX TLVs Transmitted: ERPfI
 13 Input PFC TLV pkts, 4 Output PFC TLV pkts, 0 Error PFC pkts
 3 Input ETS Conf TLV Pkts, 26 Output ETS Conf TLV Pkts, 0 Error ETS Conf TLV Pkts
 3 Input ETS Reco TLV pkts, 26 Output ETS Reco TLV pkts, 0 Error ETS Reco TLV Pkts

Total DCBX Frames transmitted 0
Total DCBX Frames received 0
Total DCBX Frame errors 0
Total DCBX Frames unrecognized 0
```

## sFlow

sFlow is a standard-based sampling technology embedded within switches and routers that monitors network traffic. It provides traffic monitoring for high-speed networks with many switches and routers.

- OS10 supports sFlow version 5
- Only data ports support sFlow collector
- OS10 supports a maximum of two sFlow collectors
- OS10 does not support sFlow on SNMP, VLAN, tunnel interfaces, extended sFlow, backoff mechanism, and egress sampling

sFlow uses two types of sampling:

- Statistical packet-based sampling of switched or routed packet flows
- Time-based sampling of interface counters

**NOTE:** On the S4248FB-ON and the S4248FBL-ON platforms, sampling is performed based on the cumulative packet counts from all the sFlow enabled ports.

sFlow monitoring consists of an sFlow agent embedded in the device and an sFlow collector:

- The sFlow agent resides anywhere within the path of the packet. The agent combines the flow samples and interface counters into sFlow datagrams and forwards them to the sFlow collector at regular intervals. The datagrams consist of information on, but not limited to, the packet header, ingress and egress interfaces, sampling parameters, and interface counters. Application-specific integrated circuits (ASICs) handle packet sampling.
- The sFlow collector analyses the datagrams received from different devices and produces a network-wide view of traffic flows.

### Configuration notes

Dell EMC PowerSwitch S4200-ON Series:

Do not enable sFlow on per-port basis.

## Enable sFlow

You can enable sFlow either on all interfaces globally or on a specific set of interfaces. The system displays an error message if you try to enable sFlow on both modes at one time.

If you configure sFlow only on a set of interfaces, any further change to the sFlow-enabled ports triggers the sFlow agent to restart. This results in a gap in the polling counter statistics of 30 seconds and the sFlow counters are reset on all sFlow-enabled ports.

When you enable sFlow on a port-channel:

- When in Per-Interface mode, the counter statistics of sFlow-enabled ports reset to zero when you add a new member port or remove an existing member port from any sflow enabled port-channel group.
- sFlow counter statistics that are individually reported for the port members of a port-channel data source are accurate. Counter statistics reported for the port-channel may not be accurate. To calculate the correct counters for a port-channel data source, add together the counter statistics of the individual port members.

### Enable or disable sFlow globally

sFlow is disabled globally by default.

- Enable sFlow globally on all interfaces in CONFIGURATION mode.

```
sflow enable all-interfaces
```

- Disable sFlow in CONFIGURATION mode.

```
no sflow
```

### Enable or disable sFlow on a specific interface

- Enable sFlow in CONFIGURATION mode.

```
sflow enable
```

- Disable sFlow in CONFIGURATION mode.

```
no sflow enable
```

### Enable sFlow on a specific interface

```
OS10(config)# sflow enable
OS10(config)# interface ethernet 1/1/1
OS10(conf-if-eth1/1/1)# sflow enable
```

### Enable sFlow on a range of interfaces

```
OS10(config)# sflow enable
OS10(config)# interface range ethernet 1/1/1-1/1/10
OS10(conf-range-eth1/1/1-1/1/10)# sflow enable
```

### Enable sFlow on a port-channel

```
OS10(config)# sflow enable
OS10(config)# interface range port-channel 1-10
OS10(conf-range-po-1-10)# sflow enable
```

## Max-header size configuration

- Set the packet maximum size in CONFIGURATION mode, from 64 to 256. The default is 128 bytes.

```
max-header-size header-size
```

- Disable the header size in CONFIGURATION mode.

```
no sflow max-header-size
```

- View the maximum packet header size in EXEC mode.

```
show sflow
```

### Configure sFlow maximum header size

```
OS10(config)# sflow max-header-size 80
```

### View sFlow information

```
OS10# show sflow
sFlow services are enabled
Management Interface sFlow services are disabled
Global default sampling rate: 32768
Global default counter polling interval: 20
Global default extended maximum header size: 128 bytes
Global extended information enabled: none
1 collector(s) configured
Collector IP addr:10.16.151.245 Agent IP addr:10.16.132.181 UDP port:6343 VRF:Default
31722 UDP packets exported
0 UDP packets dropped
34026 sFlow samples collected
```

### View sFlow running configuration

```
OS10# show running-configuration sflow
sflow enable
sflow max-header-size 80
sflow polling-interval 30
sflow sample-rate 4096
```



```
sflow collector 10.16.150.1 agent-addr 10.16.132.67 6767 max-datagram-size 800
sflow collector 10.16.153.176 agent-addr 3.3.3.3 6666
!
interface ethernet1/1/1
sflow enable
!
```

## Collector configuration

Configure the IPv4 or IPv6 address for the sFlow collector. When you configure the collector, enter a valid and reachable IPv4 or IPv6 address. You can configure a maximum of two sFlow collectors. If you specify two collectors, samples are sent to both. The agent IP address must be the same for both the collectors.

### Collector configuration for default VRF

- Enter an IPv4 or IPv6 address for the sFlow collector, IPv4 or IPv6 address for the agent, UDP collector port number, and maximum datagram size in CONFIGURATION mode.

```
sflow collector {ip-address | ipv6-address} agent-addr {ip-address | ipv6-address}
[collector-port-number] [max-datagram-size datagram-size-number]
```

The no form of the command disables sFlow collectors in CONFIGURATION mode.

### Collector configuration for nondefault VRF

If you configure a collector for a nondefault VRF, create the VRF first. If you do not specify the VRF instance, the system configures the collector for the default VRF instance.

The following are the steps to configure sFlow collector with a nondefault VRF:

1. Create a nondefault VRF instance.

```
OS10(config)# ip vrf RED
```

2. Enable the sFlow feature.

```
OS10(config)# sflow enable
```

3. Assign an IP address to an interface which you can use as the sFlow agent and add it to the VRF instance.

```
OS10(config-if-eth1/1/1)# sflow enable
OS10(config-if-eth1/1/1)# ip vrf forwarding RED
OS10(config-if-eth1/1/1)# ip address 1.1.1.1/24
OS10(config-if-eth1/1/1)# no shutdown
```

4. Assign an IP address to an interface through which the sFlow collector is reachable and add it to the VRF instance.

```
OS10(config-if-eth1/1/1)# interface ethernet 1/1/2
OS10(config-if-eth1/1/2)# sflow enable
OS10(config-if-eth1/1/2)# ip vrf forwarding RED
OS10(config-if-eth1/1/2)# ip address 4.4.4.4/24
OS10(config-if-eth1/1/2)# no shutdown
```

5. Enter the IP addresses of the sFlow collector and the agent and assign them to the VRF instance.

```
OS10(config)# sflow collector 4.4.4.1 agent-addr 1.1.1.1 vrf RED
```

### View sFlow information

```
OS10# show sflow
sFlow services are enabled
Management Interface sFlow services are disabled
Global default sampling rate: 32768
Global default counter polling interval: 10
```

```
Global default extended maximum header size: 128 bytes
Global extended information enabled: none
1 collector(s) configured
Collector IP addr:4.4.4.1 Agent IP addr:1.1.1.1 UDP port:6343 VRF:RED
0 UDP packets exported
0 UDP packets dropped
0 sFlow samples collected
```

## Polling-interval configuration

The polling interval for an interface is the number of seconds between successive samples of counters sent to the collector. You can configure the duration for polled interface statistics. Unless there is a specific deployment need to configure a lower polling interval value, configure the polling interval to the maximum value.

- Change the default counter polling interval in CONFIGURATION mode, from 10 to 300. The default is 20.

```
sflow polling-interval interval-size
```

- Disable the polling interval in CONFIGURATION mode.

```
no sflow polling-interval
```

- View the polling interval in EXEC mode.

```
show sflow
```

### Configure sFlow polling interval

```
OS10(config)# sflow polling-interval 200
```

### View sFlow information

```
OS10# show sflow
sFlow services are enabled
Management Interface sFlow services are disabled
Global default sampling rate: 32768
Global default counter polling interval: 200
Global default extended maximum header size: 128 bytes
Global extended information enabled: none
1 collector(s) configured
Collector IP addr:10.16.151.245 Agent IP addr:10.16.132.181 UDP port:6343 VRF:Default
31722 UDP packets exported
0 UDP packets dropped
34026 sFlow samples collected
```

### View sFlow running configuration

```
OS10# show running-configuration sflow
sflow enable
sflow max-header-size 80
sflow polling-interval 200
sflow sample-rate 4096
sflow collector 10.16.150.1 agent-addr 10.16.132.67 6767 max-datagram-size 800
sflow collector 10.16.153.176 agent-addr 3.3.3.3 6666
!
interface ethernet1/1/1
sflow enable
!
```

## Sample-rate configuration

Sampling rate is the number of packets skipped before the sample is taken. If the sampling rate is 4096, one sample generates for every 4096 packets observed.

- Set the sampling rate in CONFIGURATION mode, from 4096 to 65535. The default is 32768.

```
sflow sample-rate sampling-size
```

- Disable packet sampling in CONFIGURATION mode.

```
no sflow sample-rate
```

- View the sampling rate in EXEC mode.

```
show sflow
```

### Configure sFlow sampling rate

```
OS10(config)# sflow sample-rate 4096
```

### View sFlow packet header size

```
OS10# show sflow
sFlow services are enabled
Management Interface sFlow services are disabled
Global default sampling rate: 4096
Global default counter polling interval: 20
Global default extended maximum header size: 128 bytes
Global extended information enabled: none
1 collector(s) configured
Collector IP addr:10.16.151.245 Agent IP addr:10.16.132.181 UDP port:6343 VRF:Default
31722 UDP packets exported
0 UDP packets dropped
34026 sFlow samples collected
```

### View sFlow running configuration

```
OS10# show running-configuration sflow
sflow enable
sflow max-header-size 80
sflow polling-interval 20
sflow sample-rate 4096
sflow collector 10.16.150.1 agent-addr 10.16.132.67 6767 max-datagram-size 800
sflow collector 10.16.153.176 agent-addr 3.3.3.3 6666
!
interface ethernet1/1/1
sflow enable
!
```

## Source interface configuration

You can configure an interface as a source for sFlow. The sFlow agent uses the IP address of the configured source interface as the agent IP address.

- Configure the source interface in CONFIGURATION mode.

```
sflow source-interface {ethernet node/slot/port[:subport] | loopback loopback-ID|
port-channel port-channel-ID| vlan vlan-ID}
```

- View the interface details.

```
show running-configuration sflow
```

```
show sflow
```

### Configure sFlow source interface

```
OS10(config)# sflow source-interface ethernet 1/1/1
```

```
OS10(config)# sflow source-interface port-channel 1
```

```
OS10(config)# sflow source-interface loopback 1
OS10(config)# sflow source-interface vlan 10
```

### View sFlow running configuration

```
OS10# show running-configuration sflow
sflow enable all-interfaces
sflow source-interface vlan10
sflow collector 5.1.1.1 agent-addr 4.1.1.1 6343
sflow collector 6.1.1.1 agent-addr 4.1.1.1 6343

OS10(config)#show running-configuration interface vlan
!
interface vlan1
no shutdown
!
interface vlan10
no shutdown
ip address 10.1.1.1/24
```

### View sFlow details

```
OS10# show sflow
sFlow services are enabled
Management Interface sFlow services are disabled
Global default sampling rate: 32768
Global default counter polling interval: 30
Global default extended maximum header size: 128 bytes
Global extended information enabled: none
2 collector(s) configured
Collector IP addr:5.1.1.1 Agent IP addr:10.1.1.1 UDP port:6343 VRF:Default → It shows
active agent-ip
Collector IP addr:6.1.1.1 Agent IP addr:10.1.1.1 UDP port:6343 VRF:Default → It shows
active agent-ip
2 UDP packets exported
0 UDP packets dropped
2 sFlow samples collected
```

## View sFlow information

OS10 does not support statistics for UDP packets dropped and samples received from the hardware.

- View sFlow configuration details and statistics in EXEC mode.

```
OS10# show sflow
sFlow services are enabled
Management Interface sFlow services are disabled
Global default sampling rate: 32768
Global default counter polling interval: 30
Global default extended maximum header size: 128 bytes
Global extended information enabled: none
1 collector(s) configured
Collector IP addr:10.16.151.245 Agent IP addr:10.16.132.181 UDP port:6343 VRF:Default
31722 UDP packets exported
0 UDP packets dropped
34026 sFlow samples collected
```

- View sFlow configuration details on a specific interface in EXEC mode.

```
OS10# show sflow interface port-channel 1
port-channell1
sFlow is enabled on port-channell1
Samples rcvd from h/w: 0
```

- View the sFlow running configuration in EXEC mode.

```
OS10# show running-configuration sflow
sflow enable
sflow max-header-size 80
sflow polling-interval 30
sflow sample-rate 4096
sflow collector 10.16.150.1 agent-addr 10.16.132.67 6767 max-datagram-size 800
sflow collector 10.16.153.176 agent-addr 3.3.3.3 6666
!
interface ethernet1/1/1
sflow enable
!
```

## sFlow commands

### sflow collector

Configures an sFlow collector IP address where sFlow datagrams are forwarded. You can configure a maximum of two collectors.

**Syntax** `sflow collector {ipv4-address | ipv6-address} agent-addr {ipv4-address | ipv6-address} [collector-port-number] [max-datagram-size datagram-size-number] [vrf vrf-name]`

- Parameters**
- `ipv4-address | ipv6-address` — Enter an IPv4 or IPv6 address in A.B.C.D/A::B format.
  - `agent-addr ipv4-address | ipv6-address` — Enter the sFlow agent IP address. If you configure two collectors, the agent IP address must be the same for both the collectors.
  - `collector-port-number` — (Optional) Enter the UDP port number, from 1 to 65535. The default is 6343.
  - `max-datagram-size datagram-size-number` — (Optional) Enter `max-datagram-size` then the size number in bytes, from 400 to 1500. The default is 1400.
  - `vrf` — (Optional) Enter the VRF instance to set the VRF context to the collector IP address. If you do not specify a VRF, the system uses the default VRF.

**Defaults** Not configured

**Command Modes** CONFIGURATION

**Usage Information** You must enter a valid and reachable IPv4 or IPv6 address. If you configure two collectors, traffic samples are sent to both. The sFlow agent address is the IPv4 or IPv6 address used to identify the agent to the collector. The `no` version of this command removes the configured sFlow collector.

If you specify a nondefault VRF, create the VRF first.

**Example**

```
OS10(conf)# sflow collector 10.1.1.1 agent-addr 2.2.2.2 6343 max-datagram-size 1500 vrf default
```

```
OS10(conf)# sflow collector 10.1.1.1 agent-addr 2.2.2.2 6343 max-datagram-size 1500 vrf vrf-core
```

**Supported Releases** 10.3.0E or later. Updated the command to specify a nondefault VRF on OS10 release 10.4.3.0 or later

### sflow enable

Enables sFlow on a specific interface or globally on all interfaces.

**Syntax** `sflow enable [all-interfaces]`

**Parameters** `all-interfaces` — (Optional) Enter to enable sFlow globally.

**Default** Disabled

**Command Mode** CONFIGURATION

**Usage Information** The `no` version of this command to disables sFlow.

**Example (interface)**

```
OS10(config)# sflow enable
OS10(config)# interface ethernet 1/1/1
OS10(conf-if-eth1/1/1)# sflow enable
```

**Example (interface range)**

```
OS10(config)# sflow enable
OS10(config)# interface range ethernet 1/1/1-1/1/10
OS10(conf-range-eth1/1/1-1/1/10)# sflow enable
```

**Example (port-channel)**

```
OS10(config)# sflow enable
OS10(config)# interface range port-channel 1-10
OS10(conf-range-po-1-10)# sflow enable
```

**Supported Releases** 10.3.0E or later

## sflow max-header-size

Sets the maximum header size of a packet.

**Syntax** `sflow max-header-size header-size`

**Parameter** *header-size* — Enter the header size in bytes, from 64 to 256. The default is 128.

**Default** 128 bytes

**Command Mode** CONFIGURATION

**Usage Information** Use the `no` version of the command to reset the header size to the default value.

**Example**

```
OS10(conf)# sflow max-header-size 256
```

**Supported Releases** 10.3.0E or later

## sflow polling-interval

Sets the sFlow polling interval.

**Syntax** `sflow polling-interval interval-value`

**Parameter** *interval-value* — Enter the interval value in sections, from 10 to 300. The default is 30.

**Defaults** 30

**Command Mode** CONFIGURATION

**Usage Information** The polling interval for an interface is the number of seconds between successive samples of counters sent to the collector. You can configure the duration for polled interface statistics. The `no` version of the command resets the interval time to the default value.

**Example**

```
OS10(conf)# sflow polling-interval 200
```

**Supported Releases** 10.3.0E or later

## sflow sample-rate

Configures the sampling rate.

|                           |                                                                                                                                                                                                                                                                       |
|---------------------------|-----------------------------------------------------------------------------------------------------------------------------------------------------------------------------------------------------------------------------------------------------------------------|
| <b>Syntax</b>             | <code>sflow sample-rate value</code>                                                                                                                                                                                                                                  |
| <b>Parameter</b>          | <i>value</i> — Enter the packet sample rate, from 4096 to 65535. The default is 32768.                                                                                                                                                                                |
| <b>Default</b>            | 32768                                                                                                                                                                                                                                                                 |
| <b>Command Mode</b>       | CONFIGURATION                                                                                                                                                                                                                                                         |
| <b>Usage Information</b>  | Sampling rate is the number of packets skipped before the sample is taken. For example, if the sampling rate is 4096, one sample generates for every 4096 packets observed. The <code>no</code> version of the command resets the sampling rate to the default value. |
| <b>Example</b>            | <pre>OS10(config)# sflow sample-rate 4096</pre>                                                                                                                                                                                                                       |
| <b>Supported Releases</b> | 10.3.0E or later                                                                                                                                                                                                                                                      |

## sflow source-interface

Configures an interface as source for sFlow. The sFlow agent uses the IP address of the configured source interface as the agent IP address.

|                               |                                                                                                                                                                                                                                                                                                                                                                                                                                                                                                          |
|-------------------------------|----------------------------------------------------------------------------------------------------------------------------------------------------------------------------------------------------------------------------------------------------------------------------------------------------------------------------------------------------------------------------------------------------------------------------------------------------------------------------------------------------------|
| <b>Syntax</b>                 | <code>sflow source-interface {ethernet node/slot/port[:subport]   loopback loopback-ID   port-channel port-channel-ID   vlan vlan-ID}</code>                                                                                                                                                                                                                                                                                                                                                             |
| <b>Parameters</b>             | <ul style="list-style-type: none"><li>• <code>ethernet node/slot/port[:subport]</code>—Enter the physical interface type details.</li><li>• <code>loopback loopback-ID</code>—Enter the Loopback interface details. The Loopback ID range is from 0 to 16383.</li><li>• <code>port-channel port-channel-ID</code>—Enter the port channel details. The port channel ID range is from 1 to 128.</li><li>• <code>vlan vlan-ID</code>—Enter the VLAN details. The VLAN ID range is from 1 to 4093.</li></ul> |
| <b>Default</b>                | Disabled                                                                                                                                                                                                                                                                                                                                                                                                                                                                                                 |
| <b>Command Mode</b>           | CONFIGURATION                                                                                                                                                                                                                                                                                                                                                                                                                                                                                            |
| <b>Usage Information</b>      | The <code>no</code> version of this command removes the configuration from the interface.                                                                                                                                                                                                                                                                                                                                                                                                                |
| <b>Example (Ethernet)</b>     | <pre>OS10(config)# sflow source-interface ethernet 1/1/1</pre>                                                                                                                                                                                                                                                                                                                                                                                                                                           |
| <b>Example (Loopback)</b>     | <pre>OS10(config)# sflow source-interface loopback 1</pre>                                                                                                                                                                                                                                                                                                                                                                                                                                               |
| <b>Example (port-channel)</b> | <pre>OS10(config)# sflow source-interface port-channel 1</pre>                                                                                                                                                                                                                                                                                                                                                                                                                                           |
| <b>Example (VLAN)</b>         | <pre>OS10(config)# sflow source-interface vlan 10</pre>                                                                                                                                                                                                                                                                                                                                                                                                                                                  |
| <b>Supported Releases</b>     | 10.4.1.0 or later                                                                                                                                                                                                                                                                                                                                                                                                                                                                                        |

## show sflow

Displays the current sFlow configuration for all interfaces or by a specific interface type.

|               |                                          |
|---------------|------------------------------------------|
| <b>Syntax</b> | <code>show sflow [interface type]</code> |
|---------------|------------------------------------------|

**Parameter** interface type — (Optional) Enter either ethernet or port-channel for the interface type.

**Command Mode** EXEC

**Usage Information** OS10 does not support statistics for UDP packets dropped and samples received from the hardware.

**Example**

```
OS10# show sflow
sFlow services are enabled
Management Interface sFlow services are disabled
Global default sampling rate: 32768
Global default counter polling interval: 30
Global default extended maximum header size: 128 bytes
Global extended information enabled: none
1 collector(s) configured
Collector IP addr:10.16.151.245 Agent IP addr:10.16.132.181 UDP
port:6343 VRF:Default
31722 UDP packets exported
0 UDP packets dropped
34026 sFlow samples collected
```

```
OS10# show sflow
sFlow services are enabled
Management Interface sFlow services are disabled
Global default sampling rate: 32768
Global default counter polling interval: 30
Global default extended maximum header size: 128 bytes
Global extended information enabled: none
1 collector(s) configured
Collector IP addr:10.16.151.145 Agent IP addr:10.16.132.160 UDP
port:6343 VRF:RED
0 UDP packets exported
0 UDP packets dropped
0 sFlow samples collected
```

**Example (port-channel)**

```
OS10# show sflow interface port-channel 1
port-channell
sFlow is enabled on port-channell
Samples rcvd from h/w: 0
```

**Supported Releases** 10.3.0E or later



# Telemetry

Network health relies on performance monitoring and data collection for analysis and troubleshooting. Network data is often collected with SNMP and CLI commands using the pull mode. In pull mode, a management device sends a get request and pulls data from a client. As the number of objects in the network and the metrics grow, traditional methods limit network scaling and efficiency. Using multiple management systems further limits network scaling. The pull model increases the processing load on a switch by collecting all data even when there is no change.

Streaming telemetry provides an alternative method where data is continuously transmitted from network devices with efficient, incremental updates. Operators subscribe to the specific data they need using well-defined sensor identifiers.

While SNMP management systems poll for data even if there is no change, streaming telemetry enables access to near real-time, model-driven, and analytics-ready data. It supports more effective network automation, traffic optimization, and preventative troubleshooting.

For example, streaming telemetry reports packet drops or high utilization on links in real time. A network automation application can use this information to provision new paths and optimize traffic transmission across the network. The data is encoded using Google Protocol Buffers (GPB) and streamed using Google Protocol RPC (gRPC) transport.

You can use OS10 telemetry to stream data to:

- Dell-implemented external collectors, such as VMware vRNI or Wavefront
- Proprietary network collectors that you implement

## Telemetry terminology

|                             |                                                                                                                                                                                                                                                                                                                                                                                                                                                                                                                        |
|-----------------------------|------------------------------------------------------------------------------------------------------------------------------------------------------------------------------------------------------------------------------------------------------------------------------------------------------------------------------------------------------------------------------------------------------------------------------------------------------------------------------------------------------------------------|
| <b>Dial-out mode</b>        | The switch initiates a session with one or more devices according to the sensor paths and destinations in a subscription.                                                                                                                                                                                                                                                                                                                                                                                              |
| <b>Sensor path</b>          | The path used to collect data for streaming telemetry.                                                                                                                                                                                                                                                                                                                                                                                                                                                                 |
| <b>Sensor group</b>         | A reusable group of multiple sensor paths and exclude filters.                                                                                                                                                                                                                                                                                                                                                                                                                                                         |
| <b>Destination group</b>    | The IP address and transport port on a destination server to which telemetry data is streamed. You can configure multiple destinations and reuse the destination group in subscription profiles.                                                                                                                                                                                                                                                                                                                       |
| <b>Subscription profile</b> | <p>Data collector destinations and stream attributes that are associated with sensor paths. A subscription ties sensor paths and a destination group with a transport protocol, encoding format, and streaming interval.</p> <p>The telemetry agent in the switch attempts to establish a session with each collector in the subscription profile, and streams data to the collector. If a collector is not reachable, the telemetry agent continuously tries to establish the connection at one-minute intervals.</p> |

## YANG-modeled telemetry data

This section describes the YANG containers from which telemetry data can be streamed to destinations with the recommended minimum sampling intervals.

### BGP

**Table 94. BGP**

| YANG Container                | Minimum sampling interval (milliseconds) |
|-------------------------------|------------------------------------------|
| bgp/bgp-oper/bgpPeerCount     | 15000                                    |
| bgp/bgp-oper/bgpPrfxCtrsEntry | 15000                                    |

## BGP peers

**Table 95. BGP peers**

| YANG Container                   | Minimum sampling interval (milliseconds) |
|----------------------------------|------------------------------------------|
| infra-bgp/peer-state/peer-status | 0                                        |

## Buffer statistics

**Table 96. Buffer statistics**

| YANG Container               | Minimum sampling interval (milliseconds) |
|------------------------------|------------------------------------------|
| base-qos/queue-stat          | 15000                                    |
| base-qos/priority-group-stat | 15000                                    |
| base-qos/buffer-pool-stat    | 15000                                    |
| base-qos/buffer-pool         | 15000                                    |

## Device information

**Table 97. Device information**

| YANG Container                              | Minimum sampling interval (milliseconds) |
|---------------------------------------------|------------------------------------------|
| base-pas/chassis                            | 15000                                    |
| base-pas/card                               | 15000                                    |
| base-switch/switching-entities/switch-stats | 15000                                    |

## Environmental statistics

**Table 98. Environmental statistics**

| YANG Container          | Minimum sampling interval (milliseconds) |
|-------------------------|------------------------------------------|
| base-pas/entity         | 15000                                    |
| base-pas/psu            | 15000                                    |
| base-pas/fan-try        | 15000                                    |
| base-pas/fan            | 15000                                    |
| base-pas/led            | 15000                                    |
| base-pas/temperature    | 15000                                    |
| base-pas/temp_threshold | 15000                                    |
| base-pas/media          | 15000                                    |
| base-pas/media-channel  | 15000                                    |

## Interface statistics

**Table 99. Interface statistics**

| YANG Container                                 | Minimum sampling interval (milliseconds) |
|------------------------------------------------|------------------------------------------|
| if/interfaces-state/interface/statistics       | 15000                                    |
| dell-base-if-cmn/if/interfaces-state/interface | 15000                                    |

## Port-channel (lag) member ports

**Table 100. Port-channel (lag) member ports**

| YANG Container                 | Minimum sampling interval (milliseconds) |
|--------------------------------|------------------------------------------|
| dell-base-if-cmn/if/interfaces | 0                                        |

**System statistics****Table 101. System statistics**

| YANG Container               | Minimum sampling interval (milliseconds) |
|------------------------------|------------------------------------------|
| system-status/current-status | 15000                                    |

## Configure telemetry

 **NOTE:** To set up a streaming telemetry collector, download and use the OS10 telemetry .proto files from the Dell EMC Support site.

To enable the streaming of telemetry data to destinations in a subscription profile:

1. Enable telemetry on the switch.
2. Configure a destination group.
3. Configure a subscription profile by associating one or more destination groups and pre-configured sensor groups.

After you complete Step 3, the telemetry agent starts streaming data to destination devices.

**Configuration notes**

- The telemetry agent collects data from OS10 applications and switch hardware. When you configure a sampling rate of 0, which is near real-time, telemetry collects data as soon as an event occurs. If you configure a sampling rate, telemetry performs periodic data collection. The recommended minimum sampling intervals are described in **Configure a sensor group**.
- OS10 telemetry supports:
  - Only one configured destination group, and only one destination address in the group.
  - Only one subscription profile.

**Enable telemetry**

1. Enter telemetry mode from CONFIGURATION mode.

```
OS10(config)# telemetry
```

2. Enable streaming telemetry in TELEMETRY mode.

```
OS10(conf-telemetry)# enable
```

**Configure a sensor group**

A sensor group defines the data that is collected and streamed to a destination. Use any of the pre-configured sensor groups to monitor system resources. To display the sensor paths for each group, use the `show telemetry sensor-group` command.

**Table 102. Pre-configured sensor group**

| Pre-configured sensor group | Minimum sampling interval (milliseconds) |
|-----------------------------|------------------------------------------|
| BGP                         | 15000                                    |
| BGP-peer                    | 0                                        |
| Buffer                      | 15000                                    |
| Device                      | 15000                                    |
| Environment                 | 15000                                    |
| Interface                   | 15000                                    |
| LAG (port channel)          | 0                                        |

**Table 102. Pre-configured sensor group (continued)**

| Pre-configured sensor group | Minimum sampling interval (milliseconds) |
|-----------------------------|------------------------------------------|
| System                      | 15000                                    |

**Configure a destination group**

A destination group defines the destination servers to which streaming telemetry data is sent.

1. Enter the destination group name in TELEMETRY mode. A maximum of 32 characters.

```
OS10(conf-telemetry)# destination-group group-name
```

2. Enter the IPv4 or IPv6 address and transport-service port number in DESTINATION-GROUP mode. Only one destination is supported in the 10.4.3.0 release. You can enter a fully qualified domain name (FQDN) for *ip-address*. The destination domain name resolves to an IP address — see [System domain name and list](#).

```
OS10(conf-telemetry-dg-dest)# destination ip-address port-number
```

The IP address that you specify here is the IP address of the telemetry collector. You can specify any port number between 0 and 65535. Ensure that this port number is configured on the telemetry collector.

3. Return to TELEMETRY mode.

```
OS10(conf-telemetry-dg-dest)# exit
```

**Configure a subscription profile**

A subscription profile associates destination groups and sensor groups, and specifies the data encoding format and transport protocol.

1. Enter the subscription profile name in TELEMETRY mode. A maximum of 32 characters.

```
OS10(conf-telemetry)# subscription-profile profile-name
```

2. Enter the name of a pre-configured sensor group and sampling interval in SUBSCRIPTION-PROFILE mode. Valid sensor-group names are: *bgp*, *bgp-peer*, *buffer*, *device*, *environment*, *interface*, *lag*, and *system*. To view the data contents of a pre-configured sensor group, use the `show telemetry sensor-group` command. The *interface* sensor group supports only physical and port-channel interfaces.

The sampling interval is in milliseconds, from 0 (whenever an event occurs; near real-time) to 4294967295. The default is 15000. Repeat this step to add sensor groups to the subscription profile.

```
OS10(conf-telemetry-sp-subscription)# sensor-group group-name sampling-interval
```

3. Enter the name of a destination group in SUBSCRIPTION-PROFILE mode. Telemetry data is sent to the IP address and port specified in the destination group. Repeat this step to add destination groups to the subscription profile.

```
OS10(conf-telemetry-sp-subscription)# destination-group name
```

4. Enter the source interface in SUBSCRIPTION-PROFILE mode. The system uses the source interface to derive the VRF instance and IP address used to communicate with destination devices. For gRPC transport, source interface configuration is optional.

```
OS10(conf-telemetry-sp-subscription)# source-interface interface
```

Where *interface* is one of the following values:

- *ethernet node/slot/port[:subport]* — Enter a physical Ethernet interface.
  - *loopback number* — Enter a Loopback interface, from 0 to 16383.
  - *management 1/1/1* — Enter the management interface.
  - *port-channel channel-id* — Enter a port-channel ID, from 1 to 28.
  - *vlan vlan-id* — Enter a VLAN ID, from 1 to 4093.
5. Configure the *gpb* encoding format in which data is streamed in SUBSCRIPTION-PROFILE mode.

```
OS10(conf-telemetry-sp-subscription)# encoding format
```

6. Configure the gRPC transport protocol used to stream data to a destination in SUBSCRIPTION-PROFILE mode. gRPC with Transport Security Layer (TLS) certificates enabled is the default transport protocol. To disable TLS certificate exchange, use the `transport grpc no-tls` command.

```
OS10(conf-telemetry-sp-subscription)# transport protocol [no-tls]
```

After you configure a subscription profile, the telemetry agent starts collecting data and streaming it to destination devices.

## View telemetry configuration

Use the following `show` commands to display telemetry configuration.

```
OS10# show telemetry

Telemetry Status : enabled

-- Telemetry Destination Groups --
Group : dest1
 Destination : 10.11.56.204 Port : 40001

-- Telemetry Sensor Groups --
Group : bgp
 Sensor Path : bgp/bgp-oper/bgpPrfxCntrsEntry
 Sensor Path : bgp/bgp-oper/bgpPeerCount
Group : bgp-peer
 Sensor Path : infra-bgp/peer-state/peer-status
Group : buffer
 Sensor Path : base-qos/queue-stat
 Sensor Path : base-qos/priority-group-stat
 Sensor Path : base-qos/buffer-pool-stat
 Sensor Path : base-qos/buffer-pool
Group : device
 Sensor Path : base-pas/chassis
 Sensor Path : base-pas/card
 Sensor Path : base-switch/switching-entities/switch-stats
Group : environment
 Sensor Path : base-pas/entity
 Sensor Path : base-pas/psu
 Sensor Path : base-pas/fan-tray
 Sensor Path : base-pas/fan
 Sensor Path : base-pas/led
 Sensor Path : base-pas/temperature
 Sensor Path : base-pas/temp_threshold
 Sensor Path : base-pas/media
 Sensor Path : base-pas/media-channel
Group : interface
 Sensor Path : if/interfaces-state/interface/statistics
 Sensor Path : dell-base-if-cmn/if/interfaces-state/interface
Group : lag
 Sensor Path : dell-base-if-cmn/if/interfaces
Group : system
 Sensor Path : system-status/current-status

-- Telemetry Subscription Profiles --
Name : subscription-1

 Destination Groups(s) : dest1

 Sensor-group Sample-interval

 bgp 300000
 bgp-peer 0
 buffer 15000
 device 300000
 environment 300000
 interface 180000
 lag 0
 system 300000
```

```
Encoding : gpb
Transport : grpc TLS : disabled
Source Interface : ethernet1/1/1
Active : true
Reason : Connection summary: One or more active connections
 The connection 10.11.56.204:40001 is in connected state
```

### View destination group

```
OS10# show telemetry destination-group

Telemetry Status : enabled

-- Telemetry Destination Groups --
Group : dest1
Destination : 10.11.56.204 Port : 40001
```

### View sensor groups

```
OS10# show telemetry sensor-group

Telemetry Status : enabled

-- Telemetry Sensor Groups --
Group : bgp
 Sensor Path : bgp/bgp-oper/bgpPrfxCntrsEntry
 Sensor Path : bgp/bgp-oper/bgpPeerCount
Group : bgp-peer
 Sensor Path : infra-bgp/peer-state/peer-status
Group : buffer
 Sensor Path : base-qos/queue-stat
 Sensor Path : base-qos/priority-group-stat
 Sensor Path : base-qos/buffer-pool-stat
 Sensor Path : base-qos/buffer-pool
Group : device
 Sensor Path : base-pas/chassis
 Sensor Path : base-pas/card
 Sensor Path : base-switch/switching-entities/switch-stats
Group : environment
 Sensor Path : base-pas/entity
 Sensor Path : base-pas/psu
 Sensor Path : base-pas/fan-tray
 Sensor Path : base-pas/fan
 Sensor Path : base-pas/led
 Sensor Path : base-pas/temperature
 Sensor Path : base-pas/temp_threshold
 Sensor Path : base-pas/media
 Sensor Path : base-pas/media-channel
Group : interface
 Sensor Path : if/interfaces-state/interface/statistics
 Sensor Path : dell-base-if-cmn/if/interfaces-state/interface
Group : lag
 Sensor Path : dell-base-if-cmn/if/interfaces
Group : system
 Sensor Path : system-status/current-status
```

### View subscription profiles

```
OS10# show telemetry subscription-profile

Telemetry Status : enabled

-- Telemetry Subscription Profile --
Name : subscription-1

 Destination Groups(s) : dest1

 Sensor-group Sample-interval

 bgp 300000
 bgp-peer 0
```

```

buffer 15000
device 300000
environment 300000
interface 180000
lag 0
system 300000

Encoding : gpb
Transport : grpc TLS : disabled
Source Interface : ethernet1/1/1
Active : true
Reason : Connection summary: One or more active connections
 The connection 10.11.56.204:40001 is in connected state

```

### Verify telemetry in running configuration

```

OS10# show running-configuration telemetry
!
telemetry
enable
!
destination-group dest1
 destination 10.11.56.204 40001
!
subscription-profile subscription-1
 destination-group dest1
 sensor-group bgp 300000
 sensor-group bgp-peer 0
 sensor-group buffer 15000
 sensor-group device 300000
 sensor-group environment 300000
 sensor-group interface 180000
 sensor-group lag 0
 sensor-group system 300000
 encoding gpb
 transport grpc no-tls
 source-interface ethernet1/1/1

```

## Telemetry commands

### debug telemetry

Starts data collection to troubleshoot telemetry operation.

**Syntax**            `debug telemetry`

**Parameters**        None

**Default**            Not configured

**Command mode**     EXEC

**Usage information**    Use the command to start a local telemetry collector. Connect to the local collector by configuring the destination with loopback ip (127.0.0.1) and port 50051. For example:

- `destination-group local-collector`
- `destination 127.0.0.1 50051`

The local collector data logs will be stored in `/var/log/grpc_server.log`.

**Example**

```
OS10# debug telemetry
```

**Supported releases**    10.4.3.0 or later

## telemetry

Enters Telemetry configuration mode to configure streaming telemetry.

|                           |                                                           |
|---------------------------|-----------------------------------------------------------|
| <b>Syntax</b>             | <code>telemetry</code>                                    |
| <b>Parameters</b>         | None                                                      |
| <b>Default</b>            | Telemetry is disabled on the switch.                      |
| <b>Command mode</b>       | CONFIGURATION                                             |
| <b>Usage information</b>  | Enable and disable streaming telemetry in Telemetry mode. |
| <b>Example</b>            | <pre>OS10(config)# telemetry OS10(conf-telemetry)#</pre>  |
| <b>Supported releases</b> | 10.4.3.0 or later                                         |

## enable

Enables telemetry on the switch.

|                           |                                                                |
|---------------------------|----------------------------------------------------------------|
| <b>Syntax</b>             | <code>enable</code>                                            |
| <b>Parameters</b>         | None                                                           |
| <b>Default</b>            | Telemetry is disabled.                                         |
| <b>Command mode</b>       | TELEMETRY                                                      |
| <b>Usage information</b>  | Enter the <code>no enable</code> command to disable telemetry. |
| <b>Example</b>            | <pre>OS10(conf-telemetry)# enable</pre>                        |
| <b>Supported releases</b> | 10.4.3.0 or later                                              |

## destination-group (telemetry)

Configures a destination group for streaming telemetry.

|                           |                                                                                                                                                                          |
|---------------------------|--------------------------------------------------------------------------------------------------------------------------------------------------------------------------|
| <b>Syntax</b>             | <code>destination-group <i>group-name</i></code>                                                                                                                         |
| <b>Parameters</b>         | <i>group-name</i> — Enter the name of the destination group. A maximum of 32 characters maximum.                                                                         |
| <b>Default</b>            | Not configured                                                                                                                                                           |
| <b>Command mode</b>       | TELEMETRY                                                                                                                                                                |
| <b>Usage information</b>  | A destination group defines the destination servers to which streaming telemetry data is sent. The <code>no</code> version of this command removes the configured group. |
| <b>Example</b>            | <pre>OS10(conf-telemetry)# destination-group dest1 OS10(conf-telemetry-dg-dest1)#</pre>                                                                                  |
| <b>Supported releases</b> | 10.4.3.0 or later                                                                                                                                                        |



## destination

Configures a destination management device that receives streaming telemetry.

|                           |                                                                                                                                                                                                                                                                                                                                                                                                                                                                                                                                                                              |
|---------------------------|------------------------------------------------------------------------------------------------------------------------------------------------------------------------------------------------------------------------------------------------------------------------------------------------------------------------------------------------------------------------------------------------------------------------------------------------------------------------------------------------------------------------------------------------------------------------------|
| <b>Syntax</b>             | <code>destination {ip-address   domain-name} port-number</code>                                                                                                                                                                                                                                                                                                                                                                                                                                                                                                              |
| <b>Parameters</b>         | <ul style="list-style-type: none"><li>• <code>ip-address</code> — Enter the IPv4 or IPv6 address of the destination device. You can enter a fully qualified domain name (FQDN). The destination domain name resolves to an IP address — see <a href="#">System domain name and list</a>.</li><li>• <code>domain-name</code> — Enter the fully qualified domain name of the destination device. A maximum of 32 characters.</li><li>• <code>port-number</code> — Enter the transport-service port number to which telemetry data is sent on the destination device.</li></ul> |
| <b>Default</b>            | Not configured                                                                                                                                                                                                                                                                                                                                                                                                                                                                                                                                                               |
| <b>Command mode</b>       | DESTINATION-GROUP                                                                                                                                                                                                                                                                                                                                                                                                                                                                                                                                                            |
| <b>Usage information</b>  | When you associate a destination group with a subscription, telemetry data is sent to the IP address and port specified by the <code>destination</code> command. In the 10.4.3.0 release, only one destination is supported. The <code>no</code> version of this command removes the configured destination.                                                                                                                                                                                                                                                                 |
| <b>Example</b>            | <pre>OS10(conf-telemetry)# destination-group dest1 OS10(conf-telemetry-dg-dest1)# destination 10.11.56.204 40001 OS10(conf-telemetry-dg-dest1)#</pre>                                                                                                                                                                                                                                                                                                                                                                                                                        |
| <b>Supported releases</b> | 10.4.3.0 or later                                                                                                                                                                                                                                                                                                                                                                                                                                                                                                                                                            |

## subscription-profile

Configures a subscription profile for streaming telemetry data.

|                           |                                                                                                                                                                                                                                                                                                                                                                                                                                                                                                                                  |
|---------------------------|----------------------------------------------------------------------------------------------------------------------------------------------------------------------------------------------------------------------------------------------------------------------------------------------------------------------------------------------------------------------------------------------------------------------------------------------------------------------------------------------------------------------------------|
| <b>Syntax</b>             | <code>subscription-profile profile-name</code>                                                                                                                                                                                                                                                                                                                                                                                                                                                                                   |
| <b>Parameters</b>         | <code>profile-name</code> — Enter a profile name. A maximum of 32 characters.                                                                                                                                                                                                                                                                                                                                                                                                                                                    |
| <b>Default</b>            | Not configured                                                                                                                                                                                                                                                                                                                                                                                                                                                                                                                   |
| <b>Command mode</b>       | TELEMETRY                                                                                                                                                                                                                                                                                                                                                                                                                                                                                                                        |
| <b>Usage information</b>  | <p>A subscription profile associates destination groups with sensor groups, and specifies the data encoding format and transport protocol. Telemetry data is sent to the IP address and port specified in the destination groups.</p> <p> <b>NOTE:</b> The subscription profile can have either OS10 or Openconfig model sensor groups. Both cannot co-exist. If you try to configure both sensor groups, then a warning message appears.</p> |
| <b>Example</b>            | <pre>OS10(conf-telemetry)# subscription-profile subscription-1 OS10(conf-telemetry-sp-subscription-1)#</pre>                                                                                                                                                                                                                                                                                                                                                                                                                     |
| <b>Supported releases</b> | 10.4.3.0 or later                                                                                                                                                                                                                                                                                                                                                                                                                                                                                                                |

## destination-group (subscription-profile)

Assigns a destination group to a subscription profile for streaming telemetry.

|                   |                                                                                                |
|-------------------|------------------------------------------------------------------------------------------------|
| <b>Syntax</b>     | <code>destination-group group-name</code>                                                      |
| <b>Parameters</b> | <code>group-name</code> — Enter the name of the destination group. A maximum of 32 characters. |
| <b>Default</b>    | Not configured                                                                                 |

|                           |                                                                                                                                                                                                                                                                                |
|---------------------------|--------------------------------------------------------------------------------------------------------------------------------------------------------------------------------------------------------------------------------------------------------------------------------|
| <b>Command mode</b>       | SUBSCRIPTION-PROFILE                                                                                                                                                                                                                                                           |
| <b>Usage information</b>  | A subscription profile associates destination groups and sensor groups. A destination group defines the destination servers to which streaming telemetry data is sent. The <code>no</code> version of this command removes the configured group from the subscription profile. |
| <b>Example</b>            | <pre>OS10(conf-telemetry)# subscription-profile subscription-1 OS10(conf-telemetry-sp-subscription-1)# destination-group dest1</pre>                                                                                                                                           |
| <b>Supported releases</b> | 10.4.3.0 or later                                                                                                                                                                                                                                                              |

## sensor-group (subscription-profile)

Assigns a sensor group with sampling interval to a subscription profile for streaming telemetry.

**Syntax** `sensor-group {bgp | bgp-peer | buffer | device | environment | interface | lag | system | oc-bfd | oc-bgp | oc-buffer | oc-device | oc-environment | oc-interface | oc-lacp | oc-lag | oc-lldp | oc-stp | oc-system | oc-vendor-ufd | oc-vendor-vxlan | oc-vlan | oc-vrrp} group-name sampling-interval`

- Parameters**
- *bgp* — Enter *bgp* to assign a BGP statistics sensor group to the subscription profile.
  - *bgp-peer* — Enter *bgp-peer* to assign BGP peer statistics sensor group to the subscription profile.
  - *buffer* — Enter *buffer* to assign buffer statistics sensor group to the subscription profile.
  - *device* — Enter *device* to assign device statistics sensor group to the subscription profile.
  - *environment* — Enter *environmnet* to assign environment statistics sensor group to the subscription profile.
  - *interface* — Enter *interface* to assign interface statistics sensor group to the subscription profile.
  - *lag* — Enter *lag* to assign LAG statistics sensor group to the subscription profile.
  - *system* — Enter *system* to assign system statistics sensor group to the subscription profile.
  - *oc-bfd* — Enter *oc-bfd* to assign Openconfig BFD statistics sensor group to the subscription profile.
  - *oc-bgp* — Enter *oc-bgp* to assign Openconfig BGP statistics sensor group to the subscription profile.
  - *oc-buffer* — Enter *oc-buffer* to assign Openconfig buffer statistics sensor group to the subscription profile.
  - *oc-device* — Enter *oc-device* to assign Openconfig device statistics sensor group to the subscription profile.
  - *oc-environment* — Enter *oc-environment* to assign Openconfig environment statistics sensor group to the subscription profile.
  - *oc-interface* — Enter *oc-interface* to assign Openconfig interface statistics sensor group to the subscription profile.
  - *oc-lacp* — Enter *oc-lacp* to assign Openconfig LACP statistics sensor group to the subscription profile.
  - *oc-lag* — Enter *oc-lag* to assign Openconfig LAG statistics sensor group to the subscription profile.
  - *oc-lldp* — Enter *oc-lldp* to assign Openconfig LLDP statistics sensor group to the subscription profile.
  - *oc-stp* — Enter *oc-stp* to assign Openconfig STP statistics sensor group to the subscription profile.
  - *oc-system* — Enter *oc-system* to assign Openconfig system statistics sensor group to the subscription profile.
  - *oc-vendor-ufd* — Enter *oc-vendor-ufd* to assign vendor specific ufd statistics sensor group to the subscription profile.
  - *oc-vendor-vxlan* — Enter *oc-vendor-vxlan* to assign vendor specific vxlan statistics sensor group to the subscription profile.

- `oc-vlan` — Enter `oc-vlan` to assign Openconfig VLAN statistics sensor group to the subscription profile.
- `oc-vrrp` — Enter `oc-vrrp` to assign Openconfig VRRP statistics sensor group to the subscription profile.
- `sampling-interval` — Enter the interval in milliseconds used to collect data samples. The range is 0 to 4294967295. The default is 15000.

**Default** Not configured

**Command mode** SUBSCRIPTION-PROFILE

**Usage information** This command assigns the sensors from which data is collected for streaming telemetry to a subscription profile and specifies the sampling rate. To add sensor groups to the subscription profile, reenter the command. The `interface` sensor group supports only physical and port channel interfaces. The `no` version of this command deletes the sensor group from the subscription profile.

**NOTE:** The subscription profile should contain either OS10 sensor groups or openconfig sensor groups. Both sensor groups cannot co-exist in a single subscription profile.

### Example

```
OS10(conf-telemetry)# subscription-profile sp01
OS10(conf-telemetry-sp-sp01)#
OS10(conf-telemetry-sp-sp01)# sensor-group
 bgp BGP statistics sensor
group
 bgp-peer BGP Peer statistics sensor group
 buffer QOS Buffer statistics sensor group
 device Device statistics sensor group
 environment Switch peripheral statistics sensor group
 interface Interface statistics sensor group
 lag Lag statistics sensor group
 system System statistics sensor group
 oc-bfd Openconfig BFD statistics sensor group
 oc-bgp Openconfig BGP statistics sensor group
 oc-buffer Openconfig QOS Interface statistics sensor group
 oc-device Openconfig Device statistics sensor group
 oc-environment Openconfig Switch peripheral statistics sensor group
 oc-interface Openconfig Interface statistics sensor group
 oc-lacp Openconfig LACP statistics sensor group
 oc-lag Openconfig LAG statistics sensor group
 oc-lldp Openconfig LLDP statistics sensor group
 oc-stp Openconfig STP statistics sensor group
 oc-system Openconfig System statistics sensor group
 oc-vendor-ufd Vendor UFD statistics sensor group
 oc-vendor-vxlan Vendor VxLAN statistics sensor group
 oc-vlan Openconfig VLAN statistics sensor group
 oc-vrrp Openconfig VRRP statistics sensor group
```

```
OS10(conf-telemetry)# subscription-profile subscription-1
OS10(conf-telemetry-sp-subscription-1)# sensor-group bgp 30000
OS10(conf-telemetry-sp-subscription-1)# sensor-group environment 415000
```

**Supported releases** 10.4.3.0 or later

## encoding

Configures the encoding format used to stream telemetry data to a destination device.

**Syntax** `encoding format`

**Parameters** `format` — Enter the `gpb` (Google protocol buffer) encoding format in which data is streamed.

**Default** None

**Command mode** SUBSCRIPTION-PROFILE

**Usage information** The no version of the command removes the configured encoding format from a subscription profile.

**Example**

```
OS10(conf-telemetry)# subscription-profile subscription-1
OS10(conf-telemetry-sp-subscription-1)# encoding gpb
```

**Supported releases** 10.4.3.0 or later

## transport

Configures the transport protocol used to stream telemetry data to a remote management device.

**Syntax** `transport protocol [no-tls]`

**Parameters**

- `protocol` — Enter the gRPC (Google remote procedure call) transport protocol used for telemetry sessions.
- `no-tls` — (Optional) Disable Transport Security Layer (TLS) certificate exchange with gRPC transport.

**Default** OS10 telemetry uses the gRPC protocol for transport with TLS certificates enabled.

**Command mode** SUBSCRIPTION-PROFILE

**Usage information** gRPC with TLS transport is enabled by default. To use gRPC over TLS transport, you must install a X.509v3 certificate on the switch. To disable TLS certificate exchange, use the `transport grpc no-tls` command.

 **NOTE:** gRPC with TLS transport does not support host certificates. To use a CA certificate, see [Request and install host certificates](#).

The no version of the command removes the configured transport protocol from a subscription profile.

**Example**

```
OS10(conf-telemetry)# subscription-profile subscription-1
OS10(conf-telemetry-sp-subscription-1)# transport grpc
```

**Supported releases** 10.4.3.0 or later

## source-interface

Configures the source interface used to stream telemetry data to a destination device.

**Syntax** `source-interface interface`

**Parameters** `interface` — One of the following values:

- `ethernet node/slot/port[:subport]` — Enter a physical Ethernet interface.
- `loopback number` — Enter a Loopback interface, from 0 to 16383.
- `management 1/1/1` — Enter the management interface.
- `port-channel channel-id` — Enter a port-channel ID, from 1 to 28.
- `vlan vlan-id` — Enter a VLAN ID, from 1 to 4093.

**Default** None

**Command mode** SUBSCRIPTION-PROFILE

**Usage information** The telemetry agent uses the source interface to derive the VRF instance and IP address used to communicate with destination devices. For gRPC transport, source interface configuration is optional. The no version of the command removes the configured source interface from a subscription profile.

## Example

```
OS10(conf-telemetry)# subscription-profile subscription-1
OS10(conf-telemetry-sp-subscription-1)# source-interface ethernet 1/1/1
```

## Supported releases

10.4.3.0 or later

## show telemetry

Displays the configured destination-group, sensor-group, and subscription profiles for streaming telemetry.

### Syntax

```
show telemetry [destination-group [group-name] | sensor-group [group-name]
| subscription-profile [profile-name]]
```

### Parameters

- `destination-group` — Display only destination groups or a specified group.
- `sensor-group` — Display only sensor groups or a specified group.
- `subscription-profile` — Display only subscription profiles or a specified profile.

### Default

Display all destination-group, sensor-group, and subscription configurations.

### Command mode

EXEC

### Usage information

Use the `show telemetry` command to verify the configured destination devices, sensor data sources, and subscription profiles.

### Examples

```
OS10# show telemetry
Telemetry Status : disabled
-- Telemetry Destination Groups --
-- Telemetry Sensor Groups --
Group : bgp
 Sensor Path : bgp/bgp-oper/bgpPrfxCntrsEntry
 Sensor Path : bgp/bgp-oper/bgpPeerCount
Group : bgp-peer
 Sensor Path : infra-bgp/peer-state/peer-status
Group : buffer
 Sensor Path : base-qos/queue-stat
 Sensor Path : base-qos/priority-group-stat
 Sensor Path : base-qos/buffer-pool-stat
 Sensor Path : base-qos/buffer-pool
Group : device
 Sensor Path : base-pas/chassis
 Sensor Path : base-pas/card
 Sensor Path : base-switch/switching-entities/switch-stats
Group : environment
 Sensor Path : base-pas/entity
 Sensor Path : base-pas/psu
 Sensor Path : base-pas/fan-tray
 Sensor Path : base-pas/fan
 Sensor Path : base-pas/led
 Sensor Path : base-pas/temperature
 Sensor Path : base-pas/temp_threshold
 Sensor Path : base-pas/media
 Sensor Path : base-pas/media-channel
Group : interface
 Sensor Path : if/interfaces-state/interface/statistics
 Sensor Path : dell-base-if-cmn/if/interfaces-state/interface
Group : lag
 Sensor Path : dell-base-if-cmn/if/interfaces
Group : system
 Sensor Path : system-status/current-status
Group : oc-bfd
 Sensor Path : openconfig-bfd/bfd
Group : oc-bgp
 Sensor Path : openconfig-bgp/bgp/neighbors/neighbor
 Sensor Path : openconfig-bgp/bgp/rib/afi-safis/afi-safi
Group : oc-buffer
 Sensor Path : openconfig-qos/qos/interfaces/interface
```

```

Group : oc-device
 Sensor Path : openconfig-platform/components/component
 Sensor Path : openconfig-network-instance/network-instances/
networkinstance
Group : oc-environment
 Sensor Path : openconfig-platform/components/component
Group : oc-interface
 Sensor Path : openconfig-interfaces/interfaces/interface
Group : oc-lacp
 Sensor Path : openconfig-lacp/lacp
Group : oc-lag
 Sensor Path : openconfig-interfaces/interfaces/interface
Group : oc-lldp
 Sensor Path : openconfig-lldp/lldp
Group : oc-stp
 Sensor Path : openconfig-spanning-tree/stp
Group : oc-system
 Sensor Path : openconfig-system/system
 Sensor Path : openconfig-platform/components/component
Group : oc-vendor-ufd
 Sensor Path : ufd/uplink-state-group-stats/ufd-groups
Group : oc-vendor-vxlan
 Sensor Path : vxlan/vxlan-state/remote-endpoint/stats
Group : oc-vlan
 Sensor Path : openconfig-interfaces/interfaces/interface
Group : oc-vrrp
 Sensor Path : openconfig-interfaces/interfaces/interface/subinterfaces/
subinterface
-- Telemetry Subscription Profiles --

```

```

OS10# show telemetry destination-group

Telemetry Status : enabled

-- Telemetry Destination Groups --
Group : dest1
 Destination : 10.11.56.204 Port : 40001
Group : dest2
 Destination : 10.11.56.204 Port : 40002

```

```

OS10# show telemetry sensor-group

Telemetry Status : disabled

-- Telemetry Sensor Groups --
Group : bgp
 Sensor Path : bgp/bgp-oper/bgpPrfxCntersEntry
 Sensor Path : bgp/bgp-oper/bgpPeerCount
Group : bgp-peer
 Sensor Path : infra-bgp/peer-state/peer-status
Group : buffer
 Sensor Path : base-qos/queue-stat
 Sensor Path : base-qos/priority-group-stat
 Sensor Path : base-qos/buffer-pool-stat
 Sensor Path : base-qos/buffer-pool
Group : device
 Sensor Path : base-pas/chassis
 Sensor Path : base-pas/card
 Sensor Path : base-switch/switching-entities/switch-stats
Group : environment
 Sensor Path : base-pas/entity
 Sensor Path : base-pas/psu
 Sensor Path : base-pas/fan-tray
 Sensor Path : base-pas/fan
 Sensor Path : base-pas/led
 Sensor Path : base-pas/temperature
 Sensor Path : base-pas/temp_threshold
 Sensor Path : base-pas/media
 Sensor Path : base-pas/media-channel
Group : interface

```

```

 Sensor Path : if/interfaces-state/interface/statistics
 Sensor Path : dell-base-if-cmn/if/interfaces-state/interface
Group : lag
 Sensor Path : dell-base-if-cmn/if/interfaces
Group : system
 Sensor Path : system-status/current-status
Group : oc-bfd
 Sensor Path : openconfig-bfd/bfd
Group : oc-bgp
 Sensor Path : openconfig-bgp/bgp/neighbors/neighbor
 Sensor Path : openconfig-bgp/bgp/rib/afi-safis/afi-safi
Group : oc-buffer
 Sensor Path : openconfig-qos/qos/interfaces/interface
Group : oc-device
 Sensor Path : openconfig-platform/components/component
 Sensor Path : openconfig-network-instance/network-instances/network-
instance
Group : oc-environment
 Sensor Path : openconfig-platform/components/component
Group : oc-interface
 Sensor Path : openconfig-interfaces/interfaces/interface
Group : oc-lacp
 Sensor Path : openconfig-lacp/lacp
Group : oc-lag
 Sensor Path : openconfig-interfaces/interfaces/interface
Group : oc-lldp
 Sensor Path : openconfig-lldp/lldp
Group : oc-stp
 Sensor Path : openconfig-spanning-tree/stp
Group : oc-system
 Sensor Path : openconfig-system/system
 Sensor Path : openconfig-platform/components/component
Group : oc-vendor-ufd
 Sensor Path : ufd/uplink-state-group-stats/ufd-groups
Group : oc-vendor-vxlan
 Sensor Path : vxlan/vxlan-state/remote-endpoint/stats
Group : oc-vlan
 Sensor Path : openconfig-interfaces/interfaces/interface
Group : oc-vrrp
 Sensor Path : openconfig-interfaces/interfaces/interface/subinterfaces/
subinterface
OS10#

```

```

Subscription profile with dell model sensor group
=====

```

```

OS10# show telemetry subscription-profile
Telemetry Status : enabled
-- Telemetry Subscription Profile --
Name : subscription-1
Destination Groups(s) : dest1
Sensor-group Sample-interval

bgp 300000
bgp-peer 0
buffer 15000
device 300000
environment 300000
interface 180000
lag 0
system 300000
Encoding : gpb
Transport : grpc TLS : disabled
Source Interface : ethernet1/1/1
Active : true
Reason : Connection summary: One or more active connections
The connection 10.11.56.204:40001 is in connected state

```

```

Subscription profile with openconfig model sensor group
=====

OS10# show telemetry subscription-profile

Telemetry Status : enabled

-- Telemetry Subscription Profile --

Name : subscription-2

Destination Groups(s) : dest2

Sensor-group Sample-interval

oc-bfd 15000
oc-bgp 15000
oc-buffer 15000
oc-device 15000
oc-environment 15000
oc-interface 15000
oc-lacp 15000
oc-lag 0
oc-lldp 15000
oc-stp 15000
oc-system 15000
oc-vendor-ufd 15000
oc-vendor-vxlan 15000
oc-vlan 15000
oc-vrrp 15000

Encoding : gpb
Transport : grpc TLS : disabled
Source Interface : ethernet1/1/1
Active : true
Reason : Connection summary: One or more active connections
The connection 10.11.56.204:40002 is in connected state

```

**Supported releases** 10.4.3.0 or later

## Example: Configure streaming telemetry

```

OS10(config)# telemetry
OS10(conf-telemetry)# enable
OS10(conf-telemetry)# destination-group dest1
OS10(conf-telemetry-dg-dest1)# destination 10.11.56.204 40001
OS10(conf-telemetry-dg-dest1)# exit
OS10(conf-telemetry)# subscription-profile subscription-1
OS10(conf-telemetry-sp-subscription-1)# sensor-group bgp 300000
OS10(conf-telemetry-sp-subscription-1)# sensor-group bgp-peer 0
OS10(conf-telemetry-sp-subscription-1)# sensor-group buffer 15000
OS10(conf-telemetry-sp-subscription-1)# sensor-group device 300000
OS10(conf-telemetry-sp-subscription-1)# sensor-group environment 300000
OS10(conf-telemetry-sp-subscription-1)# sensor-group interface 180000
OS10(conf-telemetry-sp-subscription-1)# sensor-group lag 0
OS10(conf-telemetry-sp-subscription-1)# sensor-group system 300000
OS10(conf-telemetry-sp-subscription-1)# destination-group dest1
OS10(conf-telemetry-sp-subscription-1)# encoding gpb
OS10(conf-telemetry-sp-subscription-1)# transport grpc no-tls
OS10(conf-telemetry-sp-subscription-1)# source-interface ethernet 1/1/1
OS10(conf-telemetry-sp-subscription-1)# end

```

```

OS10# show telemetry

Telemetry Status : enabled

```



```

-- Telemetry Destination Groups --
Group : dest1
 Destination : 10.11.56.204 Port : 40001

-- Telemetry Sensor Groups --
Group : bgp
 Sensor Path : bgp/bgp-oper/bgpPrfxCntrsEntry
 Sensor Path : bgp/bgp-oper/bgpPeerCount
Group : bgp-peer
 Sensor Path : infra-bgp/peer-state/peer-status
Group : buffer
 Sensor Path : base-qos/queue-stat
 Sensor Path : base-qos/priority-group-stat
 Sensor Path : base-qos/buffer-pool-stat
 Sensor Path : base-qos/buffer-pool
Group : device
 Sensor Path : base-pas/chassis
 Sensor Path : base-pas/card
 Sensor Path : base-switch/switching-entities/switch-stats
Group : environment
 Sensor Path : base-pas/entity
 Sensor Path : base-pas/psu
 Sensor Path : base-pas/fan-tray
 Sensor Path : base-pas/fan
 Sensor Path : base-pas/led
 Sensor Path : base-pas/temperature
 Sensor Path : base-pas/temp_threshold
 Sensor Path : base-pas/media
 Sensor Path : base-pas/media-channel
Group : interface
 Sensor Path : if/interfaces-state/interface/statistics
 Sensor Path : dell-base-if-cmn/if/interfaces-state/interface
Group : lag
 Sensor Path : dell-base-if-cmn/if/interfaces
Group : system
 Sensor Path : system-status/current-status
Group : oc-bfd
 Sensor Path : openconfig-bfd/bfd
Group : oc-bgp
 Sensor Path : openconfig-bgp/bgp/neighbors/neighbor
 Sensor Path : openconfig-bgp/bgp/rib/afi-safis/afi-safi
Group : oc-buffer
 Sensor Path : openconfig-qos/qos/interfaces/interface
Group : oc-device
 Sensor Path : openconfig-platform/components/component
 Sensor Path : openconfig-network-instance/network-instances/networkinstance
Group : oc-environment
 Sensor Path : openconfig-platform/components/component
Group : oc-interface
 Sensor Path : openconfig-interfaces/interfaces/interface
Group : oc-lacp
 Sensor Path : openconfig-lacp/lacp
Group : oc-lag
 Sensor Path : openconfig-interfaces/interfaces/interface
Group : oc-lldp
 Sensor Path : openconfig-lldp/lldp
Group : oc-stp
 Sensor Path : openconfig-spanning-tree/stp
Group : oc-system
 Sensor Path : openconfig-system/system
 Sensor Path : openconfig-platform/components/component
Group : oc-vendor-ufd
 Sensor Path : ufd/uplink-state-group-stats/ufd-groups
Group : oc-vendor-vxlan
 Sensor Path : vxlan/vxlan-state/remote-endpoint/stats
Group : oc-vlan
 Sensor Path : openconfig-interfaces/interfaces/interface
Group : oc-vrrp
 Sensor Path : openconfig-interfaces/interfaces/interface/subinterfaces/subinterface

-- Telemetry Subscription Profiles --
Name : subscription-1

```

Destination Groups(s) : dest1

| Sensor-group | Sample-interval |
|--------------|-----------------|
| -----        | -----           |
| bgp          | 300000          |
| bgp-peer     | 0               |
| buffer       | 15000           |
| device       | 300000          |
| environment  | 300000          |
| interface    | 180000          |
| lag          | 0               |
| system       | 300000          |

Encoding : gpb

Transport : grpc TLS : disabled

Source Interface : ethernet1/1/1

Active : true

Reason : Connection summary: One or more active connections

The connection 10.11.56.204:40001 is in connected state

## RESTCONF API

RESTCONF is a representational state transfer (REST)-like protocol that uses HTTPS connections. Use the OS10 RESTCONF API to set up the configuration parameters on OS10 switches using JavaScript Object Notation (JSON)-structured messages. Use any programming language to create and send JSON messages. The examples in this chapter use curl.

The OS10 RESTCONF implementation complies with RFC 8040. You can use the RESTCONF API to configure and monitor an OS10 switch.

The OS10 RESTCONF API uses HTTP with the Transport Layer Security (TLS) protocol over port 443. OS10 supports HTTP/1.1 transport as defined in RFC 7230. The RESTCONF API uses pluggable authentication modules (PAM)-based authentication.

On supported platforms, the OS10 RESTCONF API is disabled by default. To configure and enable the RESTCONF API, see the *Configure the RESTCONF API* section.

To configure and monitor an OS10 switch, use REST API client tools, such as Postman or Swagger, to execute web requests. REST API requests, such as GET, PUT, POST, DELETE, and PATCH, operate on OS10 RESTCONF resources, such as:

**Table 103. OS10 RESTCONF resources**

| Resource   | Description                                                               | URL                  |
|------------|---------------------------------------------------------------------------|----------------------|
| Data       | Configuration and operational data the RESTCONF API client accesses       | /restconf/data       |
| Operations | Container for the protocol-specific data model operations OS10 advertises | /restconf/operations |

To browse OS10 RESTCONF API end-points and operations, see the OpenAPI JSON files available on the OS10 Enterprise Edition Software page at the [Dell EMC Support](#) site. Download the JSON files and import them to REST API client tools; for example, Swagger or Postman, to generate code, documentation, and test cases. For information about the OpenAPI specification, go to <https://swagger.io/docs/specification/about/>.

## Configure RESTCONF API

To use the RESTCONF API on an OS10 interface, you must enable the RESTCONF API service using the `rest api restconf` command. You can also configure HTTPS access, including:

- Hostname required in a Secure Sockets Layer (SSL) self-signed server certificate
- Timeout for the HTTPS connection
- Cipher suites for encrypting data in an HTTPS connection

After you enable the RESTCONF API, you can send HTTPS requests from a remote device.

1. (Optional) Configure the hostname required in the SSL self-signed server certificate in a RESTCONF HTTPS connection in CONFIGURATION mode, using a maximum of 30 alphanumeric characters. Enter the IP address or domain name of the OS10 switch. By default, the domain name of the OS10 switch is used as the hostname.

```
rest https server-certificate name hostname
```

2. (Optional) Configure the timeout that a RESTCONF HTTPS session uses in CONFIGURATION mode, from 30 to 65535 seconds; default 30.

```
rest https session timeout seconds
```

3. (Optional) Limit the ciphers that the switch uses in a RESTCONF HTTPS session to encrypt and decrypt data in CONFIGURATION mode. By default, all cipher suites installed on OS10 are supported. Separate multiple entries with a blank space. Valid cipher-suite values are:
  - `dhe-rsa-with-aes-128-gcm-SHA256`
  - `dhe-rsa-with-aes-256-gcm-SHA384`

- ecdhe-rsa-with-aes-128-gcm-SHA256
- ecdhe-rsa-with-aes-256-gcm-SHA384

```
rest https cipher-suite
```

#### 4. Enable RESTCONF API in CONFIGURATION mode.

```
rest api restconf
```

### RESTCONF API configuration

```
OS10(config)# rest https server-certificate name OS10.dell.com
OS10(config)# rest https session timeout 60
OS10(config)# rest https cipher-suite dhe-rsa-with-aes-128-gcm-SHA256
dhe-rsa-with-aes-256-gcm-SHA384 ecdhe-rsa-with-aes-256-gcm-SHA384
OS10(config)# rest api restconf
```

## RESTCONF request of CLI command

OS10 enables you to find equivalent RESTCONF requests of the CLI commands. The `cli mode rest-translate` command enables the CLI-RESTCONF translation mode in the current session.

when the CLI commands run in the translation mode, the console displays the equivalent RESTCONF requests (CURL commands). You can use the CURL command with minimal modifications to the following:

- \$USER\_NAME - username of any CLI user account
- \$PASSWORD - password of the CLI user account
- \$MGMT\_IP - management IP address

The CURL commands for the CLI commands are appended to the file.

The `show cli mode` command displays the file name and path, which stores the translated RESTCONF requests. The file is available only during active CLI session. The `show` command also displays the current CLI mode (`netconf/REST-TRANSLATE`). When the session is in the translation mode, the prompt changes to `REST-TRANSLATE-<hostname>`.

```
REST-TRANSLATE-OS10# show cli mode
Current CLI session mode : rest-translate
Translated requests are available as supportbundle://restconf_requests_4105.txt
REST-TRANSLATE-OS10#
```

You can use the standard copy command to download the translated RESTCONF requests from OS10.

```
copy supportbundle://restconf_requests.txt <remote-file>
```

Use the CLI batch mode to translate multiple CLI commands to their equivalent RESTCONF requests.

```
batch <batch options>
```

The `no cli mode` command disables the RESTCONF translation mode and changes the CLI session into a normal mode (including the CLI prompt).

### PATCH to POST operation

**NOTE:** If a PATCH request fails with an **unknown-resource-instance** error message when a PATCH request is made to a non-existing object, perform POST. To configure the PATCH:

- Change the operation from PATCH to POST .
- Change the URI as `/restconf/data`.

The following is an example of a PATCH and POST request:

### PATCH request

```
curl -i -k -H "Accept: application/json" -H "Content-Type: application/json" -u
$USER_NAME:$PASSWORD -d '{"dell-diffserv-classifier:classifier-entry":
[{"name":"test","mtype":"qos","match":"match-any"}]}' -X PATCH https://$MGMT_IP/restconf/
data/dell-diffserv-classifier:classifier-entry=test
```

## Error

```
{"ietf-restconf:errors":{"error":[{"error-type":"rpc","error-tag":"invalid-value","error-app-tag":"data-invalid","error-path":"/classifier-entry","error-message":"unknown resource instance","error-info":{"bad-value":"/restconf/data/dell-diffserv-classifier:classifier-entry=test","error-number":388}}]}}
```

## POST request

```
curl -i -k -H "Accept: application/json" -H "Content-Type: application/json" -u $USER_NAME:$PASSWORD -d '{"dell-diffserv-classifier:classifier-entry":[{"name":"test","mtype":"qos","match":"match-any"}]}' -X POST https://$MGMT_IP/restconf/data
```

## Configuration notes

The "request-instance test failed" indicates that there is no target resource.

To create the target resource, use the POST request:

```
curl -i -k -H "Accept: application/json" -H "Content-Type: application/json" -u $USER_NAME:$PASSWORD -X POST -d '{}'
https://$MGMT_IP/restconf/data/dell-qos:trust-map-dot1p-to-tc-entry
```

To check if a target resource is available, use the GET request:

```
curl -i -k -H "Accept: application/json" -H "Content-Type: application/json" -u $USER_NAME:$PASSWORD -X GET
https://$MGMT_IP/restconf/data/dell-qos:trust-map-dot1p-to-tc-entry
```

## Obtain RESTCONF API documentation from OS10

OAS files (`oas.tgz`) are available in the `support-bundle` directory in OS10. You can download the OAS files using the standard copy command.

```
copy supportbundle://oas.tgz <remote-file>
```

To view the JSON files, decompress and untar the `oas.tgz` file.

```
tar -zxvf oas.tgz
```

All the OAS JSON files are extracted inside the `html` folder. You can import the OAS files into RESTCONF tools (Swagger / Postman) to use it.

## Translated RESTCONF requests example

### Config command

```
OS10# cli mode rest-translate
Commands executed in this mode will not alter current system state.
Do you want to proceed? [confirm yes/no]:yes
REST-TRANSLATE-OS10# configure terminal
```

CLI command:

```
configure terminal
```

Restconf request(s):

```
curl -i -k -H "Accept: application/json" -u $USER_NAME:$PASSWORD -X GET https://$MGMT_IP/restconf/data/dell-mgmt-cm:cms
```

```
REST-TRANSLATE-OS10(config)# interface ethernet 1/1/1
```

CLI command:

```
interface ethernet 1/1/1
```

Restconf request(s):

```
curl -i -k -H "Accept: application/json" -H "Content-Type: application/json" -u $USER_NAME:$PASSWORD -d '{"ietf-interfaces:interfaces":{"interface":[{"name":"ethernet1/1/1","type":"iana-if-type:ethernetCsmacd"}]}}' -X PATCH https://$MGMT_IP/restconf/data/ietf-interfaces:interfaces
```

```
REST-TRANSLATE-OS10(conf-if-eth1/1/1)# description "ethernet 1/1/1"
```

CLI command:

```
description "ethernet 1/1/1"
```

Restconf request(s):

```
curl -i -k -H "Accept: application/json" -H "Content-Type: application/json" -u $USER_NAME:$PASSWORD -d '{"ietf-interfaces:interfaces":{"interface":[{"name":"ethernet1/1/1","description":"ethernet 1/1/1"}]}}' -X PATCH https://$MGMT_IP/restconf/data/ietf-interfaces:interfaces
```

```
REST-TRANSLATE-OS10(conf-if-eth1/1/1)# no description
```

CLI command:

```
no description
```

Restconf request(s):

```
curl -i -k -H "Accept: application/json" -H "Content-Type: application/json" -u $USER_NAME:$PASSWORD -X DELETE https://$MGMT_IP/restconf/data/ietf-interfaces:interfaces/interface=ethernet1%2F1%2F1/description
```

```
curl -i -k -H "Accept: application/json" -H "Content-Type: application/json" -u $USER_NAME:$PASSWORD -d '{"ietf-interfaces:interfaces":{"interface":[{"name":"ethernet1/1/1"}]}}' -X PATCH https://$MGMT_IP/restconf/data/ietf-interfaces:interfaces
```

```
REST-TRANSLATE-OS10(conf-if-eth1/1/1)# exit
```

### Show command

```
REST-TRANSLATE-OS10# show version
```

CLI command:

```
show version
```

Restconf request(s):

```
curl -i -k -H "Accept: application/json" -u $USER_NAME:$PASSWORD -X GET https://$MGMT_IP/restconf/data/dell-system-software:system-sw-state/sw-version
```

```
curl -i -k -H "Accept: application/json" -u $USER_NAME:$PASSWORD -X GET https://$MGMT_IP/restconf/data/dell-system:system-state/system-status
```

### Action/RPC based command

```
OS10# cli mode rest-translate
Commands executed in this mode will not alter current system state.
Do you want to proceed? [confirm yes/no]:yes
REST-TRANSLATE-OS10# configure terminal
```

CLI command:

```
ztd cancel
```

Restconf request(s):

```
curl -i -k -H "Accept: application/json" -H "Content-Type: application/json" -u $USER_NAME:$PASSWORD -d '{"input":{"action":"cancel"}}' -X POST https://$MGMT_IP/restconf/operations/dell-ztd:ztd-action
```

REST-TRANSLATE-OS10#

CLI commands generate Multiple RESTCONF requests:

- If the command updates multiple objects (within same module or across modules), the command translates into multiple RESTCONF requests. It is because the target resource in the URI can only be a single object.
- If the command performs multiple operations in a single request (merge and delete on leafs), the CLI first generates a DELETE request and then PATCH with the remaining objects.

Certain CLI commands require user confirmation (yes or no). Enter **Yes** to view the RESTCONF translation for the commands.

Some CLI commands generate multiple RESTCONF requests. Use certain requests according to the Notes information displayed along with the translation. For example, `reload` command generates request for both save running to start up config and reload operation. The Notes information provides meaningful messages to the user to use the translated RESTCONF messages.

```
OS10# cli mode rest-translate
Commands executed in this mode will not alter current system state.
Do you want to proceed? [confirm yes/no]:no
OS10# reload
```

CLI command:

```
reload
```

Restconf request(s):

```
curl -i -k -H"Accept: application/json"-H"Content-Type: application/json"-u
$USER_NAME:$PASSWORD -d'{"dell-ztd:input":{"action":"disable"}}'-X POST https://$MGMT_IP/
restconf/operations/dell-ztd:ztd-action

curl -i -k -H"Accept: application/json"-H"Content-Type: application/json"-u
$USER_NAME:$PASSWORD -d'{"input":{"target":"startup", "source":"running"}}'-X POST
https://$MGMT_IP/restconf/operations/copy-config

curl -i -k -H"Accept: application/json"-H"Content-Type: application/json"-u
$USER_NAME:$PASSWORD -d'{"dell-node-management:input":{"reboot":"cold","reboot-
reason":"CLI reload"}}'-X POST https://$MGMT_IP/restconf/operations/dell-node-
management:reload-system
```

 **NOTE:** Before triggering reload, disable ZTD and save running to start up.

The following is another example with Notes information for the requests. The last RESTCONF request is applicable on certain available conditions.

```
OS10# cli mode rest-translate
Commands executed in this mode will not alter current system state.
Do you want to proceed? [confirm yes/no]:yes
REST-TRANSLATE-OS10# configure terminal
```

CLI command:

```
configure terminal
```

Restconf request(s):

```
curl -i -k -H "Accept: application/json" -u $USER_NAME:$PASSWORD -X GET https://$MGMT_IP/
restconf/data/dell-mgmt-cm:cms
```

REST-TRANSLATE-OS10(config)# interface ethernet 1/1/1

CLI command:

```
interface ethernet 1/1/1
```

Restconf request(s):

```
curl -i -k -H "Accept: application/json" -H "Content-Type: application/json" -u
$USER_NAME:$PASSWORD -d '{"ietf-interfaces:interfaces":{"interface":
[{"name":"ethernet1/1/1","type":"iana-if-type:ethernetCsmacd"]}}}' -X PATCH https://
$MGMT_IP/restconf/data/ietf-interfaces:interfaces
```

REST-TRANSLATE-OS10(conf-if)# no ip ospf 1 area 100"

CLI command:

```
no ip ospf 1 area 100
```

Restconf request(s):

```
curl -i -k -H"Accept: application/json"-H"Content-Type: application/json"-u
$USER_NAME:$PASSWORD -X DELETE https://$MGMT_IP/restconf/data/ietf-interfaces:interfaces/
interface/dell-ospf-v2:ospf-info/dell-ospf-v2:proc-id

curl -i -k -H"Accept: application/json"-H"Content-Type: application/json"-u
$USER_NAME:$PASSWORD -X DELETE https://$MGMT_IP/restconf/data/ietf-interfaces:interfaces/
interface/dell-ospf-v2:ospf-info/dell-ospf-v2:area-id

curl -i -k -H"Accept: application/json"-H"Content-Type: application/json"-u
$USER_NAME:$PASSWORD -X DELETE https://$MGMT_IP/restconf/data/ietf-interfaces:interfaces/
interface/dell-ospf-v2:ospf-info
```

 **NOTE:** Container removal is valid only when it is empty.

## REST Token-Based Authentication

The REST Token-Based Authentication feature uses token-based authentication. Every OS10 REST API call requires basic authentication over HTTPS (with HTTP header 'Authorization: Basic <credentials>'). Instead a token is obtained first by calling the Login REST API using the basic authentication. You can use this token in further REST requests using HTTP Bearer Authentication (with HTTP header 'Authorization: Bearer <token>').

 **NOTE:** Token-based authentication is optional, and the user can use the basic authentication for each REST API request.

### Sample response from login API:

```
{
 "access_token": <access token>,
 "token_type": "bearer",
 "refresh_token": <refresh token>
}
```

Access token is valid for the configured amount of time, from the time token is issued.

Refresh can be done only for the configured number of times. After that new set of tokens needs to be acquired using basic authentication.

Refresh token is valid for the configured validity time of access token that is multiplied by the configured refresh limit.

### REST Token-Based Authentication Limitations

The following limitations are applicable in 10.5.1:

- REST token authentication is disabled when FIPS mode is enabled.

## Acquire new token

You can acquire a new token by calling the Login REST API. A successful Login API call using the basic authentication generates a new set of token.

```
$ curl -X GET -k -u admin:admin -H "Content-Type: application/json" https://$TARGET/
login
{
 "access_token": "abc.123.xyz",
 "token_type": "bearer",
 "refresh_token": "efg.456.uvw"
}
```



On successful login, JSON data returns 'access\_token' and 'refresh\_token' as keys. You can parse the data and save the token values for subsequent requests.

```
$ export ACCESS_TOKEN="abc.123.xyz"
$ export REFRESH_TOKEN="efg.456.uvw"
```

The following is an example of a RS256 signed token:

```
"eyJhbGciOiJSUzI1NiIsInR5cCI6IkpXVCJ9.eyJ1c2VybmFtZSI6ImFkbWluIiwiaXNjaXN0eSI6ImNjcyMjcxfQ.nDydDFFjLju6jYuR9waxmvVZ6iVHoJZSrgey2p3S_0B_fD5U2GU8tOjTr3paJ3Wvs1a3TQpKQ_xAp-9zxBwUoJFTC2qjKH6uMgTgfWxltrfcb3_9JF1SISyGHAT-oUzcdCmC47T1XRIRLzCz9w4Q5vFqxKYv1sRA47T9sSnAZac"
```

## Access token

You can use the HTTP Bearer Authentication to pass the access token to subsequent REST API requests. You can do this using the HTTP Authorization header with syntax 'Authorization: Bearer <TOKEN>'.

The following is the output of the command:

```
$ curl -X GET -k -H "Authorization: Bearer $ACCESS_TOKEN" -H "Content-Type: application/
json" https://$TARGET/restconf/data/dell-system:system/hostname {"dell-
system:hostname":"OS10"}
```

## Refresh token

You can use the HTTP Bearer Authentication with the same Login REST API to acquire a new access token. Place the same refresh token available in the authorization header in the 'refresh\_token' key of output data.

```
$ curl -X GET -k -H "Authorization: Bearer $REFRESH_TOKEN" -H "Content-Type: application/
json" https://$TARGET/login
{
 "access_token": "ijk.978.rst",
 "token_type": "bearer",
 "refresh_token": "efg.456.uvw"
}
```

The validity of the refresh token is equal to the validity of the access token multiplied by the refresh limit.

# CLI commands for RESTCONF API

## rest api restconf

Enables the RESTCONF API service on the switch.

|                          |                                                                                                                                                                                                                                     |
|--------------------------|-------------------------------------------------------------------------------------------------------------------------------------------------------------------------------------------------------------------------------------|
| <b>Syntax</b>            | <code>rest api restconf</code>                                                                                                                                                                                                      |
| <b>Parameters</b>        | None                                                                                                                                                                                                                                |
| <b>Default</b>           | RESTCONF API is disabled.                                                                                                                                                                                                           |
| <b>Command Mode</b>      | CONFIGURATION                                                                                                                                                                                                                       |
| <b>Usage Information</b> | <ul style="list-style-type: none"><li>After you enable the RESTCONF API, you can send curl commands in HTTPS requests from a remote device.</li><li>The <code>no</code> version of the command disables the RESTCONF API.</li></ul> |

**Example**

```
OS10(config)# rest api restconf
```

**Supported Releases** 10.4.1.0 or later

## rest https cipher-suite

Limits the ciphers to encrypt and decrypt REST HTTPS data.

|                           |                                                                                                                                                                                                                                                                                                                                                                                                                              |
|---------------------------|------------------------------------------------------------------------------------------------------------------------------------------------------------------------------------------------------------------------------------------------------------------------------------------------------------------------------------------------------------------------------------------------------------------------------|
| <b>Syntax</b>             | <code>rest https cipher-suite <i>cipher-list</i></code>                                                                                                                                                                                                                                                                                                                                                                      |
| <b>Parameters</b>         | <i>cipher-list</i> — Enter the ciphers supported in a REST API HTTPS session. Separate multiple entries with a blank space. Valid cipher suites are: <ul style="list-style-type: none"><li>• <code>dhe-rsa-with-aes-128-gcm-SHA256</code></li><li>• <code>dhe-rsa-with-aes-256-gcm-SHA384</code></li><li>• <code>ecdhe-rsa-with-aes-128-gcm-SHA256</code></li><li>• <code>ecdhe-rsa-with-aes-256-gcm-SHA384</code></li></ul> |
| <b>Default</b>            | All cipher suites installed with OS10 are supported.                                                                                                                                                                                                                                                                                                                                                                         |
| <b>Command Mode</b>       | CONFIGURATION                                                                                                                                                                                                                                                                                                                                                                                                                |
| <b>Usage Information</b>  | <ul style="list-style-type: none"><li>• Use the <code>rest https cipher-suite</code> command to restrict the ciphers that a RESTCONF HTTPS session uses.</li><li>• The <code>no</code> version of the command removes the cipher list and restores the default value.</li></ul>                                                                                                                                              |
| <b>Example</b>            | <pre>OS10(config)# rest https cipher-suite dhe-rsa-with-aes-128-gcm-SHA256 dhe-rsa-with-aes-256-gcm-SHA384 ecdhe-rsa-with-aes-256-gcm-SHA384</pre>                                                                                                                                                                                                                                                                           |
| <b>Supported Releases</b> | 10.4.1.0 or later                                                                                                                                                                                                                                                                                                                                                                                                            |

## rest https server-certificate

Creates the SSL self-signed server certificate a RESTCONF HTTPS connection uses.

|                           |                                                                                                   |
|---------------------------|---------------------------------------------------------------------------------------------------|
| <b>Syntax</b>             | <code>rest https server-certificate name <i>hostname</i></code>                                   |
| <b>Parameters</b>         | <i>name hostname</i> — Enter the IP address or domain name of the OS10 switch.                    |
| <b>Default</b>            | The OS10 switch domain name is used as the <i>hostname</i> .                                      |
| <b>Command Mode</b>       | CONFIGURATION                                                                                     |
| <b>Usage Information</b>  | The <code>no</code> version of the command removes the host name from the SSL server certificate. |
| <b>Example</b>            | <pre>OS10(config)# rest https server-certificate name 10.10.10.10</pre>                           |
| <b>Supported Releases</b> | 10.4.1.0 or later                                                                                 |

## rest https session timeout

Configures the timeout a RESTCONF HTTPS connection uses.

|                          |                                                                                                                                                             |
|--------------------------|-------------------------------------------------------------------------------------------------------------------------------------------------------------|
| <b>Syntax</b>            | <code>rest https session timeout <i>seconds</i></code>                                                                                                      |
| <b>Parameters</b>        | <i>seconds</i> — Enter the switch timeout for an HTTPS request from a RESTCONF client, from 30 to 65535 seconds.                                            |
| <b>Default</b>           | 30 seconds                                                                                                                                                  |
| <b>Command Mode</b>      | CONFIGURATION                                                                                                                                               |
| <b>Usage Information</b> | <ul style="list-style-type: none"><li>• If no HTTPS request is received within the configured time, the switch closes the RESTCONF HTTPS session.</li></ul> |

- The `no` version of the command removes the configured RESTCONF HTTPS session timeout.

**Example**

```
OS10(config)# rest https session timeout 60
```

**Supported Releases**

10.4.1.0 or later

## cli mode rest-translate

Enable RESTCONF translation mode in CLI session.

**Syntax** `cli mode rest-translate`

**Parameters** None

**Default** None

**Command Mode** Exec

**Usage Information** This command enables translation of CLI command into equivalent RESTCONF requests in the current session.

**Example**

```
OS10# cli mode rest-translate
```

**Supported Releases**

10.5.1.0 or later

## no cli mode

Disable RESTCONF translation mode in CLI session.

**Syntax** `no cli mode`

**Parameters** None

**Default** None

**Command Mode** Exec

**Usage Information** This command disables translation of CLI command into equivalent RESTCONF requests in the current session.

**Example**

```
REST-TRANSLATE-OS10# no cli mode
```

**Supported Releases**

10.5.1.0 or later

## show cli mode

Display the current CLI session mode.

**Syntax** `show cli mode`

**Parameters** None

**Default** None

**Command Mode** Exec

**Usage Information** This command displays the active mode of the current CLI session and also the file name where the RESTCONF requests are stored.

### Example

```
OS10# show cli mode
```

```
Current CLI session mode : rest-translate
```

```
Translated requests are available as supportbundle://
restconf_requests_1132.txt
```

```
OS10#
```

**Supported Releases** 10.5.1.0 or later

## rest authentication token validity

Configures the validity duration for the tokens.

**Syntax** `rest authentication token validity minutes`

**Parameters** *minutes* — Enter the validity duration (0 to 1200 minutes) for the REST Access Token. 0 indicates that the token has no expiry.

**Default** 120 minutes

**Command Mode** CONFIGURATION

**Usage Information** This command updates the validity duration for the REST Access Tokens. The `no` version of the command resets the validity duration to the default value.

### Example

```
OS10(config)# rest authentication token validity 10
```

```
OS10(config)# rest authentication token validity 0
```

**Supported Releases** 10.4.1.0 or later

## rest authentication token max-refresh

Configures the maximum refresh time.

**Syntax** `rest authentication token max-refresh count`

**Parameters** *count* — Enter the refresh count limit, from 0 to 10. The count indicates the maximum number of times the tokens refresh. If you do not want to refresh, enter 0.

**Default** 3

**Command Mode** CONFIGURATION

**Usage Information** This command updates the maximum number of times the tokens refresh. The `no` version of the command resets the count to the default value.

### Example

```
OS10(config)# rest authentication token max-refresh 10
```

```
OS10(config)# rest authentication token max-refresh 0
```

**Supported Releases** 10.4.1.0 or later

## rest authentication token algorithm

Configures the token signing algorithm.

|                           |                                                                                                                                       |
|---------------------------|---------------------------------------------------------------------------------------------------------------------------------------|
| <b>Syntax</b>             | <code>rest authentication token algorithm[<i>HS256</i>   <i>RS256</i>   <i>ES256</i>]</code>                                          |
| <b>Parameters</b>         | <code>hs256</code> , <code>rs256</code> , <code>es256</code> — Enter the algorithm standard to be used to sign the tokens.            |
| <b>Default</b>            | RS256                                                                                                                                 |
| <b>Command Mode</b>       | CONFIGURATION                                                                                                                         |
| <b>Usage Information</b>  | This command updates the token signing algorithm. The <code>no</code> version of the command resets to the default value.             |
| <b>Example</b>            | <pre>OS10(config)# rest authentication token algorithm es256</pre> <pre>OS10(config)# rest authentication token algorithm rs256</pre> |
| <b>Supported Releases</b> | 10.4.1.0 or later                                                                                                                     |

## RESTCONF API tasks

Using the RESTCONF API, you can provision OS10 switches using HTTPS requests. The examples in this section show how to access the OS10 RESTCONF API using `curl` commands. `curl` is a Linux shell command that generates HTTPS requests and is executed on an external server.



### curl Commands

`curl` command options include:

- `-X` specifies the HTTPS request type; for example, `POST`, `PATCH`, or `GET`.
- `-u` specifies the user name and password to use for server authentication.
- `-k` specifies a text file to read `curl` arguments from. The command line arguments found in the text file will be used as if they were provided on the command line. Use the IP address or URL of the OS10 switch when you access the OS10 RESTCONF API from a remote orchestration system.
- `-H` specifies an extra header to include in the request when sending HTTPS to a server. You can enter multiple extra headers.
- `-d` sends the specified data in an HTTPS request.

In `curl` commands, use `%2F` to represent a backslash (`/`); for example, enter `ethernet1/2/3` as `ethernet1%2F1%2F3`.

For more information, see the [curl Man page](#).

## Usage Information

Consider the following when accessing OS10 RESTCONF API using `curl` commands:

- Dell EMC recommends using a specific URI of the target resource for GET queries in a scaled system. For example, `curl -X GET -k -u admin:admin -H "accept:application/json" https://$TARGET/restconf/data/interfaces/interface/port-channel10`

OS10 does not support REST queries on the root resource of the RESTCONF datastore. For example, the GET query, `curl -X GET -k -u admin:admin https://$TARGET/restconf/data` returns an error.

- When a RESTCONF query is in progress, you cannot configure any CLI commands until a RESTCONF query is complete.
- It is recommended to use POST request instead of PUT, to replace the target data resources.

## View XML structure of CLI commands

To use the RESTCONF API to configure and monitor an OS10 switch, create an HTTPS request with data parameters in JSON format. The JSON data parameters correspond to the same parameters in the XML structure of an OS10 command.

To display the parameter values in the XML code of an OS10 command as reference, use the `debug cli netconf` command in EXEC mode. In CONFIGURATION mode, use the `do debug cli netconf` command.

This command enables a CLI-to-XML display. At the prompt, enter the OS10 command of the XML request and the reply you need. To exit the CLI-to-XML display, use the `no debug cli netconf` command.

Locate the XML parameters values for the same JSON data arguments. For example, to configure VLAN 20 on an OS10 switch, enter the RESTCONF endpoint and JSON contents in the curl command. Note how the JSON `type` and `name` parameters are displayed in the XML structure of the `interface vlan` command.

- RESTCONF endpoint: `/restconf/data/interfaces`
- JSON data content:

```
{
 "interface": [{
 "type": "iana-if-type:l2vlan",
 "enabled": true,
 "description": "vlan20",
 "name": "vlan20"
 }]
}
```

- curl command:

```
curl -X POST -u admin:admin -k "https://10.11.86.113/restconf/data/interfaces"
-H "accept: application/json" -H "Content-Type: application/json"
-d '{"interface": [{"type": "iana-if-type:l2vlan", "enabled": true,
"description":"vlan20", "name":"vlan20"}]}'
```

To display values for the `type` and `name` parameters in the curl command, display the XML structure of the `interface vlan 20` configuration command:

```
OS10(config)# do debug cli netconf
OS10(config)# interface vlan 10

Request:
<?xml version="1.0" encoding="UTF-8"?>
<rpc xmlns="urn:ietf:params:xml:ns:netconf:base:1.0">
 <edit-config>
 <target>
 <candidate/>
 </target>
 <default-operation>merge</default-operation>
 <error-option>stop-on-error</error-option>
 <test-option>set</test-option>
 <config>
 <interfaces xmlns="urn:ietf:params:xml:ns:yang:ietf-interfaces"
xmlns:ianaift="urn:ietf:params:xml:ns:yang:iana-if-type" xmlns:dell-if="http://
www.dellemc.com/networking/os10/dell-interface" xmlns:dell-eth="http://www.dellemc.com/
networking/os10/dell-ethernet" xmlns:dell-lag="http://www.dellemc.com/networking/os10/
dell-lag">
 <interface>
 <type>ianaift:l2vlan</type>
 <name>vlan10</name>
 </interface>
 </interfaces>
 </config>
 </edit-config>
</rpc>
```

```
Reply:
<?xml version="1.0" encoding="UTF-8"?>
<rpc-reply xmlns="urn:ietf:params:xml:ns:netconf:base:1.0" message-id="10">
 <ok/>
</rpc-reply>
OS10(config)# do no debug cli netconf
```

## RESTCONF API Examples

Some common RESTCONF API operations include configuring system hostname, and interfaces such as loopback interface. The examples in this section use `curl` commands to send the HTTPS request.

### System

#### Configure system hostname

**RESTCONF endpoint** `/restconf/data/dell-system:system/hostname`

**JSON content**

```
{
 "hostname": "MyHost"
}
```

**Parameters**

- `hostname string` — Enter the hostname of the system. The default is OS10.

**Example**

```
curl -X PATCH -k -u admin:admin -H "Content-Type: application/json"
https://10.11.86.113/restconf/data/dell-system:system/hostname
-d '{"hostname": "MyHost"}'
```

### Interface

#### Configure a loopback interface

**RESTCONF endpoint** `/restconf/data/interfaces`

**JSON content**

```
{
 "interface": [{
 "type": "iana-if-type:softwareLoopback",
 "enabled": true,
 "description": "loopback interface",
 "name": "loopback1"}]
}
```

**Parameters**

- `type string` — Enter `iana-if-type:softwareLoopback` for a loopback interface.
- `enabled bool` — Enter `true` to enable the interface; enter `false` to disable.
- `description string` — Enter a text string to describe the interface. A maximum of 80 alphanumeric characters.
- `name string` — Enter `loopback loopback-id` of the interface, `loopback-id` is from 0 to 16383.

**Example**

```
curl -X POST -k -u admin:admin "https://10.11.86.113/restconf/data/
interfaces"
-H "accept: application/json" -H "Content-Type: application/json"
-d '{"interface": [{"type": "iana-if-type:softwareLoopback", "enabled":
```

```
true,
"description":"loopback interface", "name":"loopback1"]}]}'
```

### Configure a loopback interface IP address

**RESTCONF endpoint** /restconf/data/interfaces/interface/loopback1

**JSON content**

```
{
 "dell-ip:ipv4":{
 "address": {
 "primary-addr":"6.6.6.6/24"
 }
 }
}
```

**Parameters**

- `primary-addr` *ip-address/prefix-length* — Enter the loopback IP address in dotted-decimal A.B.C.D/x format.

**Example**

```
curl -X POST -k -u admin:admin "https://10.11.86.113/restconf/data/
interfaces/interface/loopback1"
-H "accept: application/json" -H "Content-Type: application/json"
-d '{"dell-ip:ipv4":{"address": {"primary-addr":"6.6.6.6/24"}}}'
```



# Troubleshoot Dell EMC SmartFabric OS10

Critical workloads and applications require constant availability. Dell EMC Networking offers tools to help you monitor and troubleshoot problems before they happen.

<b>Packet and flow capture</b>	Manages packet and traffic
<b>Metrics measurement</b>	Pings, round-trip times, jitter, response times, and so on
<b>Analysis and reporting</b>	Metrics and packet capturing
<b>Alerting</b>	Triggers problem reporting
<b>Logging</b>	Captures system history
<b>Performance monitoring</b>	Establishes baselines and defines triggers for detecting performance problems
<b>Mapping and representation</b>	Defines device locations and status

Dell EMC recommends the following best practices:

- View traffic end-to-end from the application's view point.
- Deploy network management infrastructure rapidly, where needed, when needed, and on-demand.
- Extend analysis beyond the network and watch traffic to and from your host.
- Focus on real-time assessment and use trend analysis to backup your conclusions.
- Emphasize *effective* over *absolute* — leverage management solutions that resolve your most common, most expensive problem quickly.
- Address networking performance issues before you focus on the application performance.
- Use methodologies and technologies that fit your network and needs.
- Continuously monitor performance and availability as a baseline for system performance and system up time to quickly separate network issues from application issues.

## Diagnostic tools

This section contains information about advanced software and hardware commands to debug, monitor, and troubleshoot network devices.

**NOTE:** Output examples are for reference purposes only and may not apply to your specific system.

### View inventory

Use the `show inventory` command to view the module IDs of the device.

```
OS10# show inventory
Product : S4148F-ON
Description : S4148F-ON 48x10GbE, 2x40GbE QSFP+, 4x100GbE QSFP28 Interface
Module
Software version : 10.5.1.0
Product Base :
Product Serial Number :
Product Part Number :

Unit Type Part Number Rev Piece Part ID Svc Tag Exprs
Svc Code

```

```
* 1 S4148F-ON 09H9MN X01 TW-09H9MN-28298-713-0026 9531XC2 198
985 006 10
1 S4148F-ON-PWR-1-AC 06FKHH A00 CN-06FKHH-28298-6B5-03NY
1 S4148F-ON-FANTRAY-1 0N7MH8 X01 TW-0N7MH8-28298-713-0101
1 S4148F-ON-FANTRAY-2 0N7MH8 X01 TW-0N7MH8-28298-713-0102
1 S4148F-ON-FANTRAY-3 0N7MH8 X01 TW-0N7MH8-28298-713-0103
1 S4148F-ON-FANTRAY-4 0N7MH8 X01 TW-0N7MH8-28298-713-0104
```

## Boot information

Display system boot and image information.

- View all boot information in EXEC mode.

```
show boot
```

- View boot details in EXEC mode.

```
show boot detail
```

### View boot information

```
OS10# show boot
Current system image information:
=====
Type Boot Type Active Standby Next-Boot

Node-id 1 Flash Boot [A] 10.5.0.4 [B] 10.5.1.0 [B] standby ---
```

### View boot detail

```
OS10# show boot detail
Current system image information detail:
=====
Type: Node-id 1
Boot Type: Flash Boot
Active Partition: A
Active SW Version: 10.5.0.4
Active SW Build Version: 10.5.0.4.650
Active Kernel Version: Linux 4.9.189
Active Build Date/Time: 2020-02-11T11:13:08Z
Standby Partition: B
Standby SW Version: 10.5.1.0
Standby SW Build Version: 10.5.1.0.123
Standby Build Date/Time: 2020-02-12T02:34:02Z
Next-Boot: standby[B]
```

## Monitor processes

Display CPU process information.

- View process CPU utilization information in EXEC mode.

```
show processes node-id node-id-number [pid process-id]
```

### View CPU utilization

```
OS10# show processes node-id 1
top - 09:19:32 up 5 days, 6 min, 2 users, load average: 0.45, 0.39, 0.34
Tasks: 208 total, 2 running, 204 sleeping, 0 stopped, 2 zombie
%Cpu(s): 9.7 us, 3.9 sy, 0.3 ni, 85.8 id, 0.0 wa, 0.0 hi, 0.3 si, 0.0 st
KiB Mem: 3998588 total, 2089416 used, 1909172 free, 143772 buffers
KiB Swap: 399856 total, 0 used, 399856 free. 483276 cached Mem
 PID USER PR NI VIRT RES SHR S %CPU %MEM TIME+ COMMAND
 9 root 20 0 0 0 0 S 6.1 0.0 5:22.41 rcuos/1
 819 snmp 20 0 52736 6696 4132 S 6.1 0.2 2:44.18 snmpd
```

```

30452 admin 20 0 22076 2524 2100 R 6.1 0.1 0:00.02 top
 1 root 20 0 112100 5840 3032 S 0.0 0.1 0:12.32 systemd
 2 root 20 0 0 0 0 S 0.0 0.0 0:00.00 kthreadd
 3 root 20 0 0 0 0 S 0.0 0.0 0:25.37 ksoftirqd/0
 5 root 0 -20 0 0 0 S 0.0 0.0 0:00.00 kworker/0:+
 7 root 20 0 0 0 0 R 0.0 0.0 5:15.27 rcu_sched
 8 root 20 0 0 0 0 S 0.0 0.0 2:43.64 rcuos/0
 10 root 20 0 0 0 0 S 0.0 0.0 0:00.00 rcu_bh
 11 root 20 0 0 0 0 S 0.0 0.0 0:00.00 rcuob/0
 12 root 20 0 0 0 0 S 0.0 0.0 0:00.00 rcuob/1
 13 root rt 0 0 0 0 S 0.0 0.0 0:07.30 migration/0
 14 root rt 0 0 0 0 S 0.0 0.0 0:02.18 watchdog/0
 15 root rt 0 0 0 0 S 0.0 0.0 0:02.12 watchdog/1
 16 root rt 0 0 0 0 S 0.0 0.0 0:04.98 migration/1
 17 root 20 0 0 0 0 S 0.0 0.0 0:03.92 ksoftirqd/1
 19 root 0 -20 0 0 0 S 0.0 0.0 0:00.00 kworker/1:+
 20 root 0 -20 0 0 0 S 0.0 0.0 0:00.00 khelper
 21 root 20 0 0 0 0 S 0.0 0.0 0:00.00 kdevtmpfs
 22 root 0 -20 0 0 0 S 0.0 0.0 0:00.00 netns
 23 root 20 0 0 0 0 S 0.0 0.0 0:00.41 khungtaskd
 24 root 0 -20 0 0 0 S 0.0 0.0 0:00.00 writeback
 25 root 25 5 0 0 0 S 0.0 0.0 0:00.00 ksmd
--more--

```

```

OS10# show processes node-id 1 pid 1019
top - 09:21:58 up 5 days, 8 min, 2 users, load average: 0.18, 0.30, 0.31
Tasks: 1 total, 0 running, 1 sleeping, 0 stopped, 0 zombie
%Cpu(s): 9.7 us, 3.9 sy, 0.3 ni, 85.8 id, 0.0 wa, 0.0 hi, 0.3 si, 0.0 st
KiB Mem: 3998588 total, 2089040 used, 1909548 free, 143772 buffers
KiB Swap: 399856 total, 0 used, 399856 free. 483276 cached Mem
 PID USER PR NI VIRT RES SHR S %CPU %MEM TIME+ COMMAND
 1019 root 20 0 1829416 256080 73508 S 6.6 6.4 1212:36 base_nas
OS10#

```

## LED settings

Beacon LEDs identify the location of ports and system status with blinking or solid LEDs.

 **NOTE:** This feature is not supported on the Z9332F-ON platform.

Change current state of the location LED of the system or interface using the following commands:

```
location-led system {node-id | node-id/unit-id} {on | off}
```

```
location-led interface ethernet {chassis/slot/port[:subport]} {on | off}
```

### Change the state of system location LED

```
OS10# location-led system 1 on
OS10# location-led system 1 off
```

### Change the state of interface location LED

```
OS10# location-led interface ethernet 1/1/1 on
OS10# location-led interface ethernet 1/1/1 off
```

## Packet analysis

Use the Linux `tcpdump` command to analyze network packets. Use filters to limit packet collection and output. You must be logged into the Linux shell to use this command. For more information, see [Log into OS10 Device](#).

Use the Linux `tcpdump` command without parameters to view packets that flow through all interfaces. To write captured packets to a file, use the `-w` parameter. To read the captured file output offline, you can use open source software packages such as Wireshark.

## Capture packets from Ethernet interface

```
$ tcpdump -i e101-003-0
tcpdump: verbose output suppressed, use -v or -vv for full protocol decode
listening on e101-003-0, link-type EN10MB (Ethernet), capture size 262144 bytes
01:39:22.457185 IP 3.3.3.1 > 3.3.3.4: ICMP echo request, id 5320, seq 26, length 64
01:39:22.457281 IP 3.3.3.1 > 3.3.3.4: ICMP echo reply, id 5320, seq 26, length 64
```

## Capture two packets from interface

```
$ tcpdump -c 2 -i e101-003-0
listening on e101-003-0, link-type EN10MB (Ethernet), capture size 96 bytes
01:39:22.457185 IP 3.3.3.1 > 3.3.3.4: ICMP echo request, id 5320, seq 26, length 64
01:39:22.457281 IP 3.3.3.1 > 3.3.3.4: ICMP echo reply, id 5320, seq 26, length 64
2 packets captured
13 packets received by filter
0 packets dropped by kernel
```

## Capture packets and write to file

```
$ tcpdump -w 06102016.pcap -i e101-003-0
listening on e101-003-0, link-type EN10MB (Ethernet), capture size 96 bytes
32 packets captured
32 packets received by filter
0 packets dropped by kernel
```

# Port adapters and modules

Use the `show diag` command to view diagnostics information for OS10 port adapters and hardware modules.

## View diagnostic hardware information

```
OS10# show diag
00:00.0 Host bridge: Intel Corporation Atom Processor S1200 Internal (rev 02)
00:01.0 PCI bridge: Intel Corporation Atom Processor S1200 PCI Express Root Port 1 (rev 02)
00:02.0 PCI bridge: Intel Corporation Atom Processor S1200 PCI Express Root Port 2 (rev 02)
00:03.0 PCI bridge: Intel Corporation Atom Processor S1200 PCI Express Root Port 3 (rev 02)
00:04.0 PCI bridge: Intel Corporation Atom Processor S1200 PCI Express Root Port 4 (rev 02)
00:0e.0 IOMMU: Intel Corporation Atom Processor S1200 Internal (rev 02)
00:13.0 System peripheral: Intel Corporation Atom Processor S1200 SMBus 2.0 Controller 0 (rev 02)
00:13.1 System peripheral: Intel Corporation Atom Processor S1200 SMBus 2.0 Controller 1 (rev 02)
00:14.0 Serial controller: Intel Corporation Atom Processor S1200 UART (rev 02)
00:1f.0 ISA bridge: Intel Corporation Atom Processor S1200 Integrated Legacy Bus (rev 02)
01:00.0 Ethernet controller: Broadcom Corporation Device b850 (rev 03)
02:00.0 SATA controller: Marvell Technology Group Ltd. Device 9170 (rev 12)
03:00.0 PCI bridge: Pericom Semiconductor PI7C9X442SL PCI Express Bridge Port (rev 02)
04:01.0 PCI bridge: Pericom Semiconductor PI7C9X442SL PCI Express Bridge Port (rev 02)
04:02.0 PCI bridge: Pericom Semiconductor PI7C9X442SL PCI Express Bridge Port (rev 02)
04:03.0 PCI bridge: Pericom Semiconductor PI7C9X442SL PCI Express Bridge Port (rev 02)
07:00.0 USB controller: Pericom Semiconductor PI7C9X442SL USB OHCI Controller (rev 01)
07:00.1 USB controller: Pericom Semiconductor PI7C9X442SL USB OHCI Controller (rev 01)
07:00.2 USB controller: Pericom Semiconductor PI7C9X442SL USB EHCI Controller (rev 01)
08:00.0 Ethernet controller: Intel Corporation 82574L Gigabit Network Connection
```

# Test network connectivity

Use the `ping` and `tracert` commands to test network connectivity. When you ping an IP address, you send packets to a destination and wait for a response. If there is no response, the destination is not active. The `ping` command is useful during configuration if you have problems connecting to a hostname or IP address.

When you execute a *traceroute*, the output shows the path a packet takes from your device to the destination IP address. It also lists all intermediate hops (routers) that the packet traverses to reach its destination, including the total number of hops traversed.

### Check IPv4 connectivity

```
OS10# ping 172.31.1.255

Type Ctrl-C to abort.

Sending 5, 100-byte ICMP Echos to 172.31.1.255, timeout is 2 seconds:
Reply to request 1 from 172.31.1.208 0 ms
Reply to request 1 from 172.31.1.216 0 ms
Reply to request 1 from 172.31.1.205 16 ms
::
Reply to request 5 from 172.31.1.209 0 ms
Reply to request 5 from 172.31.1.66 0 ms
Reply to request 5 from 172.31.1.87 0 ms
```

### Check IPv6 connectivity

```
OS10# ping6 20::1
PING 20::1(20::1) 56 data bytes
64 bytes from 20::1: icmp_seq=1 ttl=64 time=2.07 ms
64 bytes from 20::1: icmp_seq=2 ttl=64 time=2.21 ms
64 bytes from 20::1: icmp_seq=3 ttl=64 time=2.37 ms
64 bytes from 20::1: icmp_seq=4 ttl=64 time=2.10 ms
^C
--- 20::1 ping statistics ---
4 packets transmitted, 4 received, 0% packet loss, time 3005ms
rtt min/avg/max/mdev = 2.078/2.194/2.379/0.127 ms
```

### Trace IPv4 network route

```
OS10# traceroute www.Dell Networking.com

Translating "www.Dell Networking.com"...domain server (10.11.0.1) [OK]
Type Ctrl-C to abort.

Tracing the route to www.Dell Networking.com (10.11.84.18),
30 hops max, 40 byte packets

TTL Hostname Probel Probe2 Probe3
 1 10.11.199.190 001.000 ms 001.000 ms 002.000 ms
 2 gwegress-sjc-02.Dell Networking.com (10.11.30.126) 005.000 ms 001.000 ms 001.000 ms
 3 fw-sjc-01.Dell Networking.com (10.11.127.254) 000.000 ms 000.000 ms 000.000 ms
 4 www.Dell Networking.com (10.11.84.18) 000.000 ms 000.000 ms 000.000 ms
```

### Trace IPv6 network route

```
OS10# traceroute 100::1

Type Ctrl-C to abort.

Tracing the route to 100::1, 64 hops max, 60 byte packets

Hops Hostname Probel Probe2 Probe3
 1 100::1 000.000 ms 000.000 ms 000.000 ms

OS10# traceroute 3ffe:501:ffff:100:201:e8ff:fe00:4c8b

Type Ctrl-C to abort.

Tracing the route to 3ffe:501:ffff:100:201:e8ff:fe00:4c8b,
64 hops max, 60 byte packets

Hops Hostname Probel Probe2 Probe3
```

```
1 3ffe:501:ffff:100:201:e8ff:fe00:4c8b
 000.000 ms 000.000 ms 000.000 ms
```

## View solution ID

Dell EMC networking switches that are part of a larger solution require a solution identifier (ID).

To view the solution ID including the product base, product serial number, and product part number, use the following show commands:

### View inventory

```
OS10# show inventory
Product : S6000-ON
Description : S6000-ON 32x40GbE QSFP+ Interface Module
Software version : 10.4.9999EX
Product Base : ECS Gen3
Product Serial Number : APM001123456789
Product Part Number : 900-590-001

Unit Type Part Number Rev Piece Part ID Svc Tag Exprs Svc Code

* 1 S4248FB-ON CN-0W1K08-77931-647-0017 OS11SIM 539 375 922 22
 1 S4248FB-ON-PWR-2-AC 02RPHX A00 CN-02RPHX-17972-5BH-00RE
 1 S4248FB-ON-FANTRAY-1 03CH15 A00 CN-03CH15-77931-62T-0039
 1 S4248FB-ON-FANTRAY-2 03CH15 A00 CN-03CH15-77931-62T-0133
 1 S4248FB-ON-FANTRAY-3 03CH15 A00 CN-03CH15-77931-62T-0067
 1 S4248FB-ON-FANTRAY-4 03CH15 A00 CN-03CH15-77931-62T-0034
 1 S4248FB-ON-FANTRAY-5 03CH15 A00 CN-03CH15-77931-62T-0041
```

### View license status

```
OS10# show license status
System Information

Vendor Name : Dell EMC
Product Name : S6000-VM
Hardware Version:
Platform Name : x86_64-dell_s6000_vm
PPID : VM0S6000000674000ABCD
Service Tag : OS11SIM
Product Base : ECS Gen3
Product Serial Number : APM001123
Product Part Number : 900-590-0
```

### View tech-support details

```
OS10# show tech-support
-----show inventory-----
Product : S6000-ON
Description : S6000-ON 32x40GbE QSFP+ Interface Module
```

```

Software version : 10.4.9999EX
Product Base : ECS Gen3
Product Serial Number : APM001123456789
Product Part Number : 900-590-001

```

-----  
<<Output Truncated>>

## View diagnostics

View system diagnostic information using show commands. Use the `show hash-algorithm` command to view the current hash algorithms configured for the Link Aggregation Group (LAG) and Equal Cost MultiPath (ECMP) protocols.

### View environment

```
OS10# show environment
```

Unit	State	Temperature
1	up	43

Thermal sensors

Unit	Sensor-Id	Sensor-name	Temperature
1	1	CPU On-Board temp sensor	32
1	2	Switch board temp sensor	28
1	3	System Inlet Ambient-1 temp sensor	27
1	4	System Inlet Ambient-2 temp sensor	25
1	5	System Inlet Ambient-3 temp sensor	26
1	6	Switch board 2 temp sensor	31
1	7	Switch board 3 temp sensor	41
1	8	NPU temp sensor	43

### View hash algorithm

```
OS10# show hash-algorithm
LagAlgo - CRC EcmpAlgo - CRC
```

### View inventory

```
OS10# show inventory
```

```

Product : S4148F-ON
Description : S4148F-ON 48x10GbE, 2x40GbE QSFP+, 4x100GbE QSFP28 Interface
Module
Software version : 10.5.1.0
Product Base :
Product Serial Number :
Product Part Number :

```

Unit	Type	Part Number	Rev	Piece Part ID	Svc Tag	Exprs
* 1	S4148F-ON	09H9MN	X01	TW-09H9MN-28298-713-0026	9531XC2	198
985	006 10					
1	S4148F-ON-PWR-1-AC	06FKHH	A00	CN-06FKHH-28298-6B5-03NY		
1	S4148F-ON-FANTRAY-1	0N7MH8	X01	TW-0N7MH8-28298-713-0101		
1	S4148F-ON-FANTRAY-2	0N7MH8	X01	TW-0N7MH8-28298-713-0102		
1	S4148F-ON-FANTRAY-3	0N7MH8	X01	TW-0N7MH8-28298-713-0103		
1	S4148F-ON-FANTRAY-4	0N7MH8	X01	TW-0N7MH8-28298-713-0104		

### View system information

```
OS10# show system
```

```

Node Id : 1
MAC : 14:18:77:15:c3:e8
Number of MACs : 256
Up Time : 1 day 00:48:58

-- Unit 1 --
Status : up
System Identifier : 1
Down Reason : unknown
Digital Optical Monitoring : disable
System Location LED : off
Required Type : S4148F
Current Type : S4148F
Hardware Revision : X01
Software Version : 10.5.1.0
Physical Ports : 48x10GbE, 2x40GbE, 4x100GbE
BIOS : 3.33.0.0-3
System CPLD : 0.4
Master CPLD : 0.10
Slave CPLD : 0.7

-- Power Supplies --
PSU-ID Status Type AirFlow Fan Speed(rpm) Status

1 up AC NORMAL 1 13312 up
2 fail

-- Fan Status --
FanTray Status AirFlow Fan Speed(rpm) Status

1 up NORMAL 1 13195 up
2 up NORMAL 1 13151 up
3 up NORMAL 1 13239 up
4 up NORMAL 1 13239 up

```

## Diagnostic commands

### location-led interface

Changes the location LED of the interface.

**Syntax** `location-led interface ethernet {chassis/slot/port[:subport]} {on | off}`

**Parameters**

- `chassis/slot/port[:subport]` — Enter the ethernet interface number.
- `on | off` — Set the interface LED to be on or off.

**Default** Not configured

**Command Mode** EXEC

**Usage Information** Use this command to change the location LED for the specified interface.

**Example**

```

OS10# location-led interface ethernet 1/1/1 on
OS10# location-led interface ethernet 1/1/1 off

```

**Supported Releases** 10.3.0E or later



## location-led system

Changes the location LED of the system.

**Syntax** `location-led system {node-id | node-id/unit-id} {on | off}`

- Parameters**
- `node-id | node-id/unit-id` — Enter the system ID.
  - `on | off` — Set the system LED to be on or off.

**Default** Not configured

**Command Mode** EXEC

**Usage Information** Use this command to change the location LED for the specified system ID.

**Example**

```
OS10# location-led system 1 on
OS10# location-led system 1 off
```

**Supported Releases** 10.3.0E or later

## show boot

Displays boot-related information.

**Syntax** `show boot [detail]`

**Parameters** `detail` — (Optional) Enter to display detailed information.

**Default** Not configured

**Command Mode** EXEC

**Usage Information** Use the `boot system` command to set the boot image for the next reboot.

**Example**

```
OS10# show boot
Current system image information:
=====
Type Boot Type Active Standby Next-Boot

Node-id 1 Flash Boot [A] 10.5.0.4 [B] 10.5.1.0 [B] standby
```

**Example (Detail)**

```
OS10# show boot detail
Current system image information detail:
=====
Type: Node-id 1
Boot Type: Flash Boot
Active Partition: A
Active SW Version: 10.5.0.4
Active SW Build Version: 10.5.0.4.650
Active Kernel Version: Linux 4.9.189
Active Build Date/Time: 2020-02-11T11:13:08Z
Standby Partition: B
Standby SW Version: 10.5.1.0
Standby SW Build Version: 10.5.1.0.123
Standby Build Date/Time: 2020-02-12T02:34:02Z
Next-Boot: standby[B]
```

**Supported Releases** 10.2.0E or later

## show diag

Displays diagnostic information for port adapters and modules.

<b>Syntax</b>	show diag
<b>Parameters</b>	None
<b>Default</b>	Not configured
<b>Command Mode</b>	EXEC
<b>Usage Information</b>	None

### Example

```
OS10# show diag
00:00.0 Host bridge: Intel Corporation Atom processor C2000 SoC
Transaction Router (rev 02)
00:01.0 PCI bridge: Intel Corporation Atom processor C2000 PCIe Root
Port 1 (rev 02)
00:02.0 PCI bridge: Intel Corporation Atom processor C2000 PCIe Root
Port 2 (rev 02)
00:03.0 PCI bridge: Intel Corporation Atom processor C2000 PCIe Root
Port 3 (rev 02)
00:04.0 PCI bridge: Intel Corporation Atom processor C2000 PCIe Root
Port 4 (rev 02)
00:0e.0 Host bridge: Intel Corporation Atom processor C2000 RAS (rev 02)
00:0f.0 IOMMU: Intel Corporation Atom processor C2000 RCEC (rev 02)
00:13.0 System peripheral: Intel Corporation Atom processor C2000 SMBus
2.0 (rev 02)
00:14.0 Ethernet controller: Intel Corporation Ethernet Connection I354
(rev 03)
00:14.1 Ethernet controller: Intel Corporation Ethernet Connection I354
(rev 03)
00:16.0 USB controller: Intel Corporation Atom processor C2000 USB
Enhanced Host Controller (rev 02)
00:17.0 SATA controller: Intel Corporation Atom processor C2000 AHCI
SATA2 Controller (rev 02)
00:18.0 SATA controller: Intel Corporation Atom processor C2000 AHCI
SATA3 Controller (rev 02)
00:1f.0 ISA bridge: Intel Corporation Atom processor C2000 PCU (rev 02)
00:1f.3 SMBus: Intel Corporation Atom processor C2000 PCU SMBus (rev 02)
01:00.0 Ethernet controller: Broadcom Corporation Device b340 (rev 01)
01:00.1 Ethernet controller: Broadcom Corporation Device b340 (rev 01)
```

<b>Supported Releases</b>	10.2.0E or later
---------------------------	------------------

## show environment

Displays information about environmental system components, such as temperature, fan, and voltage.

<b>Syntax</b>	show environment
<b>Parameters</b>	None
<b>Default</b>	Not configured
<b>Command Mode</b>	EXEC
<b>Usage Information</b>	None

### Example

```
OS10# show environment

Unit State Temperature

1 up 43
```

Thermal sensors			
Unit	Sensor-Id	Sensor-name	Temperature
1	1	CPU On-Board temp sensor	32
1	2	Switch board temp sensor	28
1	3	System Inlet Ambient-1 temp sensor	27
1	4	System Inlet Ambient-2 temp sensor	25
1	5	System Inlet Ambient-3 temp sensor	26
1	6	Switch board 2 temp sensor	31
1	7	Switch board 3 temp sensor	41
1	8	NPU temp sensor	43

**Supported Releases** 10.2.0E or later

## show hash-algorithm

Displays hash algorithm information.

**Syntax** show hash-algorithm

**Parameters** None

**Default** Not configured

**Command Mode** EXEC

**Usage Information** None

**Example**

```
OS10# show hash-algorithm
LagAlgo - CRC EcmpAlgo - CRC
```

**Supported Releases** 10.2.0E or later

## show inventory

Displays system inventory information.

**Syntax** show inventory

**Parameters** None

**Default** Not configured

**Command Mode** EXEC

**Usage Information** None

**Example**

```
OS10# show inventory
Product : S4148F-ON
Description : S4148F-ON 48x10GbE, 2x40GbE QSFP+, 4x100GbE QSFP28 Interfa
Software version : 10.5.1.0
Product Base :
Product Serial Number :
Product Part Number :
```

Unit	Type	Part Number	Rev	Piece Part ID	Svc Tag	
*	1	S4148F-ON	09H9MN	X01	TW-09H9MN-28298-713-0026	9531XC2
	1	S4148F-ON-PWR-1-AC	06FKHH	A00	CN-06FKHH-28298-6B5-03NY	
	1	S4148F-ON-FANTRAY-1	0N7MH8	X01	TW-0N7MH8-28298-713-0101	
	1	S4148F-ON-FANTRAY-2	0N7MH8	X01	TW-0N7MH8-28298-713-0102	

1	S4148F-ON-FANTRAY-3	0N7MH8	X01	TW-0N7MH8-28298-713-0103
1	S4148F-ON-FANTRAY-4	0N7MH8	X01	TW-0N7MH8-28298-713-0104

**Supported Releases** 10.2.0E or later

## show processes

View process CPU utilization information.

**Syntax** `show processes node-id node-id-number [pid process-id]`

- Parameters**
- `node-id-number` — Enter the Node ID number as 1.
  - `process-id` — (Optional) Enter the process ID number, from 1 to 2147483647.

**Default** Not configured

**Command Mode** EXEC

**Usage Information** None

### Example

```
OS10# show processes node-id 1
top - 09:19:32 up 5 days, 6 min, 2 users, load average: 0.45, 0.39,
0.34
Tasks: 208 total, 2 running, 204 sleeping, 0 stopped, 2 zombie
%Cpu(s): 9.7 us, 3.9 sy, 0.3 ni, 85.8 id, 0.0 wa, 0.0 hi, 0.3 si,
0.0 st
KiB Mem: 3998588 total, 2089416 used, 1909172 free, 143772 buffers
KiB Swap: 399856 total, 0 used, 399856 free. 483276 cached
Mem
 PID USER PR NI VIRT RES SHR S %CPU %MEM TIME+
COMMAND
 9 root 20 0 0 0 0 S 6.1 0.0 5:22.41
rcuos/1
 819 snmp 20 0 52736 6696 4132 S 6.1 0.2 2:44.18 snmpd
30452 admin 20 0 22076 2524 2100 R 6.1 0.1 0:00.02 top
 1 root 20 0 112100 5840 3032 S 0.0 0.1 0:12.32
systemd
 2 root 20 0 0 0 0 S 0.0 0.0 0:00.00
kthreadd
 3 root 20 0 0 0 0 S 0.0 0.0 0:25.37
ksoftirqd/0
 5 root 0 -20 0 0 0 S 0.0 0.0 0:00.00
kworker/0:+
 7 root 20 0 0 0 0 R 0.0 0.0 5:15.27
rcu_sched
 8 root 20 0 0 0 0 S 0.0 0.0 2:43.64
rcuos/0
 10 root 20 0 0 0 0 S 0.0 0.0 0:00.00
rcu_bh
 11 root 20 0 0 0 0 S 0.0 0.0 0:00.00
rcuob/0
 12 root 20 0 0 0 0 S 0.0 0.0 0:00.00
rcuob/1
 13 root rt 0 0 0 0 S 0.0 0.0 0:07.30
migration/0
 14 root rt 0 0 0 0 S 0.0 0.0 0:02.18
watchdog/0
 15 root rt 0 0 0 0 S 0.0 0.0 0:02.12
watchdog/1
 16 root rt 0 0 0 0 S 0.0 0.0 0:04.98
migration/1
 17 root 20 0 0 0 0 S 0.0 0.0 0:03.92
ksoftirqd/1
 19 root 0 -20 0 0 0 S 0.0 0.0 0:00.00
kworker/1:+
 20 root 0 -20 0 0 0 S 0.0 0.0 0:00.00
```

```

khelper
 21 root 20 0 0 0 0 S 0.0 0.0 0:00.00
kdevtmpfs
 22 root 0 -20 0 0 0 S 0.0 0.0 0:00.00 netns
 23 root 20 0 0 0 0 S 0.0 0.0 0:00.41
khungtaskd
 24 root 0 -20 0 0 0 S 0.0 0.0 0:00.00
writeback
 25 root 25 5 0 0 0 S 0.0 0.0 0:00.00 ksmd
--more--

```

```

OS10# show processes node-id 1 pid 1019
top - 09:21:58 up 5 days, 8 min, 2 users, load average: 0.18, 0.30,
0.31
Tasks: 1 total, 0 running, 1 sleeping, 0 stopped, 0 zombie
%Cpu(s): 9.7 us, 3.9 sy, 0.3 ni, 85.8 id, 0.0 wa, 0.0 hi, 0.3 si,
0.0 st
KiB Mem: 3998588 total, 2089040 used, 1909548 free, 143772 buffers
KiB Swap: 399856 total, 0 used, 399856 free. 483276 cached
Mem
 PID USER PR NI VIRT RES SHR S %CPU %MEM TIME+
COMMAND
 1019 root 20 0 1829416 256080 73508 S 6.6 6.4 1212:36
base_nas
OS10#

```

### Supported Releases

10.3.0E or later

## show system

Displays system information.

**Syntax** show system [brief | node-id]

- Parameters**
- **brief** — View an abbreviated list of the system information.
  - **node-id** — View the node ID number.

**Default** Not configured

**Command Mode** EXEC

**Usage Information** None

### Example

```

OS10# show system

Node Id : 1
MAC : 14:18:77:15:c3:e8
Number of MACs : 256
Up Time : 1 day 00:48:58

-- Unit 1 --
Status : up
System Identifier : 1
Down Reason : unknown
Digital Optical Monitoring : disable
System Location LED : off
Required Type : S4148F
Current Type : S4148F
Hardware Revision : X01
Software Version : 10.5.1.0
Physical Ports : 48x10GbE, 2x40GbE, 4x100GbE
BIOS : 3.33.0.0-3
System CPLD : 0.4
Master CPLD : 0.10
Slave CPLD : 0.7

```

```

-- Power Supplies --
PSU-ID Status Type AirFlow Fan Speed(rpm) Status

1 up AC NORMAL 1 13312 up
2 fail

-- Fan Status --
FanTray Status AirFlow Fan Speed(rpm) Status

1 up NORMAL 1 13195 up
2 up NORMAL 1 13151 up
3 up NORMAL 1 13239 up
4 up NORMAL 1 13239 up

```

**Example (node-id)**

```
OS10# show system node-id 1 fanout-configured
```

```

Interface Breakout capable Breakout state

Eth 1/1/5 No BREAKOUT_1x1
Eth 1/1/6 No BREAKOUT_1x1
Eth 1/1/7 No BREAKOUT_1x1
Eth 1/1/8 No BREAKOUT_1x1
Eth 1/1/9 No BREAKOUT_1x1
Eth 1/1/10 No BREAKOUT_1x1
Eth 1/1/11 No BREAKOUT_1x1
Eth 1/1/12 No BREAKOUT_1x1
Eth 1/1/13 No BREAKOUT_1x1
Eth 1/1/14 No BREAKOUT_1x1
Eth 1/1/15 No BREAKOUT_1x1
Eth 1/1/16 No BREAKOUT_1x1
Eth 1/1/17 No BREAKOUT_1x1
Eth 1/1/18 No BREAKOUT_1x1
Eth 1/1/19 No BREAKOUT_1x1
Eth 1/1/20 No BREAKOUT_1x1
Eth 1/1/21 No BREAKOUT_1x1
Eth 1/1/22 No BREAKOUT_1x1
Eth 1/1/23 No BREAKOUT_1x1
Eth 1/1/24 No BREAKOUT_1x1
Eth 1/1/25 Yes BREAKOUT_1x1

```

**Example (brief)**

```
OS10# show system brief
```

```

Node Id : 1
MAC : 14:18:77:15:c3:e8

-- Unit --
Unit Status ReqType CurType Version

1 up S4148F S4148F 10.5.1.0

-- Power Supplies --
PSU-ID Status Type AirFlow Fan Speed(rpm) Status

1 up AC NORMAL 1 13312 up
2 fail

-- Fan Status --
FanTray Status AirFlow Fan Speed(rpm) Status

1 up NORMAL 1 13195 up
2 up NORMAL 1 13151 up

```

3	up	NORMAL	1	13239	up
4	up	NORMAL	1	13239	up

**Supported Releases** 10.2.0E or later

## traceroute

Displays the routes that packets take to travel to an IP address.

**Syntax** `traceroute [vrf {management | vrf-name}] host [-46dFITnreAUDV] [-f first_ttl] [-g gate,...] [-i device] [-m max_ttl] [-N squeries] [-p port] [-t tos] [-l flow_label] [-w waittime] [-q nqueries] [-s src_addr] [-z sendwait] [--fwmark=num] host [packetlen]`

- Parameters**
- `vrf management` — (Optional) Traces the route to an IP address in the management VRF instance.
  - `vrf vrf-name` — (Optional) Traces the route to an IP address in the specified VRF instance.
  - `host` — Enter the host to trace packets from.
  - `-i interface` — (Optional) Enter the IP address of the interface through which traceroute sends packets. By default, the interface is selected according to the routing table.
  - `-m max_ttl` — (Optional) Enter the maximum number of hops for the maximum time-to-live value that traceroute probes. The default is 30.
  - `-p port` — (Optional) Enter a destination port:
    - For UDP tracing, enter the destination port base that traceroute uses. The destination port number is incremented by each probe.
    - For ICMP tracing, enter the initial ICMP sequence value, incremented by each probe.
    - For TCP tracing, enter the constant destination port to connect.
    - `-P protocol` — (Optional) Use a raw packet of the specified protocol for traceroute. The default protocol is 253 (RFC 3692).
    - `-s source_address` — (Optional) Enter an alternative source address of one of the interfaces. By default, the address of the outgoing interface is used.
    - `-q nqueries` — (Optional) Enter the number of probe packets per hop. The default is 3.
    - `-N squeries` — (Optional) Enter the number of probe packets sent out simultaneously to accelerate traceroute. The default is 16.
    - `-t tos` — (Optional) For IPv4, enter the type of service (ToS) and precedence values to use. 16 sets a low delay; 8 sets a high throughput.
    - `-UL` — (Optional) Use UDPLITE for tracerouting. The default port is 53.
    - `-w waittime` — (Optional) Enter the time in seconds to wait for a response to a probe. The default is 5 seconds.
    - `-z sendwait` — (Optional) Enter the minimal time interval to wait between probes. The default is 0. A value greater than 10 specifies a number in milliseconds, otherwise it specifies a number of seconds. This option is useful when routers rate-limit ICMP messages.
    - `--mtu` — (Optional) Discovers the maximum transmission unit (MTU) from the path being traced.
    - `--back` — (Optional) Prints the number of backward hops when different from the forward direction.
    - `host` — (Required) Enter the name or IP address of the destination device.
    - `packet_len` — (Optional) Enter the total size of the probing packet. The default is 60 bytes for IPv4 and 80 for IPv6.

**Default** Not configured

**Command Mode** EXEC

**Usage Information** None

**Example**

```
OS10# traceroute www.dell.com
traceroute to www.dell.com (23.73.112.54), 30 hops max, 60 byte packets
```

```

1 10.11.97.254 (10.11.97.254) 4.298 ms 4.417 ms 4.398 ms
2 10.11.3.254 (10.11.3.254) 2.121 ms 2.326 ms 2.550 ms
3 10.11.27.254 (10.11.27.254) 2.233 ms 2.207 ms 2.391 ms
4 Host65.hbms.com (63.80.56.65) 3.583 ms 3.776 ms 3.757 ms
5 host33.30.198.65 (65.198.30.33) 3.758 ms 4.286 ms 4.221 ms
6 3.GigabitEthernet3-3.GW3.SCL2.ALTER.NET (152.179.99.173) 4.428 ms
 2.593 ms 3.243 ms
7 0.xe-7-0-1.XL3.SJC7.ALTER.NET (152.63.48.254) 3.915 ms 3.603 ms
 3.790 ms
8 TenGigE0-4-0-5.GW6.SJC7.ALTER.NET (152.63.49.254) 11.781 ms 10.600
 ms 9.402 ms
9 23.73.112.54 (23.73.112.54) 3.606 ms 3.542 ms 3.773 ms

```

### Example (IPv6)

```

OS10# traceroute 20::1
traceroute to 20::1 (20::1), 30 hops max, 80 byte packets
1 20::1 (20::1) 2.622 ms 2.649 ms 2.964 ms

```

**Supported Releases** 10.2.0E or later

## Recover Linux password

If you lose or forget your Linux administrator password, you can reconfigure it from the CLI using the `system-user linuxadmin password {clear-text-password | hashed-password}` command in CONFIGURATION mode. Save the password using the `write memory` command. For example:

```

OS10(config)# system-user linuxadmin password Dell@Force10!@
OS10(config)# exit
OS10# write memory

```

For more information, see [Linuxadmin user configuration](#).

If you lose both OS10 user and Linux admin passwords so that you cannot log in to the CLI, you must recover the `linuxadmin` password from GRUB:

1. Connect to the serial console port. The serial settings are 115,200 baud, 8 data bits, and no parity.
2. Reboot or power up the system.
3. Press **ESC** at the Grub prompt to view the boot menu. The OS10-A partition is selected by default.

```

+-----+
| *OS10-A |
| OS10-B |
| ONIE |
+-----+

```

4. Press **e** to open the OS10 GRUB editor.
  - a. Use the arrow keys to navigate to the end of the line that has `set os_debug_args=` and then add `init=/bin/bash`.

```

+-----+
|setparams 'OS10-A' |
| |
| set os_debug_args="init=/bin/bash" |
| select_image A |
| boot_os |
| |
+-----+

```

5. Press **Ctrl + x** to reboot your system. If **Ctrl + x** does not cause the system to reboot, press **Alt + 0**. The system boots to a root shell without a password.



- At the root prompt, enter `usermod -s /bin/bash linuxadmin` to enable the `linuxadmin` user.

```
root@OS10: /# usermod -s /bin/bash linuxadmin
```

- Verify the `linuxadmin` password status by entering the `passwd -S linuxadmin` command.

If the password is locked, `L` is displayed following `linuxadmin` in the command output. Unlock the password by entering the `passwd -u linuxadmin` command.

```
root@OS10:~# passwd -S linuxadmin
linuxadmin L 10/01/2018 0 99999 7 -1

root@OS10:~# passwd -u linuxadmin
passwd: password expiry information changed.
```

- If the OS10 version is 10.5.1.0, then run the following command.

```
root@OS10: /# sed -ibak '31,41s/^/#/g' /opt/dell/os10/
bin/recover_linuxadmin_password.sh
```

- Configure the password by using the `/opt/dell/os10/bin/recover_linuxadmin_password.sh plain-password` command. Enter the `linuxadmin` password in plain text.

```
root@OS10: /# /opt/dell/os10/bin/recover_linuxadmin_password.sh Dell@admin0!@
```

- Enter the `sync` command to save the new password.

```
root@OS10: /# sync
```

- Reboot the system, and then enter your new password.

```
root@OS10: /# reboot -f
Rebooting.[822.327073] sd 0:0:0:0: [sda] Synchronizing SCSI cache

[822.340656] reboot: Restarting system

[822.344339] reboot: machine restart
BIOS (Dell Inc) Boot Selector
S6010-ON (SI) 3.20.0.3 (32-port TE/FG)
```

## Recover OS10 user name password

If you lose or forget an OS10 user name password, including the admin password, you can recover it by following this procedure.

- Connect to the serial console port. The serial settings are 115200 baud, 8 data bits, and no parity.
- Reboot or power up the system.
- Accept the selected, default boot partition: OS10-A or OS10-B.

```
+-----+
| *OS10-A |
| OS10-B |
| ONIE |
+-----+
```

- At the login prompt, enter the `linuxadmin` user name and password. You enter `linuxadmin` mode; for example:

```
s4048t-1 login: linuxadmin
Password:
Last login: Thu May 2 05:03:40 UTC 2019 on ttyS0
Linux s4048t-1 4.9.82 #1 SMP Debian 4.9.82-1+deb9u3 x86_64
```

The programs included with the Debian GNU/Linux system are free software; the exact distribution terms for each program are described in the individual files in `/usr/share/doc/*/copyright`.

```
Debian GNU/Linux comes with ABSOLUTELY NO WARRANTY, to the extent
permitted by applicable law.
```

```

-* Dell EMC Network Operating System (OS10) *-
-*
-* Copyright (c) 1999-2018 by Dell Inc. All Rights Reserved. *-
-*

```

```
This product is protected by U.S. and international copyright and
intellectual property laws. Dell EMC and the Dell EMC logo are
trademarks of Dell Inc. in the United States and/or other
jurisdictions. All other marks and names mentioned herein may be
trademarks of their respective companies.
```

```
linuxadmin@s4048t-1:~$
```

5. At the linuxadmin prompt, enter `sudo -i` and the linuxadmin password to enter root mode.

```
linuxadmin@s4048t-1:~$ sudo -i
[sudo] password for linuxadmin:
root@s4048t-1:~#
```

6. At the root mode prompt, enter the `passwd username` command to recover the password for the specified user name. Enter the new password twice; for example:

```
root@s4048t-1:~# passwd admin
New password:
Retype new password:
passwd: password updated successfully
```

7. Exit and log out from root mode and linuxadmin mode.

```
root@s4048t-1:~# exit
logout
linuxadmin@s4048t-1:~$ exit
logout

Debian GNU/Linux 9 s4048t-1 ttyS0

Dell EMC Networking Operating System (OS10)
```

8. Log in to OS10 using the admin user name and password, and enter CONFIGURATION mode.

```
s4048t-1 login: admin
Password:
Last login: Mon May 6 18:05:58 UTC 2019 on ttyS0
Linux s4048t-1 4.9.82 #1 SMP Debian 4.9.82-1+deb9u3 x86_64

The programs included with the Debian GNU/Linux system are free software;
the exact distribution terms for each program are described in the
individual files in /usr/share/doc/*/copyright.

Debian GNU/Linux comes with ABSOLUTELY NO WARRANTY, to the extent
permitted by applicable law.
```

```

-* Dell EMC Network Operating System (OS10) *-
-*
-* Copyright (c) 1999-2018 by Dell Inc. All Rights Reserved. *-
-*

```

```
This product is protected by U.S. and international copyright and
intellectual property laws. Dell EMC and the Dell EMC logo are
trademarks of Dell Inc. in the United States and/or other
jurisdictions. All other marks and names mentioned herein may be
trademarks of their respective companies.
```

```
s4048t-1# configure terminal
s4048t-1(config)#
```

9. Configure the recovered password for the user name using the `username password role` command in CONFIGURATION mode; for example:

```
s4048t-1(config)# username admin password admin12345 role sysadmin
```

## Restore factory defaults

To restore your system factory defaults, reboot the system to ONIE: Uninstall OS mode.

 **CAUTION: Restoring factory defaults erases any installed operating system and requires a long time to erase storage.**

If it is not possible to restore your factory defaults with the installed OS, reboot the system from the Grub menu and select ONIE: Rescue. ONIE Rescue bypasses the installed operating system and boots the system into ONIE until you reboot the system. After ONIE Rescue completes, the system resets and boots to the ONIE console.

1. Restore the factory defaults on your system from the Grub menu using the `ONIE: Uninstall OS` command. To select which entry is highlighted, use the up and down arrow keys.

```
+-----+
| ONIE: Install OS |
| ONIE: Rescue |
| *ONIE: Uninstall OS |
| ONIE: Update ONIE |
| ONIE: Embed ONIE |
| ONIE: Diag ONIE |
+-----+
```

2. Press **Enter** to activate the console.
3. Return to the default ONIE settings using the `onie-uninstaller` command.

```
ONIE:/ # onie-uninstaller
uninstallerErasing internal mass storage device: /dev/sda4 (32MB)
 Percent complete: 100%
Erase complete.
Deleting partition 4 from /dev/sda
Erasing internal mass storage device: /dev/sda5 (300MB)
 Percent complete: 100%
Erase complete.
Deleting partition 5 from /dev/sda
Erasing internal mass storage device: /dev/sda6 (300MB)
 Percent complete: 100%
Erase complete.
Deleting partition 6 from /dev/sda
Erasing internal mass storage device: /dev/sda7 (12461MB)
 Percent complete: 100%
Erase complete.
Deleting partition 7 from /dev/sda
Installing for i386-pc platform.
Installation finished. No error reported.
Uninstall complete. Rebooting...
ONIE:/ # discover: Rescue mode detected. No discover stopped.
Stopping: dropbear ssh daemon... done.
Stopping: telnetd... done.
Stopping: syslogd... done.
Info: Unmounting kernel filesystems
The system is going down NOW!
Sent SIGTERM to all processes
Sent SIGKILL tosd 4:0:0:0: [sda] Synchronizing SCSI cache
Restarting system.
machine restart
```

# SupportAssist

The SupportAssist feature monitors the devices in your network that run the Dell EMC Networking Operating System. This feature offers an extra layer of service to your IT support capabilities by:

- Identifying issues and helping you resolve them quickly.
- Proactively monitoring the network and minimizing the risk of downtime.

SupportAssist periodically collects information about configuration, inventory, logs, and so on, from the network devices. It sends this information securely to a centralized Dell EMC SupportAssist infrastructure server, referred to as the SupportAssist server in this section. The Dell EMC SupportAssist infrastructure service specifies a structured format to collect the data. If there is a failure, SupportAssist automatically creates a support case. You receive a notification through email about the case details.

SupportAssist communicates with the SupportAssist server through the Internet and uploads troubleshooting information at scheduled intervals.

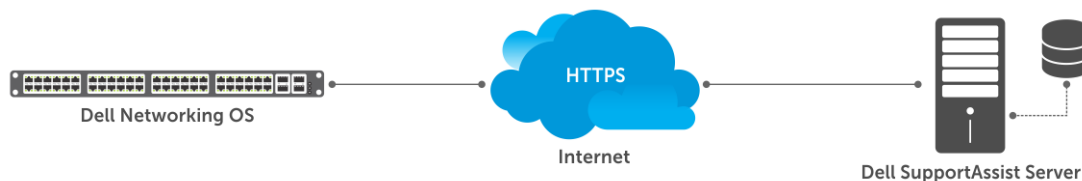

**NOTE:** When you upgrade from an earlier release (prior to Release 10.5.0.0), the switch does not retain the SupportAssist configuration. After the upgrade is complete, enable and configure SupportAssist again. You must reconfigure SupportAssist because the OS10 switch (starting from Release 10.5.0.0) connects to a different Dell EMC server, and you must accept the EULA and reconfigure the server again.

However, reconfiguring SupportAssist is not required if you are using the on-premise gateway (SupportAssist Enterprise or SAE). SAE does not require any SupportAssist configuration on the OS10 switch.

## Important notes

- Dell EMC offers SupportAssist Enterprise for large-scale deployments.
    - SupportAssist Enterprise requires you to deploy a SupportAssist Enterprise gateway server. See the [SupportAssist Enterprise documentation](#) for more information.
    - If you do not want to deploy a SupportAssist Enterprise gateway server, you can configure SupportAssist on the OS10 switch. See the [Configure SupportAssist](#) section for more information.
- Configuring SupportAssist on the OS10 switch requires Internet connectivity to the SupportAssist server. If there is network outage, SupportAssist ignores the information that is collected during the downtime. When Internet connectivity is restored, SupportAssist generates an alert.
- Before you configure SupportAssist, you must accept the SupportAssist End User License Agreement (EULA).
  - If the SupportAssist server is configured using a domain name, ensure that the network device has access to a domain name server (DNS). This release supports only IPv4 addressing.
  - This feature uses `show` commands to collect debug information. The use of `show` commands may impact CPU usage.
  - The system stores the `show` commands output in a .zip file. The size of the .zip file depends on the `show` command output.

## Configure SupportAssist

If the OS10 switch resides behind a firewall, open port 443 on the firewall for an outbound connection to the following SupportAssist servers:

- <https://esrs3.emc.com>
- <https://esrs3-dr.emc.com>

1. Enter the configuration mode.

```
OS10# configure terminal
OS10(config)#
```

2. Accept the EULA.

```
OS10(config)# eula-consent support-assist accept
```

3. Enter SupportAssist mode from CONFIGURATION mode.

```
OS10(config)# support-assist
OS10(conf-support-assist)#
```

4. (Required) Specify the SupportAssist server URL or IP address in SUPPORT-ASSIST mode, and specify your Dell Digital Locker (DDL) credentials to access the SupportAssist server. This account must have entitlements to the OS10 switch in DDL. You can enter `default` to specify the SupportAssist server URL (<https://esrs3.emc.com>).

```
OS10(conf-support-assist)# server url default username example-username password
example-password
```

Or

```
OS10(conf-support-assist)# server url https://domain username example-username
password example-password
```

5. (Required) Configure the interface to connect to the SupportAssist server in SUPPORT-ASSIST mode.

```
OS10(conf-support-assist)# source-interface interface
```

6. (Required) Configure the contact information for your company in SUPPORT-ASSIST mode.

```
OS10(conf-support-assist)# contact-company name ExampleCompanyName
OS10(conf-support-assist-ExampleCompanyName)#
```

7. Trigger an activity immediately or at a scheduled time in EXEC mode.

```
OS10# support-assist-activity full-transfer {start-now | schedule [hourly | daily |
weekly | monthly | yearly]}
```

### Remove SupportAssist schedule

```
OS10# no support-assist-activity full-transfer schedule
```

## Set company name

Configure the name, address, and territory information. Dell EMC Technical Support uses this information to identify which company owns the device.

1. (Required) Configure contact information in SUPPORT-ASSIST mode.

```
OS10(conf-support-assist)# contact-company name example-company-name
```

2. (Required) Configure address information in SUPPORT-ASSIST mode. Use double quotes to add spaces within the city or state name. Use the `no address` command to remove the configuration. Enter `?` to view a list of supported country names and codes. You can also find this information at the following location: [Country names and codes](#).

```
OS10(conf-support-assist-example-company-name)# address city city-name state state-
name country country-code zipcode number
```

3. (Required) Configure street address information in SUPPORT-ASSIST mode. Use double quotes to add spaces within an address. Use the `no street-address` command to remove the configuration.

```
OS10(conf-support-assist-example-company-name)# street-address {address-line-1}
[address-line-2 address-line-3]
```

4. (Optional) Configure the territory in SUPPORT-ASSIST mode. Use the `no territory` command to remove the configuration.

```
OS10(conf-support-assist-example-company-name)# territory company-territory
```

## Configure SupportAssist company

```
OS10(conf-support-assist)# contact-company name ExampleCompanyName
OS10(conf-support-assist-ExampleCompanyName)# address city San Jose state California
country USA zipcode 95125
OS10(conf-support-assist-ExampleCompanyName)# street-address "123 Example Street" "Bldg
999"
OS10(conf-support-assist-ExampleCompanyName)# territory Sales
```

## Set contact information

Configure contact details in SUPPORT-ASSIST mode. You can set the name, email addresses, phone, and preferred contact method.

1. (Required) Enter the contact name in SUPPORT-ASSIST mode.

```
OS10(config)# support-assist
OS10(conf-support-assist)# contact-company name ExampleCompanyName
OS10(conf-support-assist-ExampleCompanyName)# contact-person first firstname last
lastname
```

2. (Required) Enter the email addresses in SUPPORT-ASSIST mode.

```
OS10(conf-support-assist-ExampleCompanyName)# email-address primary email-address
[alternate alternate-email-address]
```

You can optionally configure an alternate email address.

3. (Optional) Enter the preferred contact method in SUPPORT-ASSIST mode.

```
OS10(conf-support-assist-ExampleCompanyName-firstnamelastname)# preferred-method
{email | phone | no-contact}
```

4. (Required) Enter a contact phone number in SUPPORT-ASSIST mode. Minimum length of phone number is nine digits.

```
OS10(conf-support-assist-ExampleCompanyName)# phone primary number [alternate number]
```

You can optionally configure an alternate phone number.

## Configure contact details

```
OS10(config)# support-assist
OS10(conf-support-assist)# contact-company name ExampleCompanyName
OS10(conf-support-assist-ExampleCompanyName)# contact-person first Firstname last
Lastname
OS10(conf-support-assist-ExampleCompanyName)# email-address primary
youremail@example.com alternate alternate_email@example.com
OS10(conf-support-assist-ExampleCompanyName-FirstnameLastname)# preferred-method email
OS10(conf-support-assist-ExampleCompanyName)# phone primary 000-123-4567 alternate
123-456-7890
```

## Schedule activity

Schedule a time for a full data transfer.

**i** **NOTE:** When a full data transfer starts, SupportAssist opens an SSH session with the user `mgmt_evt_user` to collect data. When you run the `show sessions` command to view a list of active user sessions, the system displays the `mgmt_evt_user` session as well. SupportAssist requires this session to be active to collect data. Killing this session halts data collection.

- Configure full-transfer or log-transfer activities in EXEC mode.

```
OS10# support-assist-activity {full-transfer} schedule {hourly | daily | weekly |
monthly | yearly}
```

- o hourly min *number*—Enter the time to schedule an hourly task, from 0 to 59.
- o daily hour *number* min *number*—Enter the time to schedule a daily task, from 0 to 23 hours and 0 to 59 minutes.
- o weekly day-of-week *number* hour *number* min *number*—Enter the time to schedule a weekly task, from 0 to 6 days, 0 to 23 hours, and 0 to 59 minutes.
- o monthly day *number* hour *number* min *number*—Enter the time to schedule a monthly task, from 1 to 31 days, 0 to 23 hours, and 0 to 59 minutes.
- o yearly month *number* day *number* hour *number* min *number*—Enter the time to schedule a yearly task, from 1 to 12 months, 1 to 31 days, 0 to 23 hours, and 0 to 59 minutes.

### Configure activity schedule for full transfer

```
OS10# support-assist-activity full-transfer schedule daily hour 22 min 50
OS10# support-assist-activity full-transfer schedule weekly day-of-week 6 hour 22 min 30
OS10# support-assist-activity full-transfer schedule monthly day 15 hour 12 min 30
```

### Set default activity schedule

```
OS10(conf-support-assist)# no support-assist-activity full-transfer schedule
```

## View status

View the SupportAssist configuration status, details, and EULA information using the following `show` commands:

1. View the SupportAssist activity in EXEC mode.

```
show support-assist status
```

2. View the EULA license agreement in EXEC mode.

```
show support-assist eula
```

### View SupportAssist status

```
OS10# show support-assist status
EULA support-assist : Accepted
Service : Enabled
Contact-Company : ExampleCompanyName
Street Address : Olympia
City : SanJose
State : California
Country : USA
Zipcode : 95123
Territory : West
Contact-person : Firstname Lastname
Primary email : youremail@example.com
Alternate email : emailid@example.com
Primary phone : 000-123-4567
Alternate phone : 7777777777
Contact method : email
Server(configured) : default

Activity Enable State :
 Activity State

 full-transfer Enabled
 event-notification Enabled

Scheduled Activity List :
 Activity Schedule Schedule created on

 full-transfer None Never

Activity Status :
 Activity Status last start last success

 full-transfer Success 2019-06-13 16:08:51 2019-06-13
```

```

16:15:19
 event-notification Success 2019-06-13 16:04:35 2019-06-13
16:04:39
 keep-alive Success 2019-06-13 18:00:00 2019-06-13
17:30:03

Server Status :
Last KeepAlive Status : Failed
Last KeepAlive Successful at : 2019-06-13 17:30:03
Last KeepAlive Failed at : 2019-06-13 18:00:03
Last MFT Status : Success
Last MFT Successful at : 2019-06-13 16:15:19
Last MFT Failed at : Never

```

## View EULA license

```

OS10# show support-assist eula
SUPPORTASSIST ENTERPRISE - SOFTWARE TERMS
*** IMPORTANT INFORMATION - PLEASE READ CAREFULLY ***
This SupportAssist Software ("Software") contains computer programs and other
proprietary material and information, the
use of which is governed by and expressly conditioned upon acceptance of this
SupportAssist Enterprise Software
Terms ("Agreement"). This Agreement is a legally binding agreement between the entity
that has obtained the
Software ("You" or "Customer") and Provider (which may be a Dell Inc. Affiliate or an
authorized reseller ("Reseller"),
as explained below). If you are acting on behalf of a U.S. Federal Government agency,
please stop installing the
Software and contact your sales account representative.
.
.
.
<<Output Truncated>>

```

## View warranty information

The Dell EMC TechDirect server manages the warranty information for OS10 switches and the relevant service contracts. You can obtain warranty information for the OS10 switch using the following two-step process:

 **NOTE:** You must accept the EULA before you can view the warranty information. See [eula-consent](#) for more information.

1. Obtain the warranty information from the TechDirect server:

```
OS10# support-assist-activity warranty refresh
```

The OS10 switch retrieves the warranty information.

2. View the warranty information.

```

OS10# show support-assist warranty

EULA support-assist : Accepted
Warranty details last received on: 2019-08-18T05:00:00Z
Service Tag: CARV007 Ship Date: February 08, 2017 Country: United States

Service Startdate Warranty expiration
date

-
ProSupport Flex for Client February 08, 2017 February 07, 2018
ProSupport Plus for PCs and Tablets February 08, 2017 February 07, 2018
Onsite Service After Remote Diagnosis February 08, 2017 February 07, 2018
Next Business Day + Onsite Resolution February 08, 2017 February 07, 2018

```

This command displays warranty information including when this information was last obtained from the server.



## View SupportAssist logs

To view a list of SupportAssist activities with the ESRS and TechDirect servers, use the following show command:

```
OS10# show support-assist logs
1 Thu Jun 27 15:32:46 UTC 2019 Device registered with ESRS Server
2 Fri Jun 28 03:11:46 UTC 2019 Full-transfer bundle uploaded to ESRS Server
3 Fri Jun 28 03:11:55 UTC 2019 Alert bundle uploaded to ESRS Server
4 Fri Jun 28 03:11:58 UTC 2019 Alert bundle uploaded to ESRS Server
5 Fri Jun 28 05:08:49 UTC 2019 Alert bundle uploaded to ESRS Server
6 Fri Jun 28 03:00:00 UTC 2019 Warranty status refreshed
7 Fri Jun 29 03:00:00 UTC 2019 Warranty status refreshed
8 Fri Jun 29 03:11:46 UTC 2019 Full-transfer bundle uploaded to ESRS Server
9 Fri Jun 30 05:13:37 UTC 2019 Full-transfer bundle upload failed due to communication
error
10 Fri Jun 30 05:14:00 UTC 2019 Alert bundle upload failed due to communication error
11 Fri Jun 30 05:14:03 UTC 2019 Alert bundle uploaded to ESRS Server
```

## List of country names and codes

This section provides a list of country codes that you must use in the [address](#) command.

**Table 104. Country names and codes**

Country name	Country code
Afghanistan	AFG
Aland Islands	ALA
Albania	ALB
Algeria	DZA
American Samoa	ASM
Andorra	AND
Angola	AGO
Anguilla	AIA
Antarctica	ATA
Antigua and Barbuda	ATG
Argentina	ARG
Armenia	ARM
Aruba	ABW
Australia	AUS
Austria	AUT
Azerbaijan	AZE
Bahamas	BHS
Bahrain	BHR
Bangladesh	BGD
Barbados	BRB
Belarus	BLR
Belgium	BEL
Belize	BLZ

**Table 104. Country names and codes (continued)**

<b>Country name</b>	<b>Country code</b>
Benin	BEN
Bermuda	BMU
Bhutan	BTN
Bolivia, Plurinational State of	BOL
Bonaire, Sint Eustatius and Saba	BES
Bosnia and Herzegovina	BIH
Botswana	BWA
Bouvet Island	BVT
Brazil	BRA
British Indian Ocean Territory	IOT
Brunei Darussalam	BRN
Bulgaria	BGR
Burkina Faso	BFA
Burundi	BDI
Cambodia	KHM
Cameroon	CMR
Canada	CAN
Cabo Verde	CPV
Cayman Islands	CYM
Central African Republic	CAF
Chad	TCD
Chile	CHL
China	CHN
Christmas Island	CXR
Cocos (Keeling) Islands	CCK
Colombia	COL
Comoros	COM
Congo	COGCG
Congo, the Democratic Republic of the	COD
Cook Islands	COK
Costa Rica	CRI
Côte d'Ivoire	CIV
Croatia	HRV
Cuba	CUB
Curaçao	CUW
Cyprus	CYP
Czech Republic	CZE

**Table 104. Country names and codes (continued)**

<b>Country name</b>	<b>Country code</b>
Denmark	DNK
Djibouti	DJI
Dominica	DMA
Dominican Republic	DOM
Ecuador	ECU
Egypt	EGY
El Salvador	SLV
Equatorial Guinea	GNQ
Eritrea	ERI
Estonia	EST
Ethiopia	ETH
Falkland Islands (Malvinas)	FLK
Faroe Islands	FRO
Fiji	FJI
Finland	FIN
France	FRA
French Guiana	GUF
French Polynesia	PYF
French Southern Territories	ATF
Gabon	GAB
Gambia	GMB
Georgia	GEO
Germany	DEU
Ghana	GHA
Gibraltar	GIB
Greece	GRC
Greenland	GRL
Grenada	GRD
Guadeloupe	GLP
Guam	GUM
Guatemala	GTM
Guernsey	GGY
Guinea	GIN
Guinea-Bissau	GNB
Guyana	GUY
Haiti	HTI
Heard Island and McDonald Islands	HMD

**Table 104. Country names and codes (continued)**

<b>Country name</b>	<b>Country code</b>
Holy See (Vatican City State)	VAT
Honduras	HND
Hong Kong	HKG
Hungary	HUN
Iceland	ISL
India	IND
Indonesia	IDN
Iran, Islamic Republic of	IRN
Iraq	IRQ
Ireland	IRL
Isle of Man	IMN
Israel	ISR
Italy	ITA
Jamaica	JAM
Japan	JPN
Jersey	JEY
Jordan	JOR
Kazakhstan	KAZ
Kenya	KEN
Kiribati	KIR
Korea, Democratic People's Republic of	PRK
Korea, Republic of	KOR
Kuwait	KWT
Kyrgyzstan	KGZ
Lao People's Democratic Republic	LAO
Latvia	LVA
Lebanon	LBN
Lesotho	LSO
Liberia	LBR
Libya	LBY
Liechtenstein	LIE
Lithuania	LTU
Luxembourg	LUX
Macao	MAC
Macedonia, the former Yugoslav Republic of	MKD
Madagascar	MDG
Malawi	MWI

**Table 104. Country names and codes (continued)**

<b>Country name</b>	<b>Country code</b>
Malaysia	MYS
Maldives	MDV
Mali	MLI
Malta	MLT
Marshall Islands	MHL
Martinique	MTQ
Mauritania	MRT
Mauritius	MUS
Mayotte	MYT
Mexico	MEX
Micronesia, Federated States of	FSM
Moldova, Republic of	MDA
Monaco	MCO
Mongolia	MNG
Montenegro	MNE
Montserrat	MSR
Morocco	MAR
Mozambique	MOZ
Myanmar	MMR
Namibia	NAM
Nauru	NRU
Nepal	NPL
Netherlands	NLD
New Caledonia	NCL
New Zealand	NZL
Nicaragua	NIC
Niger	NER
Nigeria	NGA
Niue	NIU
Norfolk Island	NFK
Northern Mariana Islands	MNP
Norway	NOR
Oman	OMN
Pakistan	PAK
Palau	PLW
Palestine, State of	PSE
Panama	PAN

**Table 104. Country names and codes (continued)**

<b>Country name</b>	<b>Country code</b>
Papua New Guinea	PNG
Paraguay	PRY
Peru	PER
Philippines	PHL
Pitcairn	PCN
Poland	POL
Portugal	PRT
Puerto Rico	PRI
Qatar	QAT
RÃ©union	REU
Romania	ROU
Russian Federation	RUS
Rwanda	RWA
Saint BarthÃ©lemy	BLM
Saint Helena, Ascension and Tristan da Cunha	SHN
Saint Kitts and Nevis	KNA
Saint Lucia	LCA
Saint Martin (French part)	MAF
Saint Pierre and Miquelon	SPM
Saint Vincent and the Grenadines	VCT
Samoa	WSM
San Marino	SMR
Sao Tome and Principe	STP
Saudi Arabia	SAU
Senegal	SEN
Serbia	SRB
Seychelles	SYC
Sierra Leone	SLE
Singapore	SGP
Sint Maarten (Dutch part)	SXM
Slovakia	SVK
Slovenia	SVN
Solomon Islands	SLB
Somalia	SOM
South Africa	ZAF
South Georgia and the South Sandwich Islands	SGS
South Sudan	SSD

**Table 104. Country names and codes (continued)**

<b>Country name</b>	<b>Country code</b>
Spain	ESP
Sri Lanka	LKA
Sudan	SDN
Suriname	SUR
Svalbard and Jan Mayen	SJM
Swaziland	SWZ
Sweden	SWE
Switzerland	CHE
Syrian Arab Republic	SYR
Taiwan, Province of China	TWN
Tajikistan	TJK
Tanzania, United Republic of	TZA
Thailand	THA
Timor-Leste	TLS
Togo	TGO
Tokelau	TKL
Tonga	TON
Trinidad and Tobago	TTO
Tunisia	TUN
Turkey	TUR
Turkmenistan	TKM
Turks and Caicos Islands	TCA
Tuvalu	TUV
Uganda	UGA
Ukraine	UKR
United Arab Emirates	ARE
United Kingdom	GBR
United States	USA
United States Minor Outlying Islands	UMI
Uruguay	URY
Uzbekistan	UZB
Vanuatu	VUT
Venezuela, Bolivarian Republic of	VEN
Viet Nam	VNM
Virgin Islands, British	VGB
Virgin Islands, U.S.	VIR
Wallis and Futuna	WLF

**Table 104. Country names and codes (continued)**

Country name	Country code
Western Sahara	ESH
Yemen	YEM
Zambia	ZMB
Zimbabwe	ZWE

## SupportAssist commands

### eula-consent

Accepts or rejects the SupportAssist end-user license agreement (EULA).

**Syntax** `eula-consent {support-assist} {accept | reject}`

**Parameters**

- `support-assist` — Enter to accept or reject the EULA for the service.
- `accept` — Enter to accept the EULA-consent.
- `reject` — Enter to reject EULA-consent.

**Default** Not configured

**Command Mode** CONFIGURATION

**Usage Information** If you reject the end-user license agreement, you cannot access the SupportAssist Configuration submode. If there is an existing SupportAssist configuration, the configuration is removed and the feature is disabled.

Supported on the MX9116n and MX5108n switches in Full Switch mode starting in release 10.4.0E(R3S). Also supported in SmartFabric mode starting in release 10.5.0.1

**Example (Accept)**

```
OS10(config)# eula-consent support-assist accept
```

**Example (Reject)**

```
OS10(config)# eula-consent support-assist reject

This action will disable Support Assist and erase all configured data.Do
you want to proceed ? [Y/N]:Y
```

**Supported Releases** 10.2.0E or later

### show eula-consent support-assist

Displays the status of the SupportAssist End User License Agreement, whether it is accepted or rejected.

**Syntax** `show eula-consent support-assist`

**Parameters** None

**Default** Rejected

**Command Mode** EXEC

**Usage Information** Use this command to view the status of the SupportAssist EULA.

Supported on the MX9116n and MX5108n switches in Full Switch mode starting in release 10.4.0E(R3S). Also supported in SmartFabric mode starting in release 10.5.0.1



**Example**

```
OS10# show eula-consent support-assist
EULA support-assist : Accepted
```

**Supported Releases**

10.2.0E or later

## show support-assist warranty

Displays warranty information for the OS10 switch and the relevant service contracts.

**Syntax** `show support-assist warranty`**Parameters** None**Default** None**Command Mode** EXEC**Usage Information** This command displays the warranty information for the OS10 switch and the relevant service contracts.**Example**

```
OS10# show support-assist warranty

Warranty details last received on: 2019-08-18T05:00:00Z
Service Tag: CARV007 Ship Date: February 08, 2017 Country: United States

Service Startdate Warranty expiration date

ProSupport Flex for Client February 08, 2017 February 07, 2018
ProSupport Plus for PCs and Tablets February 08, 2017 February 07, 2018
Onsite Service After Remote Diagnosis February 08, 2017 February 07, 2018
Next Business Day + Onsite Resolution February 08, 2017 February 07, 2018
```

**Supported Releases**

10.5.1.0 or later

## show support-assist logs

Displays high-level logs of SupportAssist activities.

**Syntax** `show support-assist logs`**Parameters** None**Default** None**Command Mode** EXEC**Usage Information** This command displays a list of SupportAssist activities with the ESRS and TechDirect servers.**Example**

```
OS10# show support-assist logs
1 Thu Jun 27 15:32:46 UTC 2019 Device registered with ESRS Server
2 Fri Jun 28 03:11:46 UTC 2019 Full-transfer bundle uploaded to ESRS
Server
3 Fri Jun 28 03:11:55 UTC 2019 Alert bundle uploaded to ESRS Server
4 Fri Jun 28 03:11:58 UTC 2019 Alert bundle uploaded to ESRS Server
5 Fri Jun 28 05:08:49 UTC 2019 Alert bundle uploaded to ESRS Server
6 Fri Jun 28 03:00:00 UTC 2019 Warranty status refreshed
7 Fri Jun 29 03:00:00 UTC 2019 Warranty status refreshed
8 Fri Jun 29 03:11:46 UTC 2019 Full-transfer bundle uploaded to ESRS
Server
9 Fri Jun 30 05:13:37 UTC 2019 Full-transfer bundle upload failed due
to communication error
```

```

10 Fri Jun 30 05:14:00 UTC 2019 Alert bundle upload failed due to
communication error
11 Fri Jun 30 05:14:03 UTC 2019 Alert bundle uploaded to ESRS Server

```

**Supported Releases** 10.5.1.0 or later

## support-assist

Enters SupportAssist subconfiguration mode.

**Syntax** support-assist

**Parameters** None

**Default** Not applicable

**Command Mode** CONFIGURATION

**Usage Information** Supported on the MX9116n and MX5108n switches in Full Switch mode starting in release 10.4.0E(R3S). Also supported in SmartFabric mode starting in release 10.5.0.1

### Example

```

OS10(config)# support-assist
OS10(conf-support-assist)#

```

**Supported Releases** 10.2.0E or later

## support-assist-activity

Schedules a time for data collection and transfer activity or performs on-demand data collection and managed file transfer.

**Syntax** support-assist-activity full-transfer {start-now | [schedule {hourly *minute* | daily hour *number* min *number* | weekly day-of-week *number* hour *number* min *number* | monthly day *number* hour *number* min *number* | yearly month *number* day *number* hour *number* min *number*}]}

### Parameters

- start-now—Schedules the transfer to start immediately.
- hourly *minute*—Enter the keyword and specify the minute to schedule the task, 0–59.
- daily—Schedules a daily task:
  - hour *number*—Enter the keyword and specify the hour to schedule the task, 0–23.
  - min *number*—Enter the keyword and specify the minute to schedule the task, 0–59.
- weekly—Schedules a weekly task:
  - day-of-week *number*—Enter the keyword and number for the day of the week to schedule the task, 0–6.
  - hour *number*—Enter the keyword and specify the hour to schedule the task, 0–23.
  - min *number*—Enter the keyword and specify the minute to schedule the task, 0–59.
- monthly—Schedules a monthly task:
  - day *number*—Enter the keyword and number for the day of the month to schedule the task, 1–31.
  - hour *number*—Enter the keyword and specify the hour to schedule the task, 0–23.
  - min *number*—Enter the keyword and specify the minute to schedule the task, 0–59.
- yearly—Schedules a yearly task:
  - month *number*—Enter the keyword and specify the month in which to schedule the task, 1–12.
  - day *number*—Enter the keyword and number for the day of the month to schedule the task, 1–31.
  - hour *number*—Enter the keyword and specify the hour to schedule the task, 0–23.

- o `min number`—Enter the keyword and specify the minute to schedule the task, 0–59.

**Default** None

**Command Mode** EXEC

**Usage Information** Supported on the MX9116n and MX5108n switches in Full Switch mode starting in release 10.4.0E(R3S). Also supported in SmartFabric mode starting in release 10.5.0.1

The `no` version of this command removes the configuration.

**Examples**

```
OS10# support-assist-activity full-transfer start-now
OS10# support-assist-activity full-transfer schedule hourly min 59
OS10# support-assist-activity full-transfer schedule daily hour 23 min 59
OS10# support-assist-activity full-transfer schedule weekly day-of-week
1 hour 23 min 59
OS10# support-assist-activity full-transfer schedule monthly day 30 hour
23 min 59
OS10# support-assist-activity full-transfer schedule yearly month 12 day
31 hour 23 min 59
```

**Supported Releases** 10.2.0E or later

## support-assist-activity warranty refresh

Obtains warranty information from the Dell EMC TechDirect servers and refreshes the warranty information stored in the OS10 switch.

**Syntax** `support-assist-activity warranty refresh`

**Parameters** None

**Default** Not applicable

**Command Mode** EXEC

**Usage Information** This command obtains the information from the Dell EMC TechDirect servers. It does not display results on the CLI. Use the `show support-assist warranty detailed` command to view the warranty information.

**Example**

```
OS10# support-assist-activity warranty refresh
OS10#
```

**Supported Releases** 10.5.1.0 or later

## SupportAssist configuration commands

### activity

Enables data collection activity for full transfer or event notifications.

**Syntax** `activity {event-notification | full-transfer}`

<b>Parameters</b>	None
<b>Default</b>	Enabled
<b>Command Mode</b>	SUPPORT-ASSIST
<b>Usage Information</b>	This command enables data collection for the specified activity. Supported on the MX9116n and MX5108n switches in Full Switch mode starting in release 10.4.0(R3S). Also supported in SmartFabric mode starting in release 10.5.0. The <code>no</code> version of this command disables the activity.
<b>Examples</b>	<pre>OS10(conf-support-assist)# activity event-notification enable</pre> <pre>OS10(conf-support-assist)# activity full-transfer enable</pre>
<b>Supported Releases</b>	10.2.0E or later

## contact-company

Configures the company contact information.

<b>Syntax</b>	<code>contact-company name <i>company-name</i></code>
<b>Parameters</b>	<i>company-name</i> —Enter the contact company name.
<b>Default</b>	Not configured
<b>Command Mode</b>	SUPPORT-ASSIST
<b>Usage Information</b>	You can enter only one contact company. This command takes you to a submode where you can provide more company contact information. Supported on the MX9116n and MX5108n switches in Full Switch mode starting in release 10.4.0(R3S). Also supported in SmartFabric mode starting in release 10.5.0. The <code>no</code> version of this command removes the configuration.
<b>Example</b>	<pre>OS10(conf-support-assist)# contact-company name ExampleCompanyName OS10(conf-support-assist-ExampleCompanyName)#</pre>
<b>Supported Releases</b>	10.2.0E or later

## server url

Configures the URL and port of the SupportAssist server and specifies the username and password needed for SupportAssist server authorization.

<b>Syntax</b>	<code>server url {default   <i>server-url-string</i>} username <i>username</i> password <i>password</i></code>
<b>Parameters</b>	<ul style="list-style-type: none"> <li><code>default</code>—Enter the default to connect to the SupportAssist server (<a href="https://esrs3.emc.com">https://esrs3.emc.com</a>).</li> <li><code>server-url-string</code>—Enter the domain name or IP address of the SupportAssist server.</li> <li><code>username</code>—Enter the username to establish connectivity with the SupportAssist server.</li> <li><code>password</code>—Enter the password to establish connectivity with the SupportAssist server.</li> </ul>
<b>Default</b>	None
<b>Command Mode</b>	SUPPORT-ASSIST
<b>Usage Information</b>	Enter your Dell Digital Locker (DDL) credentials. This account must have entitlements to the OS10 switch in DDL. To view the server configuration. The <code>no</code> version of this command removes the configuration, only configure one SupportAssist server, use the <code>show support-assist status</code> command.

Supported on the MX9116n and MX5108n switches in Full Switch mode starting in release 10.4.0(R3S). Also supported in SmartFabric mode starting in release 10.5.0.

**Example**

```
OS10(conf-support-assist)# server url default username
youremailid@example.com password Password1
```

**Supported Releases** 10.2.0E or later

## show configuration

Displays the SupportAssist configuration currently running on the device.

**Syntax** show configuration

**Parameters** None

**Default** Not configured

**Command Mode** SUPPORT-ASSIST

**Usage Information** Supported on the MX9116n and MX5108n switches in Full Switch mode starting in release 10.4.0(R3S). Also supported in SmartFabric mode starting in release 10.5.0.

**Example**

```
OS10(conf-support-assist)# show configuration
!
support-assist
server url https://esrs3stg.emc.com username example-username
password
976dbcf6cce4bd298375e15bb989a9a6e6ee51d130d446ce3c25ade72a6f99fc6
source-interface mgmt1/1/1
!
contact-company name "Example Company Name"
street-address No:123 Example Street Bldg 999
address city San Jose state California country USA zipcode 95125
territory Global
!
contact-person first Firstname last Lastname
email-address primary youremail@example.com alternate
alternate_email@example.com
phone primary 0001234567 alternate 1234567890
preferred-method email
```

**Supported Releases** 10.2.0E or later

## show running-configuration support-assist

Displays the SupportAssist configuration currently running on the device.

**Syntax** show running-configuration support-assist

**Parameters** None

**Default** Not configured

**Command Mode** EXEC

**Usage Information** Supported on the MX9116n and MX5108n switches in Full Switch mode starting in release 10.4.0(R3S). Also supported in SmartFabric mode starting in release 10.5.0.

**Example**

```
OS10# show running-configuration support-assist
!
support-assist
server url https://esrs3stg.emc.com username example-username
password
```

```

976dbcf6cce4bd298375e15bb989a9a6e6ee51d130d446ce3c25ade72a6f99fc6
source-interface mgmt1/1/1
!
contact-company name "Example Company Name"
 street-address No:123 Example Street Bldg 999
 address city San Jose state California country USA zipcode 95125
 territory Global
!
contact-person first Firstname last Lastname
 email-address primary youremail@example.com alternate
 alternate_email@example.com
 phone primary 0001234567 alternate 1234567890
 preferred-method email

```

**Supported Releases** 10.2.0E or later

## show support-assist eula

Displays the EULA for SupportAssist.

**Syntax** show support-assist eula

**Parameters** None

**Default** None

**Command Mode** EXEC

**Usage Information** Use this command to view the EULA for SupportAssist.

Supported on the MX9116n and MX5108n switches in Full Switch mode starting in release 10.4.0(R3S). Also supported in SmartFabric mode starting in release 10.5.0.

### Example

```

OS10# show support-assist eula
SUPPORTASSIST ENTERPRISE - SOFTWARE TERMS
*** IMPORTANT INFORMATION - PLEASE READ CAREFULLY ***
This SupportAssist Software ("Software") contains computer programs and
other proprietary material and information,
the use of which is governed by and expressly conditioned upon
acceptance of this SupportAssist Enterprise Software
Terms ("Agreement"). This Agreement is a legally binding agreement
between the entity that has obtained the
Software ("You" or "Customer") and Provider (which may be a Dell Inc.
Affiliate or an authorized reseller ("Reseller"),
as explained below). If you are acting on behalf of a U.S. Federal
Government agency, please stop installing the
Software and contact your sales account representative.
.
.
.
<<Output Truncated>>

```

**Supported Releases** 10.2.0E or later

## show support-assist status

Displays SupportAssist status information, including activities and events.

**Syntax** show support-assist status

**Parameters** None

**Default** Not configured

**Command Mode** EXEC

## Usage Information

Use this command to view the SupportAssist status.

Supported on the MX9116n and MX5108n switches in Full Switch mode starting in release 10.4.0(R3S). Also supported in SmartFabric mode starting in release 10.5.0.

## Example

```
OS10# show support-assist status
EULA support-assist : Accepted
Service : Enabled
Contact-Company : ExampleCompanyName
Street Address : Olympia
City : SanJose
State : California
Country : USA
Zipcode : 95123
Territory : West
Contact-person : Firstname Lastname
Primary email : youremail@example.com
Alternate email : emailid@example.com
Primary phone : 000-123-4567
Alternate phone : 777777777
Contact method : email
Server(configured) : default

Activity Enable State :
 Activity State

 full-transfer Enabled
 event-notification Enabled

Scheduled Activity List :
 Activity Schedule Schedule created on

 full-transfer None Never

Activity Status :
 Activity Status last start last success

 full-transfer Success 2019-06-13 16:08:51 2019-06-13
16:15:19
 event-notification Success 2019-06-13 16:04:35 2019-06-13
16:04:39
 keep-alive Success 2019-06-13 18:00:00 2019-06-13
17:30:03

Server Status :
Last KeepAlive Status : Failed
Last KeepAlive Successful at : 2019-06-13 17:30:03
Last KeepAlive Failed at : 2019-06-13 18:00:03
Last MFT Status : Success
Last MFT Successful at : 2019-06-13 16:15:19
Last MFT Failed at : Never
```

## Supported Releases

10.2.0E or later

## source-interface

Configures the source interface to establish outgoing connectivity to the SupportAssist server.

**Syntax** `source-interface interface`

**Parameters** `interface:`

- `ethernet node/slot/port[:subport]`—Enter a physical Ethernet interface.
- `loopback number`—Enter a Loopback interface, from 0 to 16383.
- `management 1/1/1`—Enter the management interface.
- `port-channel channel-id`—Enter a port channel interface, from 1 to 128.

- `vlan vlan-id`—Enter a VLAN ID, from 1 to 4093.

**Default** Not configured.

**Command Mode** SUPPORT-ASSIST

**Usage Information** Supported on the MX9116n and MX5108n switches in Full Switch mode starting in release 10.4.0(R3S). Also supported in SmartFabric mode starting in release 10.5.0.

The `no` version of this command removes the configuration.

**Examples**

```
OS10 (conf-support-assist) # source-interface ethernet 1/1/4
```

```
OS10 (conf-support-assist) # source-interface loopback 1
```

```
OS10 (conf-support-assist) # source-interface mgmt 1/1/1
```

```
OS10 (conf-support-assist) # source-interface port-channel 10
```

```
OS10 (conf-support-assist) # source-interface vlan 100
```

**Supported Releases** 10.4.0E(R1) or later

## SupportAssist company commands

### address

Configures the company address.

**Syntax** `address city name state name country name zipcode number`

- Parameters**
- `city name`—Enter the keyword and the city name.
  - `state name`—Enter the keyword and the state name.
  - `country name`—Enter the keyword and the country code.
  - `zipcode number`—Enter the keyword and the zip code.

**Default** Not configured

**Command Mode** SUPPORT-ASSIST contact company sub-mode

**Usage Information** Enter ? to view a list of supported country names and codes. You can also find this information at the following location: [Country names and codes](#).

Supported on the MX9116n and MX5108n switches in Full Switch mode starting in release 10.4.0(R3S). Also supported in SmartFabric mode starting in release 10.5.0.

The `no` version of this command removes the configuration.

**Example**

```
OS10 (conf-support-assist-ExampleCompanyName) # address city SanJose state California country USA zipcode 95123
```

**Supported Releases** 10.2.0E or later

### contact-person

Configures the contact name for an individual.

**Syntax** `contact-person {first firstname last lastname}`



<b>Parameters</b>	<ul style="list-style-type: none"> <li>• <i>first</i> <i>firstname</i> — Enter the keyword and the first name of the contact person. Use double quotes for more than one first name.</li> <li>• <i>last</i> <i>lastname</i> — Enter the keyword and the last name of the contact person.</li> </ul>
<b>Default</b>	Not configured
<b>Command Mode</b>	SUPPORT-ASSIST
<b>Usage Information</b>	Supported on the MX9116n and MX5108n switches in Full Switch mode starting in release 10.4.0(R3S). Also supported in SmartFabric mode starting in release 10.5.0. The <code>no</code> version of this command removes the configuration.
<b>Example</b>	<pre>OS10(conf-support-assist-ExampleCompanyName)# contact-person first Firstname last Lastname</pre>
<b>Supported Releases</b>	10.2.0E or later

## street-address

Configures the street address of the company.

<b>Syntax</b>	<code>street-address {line-1} [line-2] [line-3]</code>
<b>Parameters</b>	<i>line-1 line-2 line-3</i> — Enter the address of the company, from 1 to 3 lines. Enclose the text within double quotes. Insert a space after each line of text.
<b>Default</b>	Not configured
<b>Command Mode</b>	<ul style="list-style-type: none"> <li>• SUPPORT-ASSIST</li> </ul>
<b>Usage Information</b>	Supported on the MX9116n and MX5108n switches in Full Switch mode starting in release 10.4.0(R3S). Also supported in SmartFabric mode starting in release 10.5.0. The <code>no</code> version of this command removes the configuration.
<b>Example</b>	<pre>OS10(conf-support-assist-ExampleCompanyName)# street-address "One Dell Way" "Suite 100" "Santa Clara"</pre>
<b>Supported Releases</b>	10.2.0E or later

## territory

Configures the place where the company is located.

<b>Syntax</b>	<code>territory territory-name</code>
<b>Parameters</b>	<i>territory-name</i> —Enter the territory where the company is located.
<b>Default</b>	Not configured
<b>Command Mode</b>	CONF-SUPPORT-ASSIST
<b>Usage Information</b>	Supported on the MX9116n and MX5108n switches in Full Switch mode starting in release 10.4.0(R3S). Also supported in SmartFabric mode starting in release 10.5.0. The <code>no</code> version of this command removes the configuration.
<b>Example</b>	<pre>OS10(conf-support-assist)# contact-company name ExampleCompanyName OS10(conf-support-assist-ExampleCompanyName)# territory West</pre>
<b>Supported Releases</b>	10.2.0E or later

## SupportAssist person commands

### email-address

Configures the email address of the contact person.

<b>Syntax</b>	<code>email-address primary <i>email-id</i> [alternate <i>email-id</i>]</code>
<b>Parameters</b>	<i>email-id</i> —Enter the email address of the contact person.
<b>Default</b>	Not configured
<b>Command Mode</b>	SUPPORT-ASSIST
<b>Usage Information</b>	Supported on the MX9116n and MX5108n switches in Full Switch mode starting in release 10.4.0(R3S). Also supported in SmartFabric mode starting in release 10.5.0. The <code>no</code> version of this command removes the configuration.
<b>Example</b>	<pre>OS10 (conf-support-assist-ExampleCompanyName-FirstnameLastname) # email-address primary youremail@example.com alternate emailid@example.com</pre>
<b>Supported Releases</b>	10.2.0E or later

### phone

Configures the phone number of the contact person.

<b>Syntax</b>	<code>phone primary <i>string</i> [alternate <i>string</i>]</code>
<b>Parameters</b>	<i>string</i> —Enter the phone number of the contact person. Minimum length of phone number is nine digits.
<b>Default</b>	None
<b>Command Mode</b>	SUPPORT-ASSIST
<b>Usage Information</b>	Supported on the MX9116n and MX5108n switches in Full Switch mode starting in release 10.4.0(R3S). Also supported in SmartFabric mode starting in release 10.5.0. The <code>no</code> version of this command removes the configuration.
<b>Example</b>	<pre>OS10 (conf-support-assist-ExampleCompanyName-FirstnameLastname) # phone primary 000-123-4567</pre>
<b>Supported Releases</b>	10.2.0E or later

### preferred-method

Configures a preferred method to contact an individual.

<b>Syntax</b>	<code>preferred-method {email   phone   no-contact}</code>
<b>Parameters</b>	<ul style="list-style-type: none"><li><code>email</code>—Enter to select email as the preferred contact method.</li><li><code>phone</code>—Enter to select phone as the preferred contact method.</li><li><code>no-contact</code>—Enter to specify that the individual does not want to be contacted through email or phone.</li></ul>
<b>Default</b>	No-contact
<b>Command Mode</b>	SUPPORT-ASSIST

## Usage Information

Supported on the MX9116n and MX5108n switches in Full Switch mode starting in release 10.4.0(R3S). Also supported in SmartFabric mode starting in release 10.5.0.

The `no` version of this command removes the configuration.

## Examples

```
OS10 (conf-support-assist-ExampleCompanyName-FirstnameLastname) #
preferred-method email
```

```
OS10 (conf-support-assist-ExampleCompanyName-FirstnameLastname) #
preferred-method phone
```

```
OS10 (conf-support-assist-ExampleCompanyName-FirstnameLastname) #
preferred-method no-contact
```

## Supported Releases

10.2.0E or later

# Support bundle

The Support Bundle is based on the `sosreport` tool. Use the Support Bundle to generate an `sosreport` tar file that collects Linux system configuration and diagnostics information, as well as the `show` command output to send to Dell EMC Technical Support.

To send Dell EMC Technical Support troubleshooting details about the Linux system configuration and OS10 diagnostics, generate an `sosreport` tar file.

1. Generate the tar file in EXEC mode.

```
generate support-bundle
```

2. Verify the generated file in EXEC mode.

```
dir supportbundle
```

3. Send the support bundle using FTP/SFTP/SCP/TFTP in EXEC mode.

```
copy supportbundle://sosreport-filename.tar.gz tftp://server-address/path
```

Use the `delete supportbundle://sosreport-filename.tar.gz` command to delete a generated support bundle.

## Event notifications

Event notifications for the `generate support-bundle` command process at the start and end of the bundle they support, and reports either success or failure.

### Support bundle generation start event

```
Apr 19 16:57:55: %Node.1-Unit.1:PRI:OS10 %log-notice:SUPPORT_BUNDLE_STARTED: generate
support-bundle execution has started successfully:All Plugin options disabled
Apr 19 16:57:55: %Node.1-Unit.1:PRI:OS10 %log-notice:SUPPORT_BUNDLE_STARTED: generate
support-bundle execution has started successfully:All Plugin options enabled
```

### sosreport generation start event

```
May 11 22:9:43: %Node.1-Unit.1:PRI:OS10 %log-notice:SOSREPORT_GEN_STARTED: CLI output
collection task completed; sosreport execution task started:All Plugin options disabled
May 11 22:9:43: %Node.1-Unit.1:PRI:OS10 %log-notice:SOSREPORT_GEN_STARTED: CLI output
collection task completed; sosreport execution task started:All Plugin options enabled
```

### Support bundle generation successful event

```
Apr 19 17:0:9: %Node.1-Unit.1:PRI:OS10 %log-notice:SUPPORT_BUNDLE_COMPLETED: generate
support-bundle execution has completed successfully:All Plugin options disabled
```

```
Apr 19 17:0:9: %Node.1-Unit.1:PRI:OS10 %log-notice:SUPPORT_BUNDLE_COMPLETED: generate support-bundle execution has completed successfully:All Plugin options enabled
```

### Support bundle generation failure

```
Apr 19 17:0:14: %Node.1-Unit.1:PRI:OS10 %log-notice:SUPPORT_BUNDLE_FAILURE: Failure in generate support-bundle execution:All Plugin options disabled
Apr 19 17:0:14: %Node.1-Unit.1:PRI:OS10 %log-notice:SUPPORT_BUNDLE_FAILURE: Failure in generate support-bundle execution:All Plugin options enabled
```

## generate support-bundle

Generates an `sosreport` tar file that collects configuration and diagnostic information on Linux systems.

<b>Syntax</b>	<code>generate support-bundle [enable-all-plugin-options]</code>
<b>Parameters</b>	<code>enable-all-plugin-options</code> — (Optional) Generate a full support bundle with all plugin options enabled.
<b>Defaults</b>	None
<b>Command Mode</b>	EXEC
<b>Usage Information</b>	To send the tar file to Dell EMC Technical Support, use the <code>dir supportbundle</code> and <code>copy supportbundle://sosreport-OS10-file-number.tar.gz tftp://server-address/path</code> commands.
<b>Example</b>	<pre>OS10# generate support-bundle</pre>
<b>Example (Enable Options)</b>	<pre>OS10# generate support-bundle enable-all-plugin-options</pre>
<b>Supported Releases</b>	10.2.0E or later

## System monitoring

Monitor OS10 using system alarms and log information.

### Configuration notes

All Dell EMC PowerSwitches except MX-Series, S4200-Series, S5200 Series, and Z9332F-ON:

Logging is enabled by default on a terminal emulator that is connected to the console serial port. However, in an SSH or Telnet terminal session, logging is disabled by default. To enable logging on a remote terminal in an SSH or Telnet session, use the terminal monitor command in EXEC mode. To disable logging in a remote or directly connected terminal, use the no terminal monitor command.

## System events and alarms

An event notifies you of a change or situation in the system that you might be interested in. An alarm indicates that the system has entered an abnormal state and may require immediate action.

Events are classified into:

- **Stateless events**—One-time notifications about the system condition, for example, ACL updates, firewall policy update, and so on.
- **Stateful events**—Events that are raised when the abnormal situation arises, and cleared when the situation returns to normal. These types of events are called alarms.

Events can have one of the following severities:

- **CRITICAL**—A critical condition exists and requires immediate action. A critical event may trigger if one or more hardware components fail, or one or more hardware components exceed temperature thresholds.

- **MAJOR**—A major error had occurred and requires escalation or notification. For example, a major alarm may trigger if an interface failure occurs, such as a port channel being down.
- **MINOR**—A minor error or noncritical condition occurred that, if left unchecked, might cause system service interruption or performance degradation. A minor alarm requires monitoring or maintenance.
- **WARNING**—A warning condition was observed, but it may or may not result in an error condition.
- **INFORMATIONAL**—An informational event had occurred, but it does not impact performance.

Out of memory, temperature crossing a critical point, and so on, are examples of conditions when the system triggers an alarm. After the system recovers from the condition, the alarms are cleared.

All stateful events of severity level CRITICAL, MAJOR, MINOR, or WARNING trigger alarms. However, you can customize the severity of events or turn off event notification using [Severity profiles](#).

Triggered alarms are in one of these states:

- **Active**—Alarm is raised and is currently active.
- **Acknowledged**—Alarm is raised; the user is aware of the situation and acknowledged the alarm. This alarm does not impact the overall health of the system or the system LED.

Some alarms go directly from active to cleared state and require little-to-no administrative effort. You must acknowledge or investigate alarms with a high severity.

OS10 stores all Active and Acknowledged alarms in the Current Alarm List (CAL), and archives all past events in the Event History List (EHL).

Alarms in the CAL are cleared after a reload.

The EHL is persistent and retains the archived events after a reload, reboot, or upgrade. The EHL can store a maximum of 86,000 events or 30 days of events, whichever is earlier.

The system LED that indicates the status of the switch is based on the severity of the alarms in the CAL and it turns:

- Red—For CRITICAL or MAJOR alarms
- Amber—For MINOR or WARNING alarms
- Green—No alarms

## Severity profiles

OS10 allows you to change the severity of events using severity profiles. A severity profile is a .xml file that defines the effective severity of events or disables the notification of events.

OS10 comes with a default severity profile. You cannot modify or delete the default profile. However, OS10 allows you to define custom severity profiles.

- Default severity profile—All events are defined in the default profile. The default profile classifies the events as CRITICAL, WARNING, or INFORMATIONAL in severity.
- Custom severity profile—Contains events that you modify. You can classify events as CRITICAL, MAJOR, MINOR, WARNING, or INFORMATIONAL in severity.

Events and their characteristics that are defined in the custom profile take precedence over the default profile.

To create a custom severity profile, copy the default severity profile to a remote host and modify it. After the custom profile is created, copy it from the remote host to the OS10 switch and apply it. The custom profile takes effect after a system restart.

### NOTE:

- To customize severity profiles, your user account must have any one of the following privileges: System admin (`sysadmin`), security admin (`secadmin`), or network admin (`netadmin`).
- You cannot edit an active custom profile. To edit an active custom severity profile, select another severity profile and apply it.

The `severity-profile://` partition contains all the defined severity profiles. To view a list of severity profiles, use the `dir severity-profile` command.

To delete a severity profile, use the `delete` command. You can delete all severity profiles except the default and active profiles.

## Configure custom severity profile

To modify the severity of events or disable event notification:

Your user account must have any one of the following privileges: System admin (`sysadmin`), security admin (`secadmin`), or network admin (`netadmin`).

1. Use the `dir` command to view the list of available severity profiles in the `severity-profile://` partition.

```
OS10# dir severity-profile
Date (modified) Size (bytes) Name

2019-03-27T15:24:06Z 46741 default.xml
2019-04-01T11:22:33Z 456 custom.xml
```

2. Copy one of the available severity profiles to a remote host.

```
OS10# copy severity-profile://default.xml scp://username:password@a.b.c.d/dir-path/
mySevProf.xml
```

3. Modify the `.xml` file with changes as required.

**i** **NOTE:** When you modify the `xml` file, you must select one of the following severities:

- CRITICAL
- MAJOR
- MINOR
- WARNING
- INFORMATIONAL

If you want OS10 to generate the event, set the `Enable` flag to `true`. To turn off event notification, set the `Enable` flag to `false`.

If you enter invalid values, the `event severity-profile` command fails.

4. Copy the custom profile to the OS10 switch.

```
OS10# copy scp://username:password@a.b.c.d/dir-path/mySevProf.xml severity-profile://
mySevProf_1.xml
```

When you copy the custom profile, you must update the name of the custom profile. You cannot use the same name as the default profile (`default.xml`) or the active profile (`mySevProf.xml`).

5. Apply the custom severity profile on the switch.

```
OS10# event severity-profile mySevProf_1.xml
```

**i** **NOTE:** You must restart the switch for the changes to take effect.

6. Restart the switch.

```
OS10# reload
```

7. Use the `show event severity-profile` command to view the custom profile that is active.

```
OS10# show event severity-profile
Severity Profile Details

Currently Active : default
Active after restart : mySevProf_1.xml
```

## Delete custom severity profile

You can delete custom severity profiles that you no longer need. However, you cannot delete the default or active severity profile.

To delete a custom severity profile, use the `delete severity-profile://profile-name` command. For example:

```
OS10# delete severity-profile://mySevProf_1.xml
```

## System logging

You can change the system logging default settings using the severity level to control the type of system messages that log. The range of logging severities are:

- `log-emerg`—System is unstable.
- `log-alert`—Immediate action is needed.
- `log-crit`—Critical conditions
- `log-err`—Error conditions
- `log-warning`—Warning conditions
- `log-notice`—Normal, but significant conditions (default)
- `log-info`—Informational messages
- `log-debug`—Debug messages

**NOTE:** The system rate-limits syslog messages to a maximum of 10 per second on the console.

- Enter the minimum severity level for logging to the console in CONFIGURATION mode.

```
logging console severity
```

- Enter the minimum severity level for logging to the system log file in CONFIGURATION mode.

```
logging log-file severity
```

- Enter the minimum severity level for logging to terminal lines in CONFIGURATION mode.

```
logging monitor severity
```

- Configure the remote syslog server in CONFIGURATION mode.

```
logging server {ipv4-address | ipv6-address} [tcp | udp | tls] [port-number]
[severity severity-level] [vrf {management | vrf-name}]
```

## Disable system logging

You can use the `no` version of any logging command to disable system logging.

- Disable console logging, and reset the minimum logging severity to the default in CONFIGURATION mode.

```
no logging console severity
```

- Disable log-file logging, and reset the minimum logging severity to the default in CONFIGURATION mode.

```
no logging log-file severity
```

- Disable monitor logging, and reset the minimum logging severity to the default in CONFIGURATION mode.

```
no logging monitor severity
```

- Disable server logging, and reset the minimum logging severity to the default in CONFIGURATION mode.

```
no logging server severity
```

- Reenable any logging command in CONFIGURATION mode.

```
no logging enable
```

### Enable server logging for log notice

```
OS10(config)# logging server 10.11.86.139 severity log-notice
```

## System logging over TLS

To provide enhanced security and privacy in the logged system messages sent to a syslog server, you can use the Transport Layer Security (TLS) protocol. System logging over TLS encrypts communication between an OS10 switch and a configured remote logging sever, including:

- Performing mutual authentication of a client and server using public key infrastructure (PKI) certificates
- Encrypting the entire authentication exchange so that neither user ID nor password is vulnerable to discovery, and that the data is not modified during transport

### Configuration notes

System logging over TLS requires that:

- X.509v3 PKI certificates are configured on a certification authority (CA) and installed on the switch. Both the switch and syslog server exchange a public key in a signed X.509v3 certificate to authenticate each other. For more information, see [X.509v3 certificates](#).
- You configure a security profile for system logging as described in [Security profiles](#).

### Configure system logging over TLS

1. Copy an X.509v3 certificate created by a CA server using a secure method, such as SCP or HTTPS, as described in [Manage CA certificates](#). Then install the trusted CA certificate in EXEC mode.

```
crypto ca-cert install ca-cert-filepath [filename]
```

- *ca-cert-filepath* specifies the local path to the downloaded certificate; for example, `home://CAcert.pem` or `usb://CA-cert.pem`.
  - *filename* specifies an optional filename that the certificate is stored under in the OS10 trust-store directory. Enter the filename in the *filename.crt* format.
2. Obtain an X.509v3 host certificate from the CA server as described in [Request and install host certificates](#):
    - a. Create a private key and generate a certificate signing request for the switch.
    - b. Copy the CSR file to the CA server for signing.
    - c. Copy the CA-signed certificate to the home directory on the switch.
    - d. Install the host certificate:

```
crypto cert install cert-file home://cert-filepath key-file {key-path | private}
[password passphrase] [fips]
```

When you install an X.509v3 certificate-key pair:

- Both take the name of the certificate. For example, if you install a certificate using:

```
OS10# crypto cert install cert-file home://Dell_host1.pem key-file home://abcd.key
```

The certificate-key pair is installed as `Dell_host1.pem` and `Dell_host1.key`. In configuration commands, refer to the pair as `Dell_host1`. When you configure a security profile, you would enter `Dell_host1` in the `certificate certificate-name` command.

- For security reasons, because the key file contains private key information, it copied to a secure location in the OS10 file system and deleted from its original location specified in the `key-file key-path` parameter.

**i NOTE:** `fips` installs the certificate-key pair as FIPS-compliant. Enter `fips` to install a certificate-key pair that is used by a FIPS-aware application, such as Syslog over TLS. If you do not enter `fips`, the certificate-key pair is stored as a non-FIPS-compliant pair.



You determine if the certificate-key pair is generated as FIPS-compliant. Do not use FIPS-compliant certificate-key pairs outside of FIPS mode. When FIPS mode is enabled, you can still generate CSRs for non-FIPS certificates for use with non-FIPS applications. Be sure to install these certificates as non-FIPS with the `crypto cert install` command.

3. Configure a security profile for system logging over TLS using an X.509v3 certificate.

- a. Create a Syslog security profile in CONFIGURATION mode. See [Security profiles](#) for more information.

```
crypto security-profile profile-name
```

- b. Assign an X.509v3 certificate and private key pair to the security profile in SECURITY-PROFILE mode. For `certificate-name`, enter the name of the certificate-key pair as it appears in the `show crypto certs` output without the `.pem` extension.

```
certificate certificate-name
exit
```

- c. Create a system logging-specific profile in CONFIGURATION mode.

```
logging security-profile profile-name
```

Where `profile-name` is the name of the Syslog security profile created in Step 2a with the `crypto security-profile profile-name` command. You cannot delete a crypto server profile if it is configured for a logging server.

If you reconfigure `crypto security profile-name`, configured Syslog TLS servers are automatically updated to use the new certificate-key pair used by the new profile.

If you reconfigure the certificate assigned to a crypto security profile, Syslog TLS servers are automatically updated to use new certificate-key pair.

If you delete a certificate from a configured crypto security profile, system logging over TLS fails. A host certificate is required for the protocol exchange with an external device.

4. Configure a remote TLS server to receive system messages in CONFIGURATION mode.

```
logging server {ipv4-address | ipv6-address} tls [port-number]
[severity severity-level] [vrf {management | vrf-name}]
```

### Example: Configure Syslog over TLS

```
OS10# copy tftp://CAadmin:secret@172.11.222.1/cacert.pem home://cacert.pem

OS10# crypto ca-cert install home://cacert.pem
Processing certificate ...
Installed Root CA certificate
CommonName = Certificate Authority CA
IssuerName = Certificate Authority CA

OS10# show crypto ca-certs

| Locally installed certificates |

cacert.crt

OS10# crypto cert generate request cert-file home://clientreq.pem key-file home://
clientkey.pem cname "Top of Rack 6" altname "IP:10.0.0.6 DNS:tor6.dell.com" email
admin@dell.com organization "Dell EMC" orgunit Networking locality "Santa Clara" state
California country US length 2048
Processing certificate ...
Successfully created CSR file /home/admin/clientreq.pem and key

OS10# copy home://clientreq.pem scp://CAadmin:secret@172.11.222.1/clientreq.pem

OS10# copy scp://CAadmin:secret@172.11.222.1/clientcert.pem home://clientcert.pem
OS10# copy scp://CAadmin:secret@172.11.222.1/clientkey.pem home://clientkey.pem

OS10# crypto cert install cert-file home://clientcert.pem key-file home://clientkey.pem
Processing certificate ...
Certificate and keys were successfully installed as "clientcert.crt" that may be used in
a security profile. CN = 10.0.0.6

OS10# show crypto cert
```

```

| Installed non-FIPS certificates |

clientcert.crt

| Installed FIPS certificates |

OS10(config)# crypto security-profile dellprofile
OS10(config-sec-profile)# certificate clientcert
OS10(config-sec-profile)# exit
OS10(config)# logging security-profile dellprofile
OS10(config)# logging server 10.11.86.139 tls
OS10(config)# do show running-configuration logging
!
logging security-profile dellprofile
logging server 10.11.86.139 tls 514

```

## View system logs

The system log-file contains system event and alarm logs.

Use the `show trace` command to view the current syslog file. All event and alarm information is sent to the syslog server, if one is configured.

The `show logging` command accepts the following parameters:

- `log-file` — Provides a detailed log including both software and hardware saved to a file.
- `process-names` — Provides a list of all processes currently running which can be filtered based on the process-name.

### View logging log-file

```

OS10# show logging log-file
Jun 1 05:01:46 %Node.1-Unit.1:PRI:OS10 %log-notice:ETL_SERVICE_UP: ETL service
is up
Jun 1 05:02:06 %Node.1-Unit.1:PRI:OS10 %log-notice:EQM_UNIT_DETECTED: Unit pres
ent:Unit 1#003
Jun 1 05:02:09 %Node.1-Unit.1:PRI:OS10 %log-notice:EQM_PSU_DETECTED: Power Supp
ly Unit present:PSU 1#003
Jun 1 05:02:09 %Node.1-Unit.1:PRI:OS10 %log-notice:EQM_PSU_DETECTED: Power Supp
ly Unit present:PSU 2#003
Jun 1 05:02:09 %Node.1-Unit.1:PRI:OS10 %log-notice:EQM_FAN_TRAY_DETECTED: Fan t
ray present:Fan tray 1#003
Jun 1 05:02:09 %Node.1-Unit.1:PRI:OS10 %log-notice:EQM_FAN_TRAY_DETECTED: Fan t
ray present:Fan tray 2#003
Jun 1 05:02:09 %Node.1-Unit.1:PRI:OS10 %log-notice:EQM_FAN_TRAY_DETECTED: Fan t
ray present:Fan tray 3#003
Jun 1 05:02:09 %Node.1-Unit.1:PRI:OS10 %log-crit:EQM_FAN_AIRFLOW_MISMATCH: MAJO
R ALARM: FAN AIRFLOW MISMATCH: SET: One or more fans have mismatching or unknown
airflow directions#003
Jun 1 05:02:10 %Node.1-Unit.1:PRI:OS10 %log-notice:NDM_SERVICE_UP: NDM Service
Ready!
Jun 1 05:02:10 %Node.1-Unit.1:PRI:OS10 %log-notice:SU_SERVICE_UP: Software upgr
ade service is up:software upgrade service up
--More--

```

### View logging process names

```

OS10# show logging process-names
dn_alm
dn_app_vlt
dn_app_vrrp
dn_bgp
dn_dot1x
dn_eqa
dn_eqm
dn_eth_drv
dn_etl
dn_i3
dn_ifm

```

```
dn_infra_afs
dn_issu
dn_l2_services
dn_l2_services_
dn_l2_services_
dn_l2_services_
dn_l2_services_
dn_l3_core_serv
dn_l3_service
dn_lacp
dn_lldp
dn_mgmt_entity_
--More--
```

## Environmental monitoring

Monitors the hardware environment to detect temperature, CPU, and memory utilization.

### View environment

```
OS10# show environment

Unit State Temperature Voltage

1 up 42

Thermal sensors
Unit Sensor-Id Sensor-name Temperature

1 1 T2 temp sensor 28
1 2 system-NIC temp sensor 25
1 3 Ambient temp sensor 24
1 4 NPU temp sensor 40

```

## Link-bundle monitoring

Monitoring link aggregation group (LAG) bundles allows the traffic distribution amounts in a link to look for unfair distribution at any given time. A threshold of 60% is an acceptable amount of traffic on a member link.

Links are monitored in 15-second intervals for three consecutive instances. Any deviation within that time sends syslog and an alarm event generates. When the deviation clears, another syslog sends and a clear alarm event generates.

Link-bundle utilization calculates the total bandwidth of all links divided by the total bytes-per-second of all links. If you enable monitoring, the utilization calculation performs when the utilization of the link-bundle (not a link within a bundle) exceeds 60%.

### Configure Threshold level for link-bundle monitoring

```
OS10(config)# link-bundle-trigger-threshold 10
```

### View link-bundle monitoring threshold configuration

```
OS10(config)# do show running-configuration
link-bundle-trigger-threshold 10
!
...
```

### Show link-bundle utilization

```
OS10(config)# do show link-bundle-utilization

Link-bundle trigger threshold - 10
```

# Alarm commands

## alarm acknowledge

Acknowledges an active alarm.

<b>Syntax</b>	<code>alarm acknowledge <i>sequence-number</i></code>
<b>Parameters</b>	<ul style="list-style-type: none"><li><i>sequence-number</i> — Acknowledge the alarm corresponding to the sequence number.</li></ul>
<b>Default</b>	Not configured
<b>Command Mode</b>	EXEC
<b>Usage Information</b>	Use the <code>show alarm</code> command to view all active alarms. Use active alarm sequence numbers to acknowledge specific alarms.
<b>Example</b>	<pre>OS10# alarm acknowledge 1</pre>
<b>Supported Releases</b>	10.4.3 or later

## event severity-profile

Configures a severity profile to change the severity of events, or turn off event notifications.

<b>Syntax</b>	<code>event severity-profile {default   <i>profile-name</i>}</code>
<b>Parameters</b>	<i>profile-name</i> —Name of the custom severity profile, a maximum of 64 characters. The file extension, <code>.xml</code> is optional.
<b>Default</b>	Default.xml
<b>Command Mode</b>	EXEC
<b>Usage Information</b>	Configures a severity profile to change the characteristics of events. If you configure a custom profile, the profile applies on top of the default profile. Restart the system for the changes to take effect. The system restart ensures that the existing stateful events are tagged appropriately based on the newly applied severity profile. Severity profiles are stored in the <code>severity-profile://</code> partition. This partition includes a factory default severity profile, <code>default.xml</code> . You cannot edit or delete the default and active severity profiles.
<b>Example</b>	<pre>OS10# event severity-profile MySevPro_1 %Notice: Severity profile will be active after system restart</pre>
<b>Supported Releases</b>	10.5.0 or later

## show alarms

Displays all current active alarms in the system.

<b>Syntax</b>	<code>show alarms</code>
<b>Parameters</b>	None
<b>Default</b>	None
<b>Command Mode</b>	EXEC
<b>Usage Information</b>	None

## Example

```
OS10# show alarms

Sq No Severity Name
Timestamp ----- -----

 7563 critical EQM_MORE_PSU_FAULT Fri Jul 26
19:26:16 2019 /pus/1
 7566 warning EQM_TML_MINOR_CROSSED Fri Jul 26
19:30:22 2019 /pus/1
 7569 information L2_SERV_LACP_CMS_CPS_SEND_FAIL Fri Jul 26
19:55:40 2019 /pus/1
```

**Supported Releases** 10.2.0E or later

## show alarms acknowledged

Displays all acknowledged alarms.

**Syntax** show alarms acknowledged

**Parameters** None

**Default** None

**Command Mode** EXEC

**Usage Information** None

## Example

```
show alarms acknowledged

Sq No Severity Name
Timestamp ----- -----

100071 warning EQM_FAN_FAULT_MINOR Tue Jul 23 13:53:47
2019 /psu/1/fan/1
100072 critical EQM_FAN_FAULT_MAJOR Tue Jul 23 13:53:47
2019 /psu/1
```

**Supported Releases** 10.2.0E or later

## show alarms details

Displays details about active alarms.

**Syntax** show alarms details

**Parameters** None

**Default** None

**Command Mode** EXEC

**Usage Information** The output of the `show alarms details` command indicates if an alarm is acknowledged or not. If an alarm is not acknowledged, the `Acknowledged` field is set to `false` and the `Ack-time` value is empty. If an alarm is acknowledged, the `Acknowledged` field is set to `true` and the system displays the time the alarm was acknowledged.

## Example

**Alarm is not acknowledged:**

```
OS10# show alarms details
```

```
Active-alarm details - 732

Sequence Number: 732
Severity: critical
Source: /psu/2
Name: EQM_MORE_PSU_FAULT
Description: psu 2 is not working correctly
Raise-time: Mon Jul 29 06:12:30 2019
Ack-time:
New: true
Acknowledged: false

```

**Alarm is acknowledged:**

```
OS10# show alarms details

Active-alarm details - 732

Sequence Number: 732
Severity: critical
Source: /psu/2
Name: EQM_MORE_PSU_FAULT
Description: psu 2 is not working correctly
Raise-time: Mon Jul 29 06:12:30 2019
Ack-time: Mon Jul 29 06:16:35 2019
New: true
Acknowledged: true

```

**Supported Releases** 10.2.0E or later

## show alarms sequence

Displays information corresponding to the active alarm based on the sequence number that you specify.

**Syntax** `show alarms sequence sequence-number`

**Parameters**

- `sequence-number` — Enter the sequence number corresponding to the active alarm.

**Default** None

**Command Mode** EXEC

**Usage Information** Use the show alarms command to view all active alarms. Use an active alarm sequence number to view detailed information about that alarm.

**Example**

```
NOS# show alarms sequence 3
Active-alarm details - 1

Sequence Number: 3
Severity: major
Type: 1081375
Source: /psu/2
Name: EQM_MORE_PSU_FAULT
Description: psu 2 is not working correctly
Raise-time: Sun 10-07-2018 18:39:47
Ack-time:
State: raised

```

**Supported Releases** 10.4.3E or later

## show alarms severity

Displays all active alarms corresponding to a specific severity level.

**Syntax** `show alarms severity severity`

**Parameters** `severity` — Set the alarm severity:

- `critical` — Critical alarm severity.
- `major` — Major alarm severity.
- `minor` — Minor alarm severity.
- `warning` — Warning alarm severity.

**Default** Not configured

**Command Mode** EXEC

**Usage Information** None

**Example (Warning)**

```
OS10# show alarms severity warning
Active-alarm details - 1

Sequence Number: 5
Severity: warning
Type: 1081364
Source: Node.1-Unit.1
Name: EQM_THERMAL_WARN_CROSSED
Description:
Raise-time: Sat 10-06-2018 0:1:5
Ack-time: Sun 10-07-2018 20:39:47
New: true
State: raised
```

**Example (Critical)**

```
OS10# show alarms severity critical
Active-alarm details - 0

Sequence Number: 1
Severity: critical
Type: 1081367
Source: Node.1-Unit.1
Name: EQM_THERMAL_CRIT_CROSSED
Description:
Raise-time: Sat 10-06-2018 0:1:5
Ack-time: Sun 10-07-2018 20:39:47
New: true
State: raised
```

**Example (Minor)**

```
NOS# show alarms severity minor
Active-alarm details - 1

Sequence Number: 4
Severity: minor
Type: 1081375
Source: /psu/1
Name: EQM_MORE_PSU_FAULT
Description: psu 2 is not working correctly
Raise-time: Sun 10-07-2018 18:39:47
Ack-time: Sun 10-07-2018 20:39:47
New: true
State: acknowledged

```

**Supported Releases** 10.4.3 or later

## show alarms summary

Displays the summary of all active alarms.

**Syntax** show alarms summary

**Parameters** None

**Default** Not configured

**Command Mode** EXEC

**Usage Information** None

### Example

```
OS10# show alarms summary
Active-alarm Summary

Total-count: 2
Critical-count: 0
Major-count: 1
Minor-count: 1
Warning-count: 0

```

**Supported Releases** 10.2.0E or later

## show event history

Displays the history of all events with the latest at the top of the output.

**Syntax** show event history [summary] [reverse] [severity *severity-name*] [details] [sequence *sequence-number*]

- Parameters**
- **summary**—Displays a summary of the event history.
  - **reverse**—Displays a summary of the event history from the beginning, with the oldest event listed at the top of the output.
  - **severity**—Displays event history for a given severity: CRITICAL, MAJOR, MINOR, WARNING, INFORMATIONAL.
  - **details**—Displays event history in details.
  - **sequence *sequence-number***—Displays event details for a given sequence number.

**Default** None

**Command Mode** EXEC

**Usage Information** Displays event logs in the OS10 switch.

### Example

```
OS10# show event history
Sq No State Name Timestamp Source

6 Cleared EQM_FANTRAY_FAULT Sun 10-07-2018 22:39:50 /fantray/3
5 Ack EQM_MORE_PSU_FAULT Sun 10-07-2018 20:39:49 /psu/1
4 Raised EQM_MORE_PSU_FAULT Sun 10-07-2018 18:39:47 /psu/1
3 Raised EQM_MORE_PSU_FAULT Sun 10-07-2018 18:39:44 /psu/2
2 Raised EQM_FANTRAY_FAULT Sun 10-07-2018 16:39:42 /fantray/3
1 Stateless SYSTEM_REBOOT Sun 10-07-2018 15:39:41 -
```

### Example (severity)

```
OS10# show event history severity critical
Sq No State Name Timestamp Source

4 Raised EQM_MORE_PSU_FAULT Sun 10-07-2018 18:39:47 /psu/1
```



```

3 Raised EQM_MORE_PSU_FAULT Sun 10-07-2018 18:39:44 /psu/2
2 Raised EQM_FANTRAY_FAULT Sun 10-07-2018 16:39:42 /fantray/3

```

**Example  
(reverse)**

```

OS10# show event history reverse
Sq No State Name Timestamp Source

1 Stateless SYSTEM_REBOOT Sun 10-07-2018 15:39:41 -
2 Raised EQM_FANTRAY_FAULT Sun 10-07-2018 16:39:42 /fantray/3
3 Raised EQM_MORE_PSU_FAULT Sun 10-07-2018 18:39:44 /psu/2
4 Raised EQM_MORE_PSU_FAULT Sun 10-07-2018 18:39:47 /psu/1
5 Ack EQM_MORE_PSU_FAULT Sun 10-07-2018 20:39:49 /psu/1
6 Cleared EQM_FANTRAY_FAULT Sun 10-07-2018 22:39:50 /fantray/3

```

**Example  
(sequence)**

```

OS10# show event history sequence 2
Event History Details - 2

Sequence Number: 2
Severity: informational
Name: IFM_ASTATE_UP
Description: Dummy Event
Timestamp: Fri May 03 18:13:07 2019
Source: -
State: stateless

```

**Example (details)**

```

OS10# show event history details
Event History Details - 2

Sequence Number: 2
Severity: informational
Name: IFM_ASTATE_UP
Description: Dummy Event
Timestamp: Fri May 03 18:13:07 2019
Source: -
State: stateless

Event History Details - 1

Sequence Number: 1
Severity: informational
Name: IFM_ASTATE_UP
Description: Dummy Event
Timestamp: Fri May 03 18:13:05 2019
Source: -
State: stateless

```

**Example  
(summary)**

If the sequence number counter is not rolled over, the Last Rollover Time value is empty.

```

OS10# show event history summary
Event History Summary

Total-count: 583
Raised-count: 4
Ack-count: 0
Cleared-count: 0
Stateless-count: 579
Next Sequence Number: 584
Last Rollover Time:

```

**Supported  
Releases**

10.5.0 or later

## show event severity-profile

Displays the active severity profile and the profile that becomes active after a system restart.

**Syntax** `show event severity-profile`

**Parameters** None

**Default** None

**Command Mode** EXEC

**Usage Information** None

### Example

```
OS10# show event severity-profile
Severity Profile Details

Currently Active : default
Active after restart : mySevProf.xml
```

**Supported Releases** 10.5.0 or later

## Logging commands

### clear logging

Clears messages in the logging buffer.

**Syntax** `clear logging log-file`

**Parameters** None

**Default** Not configured

**Command Mode** EXEC

**Usage Information** Supported on the MX9116n and MX5108n switches in Full Switch mode starting in release 10.4.0E(R3S). Also supported in SmartFabric mode starting in release 10.5.0.1.

### Example

```
OS10# clear logging log-file

Proceed to clear the log file [confirm yes/no(default)]:
```

**Supported Releases** 10.2.0E or later

### logging console

Disables, enables, or configures the minimum severity level for logging to the console.

**Syntax** `logging console {disable | enable | severity}`

**Parameters** *severity*—Set the minimum logging severity level:

- `log-emerg`—Set to unusable.
- `log-alert`—Set to immediate action is needed.
- `log-crit`—Set to critical conditions.
- `log-err`—Set to error conditions.
- `log-warning`—Set to warning conditions.
- `log-notice`—Set to normal but significant conditions, the default.

- `log-info`—Set to informational messages.
- `log-debug`—Set to debug messages.

**Default** Log-notice

**Command Mode** CONFIGURATION

**Usage Information** Supported on the MX9116n and MX5108n switches in Full Switch mode starting in release 10.4.0E(R3S). Also supported in SmartFabric mode starting in release 10.5.0.1.

To set the severity to the default level, use the `no logging console severity` command. The default severity level is `log-notice`.

 **NOTE:** The system rate-limits syslog messages to a maximum of 10 per second on the console.

**Example**

```
OS10(config)# logging console disable
```

**Example (Enable)**

```
OS10(config)# logging console enable
```

**Example (Severity)**

```
OS10(config)# logging console severity log-warning
```

**Supported Releases** 10.2.0E or later

## logging enable

Enables system logging.

**Syntax** `logging enable`

**Parameters** None

**Default** Enabled

**Command Mode** CONFIGURATION

**Usage Information** Supported on the MX9116n and MX5108n switches in Full Switch mode starting in release 10.4.0E(R3S). Also supported in SmartFabric mode starting in release 10.5.0.1.

The `no` version of this command disables all logging.

**Example**

```
OS10(config)# logging enable
```

**Supported Releases** 10.2.0E or later

## logging log-file

Disables, enables, or sets the minimum severity level for logging to the log file.

**Syntax** `logging log-file {disable | enable | severity}`

**Parameters** `severity` — Set the minimum logging severity level:

- `log-emerg` — Set the system as unusable.
- `log-alert` — Set to immediate action is needed.
- `log-crit` — Set to critical conditions.
- `log-err` — Set to error conditions.
- `log-warning` — Set to warning conditions.
- `log-notice` — Set to normal but significant conditions, the default.

- `log-info` — Set to informational messages.
- `log-debug` — Set to debug messages.

**Default** Log-notice

**Command Mode** CONFIGURATION

**Usage Information** To reset the log-file severity to the default level, use the `no logging log-file severity` command. The default severity level is `log-notice`.

Supported on the MX9116n and MX5108n switches in Full Switch mode starting in release 10.4.0E(R3S). Also supported in SmartFabric mode starting in release 10.5.0.1.

**Example**

```
OS10(config)# logging log-file disable
```

**Example (Enable)**

```
OS10(config)# logging log-file enable
```

**Example (Severity)**

```
OS10(config)# logging log-file severity log-notice
```

**Supported Releases** 10.2.0E or later

## logging monitor

Set the minimum severity level for logging to the terminal lines.

**Syntax** `logging monitor severity severity-level`

**Parameters** `severity-level` — Set the minimum logging severity level:

- `log-emerg` — Set the system as unusable.
- `log-alert` — Set to immediate action is needed.
- `log-crit` — Set to critical conditions.
- `log-err` — Set to error conditions.
- `log-warning` — Set to warning conditions.
- `log-notice` — Set to normal but significant conditions, the default.
- `log-info` — Set to informational messages.
- `log-debug` — Set to debug messages.

**Default** Log-notice

**Command Mode** CONFIGURATION

**Usage Information** To reset the monitor severity to the default level, use the `no logging monitor severity` command. The default severity level is `log-notice`.

Supported on the MX9116n and MX5108n switches in Full Switch mode starting in release 10.4.0E(R3S). Also supported in SmartFabric mode starting in release 10.5.0.1.

**Example**

```
OS10(config)# logging monitor severity log-info
```

**Supported Releases** 10.2.0E or later

## logging security-profile

Creates a TLS security profile for system logging.

**Syntax** `logging security-profile profile-name`

<b>Parameters</b>	<i>profile-name</i> — Enter the name of the Syslog over TLS security profile created with the <code>crypto security-profile <i>profile-name</i></code> command; a maximum of 32 characters.
<b>Default</b>	Not configured
<b>Command mode</b>	CONFIGURATION
<b>Usage information</b>	Use this command to specify the configured crypto security profile to use to send system messages to a remote server over TLS. TLS requires an X.509v3 certificate-key pair installed on the switch.
<b>Example</b>	<pre>OS10(config)# logging security-profile prof1</pre>
<b>Supported releases</b>	10.5.0 or later

## logging server

Configures a remote syslog server.

<b>Syntax</b>	<code>logging server {<i>ipv4-address</i>   <i>ipv6-address</i>} [tcp   udp   tls] [<i>port-number</i>] [<i>severity severity-level</i>] [<i>vrf {management   vrf-name}</i>]</code>
<b>Parameters</b>	<ul style="list-style-type: none"> <li>• <i>ipv4-address</i>   <i>ipv6-address</i> — (Optional) Enter the IPv4 or IPv6 address of the logging server.</li> <li>• <code>tcp   udp   tls <i>port-number</i></code> — (Optional) Send syslog messages using TCP, UDP, or TLS transport to a specified port on a remote logging server, from 1 to 65535.</li> <li>• <i>severity-level</i> — (Optional) Set the logging threshold severity: <ul style="list-style-type: none"> <li>◦ <code>log-emerg</code> — System is unusable.</li> <li>◦ <code>log-alert</code> — Immediate action is needed.</li> <li>◦ <code>log-crit</code> — Critical conditions</li> <li>◦ <code>log-err</code> — Error conditions</li> <li>◦ <code>log-warning</code> — Warning conditions</li> <li>◦ <code>log-notice</code> — Normal, but significant conditions (default)</li> <li>◦ <code>log-info</code> — Informational messages</li> <li>◦ <code>log-debug</code> — Debug messages</li> </ul> </li> <li>• <code>vrf {management   <i>vrf-name</i>}</code> — (Optional) Configure the logging server for the management or a specified VRF instance.</li> </ul>
<b>Defaults</b>	System logging to a remote server is not configured. When configured, system messages are sent over UDP to port 514 on a remote logging server by default. System messages of severity-level <code>log-notice</code> and lower are sent.
<b>Command Mode</b>	CONFIGURATION
<b>Usage Information</b>	<p>Use the <code>logging server</code> command to forward log messages to syslog servers for storage.</p> <p>The <code>tls</code> option requires that a valid security profile is already configured with the <code>logging security-profile</code> command. If you delete the logging security profile, system messages are sent using UDP (default) to a remote syslog server.</p> <p>Supported on the MX9116n and MX5108n switches in Full Switch mode starting in release 10.5.0.0. Also supported in SmartFabric mode starting in release 10.5.0.1.</p> <p>The <code>no</code> version of this command deletes the syslog server.</p>
<b>Example</b>	<pre>OS10(config)# logging server 10.11.86.139 severity log-info</pre> <pre>OS10(config)# logging server fda8:6c3:ce53:a890::2 tcp 1468</pre> <pre>OS10(config)# logging server 10.11.86.139 vrf management severity log-debug</pre>

**Supported Releases** 10.5.0 or later

## show logging

Displays system logging messages by log file, process-names, or summary.

**Syntax** `show logging {log-file [process-name | line-numbers] | process-names}`

**Parameters**

- *process-name* — (Optional) Enter the process-name to use as a filter in syslog messages.
- *line-numbers* — (Optional) Enter the number of lines to include in the logging messages, from 1 to 65535.

**Default** None

**Command Mode** EXEC

**Usage Information** The output from this command is the `/var/log/eventlog` file.

Supported on the MX9116n and MX5108n switches in Full Switch mode starting in release 10.4.0E(R3S). Also supported in SmartFabric mode starting in release 10.5.0.1.

### Example (Log File)

```
OS10# show logging log-file process-name dn_qos
```

### Example (Process-Names)

```
OS10# show logging process-names
dn_pas_svc
dn_system_mgmt_
dn_env_tmpctl_
dn_pm
dn_eth_drv
dn_etl
dn_eqa
dn_alm
dn_eqm
dn_issu
dn_swupgrade
dn_ifm
dn_ppm
dn_l2_services
dn_dotlx
dn_l3_core_serv
dn_policy
dn_qos
dn_switch_res_m
dn_ospfv3
dn_lacp
dn_i3
dn_supportassis
--More--
```

**Supported Releases** 10.2.0E or later

## show trace

Displays trace messages.

**Syntax** `show trace [number-lines]`

**Parameters** *number-lines* — (Optional) Enter the number of lines to include in log messages, from 1 to 65535.

**Default** Enabled

**Command Mode** EXEC

## Usage Information

The output from this command is the `/var/log/syslog` file.

Supported on the MX9116n and MX5108n switches in Full Switch mode starting in release 10.4.0E(R3S). Also supported in SmartFabric mode starting in release 10.5.0.1.

## Example

```
OS10# show trace
May 23 17:10:03 OS10 base_nas: [NETLINK:NH-
EVENT]:ds_api_linux_neigh.c:nl_to_nei
gh_info:109, Operation:Add-NH family:IPv4(2) flags:0x0 state:Failed(32)
if-idx:4
May 23 17:10:03 OS10 base_nas: [NETLINK:NH-
EVENT]:ds_api_linux_neigh.c:nl_to_nei
gh_info:120, NextHop IP:192.168.10.1
May 23 17:10:04 OS10 base_nas: [NDI:NDI-SAI], Values are invalid - can't
be conv
erted to SAI types (func:2359304)
May 23 17:10:04 OS10 base_nas: [NDI:NDI-SAI], Hash value - 20 can't be
converted
May 23 17:10:04 OS10 base_nas: [NDI:NDI-SAI], Values are invalid - can't
be conv
erted to SAI types (func:2359305)
May 23 17:10:04 OS10 base_nas: [NDI:NDI-SAI], Values are invalid - can't
be conv
erted to SAI types (func:2359311)
May 23 17:10:04 OS10 base_nas: [NDI:NDI-SAI], Hash value - 20 can't be
converted
May 23 17:10:04 OS10 base_nas: [NDI:NDI-SAI], Values are invalid - can't
be conv
erted to SAI types (func:2359312)
May 23 17:10:04 OS10 base_nas: [NDI:NDI-SAI], Invalid operation type for
NDI (23
59344)
May 23 17:10:04 OS10 base_nas: [NDI:NDI-SAI], Invalid operation type for
NDI (23
59345)
May 23 17:10:04 OS10 base_nas: [NDI:NDI-SAI], Invalid operation type for
NDI (23
59346)
May 23 17:10:04 OS10 base_nas: [NDI:NDI-SAI], Invalid operation type for
NDI (23
59319)
May 23 17:10:08 OS10 base_nas: [NETLINK:NH-
EVENT]:ds_api_linux_neigh.c:nl_to_nei
--More--
```

## Supported Releases

10.2.0E or later

# Log into OS10 device

Linux shell access is available for troubleshooting and diagnostic purposes only. Use `linuxadmin` for both the default user name and password. For security reasons, you must use the `system-user` command to change the default `linuxadmin` password from the command-line interface.

If you log in to the Linux shell before you change the password from the CLI, you are prompted to change password in the Linux shell. If you change the password in the Linux shell, configure the same password from the CLI to avoid inconsistent behavior. To save the new password for future logins, enter the `write memory` command.

**CAUTION: Changing the system state from the Linux shell can result in undesired and unpredictable system behavior. Only use Linux shell commands to display system state and variables, or as instructed by Dell EMC Support.**

```
OS10 login: linuxadmin
Password: linuxadmin >> only for first-time login
You are required to change your password immediately (root enforced)
Changing password for linuxadmin.
(current) UNIX password: linuxadmin
```





### Where can I find additional installation information for my specific device?

See the *Setup Guide* shipped with your device or the platform-specific *Installation Guide* on the Dell EMC Support page at [dell.com/support](http://dell.com/support).

## Hardware

### What are the default console settings for ON-Series devices?

- Set the data rate to 115200 baud
- Set the data format to 8 bits, stop bits to 1, and no parity
- Set flow control to none

### How do I view the hardware inventory?

Use the `show inventory` command to view complete system inventory.

### How do I view the process-related information?

Use the `show processes node-id node-id-number [pid process-id]` command to view the process CPU utilization information.

## Configuration

### How do I enter CONFIGURATION mode?

Use the `configure terminal` command to change from EXEC mode to CONFIGURATION mode.

### I made changes to the running configuration file but the updates are not showing. How do I view my changes?

Use the `show running-configuration` command to view changes that you have made to the running-configuration file. Here are the differences between the available configuration files:

- startup-configuration contains the configuration applied at device startup
- running-configuration contains the current configuration of the device
- candidate-configuration is an intermediate temporary buffer that stores configuration changes prior to applying them to the running-configuration

## Security

### How do I add new users?

Use the `username` commands to add new users. Use the `show users` command to view a list of current users.

### How do I view RADIUS transactions to troubleshoot problems?

Use the `debug radius` command.

### How do I view the current DHCP binding information?

Use the `show ip dhcp binding` command.

## Layer 2

### How do I view the VLAN running configuration?

Use the `show vlan` command to view all configured VLANs.

## Layer 3

### How do I view IPv6 interface information?

Use the `show ipv6 route summary` command.

### How do I view summary information for all IP routes?

Use the `show running-configuration` command.

#### **How do I view summary information for the OSPF database?**

Use the `show ip ospf database` command.

#### **How do I view configuration of OSPF neighbors connected to the local router?**

Use the `show ip ospf neighbor` command.

## System management

#### **How can I view the current interface configuration?**

Use the `show running-configuration` command to view all currently configured interfaces.

#### **How can I view a list of all system devices?**

Use the `show inventory` command to view a complete list.

#### **How can I view the software version?**

Use the `show version` command to view the currently running software version.

## Access control lists

#### **How do I setup filters to deny or permit packets from an IPv4 or IPv6 address?**

Use the `deny` or `permit` commands to create ACL filters.

#### **How do I clear access-list counters?**

Use the `clear ip access-list counters`, `clear ipv6 access-list counters`, or `clear mac access-list counters` commands.

#### **How do I setup filters to automatically assign sequencer numbers for specific addresses?**

Use the `seq deny` or `seq permit` commands for specific packet filtering.

#### **How do I view access-list and access-group information?**

Use the `show {ip | mac | ipv6} access-group` and `show {ip | mac | ipv6} access-list` commands.

## Quality of service

#### **What are the QoS error messages?**

Flow control error messages:

- `Error: priority-flow-control mode is on, disable pfc mode to enable LLFC`
- `% Warning: Make sure all qos-groups are matched in a single class in attached policy-map`

Priority flow control mode error message:

`% Error: LLFC flowcontrol is on, disable LLFC to enable PFC`

PFC shared-buffer size error message:

`% Error: Hardware update failed.`

Pause error message:

`% Error: Buffer-size should be greater than Pause threshold and Pause threshold should be greater than equal to Resume threshold.`

PFC cost of service error messages:

- `% Error: Not enough buffers are available, to enable system-qos wide pause for all pfc-cos values in the policymap`
- `% Error: Not enough buffers are available, to enable system-qos wide pause for the pfc-cos values in the policymap`

- % Error: Not enough buffers are available, to enable pause for all pfc-cos values in the policymap for this interface
- % Warning: Not enough buffers are available, for lossy traffic. Expect lossy traffic drops, else reconfigure the pause buffers

## Monitoring

### **How can I check if SupportAssist is enabled?**

Use the `show support-assist status` command to view current configuration information.

### **How can I view a list of alarms?**

Use the `show alarms details` to view a list of all system alarms.

### **How do I enable or disable system logging?**

Use the `logging enable` command or the `logging disable` command.

### **How do I view system logging messages?**

Use the `show logging` command to view messages by log file or process name.

## Support resources

The Dell EMC Support site provides a range of documents and tools to assist you with effectively using Dell EMC devices. Through the support site you can obtain technical information regarding Dell EMC products, access software upgrades and patches, download available management software, and manage your open cases. The Dell EMC support site provides integrated, secure access to these services.

To access the Dell EMC Support site, go to [www.dell.com/support/](http://www.dell.com/support/). To display information in your language, scroll down to the bottom of the page and select your country from the drop-down menu.

- To obtain product-specific information, enter the 7-character service tag or 11-digit express service code of your switch and click **Submit**.

To view the service tag or express service code, pull out the luggage tag on the chassis or enter the `show chassis` command from the CLI.

- To receive additional kinds of technical support, click **Contact Us**, then click **Technical Support**.

To access system documentation, see [www.dell.com/manuals/](http://www.dell.com/manuals/).

To search for drivers and downloads, see [www.dell.com/drivers/](http://www.dell.com/drivers/).

To participate in Dell EMC community blogs and forums, see [www.dell.com/community](http://www.dell.com/community).

# Index

## B

bgp unnumbered [1071](#)