

Operation Guide

ECOSYS PA4500cx

ECOSYS PA4000cx

ECOSYS PA3500cx

2023.6
2Z1KDENEN000



Contents

1	Please Read First	1
	Preface	2
	Machine Features	3
	Optimize your office workflow	3
	Save energy and cost	4
	Strengthen security	5
	Use functions more efficiently	7
	Guides Provided with the Machine	8
	About the Operation Guide (this Guide)	10
	Structure of the guide	10
	Conventions Used in This Guide	11
	Notice	15
	Safety Conventions in This Guide	15
	Environment	16
	Precautions for Use	17
	Compliance and Conformity	17
	Security Precautions when Using Wireless LAN (If equipped)	18
	Limited Use of This Product (If equipped)	19
	Legal and Safety Information	20
	Energy Saving Control Function	22
	Automatic 2-Sided Print Function	22
	Resource Saving - Paper	22
	Environmental benefits of "Power Management"	22
	ENERGY STAR Program	23
2	Installing and Setting up the Machine	24
	Part Names (Machine Exterior)	25
	Part Names (Connectors/Interior)	27
	Part Names (With Optional Equipments Attached)	29
	Connecting the Machine and Other Devices	32
	Connecting Cables	34
	Connecting LAN Cable	34
	Connecting USB Cable	35
	Connecting the Power Cable	35
	Power On/Off	36
	Power on	36
	Power off	36
	Using the Operation Panel	37
	Operation Panel Keys	37
	Adjusting the Operation Panel Angle	39
	Using the Operation Panel	40
	Help Screen	41
	Login/Logout	42
	Login	42
	Logout	43
	Default Settings of the Machine	44
	Setting Date and Time	44
	Network Setup	45
	Energy Saver function	57
	Installing Software	59
	Published Software (Windows)	59
	Installing Software in Windows	60
	Uninstalling Windows Software	67
	Installing Software on a Mac OS Computer	69

Checking the Counter	74
Additional Preparations for the Administrator	75
Administrator Privileges Overview	75
Log in as Machine Administrator or Administrator	75
Strengthening the Security	76
Command Center RX	78
Accessing Command Center RX	78
Changing Security Settings	80
Changing Device Information	81
SMTP and E-mail Settings	82
Creating a New Custom Box	84
Printing a Document Stored in a Custom Box	85

3 Preparation before Use 87

Load Paper	88
Loading Paper	88
Precaution for Loading Paper	90
Paper Specifications available in the Cassettes	91
Loading in the Cassettes	92
Paper Specifications available in the Multipurpose Tray	95
Loading Paper in the Multipurpose Tray	96
Specifying Paper Size and Media Type	99
Paper Stopper	103

4 Print from PC 104

Printer Driver Print Settings Screen	105
Displaying the Printer Driver Help	107
Changing the Default Printer Driver Settings (Windows 10)	108
Changing the Default Printer Driver Settings (Windows 11)	108
Changing the Default Printer Driver Settings (Windows 8.1, Windows Server 2012/R2, Windows Server 2016, Windows Server 2019)	108
Printing from PC	109
Printing on Standard Sized Paper	110
Printing on Non-standard Sized Paper	112
Printing with Universal Print	115
Printing on Banner Paper	118
Canceling Printing from a Computer	121
Printing from the Mobile Device	122
Printing by AirPrint	122
Printing by Mopria	122
Printing with Wi-Fi Direct	122
Printing Data Saved in the Printer	123
Specifying the Job Box from a Computer and Storing the Job	123
Printing Documents from Private Print Box	124
Deleting the Documents Stored in the Private Print Box	125
Printing Document from Stored Job Box	126
Deleting the Documents Stored in the Stored Job Box	127
Printing Document from Quick Copy Box	128
Deleting the Documents Stored in the Quick Copy Box	129
Printing Document from Proof and Hold Box	130
Deleting the Documents Stored in the Proof and Hold Box	131
Printing Documents from PIN Print Box	132
Deleting the Documents Stored in the PIN Print Box	133
Printing Document from Universal Print Box	134
Deleting the Documents Stored in the Universal Print Box	135
Configure the Job Box	136
Monitoring the Printer Status (Status Monitor)	137
Accessing the Status Monitor	137
Exiting the Status Monitor	137

	Quick View State	137
	Printing progress tab	138
	Paper tray status tab	138
	Toner Status Tab	139
	Alert tab	139
	Status Monitor Context Menu	140
	Status Monitor Notification Settings	141
5	Operation on the Machine	143
	Canceling Jobs	144
	Using Document Boxes	145
	What is Custom Box?	145
	What is Job Box?	145
	What is USB Drive Box?	145
	How to use Custom Box	146
	Create a New Box	146
	Editing a Box	149
	Delete the Custom Box.	150
	Storing Documents to a Custom Box	151
	Printing Document in a Custom Box	152
	Moving Documents in Custom Box	154
	Deleting Documents in a Custom Box	156
	Using Removable USB Drive	157
	Printing Documents Stored in Removable USB Drive	157
	Removing USB Drive	158
6	Using Various Functions	159
	About Functions Available on the Machine	160
	Custom Box (Print)	160
	USB Drive (Printing Documents)	161
	Quiet Mode	162
	Duplex	163
	EcoPrint	164
	File Name Entry	165
	Job Finish Notice	166
	Delete after Printed	167
	Encrypted PDF	168
	TIFF/JPEG size	169
	XPS print area setting	170
7	Status/Job Cancel	171
	Checking Job Status	172
	Displaying Status Screens	172
	Checking Job History	174
	Displaying Job History Screen	174
	Checking the Detailed Information of Histories	175
	Sending the Log History	175
	Device Information	176
	Checking the Remaining Amount of Toner (Paper/Supplies)	177
8	System Menu	178
	Operation Method	179
	System Menu Settings	180
	Report	185
	Report Print	185
	Job Log	187

Paper Settings	188
MP Tray Set.	188
Cassette 1 Set. to Cassette 5 Set. Settings	188
Media Type Set.	191
Reset Type Adj.	192
Paper Setup Msg	192
Print Settings	193
About reduced print settings	198
Network	200
Host Name	200
Wi-Fi Direct Set	201
Wi-Fi Settings	202
Wired Netwk. Set	208
ProtocolSettings	212
Primary Network	219
Ping	220
Restart Network	220
Remote Serv.Set.	221
Remote Operation	221
Optional Network	222
Wireless Network	222
Basic	224
Restart Network	224
Device Common	225
Language	225
Def. Screen(Box)	225
Date Setting	225
Buzzer	226
RAM Disk Setting	226
Format SSD	227
Format SD Card	227
Display Bright.	227
Error Handling	228
ColorToner Empty	228
Timer Setting	229
Disp. Status/Log	232
Keyboard Type	232
Bluetooth Set.	232
Low Toner Alert	232
Msg Banner Print	234
Remote Printing	234
Direct PRN (Web)	234
MaintenanceAlert	235
Security	236
Network Security	236
I/F Block Set.	238
Security Level	239
Data Security	240
Manual FW Update	241
Allowlisting	242
User/Job Account	243
Application	244
Adjust/Maint.	245

9	User Authentication and Accounting (User Login, Job Accounting)	247
	Overview of User Login Administration	248
	Managing the Job Account from PC	248

Enable User Login Administration	249
Setting User Login Administration	250
Authentication Security	250
Adding a User (Local User List)	252
Changing User Properties for Local Users (Admin, DeviceAdmin, PowerUser)	252
Changing User Properties for Network Users	254
Deleting a User	255
Managing the Users that Print on This Machine from a PC	256
Server Settings	257
Configure Network User Rights	259
Obtain NW User Property	260
ID Card Settings	261
PIN Login	263
Using User Login Administration	263
Overview of Job Accounting	264
Enabling Job Accounting	265
Job Accounting	266
Job Accounting (Local)	267
Adding an Account	267
Restricting the Use of the Machine	268
Editing an Account	269
Deleting an Account	269
Job Accounting for Printing	271
Configuring Job Accounting	273
Counting the Number of Pages Printed	273
Print Accounting Report	275
Using Job Accounting	276
Apply Limit	277
Unknown User Settings	278

10 Troubleshooting 280

Regular Maintenance	281
Cleaning	281
Cleaning Paper Transfer Unit	282
Replacing the Toner Container	283
Replacing the Waste Toner Box	287
Troubleshooting	289
Solving Malfunctions	289
Machine Operation Trouble	289
Printed Image Trouble	323
Color Printing Trouble	332
Remote Operation	338
Responding to Messages	341
Adjustment/Maintenance	356
Overview of Adjustment/Maintenance	356
Color Adjustment	357
Color Registration Procedure	357
Clearing Paper Jams	362
Jam Location Indicators	362
Remove any jammed paper in the Multipurpose Tray	364
Remove paper jams from Cassette 1 to Cassette 5	367
Remove the paper jammed in the Rear Cover 1 (Feed)	369
Remove the paper jammed in the Rear Cover 2	370
Remove the paper jammed in the Rear Cover 3	371
Remove the paper jammed in the Rear Cover 1	372
Remove any jammed paper in Duplex Unit	374

11	Appendix	376
	Optional Equipment	377
	Option configuration	377
	Overview of the Applications	380
	Starting Application Use	380
	Checking Details of Application	381
	Character Entry Method	382
	Key used	382
	Selecting Type of Characters	383
	Characters That Can be Entered Using the Numeric Keys	383
	About Paper	386
	Basic Paper Specifications	386
	Choosing the Appropriate Paper	387
	Special Paper	390
	Specifications	395
	Machine	395
	Printer Function	398
	Paper Feeder (550-sheet)	400
	Backing up your data	401
	Backing up your data using KYOCERA Net Viewer	401
	Backing up your data using Command Center RX	401
	Security Quick Setup Function List	402
	TLS	402
	Serverside Settings	402
	Clientside Settings	403
	IPv4 Settings (Wired Network)	404
	IPv4 Settings (Wireless Network)	405
	IPv6 Settings (Wired Network)	406
	IPv6 Settings (Wireless Network)	407
	Other Protocols: HTTP (Client)	408
	Other Protocols: SOAP	409
	Other Protocols: LDAP	410
	Send Protocols: SMTP (E-mail TX)	411
	Email: POP3 User Settings	412
	Print protocols	413
	Other Protocols	415
	TCP/IP: Bonjour Settings	417
	Network Settings	417
	Connectivity	417
	Interface Block Setting	418
	Energy Saver/Timer	419
	User Account Lockout Setting	419
	Job Status/Job Logs Settings	419

1 Please Read First

Preface

Thank you for purchasing this machine.

This Operation Guide is intended to help you operate the machine correctly, perform routine maintenance, and take simple troubleshooting measures as needed so that the machine can always be used in the optimum condition.

Please read this Operation Guide before using the machine.

The product illustrations, screens, settings, etc., in this guide may differ depending on the machine you are using.

We recommend the use of our genuine toner containers, which have passed rigorous quality control testing, to maintain quality.

The use of non-genuine toner containers may cause failure.

We will not be liable for any damages caused by the use of third party supplies in this machine.

A label is affixed to our genuine supplies, as shown below.

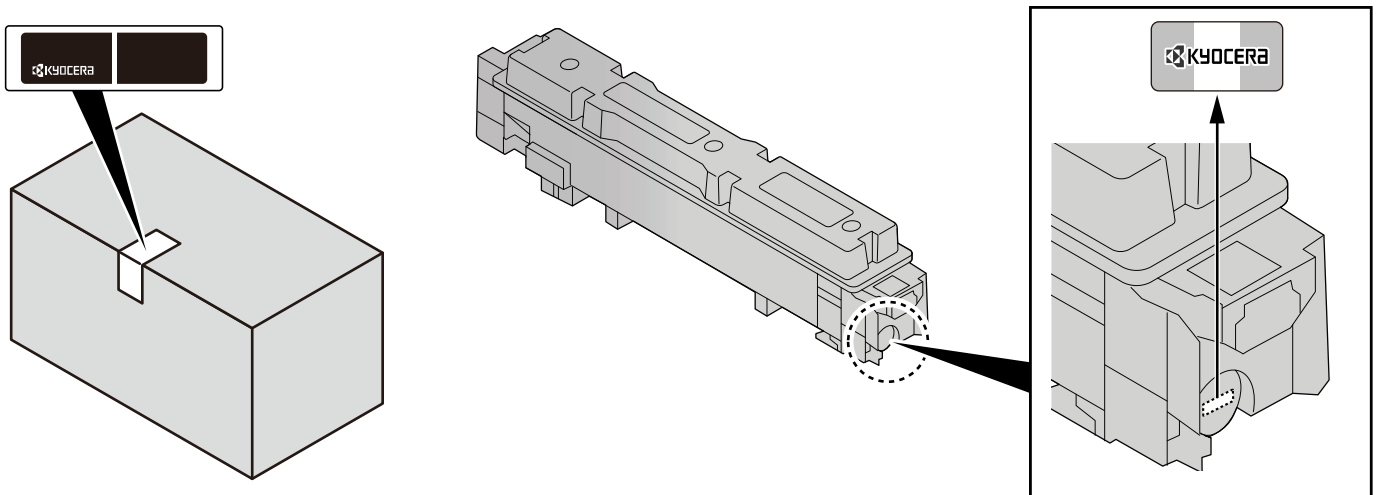

Checking the Equipment's Serial Number

The equipment's serial number is printed in the location shown in the figure.

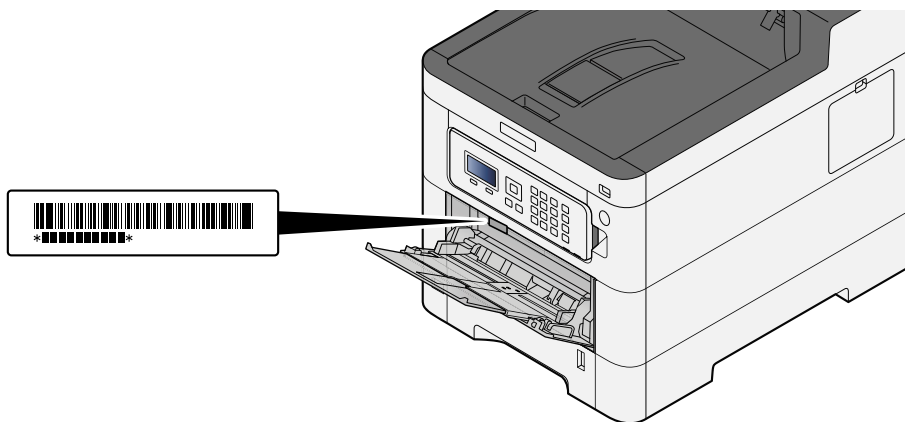

You'll need the equipment's serial number when contacting your Service Representative. Please check the number before contacting your service representative.

Machine Features

The machine is equipped with many useful functions.

➔ [Using Various Functions \(page 159\)](#)

Here are some examples.

Optimize your office workflow

Save frequently used documents in the machine (Custom Box)

You can save the frequently used document in the machine and print it when needed.

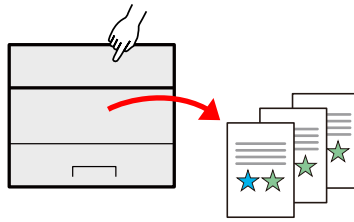

➔ [Using Document Boxes \(page 145\)](#)

Save energy and cost

Save energy as needed (Energy Saver function)

The machine is equipped with Energy Saver function that automatically switches the machine into Sleep Mode.

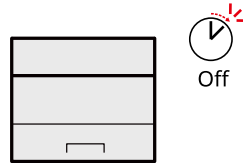

➔ [Energy Saver function \(page 57\)](#)

Printing with reduced toner consumption (EcoPrint)

You can save toner consumption with this function.

When you only need to check the printed content, such as a trial print run or documents for internal confirmation, use this function to save toner.

Use this function when a high-quality print is not required.

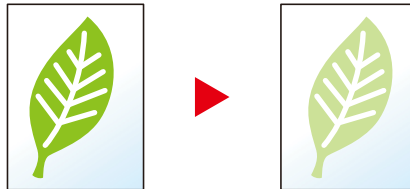

➔ [EcoPrint \(page 164\)](#)

Reduce paper use (Paper Saving Printing)

You can print originals on both sides of the paper. You can also print multiple originals onto one sheet.

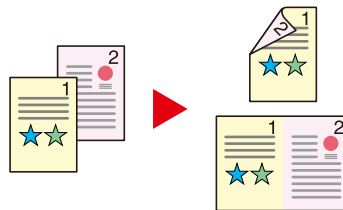

➔ [Duplex \(page 163\)](#)

Strengthen security

Protect data on the SSD (Encryption / Overwrite)

You can overwrite the unnecessary data that remains on the SSD automatically.

To prevent an external leakage, the machine is able to encrypt data before writing it to the SSD.

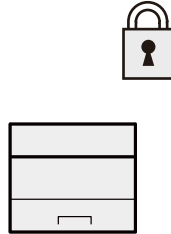

➔ [Data Security \(page 240\)](#)

Prevent loss of finished documents (Private Print)

Temporarily saving print jobs in the main unit document box and outputting them when in front of the device can prevent documents from being taken by others.

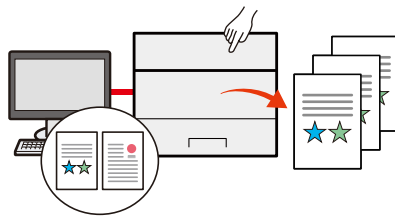

➔ [Printing Documents from Private Print Box \(page 124\)](#)

Log in by ID card (Card Authentication)

You can log in simply by touching an ID card. You don't need to enter your user name and password.

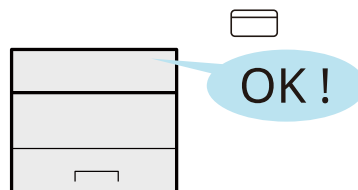

➔ [Card Authentication Kit\(B\) AC <IC card authentication kit \(Activate\)> \(page 378\)](#)

Strengthen security (Settings for Administrator)

Various functions are available for administrators to strengthen security.

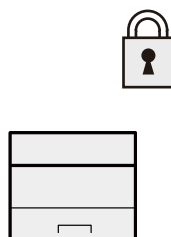

➔ [Strengthening the Security \(page 76\)](#)

Prevent the execution of malware (Allowlisting)

Prevent malware from running and prevent software tampering and maintain system reliability.

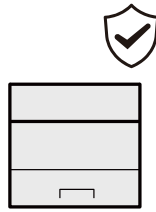

➔ [Allowlisting \(page 242\)](#)

Use functions more efficiently

Make the machine quiet (Quiet Mode)

You can make the machine quiet by reducing its running noise. You can configure this mode by job.

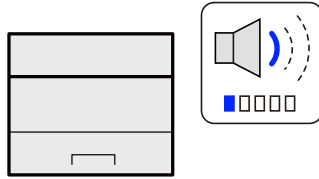

➔ [Quiet Mode \(page 162\)](#)

Install the machine without concerning the network cables (Wireless Network)

If there is a wireless LAN environment, it is possible to install the unit without worrying about the network wiring. In addition, Wi-Fi Direct, etc. are supported.

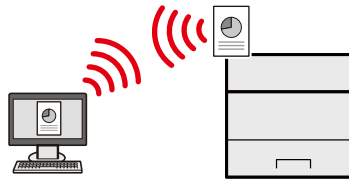

➔ [Configuring the Wireless Network \(page 47\)](#)

Use USB drive(USB Drive)

It is useful when you need to print documents outside your office or you cannot print documents from your PC. You can print the document from the USB drive by plugging it directly into the machine.

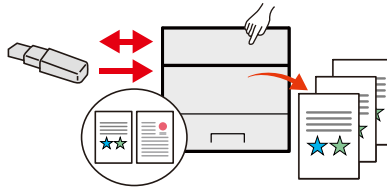

➔ [Using Removable USB Drive \(page 157\)](#)

Perform remote operation (Command Center RX)

You can access to the machine remotely to print data.

Administrators can configure the machine behavior or management settings.

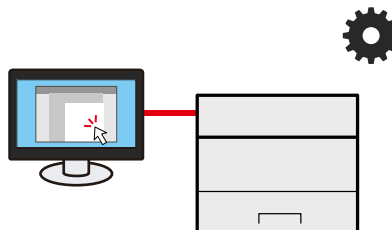

➔ [Command Center RX \(page 78\)](#)

Guides Provided with the Machine

The following guides are provided with the machine. Refer to each guide as needed. The guides can be downloaded from the Download Center (<https://kyocera.info/>). To view the guides on a computer, Adobe Reader Version 8.0 or later needs to be installed.

The contents of the guides are subject to change without notice for the purpose of improvement of machine performance.

To set up the machine:	<p>Setup Guide</p> <p>Explains the setup procedure to follow in order to print with this machine.</p>
Start using the machine quickly	<p>Quick Guide</p> <p>Explains frequently-used operations and what to do when problems occur.</p> <p>This printed guide is provided together with the machine.</p>
For safe use of the machine	<p>Safety Guide</p> <p>Provides safety and cautionary information for installation environment and use of the machine. Be sure to read this guide before using the machine.</p> <p>This printed guide is provided together with the machine.</p> <p>Safety Guide (ECOSYS PA4500cx/ECOSYS PA4000cx/ECOSYS PA3500cx)</p> <p>Indicates the space required for machine installation, and describes the cautionary labels and other safety information. Be sure to read this guide before using the machine.</p> <p>This printed guide is provided together with the machine.</p>
Use the machine to its fullest	<p>Operation Guide (this guide)</p> <p>Explains paper loading, basic operations, and various default settings.</p>
Use the ID card	<p>Card Authentication Kit (B) Operation Guide</p> <p>Explains how to perform authentication using the ID card.</p>
Strengthen security	<p>Data Encryption/Overwrite Operation Guide</p> <p>Explains how to introduce and use the Data Encryption/Overwrite Function, and how to overwrite and encrypt data.</p>
Easily register machine information and configure settings	<p>Command Center RX User Guide</p> <p>Explains how to access the machine from a Web browser on your computer to check and change settings.</p>
Print data from a computer	<p>Printer Driver User Guide</p> <p>Explains how to install the printer driver and use the printer function.</p>
Monitor the machine and printers on the network	<p>KYOCERA Net Viewer User Guide</p> <p>Explains how to monitor your network printing system (the machine) with KYOCERA Net Viewer.</p>

Print without using the printer driver	<p>PRESCRIBE Commands Command Reference Describes the native printer language (PRESCRIBE commands).</p> <p>PRESCRIBE Commands Technical Reference Describes the PRESCRIBE command functions and control for each type of emulation.</p>
Directly print a PDF file	<p>KYOCERA Net Direct Print Operation Guide Explains how to print PDF files without launching Adobe Acrobat or Reader.</p>
Adjust the printing position	<p>Maintenance Menu User Guide Explains how to configure print settings.</p>

About the Operation Guide (this Guide)

Structure of the guide

The Operation Guide contains the following chapters.

Chapter	Contents
Please Read First	Provides precautions regarding use of the machine and trademark information.
Installing and Setting up the Machine	Explains part names, cable connections, installation of the software, login, logout, and other matters related to administration of the machine.
Preparation before Use	Explains preparations and settings that are required in order to use the machine, such as how to load paper.
Print from PC	Explains the basic printing method.
Operation on the Machine	Explains the basic procedures for using document boxes.
Using Various Functions	Explains convenient functions that are available on the machine.
Status/Job Cancel	Explains how to check the status of a job and the job history, and how to cancel jobs being printed or waiting to print. Also explains how to check paper and toner levels, and how to check the device status.
System Menu	Explains System Menu and how it relates to the operation of the machine.
User Authentication and Accounting (User Login, Job Accounting)	Explains user login and job accounting.
Troubleshooting	Explains what to do when toner runs out, an error is displayed, or a paper jam or other problem occurs.
Appendix	Describes convenient options that are available for the machine. Provides information on media types and paper sizes, and gives a glossary of terms. Explains how to enter characters, and lists the specifications of the machine.

Conventions Used in This Guide

Adobe Reader is used as an example in the explanations below.

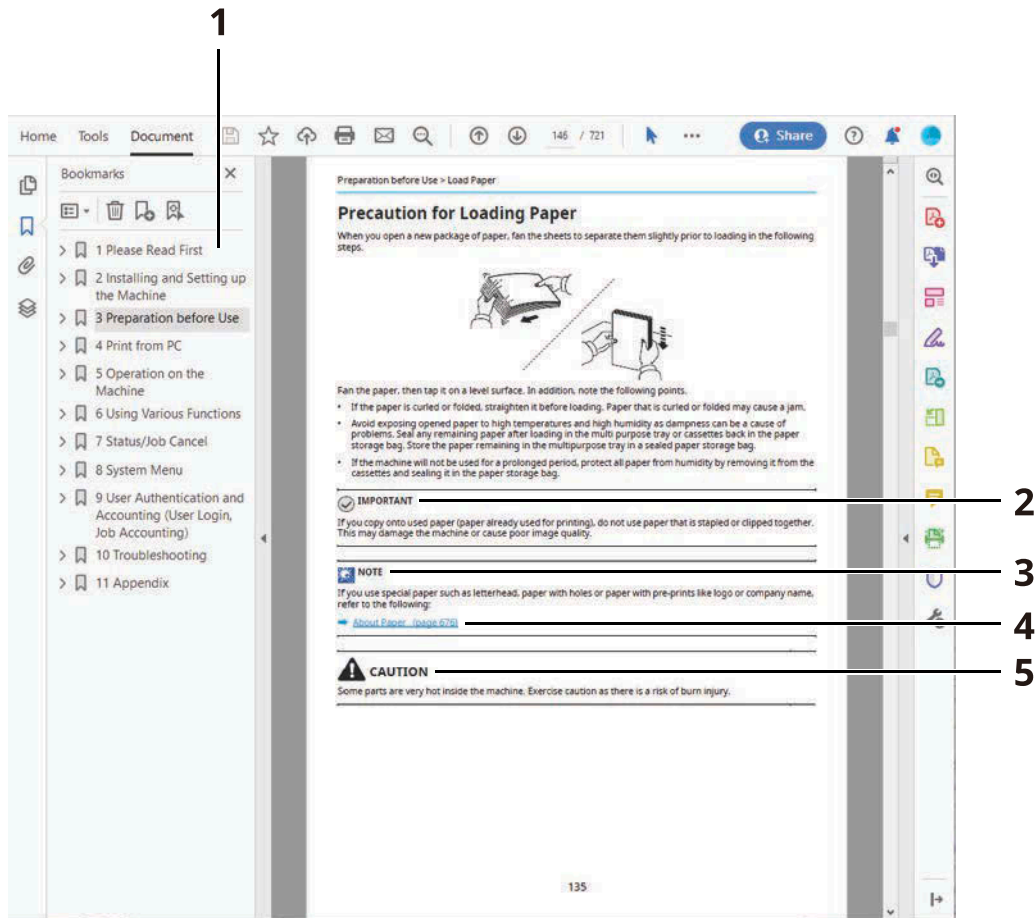

- 1 Click an item in the Table of Contents to jump to the corresponding page.
- 2 Indicates operational requirements and restrictions to operate the machine correctly, and avoid damage to the machine or property.
- 3 Indicates supplemental explanations and reference information for operations.
- 4 Click the underlined text to jump to the corresponding page.
- 5 Indicates that personal injury or mechanical damage may result from insufficient attention to or incorrect compliance with the related points.

NOTE

The items that appear in Adobe Reader vary depending on how it is used. If the Table of Contents or tools do not appear, refer to Adobe Reader Help.

Certain items are indicated in this guide by the conventions described below.

Convention	Description
[]	Indicates keys and buttons.
" "	Indicates a message.

Conventions Used in Procedures for Operating the Machine

In this Operation Guide, continuous operation is shown with > in sequence, as below:

Actual procedure

- 1 Select the [Menu] key.
- 2 Press the [▲] or [▼] key and select [Device Common]
- 3 Select the [OK] key

Procedure indicated in this guide

[Menu] key > [▲][▼] key > [Device Common] > [OK] key

Size of Paper

Paper sizes such as A5 and Statement can be used in both the horizontal and vertical orientations. To distinguish the orientations when these sizes are used, "R" is added to sizes used in the horizontal orientation.

Set the paper in vertical orientation

When loading in a cassette

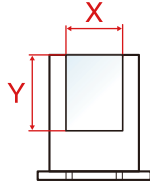
Setting Position (X=Width, Y=Length)	Indicated size in this Guide
	A5-R, Statement-R

When loading in the multipurpose tray

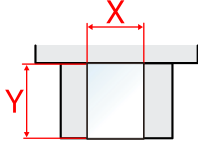
Setting Position (X=Width, Y=Length)	Indicated size in this Guide
	A5-R, Statement-R

Paper sizes that can be used vary depending on the function and paper feeder unit. For details, refer to the following.

➔ [Specifications \(page 395\)](#)

Set the paper in horizontal orientation

When loading in a cassette

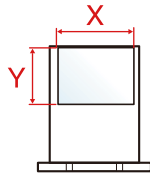
Setting Position (X=Width, Y=Length)	Indicated size in this Guide
	A5, Statement

When loading in the multipurpose tray

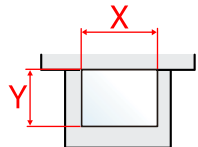
Setting Position (X=Width, Y=Length)	Indicated size in this Guide
	A5, Statement

Paper sizes that can be used vary depending on the function and paper feeder unit. For details, refer to the following.

➔ [Specifications \(page 395\)](#)

Notice

Safety Conventions in This Guide

The sections of this guide and parts of the machine marked with symbols are safety warnings meant to protect the user, other individuals and surrounding objects, and ensure correct and safe usage of the machine. The symbols and their meanings are indicated below.



WARNING:

Indicates that serious injury or even death may result from insufficient attention to or incorrect compliance with the related points.



CAUTION:

Indicates that personal injury or mechanical damage may result from insufficient attention to or incorrect compliance with the related points.

Symbols

The  symbol indicates that the related section includes safety warnings. Specific points of attention are indicated inside the symbol.



[General warning]



[Warning of high temperature]

The  symbol indicates that the related section includes information on prohibited actions. Specifics of the prohibited action are indicated inside the symbol.



[Warning of prohibited action]



[Disassembly prohibited]

The  symbol indicates that the related section includes information on actions which must be performed. Specifics of the required action are indicated inside the symbol.



[Alert of required action]



[Remove the power plug from the outlet]



[Always connect the machine to an outlet with a ground connection]

Environment

The service environmental conditions are as follows:

Temperature	10 to 32.5°C/50 to 90.5°F But humidity should be 70% or less when temperature is 90.5 °F (32.5 °C).
Humidity	10 to 80% But temperature should be 86 °F (30 °C) or less when humidity is 80%.

Avoid the following locations when selecting a site for the machine.

- Avoid locations near a window or with exposure to direct sunlight.
- Avoid locations with vibrations.
- Avoid locations with drastic temperature fluctuations.
- Avoid locations with direct exposure to hot or cold air.
- Avoid poorly ventilated locations.

During copying, some ozone is released, but the amount does not cause any ill effect to one's health.

If, however, the machine is used over a long period of time in a poorly ventilated room or when making an extremely large number of copies, the smell may become unpleasant.

To maintain the appropriate environment for copy work, it is suggested that the room be properly ventilated.

Precautions for Use

Cautions when handling consumables

CAUTION

Do not attempt to incinerate parts which contain toner. Dangerous sparks may cause burns.

Keep parts which contain toner out of the reach of children.

If toner happens to spill from parts which contain toner, avoid inhalation and ingestion, as well as contact with your eyes and skin.

- If you do happen to inhale toner, move to a place with fresh air and gargle thoroughly with a large amount of water. If coughing develops, contact a physician.
- If you do happen to ingest toner, rinse your mouth with water and drink 1 or 2 cups of water to dilute the contents of your stomach. If necessary, contact a physician.
- If you do happen to get toner in your eyes, flush them thoroughly with water. If there is any remaining tenderness, contact a physician.
- If toner does happen to get on your skin, wash with soap and water.

Do not attempt to force open or destroy parts which contain toner.

Other precautions

Return the exhausted toner container and waste toner box to your dealer or service representative. The collected toner container and waste toner box will be recycled or disposed in accordance with the relevant regulations.

Store the machine while avoiding exposure to direct sunlight.

Store the machine in a place where the temperature stays below 40 °C while avoiding sharp changes of temperature and humidity.

If the machine will not be used for an extended period of time, remove the paper from the cassette and the Multipurpose (MP) Tray, return it to its original package and reseal it.

Compliance and Conformity

Hereby, KYOCERA Document Solutions Inc. declares that the radio equipment type ECOSYS PA4500cx, ECOSYS PA4000cx, ECOSYS PA3500cx are in compliance with Directive 2014/53/EU.

The full text of the EU declaration of conformity is available at the following internet address:

Module name, Option	Software Ver.	Frequency band in which the radio equipment operates:	Maximum radio-frequency power transmitted in the frequency band in which the radio equipment operates:
IB-51 (option)	2.2.6	2.4 GHz	100 mW
IB-37 (option)	1.0	2.4 GHz	100 mW
		5 GHz	50 mW - 1 W
IB-38 (option)	1.0	2.4 GHz	100 mW

Security Precautions when Using Wireless LAN (If equipped)

Wireless LAN allows information to be exchanged between wireless access points instead of using a network cable, which offers the advantage that a WLAN connection can be established freely within an area in which radio waves can be transmitted.

On the other hand, the following problems may occur if security settings are not configured, because radio waves can pass through obstacles (including walls) and reach everywhere within a certain area.

Secretly Viewing Communication Contents

A third person with malicious objectives may intentionally monitor radio waves and gain unauthorized access to the following communication contents.

- Personal information including ID, passwords, and credit card numbers
- Contents of email messages

Illegal Intrusion

A third party with malicious intent may gain unauthorized access to personal or company networks and conduct the following illegal actions.

- Extracting personal and confidential information (information leak)
- Entering into communication while impersonating a specific person and distributing unauthorized information (spoofing)
- Modifying and retransmitting intercepted communications (falsification)
- Transmitting computer viruses and destroying data and systems (destruction)

Wireless LAN cards and wireless access points contain built-in security mechanisms to address these problems and to reduce the possibility of these problems occurring by configuring the security settings of wireless LAN products when the product is used.

We recommend that customers take responsibility and use their judgment when configuring the security settings and that they ensure that they fully understand the problems that can occur when the product is used without configuring the security settings.

Limited Use of This Product (If equipped)

- Radio waves transmitted from this product may affect medical equipment. When using this product in a medical institution or in the vicinity of medical instruments, either use this product according to the instructions and precautions provided by the administrator of the institution or those provided on the medical instruments.
- Radio waves transmitted from this product may affect automatic control equipment including automatic doors and fire alarms. When using this product in the vicinity of the automatic control equipment, use this product according to the instructions and precautions provided on the automatic control equipment.
- If this product is used in devices that are directly related to service including airplanes, trains, ships, and automobiles or this product is used in applications requiring high reliability and safety to function and in devices requiring accuracy including those used in disaster prevention and crime prevention and those used for various safety purposes, please use this product after considering the safety design of the entire system including adoption of a failsafe design and redundancy design for reliability and safety maintenance of the entire system. This product is not intended for use in applications requiring high reliability and safety including aerospace instruments, trunk communication equipment, nuclear power control equipment, and medical equipment; hence, the decision as to whether to use this product in these applications needs to be fully considered and determined.

Legal and Safety Information

Unauthorized reproduction (copying) of all or part of this document is prohibited, with the exception of copyright law exceptions.

Regarding Trade Names

- PRESCRIBE and ECOSYS are registered trademarks of Kyocera Corporation.
- KPDL is a trademark of Kyocera Corporation.
- Active Directory, Azure, Microsoft, Microsoft 365, Microsoft Edge, Windows and Windows Server are registered trademarks or trademarks of Microsoft Corporation in the U.S.A. and/or other countries.
- PCL is a trademark of Hewlett-Packard Company.
- Adobe, Acrobat, PostScript and Reader are registered trademarks or trademarks of Adobe Inc. in the U.S.A. and/or other countries.
- Ethernet is a registered trademark of Fuji Xerox Co., Ltd.
- IBM and IBM PC/AT are trademarks of International Business Machines Corporation.
- AppleTalk, Bonjour, Mac, and Mac OS are trademarks of Apple Inc., registered in the U.S. and other countries.
- All European language fonts installed in this machine are used under licensing agreement with Monotype Imaging Inc.
- Helvetica, Palatino and Times are registered trademarks of Linotype GmbH.
- ITC Avant Garde Gothic, ITC Bookman, ITC ZapfChancery and ITC ZapfDingbats are registered trademarks of International Typeface Corporation.
- ThinPrint is a trademark of Cortado AG in Germany and other countries.
- UFST™ MicroType® fonts by Monotype Imaging Inc. are installed in this machine.
- iPad, iPhone and iPod touch are trademarks of Apple Inc., registered in the U.S. and other countries.
- AirPrint and the AirPrint logo are trademarks of Apple Inc.
- iOS is a trademark or registered trademark of Cisco in the U.S. and other countries and is used under license by Apple Inc.
- Google is trademarks and/or registered trademarks of Google LLC.
- Mopria™ is registered trademarks of Mopria™ Alliance.
- Wi-Fi, Wi-Fi Direct and Wi-Fi Protected Setup are trademarks and/or registered trademarks of Wi-Fi Alliance.
- RealVNC, VNC and RFB are registered trademarks of RealVNC Ltd. in the U.S. and in other countries.

All other brands and product names are registered trademarks or trademarks of their respective companies. Neither™ nor® will be specified in the main text.

Monotype Imaging License Agreement

- 1 Software shall mean the digitally encoded, machine readable, scalable outline data as encoded in a special format as well as the UFST Software.
- 2 You agree to accept a non-exclusive license to use the Software to reproduce and display weights, styles and versions of letters, numerals, characters and symbols (Typefaces) solely for your own customary business or personal purposes at the address stated on the registration card you return to Monotype Imaging. Under the terms of this License Agreement, you have the right to use the Fonts on up to three printers. If you need to have access to the fonts on more than three printers, you need to acquire a multiuser license agreement which can be obtained from Monotype Imaging. Monotype Imaging retains all rights, title and interest to the Software and Typefaces and no rights are granted to you other than a License to use the Software on the terms expressly set forth in this Agreement.

- 3 To protect proprietary rights of Monotype Imaging, you agree to maintain the Software and other proprietary information concerning the Typefaces in strict confidence and to establish reasonable procedures regulating access to and use of the Software and Typefaces.
- 4 You agree not to duplicate or copy the Software or Typefaces, except that you may make one backup copy. You agree that any such copy shall contain the same proprietary notices as those appearing on the original.
- 5 This License shall continue until the last use of the Software and Typefaces, unless sooner terminated. This License may be terminated by Monotype Imaging if you fail to comply with the terms of this License and such failure is not remedied within thirty (30) days after notice from Monotype Imaging. When this License expires or is terminated, you shall either return to Monotype Imaging or destroy all copies of the Software and Typefaces and documentation as requested.
- 6 You agree that you will not modify, alter, disassemble, decrypt, reverse engineer or decompile the Software.
- 7 Monotype Imaging warrants that for ninety (90) days after delivery, the Software will perform in accordance with Monotype Imaging-published specifications, and the diskette will be free from defects in material and workmanship. Monotype Imaging does not warrant that the Software is free from all bugs, errors and omissions.

The parties agree that all other warranties, expressed or implied, including warranties of fitness for a particular purpose and merchantability, are excluded.
- 8 Your exclusive remedy and the sole liability of Monotype Imaging in connection with the Software and Typefaces is repair or replacement of defective parts, upon their return to Monotype Imaging.

In no event will Monotype Imaging be liable for lost profits, lost data, or any other incidental or consequential damages, or any damages caused by abuse or misapplication of the Software and Typefaces.
- 9 Massachusetts U.S.A. law governs this Agreement.
- 10 You shall not sublicense, sell, lease, or otherwise transfer the Software and/or Typefaces without the prior written consent of Monotype Imaging.
- 11 Use, duplication or disclosure by the Government is subject to restrictions as set forth in the Rights in Technical Data and Computer Software clause at FAR 252-227-7013, subdivision (b)(3)(ii) or subparagraph (c)(1)(ii), as appropriate. Further use, duplication or disclosure is subject to restrictions applicable to restricted rights software as set forth in FAR 52.227-19 (c)(2).
- 12 You acknowledge that you have read this Agreement, understand it, and agree to be bound by its terms and conditions. Neither party shall be bound by any statement or representation not contained in this Agreement. No change in this Agreement is effective unless written and signed by properly authorized representatives of each party. By opening this diskette package, you agree to accept the terms and conditions of this Agreement.

OpenSSL License

For the Open Source Software license, go into the following URL and select Country > Product Name > OS > Language and then, refer to the "OSS_Notice" from the manual tab in the Download.

<https://kyocera.info/>

Energy Saving Control Function

To reduce power consumption when idle, the device comes equipped with a power management function that automatically shifts to "Sleep" to minimize power consumption after a certain period of time has passed since the device was last used.

→ [Sleep \(page 57\)](#)

Automatic 2-Sided Print Function

This device includes 2-sided printing as a standard function. For example, by printing two 1-sided originals onto a single sheet of paper as a 2-sided print, it is possible to lower the amount of paper used.

→ [Duplex \(page 163\)](#)

Printing in duplex mode reduces paper consumption and contributes to the conservation of forest resources. Duplex mode also reduces the amount of paper that must be purchased, and thereby reduces cost. It is recommended that machines capable of duplex printing be set to use duplex mode by default.

Resource Saving - Paper

For the preservation and sustainable use of forest resources, it is recommended that recycled as well as virgin paper certified under environmental stewardship initiatives or carrying recognized ecolabels, which meet EN 12281:2002* or an equivalent quality standard, be used.

This machine also supports printing on 64 g/m² paper. Using such paper containing less raw materials can lead to further saving of forest resources.

* : EN12281:2002 "Printing and business paper - Requirements for copy paper for dry toner imaging processes"

Contact your dealer or service representative for recommended paper types.

Environmental benefits of "Power Management"

To reduce power consumption when idle, this machine is equipped with a power management function that automatically activates energy-saving mode when the machine is idle for a certain period of time.

Although it takes the machine a slight amount of time to return to READY mode when in energy-saving mode, a significant reduction in energy consumption is possible. It is recommended that the machine be used with the activation time for energy-saving mode set to the default setting.

ENERGY STAR Program

We participate in the ENERGY STAR® Program. We provide the products that comply with ENERGY STAR standards to the market.

ENERGY STAR is an energy efficiency program with the goal of developing and promoting the use of products with high energy efficiency in order to help prevent global warming. By purchasing the products that comply with ENERGY STAR, customers can help reduce emissions of greenhouse gases during product use and cut energy-related costs.

2 Installing and Setting up the Machine

Part Names (Machine Exterior)

ECOSYS PA4500cx/ECOSYS PA4000cx

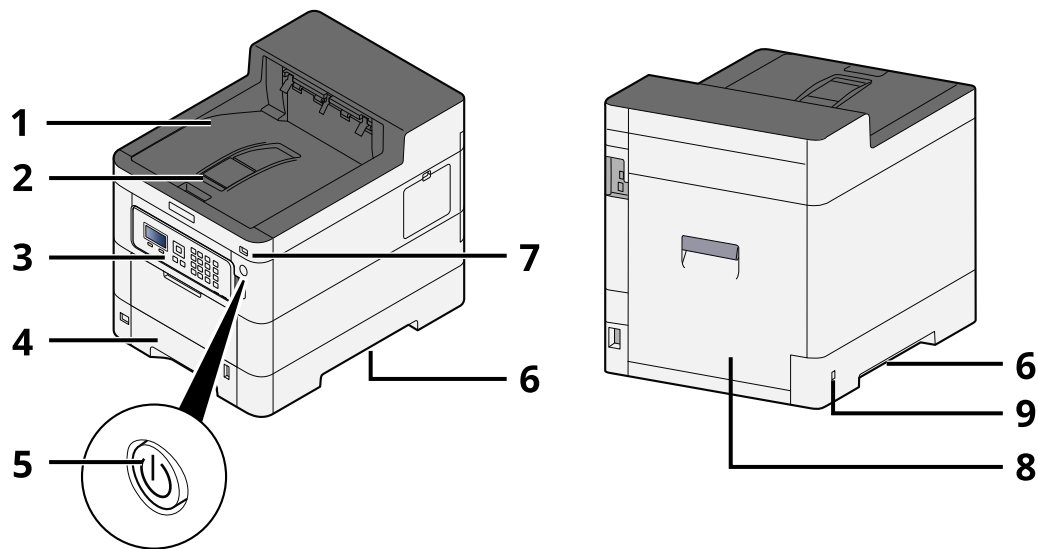

- 1 Upper tray
- 2 Eject stopper
- 3 Operation panel
- 4 Cassette 1
- 5 Power Switch
- 6 Conveying handle
- 7 USB Memory slot
- 8 Rear cover 1
- 9 Anti-theft slot

ECOSYS PA3500cx

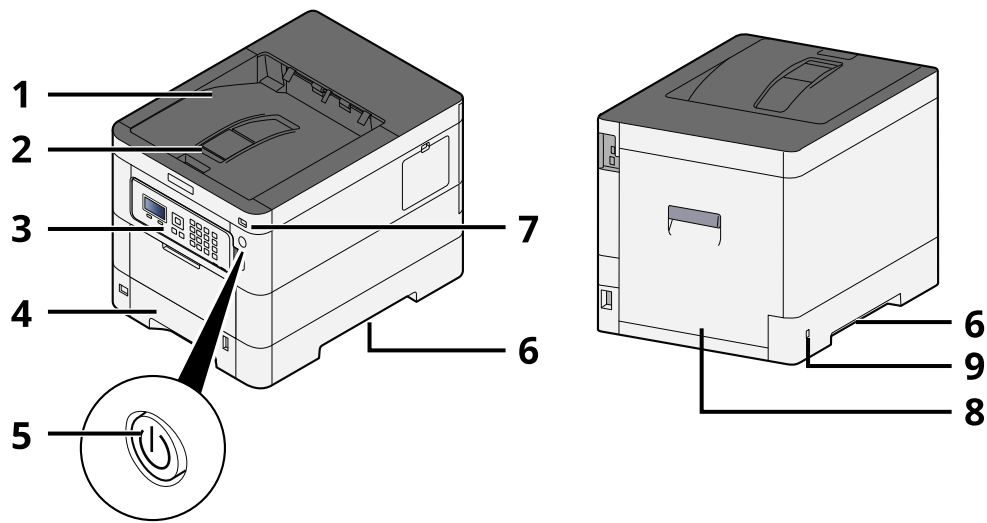

- 1 Upper tray
- 2 Eject stopper
- 3 Operation panel
- 4 Cassette 1
- 5 Power Switch
- 6 Conveying handle
- 7 USB Memory slot
- 8 Rear cover 1
- 9 Anti-theft slot

Part Names (Connectors/Interior)

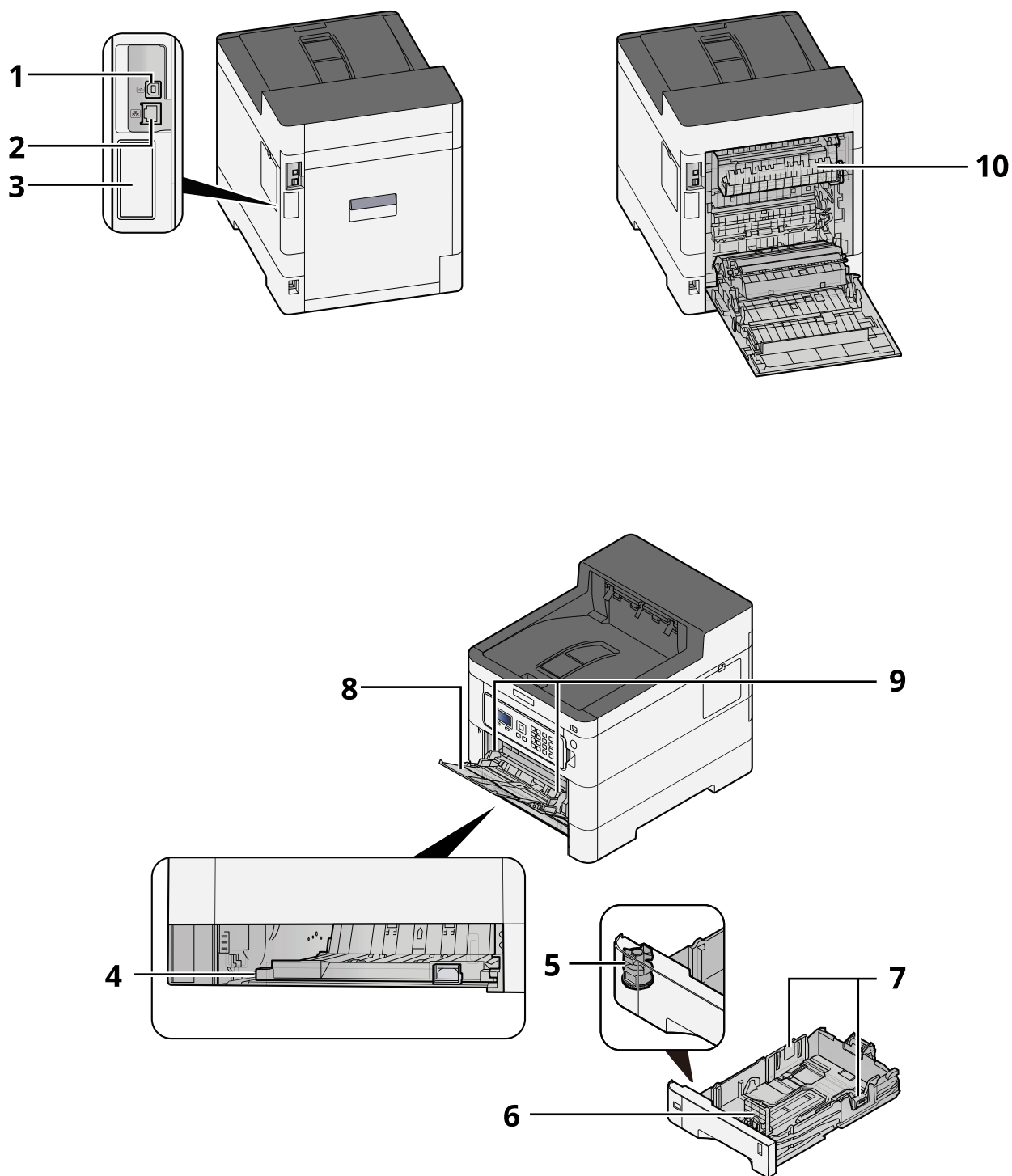

- 1 USB interface connector
- 2 Network interface connector
- 3 Optional interface slot
- 4 Conveying cover
- 5 Size dial

- 6 Paper length guide
- 7 Paper width guide
- 8 Multipurpose Tray
- 9 Paper guide
- 10 Fuser cover

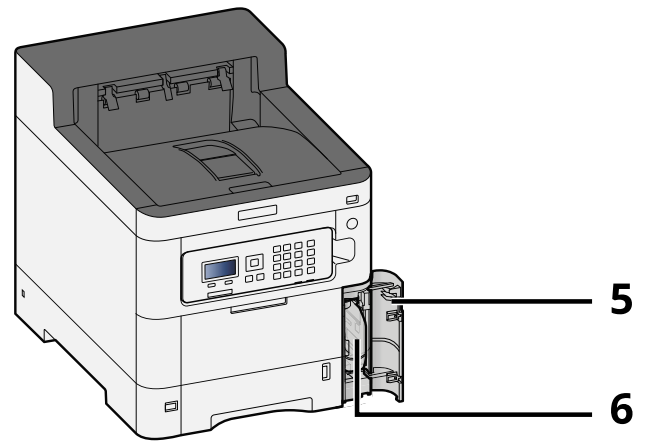
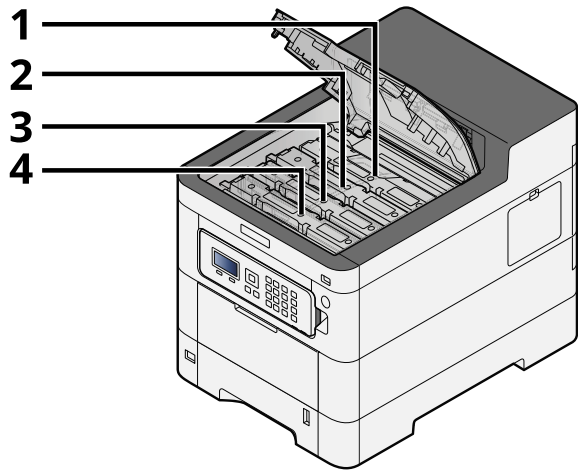

- 1 Toner container (Black)
- 2 Toner container (Cyan)
- 3 Toner container (Magenta)
- 4 Toner container (Yellow)
- 5 Waste toner cover
- 6 Waste toner box

Part Names (With Optional Equipments Attached)

ECOSYS PA4500cx

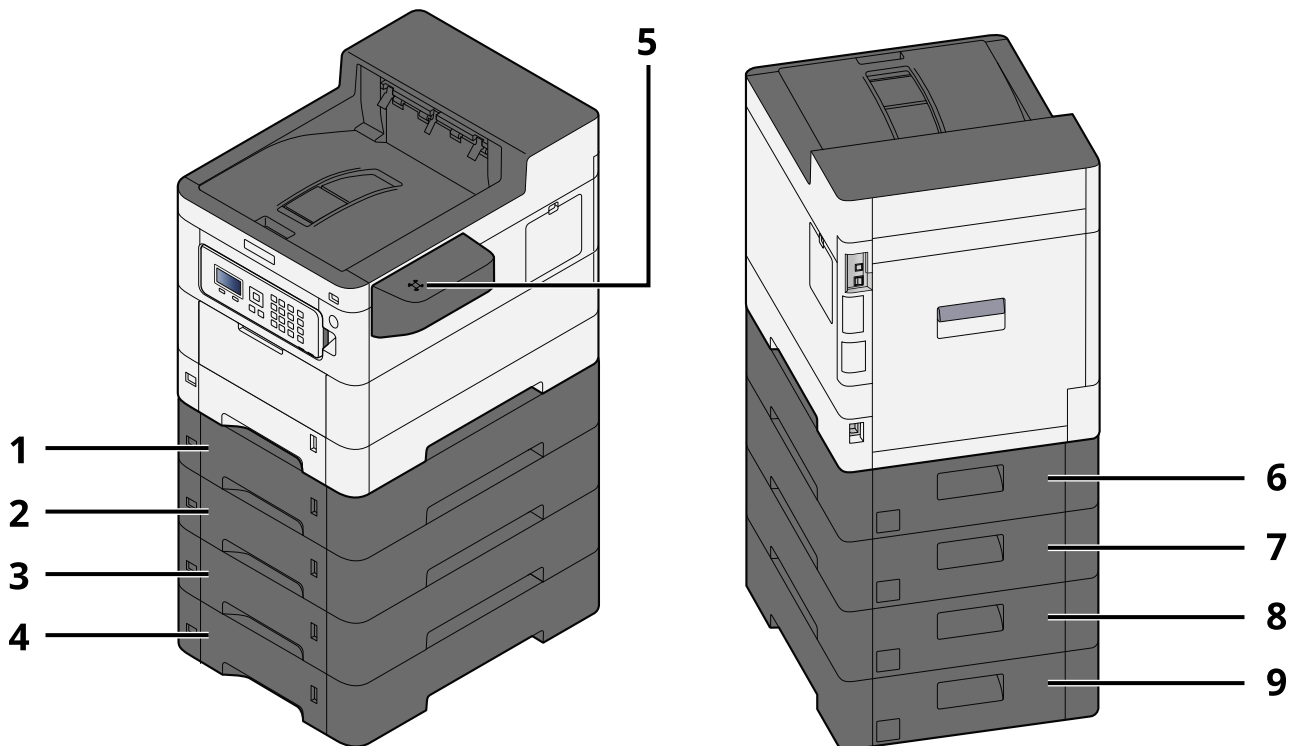

- 1 Cassette 2
- 2 Cassette 3
- 3 Cassette 4
- 4 Cassette 5
- 5 Card reader
- 6 Rear cover 2
- 7 Rear cover 3
- 8 Rear cover 4
- 9 Rear cover 5

For details of options, refer to the following:

➔ [Option configuration \(page 377\)](#)

ECOSYS PA4000cx

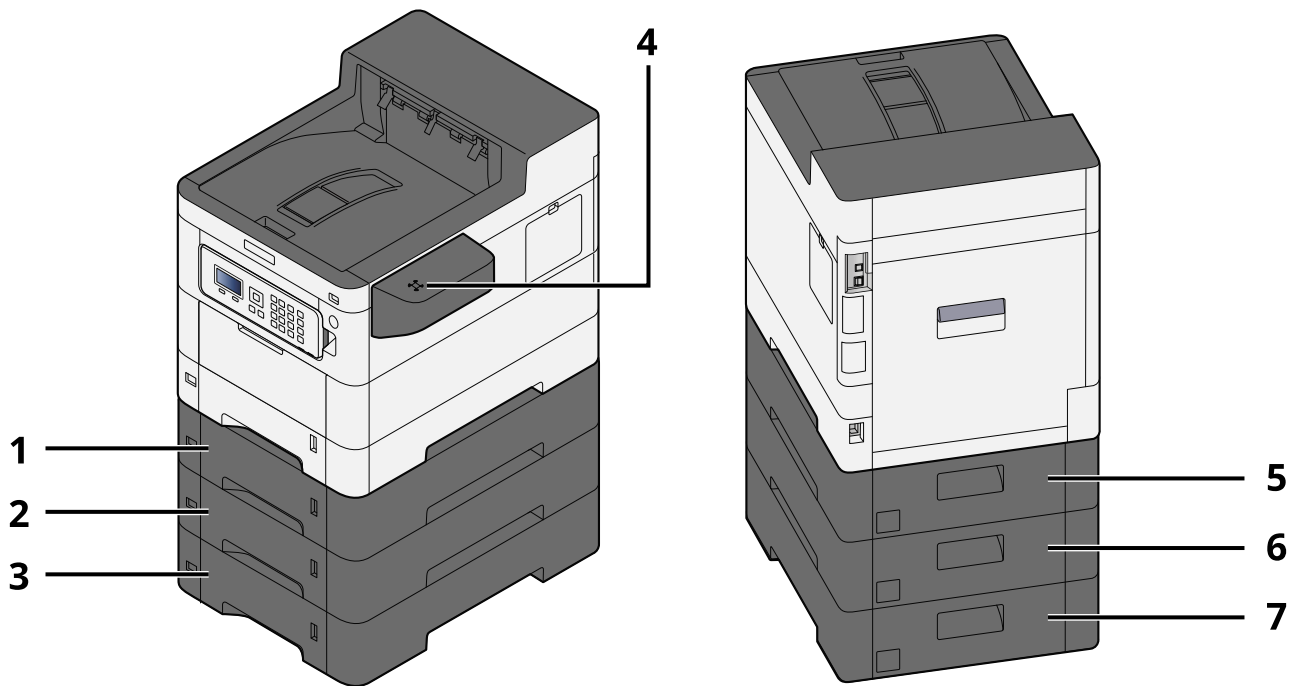

- 1 Cassette 2
- 2 Cassette 3
- 3 Cassette 4
- 4 Card reader
- 5 Rear cover 2
- 6 Rear cover 3
- 7 Rear cover 4

ECOSYS PA3500cx

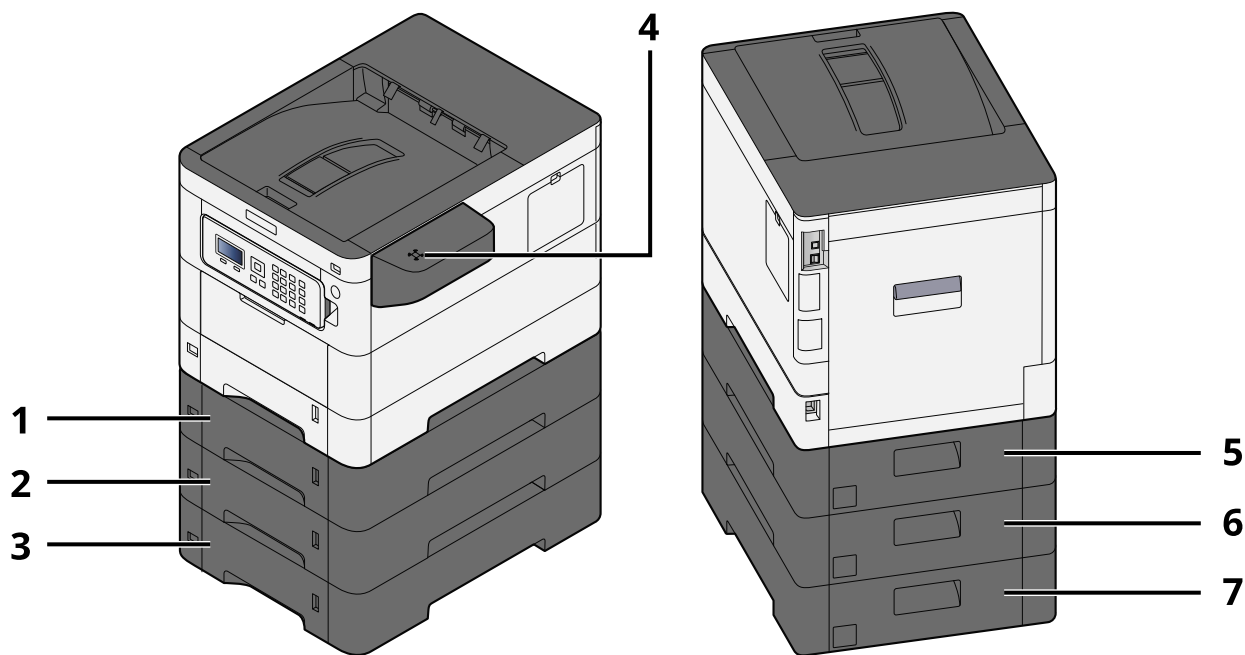

- 1 Cassette 2
- 2 Cassette 3
- 3 Cassette 4
- 4 Card reader
- 5 Rear cover 2
- 6 Rear cover 3
- 7 Rear cover 4

Connecting the Machine and Other Devices

Prepare the cables necessary to suit the environment and purpose of the machine use.

When Connecting the Machine to the PC via USB

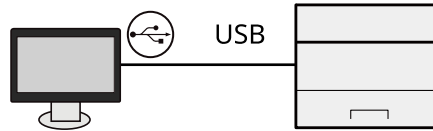

When Connecting the Machine to the PC or Tablet by network cable, Wi-Fi, or Wi-Fi direct

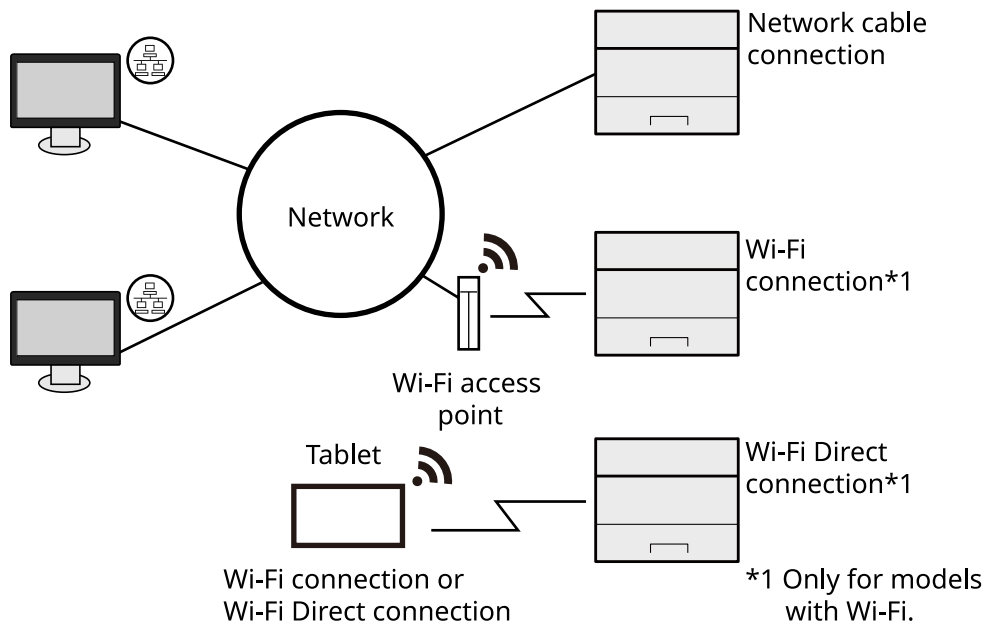

 **NOTE**

If you are using wireless LAN, refer to the following.

➔ [Configuring the Wireless Network \(page 47\)](#)

Cables that Can Be Used

When a network cable is used to connect the machine

Function	Necessary Cable
Printer	LAN cable (10BASE-T, 100BASE-TX, 1000BASE-T)

When a USB cable is used to connect the machine

Function	Necessary Cable
Printer	USB 2.0 compatible cable (Hi-Speed USB compliant, max. 5.0 m, shielded)

 **IMPORTANT**

Using a cable other than a USB 2.0 compatible cable may cause failure.

Connecting Cables

Connecting LAN Cable

✔ IMPORTANT

If the power is on, turn the power switch off.

➔ [Power off \(page 36\)](#)

1 Connect the cable to the machine.

- 1 Connect the LAN cable to the network interface connector.

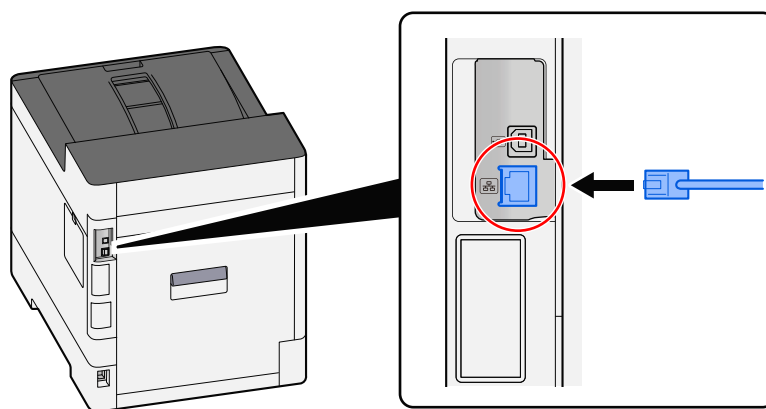

- 2 Connect the other end of the cable to the hub.

2 Power on the machine and configure the network.

➔ [Network Setup \(page 45\)](#)

Connecting USB Cable

 **IMPORTANT**

If the power is on, turn the power switch off.

→ [Power off \(page 36\)](#)

1 Connect the cable to the machine.

- 1 Connect the USB cable to the USB interface connector.

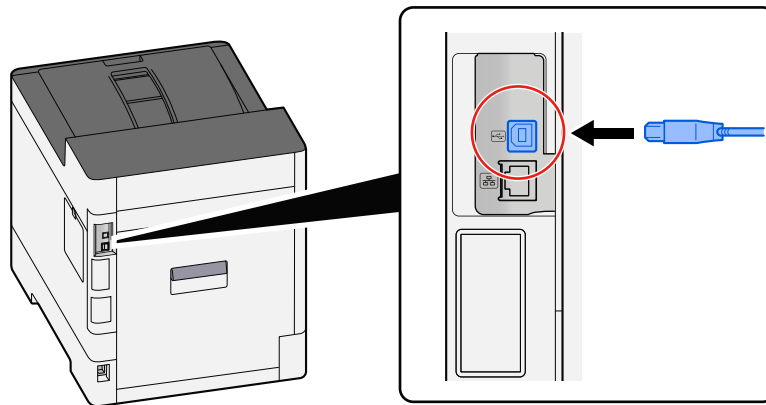

- 2 Connect the other end of the cable to the PC.

2 Power on the machine.

Connecting the Power Cable

1 Connect the cable to the machine.

Connect one end of the supplied power cable to the machine and the other end to a power outlet.

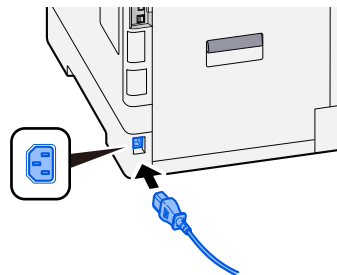

 **IMPORTANT**

Only use the power cable that comes with the machine.

Power On/Off

Power on

- 1 Turn the power switch on.

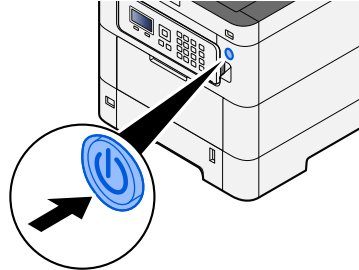

 **IMPORTANT**

When turning off the power switch, do not turn on the power switch again immediately. Wait more than 5 seconds, and then turn on the power switch.

Power off

- 1 Turn the power switch off.

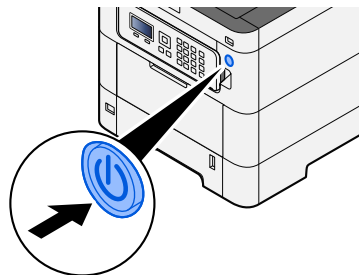

The confirmation message for power supply off is displayed.

It takes approximately 3 minutes for power off.

 **CAUTION**

If this machine will be left unused for an extended period (e.g. overnight), turn it off at the power switch. If the machine will not be used for an even longer period of time (e.g. vacation), remove the power plug from the outlet as a safety precaution.

 **IMPORTANT**

- Remove paper from the cassettes and seal it in the paper storage bag to protect it from humidity.
-

Using the Operation Panel

Operation Panel Keys

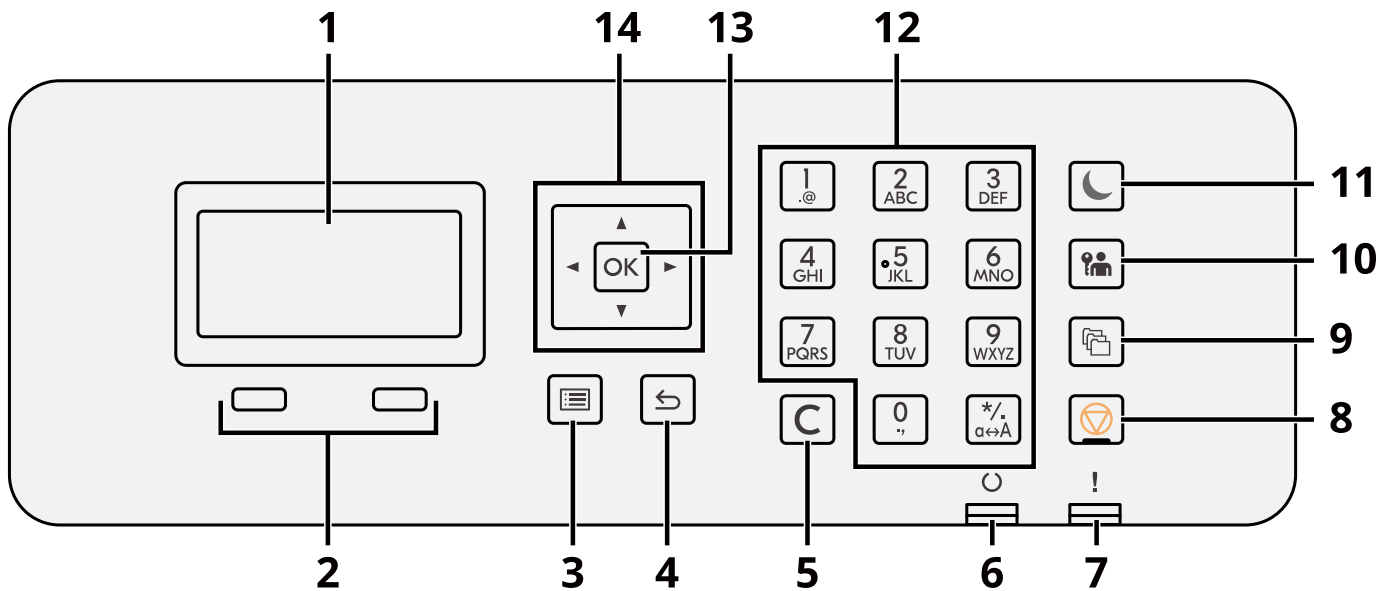

- 1 LDC panel
Display the setting items or the error message.
- 2 Selection key
Select the menu that displayed under the LDC panel.
- 3 [Menu] key
Display the Menu screen.
- 4 [Back] key
Return to the previous screen.
- 5 [Clear] key
Delete the value or the letter inputted.
- 6 [Ready] indicator
Lights when printing is possible. Blinks when processing the print or the error occurred.
- 7 [Attention] indicator
Lights or blinks when an error occurs and a job is stopped.
- 8 [Cancel] key.
Cancel or pause the job in progress
- 9 [Document Box] key
Display the Document Box screen.
- 10 [Logout] key
Finish (Log out) the operation of each user.

11 [Energy Saver] key / [Energy Saver] lamp

Make this main unit into the Sleep Mode condition. Recovers from the Sleep Mode in case of the sleep mode condition. The lamp lights at the sleep mode.

12 The numeric key

Input the number or the symbol.

13 [OK] key

Confirm the function or the menu inputted, or the numerical value.

14 [▲] [▼] [◀] [▶]

Increase/decrease the numerical value at the LCD panel, or select the menu. And also, move the cursor when inputting the letter.

Adjusting the Operation Panel Angle

The angle of the operation panel can be adjusted.

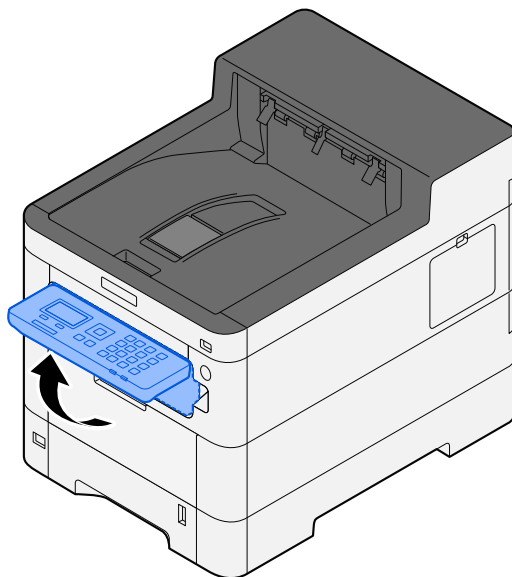

Using the Operation Panel

Here, using the setting menu as an example, operation of the operation panel will be explained.

Selecting the [Menu] key will display the setting menu.

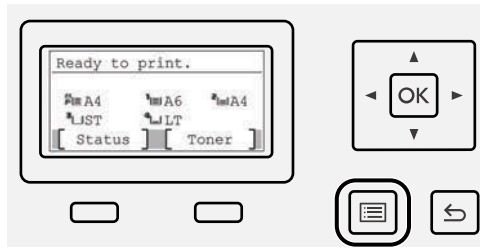

Displays the direction of arrow keys that are useable on the displayed screen.

When you select [▲] or [▼] key, the selected item moves by one line.

When you select [◀] or [▶] key, the selected item moves to page increments.

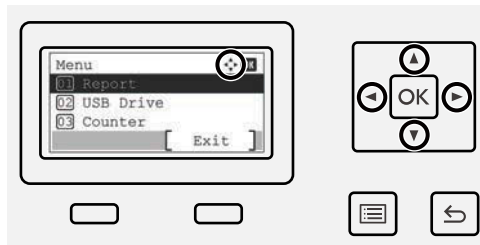

When [OK] is displayed, selecting the [OK] key will confirm the selection.

Selecting the [Back] key will return to the previous level in the menu.

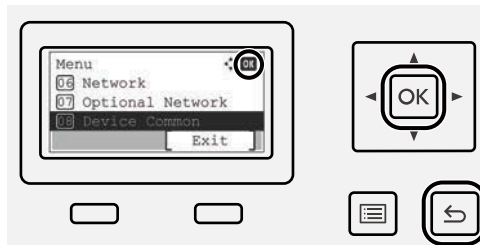

* is displayed at the beginning of the selected item.

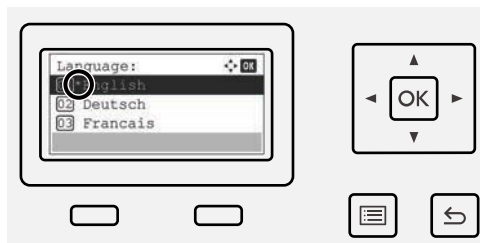

When [End] is displayed, selecting [End] will return to the normal screen from the Setting Menu screen.

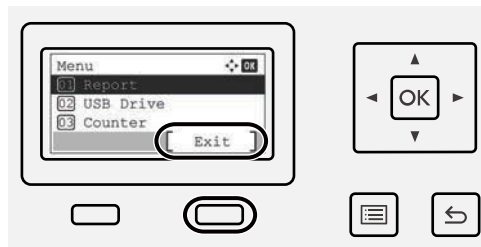

Help Screen

If you have difficulty operating the machine, you can check how to operate it using the touch panel.

When [Help] is displayed, select [Help] to display the Help screen. The Help screen shows the machine operation..



Login/Logout

Login

1 Enter the login user name and login password to login.

If the login screen is displayed during operations, select a [Login User Name] and press the [OK] key.

1 If the user authentication method is set to [Netwk Authentic.], [Menu] is displayed. Selecting [Menu] then [Login Type] allows either [Local Authentic.] or [Netwk Authentic.] to be selected as the authentication destination. Selecting [Menu] then [Domain] allows a registered domain to be selected.

2 Enter the login user name.



NOTE

If you do not know your login User Name, please contact your Administrator.

3 Enter the login password.

➔ [Character Entry Method \(page 1\)](#)



NOTE

If you do not know your login Password, please contact your Administrator.

4 Select [PIN Login] or [ID Card Login] as the login method.

➔ [User Authentication and Accounting \(User Login, Job Accounting\) \(page 247\)](#)

2 Select [Login].

Logout

1 Select the [Logout] key.

The login user name/login password entry screen is returned.

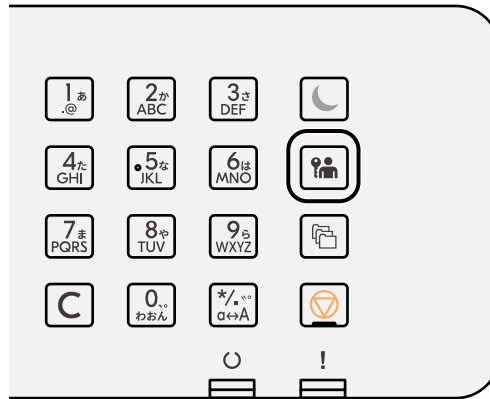

NOTE

Users are automatically logged out in the following circumstances:

- When the machine enters the sleep state.
 - When the auto panel reset function is activated.
-

Default Settings of the Machine

The default settings of the machine can be changed in System Menu. Before using this machine, configure such settings as date and time, network configuration, and energy saving functions as needed.

NOTE

For settings that are configurable from System Menu, refer to the following:

→ [System Menu \(page 178\)](#)

Setting Date and Time

Follow the steps below to set the local date and time at the place of installation. When you send an E-mail using the transmission function, the date and time as set here will be printed in the header of the E-mail message. Set the date, time and time difference from GMT of the region where the machine is used.

NOTE

- To make changes after this initial configuration, refer to the following:

- [Date Setting \(page 225\)](#)

- The correct time can be periodically set by obtaining the time from the network time server.

- **Command Center RX User Guide**

1 Display the screen.

[Menu] key > [▲][▼] key > [Device Common] > [OK] key > [▲][▼] key > [Date Setting] > [OK] key

2 Configure the settings.

Select [Date] > [Time] > [Date Format] > [Time Zone]

[Date]

Set the date for the location where you use the machine.

Value: Year (2000 to 2035), Month (1 to 12), Day (1 to 31)

[Time]

Set the time for the location where you use the machine.

Value: Hours (0-23), Minutes (0-59), Seconds (0-59)

[Date Format]

Select the display format of year, month, and date. The year is displayed in Western notation.

Value: [Month/Day/Year], [Day/Month/Year], [Year/Month/Day]

[Time Zone]

Set the time difference from GMT. Choose the nearest listed location from the list. If you select a region that utilizes summer time, configure settings for summer time.

 **NOTE**

Use the [▲] or [▼] key to enter numbers.

When you select the [◀] or [▶] keys, the input position moves to the left or right and is highlighted.

Network Setup

Configuring the Wired Network

The machine is equipped with network interface, which is compatible with network protocols such as TCP/IP (IPv4), TCP/IP (IPv6), NetBEUI, and IPsec. It enables network printing on the Windows, Mac, UNIX and other platforms. The configuration methods are as follows:

Configuration Method	Description
Configuring the Connection from the Operation Panel on This Machine	Use Wired Network Settings or Optional Network to configure the network in details from System menu. → Wired Netwk. Set (page 208) → Optional Network (page 222)
Configuring Connections on the Web Page	For the equipped network interface, the connection can be set by using Command Center RX. For the IB-50, the connection can be set on the dedicated Web page. → Command Center RX User Guide → IB-50 Operation Guide
Setting the Connection by Using the Setup Utility of IB-50	This is the setup tool included in the CD of IB-50. You can use it on Windows. → IB-50 Operation Guide

 **NOTE**

When you want to switch to the network interface other than Wired (default) after installing an optional Network Interface Kit (IB-50) and a Wireless Network Interface Kit (IB-37/IB-38/IB-51), select the desired setting on [Primary Network].

→ [Primary Network \(page 219\)](#)

For other network settings, refer to the following:

→ [Network \(page 200\)](#)

TCP/IP (IPv4) setting

NOTE

If the user authentication screen appears, log in with a user who has the privilege to configure this setting. If you do not know your login user name or password, please contact your administrator.

1 Display the screen.

[Menu] key > [▲] [▼] key > [Network] > [OK] key > [▲] [▼] key > [Wired Netwk. Set] > [OK] key > [▲] [▼] key > [TCP/IP Settings] > [OK] key > [▲] [▼] key > [IPv4 Setting] > [OK] key

2 Configure the settings.

- When using DHCP server
 - [DHCP]: Configure the settings
- When setting the static IP address
 - [DHCP]: [Off]
 - [Auto-IP]: [Off]
 - [IP Address]: Enter the address.
 - [Subnet Mask]: Enter the subnet mask in decimal representation (0 to 255).
 - [Default Gateway]: Enter the address.
- When using the Auto-IP
 - Enter "0.0.0.0" in IP Address.
- When setting the DNS server
 - In the following cases, set the IP address of DNS (Domain Name System) server.
 - When using the host name with [DHCP] setting set to [Off].
 - When using the DNS server with IP address that is not assigned by DHCP automatically.

Select [Auto (DHCP)] or [Manual]. If you selected [Manual], enter the [Primary Server] and [Secondary Server].

IMPORTANT

After changing the setting, restart the network from System Menu, or turn the machine OFF and then ON.

➔ [Restart Network \(page 220\)](#)

NOTE

Ask your network administrator for the IP address in advance, and have it ready when you configure this setting.

Configuring the Wireless Network

When the optional Wireless Network Interface Kit (IB-37, IB-38, or IB-51) is installed on the machine and the connection settings are configured, it is possible to print in a wireless network (wireless LAN) environment.

➔ [IB-37/IB-38 <Wireless network interface \(USB: 5GHz/2.4GHz\)> \(page 378\)](#)

➔ [IB-51 <Wireless network interface \(KUIO: 2.4GHz\)> \(page 378\)](#)

The configuration methods are as follows:

Configuration Method	Description
Configuring the Connection from the Operation Panel on This Machine	Use Wi-Fi Settings or Wireless Network to configure the network in details from System menu. ➔ Wi-Fi Settings (page 202) ➔ Wireless Network (page 222)
Setting the Connection by Using the Wi-Fi Setup Tool	This is a tool that can be downloaded from Download Center (https://kyocera.info/). You can configure the connection according to the instructions provided by the wizard. ➔ Wired Connection with LAN Cable Using Wi-Fi Setup Tool (page 48)
Setting the Connection by Using the Setup Utility of IB-51	This is the setup tool included in the CD of IB-51. You can use it on both Windows and Mac OS. ➔ IB-51 Operation Guide
Configuring Connections on the Web Page	For the IB-37/IB-38, the connection can be set on the Command Center RX. ➔ Command Center RX User Guide
	For the IB-51, the connection can be set on the dedicated Web page. ➔ IB-51 Operation Guide

NOTE

When you want to switch to the network interface other than Wired (default) after installing an optional Network Interface Kit (IB-50) and a Wireless Network Interface Kit (IB-37/IB-38/IB-51), select the desired setting on [Primary Network].

➔ [Primary Network \(page 219\)](#)

Wired Connection with LAN Cable Using Wi-Fi Setup Tool

To send the Wi-Fi settings configured in the Wi-Fi Setup Tool to the machine, connect the computer or mobile device with the machine locally. To use a wired LAN cable directly connected to the machine, the Auto-IP (Link-local) address will be assigned to the machine and the computer. This machine applies Auto-IP as the default settings.

NOTE

Configure the settings on the operation panel if your computer supports WPS.

→ [Wi-Fi Settings \(page 202\)](#)

→ [Wireless Network \(page 222\)](#)

1 Connect the machine with a computer.

1 Connect the machine with a computer via LAN cable when the machine is powered on.

2 Turn on the computer.

IP addresses (link local addresses) of the machine and computer are generated automatically.

2 Launch the Wi-Fi Setup Tool.

1 Launch your Web browser.

2 Enter "<https://kyocera.info/>" into the browser's address bar or location bar.

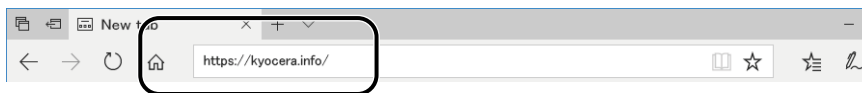

3 Enter and search the product name, and select this product from the candidate list.

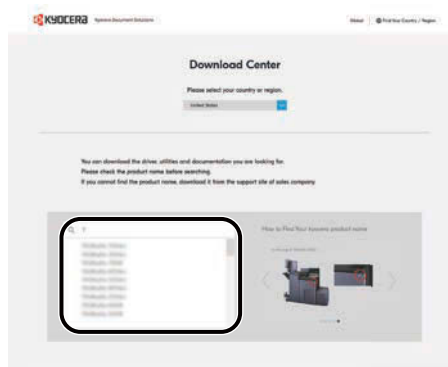

4 Change the selected operating system and its language setting as needed.

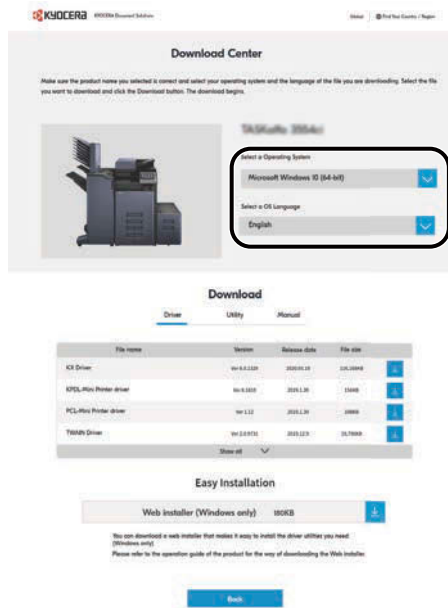

5 Utility tab > [Wi-Fi Setup Tool]

The Wi-Fi Setup Tool will be downloaded.

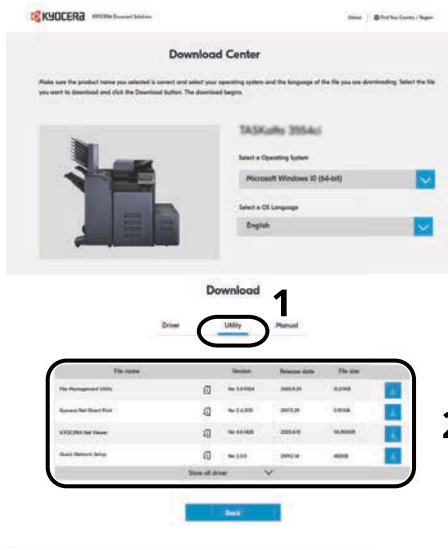

6 Double-click the downloaded installer to launch.

NOTE

- Installation on Windows must be done by a user logged on with administrator privileges.
- If the user account management window appears, click [Yes] (Allow).

3 Configure the settings.

1 [Do not use automatic configuration] > [Next] > [Next]

2 [Use LAN cable] > [Next] > [Next]

3 [Easy setup] > [Next]

The machine is detected.



NOTE

- Only one machine can be searched using Wi-Fi Setup Tool. It may take times to search the machine.
 - If the machine is not detected, select [Advanced setup] > [Next]. Select [Express] or [Custom] as device discovery method and specify the IP address or host name to search the machine.
-

4 Select the machine > [Next]

5 Select [Use the device settings.] on [Authentication mode], and enter the administrator's login user name and password.

6 Configure the communication settings > [Next]

7 Change the settings of access point as necessary > [Next]

The network is configured.

Wireless LAN Connection by Wi-Fi Direct Using Wi-Fi Setup Tool

To send the Wi-Fi settings configured in the Wi-Fi Setup Tool to the machine, connect the computer or mobile device with the machine locally.

To use Wi-Fi Direct, confirm that the Wi-Fi Direct is enabled (Wi-Fi Direct is set to [On]) and Restart Network from the operation panel, before your computer will be connected to this machine with Wi-Fi Direct.

NOTE

Configure the settings on the operation panel if your computer supports WPS.

→ [Wi-Fi Settings \(page 202\)](#)

→ [Wireless Network \(page 222\)](#)

1 Display the screen.

[Menu] key > [▲][▼] key > [Network] > [OK] key > [▲][▼] key > [Wi-Fi Direct Set] > [OK] key > [▲][▼] key > [Wi-Fi Direct] > [OK] key

2 Configure the settings.

[▲][▼] key > [On] > [OK] key

3 Restart the network.

[Menu] key > [▲][▼] key > [Network] > [OK] key > [▲][▼] key > [Restart Network] > [OK] key > [Yes]

4 Connect a computer or a mobile device with the machine.

→ [Setting Wi-Fi Direct \(page 54\)](#)

5 Launch the Wi-Fi Setup Tool.

1 Launch your Web browser.

2 Enter "<https://kyocera.info/>" into the browser's address bar or location bar.



- 3 Enter and search the product name, and select this product from the candidate list.

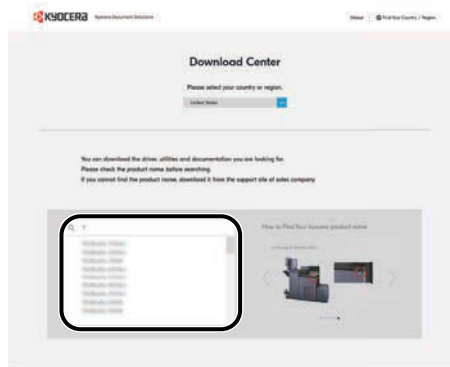

- 4 Change the selected operating system and its language setting as needed.

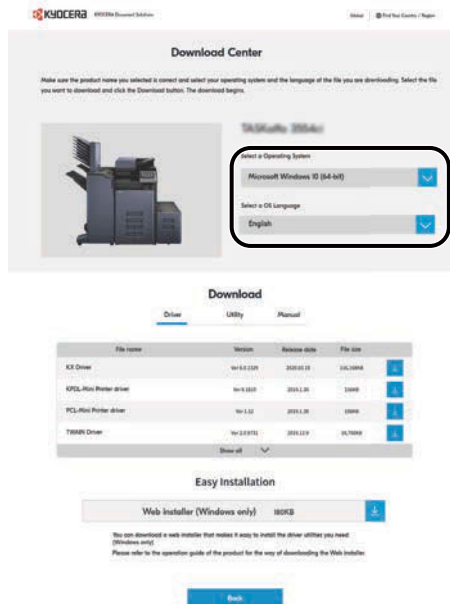

- 5 Utility tab > [Wi-Fi Setup Tool] 
The Wi-Fi Setup Tool will be downloaded.

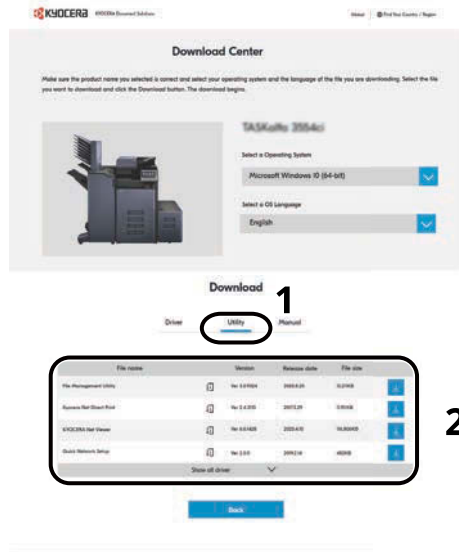

- 6 Double-click the downloaded installer to launch.



NOTE

- Installation on Windows must be done by a user logged on with administrator privileges.
- If the user account management window appears, click [Yes] (Allow).

6 Configure the settings.

- 1 [Do not use automatic configuration] > [Next] > [Next]
- 2 [Wi-Fi Direct] > [Next] > [Next]
- 3 [Advanced setup] > [Next]

Select [Express] or [Custom] as the device discovery method. You can specify an IP address or hostname as the discovery method.
- 4 Select the machine > [Next]
- 5 Select [Use the device settings.] on [Authentication mode], and enter the administrator's login user name and password.
- 6 Configure the communication settings > [Next]
- 7 Change the settings of access point as necessary > [Next]

The network is configured.

Setting Wi-Fi Direct

When the Optional Wireless Network Interface Kit (IB-37/IB-38) is installed on the machine and the connection settings are configured, this enables you to print from the Wi-Fi Direct environment. The configuration methods are as follows:

- Configuring the connection from the operation panel on this machine
- Configuring the connection by using push button

Connecting to Computers or Mobile Devices that Support Wi-Fi Direct

1 Display the screen.

[Menu] key > [▲][▼] key > [Network] > [OK] key > [▲][▼] key > [Wi-Fi Direct Set] > [OK] key > [▲][▼] key > [Wi-Fi Direct] > [OK] key

2 Configure the settings.

[▲][▼] key > [On] > [OK] key

3 Restart the network.

[Menu] key > [▲][▼] key > [Network] > [OK] key > [▲][▼] key > [Restart Network] > [OK] key > [Yes]

4 Specify the machine name from the computer or mobile device.

If a confirmation message appears on the operation panel of the machine, select [Yes].

The network between this machine and the computer or mobile device is configured.

Connecting to Computers or Mobile Devices Unsupported Wi-Fi Direct

Here, we'll explain the procedures for connecting to iOS mobile devices.

1 Display the screen.

[Menu] key > [▲][▼] key > [Network] > [OK] key > [▲][▼] key > [Wi-Fi Direct Set] > [OK] key > [▲][▼] key > [Wi-Fi Direct] > [OK] key

2 Configure the settings.

[▲][▼] key > [Enable] > [OK] key

3 Restart the network.

[Menu] key > [▲][▼] key > [Network] > [OK] key > [▲][▼] key > [Restart Network] > [OK] key > [Yes]

4 [Status] > [▲][▼] key > [Wi-Fi Direct] > [OK] key > [▲][▼] key > [Detail Info] > [OK] key

5 Use the [◀][▶] keys to check the network name (SSID), password, and IP address, and note them.

6 Configure the mobile device.

1 [Settings] > [Wi-Fi]

2 Select the network name (SSID) appeared in step 5 from the list.

3 Enter the password that was provided in step 5 > [Connect]

The network between this machine and the computer or mobile device is configured.

Configuring the Connection by Using Push Button

When your computer or mobile device does not support Wi-Fi Direct but supports WPS, you can configure the network using push button.

1 Display the screen.

[Menu] key > [▲][▼] key > [Network] > [OK] key > [▲][▼] key > [Wi-Fi Direct Set] > [OK] key > [▲][▼] key > [Wi-Fi Direct] > [OK] key

2 Configure the settings.

[▲][▼] key > [Enable] > [OK] key

3 Restart the network.

[Menu] key > [▲][▼] key > [Network] > [OK] key > [▲][▼] key > [Restart Network] > [OK] key > [Yes]

4 [Status] > [▲][▼] key > [Wi-Fi Direct] > [OK] key > [PushButton Setup] > [OK] key

5 Press the push button on the computer or mobile device to be connected > [Next]

The network between this machine and the computer or mobile device is configured.

 **IMPORTANT**

You can connect up to ten mobile devices at the same time using Wi-Fi Direct setting. When the devices that support Wi-Fi Direct are connected, if you want to connect other device, disconnect the already connected devices from the network. The disconnection methods are as follows:

- Disconnect the network from the computer or handheld computer
 - Disconnecting all devices from the network on the operation panel
Select [Status] > [▲][▼] key > [Wi-Fi Direct] > [OK] key > [ConnectionStatus] > [OK] key > [Menu] > [Disconnect All] > [OK] key in this order.
 - Configuring auto disconnecting time from the System menu
➔ [Wi-Fi Direct Set \(page 201\)](#)
 - Configuring auto disconnecting time from the Command Center RX
➔ **Command Center RX User Guide**
-

Energy Saver function

If a certain period of time elapses after the machine is last used, the machine automatically enters Sleep to minimize power consumption.

Sleep

Panel and all indicators on the operation panel will go out to save a maximum amount of power except the Energy Saver indicator. This status is referred to as Sleep.

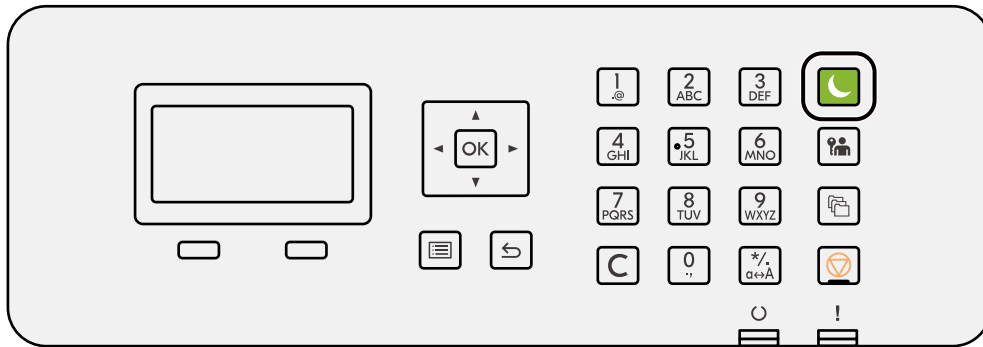

If print data is received during Sleep, the machine automatically wakes up and starts printing.

In addition, the machine wakes up when the following operations are performed:

- Select the [Energy Saver] key.

Recovery time from Sleep Mode is as follows.

6.0 seconds or less

Note that ambient environmental conditions, such as ventilation, may cause the machine to respond more slowly.

Auto Sleep

Function that automatically switches the machine into Sleep if left idle for a preset time. Switch time has a factory default of 1 minute.

When using this machine, select the [Energy Saver] key.

You will be able to use again within 6 seconds.

Note that ambient environmental conditions, such as ventilation, may cause the machine to respond more slowly.

The procedure for specifying the switch time for the sleep function is explained below.

1 Display the screen

[Menu] key > [▲][▼] key > [Device Common] > [OK] key > [▲][▼] key > [Timer Setting] > [OK] key > [▲][▼] key > [Sleep Timer] > [OK] key

2 Configure the settings.

- 1 Input the sleep time.



NOTE

The time can be set between 1 and 120 minutes.

Select [▲] or [▼] key and enter a value.

- 2 Select the [OK] key.

Status (Sleep Level Set.)

You can set whether sleep mode operates for each function. When the machine enters sleep mode, the ID card cannot be recognized.

For more information on Status, refer to the following:

➔ [Status \(page 229\)](#)

Power Off Rule

The Power Off Rule is used to stop the power from automatically turning off.

The default preset time is 3 days.

For more information on Power Off Rule settings, refer to the following:

➔ [Power Off Rule \(page 230\)](#)

Installing Software

To use printer function, download and install the required software from Download Center (<https://kyocera.info/>).

Published Software (Windows)

Software	Description	Recommended software
KX DRIVER	This driver enables files on a computer to be printed by the machine. Multiple page description languages (PCL XL, KPD, etc.) are supported by a single driver. This printer driver allows you to take full advantage of the features of the machine. Use this driver to create PDF files.	○
KPD mini-driver/PCL minidriver	This is a Microsoft MiniDriver that supports PCL and KPD. There are some restrictions on the machine features and option features that can be used with this driver.	—
KYOCERA Net Viewer	This is a utility that enables monitoring of the machine on the network.	—
Status Monitor 5	This is a utility that monitors the printer status and provides an ongoing reporting function.	○
KYOCERA Net Direct Print	This makes it possible to print a PDF file without starting Adobe Acrobat/Reader.	—
FONTS	These are display fonts that enable the machine's built-in fonts to be used in a software application.	○
Quick Network Setup Tool	A tool to configure the network (wired LAN) settings of the machine.	—
Wi-Fi Setup Tool	A tool to configure the wireless network (wireless LAN) settings of the machine.	—

NOTE

- Installation on Windows must be done by a user logged on with administrator privileges.

Installing Software in Windows

Downloading and installing from the website

Download and install a software from our website.

1 Download a software from the website.

- 1 Launch your Web browser.
- 2 Enter "<https://kyocera.info/>" into the browser's address bar or location bar.

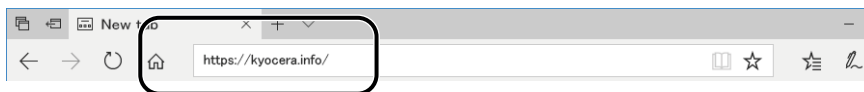

- 3 Enter and search the product name, and select this product from the candidate list.

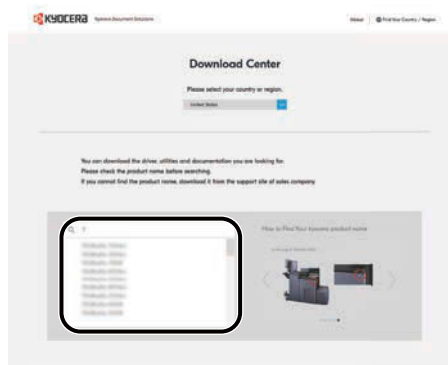

- 4 Change the selected operating system and its language setting as needed.

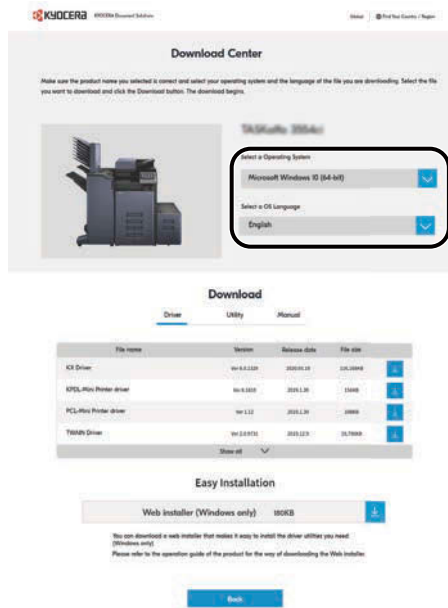

- 5 Driver tab or Utility tab >  of the software you want to download. An installer of the selected software will be downloaded.

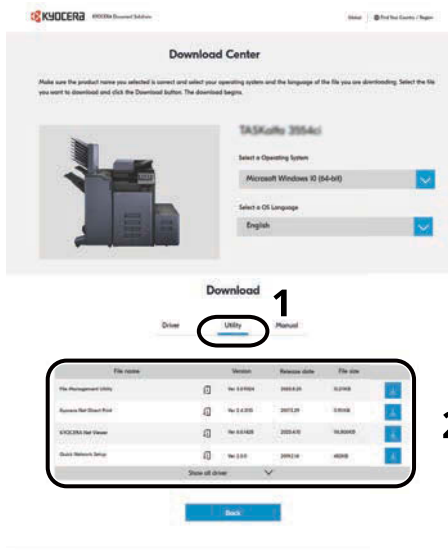

2 Double-click the downloaded installer to launch.

Follow the guidance on the screen to install the software.



NOTE

- Installation on Windows must be done by a user logged on with administrator privileges.
- If the user account management window appears, click [Yes] (Allow).

Using the web installer

Install a software by using a web installer downloaded from our website.

1 Download a software from the website.

- 1 Launch your Web browser.
- 2 Enter "<https://kyocera.info/>" into the browser's address bar or location bar.

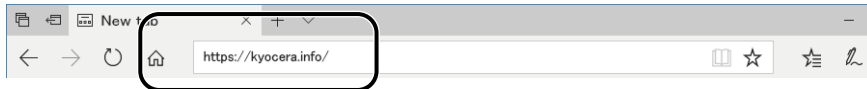

- 3 Enter and search the product name, and select this product from the candidate list.

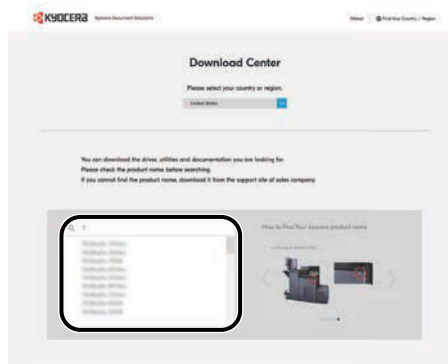

- 4 Change the selected operating system and its language setting as needed.

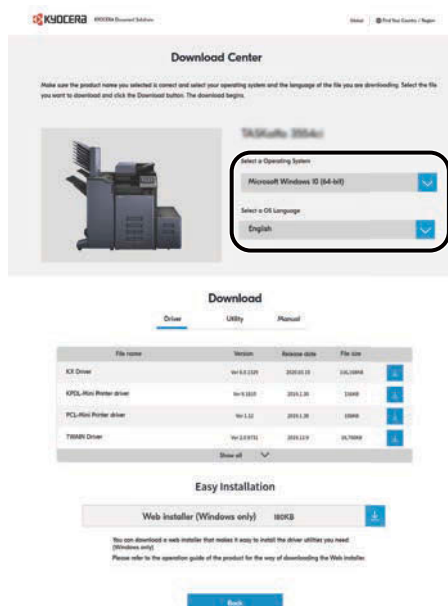

- Utility tab >  of "Web installer".
A web installer will be downloaded.

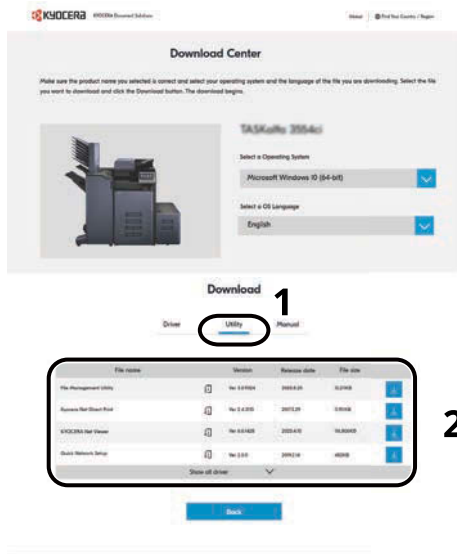

2 Double-click the downloaded installer to launch.



NOTE

- Installation on Windows must be done by a user logged on with administrator privileges.
- If the user account management window appears, click [Yes] (Allow).

3 Display the screen.

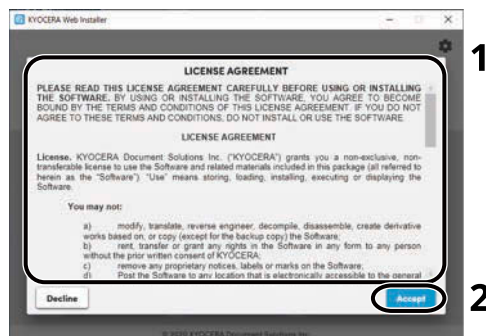

- 1 Read the license agreement.
- 2 Click [Accept] if there is no problem.

4 Click [Install].

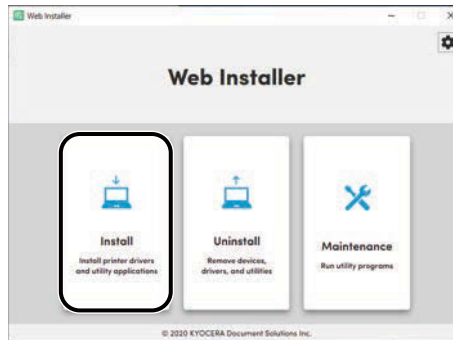

5 Select a model and click [Next].

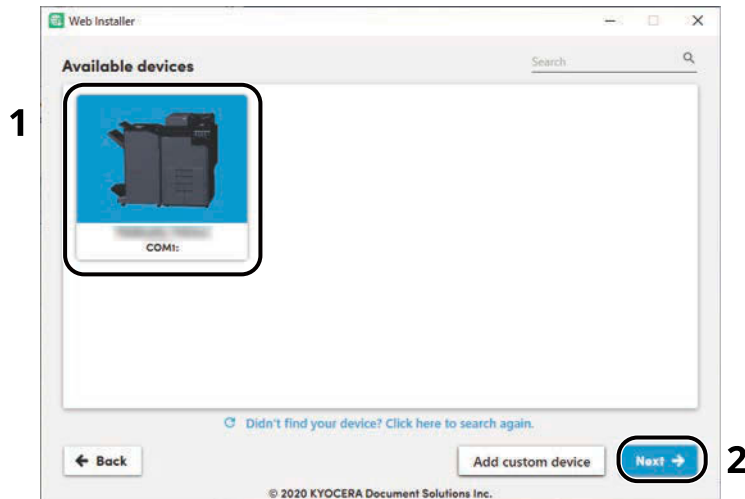

NOTE

- The machine cannot be detected unless it is on. If the computer fails to detect the machine, verify that it is connected to the computer via a network or USB cable.
- If a desired device is not displayed, select [Add custom device] to directly select the device you want to use.

6 Install the software.

- 1 Select software you want to install.

NOTE

Software recommended to install have in their checkboxes by default. Change as required.

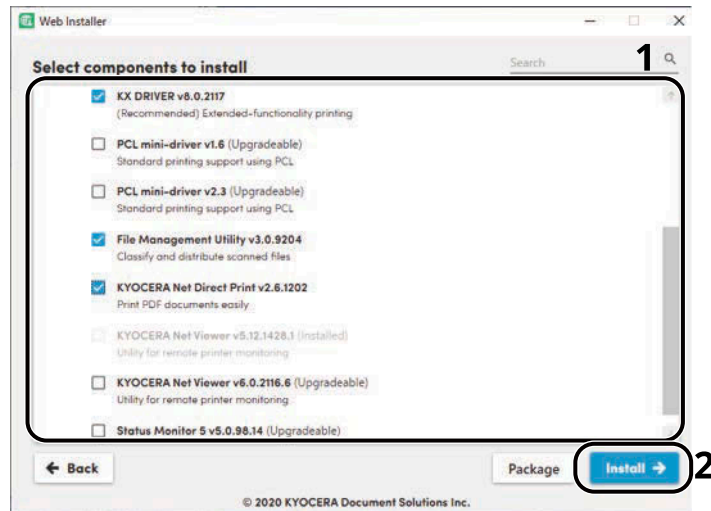

2 Click [Install].

When [Install] is clicked, a screen which asks for cooperation for data collection may appear. Select one of the answer choices and click [OK].

 **NOTE**

- If the Windows security window appears, click [Install this driver software anyway].
- To install Status Monitor for Windows 8.1, it is necessary to install Microsoft.NET Framework 4.0 beforehand.

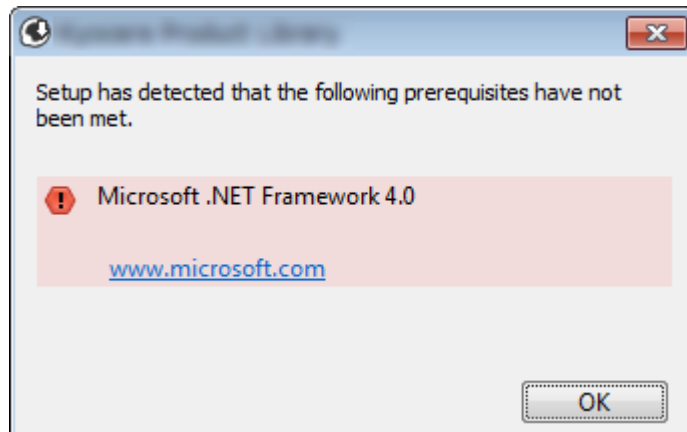

7 Finish the installation.

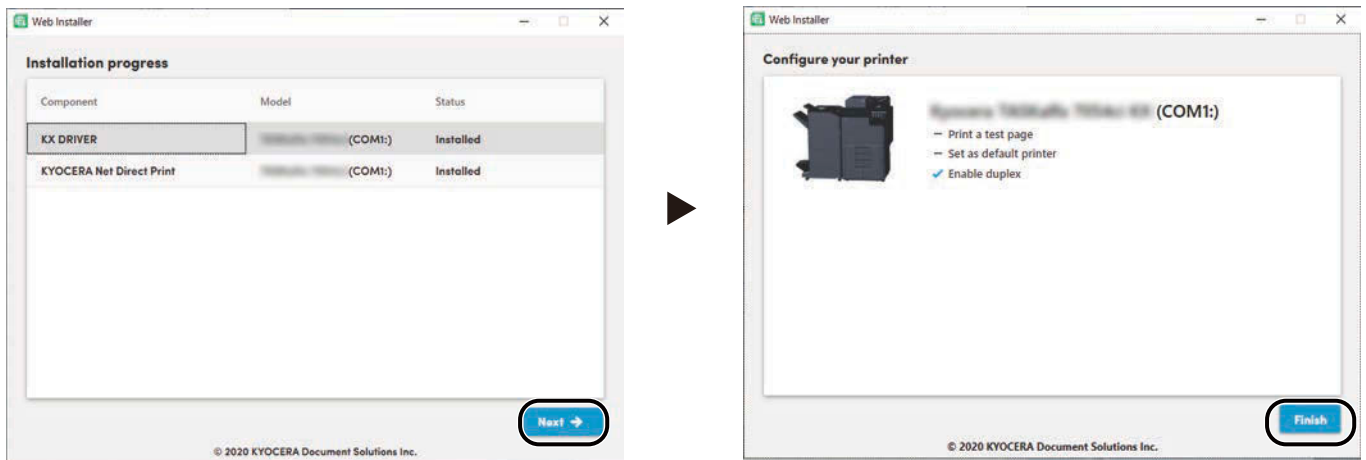

Click [Next] > [Finish] to finish the installation wizard.

If a system restart message appears, restart the computer by following the screen prompts. This completes the printer driver installation procedure.

5 Finish uninstalling.

Click [Finish].

Restart the system for the uninstall to take effect.

Installing Software on a Mac OS Computer

A printer driver can be installed for a Macintosh computer.

NOTE

- Installation on Mac OS must be done by a user logged on with administrator privileges.
- When installing for a Mac, set the machine's emulation to [KPD/L] or [KPD/L (Auto)].
 - ➔ [Print Settings \(page 193\)](#)
- If connecting by Bonjour, enable Bonjour in the machine's network settings.
 - ➔ [\[Bonjour\] \(page 212\)](#)
- In the Authenticate screen, enter the name and password used to log in to the operating system.
- When printing via AirPrint, you do not have to install the software.

1 Download a software from the website.

- 1 Launch your Web browser.
- 2 Enter "<https://kyocera.info/>" into the address bar.

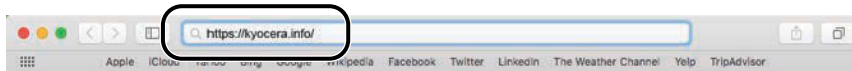

- 3 Enter and search the product name, and select this product from the candidate list.

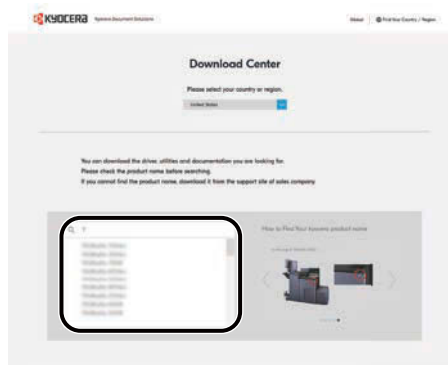

- 4 Change the selected operating system and its language setting as needed.

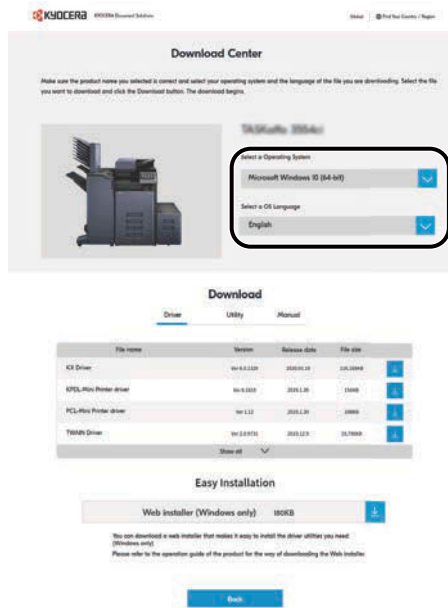

- 5 Driver tab > "Mac Printer Driver (x.x and later)" 
An installer of the selected software will be downloaded.

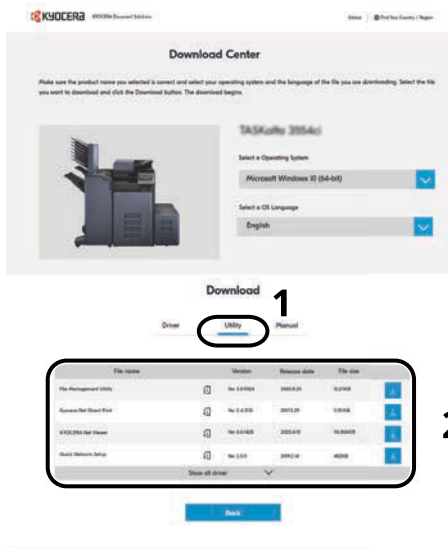

2 Install the Printer Driver.

Double click to launch the downloaded installer.

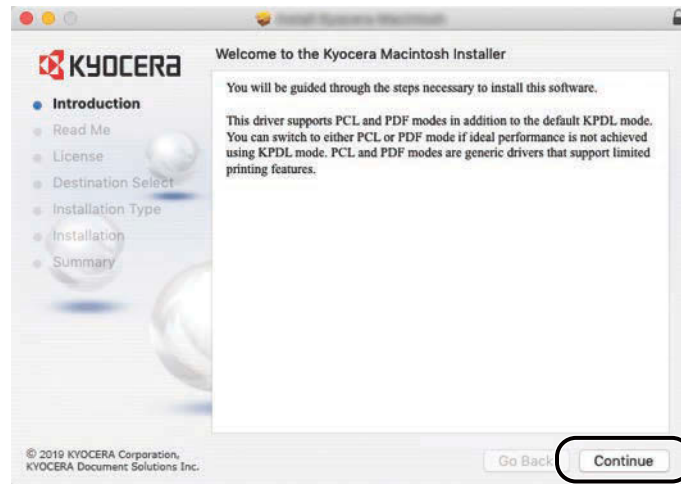

Install the printer driver as directed by the instructions in the installation software. This completes the printer driver installation.

If a USB connection is used, the machine is automatically recognized and connected. If an IP connection is used, the settings below are required.

3 Configure the printer.

- 1 Open System Preferences and add the printer.

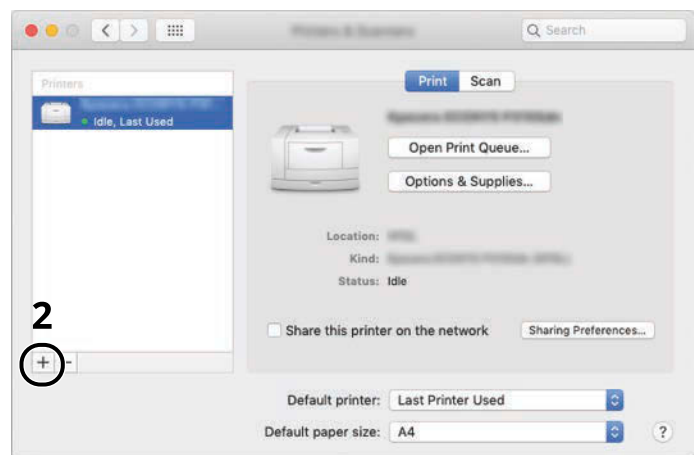
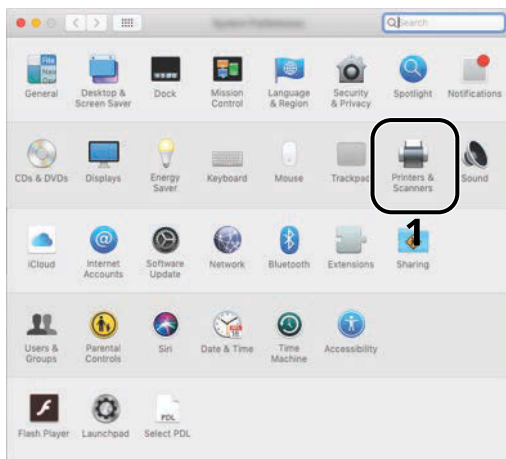

- 2 Select [Default] and click the item that appears in "Name" and then select the driver in Use.

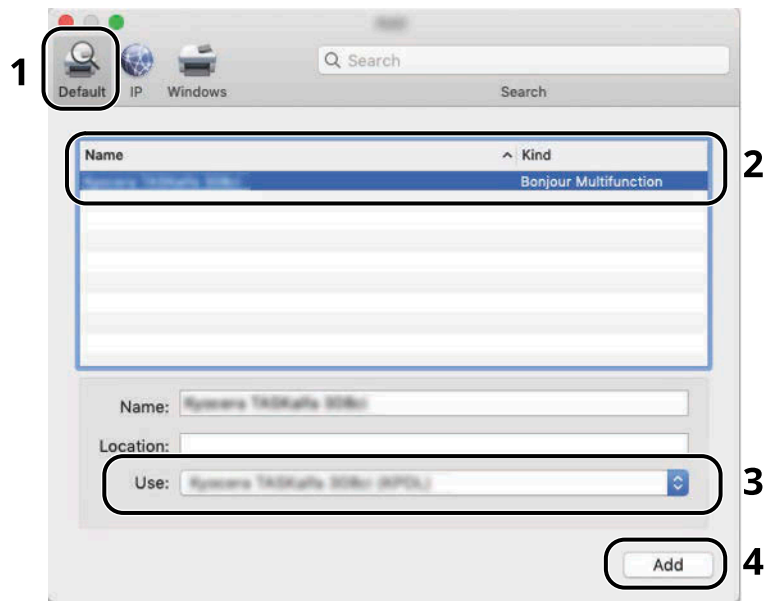

The selected machine is added.

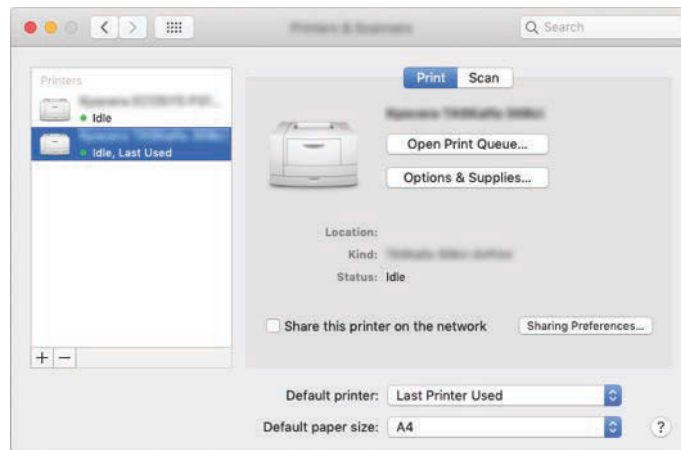

 **NOTE**

When using an IP connection, click the IP icon for an IP connection and then enter the host name or IP address. The number entered in "Address" will automatically appear in "Name". Change as required.

3 Select the options equipped with the machine.

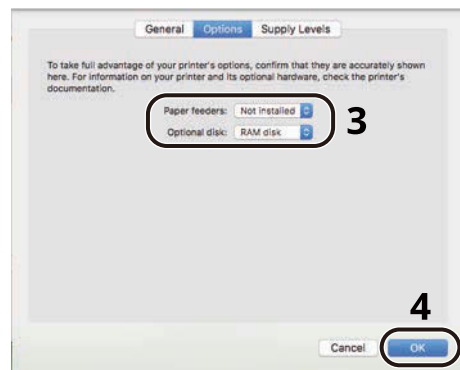
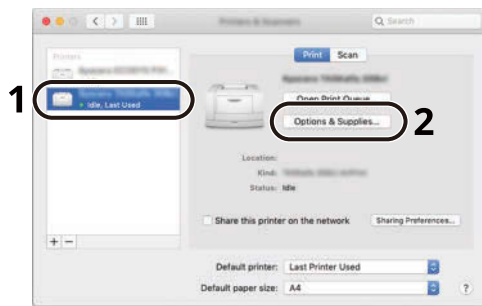

Checking the Counter

Check the number of sheets printed and scanned.

1 Display the screen.

[Menu] key > [▲] [▼] key > [Counter] > [OK] key

2 Check the counter

Select the item you wish to check, and select the [OK] key.

Additional Preparations for the Administrator

Administrator Privileges Overview

This machine is shipped with two default users registered one with Machine Administrator privileges, and another with Administrator privileges. The user with Machine Administrator privileges and the user with Administrator privileges can configure important settings for the machine. The differences in the privileges are as follows:

User with Machine Administrator privileges

This user can configure the product's network settings, security settings such as user registration, and the machine's security level.

➔ [Security Level \(page 239\)](#)

User with Administrator privileges

This user can configure the product's network settings, and security settings such as user registration. This user cannot set the machine's security level.

Log in as Machine Administrator or Administrator

The user with Machine Administrator privileges or the user with Administrator privileges must log in to configure important settings for the product, such as network settings and security settings. The factory default login user name and login password are set as shown below.

Machine Administrator

User Name	DeviceAdmin
Login User Name	ECOSYS PA4500cx:4500, ECOSYS PA4000cx:4000, ECOSYS PA3500cx:3500
Login Password	ECOSYS PA4500cx:4500, ECOSYS PA4000cx:4000, ECOSYS PA3500cx:3500

Administrator

User Name	Admin
Login User Name	Admin
Login Password	xxxxxxxxxx (Serial Number) ➔ Checking the Equipment's Serial Number (page 2)

IMPORTANT

To ensure security, be sure to change the factory default user name, login user name, and login password. Also, change your password regularly.

➔ [Changing User Properties for Local Users \(Admin, DeviceAdmin, PowerUser\) \(page 252\)](#)

Strengthening the Security

This machine is shipped with two default users registered one with Machine Administrator rights, and another with Administrator rights. Logging in as this user will allow you to configure all settings; therefore, please change the login user name and password.

In addition, this machine is equipped with user authentication function, which can be configured to limit the access to this machine to only those who have a registered login name and password. For details, refer to the following:

➔ [User Authentication and Accounting \(User Login, Job Accounting\) \(page 247\)](#)

NOTE

This product has an optional security chip called TPM (UG-50) (Trusted Platform Module). The encryption key used to encrypt confidential information on this machine is stored in a dedicated storage area on the TPM chip. Since this storage area cannot be read from outside the TPM, confidential information can be safely protected.

Restrict the users of the machine

- User Login
 - ➔ [Overview of User Login Administration \(page 248\)](#)
- Authentication Security
 - ➔ [Authentication Security \(page 250\)](#)
- Auto Panel Reset
 - ➔ [Auto Panel Reset \(page 229\)](#)
- ID Card Settings

The optional IC Card Authentication Kit is required.

 - ➔ [ID Card Settings \(page 261\)](#)

Prevent another user from handling the documents stored in the machine

- Custom Box

Requires the optional SSD.

 - ➔ [What is Custom Box? \(page 145\)](#)

Output the document stored in the machine at the time when user operates the device via operation panel

- Remote Printing
 - ➔ [Remote Printing \(page 234\)](#)

Prevent the data stored in the machine from being leaked

- Data Overwrite

Requires the optional SSD.

It is necessary to activate the Data Security Function.

 - ➔ **Data Encryption / Overwrite Operation Guide**

- Encryption
Requires the optional SSD.
It is necessary to activate the Data Security Function.
➔ **Data Encryption / Overwrite Operation Guide**

Completely delete the data on the machine before disposing of the machine

- Data Sanitization
➔ [DataSanitization \(page 240\)](#)

Protect the transmission from interception and wiretapping

- IPP over TLS
➔ [IPP over TLS \(page 215\)](#)
- HTTPS
➔ [HTTPS \(page 215\)](#)
- SMTP Security
➔ [Off/On \(page 213\)](#)
- POP3 Security
➔ [Off/On \(page 214\)](#)
- Enhanced WSD (TLS)
➔ [EnhancedWSD\(TLS\) \(page 217\)](#)
- IPSec
➔ [Off/On \(page 212\)](#)
- SNMPv3
➔ [SNMPv3 \(page 213\)](#)

Verify the software in the machine

- Software Verification
➔ [SW Verification \(page 241\)](#)

Preventing from execution of the unauthorized programs

- Allowlisting
➔ [Allowlisting \(page 242\)](#)

Command Center RX

If the machine is connected to the network, you can configure various settings using Command Center RX. This section explains how to access Command Center RX, and how to change security settings and the host name.

➔ Command Center RX User Guide

NOTE

To fully access the features of the Command Center RX pages, you must enter the user name and password and log in. Entering the predefined administrator password allows the user to access all pages, including document box and settings on the navigation menu.

Settings that the administrator and general users can configure in Command Center RX are as follows.

Setting	Description	Administrator	General User
Device Information/ Remote Operation	The machine's structure can be checked.	Yes	Yes
Job Status	Displays all device information, including print and scan jobs, storing jobs, scheduled jobs, and job log history.	Yes	Yes
Document Box	Add or delete document boxes, or delete documents within a document box. The logged in user may not be able to configure some settings, depending on the privilege of the user.	Yes	Yes
Device Settings	Configure the advanced settings of the machine.	Yes	No
Function Settings	Configure the advanced function settings.	Yes	No
Network Settings	Configure the network advanced settings.	Yes	No
Security Settings	Configure the security advanced settings.	Yes	No
Management Settings	Configure the advanced management settings.	Yes	No

Accessing Command Center RX

1 Display the screen.

- 1 Launch your Web browser.
- 2 In the address or location bar, enter the machine's IP address or the host name.
Click in the following order to check the machine's IP address and the host name.

In the home screen [Status] > [▲][▼] key > [Network] > [OK] key[]

Example: https://10.180.81.1 (in the case of /IP address)

https://MFP001 (if the host name is MFP001)

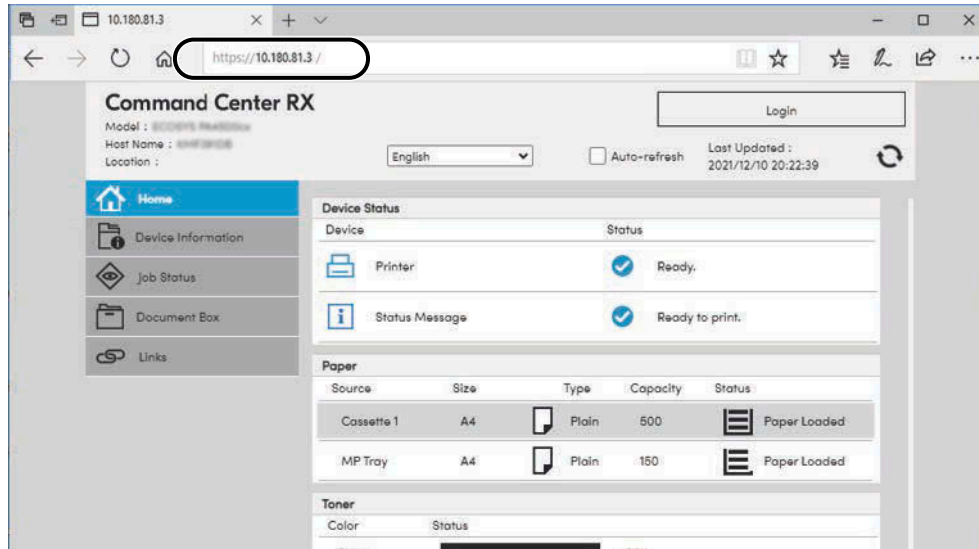

The web page displays basic information about the machine and Command Center RX as well as their current status.



NOTE

If the screen "There is a problem with this website's security certificate." is displayed, configure the certificate.

➔ **Command Center RX User Guide**

You can also continue the operation without configuring the certificate.

2 Configure the settings.

Select a category from the navigation bar on the left of the screen.



NOTE

To fully access the features of the Command Center RX pages, you must enter the user name and password and log in. Entering the predefined administrator password allows the user to access all pages, including document box and settings on the navigation menu.

Changing Security Settings

1 Display the screen.

- 1 Launch your Web browser.
- 2 In the address or location bar, enter the machine's IP address or the host name.
Click in the following order to check the machine's IP address and the host name.
In the home screen [Status] > [▲][▼] key > [Network] > [OK] key[]
- 3 Log in with administrator privileges.

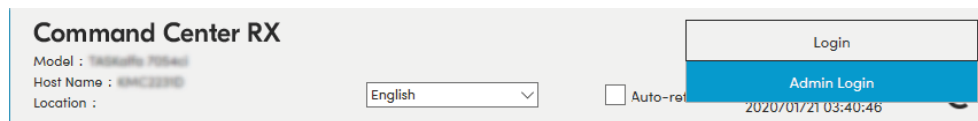

- 4 Click [Security Settings].

2 Configure the settings.

From the [Security Settings] menu, select the setting you want to configure.



NOTE

For details on settings related to certificates, refer to the following:

- ➔ [Command Center RX User Guide](#)
-

Changing Device Information

1 Display the screen.

- 1 Launch your Web browser.
- 2 In the address or location bar, enter the machine's IP address or the host name.
Click in the following order to check the machine's IP address and the host name.
In the home screen [Status] > [▲][▼] key > [Network] > [OK] key[]
- 3 Log in with administrator privileges.

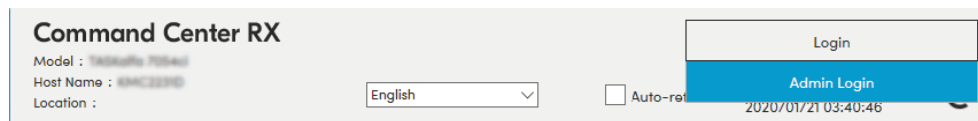

- 4 Click [System] from the [Device Settings] menu.

2 Specify the host name.

Enter the device information, and then click [Submit].

 **IMPORTANT**

After changing the setting, restart the network or turn the machine OFF and then ON. To restart the network interface card, click [Reset] in the [Management Settings] menu, and then click [Restart Network] in "Restart".

SMTP and E-mail Settings

By configuring the SMTP settings, it is possible to send the images scanned by the machine as E-mail attachments and to send E-mail notices when jobs have been completed. To use this function, this machine must be connected to a mail server using the SMTP protocol.

In addition, configure the following.

SMTP settings

"SMTP Protocol" and "SMTP Server Name" in "SMTP"

The sender address when the machine sends E-mails

"Sender Address" in "E-mail Send Settings"

The setting to limit the size of E-mails

"E-mail Size Limit" in "E-mail Send Settings"

The procedure for specifying the SMTP settings is explained below.

1 Display the screen.

Display the SMTP Protocol screen.

- 1 Launch your Web browser.
- 2 In the address or location bar, enter the machine's IP address or the host name.
Click in the following order to check the machine's IP address and the host name.
In the home screen [Status] > [▲][▼] key > [Network] > [OK] key[]
- 3 Log in with administrator privileges.

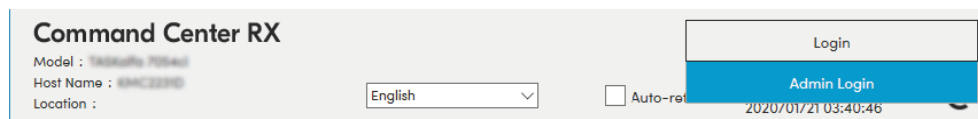

- 4 Click [Protocol] from the [Network Settings] menu.

2 Configure the settings.

Set "SMTP (E-mail TX)" to [On] in the "Send Protocols".

3 Display the screen.

Display the E-mail Settings screen.

Click [E-mail] from the [Function Settings] menu.

4 Configure the settings.

Enter "SMTP" and "E-mail Send Settings" items.

SMTP

Set to send e-mail from the machine.

[SMTP Protocol]

Displays the SMTP protocol settings. Check that [SMTP Protocol] is set to [On]. If [Off] is set, click [Protocols] and set the SMTP protocol to [On].

[SMTP Server Name]

Enter the host name or IP address of the SMTP server. Be sure to enter the items.

[SMTP Port Number]

Specify the port number to be used for SMTP. The default port number is 25.

[SMTP Server Timeout]

Set the amount of time to wait before time-out in seconds.

[Authentication Protocol]

To use SMTP authentication, enter the user information for authentication.

[Connection Test]

Tests to confirm the proper operation under the settings without sending an email.

[Domain Restrictions]

To restrict the domains, click the [Domain List] and enter the domain names of addresses to be allowed or rejected. Restriction can also be specified by e-mail address.

POP3

You don't need to set the items when you only use the function of sending e-mail from the machine. Set the items if you want to enable the function of receiving e-mail on the machine.

➔ [Command Center RX User Guide](#)

E-mail Send Settings

[E-mail Size Limit]

Enter the maximum size of E-mail that can be sent in kilobytes. When E-mail size is greater than this value, an error message appears and E-mail sending is canceled. Use this setting if you have set E-mail Size Limit for SMTP server. If not, enter a value of 0 (zero) to enable E-mail sending regardless of the size limit.

[Sender Address]

Specify the sender address for when the machine sends E-mails, such as the machine administrator, so that a reply or non-delivery report will go to a person rather than to the machine. The sender address must be entered correctly for SMTP authentication. The maximum length of the sender address is 256 characters. Be sure to enter the items.

[Signature]

Enter the signature. The signature is free form text that will appear at the end of the E-mail body. It is often used for further identification of the machine. The maximum length of the signature is 512 characters.

[Function Default]

Change the function default settings in [Customize Status Display] page.

5 Click [Submit].

Creating a New Custom Box

NOTE

An optional SSD is required to use the Custom Box.

1 Display the screen.

- 1 Launch your Web browser.
- 2 In the address or location bar, enter the machine's IP address or the host name.
Click in the following order to check the machine's IP address and the host name.
In the home screen [Status] > [▲][▼] key > [Network] > [OK] key[]
- 3 In the [Document Box] menu, click [Custom Box].

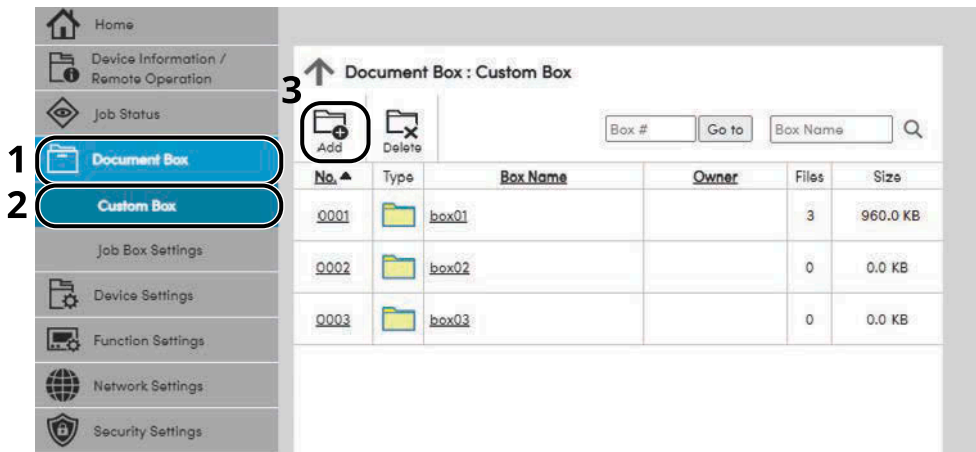

- 4 Click [Add].

2 Configure the Custom Box.

- 1 Enter the box details.
Enter the information for the custom box you want to register. For details on the fields to populate, refer to the following:
➔ **Command Center RX User Guide**
- 2 Click [Submit].

Printing a Document Stored in a Custom Box

1 Display the screen.

- 1 Launch your Web browser.
- 2 In the address or location bar, enter the machine's IP address or the host name.
Click in the following order to check the machine's IP address and the host name.
In the home screen [Status] > [▲][▼] key > [Network] > [OK] key[]
- 3 In the [Document Box] menu, click [Custom Box].

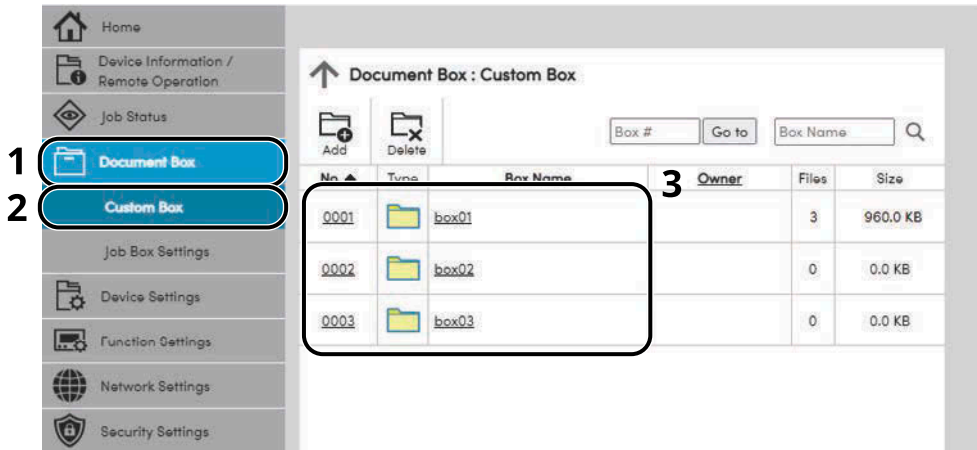

- 4 Click the number or name of the Custom Box in which the document is stored.

2 Print the document.

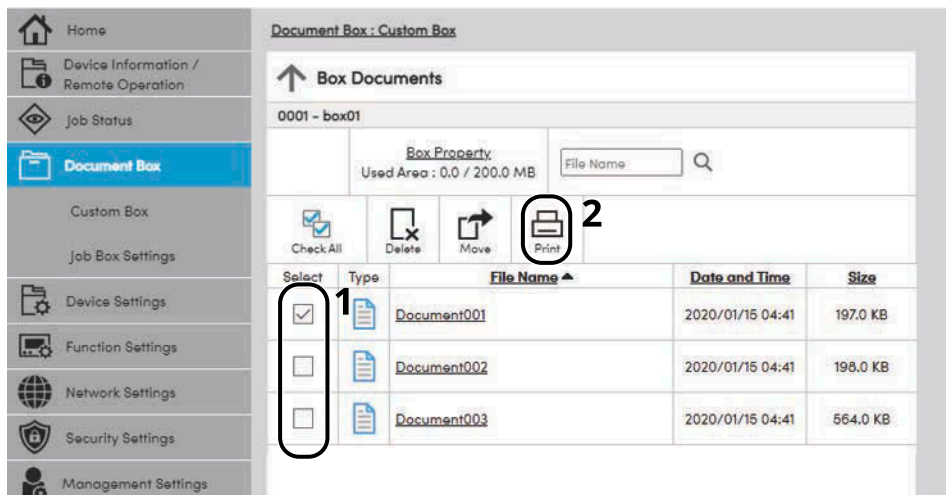

- 1 Select the document you wish to print.
Select the checkbox of the document to be printed.

- 2 Click [Print].
- 3 Configure settings for printing, click [Print].

3 Preparation before Use

Load Paper

Loading Paper

Load paper in the cassettes and multipurpose tray.

For the paper load methods for each cassette, refer to the page below.

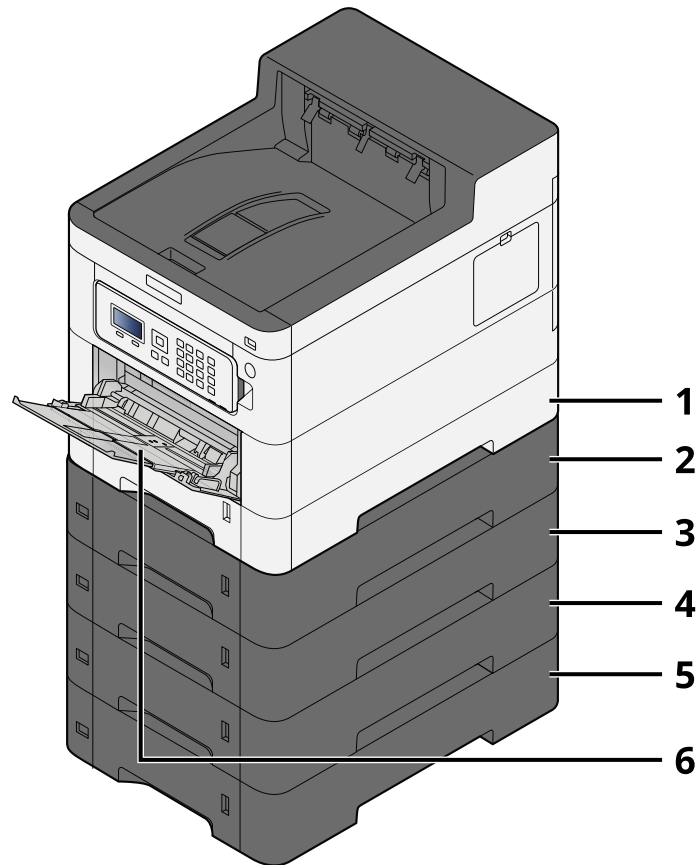

- 1 Cassette 1
➔ [Loading in the Cassettes \(page 92\)](#)
- 2 Cassette 2
➔ [Loading in the Cassettes \(page 92\)](#)
- 3 Cassette 3
➔ [Loading in the Cassettes \(page 92\)](#)
- 4 Cassette 4
➔ [Loading in the Cassettes \(page 92\)](#)
- 5 Cassette 5
➔ [Loading in the Cassettes \(page 92\)](#)
- 6 MultipurposeTray
➔ [Loading Paper in the Multipurpose Tray \(page 96\)](#)

 **NOTE**

- The number of sheets that can be held varies depending on your environment and paper type (thickness).
 - Do not use inkjet printer paper or paper with special coatings. (Doing so may lead to failures such as paper jams.)
 - Use paper made for color printing if you want higher-quality color prints.
-

Precaution for Loading Paper

When you open a new package of paper, fan the sheets to separate them slightly prior to loading in the following steps.

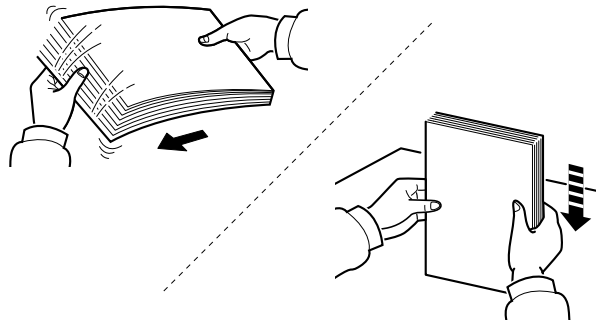

Fan the paper, then tap it on a level surface. In addition, note the following points.

- If the paper is curled or folded, straighten it before loading. Paper that is curled or folded may cause a jam.
- Avoid exposing opened paper to high temperatures and high humidity as dampness can be a cause of problems. Seal any remaining paper after loading in the multipurpose tray or cassettes back in the paper storage bag.
- If the machine will not be used for a prolonged period, protect all paper from humidity by removing it from the cassettes and sealing it in the paper storage bag.

IMPORTANT

If you copy onto used paper (paper already used for printing), do not use paper that is stapled or clipped together. This may damage the machine or cause poor image quality.

NOTE

If you use special paper such as letterhead, paper with holes or paper with pre-prints like logo or company name, refer to the following:

➔ [About Paper \(page 386\)](#)

Paper Specifications available in the Cassettes

The cassettes can hold plain paper, recycled paper or color paper. The number of sheets that can be loaded in each cassette is shown below.

Cassette	Capacity
Cassettes 1 to 5	550 sheets (75 g/m ²)

For details of the supported paper sizes, refer to the following:

→ [Choosing the Appropriate Paper \(page 387\)](#)

 **NOTE**

A5 and A6 paper cannot be loaded in cassettes 2 to 5. (A5-R size can be set)

For the paper type setting, refer to the following:

→ [Media Type Set. \(page 191\)](#)

 **IMPORTANT**

- The cassettes 1 to 5 can hold paper with weight between 60 and 220 g/m².
 - If you are using a paper weight of 106 g/m² or more, set the media type to Thick and set the weight of the paper you are using.
-

Loading in the Cassettes

- 1 Pull the cassette completely out of the machine.

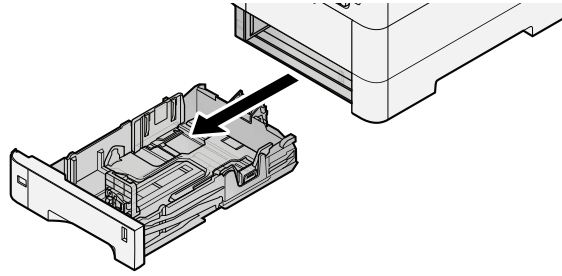

NOTE

When pulling the cassette out of the machine, ensure it is supported and does not fall out.

- 2 Adjust the cassette size.

- 1 Adjust the position of the paper width guides located on the left and right sides of the cassette. Press the paper width adjusting tab and slide the guides to the paper size required.

Paper sizes are marked on the cassette.

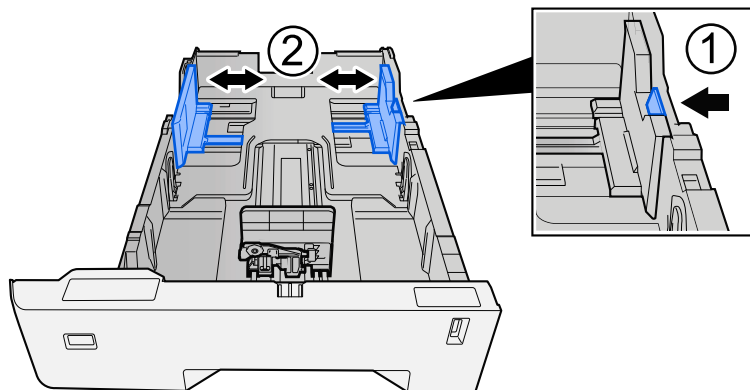

- 2 Adjust the paper length guide to the paper size required. Press the paper length adjusting tab and slide the guides to the paper size required.

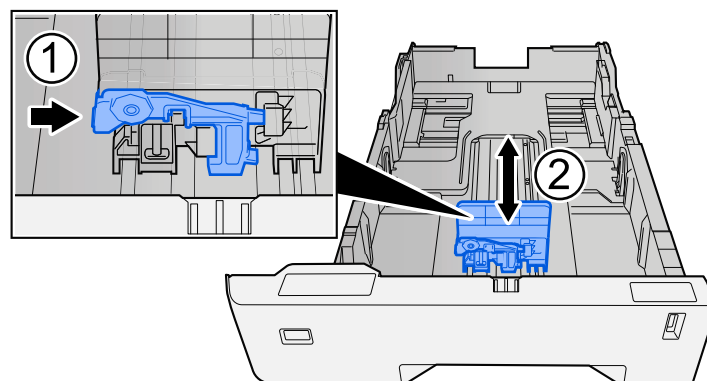

- 3 Turn the size dial so that the size of the paper you are going to use appears in the paper size window.

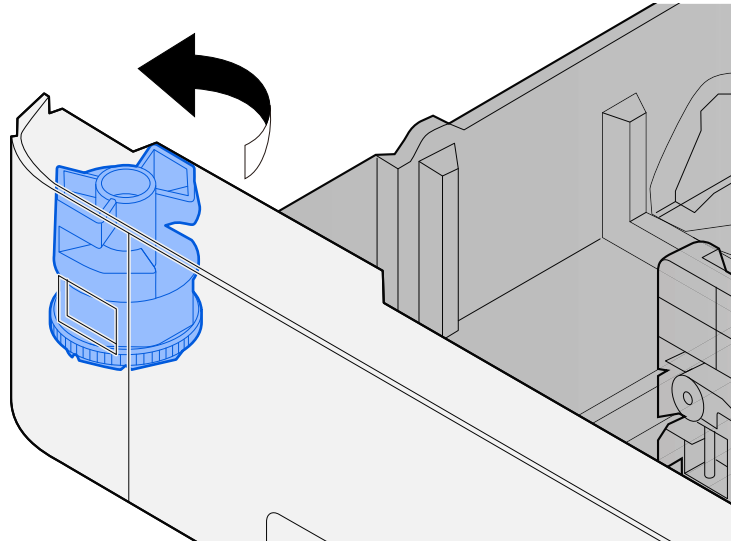

NOTE

Set the size dial to Other if you wish to use paper that is other than the Standard Size. In this case, it is necessary to set the paper size from the operation panel.

→ [Specifying Paper Size and Media Type \(page 99\)](#)

3 Load paper.

- 1 Fan the paper, then tap it on a level surface to avoid paper jams or skewed printing.
- 2 Load the paper in the cassette.

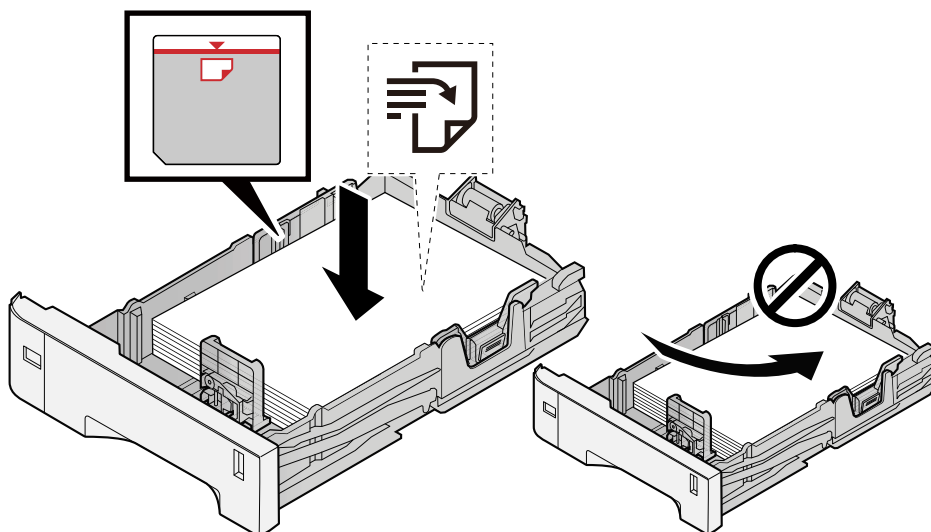

 **IMPORTANT**

- Load the paper with the print side facing up.
 - After removing new paper from its packaging, fan out the paper before loading it in the cassettes.
➔ [Precaution for Loading Paper \(page 90\)](#)
 - Before loading the paper, be sure that it is not curled or folded. Paper that is curled or folded may cause paper jams.
 - Ensure that the loaded paper does not exceed the level indicator (see illustration above).
 - If paper is loaded without adjusting the paper length guide and paper width guide, the paper may skew or become jammed.
-

4 Gently push the cassette back in.

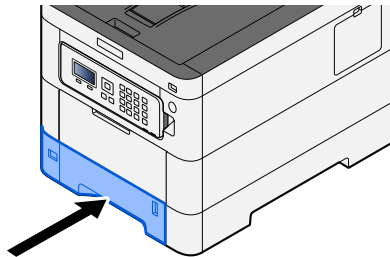

 **NOTE**

There is a paper gauge on the right side of the front of the cassette. The display changes up and down to match the remaining amount of paper.

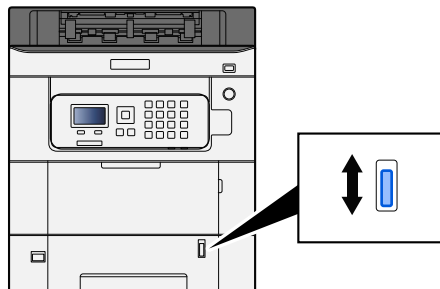

5 Specify the type of paper loaded in the cassette using the operation panel.

➔ [Specifying Paper Size and Media Type \(page 99\)](#)

Paper Specifications available in the Multipurpose Tray

Up to 100 sheets of normal paper (64 g/m²) can be added to the multipurpose tray.

For details of the supported paper sizes, refer to the following:

➔ [Choosing the Appropriate Paper \(page 387\)](#)

For the paper type setting, refer to the following:

➔ [Media Type Set. \(page 191\)](#)

Be sure to use the multipurpose tray when you print on any special paper.

IMPORTANT

- If you are using a paper weight of 106 g/m² or more, set the media type to Thick and set the weight of the paper you are using.
-

The capacity of the multipurpose tray is as follows.

- Plain paper (64 g/m²), recycled paper, and colored paper: 100 sheets
 - Thick paper (209 g/m²): 15 sheets
 - Thick paper (157 g/m²): 30 sheets
 - Thick paper (104.7 g/m²): 50 sheets
 - Hagaki (Cardstock): 30 sheets
 - Envelope DL, Envelope C5, Envelope #10, Envelope #9, Envelope #6 3/4, Envelope Monarch, Youkei 4, Youkei 2: 5 sheets
 - Coated: 30 sheets
-

NOTE

- When you load custom size paper, enter the paper size by referring to the following:
➔ [MP Tray Set. \(page 188\)](#)
-

Loading Paper in the Multipurpose Tray

1 Open the multipurpose tray.

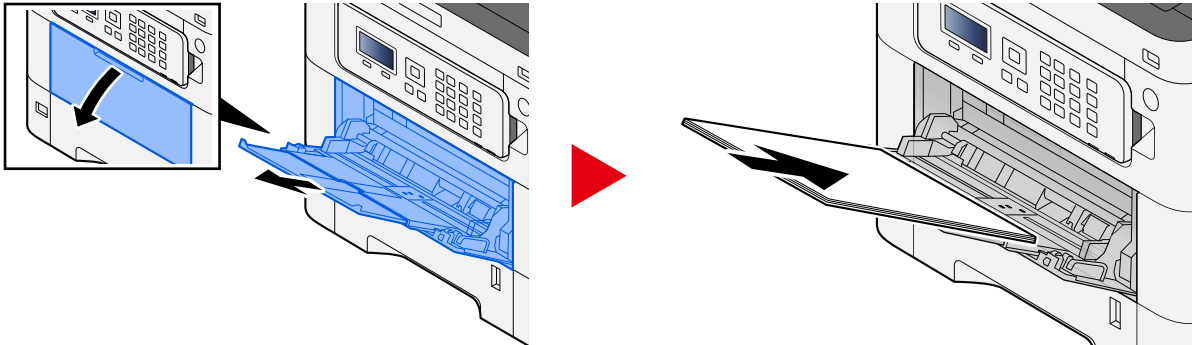

2 Adjust the multipurpose tray size.

Paper sizes are marked on the multipurpose tray.

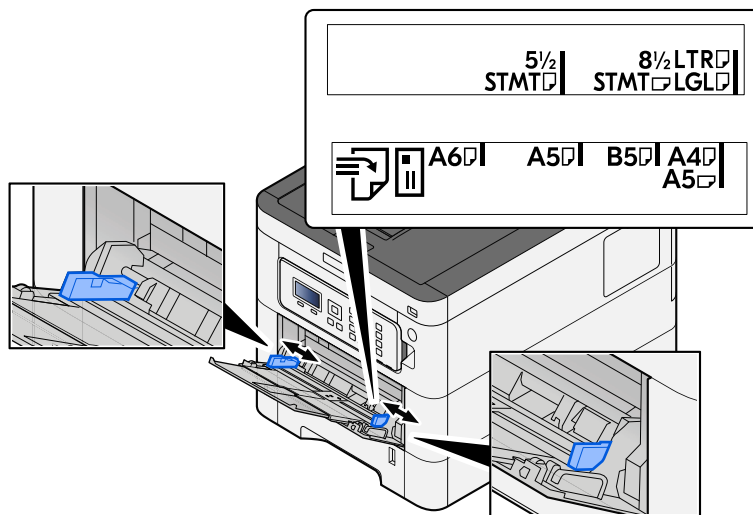

3 Load paper.

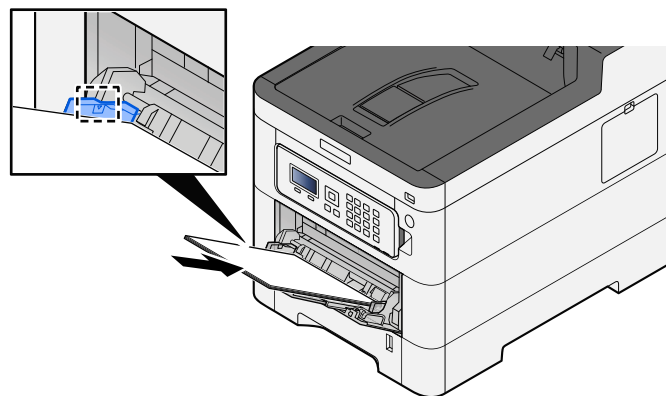

Insert the paper along the paper width guides into the tray until it stops.

After removing new paper from its packaging, fan the paper before loading it in the multipurpose tray.

➔ [Precaution for Loading Paper \(page 90\)](#)

✔ **IMPORTANT**

- When loading the paper, keep the print side facing up.
 - Curled paper must be uncurled before use.
 - When loading paper into the multipurpose tray, check that there is no paper left over in the tray from a previous job before loading the paper. If there is just a small amount of paper left over in the multipurpose tray and you want to add more, first remove the left-over paper from the tray and include it with the new paper before loading the paper back into the tray.
 - If there is a gap between the paper and the paper width guides, readjust the guides to fit the paper in order to prevent skewed feeding and paper jams.
 - Ensure that the loaded paper does not exceed the load limits.
-

When you load envelopes or cardstock in the multipurpose tray, load the paper with the print side facing up. For the procedure for printing, refer to the Printer Driver User Guide.

➔ **Printer Driver User Guide**

Example: When printing the address.

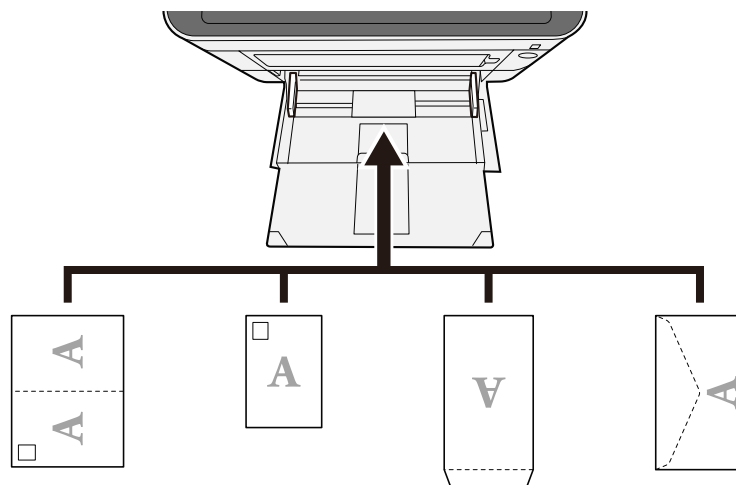

✔ **IMPORTANT**

- Use unfolded Oufuku hagaki (Return postcard).
 - How to load envelopes (orientation and facing) will differ depending on the type of envelope. Be sure to load it in correctly, otherwise printing may be done in the wrong direction or on the wrong face.
-

 **NOTE**

When you load envelopes in the multipurpose tray, select the envelope type by referring to the following:

➔ [MP Tray Set. \(page 188\)](#)

4 Specify the type of paper loaded in the multipurpose tray using the operation panel.

➔ [Specifying Paper Size and Media Type \(page 99\)](#)

Specifying Paper Size and Media Type

The default paper size setting for cassette 1, for the multipurpose tray and for the optional paper feeder (cassettes 2 to 5) is "A4", and the default media type setting is "Plain". To change the type of paper to be used in cassettes, specify the paper size and media type setting.

Cassette Paper Size and Media Type

Item	Description
[Media Type]	<p>Value (Cassette 1) [Plain], [Transparency], [Preprinted], [Bond], [Recycled], [Vellum], [Rough],[Letterhead], [Color], [Prepunched], [Thick], [High Quality], [CUSTOM 1] to [CUSTOM 8]</p> <p>Value (Cassette 2 to 5) [Plain], [Preprinted], [Labels], [Bond], [Recycled], [Vellum], [Rough],[Letterhead], [Color], [Prepunched], [Envelope], [Coated], [Thick], [High Quality], [CUSTOM 1] to [CUSTOM 8]</p> <p>To change to a media type other than "Plain," refer to the following. → Media Type Set. (page 191)</p> <p>When a paper weight that cannot be loaded in the cassette is set for a media type, that media type does not appear.</p>
[Other Paper Size]	<p>Select the paper size.</p> <p>Value (Cassette 1) [Executive], [Letter], [Legal], [A4], [B5], [A5-R], [A5], [A6], [B6], [ISO B5], [Custom], [Oficio II], [216x340mm], [16K], [Statement-R], [Statement], [Folio]</p> <p>Value (Cassette 2 to 5) [Envelope Monarch], [Envelope #10], [Envelope DL], [Envelope C5], [Executive], [Letter], [Legal][A4], [B5], [A5-R], [B6], [Envelope #9], [Envelope #6], [ISO B5], [Custom], [Oficio II], [216x340mm], [16K], [Statement-R], [Folio], [Youkei 2], [Youkei 4], [Nagagata 3], [Nagagata 4], [Younaga 3]</p>

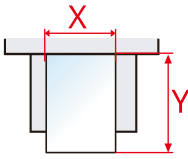
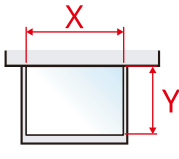
Item	Description
[Custom Paper]	<p>Register the custom size used for Cassette 1 to Cassette 5. Used when the size dial of the cassette is set to "Other".</p> <p>Value Cassette1:</p> <p>[mm] X: 105 to 216 mm (in 1 mm increments) Y: 140 to 356 mm (in 1mm increments)</p> <p>[inch] X: 4.13 to 8.50" (in 0.01" increments) Y: 5.50 to 14.02" (in 0.01" increments)</p> <p>Value Cassette 2 to Cassette 5:</p> <p>[mm] X: 92 to 216 mm (in 1 mm increments) Y: 162 to 356 mm (in 1mm increments)</p> <p>[inch] X: 3.62 to 8.50" (in 0.01" increments) Y: 6.38 to 14.02" (in 0.01" increments)</p> <p>X=Width, Y=Length</p> <div style="display: flex; justify-content: space-around; align-items: center;"> <div style="text-align: center;"> <p>Vertical</p>  </div> <div style="text-align: center;"> <p>Horizontal</p>  </div> </div>

Specifying the Cassette Paper Size and Media Type

If the size dial is matched to the following, set the media type.

- A4
- A5
- B5
- Letter
- Legal
- A6 (Cassette 1 only)

If the size dial is matched to the "Other," set the paper size and media type.

1 Display the screen

[Menu] key > [▲][▼] key > [Paper Settings] > [OK]key > [▲][▼] key > [Cassette 1 Set.] to [Cassette 5 Set.] > [OK] key



NOTE

[Cassette 2] to [Cassette 5] are displayed when the optional paper feeder is installed.

2 Specifying Media Type

- 1 [▲][▼] key > [Media Type] > [OK] key
- 2 Select the media type, and select the [OK] key.

3 Specify the paper size

- 1 [▲][▼] key > [Other Paper Size] > [OK] key
- 2 Select the paper size, and select the [OK] key.
If [Custom PaperSize] is selected, set the paper width and length with the following procedure.
- 3 With [Cassette 1 Set.] to [Cassette 5 Set.], [▲][▼] key > [Custom PaperSize] > [OK]key > [▲][▼] key > [Measurement] > [OK] key
- 4 Select the paper size increments, and select the [OK] key.
- 5 [▲][▼] key > [Size Entry(Y)] > [OK] key
- 6 Input the paper length (Y) and select [OK] key.



NOTE

Use the numeric keys or select the [▲] or [▼] key to enter a number.

- 7 [▲][▼] key > [Size Entry(X)] > [OK] key
- 8 Input the paper length (X) and select [OK] key.



NOTE

Use the numeric keys or select the [▲] or [▼] key to enter a number.

Multipurpose Tray Paper Size and Media Type

Item	Description
[Paper Size]	Select the paper size. Value: [Envelope Monarch], [Envelope #10], [Envelope DL], [Envelope C5], [Executive], [Letter], [Legal], [A4], [B5], [A5-R], [A5], [A6], [B6], [Envelope #9], [Envelope #6], [ISO B5], [Custom], [Cardstock], [Oufuku], [Oficio II], [216x340mm], [16K], [Statement-R], [Statement], [Folio], [Youkei 2], [Youkei 4], [Nagagata 3], [Nagagata 4], [Younaga 3]
[Media Type]	Select the media type. Value: [Plain], [Preprinted], [Labels], [Bond], [Recycled], [Vellum], [Rough],[Letterhead], [Color], [Prepunched], [Envelope], [Cardstock], [Coated], [Thick], [High Quality], [CUSTOM 1] to [CUSTOM 8] To change to a media type other than "Plain," refer to the following. → Media Type Set. (page 191)

Specifying Multipurpose Tray Paper Size and Media Type

Set the size of paper and media type used in the multipurpose tray.

1 Display the screen

[Menu] key > [▲][▼] key > [Paper Settings] > [OK] key > [▲][▼] key > [MP Tray Set.] > [OK] key

2 Specify the paper size

- 1 [▲][▼] key > [Paper Size] > [OK] key
- 2 Select the paper size, and select the [OK] key.

3 Specifying Media Type

- 1 [▲][▼] key > [Media Type] > [OK] key
- 2 Select the media type, and select the [OK] key.

Paper Stopper

When using paper A4/Letter or larger, open the paper stopper shown in the figure.

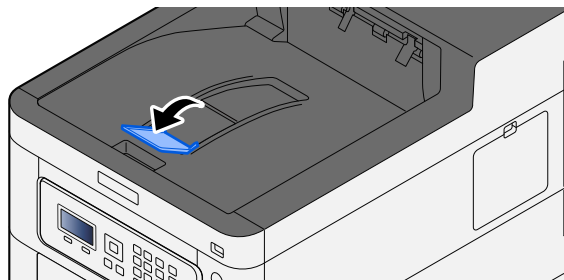

4 Print from PC

Printer Driver Print Settings Screen

The printer driver print settings screen allows you to configure a variety of print-related settings.

➔ **Printer Driver User Guide**

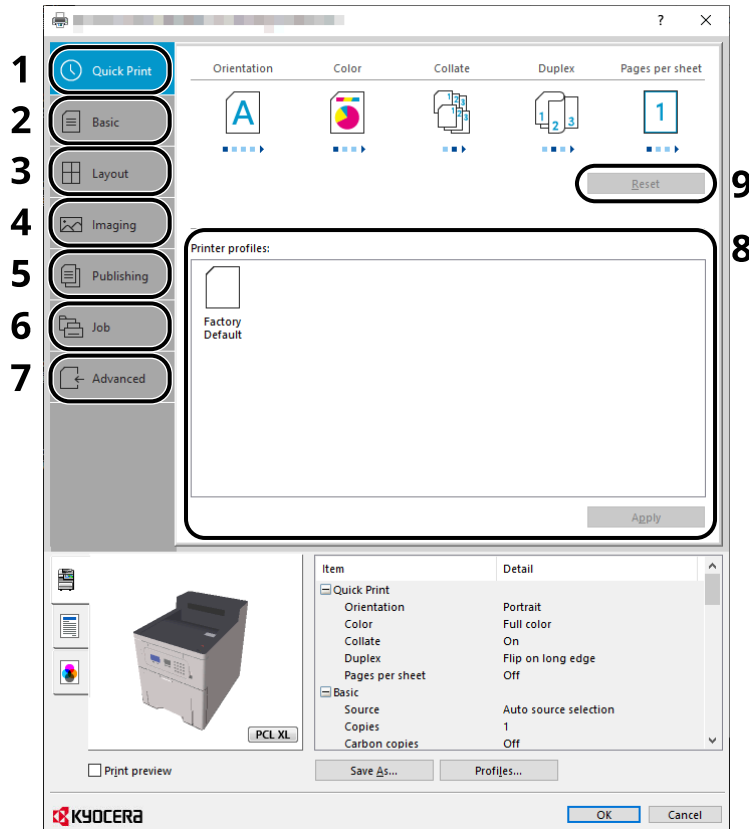

1 [Quick Print] tab

Provides icons that can be used to easily configure frequently used functions. Each time you click an icon, it changes to an image resembling the print results and applies the settings.

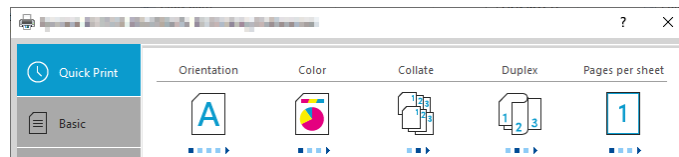

2 [Basic] tab

This tab groups basic functions that are frequently used. You can use it to configure the paper size, destination, and duplex printing.

3 [Layout] tab

This tab lets you configure settings for printing various layouts, including booklet printing, combine mode, poster printing, and scaling.

4 [Imaging] tab

This tab lets you configure settings related to the quality of the print results.

5 [Publishing] tab

This tab lets you create covers and inserts for print jobs and put inserts between sheets of OHP film.

6 [Job] tab

This tab lets you configure settings for saving print data from the computer to the machine. Regularly used documents and other data can be saved to the machine for easy printing later. Since saved documents can be printed directly from the machine, this function is also convenient when you wish to print a document that you don't want others to see.

7 [Advanced] tab

This tab lets you configure settings for adding text pages or watermarks to print data.

8 [Profiles]

Printer driver settings can be saved as a profile. Saved profiles can be recalled at any time, so it's a convenient practice to save frequently used settings.

9 [Reset]

Click to revert settings to their initial values.

Displaying the Printer Driver Help

The printer driver includes Help. To learn about print settings, open the printer driver print settings screen and display Help as explained below.

- 1 Click the [?] button in the upper right corner of the screen.

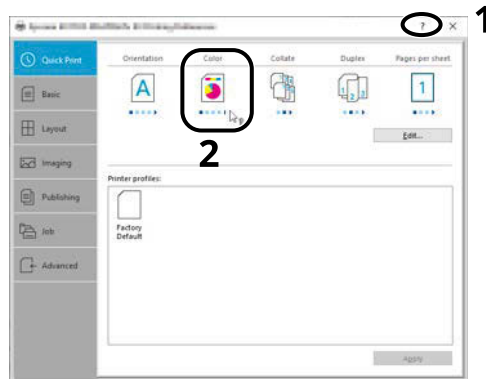

- 2 Click the item you want to know about.



NOTE

The Help appears, even when you click the item you want to know about and press the [F1] key on your keyboard.

Changing the Default Printer Driver Settings (Windows 10)

The default printer driver settings can be changed. By selecting frequently used settings, you can omit steps when printing. For the settings, refer to the following:

→ Printer Driver User Guide

- 1 Click [Start] button on the Windows and then select → [Windows System Tools], → [Control Panel], and → [Devices and Printers].
- 2 Right-click the printer driver icon of the machine, and click the [Printer properties] menu of the printer driver.
- 3 Click the [Basic] button on the [General] tab.
- 4 Select the default settings and click the [OK] button.

Changing the Default Printer Driver Settings (Windows 11)

The default printer driver settings can be changed. By selecting frequently used settings, you can omit steps when printing. For the settings, refer to the following:

→ Printer Driver User Guide

- 1 Click the [Start] button → [All apps] → [Windows Tools] → [Control Panel] → [Devices and Printers]
- 2 Right-click the printer driver icon of the machine, and click the [Printer properties] menu of the printer driver.
- 3 Click the [Basic] button on the [General] tab.
- 4 Select the default settings and click the [OK] button.

Changing the Default Printer Driver Settings (Windows 8.1, Windows Server 2012/R2, Windows Server 2016, Windows Server 2019)

The default printer driver settings can be changed. By selecting frequently used settings, you can omit steps when printing. For the settings, refer to the following:

→ Printer Driver User Guide

- 1 Click [Settings] in the Charms Bar on Desktop → [Control Panel] → [Devices and Printers]
- 2 Right-click the printer driver icon of the machine, and click the [Printer properties] menu of the printer driver.
- 3 Click the [Basic] button on the [General] tab.
- 4 Select the default settings and click the [OK] button.

Printing from PC

This section provides the printing method using the KX DRIVER.

NOTE

- To print the document from applications, install the printer driver downloaded from Download Center (<https://kyocera.info/>) on your computer.
- In some environments, the current settings are displayed at the bottom of the printer driver.

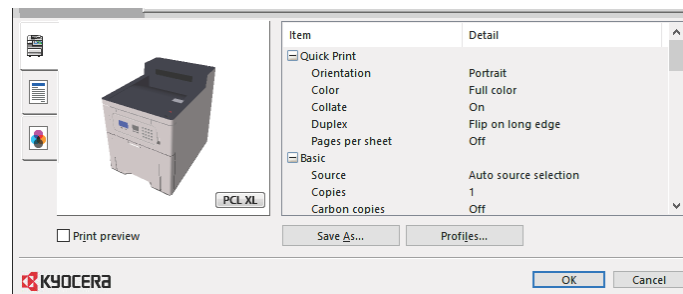

- When printing the cardstock or envelopes, load the cardstock or envelopes in the multipurpose tray before performing the following procedure.

➔ [Loading Paper in the Multipurpose Tray \(page 96\)](#)

Printing on Standard Sized Paper

If you loaded a paper size that is included in the print sizes of the machine, select the paper size in the [Basic] tab of the print settings screen of the printer driver.

NOTE

Specify the paper size and media type to print from the operation panel.

➔ [Paper Settings \(page 188\)](#)

1 Display the screen.

Click [File] and select [Print] in the application.

2 Configure the settings.

1 Select the machine from the "Printer" menu and click the [Properties] button.

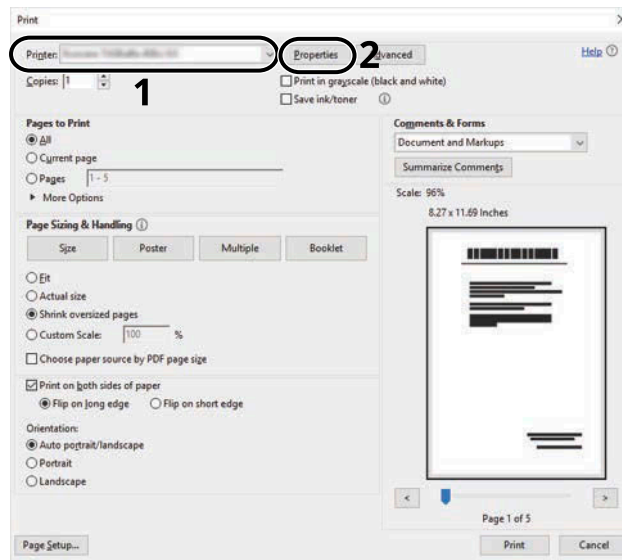

2 Select the [Basic] tab.

3 Click "Print size" menu and select the paper size to use for printing.

To load the paper of size that is not included in print sizes of the machine such as cardstock or envelopes, the paper size needs to be registered.

➔ [Printing on Non-standard Sized Paper \(page 112\)](#)

To print on the special paper such as thick paper or transparency, click "Media type" menu and select the media type.

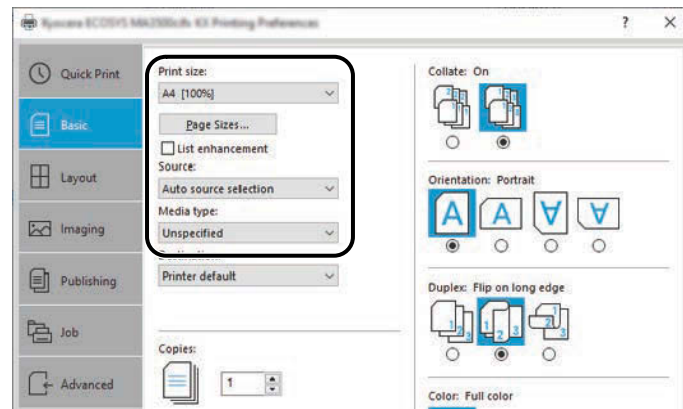

4 Click [OK] button to return to the Print dialog box.

3 Start printing.

Click the [OK] button.

Printing on Non-standard Sized Paper

If you loaded a paper size that is not included in the print sizes of the machine, register the paper size in the [Basic] tab of the print settings screen of the printer driver.

The registered size can be selected from the "Print size" menu.

NOTE

Specify the paper size and media type to print from the operation panel.

→ [Paper Settings \(page 188\)](#)

1 Display the screen.

- 1 Select the Windows [Start] button → [Windows System Tool] → [Control Panel] → [Devices and Printers].

NOTE

- For Windows 11, select the [Start] button → [All apps] → [Windows Tools] → [Control Panel] → [Devices and Printers].
- For Windows 8.1, select [Settings] in the Charms Bar on Desktop → [Control Panel] → [Devices and Printers].

- 2 Right-click the printer driver icon of the machine, and click the [Printer properties] menu of the printer driver.
- 3 Click the [Preferences] button on the [General] tab.

2 Register the group.

- 1 Click the [Basic] tab.

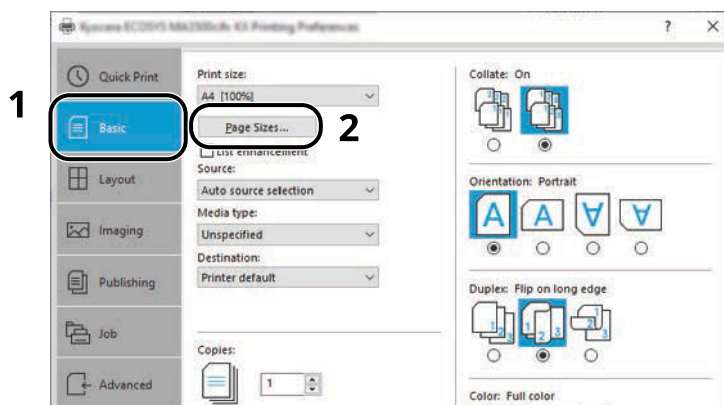

- 2 Click the [Page Size...] button.

- 3 Click the [New] button.

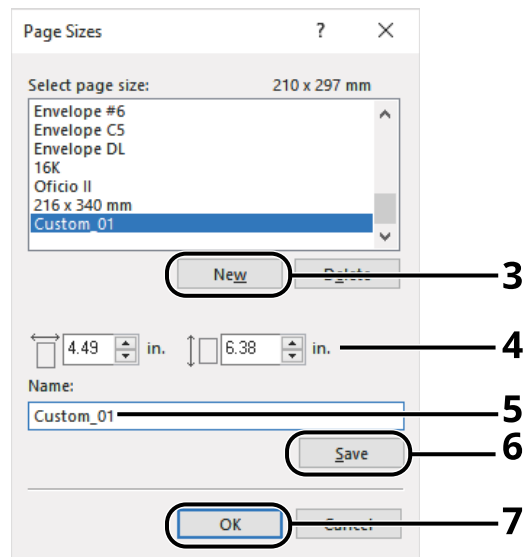

- 4 Enter the paper size.
- 5 Enter the name of the paper.
- 6 Click the [Save] button.
- 7 Click the [OK] button.
- 8 Click the [OK] button.

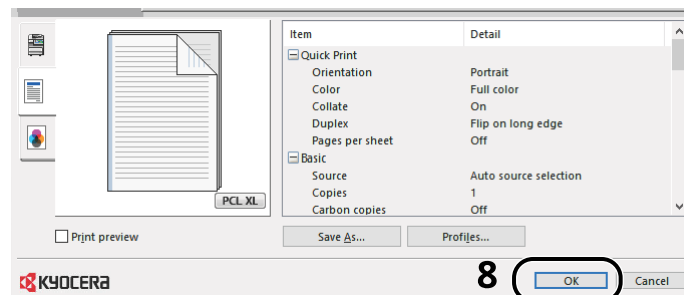

3 Display the print settings screen.

Click [File] and select [Print] in the application.

4 Select the paper size and type of non-standard size paper.

- 1 Select the machine from the "Printer" menu and click the [Properties] button.

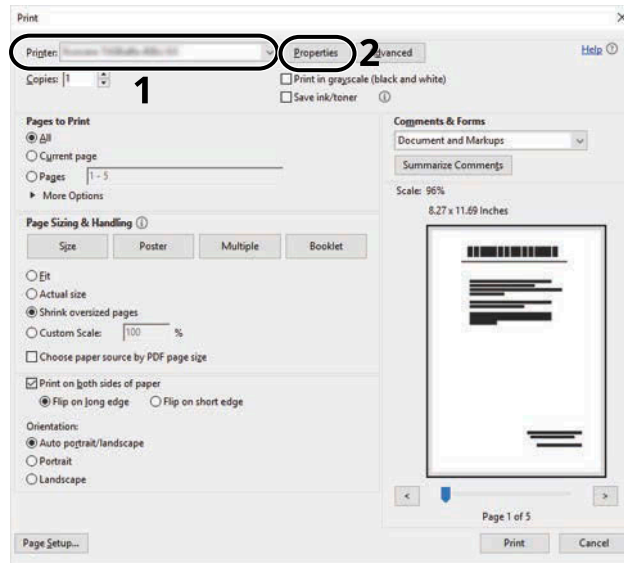

- 2 Select the [Basic] tab.

- 3 Click "Print size" menu and select the paper size registered in step 2.

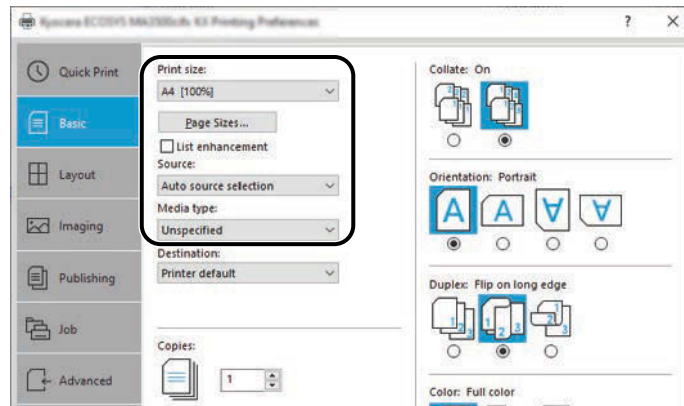

To print on the special paper such as thick paper or transparency, click [Media type] menu and select the media type.

NOTE

If you loaded a postcard or envelope, select [Cardstock] or [Envelope] in the "Media type" menu.

- 4 Select the paper source in the "Source" menu.
- 5 Click [OK] button to return to the Print dialog box.

5 Start printing.

Click the [OK] button.

Printing with Universal Print

Jobs can be printed via the cloud by using the cloud service "Universal Print" provided by Microsoft Corporation. Users authorized in the Azure Active Directory can print to Universal Print ready printers from anywhere.

NOTE

- A Microsoft 365 license and an Azure Active Directory account are necessary in order to use Universal Print. If you do not have one, please obtain these licenses and accounts.
 - In order to use Universal Print, the following prerequisites need to be met:
 - A Universal Print-eligible license must be assigned to the user account used
 - Printer Administrator or Global Administrator privileges must be assigned to all administrators
-

Registering the Machine to Universal Print

1 Start up the browser.

Specify `https://[Host name of this Machine]` and start Command Center RX.

2 Display the screen.

[Function Settings] > [Printer] > "Universal Print Settings" > [Settings]

3 Configure the settings.

- 1 Enter "Printer Name" in "Basic".
-

NOTE

Set the proxy if required.

➔ [Command Center RX User Guide](#)

- 2 Click [Register] in "Universal Print".
A Microsoft URL and an access code are displayed.
 - 3 Click the URL and enter the access code obtained in Step 2 > [Next]
 - 4 Log in as Azure administrator.
-

NOTE

Credential is required only when you register for the first time. Click [Approve].

- 5 Close the Microsoft web page and return to the Command Center RX screen.
 - 6 Click [OK].
Returns to the Universal Print Settings screen.
-

NOTE

Once registration is complete, [Register] in "Universal Print" will change to [Unregister], and the expiration date of certificate will be shown. Click [Refresh] if the display remains unchanged.

- 7 Click [Edit] in "Universal Print Preferences" and copy the unregister URL.
- 8 Open a new tab in the browser and past the URL.
You will be redirected to the Universal Print web page.
- 9 Click [Printers].
Registered printers are displayed.
- 10 Check the box for this machine and click [Share].
The "Shares printers" screen is displayed.
- 11 Select the users you want to share this machine with from the "Select member(s)" menu and click the [Share Printer] button.



NOTE

Enable [Allow access to everyone in my organization] to share this machine with all users in your organization.

- 12 Close the Universal Print web page.

Registering a Shared Printer to a Computer

To use Universal Print, it is necessary to add a shared printer registered with Universal Print to the computer.

1 Login

- 1 Select the Windows Start button → [Settings]→ [Accounts]→ [Access work or school].
- 2 Confirm that the Azure administrator account name is displayed in [Work or school account], and click it.



NOTE

If the Azure administrator account name is not displayed, click [+] (Connect), and use the Azure administrator account name and password to log in.

2 Display the screen.

Select [Home]→ [Devices]→ [Printers & scanners].

3 Configure the function.

- 1 Click [Add a printer or scanner].
- 2 Select the shared printer and click [Add device].
The shared printer is registered.

Print the Job

1 Display the screen.

Click [File] and select [Print] in the application.

2 Configure the settings.

- 1 Select a registered shared printer from the [Printer] menu and click the [Properties] button.

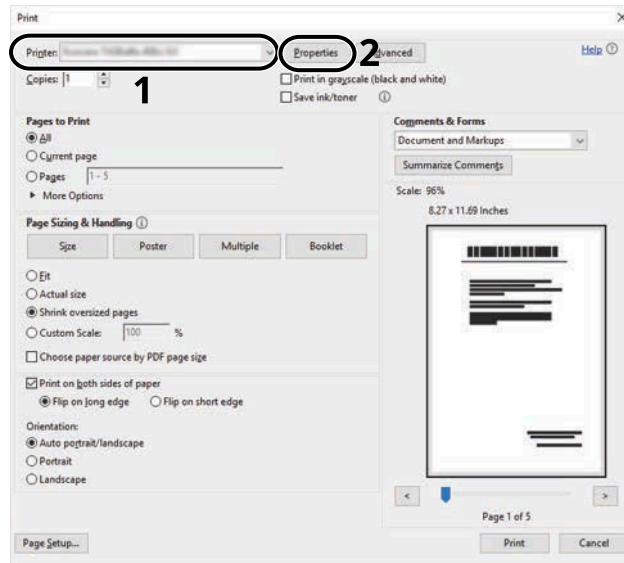

- 2 Set the paper size, printer function, etc., as desired.
- 3 Click [OK] button to return to the Print dialog box.

3 Start printing.

Click the [OK] button.

Printing on Banner Paper

If you specify a paper size with a length of 488.1 mm or more (19.22" or more) and a maximum of 1,220 mm (48.03"), it will be treated as banner printing.

Maximum Loading Capacity	1 sheet (Multipurpose Tray)
Paper Width	210 mm to 216 mm (8.26" to 8.5")
Paper Length	488.1 mm to 1,220 mm (19.22" to 48.03")
Supported Paper Thickness	136 to 163 g/m ²
Media Type	Heavy 2

1 Display the screen.

Click [File] and select [Print] in the application.

2 Display the screen for registering the original size.

1 Select the machine from the "Name" menu and click the [Properties] button.

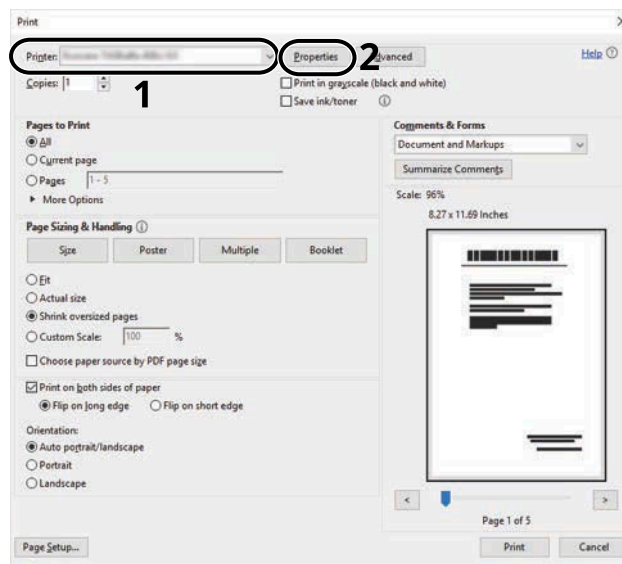

2 Select the [Basic] tab.

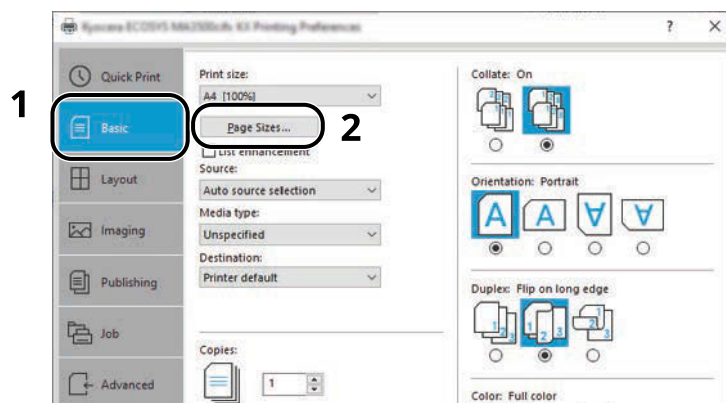

- 3 Select [Paper Size].

3 Register the original size.

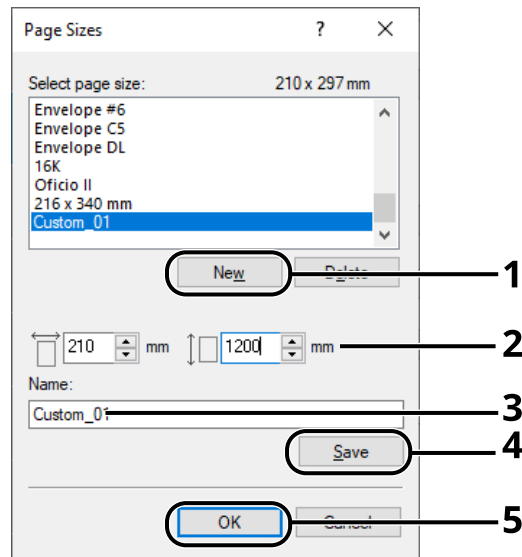

- 1 Click the [New] button.
- 2 Enter the length (488.1 mm or more) and width of the custom paper to be registered.
- 3 Enter the name of the paper.
- 4 Click the [Add] button.
- 5 Click the [OK] button.

4 Specify the print size.

- 1 Select the paper size registered in the "Print Size" menu.

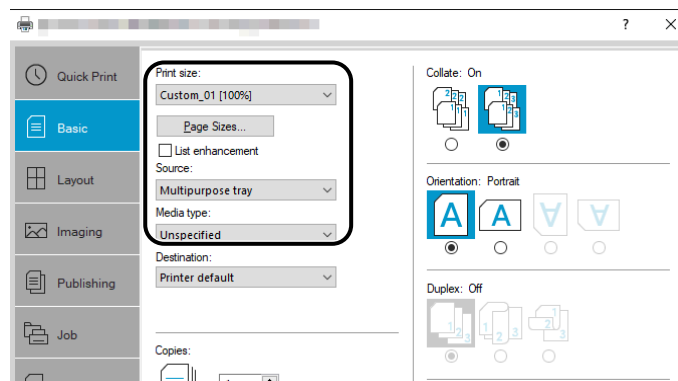

- 2 In the "Print Size" menu, select [Multipurpose Tray].
- 3 In the "Media Type" menu, select [Plain].

- 4 Click the [OK] button.



NOTE

For banner printing, the resolution is 600 dpi.

5 Load paper

- 1 Open the multipurpose tray and pull out the multipurpose tray extension.

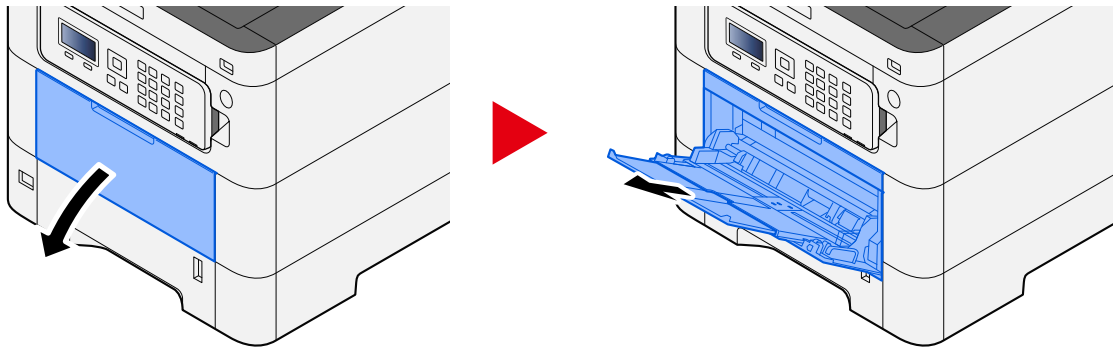

- 2 Load the banner sheets.

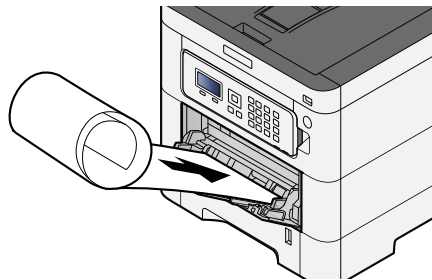

6 Print

Click the [OK] button.

When printing is executed, a message will be displayed on the operation panel of the machine. Load the paper in the multipurpose tray and select [Continue] while supporting it so that it will not fall.

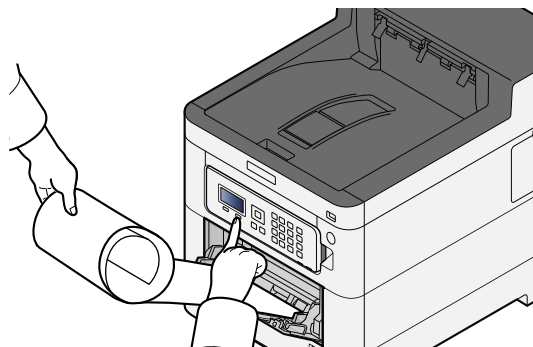

✔ **IMPORTANT**

- After selecting [Continue], support the paper with both hands so that the paper feeds correctly.

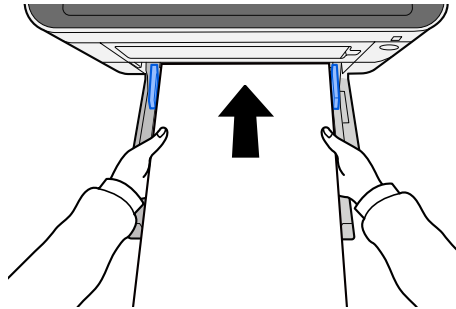

- After printing starts, catch the paper when it is output so that it does not fall out of the tray. When using the inner tray as the output location, do not stand up the stopper.

Set whether the confirmation screen appears before each sheet is printed when printing multiple sheets.

➔ [Msg Banner Print \(page 234\)](#)

Canceling Printing from a Computer

To cancel a print job executed using the printer driver before the printer begins printing, do the following:

 **NOTE**

When canceling printing from this machine, refer to the following:

➔ [Canceling Jobs \(page 144\)](#)

-
- 1** Double-click the printer icon () displayed on the taskbar at the bottom right of the Windows desktop to display a dialog box for the printer.
 - 2** Click the file for which you wish to cancel printing and select [Cancel] from the "Document" menu.

Printing from the Mobile Device

This machine supports the AirPrint and Mopria. According to the supported OS and application, you can print the job from any mobile device or computer without installing a printer driver.

Printing by AirPrint

AirPrint is a printing function that is included standard in iOS 4.2 and later products, and Mac OS X 10.7 and later products. To use the AirPrint, make sure that the AirPrint setting is enabled in the Command Center RX.

➔ [Command Center RX User Guide](#)



Printing by Mopria

Mopria is a standard on printing function included in Android 4.4 or later products. Mopria Print Service needs to be installed and enabled in advance. For details on how to use, refer to a Web site of Mopria Alliance.



Printing with Wi-Fi Direct

Wi-Fi Direct is a wireless LAN standard that Wi-Fi Alliance has been established. This is one of the functions of the wireless LAN, without a wireless LAN access point or wireless LAN router, between devices can communicate directly on a peer to peer basis.

The printing procedure by the Wi-Fi Direct is the same as that from the normal mobile devices.

When you use a printer name or Bonjour name on the port settings of the printer property, you can print the job by specifying the name at Wi-Fi Direct connection. When you use an IP address for the port, specify the IP address of this machine.

Printing Data Saved in the Printer

You can save the print job into the Job Box of this device and print it as necessary. If you configure settings in the [Job] tab of the printer driver and then print, the print job will be saved in the Job Box (memory) and printing can be executed at the machine.

To print the job in Job Box, specify the Job Box from a computer and sending the print job, then specify a file within a Box and printing it, using the operation panel.

You can print the documents from the following boxes.

- Private Print Box
 - ➔ [Printing Documents from Private Print Box \(page 124\)](#)
- Stored Job Box
 - ➔ [Printing Document from Stored Job Box \(page 126\)](#)
- Quick Copy Box
 - ➔ [Printing Document from Quick Copy Box \(page 128\)](#)
- Proof and Hold Box
 - ➔ [Printing Document from Proof and Hold Box \(page 130\)](#)
- PIN Print Box
 - ➔ [Printing Documents from PIN Print Box \(page 132\)](#)
- Universal Print Box
 - ➔ [Printing the Documents Stored in the Universal Print Box \(page 135\)](#)

Specifying the Job Box from a Computer and Storing the Job

1 Click [File] and select [Print] in the application.

The Print dialog box displays.

2 Click the [▼] button of the Name to select the machine from the list.

3 Click the [Properties] button.

The Properties dialog box displays.

4 Click the [Job] tab and select the [Job storage (e-MPS)] check box to set the function.



NOTE

An optional SSD is required to use the Stored Job Box and the Quick Copy Box.

For information on how to use the printer driver software, refer to the following:

- ➔ **Printer Driver User Guide**
-

Printing Documents from Private Print Box

In Private Printing, you can specify that a job is not to be printed until you operate the machine. When sending the job from the application software, specify a password in the printer driver. The job is released for printing by entering the password on the operation panel, ensuring confidentiality of the print job. The data will be deleted upon completion of the print job or after the power switch is turned off.

1 Display the screen.

- 1 [Document Box] key > [▲][▼] key > [Private/Stored] > [OK] key



NOTE

If the box initial screen is set to the Custom Box, display the Job Box screen.

[Document Box] key > [Back] key > [▲][▼] key > [Job Box] > [OK] key

- 2 Select the creator of the document, and select the [OK] key.

2 Print the document.

- 1 Select the document to print and the [OK] key

Select a document and a checkmark will appear on the right side of the selected document.

If you select [All Files], all documents will be marked with a checkmark on their right side.

When all documents are checked, all check marks are removed.

If you select a document marked with a checkmark and once again select [Select], the selection will be cleared.

- 2 [▲][▼] key > [Print] > [OK] key
- 3 Enter the password > [OK] key
- 4 Enter the number of copies to print and select the [OK] key > [Yes]

Printing starts.

Upon completion of printing, the Private/Stored job data is automatically deleted.

Deleting the Documents Stored in the Private Print Box

1 Display the screen.

- 1 [Document Box] key > [▲][▼] key > [Private/Stored] > [OK] key
-



NOTE

If the box initial screen is set to the Custom Box, display the Job Box screen.

[Document Box] key > [Back] key > [▲][▼] key > [Job Box] > [OK] key

- 2 Select the creator of the document, and select the [OK] key.

2 Delete the document.

- 1 Select the document to delete and [OK] key

Select a document and a checkmark will appear on the right side of the selected document.

If you select [All Files], all documents will be marked with a checkmark on their right side.

When all documents are checked, all check marks are removed.

If you select a document marked with a checkmark and once again select [Select], the selection will be cleared.

- 2 [▲][▼] key > [Delete] > [OK] key
- 3 Enter the password > [OK] key > [Yes]
The document is deleted.

Printing Document from Stored Job Box

In Stored Job, the print data sent from the application is saved to the machine. You can set up a password as necessary. If you set up a password, enter the password when printing. Print data will be stored in the Stored Job Box after printing. This will allow printing of the same print data repeatedly.

1 Display the screen.

- 1 [Document Box] key > [▲][▼] key > [Private/Stored] > [OK] key



NOTE

If the box initial screen is set to the Custom Box, display the Job Box screen.

[Document Box] key > [Back] key > [▲][▼] key > [Job Box] > [OK] key

- 2 Select the creator of the document, and select the [OK] key.

2 Print the document.

- 1 Select the document to print and the [OK] key

Select a document and a checkmark will appear on the right side of the selected document.

If you select [All Files], all documents will be marked with a checkmark on their right side.

When all documents are checked, all check marks are removed.

If you select a document marked with a checkmark and once again select [Select], the selection will be cleared.

- 2 [▲][▼] key > [Print] > [OK] key

- 3 Enter the number of copies to print and the [OK] key

Printing starts.



NOTE

If the document is protected by a password, the password entry screen will be displayed. Enter the password with the numeric keypad.

Simple Job Printing

When you save a print job performed via user login to the Stored Job Box, logging in with an IC card at the time of printing displays a list of your print jobs in the Stored Job Box. When you run the print job, printing starts immediately.

User login administration that uses the optional IC Card Authentication Kit is required. For details on user login administration for printing, refer to the following:

➔ [Adding a User \(Local User List\) \(page 252\)](#)

➔ [Managing the Users that Print on This Machine from a PC \(page 256\)](#)

For IC card settings, refer to the following:

➔ [ID Card Settings \(page 261\)](#)

For Simple Job Printing settings, refer to the following:

➔ [Simple Job Printing \(page 262\)](#)

Deleting the Documents Stored in the Stored Job Box

1 Display the screen.

- 1 [Document Box] key > [▲][▼] key > [Private/Stored] > [OK] key
-



NOTE

If the box initial screen is set to the Custom Box, display the Job Box screen.

[Document Box] key > [Back] key > [▲][▼] key > [Job Box] > [OK] key

- 2 Select the creator of the document, and select the [OK] key.

2 Delete the document.

- 1 Select the document to delete and [OK] key

Select a document and a checkmark will appear on the right side of the selected document.

If you select [All Files], all documents will be marked with a checkmark on their right side.

When all documents are checked, all check marks are removed.

If you select a document marked with a checkmark and once again select [Select], the selection will be cleared.

- 2 [▲][▼] key > [Delete] > [OK] key

The document is deleted.



NOTE

If the document is protected by a password, the password entry screen will be displayed. Enter the password with the numeric keypad.

Printing Document from Quick Copy Box

Quick Copy feature facilitates additional prints of a document already printed. Activating Quick Copy and printing a document using the printer driver allow the print data to be stored in the Quick Copy Job Box. When additional copies are required, you can reprint the required number of copies from the operation panel. By default, up to 32 documents can be stored. When power is turned off, all stored jobs will be deleted.

NOTE

- When the number of jobs reaches the limit, the oldest job will be overwritten by the new one.
- To maintain free space on the hard disk, you can set the maximum number of stored jobs.

➔ [Configure the Job Box \(page 136\)](#)

1 Display the screen.

- 1 [Document Box] key > [▲][▼] key > [Quick/Proof] > [OK] key

NOTE

If the box initial screen is set to the Custom Box, display the Job Box screen.

[Document Box] key > [Back] key > [▲][▼] key > [Job Box] > [OK] key

- 2 Select the creator of the document, and select the [OK] key.

2 Print the document.

- 1 Select the document to print and the [OK] key

Select a document and a checkmark will appear on the right side of the selected document.

If you select [All Files], all documents will be marked with a checkmark on their right side.

When all documents are checked, all check marks are removed.

If you select a document marked with a checkmark and once again select [Select], the selection will be cleared.

- 2 [▲][▼] key > [Print] > [OK] key
- 3 Enter the number of copies to print and the [OK] key
Printing starts.

Deleting the Documents Stored in the Quick Copy Box

1 Display the screen.

- 1 [Document Box] key > [▲][▼] key > [Quick/Proof] > [OK] key
-



NOTE

If the box initial screen is set to the Custom Box, display the Job Box screen.

[Document Box] key > [Back] key > [▲][▼] key > [Job Box] > [OK] key

- 2 Select the creator of the document, and select the [OK] key.

2 Delete the document.

- 1 Select the document to delete and [OK] key

Select a document and a checkmark will appear on the right side of the selected document.

If you select [All Files], all documents will be marked with a checkmark on their right side.

When all documents are checked, all check marks are removed.

If you select a document marked with a checkmark and once again select [Select], the selection will be cleared.

- 2 [▲][▼] key > [Delete] > [OK] key

The document is deleted.

Printing Document from Proof and Hold Box

The Proof and Hold feature produces only a single proof print of multiple-print job and holds printing of the remaining copies. Printing a multiple-print job in Proof and Hold using the printer driver allows only a single copy to be printed while maintaining the document data in the Job Box. To continue to print the remaining copies, use the operation panel. You can change the number of copies to print.

1 Display the screen.

- 1 [Document Box] key > [▲][▼] key > [Quick/Proof] > [OK] key



NOTE

If the box initial screen is set to the Custom Box, display the Job Box screen.

[Document Box] key > [Back] key > [▲][▼] key > [Job Box] > [OK] key

- 2 Select the creator of the document, and select the [OK] key.

2 Print the document.

- 1 Select the document to print and the [OK] key

Select a document and a checkmark will appear on the right side of the selected document.

If you select [All Files], all documents will be marked with a checkmark on their right side.

When all documents are checked, all check marks are removed.

If you select a document marked with a checkmark and once again select [Select], the selection will be cleared.

- 2 [▲][▼] key > [Print] > [OK] key
- 3 Enter the number of copies to print and the [OK] key
Printing starts.

Deleting the Documents Stored in the Proof and Hold Box

1 Display the screen.

- 1 [Document Box] key > [▲][▼] key > [Quick/Proof] > [OK] key
-



NOTE

If the box initial screen is set to the Custom Box, display the Job Box screen.

[Document Box] key > [Back] key > [▲][▼] key > [Job Box] > [OK] key

- 2 Select the creator of the document, and select the [OK] key.

2 Delete the document.

- 1 Select the document to delete and [OK] key

Select a document and a checkmark will appear on the right side of the selected document.

If you select [All Files], all documents will be marked with a checkmark on their right side.

When all documents are checked, all check marks are removed.

If you select a document marked with a checkmark and once again select [Select], the selection will be cleared.

- 2 [▲][▼] key > [Delete] > [OK] key

The document is deleted.

Printing Documents from PIN Print Box

This PIN Print Box holds printing when printing is executed from applications that use the IPP protocol, such as AirPrint and Mopria. A pending print job can be output by entering the PIN code that was set at the time of printing.

1 Display the screen.

- 1 [Document Box] key > [▲][▼] key > [PIN Print] > [OK] key



NOTE

If the box initial screen is set to the Custom Box, display the Job Box screen.

[Document Box] key > [Back] key > [▲][▼] key > [Job Box] > [OK] key

- 2 Select the creator of the document, and select the [OK] key.

2 Print the document.

- 1 Select the document to print and the [OK] key
- 2 [▲][▼] key > [Print] > [OK] key
- 3 Enter the PIN code to print, and select the [OK] key

Printing starts.

Upon completion of printing, the PIN Print job is automatically deleted.

Deleting the Documents Stored in the PIN Print Box

1 Display the screen.

- 1 [Document Box] key > [▲][▼] key > [PIN Print] > [OK] key
-



NOTE

If the box initial screen is set to the Custom Box, display the Job Box screen.

[Document Box] key > [Back] key > [▲][▼] key > [Job Box] > [OK] key

- 2 Select the creator of the document, and select the [OK] key.

2 Delete the document.

- 1 Select the document to delete and [OK] key
- 2 [▲][▼] key > [Delete] > [OK] key
- 3 Enter the PIN code, and select the [OK] key
The document is deleted.

Printing Document from Universal Print Box

For added security, Universal Print can set a PIN code for the printing jobs. Jobs with a PIN code will be saved in the cloud without being printed. By entering the PIN code from the operation panel, jobs from this machine can be printed.

NOTE

- To use Universal Print, this machine must be registered as a shared printer.
 - ➔ [Registering the Machine to Universal Print \(page 115\)](#)
- To use the Universal Print box, you need a Windows 11 and Microsoft 365 license and an Azure Active Directory account.

Storing a Job in the Universal Print Box

1 Display the screen.

Click [File] and select [Print] in the application.

2 Configure the settings.

- 1 Select a registered shared printer from the "Printer" menu and click the [Properties] button.

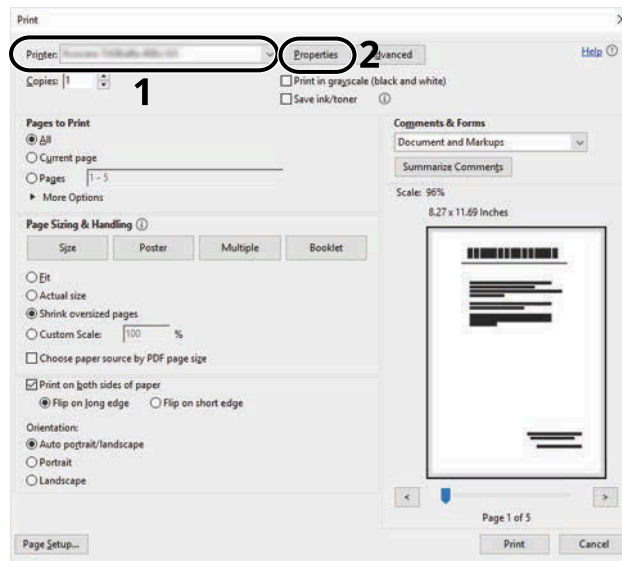

- 2 Select [Advanced settings].

- 3 Set [PIN-protected printing] to [On], and set a PIN code (4 digits) as the [PIN-protected printing PIN].

- 4 Click [OK] button > [OK] button to return to the Print dialog box.

3 Start printing.

Click the [OK] button.

Printing the Documents Stored in the Universal Print Box

1 Display the screen.

- 1 [Document Box] key > [▲] [▼] key > [Universal Print] > [OK] key
-



NOTE

If the box initial screen is set to the Custom Box, display the Job Box screen.

[Document Box] key > [Back] key > [▲][▼] key > [Universal Print] > [OK] key

- 2 Select the creator of the document, and select the [OK] key.

2 Print the document.

- 1 Select the document to print, and [Select] > [OK] key

Select a document and a checkmark will appear on the right side of the selected document.

If you select [All Files], all documents will be marked with a checkmark on their right side.

When all documents are checked, all check marks are removed.

If you select a document marked with a checkmark and once again select [Select], the selection will be cleared.

- 2 [▲] [▼] key > [Print] > [OK] key > Enter the PIN code > [OK] key > [Yes]

Deleting the Documents Stored in the Universal Print Box

1 Display the screen.

- 1 [Document Box] key > [▲][▼] key > [Universal Print] > [OK] key
-



NOTE

If the box initial screen is set to the Custom Box, display the Job Box screen.

[Document Box] key > [Back] key > [▲][▼] key > [Universal Print] > [OK] key

- 2 Select the creator of the document, and select the [OK] key.

2 Delete the document.

- 1 Select the document to delete and [Select] > [OK] key

Select a document and a checkmark will appear on the right side of the selected document.

If you select [All Files], all documents will be marked with a checkmark on their right side.

When all documents are checked, all check marks are removed.

If you select a document marked with a checkmark and once again select [Select], the selection will be cleared.

- 2 [▲][▼] key > [Delete] > [OK] key > enter the PIN > [OK] key > [Yes]

The document is deleted.

Configure the Job Box

Configure settings for Job Box.

1 Display the screen.

[Document Box] key > [▲][▼] key > [Job Box Setting] > [OK] key



NOTE

If the box initial screen is set to the Custom Box, display the Job Box screen.

[Document Box] key > [Back] key > [▲][▼] key > [Job Box] > [OK] key

2 Configure the settings.

The following settings can be configured.

[Quick Copy Jobs]

To maintain free space on the box, you can set the maximum number of stored jobs.

Value: number between 0 and 300



NOTE

When 0 is set, Quick Copy cannot be used.

[JobRet. Deletion]

This setting specifies that documents, such as Private Printing, Quick Copying, or Proof and Hold Printing, saved temporarily in the job box are automatically deleted after they have been saved for a set time.

Value: [Off], [1 hour], [4 hours], [1 day], [1 week]



NOTE

This function is valid for documents saved after the function is set. Regardless of this function setting, temporary documents are deleted when the power switch is turned off.

[DePIN at PwrOff]

Set whether or not the jobs stored in the PIN Print Box is deleted when the power is turned off.

Displayed when the optional SSD is installed.

Value: [Off], [On]

[Storage Media]

Set the save destination of the Job Box.

Displayed when the optional SSD and an SD card are installed.

Value: [SSD], [SD Card]

Monitoring the Printer Status (Status Monitor)

The Status Monitor monitors the printer status and provides an ongoing reporting function.

NOTE

When you activate Status Monitor, check the status below.

- KX DRIVER is installed.
- Either [Enhanced WSD] or [EnhancedWSD(TLS)] is enabled.

➔ [ProtocolSettings \(page 212\)](#)

Accessing the Status Monitor

The Status Monitor also starts up when printing is started.

Exiting the Status Monitor

Use either of the methods listed below to exit the Status Monitor.

Exit manually

Click the settings icon and select Exit in the menu to exit the Status Monitor.

Exit automatically

The Status Monitor automatically shuts down after 7 minutes if it is not being used.

Quick View State

The status of the printer is displayed using icons. Detailed information is displayed when the Expand button is clicked.

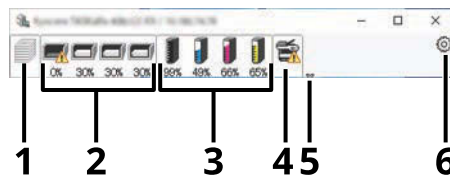

- 1 Printing progress tab
- 2 Paper tray status tab
- 3 Toner Status Tab
- 4 Alert tab
- 5 Expand button
- 6 Settings icon

Detailed information is displayed by clicking on each icon tab.

Printing progress tab

The status of the print jobs is displayed.

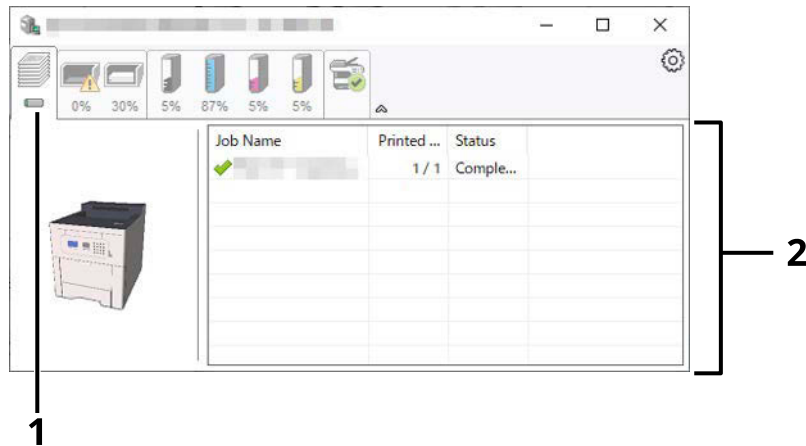

1 Status icon

2 Job list

Select a job on the job list and it can be canceled using the menu displayed with a right-click.

Paper tray status tab

Information is displayed about the paper in the printer and about the amount of paper remaining.

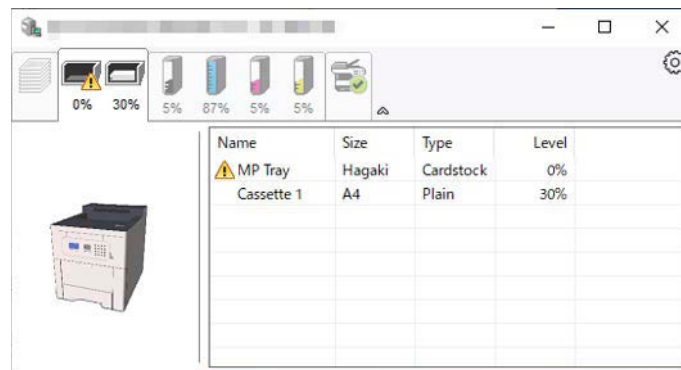

Toner Status Tab

The amount of toner remaining is displayed.

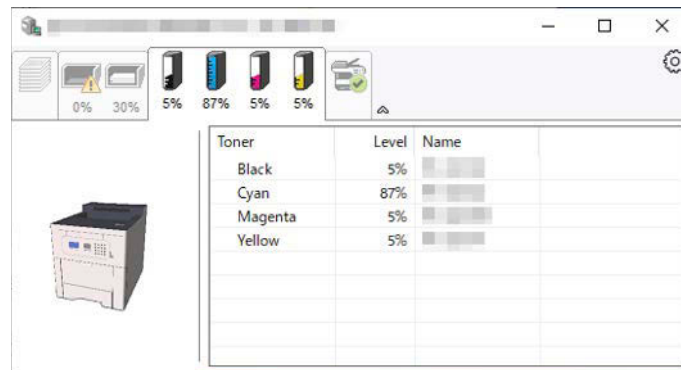

Alert tab

If an error occurs, a notice is displayed using a 3D image and a message.

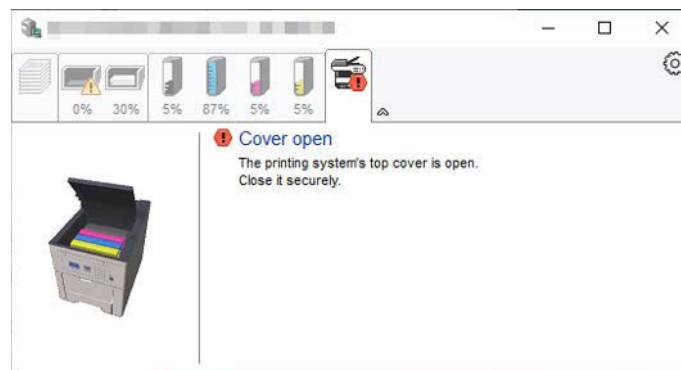

Status Monitor Context Menu

The following menu is displayed when the settings icon is clicked.

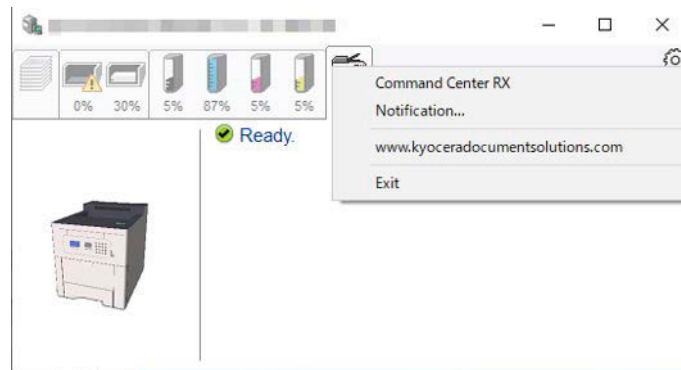

[Command Center RX]

If the printer is connected to a TCP/IP network and has its own IP address, use a web browser to access the Command Center RX to modify or confirm the network settings. This menu is not displayed when using USB connection.

➔ [Command Center RX User Guide](#)

[Notification...]

This sets the display of the Status Monitor.

➔ [Status Monitor Notification Settings \(page 141\)](#)

[www.kyoceradocumentsolutions.com]

Open our website.

[Exit]

Exits the Status Monitor.

Status Monitor Notification Settings

The Status Monitor settings and event list details are displayed.

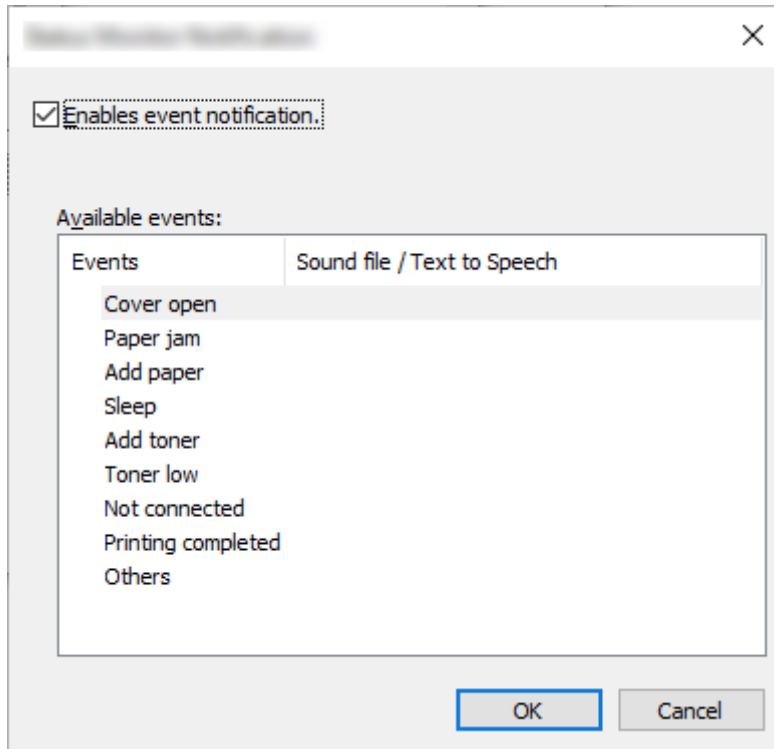

Select whether notification is performed when an error in the event list occurs.

1 Select "Enable event notification".

If this setting is set to Off, then the Status Monitor will not start up even when printing is executed.

2 Select an event to use with the text to speech function in Available events.

3 Click "Sound file / Text to Speech" column.

Click the browse (...) button to notify the event by sound file.

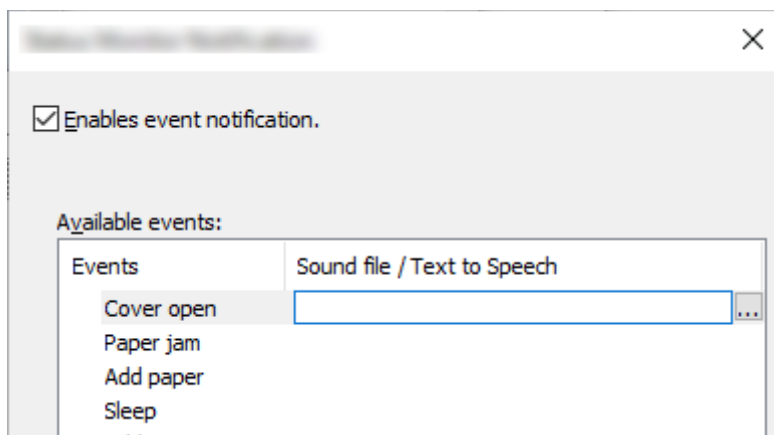



NOTE

The available file format is WAV.

When customizing the message texts to read on the screen aloud, enter the texts in the text box.

5 Operation on the Machine

Canceling Jobs

You can cancel jobs by pressing the [Cancel] key.

1 Confirm that [Processing.] is displayed on the message display, then select the [Cancel] key.

[Job Cancel List] appears, and the current job names are displayed.

2 Cancel a job.

1 Select the job to cancel, and select the [OK] key.

2 Select [Yes].

The job will be canceled.



NOTE

If the job is canceled and [Canceling...] is displayed, printing will be stopped after the page currently being printed is output.

Using Document Boxes

Document Box is a function for saving print data from a computer and sharing it with multiple users. The following types of document boxes are available:

- Custom Box
- Job Box
- USB Drive Box

What is Custom Box?

Custom Box is a component box which you can create within the Document Box and store data for later retrieval. You can create or delete a Custom Box.

The following operations are possible:

- Creating a new Custom Box
- Printing Document in a Custom Box
- Editing Documents in a Custom Box
- Deleting Documents in Custom Box

NOTE

- An optional SSD is required to use a Custom Box.
 - ➔ [HD-17/HD-18/HD-19 <SSD> \(page 378\)](#)
- The operation on Custom Box can also be performed from Command Center RX.
 - ➔ **Command Center RX User Guide**

What is Job Box?

Job Box is a generic name for the "Private Print/Stored Job Box", "Quick Copy/Proof and Hold Box", and "PIN Print Box".

These Job Boxes cannot be created or deleted by a user.

NOTE

- You can set up the machine so that temporary documents in job boxes are automatically deleted.
 - ➔ [Configure the Job Box \(page 136\)](#)
- For details on operating the "Private Print/Job Hold Box", "Quick Copy/Proof and Hold Box", or "PIN Print Box", refer to the following:
 - ➔ [Printing Data Saved in the Printer \(page 123\)](#)

What is USB Drive Box?

A USB drive can be connected to the USB memory slot on the machine to print a saved file. You can print data directly from the USB drive without a PC.

How to use Custom Box

Custom Box is a component box which you can create within the Document Box and store data for later retrieval. You can create or delete a Custom Box.

The following operations are possible:

- Create a new Box
- Store documents
- Print documents
- Edit documents
- Delete the document.



The operation on Custom Box can also be performed from Command Center RX.

➔ [Command Center RX User Guide](#)

Create a New Box



- An optional SSD is required to use the Custom box.
- If user login administration is enabled, you can only change the settings by logging in with administrator privileges.
If the user authentication screen appears, log in with a user who has the privilege to configure this setting. If you do not know your login user name or password, please contact your administrator.
- If user login administration is enabled, log in with administrator privileges to perform the following operations. They cannot be performed with user privileges.
 - Creating a box
 - Deleting a box of which the owner is another user

1 Display the screen.

Select the [Document Box] key.



If the box initial screen is set to the Job Box, display the Custom Box screen.

[Document Box] key > [Back] key > [▲][▼] key > [Custom Box] > [OK] key

2 Create a new box.

- 1 Select [Add].

- 2 Enter a box name and select the [OK] key.



NOTE

Names should be not more than 32 characters.

For details on entering characters, refer to the following:

→ [Character Entry Method \(page 1\)](#)

- 3 Enter the box number and select the [OK] key.



NOTE

The number can be set between 0001 and 1000.

Use the numeric keys or select the [▲] or [▼] key to enter a number.

If you specify a box number that is already in use, an error message appears when you select [OK] and the number cannot be registered. If you enter 0000, the smallest number available will be automatically assigned.

- 4 To complete the Custom Box registration, select the [▲][▼] key > [Exit] > [OK] key.

The Custom Box is created.

To register box information, select the [▲][▼] key > [Detail] > [OK] key.

Proceed to the next step.

3 Enter the box details.

Select [Edit] or [Change], enter the details, then select the [OK] key.

[▶] Select to display the next screen. Select the [◀] key to return to the previous screen. The following items can be set.

[Box Name]

Enter a box name consisting of up to 32 characters.

→ [Character Entry Method \(page 1\)](#)

[Owner]^{*1*2}

Set the owner of the box. Select the owner from the user list that appears.

[Permission]^{*1}

Select whether to share the box.

[Box Password]

User access to the box can be restricted by specifying a password to protect the box. Entering a password is not mandatory.

Enter a password of up to 16 characters and select the [OK] key. Enter the password again and select the [OK] key.

This can be set if [Shared] is selected in [Permission].

[Box Number]

Enter the box number by selecting the [▲] and [▼] keys or numeric keys. The box number can be from 0001 to 1000. A Custom Box should have a unique number. If you enter 0000, the smallest number available will be automatically assigned.

[Usage Restrict.]

The usage for a box can be restricted. To enable capacity restriction, enter a value for the storage capacity of the Custom Box in megabytes by using [▲], [▼] or the numeric keys. You can enter a limit between 1 and 30000 (MB) depending on the number of Custom Boxes created.

[Auto File Del.]

Automatically deletes stored documents after a set period of time.

To enable automatic deletion, select the [▲][▼] key > [Off/On] > [OK] key > [▲][▼] key > [On] > [OK] key

To set the period for storing a document, select the [▲][▼] key > [Period] > [OK] key

Enter the number of days for storing the document by using [▲], [▼], or the numeric keys. You can enter any number between 1 and 31 (day(s)).

To disable automatic deletion, select the [▲][▼] key > [Off/On] > [OK] key > [▲][▼] key > [Off] > [OK] key

[OverwriteSetting]

Specifies whether or not old stored documents are overwritten when new documents are stored.

To overwrite old documents, select the [▲][▼] key > [On] > [OK] key

To retain old documents, select the [▲][▼] key > [Off] > [OK] key

[Del. after Print]

Automatically deletes a document from the box once printing is complete.

To delete the document, select the [▲][▼] key > [On] > [OK] key

To retain the document, select the [▲][▼] key > [Off] > [OK] key

*1 Displayed when user login administration is enabled.

*2 Displayed when logged in as administrator.

Editing a Box

1 Display the screen.

Select the [Document Box] key.



NOTE

If the box initial screen is set to the Job Box, display the Custom Box screen.

[Document Box] key > [Back] key > [▲][▼] key > [Custom Box] > [OK] key

2 Edit the custom box.

1 Select the box to edit and select the [OK] key.



NOTE

- When you have logged in as a user, you can only edit a box whose owner is set to that user.
 - When you have logged in as administrator, you can edit all boxes.
 - If a custom box is protected by a password, enter the correct password.
-

2 [Menu] > [▲][▼] key > [Box Detail/Edit] > [OK] key

3 Change the box details.

➔ [Create a New Box \(page 146\)](#)

Delete the Custom Box.

1 Display the screen.

Select the [Document Box] key.



NOTE

If the box initial screen is set to the Job Box, display the Custom Box screen.

[Document Box] key > [Back] key > [▲][▼] key > [Custom Box] > [OK] key

2 Delete the custom box.

1 Select the box to delete and select the [OK] key.



NOTE

- When you have logged in as a user, you can only delete a box whose owner is set to that user.
 - When you have logged in as administrator, you can edit all boxes.
-

2 [Menu] > [▲][▼] key > [Delete] > [OK] key > [Yes]



NOTE

If a custom box is protected by a password, enter the correct password.

Storing Documents to a Custom Box

Custom box stores the print data which is sent from a PC. For the operation of the printing from the PC, refer to the following:

➔ **Printer Driver User Guide**

Printing Document in a Custom Box

1 Display the screen

- 1 Select the [Document Box] key.



NOTE

If the box initial screen is set to the Job Box, display the Custom Box screen.

[Document Box] key > [Back] key > [▲][▼] key > [Custom Box] > [OK] key

- 2 Select the box the document to print is in and select [OK] key.



NOTE

- If a custom box is protected by a password, enter the correct password.
 - If you select [Menu], you can perform the following operations.
 - [Sort]: Box order can be changed.
 - [Search(No.)]: Search for a Document Box by Box No.
-

2 Print

- 1 Select the document you wish to print and select [Select].

Select a document and a checkmark will appear on the right side of the selected document.

If you select [All Files], all documents will be marked with a checkmark on their right side.

When all documents are checked, all check marks are removed.

If you select a document marked with a checkmark and once again select [Select], the selection will be cleared.



NOTE

If you select [Menu], you can perform the following operations.

- [Search(Name)]
Search for a document by name.
 - [Box Detail/Edit]
Display or edit the details of the box.
➔ [Editing a Box \(page 149\)](#)
 - [File Detail]
Display the document details when the document is selected.
 - [Delete]
Delete the box.
➔ [Delete the Custom Box. \(page 150\)](#)
-

2 Select the [OK] key.

To use the print settings (the settings saved with the document), [▲][▼] key > [Print(ChangeSet)] > [OK] key

To change the print settings, [▲][▼] key > [Print(ChangeSet)] > [OK] key

Change the number of copies to print when [Print] is selected.

Change the print settings when [Print(ChangeSet)] is selected. For the features that can be selected, refer to the following:

➔ [Print Settings \(page 193\)](#)

Printing of the selected document begins.

Moving Documents in Custom Box

1 Display the screen

- 1 Select the [Document Box] key.

 **NOTE**

If the box initial screen is set to the Job Box, display the Custom Box screen.

[Document Box] key > [Back] key > [▲][▼] key > [Custom Box] > [OK] key

- 2 Select the box the document to move is in and select [OK] key.

 **NOTE**

- If a custom box is protected by a password, enter the correct password.
 - If you select [Menu], you can perform the following operations.
 - [Sort]: Box order can be changed.
 - [Search(No.)]: Search for a Document Box by Box No.
-

2 Move the file.

- 1 Select the document you wish to move and select [Select].

Select a document and a checkmark will appear on the right side of the selected document.

If you select [All Files], all documents will be marked with a checkmark on their right side.

When all documents are checked, all check marks are removed.

If you select a document marked with a checkmark and once again select [Select], the selection will be cleared.

 **NOTE**

If you select [Menu], you can perform the following operations.

- [Search(Name)]
Search for a document by name.
 - [Box Detail/Edit]
Display or edit the details of the box.
➔ [Editing a Box \(page 149\)](#)
 - [File Detail]
Display the document details when the document is selected.
 - [Delete]
Delete the box.
➔ [Delete the Custom Box. \(page 150\)](#)
-

- 2 [OK] key > [▲][▼] key > [Move] > [OK] key

- 3 Select the destination box and select [OK] key.

The document is moved.



NOTE

If a custom box is protected by a password, enter the correct password.

Deleting Documents in a Custom Box

1 Display the screen

- 1 Select the [Document Box] key.

NOTE

If the box initial screen is set to the Job Box, display the Custom Box screen.

[Document Box] key > [Back] key > [▲][▼] key > [Custom Box] > [OK] key

- 2 Select the box the document to delete is in and select [OK] key.

NOTE

- If a custom box is protected by a password, enter the correct password.
 - If you select [Menu], you can perform the following operations.
 - [Sort]: Box order can be changed.
 - [Search(No.)]: Search for a Document Box by Box No.
-

2 Delete the document.

- 1 Select the document you wish to delete and select [Select].

Select a document and a checkmark will appear on the right side of the selected document.

If you select [All Files], all documents will be marked with a checkmark on their right side.

When all documents are checked, all check marks are removed.

If you select a document marked with a checkmark and once again select [Select], the selection will be cleared.

NOTE

If you select [Menu], you can perform the following operations.

- [Search(Name)]
Search for a document by name.
 - [Box Detail/Edit]
Display or edit the details of the box.
➔ [Editing a Box \(page 149\)](#)
 - [File Detail]
Display the document details when the document is selected.
 - [Delete]
Delete the box.
➔ [Delete the Custom Box. \(page 150\)](#)
-

- 2 [OK] key > [▲][▼] key > [Delete] > [OK] key > [Yes]

Using Removable USB Drive

Plugging USB drive directly into the machine enables you to quickly and easily print the files stored in the USB drive without having to use a computer.

The following file types can be printed:

- PDF file (Version 1.7 or older)
- TIFF file (TIFF V6/TTN2 format)
- JPEG file
- XPS file
- OpenXPS file
- Encrypted PDF file

Printing Documents Stored in Removable USB Drive

NOTE

- PDF files you wish to print should have an extension (.pdf).
 - Plug the USB drive directly into the USB Memory Slot.
-

1 Plug the USB Drive.

Plug the USB drive into the USB Memory Slot.

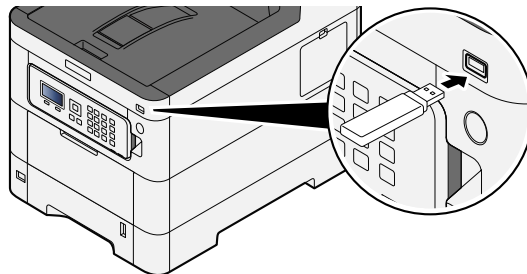

NOTE

If the USB drive screen is not displayed, display the USB drive screen.

[Menu] key > [▲][▼] key > [USB Drive] > [OK] key

2 Print the document.

1 [▲][▼] key > [Print File] > [OK] key

2 Select the folder containing the file to be printed and select the [OK] key.

NOTE

- 1,000 documents can be displayed.
 - To return to a higher level folder, select the [Back] key.
-

- 3 Select the document you wish to print and select [OK] key.



NOTE

Selecting [Detail] will display the details for the selected folder or document.

- 4 Change the number of copies, duplex printing, etc. as desired.

For the functions that can be set, refer to the following:

➔ [USB Drive \(Printing Documents\) \(page 161\)](#)

- 5 Select the [OK] key.

Printing of the selected document begins.

Removing USB Drive



IMPORTANT

Be sure to follow the proper procedure to avoid damaging the data or USB drive.

- 1 Display the screen.**

[Menu] key > [▲][▼] key > [USB Memory] > [OK] key

- 2 Select Remove.**

[▲][▼] key > [Remove USB Drive] > [OK] key

- 3 Remove the USB drive.**

6 Using Various Functions

About Functions Available on the Machine

This machine provides the various functions available.

Custom Box (Print)

Functions

Configure the settings for paper selection and duplex printing when printing from the USB drive.

Function	Description
[Quiet Mode]	The operating sound of the machine can be suppressed. ➔ Quiet Mode (page 162)
[Duplex]	Print a document to 1-side or 2-sided sheets. ➔ Duplex (page 163)
[EcoPrint]	EcoPrint saves toner when printing. ➔ EcoPrint (page 164)
[File Name Entry]	Name a document. ➔ File Name Entry (page 165)
[JobFinish Notice]	Sends E-mail notice when a job is complete. ➔ Job Finish Notice (page 166)
[Del. after Print]	Automatically deletes a document from the box once printing is complete. ➔ Delete after Printed (page 167)

USB Drive (Printing Documents)

Functions

Configure the settings for paper selection and duplex printing when printing from the USB drive.

Function	Description
[Quiet Mode]	The operating sound of the machine can be suppressed. ➔ Quiet Mode (page 162)
[Duplex]	Print a document to 1-side or 2-sides. ➔ Duplex (page 163)
[EcoPrint]	EcoPrint saves toner when printing. ➔ EcoPrint (page 164)
[File Name Entry]	Adds a file name in the document. ➔ File Name Entry (page 165)
[JobFinish Notice]	Sends E-mail notice when a job is complete. ➔ Job Finish Notice (page 166)
[Encrypted PDF]	Enter the preassigned password to print the PDF data. ➔ Encrypted PDF (page 168)
[TIFF/JPEG Size]	Select the image size when printing JPEG or TIFF files. ➔ TIFF/JPEG size (page 169)
[XPS FitTo Page]	Reduces or enlarges the image size to fit to the selected paper size when printing XPS file. ➔ XPS print area setting (page 170)

Quiet Mode

The operating sound of the machine can be suppressed. Set Quiet Mode if you are concerned about the operating sound.

You can configure each function to use Quiet Mode.

Value: [Off]/[On]

NOTE

In Quiet Mode, the processing speed will be slower than normal. Not available when [Prohibit] is selected in [Each Job].

➔ [Each Job \(page 245\)](#)

Duplex

Select binding orientation for duplex mode.

Value	Description
[Bind Long Edge], [Bind Short Edge]	[Bind Long Edge]? Images on the second sides are not rotated. [Bind Short Edge]? Images on the second sides are rotated 180 degrees. Print can be bound on the top edge, facing the same orientation when turning the pages.

Sample image

[Duplex] > [Bind Long Edge]



[Duplex] > [Bind Short Edge]



EcoPrint

EcoPrint saves toner when printing. Use this function for test prints or any other occasion when high quality print is not required.

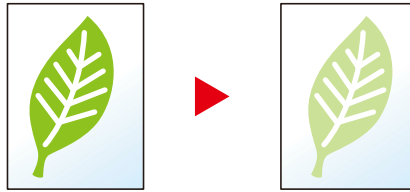

Value: [Off], [On]

File Name Entry

Adds a file name in the document.

Additional information such as job number and date and time can also be set. You can check a job history or job status using the file name, date and time, or job number specified here.

Enter the file name (up to 32 characters) and select the [OK] key.

To add a date and time, select [Date] and then select the [OK] key. To add a job number, select [Job No.] and then select the [OK] key. To add both, select [Job No. + Date] or [Date + Job No.] and then select the [OK] key.

Job Finish Notice

Sends E-mail notice when a job is complete.

It can also be set up to send a notice when a job is interrupted.

Users can be notified of the completion of a job while working at a remote desk, saving the time spent waiting beside the machine to finish.

NOTE

- PC should be configured in advance so that E-mail can be used. For details, refer to the following:
 - ➔ [Command Center RX \(page 78\)](#)
- E-mail can be sent to a single destination.

Item	Description
[Off]	Disables the function.
[Finished only]	Enter E-mail address directly. Enter the E-mail address (up to 128 characters) and select the [OK] Key.
[Fin.+Interrupted]	Enter E-mail address directly. Enter the E-mail address (up to 128 characters) and select the [OK] Key.

Delete after Printed

Automatically deletes a document from the box once printing is complete.

(Value: [Off]/[On])

Encrypted PDF

Enter the password you set to print the PDF data.

Enter the password and select the [OK] key.

 **NOTE**

For details on entering the password, refer to the following:

→ [Character Entry Method \(page 1\)](#)

TIFF/JPEG size

Select the image size when printing JPEG or TIFF files.

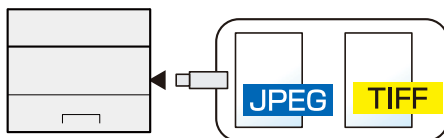

Item	Description
[Paper Size]	Fits the image size to the selected paper size.
[Image Resolution]	Prints at resolution of the actual image.
[Print Resolution]	Fits the image size to the print resolution.

XPS print area setting

Reduces or enlarges the image size to fit to the selected paper size when printing XPS file.

(Values [Off]/[On])

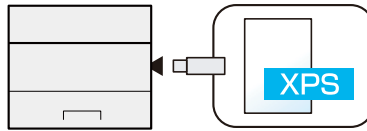

7 Status/Job Cancel

Checking Job Status

Check the status of jobs being processed or waiting to be printed.

Displaying Status Screens

1 Display the screen.

Select [Status] while the printer is waiting or printing.

[▲][▼] key > [Job Status] > [OK] key

2 Select the job you want to check.

Select the job to check, and select [OK] key or [Detail].



NOTE

- You can show the job statuses of all users, or only the statuses of your own jobs.
→ [Disp. Status/Log \(page 232\)](#)
 - This setting can also be changed from Command Center RX. For details, refer to the following:
→ [Command Center RX User Guide](#)
-

3 Check the information.

[▶] Select key to display the next page. Select the [◀] key to return to the previous screen.

[Job Name]

When the job name cannot be displayed because the job name is too long, selecting [Detail] will display the entire job name. Selecting the [OK] key will return to the original screen.

[Status]

[Processing.]: The status before starting to print

[Waiting]: Print Waiting

[Pause]: Pausing print job or error

[Canceling]: Canceling the job

[-----]: The job is ending.

[Job Type]

[Printer]: Printer job

[Report]: Printing Report/List

[USB]: Printing data from USB Drive

[Box]: Printing from Document Box

[Accepted Time]

Accepted Time of job

[User Name]

User Name for the executed job

[Printed Pages]

Printed Pages

Printed Pages / Total Printed Pages

[Color/B & W]

Color mode

[Auto Color]

[Full Color]

[Black & White]

[Mixed]

Checking Job History

NOTE

- Job history is also available by Command Center RX or KYOCERA Net Viewer from the computer. For details, refer to the following:
 - ➔ **Command Center RX User Guide**
 - ➔ **KYOCERA Net Viewer User Guide**
 - You can show the job log of all users, or only your own job log.
 - ➔ [Disp. Status/Log \(page 232\)](#)
 - This setting can also be changed from Command Center RX. For details, refer to the following:
 - ➔ **Command Center RX User Guide**
-

Displaying Job History Screen

1 Display the screen.

Select [Status] while the printer is waiting or printing.

[▲][▼] key > [Job Log] > [OK] key

2 Select the job you want to check.

Select the job to check, and select [OK] key or [Detail]. An icon showing the result of the job is displayed to the right of each job.

OK : The job finished normally.

 : Job error

 : Job cancelled

Checking the Detailed Information of Histories

1 Display the screen.

➔ [Displaying Job History Screen \(page 174\)](#)

2 Check the information.

[Job Name]

When the job name cannot be displayed because the job name is too long, selecting [Detail] will display the entire job name. Selecting the [OK] key will return to the original screen.

[Result]

[OK]: The Job is completed.

[Error]: Error has occurred.

[Cancel]: The job has been canceled.

[Job Type]

[Printer]: Printer job

[Report]: Printing Report/List

[USB]: Printing data from USB Drive

[Box]: Printing from Document Box

[Accepted Time]

Accepted Time of job

[User Name]

User Name for the executed job

[Printed Pages]

Printed Pages

Printed Pages / Total Printed Pages

[Color/B & W]

Color mode

[Auto Color]

[Full Color]

[Black & White]

[Mixed]

Sending the Log History

You can send the log history by E-mail. You can either send it manually as needed or have it sent automatically whenever a set number of jobs is reached.

➔ [Send History \(page 187\)](#)

Device Information

Configure the devices/lines installed or connected to this machine or check their status.

1 Display the screen.

- 1 Select [Status] while the printer is waiting or printing.

2 Check the information.

Select the item to check. Select the [OK] key to display the status of the selected device.

[Keyboard]

Displays the status of the USB keyboard and Bluetooth keyboard.

[Network]

Displays the state of the network connection.

[Wi-Fi]

Displays the Wi-Fi connection status and the network name (SSID) of the machine.

[Wi-Fi Direct]

Select [▲][▼] key > [Push Button Setup] > [OK] key and execute the push button of the device you want to connect to start the connection with the machine.

Select [▲][▼] key > [Detailed Information] > [OK] key to display the information for devices connected via Wi-Fi direct.

Select [▲][▼] key > [Connected] > [OK] > [Menu] key > [▲][▼] key > [Connected Device List] > [OK] key to display a list of connected devices.

Select [▲][▼] key > [Connected] > [OK] > [Menu] key > [▲][▼] key > [Disconnect All] > [OK] key to terminate all connections.

[Option Network]

Displays the connection status for the optional Wireless Network Interface Kit.

[Wireless Network]

Displays the connection status for the optional wireless network interface kit.

[Unit Condition]

You can check the remaining life of the drum unit and the cassette.

Checking the Remaining Amount of Toner (Paper/Supplies)

Check the remaining amount of toner, and paper on the LCD panel.

1 Display the screen

To check the remaining amount of toner, select [Toner] while the printer is waiting. Selecting [Paper] will return to the Paper Status screen.

2 Check the information.

The items you can check are described below.

Toner Status

The amount of toner remaining is shown in levels.

Paper Status

You can check the size and remaining amount of paper in each paper source. The amount of paper remaining is shown in levels.

8 System Menu

Operation Method

Configure settings related to overall machine operation. System Menu is operated as follows:

➔ [Using the Operation Panel \(page 40\)](#)

 **NOTE**

If the user authentication screen appears, log in with a user who has the privilege to configure this setting. If you do not know your login user name or password, please contact your administrator.

Refer to the following and configure the necessary settings.

➔ [System Menu Settings \(page 180\)](#)

System Menu Settings

This section explains the functions that can be configured in System Menu. To configure the settings, select the item in System Menu and select the setting item. For details on each function, see the table below.

[Report]

Print reports to check the machine settings and status.

➔ [Report \(page 185\)](#)

[Counter]

Check the number of pages printed.

➔ [Checking the Counter \(page 74\)](#)

[User Property]

You can check and change the information of the logged in user. For details related to information, see below.

➔ [Changing User Properties for Local Users \(Admin, DeviceAdmin, PowerUser\) \(page 252\)](#)

➔ [Changing User Properties for Network Users \(page 254\)](#)



NOTE

Displayed when the user login administration is enabled.

[Paper Settings]

Configure the paper settings.

➔ [Paper Settings \(page 188\)](#)

[Print Settings]

Configures settings for printing.

➔ [Print Settings \(page 193\)](#)

[Network]

Configures network settings.

➔ [Network \(page 200\)](#)

[Optional Network]

Configure settings for the optional Network Interface Kit or Wireless Network Interface Kit.

➔ [Optional Network \(page 222\)](#)

[Device Common]

Configure overall machine operation.

➔ [Device Common \(page 225\)](#)

Item	Description
[Language]	Set the language to use for the LCD panel display. ➔ Language (page 225)
[Def. Screen(Box)]	Set the screen displayed when you select the [Document Box] key. ➔ Def. Screen(Box) (page 225)
[Date Setting]	Configures settings related to the date and time. ➔ Date Setting (page 225)
[Buzzer]	Set options for buzzer sound during the machine operations. ➔ Buzzer (page 226)
[RAM Disk Setting]	Create a RAM disk and set its capacity. ➔ RAM Disk Setting (page 226)
[Format SSD]	Format the SSD. ➔ Format SSD (page 227)
[Format SD Card]	Format the SSD. ➔ Format SD Card (page 227)
[Display Bright.]	Set the brightness of the LCD panel. ➔ Display Bright. (page 227)
[Error Handling]	Select whether to cancel or continue the job when error has occurred. ➔ Error Handling (page 228)
[ColorToner Empty]	Select whether printing is prohibited or the Print in Black and White setting is used for printing once the color toner runs out. ➔ ColorToner Empty (page 228)
[Timer Setting]	Configures settings related to the time. ➔ Timer Setting (page 229)
[Disp. Status/Log]	Set the display of Job Status/Jobs History. ➔ Disp. Status/Log (page 232)
[Keyboard Type]	Select the keyboard type. ➔ Keyboard Type (page 232)
[Bluetooth Set.]	Set Bluetooth keyboard. ➔ Bluetooth Set. (page 232)
[Low Toner Alert]	Set the amount of remaining toner to notify the administrator when to order a toner when the toner is running low. ➔ Low Toner Alert (page 232)
[Msg Banner Print]	Set whether the confirmation screen appears before each sheet is printed when printing banner sheet. ➔ Msg Banner Print (page 234)
[Remote Printing]	Select whether to prohibit printing that is performed without operating the machine. ➔ Remote Printing (page 234)

Item	Description
[Direct PRN (Web)]	Set whether to allow Direct Printing from Command Center RX. ➔ Direct PRN (Web) (page 234)
[MaintenanceAlert]	Set the timing at which the administrator will be notified of the period remaining before the upcoming scheduled inspection when it is near. ➔ MaintenanceAlert (page 235)

[Security]

Configures security settings.

➔ [Security \(page 236\)](#)

Item	Description
[Network Security]	Security features can be set to protect operation of the machine and data. ➔ Network Security (page 236)
[I/F Block Set.]	This allows you to protect this machine by blocking the interface with external devices such as USB hosts or optional interfaces. ➔ I/F Block Set. (page 238)
[Security Level]	Specify the security level. ➔ Security Level (page 239)
[Data Security]	Configure settings related to data stored in SSD or memory. ➔ Data Security (page 240)
[Manual FW Update]	Set whether to allow firmware updates. ➔ Manual FW Update (page 241)
[Allowlisting]	Configure settings to prevent malware from running and prevent software tampering. ➔ Allowlisting (page 242)

[User/Job Account]

Configures settings related to machine management.

For details on user login administration, refer to the following:

➔ [Enable User Login Administration \(page 249\)](#)

For details on job accounting, refer to the following:

➔ [Enabling Job Accounting \(page 265\)](#)

[Application]

Configure the application settings.

➔ [Application \(page 244\)](#)

[Adjust/Maint.]

Adjust printing quality and conduct machine maintenance.

➔ [Adjust/Maint. \(page 245\)](#)

[Op Functions]

You can use the optional applications installed on this machine.

➔ [Op Functions \(page 246\)](#)

[Device Info.]

Shows Device Information.

➔ [\[Device Info.\] \(page 246\)](#)





Report

Print reports to check the machine settings, status, and history. Settings for printing reports can also be configured.

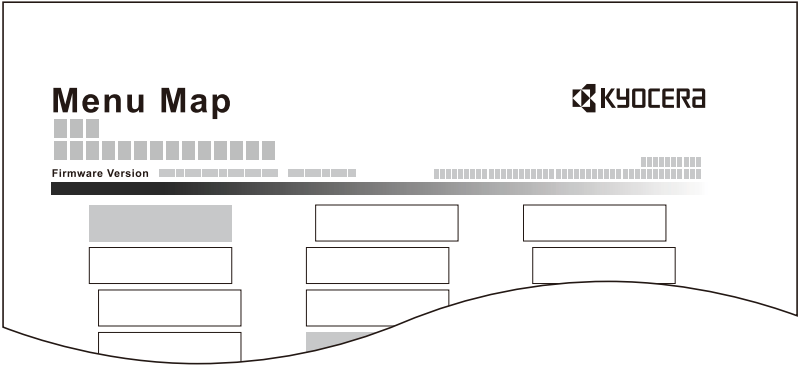
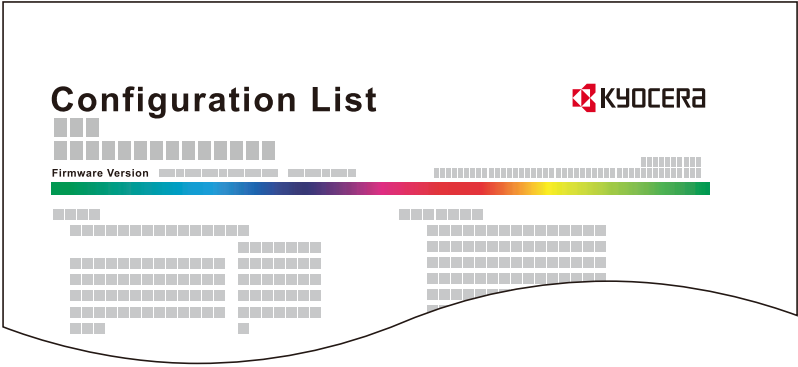
Report Print

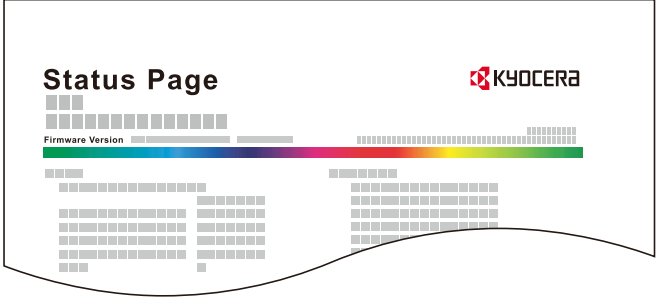
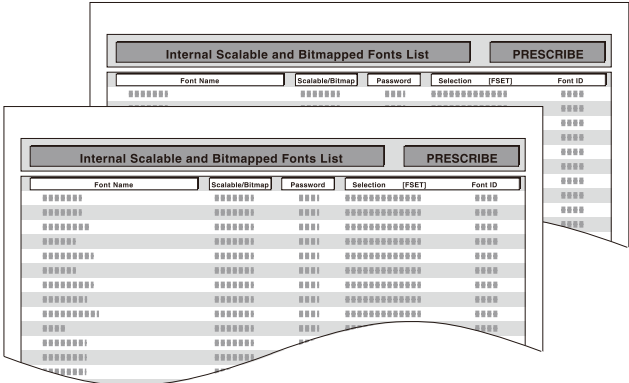
[Menu] key > [▲][▼] key > [Report] > [OK] key > [▲][▼] key > [Report Print] > [OK] key

Item	Description
[Menu Map]	<p>Prints the Menu Map. The machine's settings can be checked.</p> 
[Configuration List]	<p>Print the system settings as the list.</p> 

Item	Description
[Status Page]	<p>Prints the status page. You can check information such as the current settings, available memory, and installed optional devices.</p> 
[Font List]	<p>Prints the font list. You can check the fonts installed in this machine with a sample.</p> 
[RAM File List]	<p>You can print a list of the files on the RAM disk.</p> <hr/> <p> NOTE This function is displayed when [RAM Disk Mode] is set to [On].</p> <hr/>
[SSD File List]	<p>You can print a list of the files on the SSD disk.</p> <hr/> <p> NOTE Displayed when the optional SSD is installed.</p> <hr/>
[SD Card FileList]	<p>You can print a list of the files on the SD card.</p> <hr/> <p> NOTE Displayed when the SD card is installed.</p> <hr/>
[DataSanitization]	<p>Prints the data sanitization report.</p>

Job Log

[Menu] key > [▲][▼] key > [Report] > [OK] key > [▲][▼] key > [Job Log] > [OK] key

NOTE

For details on the Log History, refer to the following:

➔ [History Management \(page 187\)](#)

Item	Description
[Auto Sending]	<p>This function automatically sends the log history to the specified destinations whenever a set number of jobs has been logged.</p> <p>Value [Off/On]: [Off], [On] [Jobs]: Specify the number of job histories to be sent automatically.</p> <hr/> <p> NOTE</p> <p>If [On] is selected, specify the number of job histories to be sent automatically. The setting range is 1 to 16.</p>
[Send History]	You can also send the log history to the specified destinations manually.
[Destination]	<p>Check or set the destination to which log histories are sent.</p> <p>Value [Check]: Set the destination to which log histories are sent. [Address input]: Set the destination to which log histories are sent. Only E-mail address can be set.</p>
[Subject]	<p>Set the subject automatically entered when sending log histories by E-mail.</p> <p>Value: Up to 60 characters</p>
[Personal Info.]	<p>Select whether to include personal information in the job log.</p> <p>Value: [Include], [Exclude]</p>

History Management

It is possible to perform Log Management for the following logs on this machine.

Jobs Log

Log subject

- Print job completion
- Checking job status/Changing of jobs/Canceling of jobs

Log information

- Event occurrence date and time
- Event type

Paper Settings

[Menu] key > [▲][▼] key > [Paper Settings] > [OK] key

Configure the paper and paper source settings.

MP Tray Set.

[Menu] key > [▲][▼] key > [Paper Settings] > [OK] key > [▲][▼] key > [MP Tray Set.] > [OK] key

Item	Description
[Paper Size]	Select the paper size. Value: [Envelope Monarch], [Envelope #10], [Envelope DL], [Envelope C5], [Executive], [Letter], [Legal], [A4], [B5], [A5-R], [A5], [A6], [B6], [Envelope #9], [Envelope #6], [ISO B5], [Custom], [Cardstock], [Oufuku], [Oficio II], [216x340mm], [16K], [Statement-R], [Statement], [Folio], [Youkei 2], [Youkei 4], [Nagagata 3], [Nagagata 4], [Younaga 3]
[Media Type]	Select the media type. Value: [Plain], [Preprinted], [Labels], [Bond], [Recycled], [Vellum], [Rough],[Letterhead], [Color], [Prepunched], [Envelope], [Cardstock], [Coated], [Thick], [High Quality], [CUSTOM 1] to [CUSTOM 8] To change to a media type other than "Plain," refer to the following. → Media Type Set. (page 191)

Cassette 1 Set. to Cassette 5 Set. Settings

[Menu] key > [▲][▼] key > [Paper Settings] > [OK] key > [Cassette 1 Set.] (to[Cassette 5 Set.]) > [OK] key

NOTE

[Cassette 2] to [Cassette 5] are displayed when the following optional paper feeder is installed.

[Cassette 2]: Paper Feeder (550-sheet)

[Cassette 3]: Paper Feeder (550-sheet)

[Cassette 4]: Paper Feeder (550-sheet)

[Cassette 5]: Paper Feeder (550-sheet)

Item	Description
[Media Type]	<p>Value (Cassette 1) [Plain], [Transparency], [Preprinted], [Bond], [Recycled], [Vellum], [Rough],[Letterhead], [Color], [Prepunched], [Thick], [High Quality], [CUSTOM 1] to [CUSTOM 8]</p> <p>Value (Cassette 2 to 5) [Plain], [Preprinted], [Labels], [Bond], [Recycled], [Vellum], [Rough],[Letterhead], [Color], [Prepunched], [Envelope], [Coated], [Thick], [High Quality], [CUSTOM 1] to [CUSTOM 8]</p> <p>To change to a media type other than "Plain," refer to the following. ➔ Media Type Set. (page 191)</p> <p>When a paper weight that cannot be loaded in the cassette is set for a media type, that media type does not appear.</p>
[Other Paper Size]	<p>Select the paper size.</p> <p>Value (Cassette 1) [Executive], [Letter], [Legal], [A4], [B5], [A5-R], [A5], [A6], [B6], [ISO B5], [Custom], [Oficio II], [216x340mm], [16K], [Statement-R], [Statement], [Folio]</p> <p>Value (Cassette 2 to 5) [Envelope Monarch], [Envelope #10], [Envelope DL], [Envelope C5], [Executive], [Letter], [Legal][A4], [B5], [A5-R], [B6], [Envelope #9], [Envelope #6], [ISO B5], [Custom], [Oficio II], [216x340mm], [16K], [Statement-R], [Folio], [Youkei 2], [Youkei 4], [Nagagata 3], [Nagagata 4], [Younaga 3]</p>

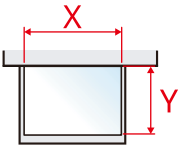
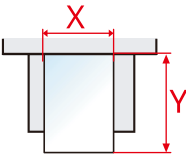
Item	Description
[Custom Paper]	<p>Register the custom size used for Cassette 1 to Cassette 5. Used when the size dial of the cassette is set to "Other".</p> <p>Value Cassette1:</p> <p>[mm] X: 105 to 216 mm (in 1 mm increments) Y: 140 to 356 mm (in 1mm increments)</p> <p>[inch] X: 4.13 to 8.50" (in 0.01" increments) Y: 5.50 to 14.02" (in 0.01" increments)</p> <p>Value Cassette 2 to Cassette 5:</p> <p>[mm] X: 92 to 216 mm (in 1 mm increments) Y: 162 to 356 mm (in 1mm increments)</p> <p>[inch] X: 3.62 to 8.50" (in 0.01" increments) Y: 6.38 to 14.02" (in 0.01" increments)</p> <p>X=Width, Y=Length</p> <p style="text-align: center;">Vertical Horizontal</p> <div style="display: flex; justify-content: space-around; align-items: center;"></div>

Media Type Set.

[Menu] key > [▲][▼] key > [Paper Settings] > [OK] key > [Media Type Set.] > [OK] key

Select weight for each media type.

The following media type and paper weight combinations are available.

Paper Weight	Weight (g/m ²) and Media Type
Light	52 g/m ² to 59 g/m ²
Normal 1	60 g/m ² to 74 g/m ²
Normal 2	75 g/m ² to 90 g/m ²
Normal 3	91 g/m ² to 105 g/m ²
Heavy 1 ^{*1}	106 g/m ² to 135 g/m ²
Heavy 2 ^{*1}	136 g/m ² to 163 g/m ²
Heavy 3 ^{*1}	164 g/m ² to 220 g/m ²
Extra Heavy ^{*1}	Transparencies

*1 The processing speed will be slower than normal.

Each media type's default weight is indicated.

Media Type	Default
[Plain]	[Normal 1]
[Vellum]	[Normal 1]
[Labels]	[Heavy 1]
[Recycled]	[Normal 1]
[Preprinted]	[Normal 2]
[Bond]	[Normal 3]
[Cardstock]	[Heavy 3]
[Color]	[Normal 1]
[Prepunch]	[Normal 1]
[Letterhead]	[Normal 2]
[Envelope]	[Heavy 2]
[Thick]	[Heavy 2]
[Coated]	[Normal 3]
[High Quality]	[Normal 1]
[CUSTOM 1] to [CUSTOM 8]	[Normal 1]

For [CUSTOM 1] to [CUSTOM 8], settings for duplex printing and media type name can be changed.

[Duplex]

Item	Description
[Permit]	Duplex printing allowed.
[Prohibit]	Duplex printing not allowed.

[Name Entry]

Change names for Custom 1-8. Names should be not more than 16 characters. Selecting media type at multipurpose tray, the name after change will be displayed.

→ [Character Entry Method \(page 1\)](#)

Reset Type Adj.

[Menu] key > [▲][▼] key > [Paper Settings] > [OK] key > [Reset Type Adj.] > [OK] key

Reset all attribute settings related to media type set in Media Type Setting.

Paper Setup Msg

[Menu] key > [▲][▼] key > [Paper Settings] > [OK] key > [Paper Setup Msg] > [OK] key

Set whether to display the confirmation screen for the paper setting when a new paper is set for each cassette.

Item	Description
[Cassette 1]to [Cassette 5]	Value: [Off], [On]
[MP Tray]	 NOTE [Cassette 2] to [Cassette 5] are displayed when the following optional paper feeder is installed. [Cassette 2]: Paper Feeder (550-sheet) [Cassette 3]: Paper Feeder (550-sheet) [Cassette 4]: Paper Feeder (550-sheet) [Cassette 5]: Paper Feeder (550-sheet)

Print Settings

[Menu] key > [▲][▼] key > [Print Settings] > [OK] key

[Paper Source]

Select the default paper source.

Value: [Cassette 1] to [Cassette 5], [MP Tray]

NOTE

[Cassette 2] to [Cassette 5] are displayed when the following optional paper feeder is installed.

[Cassette 2]: Paper Feeder (550-sheet)

[Cassette 3]: Paper Feeder (550-sheet)

[Cassette 4]: Paper Feeder (550-sheet)

[Cassette 5]: Paper Feeder (550-sheet)

[Auto Cass.Change]

Select the following actions when the paper runs out in the paper source while printing.

Value: [Off], [On]

NOTE

- When selecting [Off], the machine displays "Add the following paper in cassette #." (# is a cassette number) or "Add the following paper in the multipurpose tray.", and stops printing.
 - When you load the paper in the cassette displayed in the message, printing resumes.
 - If you wish to print from another cassette, select the desired paper source with[Alt.].
 - When selecting [On], the machine continues printing automatically when the other cassette contains the same paper as the currently-used cassette.
-

[MP Tray Priority]

If paper is set in the MP Tray then it is possible for priority to be given to that MP tray in the paper feed.

Value	Description
[Off]	The printer driver settings are followed.
[Auto Feed]	If Auto is selected in the printer driver and there is paper in the MP tray then the paper feed will be from the MP tray.
[Always]	If there is paper in the MP tray then the paper feed will be from the MP tray regardless of what is set in the printer driver.

[Paper Feed Mode]

While printing from the computer, select how to feed paper when the paper source and type are specified.

Value	Description
[Auto]	Search the paper source that matches the selected paper size and type.
[Fixed]	Print on paper loaded in the specified paper source.

[2-sided]

Select binding orientation for duplex mode.

Value: [Off], [Bind Long Edge], [Bind Short Edge]

[Override A4/LTR]

Select whether to treat A4 size and Letter, which are similar in size, as the same size when printing.

Value	Description
[Off]	A4 and Letter are not regarded as the same in size.
[On]	A4 and Letter are regarded as the same in size. The machine will use whichever size is in the paper source.

[Emulation Set.]

Select the emulation for operating this machine by commands oriented to other types of printers.

Value: PCL6, KPDL, KPDL(Auto)



NOTE

- When you have selected [KPDL(Auto)], set [Alt. Emulation], too.
 - When you have selected [KPDL] or [KPDL(Auto)], set [KPDL Error Rpt.], too.
-

[KPDL Error Rpt.]

When an error has occurred during printing in KPDL emulation mode, set whether or not the error report is output.

Value: [Off], [On]



[Color Mode]

You can choose whether reports are printed in full color or black and white.

Value: [Full Color], [Black & White]

[Print Quality]

Set the printing quality.

Value	Description
[KIR]	Select the default KIR (smoothing) setting. Value: [Off], [On]
[EcoPrint]	EcoPrint conserves toner when printing. This is recommended for test copies where faded printing is not a problem. Value: [Off], [On]
[EcoPrint SaveLv]	Select the default Toner Save Level (EcoPrint). Value: 1 (low), 2, 3, 4, 5 (high) Raising the level reduces toner consumption, but image quality falls.
[Gloss Mode]	Gloss Mode increases the effect of glossiness in printing. However, printing takes longer time. Value: [Off], [On] <hr/>  IMPORTANT This function is not available when [Labels] or [Transparency] is selected as the paper type setting. ➔ Paper Settings (page 188) Depending on the paper used, printing in gloss mode may cause curl in paper. To reduce curl, try using thicker paper. <hr/>
[Print Resolution]	Set the resolution used for printing. Value: 600 dpi, 1200 dpi <hr/>  NOTE Settings that are received from the printer driver have priority over the operation panel settings. <hr/>

[Page Setting]

Value	Description
[Copies]	Set the default number of copies, from 1 to 999. Value: 1 to 999 copies
[Reduced Print]	Configure settings for reducing the print data and printing (reduced printing). Set the paper size before reduction and reduction ratio. → About reduced print settings (page 198)  NOTE In reduced printing, unlike the print result of 1x size, the line width of characters may not be constant, or lines may be seen in figures, images, patterns, etc. Also, thin lines may not be printed. Also, if you print the barcode in reduced size, it may not be readable.
[Orientation]	Set the default orientation, [Portrait] or [Landscape]. Value: [Portrait], [Landscape]
[LF Action]	Set the line feed action when the machine receives the line feed code (character code 0AH). Value: [LF Only], [LF and CR], [Ignore LF]
[CR Action]	Set the character return action when the machine receives the character return code (character code 0DH). Value: [CR Only], [LF and CR], [Ignore CR]
[Wide A4]	Turn this to [On] to increase the maximum number of characters that can be printed in a line for an A4 page (78 characters at 10 pitch) and Letter size page (80 characters at 10 pitch). This setting is only effective in PCL6 emulation. Value: [Off], [On]
[XPS FitTo Page]	Set the default value for the XPS fit to page function. Value: [Off], [On]
[TIFF/JPEG Size]	Select the image size (resolution) when printing JPEG or TIFF file. Value: [Paper Size], [Image Resolution], [Print Resolution]
[File Name Entry]	Set an automatically entered name (default) for jobs. Value File Name: Up to 32 characters can be entered. Additional information: [Not Installed], [Job No.], [Date and Time], [Job No. + Date], [Date + Job No.]

[User Name]

Set whether the user name set in the printer driver is displayed.

Value: [Off], [On]

[Job Name]

Set whether the job name set in the printer driver is displayed.

Value: [Off], [Job Name], [Job No.+Job Name], [Job Name+Job No.]

[Job Terminator]

You can select the condition which regarded as a job termination if the print job could not be processed until the end due to your environment and the other reason.

Value	Description
[EOJ]	The command recognized as a termination of the job data is regarded as one job until it is detected.
[End of Session]	The data included in a network session at network connection is regarded as one job.
[UEL]	The UEL included in the termination of the job data is regarded as one job until it is detected.

About reduced print settings

The reduced print is displayed as follows.

Source size

Paper size before reduction. It must be the same as the paper size set for the print data.

Target size (reduction ratio)

The paper size or reduction ratio after reduction. It is displayed in paper size or magnification.

Source size	Target size (reduction ratio)
Cassette size	100%
	98%
Ledger	Letter
Legal	100%
	98%
Letter	100%
	A4
	98%
Oficio II	100%
Folio	100%
16K	100%
A5-R	100%
	98%
B5	100%
	A5-R
	98%

Source size	Target size (reduction ratio)
A4	100%
	Letter
	B5
	A5-R
	98%
B4	B5
	A4
A3	A4
SF(Stock Form)(A4)	A4

Network

Configures network settings.

Host Name

[Menu] key > [▲] [▼] key > [Network] > [OK] key > [▲] [▼] key > [Host Name] > [OK] key

Item	Description
[Host Name]	Check the host name of the machine. Host name can be changed from Command Center RX. ➔ Changing Device Information (page 81)





Wi-Fi Direct Set

[Menu] key > [▲][▼] key > [Network] > [OK] key > [▲][▼] key > [Wi-Fi Direct Set] > [OK] key
Set Wi-Fi Direct.

NOTE

This function is displayed when the Wireless Network Interface Kit (IB-37 or IB-38) is installed.

The Wireless Network Interface Kit is an option for some models. Contact your dealer or our sales or service representatives for detail.

Item	Description
[Wi-Fi Direct]	Select whether to use Wi-Fi Direct. Value: [Off], [On]
[Device Name]	Specify the device name.  NOTE <ul style="list-style-type: none"> Up to 32 characters can be entered. This function is displayed when [Wi-Fi Direct] is set to [Enable].
[IP Address]	Check the IP address of the machine. → [TCP/IP Settings][TCP/IP Settings] (page 208)  NOTE This function is displayed when [Wi-Fi Direct] is set to [Enable].
[Auto Disconnect]	Automatically disconnect devices connected through Wi-Fi Direct. Value: [Off], [On]  NOTE <ul style="list-style-type: none"> If you select [On], set the waiting time for automatic disconnection. This function is displayed when [Wi-Fi Direct] is set to [Enable].
[Persistent Group]	Set whether Wi-Fi Direct connection as Persistent Group (information for the connection is kept even if the power is turned off). Value: [Off], [On]  NOTE This function is displayed when [Wi-Fi Direct] is set to [Enable].
[Frequency Band]	Set the frequency band to be used. Specify when using IB-37/IB-38. Value: [2.4 GHz], [5 GHz]

Item	Description
[Password]	<p>Select whether the Wi-Fi Direct password is automatically generated or created manually.</p> <p>When [Auto] is selected, the Persistent Group setting changes to [On]. Value: [Auto], [Manual]</p> <hr/> <p> NOTE</p> <p>If [Manual] is selected, set a password (8 or more characters).</p> <hr/>

Wi-Fi Settings

[Menu] key > [▲][▼] key > [Network] > [OK] key > [▲][▼] key > [Wi-Fi Settings] > [OK] key
Set Wi-Fi Direct.

NOTE

This function is displayed when the Wireless Network Interface Kit (IB-37 or IB-38) is installed.

The Wireless Network Interface Kit is an option for some models. Contact your dealer or our sales or service representatives for detail.

[Wi-Fi]

Item	Description
[Wi-Fi]	<p>Select whether to use Wi-Fi.</p> <p>Value: [Off], [On]</p>

[Connect-SelectNW]

Displays access points to which the machine can connect.

Item	Description
[AvailableNetwork]	<p>Select connectable access points, select the [OK] key, and enter the WEP key or the pre-shared key to connect.</p> <hr/> <p> NOTE</p> <ul style="list-style-type: none"> • Select [Reload] and the computer list will be reloaded. • If the access point security setting is WEP, select [Menu] and set [WEP Key Index]. <hr/>

[Connect-by Other]

[Push Button]

If the access point supports the push button method, wireless settings can be configured using the push button. This setting executes push button, and the connection is started by pressing the push button on the access point.

 **NOTE**

The push button method supports only the WPS.

[PIN (Device)]

Starts connection using the machine's PIN code. Enter the PIN code into the access point. The PIN code of the machine is automatically generated.

[Custom Setup]

The detailed settings for wireless LAN can be changed.

Item	Description
[Netwk Name(SSID)]	Set the SSID (Service Set Identifier) of the wireless LAN to which the machine connects. <hr/>  NOTE Up to 32 characters can be entered.
[Netwk Authentic.]	Select network authentication type. Value: [Open], [WPA2/WPA-PSK], [WPA2-PSK], [WPA2/WPA-EAP], [WPA2-EAP], [WPA3SAE/WPA2PSK], [WPA3-SAE], [WPA3/WPA2-EAP], [WPA3-EAP]

Item	Description
[Encryption]	<p>Select encryption method. The setting values vary depending on the Network Authentication setting.</p> <p>Open Value: [Disable], [WEP]</p> <hr/> <p> NOTE If you selected [WEP], set the WEP key (up to 26 characters) and WEP Key Index (0 to 3).</p> <hr/> <p>WPA2/WPA-PSK Value: [AES], [Auto], [Preshared Key] (up to 64 characters)</p> <p>WPA2-PSK Value: [Preshared Key] (up to 64 characters)</p> <p>WPA2/WPA-EAP Value: [AES], [Auto]</p> <p>WPA2-EAP Value: —</p> <p>WPA3-SAE/WPA2-PSK Value: [Preshared Key]</p> <p>WPA3-SAE Value: [Preshared Key]</p> <p>WPA3/WPA2-EAP Value: —</p> <p>WPA3-EAP Value: —</p>

[TCP/IP Settings][TCP/IP Settings]**[TCP/IP]**





Select whether to use TCP/IP Protocol.

Value: [Off], [On]

[IPv4 Setting]

Set up TCP/IP (IPv4) to connect to the network.

This setting is available when [TCP/IP] is [On].



Item	Description
[DHCP]	Select whether to use the DHCP (IPv4) server. Value: [Off], [On]
[Auto-IP]	Select whether to use Auto-IP. Value: [Off], [On]
[IP Address]	Set the IP address. Value: ###.###.###.###  NOTE When DHCP is set to [On], the value cannot be entered.
[Subnet Mask]	Set the IP subnet mask. Value: ###.###.###.###  NOTE When DHCP is set to [On], the value cannot be entered.
[Default Gateway]	Set the IP gateway address. Value: ###.###.###.###  NOTE When DHCP is set to [On], the value cannot be entered.
[DNS Server]	Set the IP address of DNS (Domain Name System) server. Value: [Auto (DHCP)], [Manual]  NOTE When [Manual] is selected, enter the DNS server IP address in the Primary and Secondary fields provided.
[DNS over TLS]	Set whether to connect to a DNS server during communication protected by TLS. Value: [Off], [On], [Auto]



✔ IMPORTANT

- When setting the Auto-IP, enter "0.0.0.0" in IP Address.
- After changing the setting, restart the network or turn the machine OFF and then ON.

[IPv6 Setting]

Set up TCP/IP (IPv6) to connect to the network. This setting is available when [TCP/IP] is [On].

Item	Description
[IPv6 Setting]	<p>Select whether to use IPv6. Value: [Off], [On]</p> <hr/> <p> NOTE</p> <p>Selecting [On] displays IP address in [Link Local] after restarting the network.</p>
[Manual Settings]	<p>Manually specify the IP address, prefix length, and gateway address of TCP/IP (IPv6). Value</p> <p>[IP Address] 128-bits address is expressed in eight groups consisting of four-digit hexadecimal digits. The groups are separated by colon (:).</p> <p>[Prefix Length] 0 to 128</p> <p>[Default Gateway] 128-bits address is expressed in eight groups consisting of four-digit hexadecimal digits. The groups are separated by colon (:).</p> <hr/> <p> NOTE</p> <ul style="list-style-type: none"> • This function is displayed when [IPv6 Setting] is set to [On]. • To enter [Default Gateway], set [RA(Stateless)] to [Off].
[RA(Stateless)]	<p>Select whether to use RA (Stateless). Value: [Off], [On]</p> <hr/> <p> NOTE</p> <ul style="list-style-type: none"> • This function is displayed when [IPv6 Setting] is set to [On]. • Selecting [On] displays [IP Address 1] - [IP Address 5] to after restarting the network.

Item	Description
[DHCPv6 Settings]	<p>Select whether to use the DHCP (IPv6) server. Value: [Off], [On]</p> <hr/> <p> NOTE</p> <ul style="list-style-type: none"> • This function is displayed when [IPv6 Setting] is set to [On]. • Selecting [On] displays IP address in [IP Address] after restarting the network.
[DNS Server]	<p>Set the IP address of DNS (Domain Name System) server. Value: [Auto (DHCP)], [Manual]</p> <hr/> <p> NOTE</p> <p>When [Manual] is selected, enter the DNS server IP address in the Primary and Secondary fields provided.</p>
[DNS over TLS]	<p>Set whether to connect to a DNS server during communication protected by TLS. Value: [Off], [On], [Auto]</p>

 **IMPORTANT**

After changing the setting, restart the network or turn the machine OFF and then ON.

[ConnectionStatus]

Displays the status and name of the connected network.

Wired Netwk. Set

[Menu] key > [▲][▼] key > [Network] > [OK] key > [▲][▼] key > [Wired Netwk. Set] > [OK] key
Configure wired network settings.

[TCP/IP Settings][TCP/IP Settings]

[TCP/IP]



Select whether to use TCP/IP Protocol.

Value: [Off], [On]

[IPv4 Setting]

Set up TCP/IP (IPv4) to connect to the network.

This setting is available when [TCP/IP] is [On].

Item	Description
[DHCP]	Select whether to use the DHCP (IPv4) server. Value: [Off], [On]
[Auto-IP]	Select whether to use Auto-IP. Value: [Off], [On]
[IP Address]	Set the IP address. Value: ###.###.###.###  NOTE When DHCP is set to [On], the value cannot be entered.
[Subnet Mask]	Set the IP subnet mask. Value: ###.###.###.###  NOTE When DHCP is set to [On], the value cannot be entered.
[Default Gateway]	Set the IP gateway address. Value: ###.###.###.###  NOTE When DHCP is set to [On], the value cannot be entered.

Item	Description
[DNS Server]	<p>Set the IP address of DNS (Domain Name System) server. Value: [Auto (DHCP)], [Manual]</p> <hr/> <p> NOTE</p> <p>When [Manual] is selected, enter the DNS server IP address in the Primary and Secondary fields provided.</p> <hr/>
[DNS over TLS]	<p>Set whether to connect to a DNS server during communication protected by TLS. Value: [Off], [On], [Auto]</p>





 **IMPORTANT**

- When setting the Auto-IP, enter "0.0.0.0" in IP Address.
- After changing the setting, restart the network or turn the machine OFF and then ON.

[IPv6 Setting]

Set up TCP/IP (IPv6) to connect to the network. This setting is available when [TCP/IP] is [On].

Item	Description
[IPv6 Setting]	<p>Select whether to use IPv6. Value: [Off], [On]</p> <hr/> <p> NOTE</p> <p>Selecting [On] displays IP address in [Link Local] after restarting the network.</p> <hr/>

Item	Description
[Manual Settings]	<p>Manually specify the IP address, prefix length, and gateway address of TCP/IP (IPv6). Value</p> <p>[IP Address] 128-bits address is expressed in eight groups consisting of four-digit hexadecimal digits. The groups are separated by colon (:).</p> <p>[Prefix Length] 0 to 128</p> <p>[Default Gateway] 128-bits address is expressed in eight groups consisting of four-digit hexadecimal digits. The groups are separated by colon (:).</p> <hr/> <p> NOTE</p> <ul style="list-style-type: none"> • This function is displayed when [IPv6 Setting] is set to [On]. • To enter [Default Gateway], set [RA(Stateless)] to [Off].
[RA(Stateless)]	<p>Select whether to use RA (Stateless). Value: [Off], [On]</p> <hr/> <p> NOTE</p> <ul style="list-style-type: none"> • This function is displayed when [IPv6 Setting] is set to [On]. • Selecting [On] displays [IP Address 1] - [IP Address 5] to after restarting the network.
[DHCPv6 Settings]	<p>Select whether to use the DHCP (IPv6) server. Value: [Off], [On]</p> <hr/> <p> NOTE</p> <ul style="list-style-type: none"> • This function is displayed when [IPv6 Setting] is set to [On]. • Selecting [On] displays IP address in [IP Address] after restarting the network.
[DNS Server]	<p>Set the IP address of DNS (Domain Name System) server. Value: [Auto (DHCP)], [Manual]</p> <hr/> <p> NOTE</p> <p>When [Manual] is selected, enter the DNS server IP address in the Primary and Secondary fields provided.</p>

Item	Description
[DNS over TLS]	Set whether to connect to a DNS server during communication protected by TLS. Value: [Off], [On], [Auto]

 **IMPORTANT**

After changing the setting, restart the network or turn the machine OFF and then ON.

[LAN Interface]

Item	Description
[LAN Interface]	Specify the settings for the LAN interface to be used. Value: [Auto], [10BASE-Half], [10BASE-Full], [100BASE-Half], [100BASE-Full], [1000BASE-T]

 **IMPORTANT**

After changing the setting, restart the network or turn the machine OFF and then ON.

ProtocolSettings

[Menu] key > [▲][▼] key > [Network] > [OK] key > [▲][▼] key > [ProtocolSettings] > [OK] key
Configures protocol settings.

[Bonjour]

Item	Description
[Off/On]	Select whether to use Bonjour. Value: [Off], [On]
[AvailableNetwork]	Set whether to enable this function for each network of Wi-Fi Direct, Wi-Fi and wired. Value: [Disable], [Enable]

[IP Filter (IPv4)]

Item	Description
[Off/On]	Configure the IP Filter Setting. IP filter is a function used to restrict the access to the machine by setting the IP address and protocol. The IP address or network address of permitted hosts is set from Command Center RX. Not setting the IP Filter will allow access from all hosts. Value: [Off], [On] ➔ Command Center RX User Guide

[IP Filter (IPv6)]

Item	Description
[Off/On]	Configure the IP Filter Setting. IP filter is a function used to restrict the access to the machine by setting the IP address and protocol. The IP address or network address of permitted hosts is set from Command Center RX. Not setting the IP Filter will allow access from all hosts. Value: [Off], [On] ➔ Command Center RX User Guide

[IPSec]

Item	Description
[Off/On]	Set whether or not to use the IPSec. Value: [Off], [On]

[NetBEUI]

Item	Description
[Off/On]	Set whether to send documents using NetBEUI. The setting will be changed after restarting the device or network. Value: [Off], [On]
[AvailableNetwork]	Set whether to enable this function for each network of Wi-Fi Direct, Wi-Fi and wired. Value: [Disable], [Enable]

[SNMPv3]

Item	Description
[Off/On]	Set whether to communicate using SNMPv3. The setting will be changed after restarting the device or network. Value: [Off], [On]
[AvailableNetwork]	Set whether to enable this function for each network of Wi-Fi Direct, Wi-Fi and wired. Value: [Disable], [Enable]

[FTP(Server)]

Item	Description
[Off/On]	Set whether to send documents using FTP. The setting will be changed after restarting the device or network. Value: [Off], [On]
[AvailableNetwork]	Set whether to enable this function for each network of Wi-Fi Direct, Wi-Fi and wired. Value: [Disable], [Enable]

[SNMP]

Item	Description
[Off/On]	Select whether to communicate using SNMP. The setting will be changed after restarting the device or network. Value: [Off], [On]
[AvailableNetwork]	Set whether to enable this function for each network of Wi-Fi Direct, Wi-Fi and wired. Value: [Disable], [Enable]

[SMTP]

Item	Description
[Off/On]	Select whether to send E-mail using SMTP. Value: [Off], [On]

[POP3]

Item	Description
[Off/On]	Select whether to receive E-mail using POP3. Value: [Off], [On]

[RAW Port]

Item	Description
[Off/On]	Set whether to receive documents using the Raw Port. The setting will be changed after restarting the device or network. Value: [Off], [On]
[AvailableNetwork]	Set whether to enable this function for each network of Wi-Fi Direct, Wi-Fi and wired. Value: [Disable], [Enable]

[LPD]

Item	Description
[Off/On]	Set whether to send documents using LPD. The setting will be changed after restarting the device or network. Value: [Off], [On]
[AvailableNetwork]	Set whether to enable this function for each network of Wi-Fi Direct, Wi-Fi and wired. Value: [Disable], [Enable]

[IPP]

Item	Description
[Off/On]	Set whether to send documents using IPP. To use this, select [On] for this setting, and select [Off] for [TLS] in the [Security]. Then select [Not Secure (IPPS & IPP)] in the security settings from Command Center RX. The default port number is 631. Value: [Off], [On], 1 to 32767 (Port Number)
[AvailableNetwork]	Set whether to enable this function for each network of Wi-Fi Direct, Wi-Fi and wired. Value: [Disable], [Enable]

[IPP over TLS]

Item	Settings
[Off/On]	<p>Sets whether to receive documents using TLS-protected IPP. To use this, select [On] in these settings, and select [On] for [TLS] in the [Security]. The default port number is 443.*¹ The setting will be changed after restarting the device or network. Value: [Off], [On], 1 to 32767 (Port Number)</p> <hr/> <p> NOTE If the setting is [On], a TLS certificate is required. The factory certificate is the certificate owned by the machine.</p> <hr/>
[AvailableNetwork]	<p>Set whether to enable this function for each network of Wi-Fi Direct, Wi-Fi and wired. Value: [Disable], [Enable]</p>

[HTTP]

Item	Description
[Off/On]	<p>Set whether to communicate using HTTP. The setting will be changed after restarting the device or network. Value: [Off], [On]</p>
[AvailableNetwork]	<p>Set whether to enable this function for each network of Wi-Fi Direct, Wi-Fi and wired. Value: [Disable], [Enable]</p>



[HTTPS]

Item	Description
[Off/On]	<p>Select whether to communicate using HTTPS.*¹ The setting will be changed after restarting the device or network. Value: [Off], [On]</p>
[AvailableNetwork]	<p>Set whether to enable this function for each network of Wi-Fi Direct, Wi-Fi and wired. Value: [Disable], [Enable]</p>

[LDAP]

Item	Description
[Off/On]	<p>Select whether to use LDAP. Value: [Off], [On]</p>

[ThinPrint]

Item	Settings
[Off/On]	<p>Set whether to use ThinPrint. To use, select [On] in these settings. The default port number is 4000.*¹</p> <p>The setting will be changed after restarting the device or network. Value: [Off], [On]</p> <hr/> <p> NOTE</p> <p>This feature does not appear if the optional ThinPrint Option is not running.</p>
[ThinPrintOverTLS]	<p>To use ThinPrint over TLS, select [On] for this setting, and for [TLS] in the [Security], select [On]. Value: [Off], [On]</p> <hr/> <p> NOTE</p> <p>If the setting is [On], a TLS certificate is required. The factory certificate is the certificate owned by the machine.</p>
[AvailableNetwork]	<p>Set whether to enable this function for each network of Wi-Fi Direct, Wi-Fi and wired. Value: [Disable], [Enable]</p>

[WSD-PRINT]

Item	Description
[Off/On]	<p>Set whether to use our proprietary web services. The setting will be changed after restarting the device or network. Value: [Off], [On]</p>
[AvailableNetwork]	<p>Set whether to enable this function for each network of Wi-Fi Direct, Wi-Fi and wired. Value: [Disable], [Enable]</p>



[Enhanced WSD]

Item	Description
[Off/On]	<p>Set whether to use our proprietary web services. The setting will be changed after restarting the device or network. Value: [Off], [On]</p>
[AvailableNetwork]	<p>Set whether to enable this function for each network of Wi-Fi Direct, Wi-Fi and wired. Value: [Disable], [Enable]</p>

[EnhancedWSD(TLS)]

Item	Description
[Off/On]	Set whether to use our proprietary Web service on TLS.*1 The setting will be changed after restarting the device or network. Value: [Off], [On]
[AvailableNetwork]	Set whether to enable this function for each network of Wi-Fi Direct, Wi-Fi and wired. Value: [Disable], [Enable]

[VNC(RFB)overTLS]

Item	Description
[Off/On]	Set when using a remote operation protected by TLS by starting up a VNC Viewer other than ours (example: Real VNC). The default port number is 9063.*1 The setting will be changed after restarting the device or network. Value: [Off], [On], 1 to 32767 (Port Number)  NOTE If the setting is [On], a TLS certificate is required. The factory certificate is the certificate owned by the machine.  Command Center RX User Guide
[AvailableNetwork]	Set whether to enable this function for each network of Wi-Fi Direct, Wi-Fi and wired. Value: [Disable], [Enable]

[VNC (RFB)]

Item	Description
[Off/On]	Set when using a remote operation by starting up a VNC Viewer other than ours (example: Real VNC). The default port number is 9062. The setting will be changed after restarting the device or network. Value: [Off], [On], 1 to 32767 (Port Number)
[AvailableNetwork]	Set whether to enable this function for each network of Wi-Fi Direct, Wi-Fi and wired. Value: [Disable], [Enable]

[Enhanced VNC over TLS]

Item	Description
[Off/On]	<p>Start Command Center RX and set for using TLS-protected remote operation. The default port number is 9061.*¹</p> <p>The setting will be changed after restarting the device or network.</p> <p>Value: [Off], [On], 1 to 32767 (Port Number)</p> <hr/> <p> NOTE</p> <ul style="list-style-type: none"> • The factory default setting is [On]. • If the setting is [On], a TLS certificate is required. The factory certificate is the certificate owned by the machine. <p>➔ Command Center RX User Guide</p> <hr/>
[AvailableNetwork]	<p>Set whether to enable this function for each network of Wi-Fi Direct, Wi-Fi and wired.</p> <p>Value: [Disable], [Enable]</p>

*1 In [Security] set [TLS Setting] to [On].

[➔ \[TLS Setting\] \(page 237\)](#)

 **IMPORTANT**

Depending on the protocol, it may be necessary to restart the network or turn the power off/on after changing the settings.

Primary Network

[Menu] key > [▲][▼] key > [Network] > [OK] key > [▲][▼] key > [Primary Network] > [OK] key

Item	Description
[Primary Network]	<p>Select the network interface to be used when connecting this machine as a client device.</p> <p>Value: [Wi-Fi], [Wired Network], [Optional Network]</p> <ul style="list-style-type: none">• [Wi-Fi] is displayed when the optional Wireless Network Interface Kit (IB-37/IB-38) is installed.• [Optional Network] is displayed when the optional Network Interface Kit (IB-50) or Wireless Interface Kit (IB-51) is installed.

Ping

[Menu] key > [▲][▼] key > [Network] > [OK] key > [▲][▼] key > [Ping] > [OK] key

Item	Description
[Ping]	<p>Check if you can communicate with the destination by entering the host name or IP address of the destination.</p> <hr/> <p> NOTE</p> <p>This function is not displayed when [Primary Network] is specified in [Optional Network].</p> <p>➔ Primary Network (page 219)</p>

Restart Network

[Menu] key > [▲][▼] key > [Network] > [OK] key > [▲][▼] key > [Restart Network] > [OK] key

Item	Description
[Restart Network]	Restarts the network.

Remote Serv.Set.

[Menu] key > [▲][▼] key > [Network] > [OK] key > [▲][▼] key > [Remote Serv.Set.] > [OK] key

When the trouble occurs on this product, it is possible to explain the operational procedure and the troubleshooting method through the internet from our sales office by accessing the operation panel screen of this product while operating the screen.

NOTE

When using the remote service settings, it is necessary to make a contract with our company. Please contact our sales office or our authorized dealer (purchase source) for the details.

Remote Operation

Configures remote operation settings.

[Menu] key > [▲][▼] key > [Network] > [OK] key > [▲][▼] key > [Remote Operation] > [OK] key

Item	Description
[Off/On]	Set whether to use Remote Operation. Value: [Off], [On]
[Use Restriction]	Set usage authority. Value [Off] : Users with no administrator privileges can perform remote operation. [Use Password] : Enter the password for remote operation. [Admin. Only] : Only administrators can perform remote operations.  NOTE <ul style="list-style-type: none"> • This setting is available when [Off/On] is [On]. • If you selected [Admin. Only], remote operation from VNC software is not possible.
[VNC Comp. Soft]	Display whether VNC compatible software can be used.

Optional Network

[Menu] key > [▲][▼] key > [Optional Network] > [OK] key

Configure settings for the optional Network Interface Kit.

NOTE

This Menu is displayed when the optional Network Interface Kit or Wireless Network Interface Kit is installed.

Wireless Network

[Optional Network] key > [▲][▼] key > [Wireless Network] > [OK] key

Configure settings for the optional Wireless Network Interface Kit.

NOTE

This function will be displayed when the optional Wireless Network Interface Kit (IB-51) is installed.

[ConnectionStatus]

If you have the optional Wireless Network Interface Kit installed, you can check the status of your wireless LAN.





[Quick Setup]

Item	Description
[AvailableNetwork]	Displays access points to which the machine can connect.
[Push Button]	<p>If the access point supports the push button method, wireless settings can be configured using the push button. This setting executes push button, and the connection is started by pressing the push button on the access point.</p> <hr/> <p> NOTE</p> <p>The push button method supports only the WPS.</p> <hr/>
[PIN (Device)]	Starts connection using the machine's PIN code. Enter the PIN code into the access point. The PIN code of the machine is automatically generated.
[PIN (Terminal)]	Starts connection using the access point's PIN code. Enter the PIN code of the access point.

[Custom Setup]

The detailed settings for wireless LAN can be changed.

Select [Connected] to check the wireless network connection.

Item	Description
[Netwk Name(SSID)]	<p>Set the SSID (Service Set Identifier) of the wireless LAN to which the machine connects.</p> <hr/> <p> NOTE</p> <p>Up to 32 characters can be entered.</p> <hr/>
[Connection Mode]	<p>Set Connection Mode. Value: [Ad Hoc], [Infrastructure]</p> <hr/> <p> NOTE</p> <p>[Ad Hoc] Communicates directly with the device without going through the access point. It cannot be connected to more than one device.</p> <p>[Infrastructure] Communicates via the access point.</p> <hr/>
[Channel]	<p>Performs channel configuration. Use [][] or the numeric keys to set the value. Value: 1 to 11</p>
[Netwk Authentic.]	<p>Select network authentication type. If you want to select another authentication method, access the web page from your computer and set it. Value: [Open], [Shared], [WPA-PSK]^{*1}, [WPA2-PSK]^{*1} ^{*1} Not displayed when [Ad Hoc] is specified in [Connection Mode].</p>
[Encryption]	<p>Select encryption method. If you selected a setting other than [Disable], enter the WEP key or preshared key. The setting values vary depending on the Network Authentication setting. Select [Data Encryption].</p> <ul style="list-style-type: none"> • If the network authentication type is [Open] or [Shared] Value: [Disable], [WEP] • If the network authentication type is [WPA-PSK] or [WPA2-PSK] Value: [TKIP]^{*2}, [AES], [Auto]^{*2}, [Preshared Key] ^{*2} Not displayed when [WPA2-PSK] is specified in [Netwk Authentic.]. <hr/> <p> NOTE</p> <ul style="list-style-type: none"> • If you selected [WEP], enter the WEP key. Up to 26 characters can be entered. • If you selected [TKIP], [AES], or [Auto], enter the pre-shared key. 8 to 64 characters can be entered. <hr/>

Basic

[Menu] key > [▲][▼] key > [Optional Network] > [OK] key > [▲][▼] key > [Basic] > [OK] key

NOTE

This function will be displayed when the optional Network Interface Kit (IB-50/IB-51) is installed.

Item	Description
[TCP/IP Settings]	For the setting values, refer to the following: ➔ [TCP/IP Settings][TCP/IP Settings] (page 205) ➔ Bonjour (page 212)
[NetWare]	Receives documents using NetWare. ➔ Network Interface Kit Operation Guide Value: [Off], [On]
[AppleTalk]	Set whether to receive documents using the AppleTalk. The setting will be changed after restarting the device or the machine's network. Value: [Off], [On]
[IPSec]	For the setting values, refer to the following: ➔ Off/On (page 212)
[LAN Interface]	Select the LAN interface. The setting will be changed after restarting the device or the machine's network. Value: [Auto], [10BASE-Half], [10BASE-Full], [100BASE-Half], [100BASE-Full], [1000BASE-T] <hr/>  NOTE This function will be displayed when the optional Network Interface Kit is installed.
[MACAddressFilter]	Set whether to use MAC Address Filter. ➔ Network Interface Kit Operation Guide Value: [Off], [On]

Restart Network

Item	Description
[Restart Network]	Restarts the network.

Device Common

Configure overall machine operation.

Language

[Menu] key > [▲][▼] key > [Device Common] > [OK] key > [▲][▼] key > [Language] > [OK] key

Item	Description
[Language]	Set the language to use for the LCD panel display.



Def. Screen(Box)

[Menu] key > [▲][▼] key > [Device Common] > [OK] key > [▲][▼] key > [Def. Screen(Box)] > [OK] key

Item	Description
[Def. Screen(Box)]	Set the screen displayed when you select the [Document Box] key. Value: [Custom Box], [Job Box]

Date Setting

[Menu] key > [▲][▼] key > [Device Common] > [OK] key > [▲][▼] key > [Date Setting] > [OK] key

Item	Description
[Date]	<p>Set the date for the location where you use the machine. Value: [Year] (2000?2035), [Month] (1 to 12), [Day] (1 to 31)</p> <p>➔ Setting Date and Time (page 44)</p> <hr/> <p> NOTE</p> <p>If you change the date while using the trial version of an option or application, you will no longer be able to use the option or application.</p> <hr/>
[Time]	<p>Set the time for the location where you use the machine. Value: [Hour] (0?23), [min.] (0 to 59), [sec.] (0 to 59)</p> <p>➔ Setting Date and Time (page 44)</p> <hr/> <p> NOTE</p> <p>If you change the time while using the trial version of an option or application, you will no longer be able to use the option or application.</p> <hr/>
[Date Format]	<p>Select the display format of year, month, and date. The year is displayed in Western notation.</p> <p>Value: [Month/Day/Year], [Day/Month/Year], [Year/Month/Day]</p>

Item	Description
[Time Zone]	Set the time difference from GMT. Choose the nearest listed location from the list. ➔ Setting Date and Time (page 44)
[Summer Time]	If you select a region that utilizes summer time, configure settings for summer time. ➔ Setting Date and Time (page 44)

Buzzer

[Menu] key > [▲][▼] key > [Device Common] > [OK] key > [▲][▼] key > [Buzzer] > [OK] key

Set options for buzzer sound during the machine operations.

Item	Description
[Key Conf. Buzzer]	Emit a sound when the operation panel keys are selected. Value: [Off], [On]
[Job Finish]	Emit a sound when a print job is normally completed. Value: [Off], [On]
[Ready Buzzer]	Emit a sound when the warm-up is completed. Value: [Off], [On]
[Warning]	Emit a sound when errors occur. Value: [Off], [On]
[Keyboard Confirm]	Emit a sound to confirm key presses with a sound. Value: [Off], [On]

RAM Disk Setting

[Menu] key > [▲][▼] key > [Device Common] > [OK] key > [▲][▼] key > [RAM Disk Setting] > [OK] key



NOTE

Displayed when the optional SSD is installed.

Create a RAM disk and set its capacity.

You can print print data from the job box by creating a RAM disk.

Value

[RAM Disk Mode]:[Off], [On]

[RAM Disk Size]: Setting range varies depending on size of onboard memory and optional memory usage.



IMPORTANT

After changing the setting, restart the system or turn the machine OFF and then ON.

Format SSD

[Menu] key > [▲][▼] key > [Device Common]> [OK] key > [▲][▼] key > [Format SSD] > [OK] key

Format the SSD.

Formatting an SSD is necessary when first installing an optional SSD to the machine.

IMPORTANT

Formatting an SSD will erase all of its data.

NOTE

This setting will not be displayed when the optional security kit is installed.

Format SD Card

[Menu] key > [▲][▼] key > [Device Common]> [OK] key > [▲][▼] key > [Format SD Card] > [OK] key

Format the SSD.

To use an SD memory card, you must first use the machine to format the SD memory card.

IMPORTANT

- Formatting an SD card will erase all of its data.
 - If installing an application, the application may be deleted so do not format the SD card.
-

Display Bright.

[Menu] key > [▲][▼] key > [Device Common] > [OK] key > [▲][▼] key > [Display Bright.] > [OK] key

Set the brightness of the LCD panel.

Value: Darker -2, Darker -1, Normal 0, Lighter +1, Lighter +2

Error Handling

[Menu] key > [▲][▼] key > [Device Common] > [OK] key > [▲][▼] key > [Error Handling] > [OK] key

Select whether to cancel or continue the job when error has occurred.

Item	Description
[DuplexPaperError]	Set what to do when duplex printing is not possible for the selected paper sizes and media types. Value [1-sided]: Printed in 1-sided. [Display Error]: Message to cancel printing is displayed.
[Paper Mismatch]	Set what to do when the selected paper size or type does not match paper size or type loaded in the specified paper source while printing from the computer by specifying the cassette or multipurpose tray. Value [Continue]: The setting is ignored and the job is printed. [Display Error]: Message to cancel printing is displayed.
[WrongSize Loaded]	Set what to do when it is detected that the multipurpose tray paper size setting does not match the actual paper size that is fed. Value [Ignore]: The setting is ignored and the job is printed. [Display Error]: Message to cancel printing is displayed.
[MP Tray Empty]	Set whether to display the no paper message or not when printing with the paper source fixed to the multipurpose tray and no paper in the multipurpose tray. Value: [Off], [On]

ColorToner Empty

[Menu] key > [▲][▼] key > [Device Common] > [OK] key > [▲][▼] key > [ColorToner Empty] > [OK] key

Select whether printing is prohibited or the Print in Black and White setting is used for printing once the color toner runs out.

Value: [Stop Printing], [Print in B & W]



NOTE

This setting is not valid when the optional Fiery Controller is installed.

Timer Setting

[Menu] key > [▲] [▼] key > [Device Common] > [OK] key > [▲] [▼] key > [Timer Setting] > [OK] key

[Auto Panel Reset]

If no jobs are run for a certain period of time, automatically reset settings and return to the default setting. Select to use Auto Panel Reset or not.

Value: [Off], [On]



NOTE

For setting the time until the panel is automatically reset, refer to the following:

→ [PanelReset Timer \(page 229\)](#)

[PanelReset Timer]

If you select On for Auto Panel Reset, you can set the amount of time to wait before Auto Panel Reset.

Value: 5 to 495 seconds (in 5 second increments)



NOTE

This function is displayed when [Auto Panel Reset] is set to [On].

[Sleep Level Set.]

Select the sleep level.

This function will not be displayed when the optional Network Interface Kit or Fiery controller is installed.

Item	Description
[Status]	<p>Select whether to use Energy Saver for the following functions individually:</p> <ul style="list-style-type: none"> ID Card Reader Displayed when the optional Card Authentication Kit is activated. Application Startup <p>Value: [On], [On]</p> <hr/> <p> NOTE</p> <p>When the machine has entered sleep mode with Energy Saver setting, the ID card cannot be recognized.</p>

[Sleep Timer]

Set amount of time before entering Sleep.

Value: 1 to 120 minutes (1 minute increments)

→ [Sleep \(page 57\)](#)

[Power Off Rule]

Select whether or not the machine enters Power Off mode for the following function.

Select [On] to set the Power Off mode.

- Network
- USB Cable
- USB Host
- NIC

(Displayed when the optional Network Interface Kit is installed.)

Value: [Off], [On]

Even when any of the functions is set to [On], if [NIC] is set to [Off] the machine does not enter Power Off Mode.

Even when [Network] or [USB Cable] is set to [Off], if the machine does not communicate with the other devices, the machine will enter Power Off Mode.

[Power Off Timer]

Select whether to turn off the power automatically after a period of inactivity.

Value: [1 hour], [2 hours], [3 hours], [4 hours], [5 hours], [6 hours], [9 hours], [12 hours], [1 day], [2 days], [3 days], [4 days], [5 days], [6 days], [1 week]

[WeeklyTimer Set.]

Configure settings for switching the machine into Sleep mode and waking it automatically at a specified time for each day of the week.

Item	Description
[Weekly Timer]	Select whether to use Weekly Timer. Value: [Off], [On]
[Schedule]	Specify the time for each day of the week at which the machine enters Sleep mode and recovers.
[Retry Settings]	Set the number of retry to switch the machine into Sleep mode. Value: [On], [Off]  NOTE <ul style="list-style-type: none"> • If [On] is selected, set the number of retries. The setting range is 0 to 10. • If [Off] is selected, retry is performed until the machine enters Sleep mode.
[Retry Interval]	Set the retry interval. Use [▲][▼] to enter a number. Value: 10 to 60 seconds (in 10 second increments)

[Auto Err. Clear]

If an error occurs during processing, processing stops to wait for the next step to be taken by the user. In the Auto Error Clear mode, automatically clear the error after a set amount of time elapses.

Value: [On], [Off]

[Err. Clear Timer]

If you selected Auto Error Clear, set the amount of time to wait before automatically resuming printing.

Value: 5 to 495 seconds (in 5 second increments)



NOTE

This function is displayed when [Auto Err. Clear] is set to [On].

[FormFeed TimeOut]

Receiving print data from the computer, the machine may sometimes wait if there is no information signaling that the last page does not have any more data to be printed. When the preset timeout passes, the machine automatically prints paper. The options are between 5 and 495 seconds.

Value: 5 to 495 seconds (in 5 second increments)

[Ping Timeout]

Set the time until timeout occurs when [Ping] is executed in "Network Setting".

Value: 1 to 30 seconds (in 1 second increments)

Disp. Status/Log

[Menu] key > [▲][▼] key > [Device Common] > [OK] key > [▲][▼] key > [Disp. Status/Log] > [OK] key

[Disp. Status/Log]

Set the display of Job Status/Job History.

Item	Description
[JobsDetailStatus]	Value: [Show All], [My Jobs Only], [Hide All]
[Job Log]	Value: [Show All], [My Jobs Only], [Hide All]

Keyboard Type

[Menu] key > [▲][▼] key > [Device Common] > [OK] key > [▲][▼] key > [Keyboard Type] > [OK] key

Item	Description
[Keyboard]	Select the keyboard type. Value: [US], [Europe US], [France], [Germany], [UK-English]

Bluetooth Set.

[Menu] key > [▲][▼] key > [Device Common] > [OK] key > [▲][▼] key > [Bluetooth Set.] > [OK] key

[Bluetooth Set.]

Item	Description
[Off/On]	Bluetooth keyboard is used. Value: [Off], [On]
[Search Device]	Select a keyboard.

Low Toner Alert

[Menu] key > [▲][▼] key > [Device Common] > [OK] key > [▲][▼] key > [Low Toner Alert] > [OK] key

Item	Description
[Notify via Panel]	Set whether to display the alert on the operation panel when the toner is low. Value: [Off], [On]

Item	Description
[NotifyExternally]	<p>Set the amount of remaining toner to notify the administrator when to order a toner when the toner is running low. This notification is used for Event Reports, Status Monitors, and SNMPTraps (such as Printing Equipment Management Systems).</p> <p>Value: [Off], [On]</p> <hr/> <p> NOTE</p> <p>If [On] is selected, set the amount of remaining toner to alert. The setting range is 5 to 100% (in 1% increments).</p> <hr/>

Msg Banner Print

[Menu] key > [▲] [▼] key > [Device Common] > [OK] key > [▲] [▼] key > [Msg Banner Print] > [OK] key

Set whether the confirmation screen appears before each sheet is printed when printing banner sheet.

Value: [Off], [On]

Remote Printing

[Menu] key > [▲] [▼] key > [Device Common] > [OK] key > [▲] [▼] key > [Remote Printing] > [OK] key

Select whether to prohibit printing that is performed without operating the machine.

When [Not Allowed] is selected, a document that has been stored in the document box from the printer driver can be printed from the machine. This prevents another person from seeing that document.

Value: [Permit] , [Not Allowed],

Direct PRN (Web)

[Menu] key > [▲] [▼] key > [Device Common] > [OK] key > [▲] [▼] key > [Direct PRN (Web)] > [OK] key

Set whether to allow Direct Printing from Command Center RX.

Value: [Not Allowed], [Permit]

➔ **Command Center RX User Guide**

MaintenanceAlert

[Menu] key > [▲][▼] key > [Device Common] > [OK] key > [▲][▼] key > [MaintenanceAlert] > [OK] key

Item	Description
[Notify via Panel]	Set whether or not to display on the operation panel when a periodic inspection is near. Value: [Off], [Display Status]
[NotifyExternally]	Set the timing at which the administrator will be notified of the period remaining before the upcoming scheduled inspection when it is near. This notification is used for Event Reports, Status Monitors, and SNMPTraps (such as Printing Equipment Management Systems). Value [Off/On]:[Off], [On] <hr/> <div style="display: flex; align-items: flex-start;">  <div style="margin-top: 5px;"> <p>NOTE</p> <p>If [On] is selected, set the alert timing. The setting range is 5 to 100% (in 1% increments).</p> </div> </div> <hr/>

Security

Configures security settings.

Network Security

[Menu] key > [▲][▼] key > [Security] > [OK] key > [▲][▼] key > [Network Security] > [OK] key

[SecurityQuickSet]

Item	Description
[SecurityQuickSet]	<p>Select security settings from levels 1 to 3 that are close to your environment, and change (customize) the functions as needed.</p> <p>Value</p> <p>[Level 1] The factory default setting.</p> <p>[Level 2] The security function of the network will change.</p> <p>[Level 3] All functions that protect the machine are enabled, and functions that do not protect the machine are disabled.</p> <hr/> <p> NOTE</p> <ul style="list-style-type: none"> This function can be set only when logged in with administrator privileges. <ul style="list-style-type: none"> ➔ Log in as Machine Administrator or Administrator (page 75) Restart the device or network after selecting a level for the settings to take effect. <ul style="list-style-type: none"> ➔ Restart (page 246) ➔ Restart Network (page 224) For more information on each security level setting, refer to the following: <ul style="list-style-type: none"> ➔ Security Quick Setup Function List (page 402)

Configuring Security Quick Setup

1 Display the screen.

- 1 [Menu] key > [▲][▼] key > [Security] > [OK] key > [▲][▼] key > [Netwk Security] > [OK] key > [SecurityQuickSet] > [OK] key



NOTE

If the user authentication screen appears, log in with a user who has the privilege to configure this setting. If you do not know your login user name or password, please contact your administrator.

2 Select the security level according to the usage environment.

3 Configure the security function as necessary.



NOTE

Refer to the following for the settings of each security level.

→ [Security Quick Setup Function List \(page 402\)](#)

4 Restart the device or network.

→ [Restart \(page 246\)](#)

→ [Restart Network \(page 224\)](#)

[TLS Setting]

Item	Description
[TLS]	Set whether to use TLS for communication. Value: [Off], [On]

I/F Block Set.

[Menu] key > [▲] [▼] key > [Security] > [OK] key > [▲] [▼] key > [I/F Block Set.] > [OK] key

Item	Description
[USB Host]	Block and protect the USB port and USB port (USB Host). Value: [Unblock], [Block]
[USB Device]	Block and protect the USB interface connector (USB Device). Value: [Unblock], [Block]
[Option I/F]	Block and protect the Option Interface. Value: Unblock, Block
[USB Drive]	Block and protect the USB memory slot. Value: [Unblock], [Block] <hr/>  NOTE This function can be configured when the USB host is set to [Unblock]. <hr/>

IMPORTANT

After changing the setting, restart the system or turn the machine OFF and then ON.

Security Level

[Menu] key > [▲] [▼] key > [Security] > [OK] key > [▲] [▼] key > [Security Level] > [OK] key

Item	Description
[Security Level]	<p>Specify the security level. Value</p> <p>[High] This is the security setting we recommend. Normally use this setting.</p> <p>[Low] Used during maintenance. Do not use normally.</p> <p>[Very High] In addition to the [High] state, disables changing of machine settings with external commands.</p> <hr/> <p> NOTE This function can be set only when logging in with the authority of the device administrator.</p> <p>➔ Log in as Machine Administrator or Administrator (page 75)</p>

Data Security

[Menu] key > [▲][▼] key > [Security] > [OK] key > [▲][▼] key > [Data Security] > [OK] key



Configure settings related to data stored in SSD or memory.

[SSD Initializ.]

Change the security feature settings.

NOTE

- This feature appears when an optional SSD is installed and the optional security kit is running.
- To change security feature settings, you must enter a security password. The factory default value is 000000.

Item	Description
[Security Passwd]	<p>Customize the security password so that only the administrator can use the Data Encryption/Overwrite.</p> <p>Enter a new security password 6 to 16 alphanumeric characters and symbols.</p> <p>Enter the password again for confirmation.</p> <hr/> <p> IMPORTANT</p> <p>Avoid any easy-to-guess numbers for the security password (e.g. 11111111 or 12345678).</p>
[Initialization]	<p>You can completely erase the contents of the SSD. Do so when you want to stop using the machine.</p> <hr/> <p> IMPORTANT</p> <p>If the power switch is turned off during initialization, the SSD may be damaged and the initialization may not complete.</p> <hr/> <p> NOTE</p> <p>If you accidentally turn the power switch off during initialization, turn the power switch on again. Initialization automatically restarts.</p>

[DataSanitization]

This function returns the following information stored in the machine to the factory default.

- System Settings
- Data in the Custom Box
- Optional applications

**CAUTION**

Job box data saved in applications or SD cards cannot be deleted. If you want to erase this, you need to format the SD card.

**NOTE**

- Print [DataSanitization] and check that security data has definitely been erased.
→ [Report \(page 185\)](#)
- You cannot cancel a process in the middle.
- Disconnect any modular or network cables before performing this operation.
- Before executing this function, set all [I/F Block Set.] to [Unblock].
→ [I/F Block Set. \(page 238\)](#)
- Do not turn off the power during data sanitization. If the power is turned off during erasing, erasing will be performed automatically after the power is turned on, but complete operation cannot be guaranteed.

Item	Settings
[Run Immediately]	Execute security data sanitization.
[Schedule]	The address information and image data in the machine will be completely erased at the specified time. Value: [On], [Off] If you select [On], set the date and time for complete erasure. Value: Year (2000 to 2035), Month (1 to 12), Day (1 to 31), and Hour (0 to 23).
[Device Use]	After data sanitization, the usage of this machine will be restricted. If [Prohibit] is selected, machine operation is disabled. Value: [Permit], [Prohibit]

[SW Verification]

Verify the software in the machine.

Select [Start] to run the verification. If you experience any abnormalities in software verification, contact your service representative.

Manual FW Update

[Menu] key > [▲][▼] key > [Security] > [OK] key > [▲][▼] key > [Manual FW Update] > [OK] key

Item	Description
[Manual FW Update]	Set whether to allow manual firmware updates. Value: [Not Allowed], [Permit]

Allowlisting

[Menu] key > [▲][▼] key > [Security] > [OK] key > [▲][▼] key > [Allowlisting] > [OK] key

Item	Description
[Allowlisting]	<p>In case if the unauthorized program or the program that has tampered are installed, the stored data or the contents of the communication in this program might be stolen. Once this function is activated, execution of the unauthorized software or the tampering of the software can be prevented, and possible to maintain the reliability of the system. Value: [Off], [On]</p> <hr/> <p> NOTE</p> <ul style="list-style-type: none"> • After setting it to [On], you need to shutdown and restart the machine. • Enabling this feature slows the machine start-up. • If malware is detected, an event report can be used as a way to understand its content. The Event reports can be enable by the Command Center RX > "Management Settings: Notification/Report" > [Recipient 1 E-mail Address] to [Recipient 3 E-mail Address] and [Notify when Malicious Program is Detected] is set to [On].

User/Job Account

[Menu] key > [▲][▼] key > [User/Job Account] > [OK] key

Configures settings related to machine management.

➔ [Overview of User Login Administration \(page 248\)](#)

➔ [Overview of Job Accounting \(page 264\)](#)

➔ [Unknown User Settings \(page 278\)](#)

Application

[Menu] key > [▲][▼] key > [Application] > [OK] key

Configure the application settings.

➔ [Starting Application Use \(page 380\)](#)

➔ [Overview of the Applications \(page 380\)](#)

Adjust/Maint.

Adjust printing quality and conduct machine maintenance.

[Menu] key > [▲][▼] key > [Adjust/Maint.] > [OK] key

[Silent Mode]

Value	Description
[Silent Mode]	Set the quiet mode. Set this when the operating noise is disturbing. Value: [Off], [On]
[Each Job]	You can set the quiet mode for each job. Here, set whether to allow the setting for each job. Value: [Permit], [Prohibit]

[Color Regist.]

When first installing the machine or moving it to a new location, color drift during printing may occur. Use this function to correct the color position of each of cyan, magenta and yellow to resolve color drift.

➔ [Color Registration Procedure \(page 357\)](#)

[Image Adjustment]

You can select the one you need from drum refresh, development refresh, laser scan cleaning, and color adjustment and execute it continuously.

[Drum]

Remove image blur and white dots from the printout. It takes about 1 minute and 20 seconds. The time required may vary depending on the usage environment.

[DeveloperRefresh]

Adjust the printed image that is too light or incomplete, even though there is enough toner.

[LSU]

Remove vertical white lines from the printout.

[ColorCalibration]

Calibrate the device to ensure correct toner overlapping and consistency with the original tone.

➔ [Color Adjustment \(page 357\)](#)



NOTE

- Drum refresh cannot be performed while printing. Execute drum refresh after the printing is done.
- Waiting time may be longer when the toner is refilled during developer refresh.
- When the correct toner overlapping is not ensured even after performing this color adjustment, refer to the following:

➔ [Color Registration Procedure \(page 357\)](#)

[Restart]

You can restart the device without turning the power switch off. Execute this when the operation of this machine is unstable (similar to restarting the computer).

[Service Setting]

Perform the maintenance and inspection of the machine. This menu is primarily used by service personnel for maintenance work.

[Op Functions]

[Menu] key > [▲][▼] key > [Op Functions] > [OK] key

You can use the optional applications installed on this machine.

➔ [Overview of the Applications \(page 380\)](#)

[Device Info.]

[Menu] key > [▲][▼] key > [Device Info.] > [OK] key

Item	Description
[Software]	Check the version of the system and engine software of this machine.
[Option]	You check the options installed on this machine.

9 User Authentication and Accounting (User Login, Job Accounting)

Overview of User Login Administration

User login administration specifies how the user access is administered on this machine. Enter a correct login user name and password for user authentication to login.

- 1 Enable User Login Administration
 - ➔ [Enable User Login Administration \(page 249\)](#)
- 2 Set the user
 - ➔ [Setting User Login Administration \(page 250\)](#)
- 3 Enter the login user name and password and execute the job
 - ➔ [Login \(page 42\)](#)

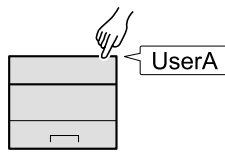

Managing the Job Account from PC

In addition to the above settings, the following are necessary to manage the job account from PC.

To Manage the Users to Print from PCs

Printer driver settings are necessary to manage the users that print on the machine from PCs.

- ➔ [Managing the Users that Print on This Machine from a PC \(page 256\)](#)

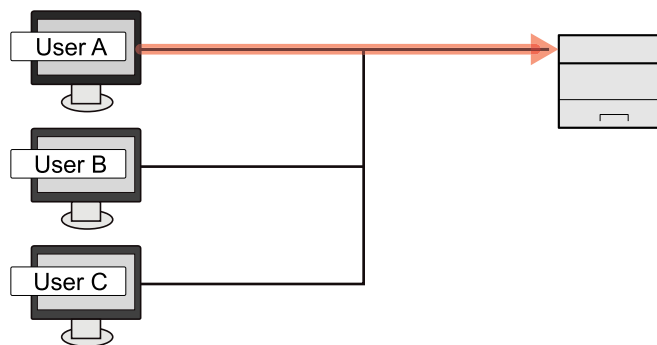

Enable User Login Administration

This enables user login administration.

1 Display the screen.

- 1 [Menu] key > [▲][▼] key > [User/Job Account] > [OK] key



NOTE

If the user authentication screen appears, log in with a user who has the privilege to configure this setting. If you do not know your login user name or password, please contact your administrator.

- 2 [▲][▼] key > [User Login Set.] > [OK] key

2 Configure the settings.

- Select [Off] to disable user login administration.
- If [Netwk Authentic.] is selected, set [Netwk Auth. Set.].
→ [Server Settings \(page 257\)](#)



NOTE

If you cannot login because of the setting of the machine, login with any administrator registered in the local user list and correct the settings.

Setting User Login Administration

This registers, alters and deletes users and configures the settings for User Login Administration.

Authentication Security

If user authentication is enabled, configure the user authentication settings.

User Account Lockout Setting

You can prohibit the use of a user account if an incorrect password is entered repeatedly to login with that account.

1 Display the screen.

- 1 [Menu] key > [▲][▼] key > [User/Job Account] > [OK] key



NOTE

If the user authentication screen appears, log in with a user who has the privilege to configure this setting. If you do not know your login user name or password, please contact your administrator.

- 2 [▲][▼] key > [User Login Set.] > [OK] key > [▲][▼] key > [Account Lockout] > [OK] key

2 Configure the settings.

Configurable items are as follows:

[Lockout]

Select whether or not account lockout policy is enabled.

Value: [Off], [On]

[Lockout Policy]

Specify the conditions and the extent to which the account lockout is applied.

Value

[Number of Retries until Locked]: Specify how many login retries are allowed until the account is locked out. (1 to 10 times)

[Lockout Duration]: Specify how long the account is to be locked out until it is unlocked. (1 to 60 minutes)

[Lockout Target]: Specify the extent to which the account lockout is applied. You can select from [All] or [Remote Login Only]. Remote Login Only locks out all operations from outside the operation panel.

[Locked out Users List]

Displays a list of locked out users. You can unlock a user by selecting the user in the list, and selecting [Unlock].



NOTE

This function is displayed when account lockout policy is enabled.

Password Policy Settings

You can prohibit the setting and use of passwords that do not comply with the password policy. Setting the Password Policy makes it more difficult to break the password.

1 Display the screen.

- 1 [Menu] key > [▲][▼] key > [User/Job Account] > [OK] key



NOTE

If the user authentication screen appears, log in with a user who has the privilege to configure this setting. If you do not know your login user name or password, please contact your administrator.

- 2 [▲][▼] key > [User Login Set.] > [OK] key > [▲][▼] key > [Password Policy] > [OK] key

2 Configure the settings.

Configurable items are as follows:

[Password Policy]

Select whether or not password policy is enabled.

Value: [Off], [On]

[Minimum Password Length]

Set the minimum password length of characters for password.

Value: [Off], [On] (1 to 64 characters)

[Password Complexity]

Set the password complexity.

Value

[Reject common passwords]: [Off], [On]

[At least one uppercase letter (A-Z)]: [Off], [On]

[At least one lowercase letter (A-Z)]: [Off], [On]

[At least one number]: [Off], [On]

[At least one symbol]: [Off], [On]

[Maximum Password Age]

Set the maximum password age.

Value: [Off], [On] (1 to 180 days)

[Policy Violated User List]

List of users who do not meet password policy requirements.

Adding a User (Local User List)

You can add 1 user (including the default login user name).

1 Display the screen.

- 1 [Menu] key > [▲][▼] key > [User/Job Account] > [OK] key > [▲][▼] key > [User Login Set.] > [OK] key



NOTE

If the user authentication screen appears, log in with a user who has the privilege to configure this setting. If you do not know your login user name or password, please contact your administrator.

- 2 [▲][▼] key > [Local User List] > [OK] key

2 Register the user.

- 1 [Menu] key > [Add User] > [OK] key

[Login User Name]

Enter the login user name to login (up to 64 characters). The same login user name cannot be registered.

- 2 Select the [OK] key.

The User Name is "Power User".

3 Enter the user information.

- [▲][▼] key > [Detail]

[Login Password]

Enter the password to login (up to 64 characters).

[Access Level]

User access privileges are [User].

[Permit SysAdmin]

Select the privileges that can be set from the following.

- User/Job Account Information
- Basic Network Settings
- Advanced Device/Network

4 Select the [OK] key.

The user information is configured.

Changing User Properties for Local Users (Admin, DeviceAdmin, PowerUser)

Types of user properties that could be changed may be different depending on user access privilege.

 **NOTE**

To change the user information of the machine administrator, you must log in with machine administrator authority. You can only view user information if you log in as a regular user.

If the user authentication screen appears, log in with a user who has the privilege to configure this setting. If you do not know your login user name or password, please contact your administrator.

1 Display the screen.

- 1 [Menu] key > [▲][▼] key > [User/Job Account] > [OK] key > [▲][▼] key > [User Login Set.] > [OK] key > [▲][▼] key > [Local User List] > [OK] key

 **NOTE**

If the user authentication screen appears, log in with a user who has the privilege to configure this setting. If you do not know your login user name or password, please contact your administrator.

2 Change the user properties.

- 1 Select for the user whose properties you wish to change.

[Menu] key > [▲][▼] key > [Detail/Edit] > [OK] key

- 2 Configure the settings.

[User Name], [Account ID], and [Access Level] cannot be changed.

- [Login User Name]*1
- [Login Password]
- [Permit SysAdmin]*1

*1 You can change only when you log in with machine administrator authority.

- 3 Select the [OK] key.

The user information is changed.

Changing User Properties for Network Users

Edit the network user properties that were registered with settings concerning the granting of local user rights.

→ [Configure Network User Rights \(page 259\)](#)

NOTE

To change the user information of the machine administrator, you must log in with machine administrator authority. You can only view user information if you log in as a regular user.

If the user authentication screen appears, log in with a user who has the privilege to configure this setting. If you do not know your login user name or password, please contact your administrator.

1 Display the screen.

- 1 [Menu] key > [▲][▼] key > [User/Job Account] > [OK] key > [▲][▼] key > [User Login Set.] > [OK] key > [▲][▼] key > [Local User List] > [OK] key

NOTE

If the user authentication screen appears, log in with a user who has the privilege to configure this setting. If you do not know your login user name or password, please contact your administrator.

2 Change the user properties.

- 1 Select the user whose properties you wish to change.

[Menu] key > [▲][▼] key > [Detail/Edit] > [OK] key

- 2 Configure the settings.

[User Name], [Login User Name] cannot be changed.

- [Account ID]*¹

Set the Account ID registered in Job Accounting Setting.

- [Access Level]*¹

- [Permit SysAdmin]

- [ID Card Info.]

This cannot be set.

- [Local Authorization]

[Print Restriction: Printer]

Select whether or not use of the print function of the printer is prohibited. Applicable print functions are as follows:

- Print from Box
- Print from USB Drive
- Print Report
- Print from PC

[Print Restriction: Printer (Full Color)]

Select whether or not use of the print function (color) of the printer is prohibited. Applicable print functions are as follows:

- Print from Box
- Print from USB Drive
- Print Report
- Print from PC

[Duplex Restrict.]

Select whether only duplex printing is allowed.

[EcoPrint Restr.]

Specify whether only EcoPrint is allowed.

[Storing in Box]

Select whether or not to reject usage of storing in the document boxes.

Displayed when the optional SSD is installed.

- [Last updated]

This cannot be changed.

*1 You can change only when you log in with machine administrator authority.

- 3 Select the [OK] key.

The user information is changed.

Deleting a User

1 Display the screen.

- 1 [Menu] key > [▲][▼] key > [User/Job Account] > [OK] key > [▲][▼] key > [User Login Set.] > [OK] key > [▲][▼] key > [Local User List] > [OK] key



NOTE

If the user authentication screen appears, log in with a user who has the privilege to configure this setting. If you do not know your login user name or password, please contact your administrator.

2 Deleting a user.

- 1 Select the user to delete.

[Menu] key > [▲][▼] key > [Delete] > [OK] key

- 2 [Delete] > [Delete]

The selected user will be deleted.



NOTE

The default user with machine administrator rights cannot be deleted.

➔ [Administrator Privileges Overview \(page 75\)](#)

Managing the Users that Print on This Machine from a PC

To manage the users that print on this machine from a PC, the following settings are necessary in the printer driver. Instructions are based on interface elements as they appear in Windows 10.

1 Display the screen.

- 1 Select the Windows [Start] button → [Windows System Tool] → [Control Panel] → [Devices and Printers].



NOTE

- For Windows 11, select the [Start] button → [All apps] → [Windows Tools] → [Control Panel] → [Devices and Printers].
- For Windows 8.1, select [Settings] in the Charms Bar on Desktop → [Control Panel] → [Devices and Printers].

- 2 Right-click the printer driver icon of the machine, and click the [Printer properties] menu of the printer driver.
- 3 Click [Administrator] on the [Device Settings] tab.

2 Configure the settings.

- 1 Select [User Login] on the [User Login] tab.

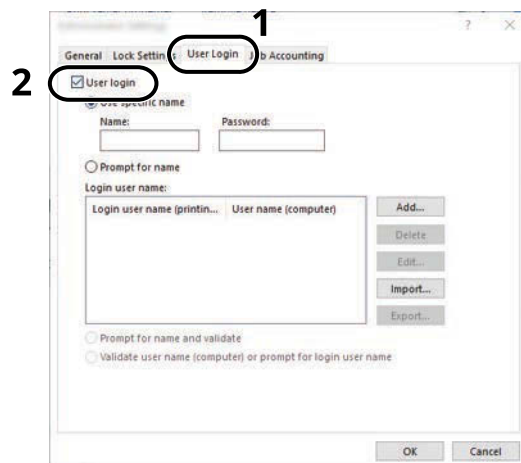

- 2 Set the User Login Administration.

[Use Specific Login User Name]

This option can be used to specify a user name and password to use the same User login for every print job. If this option is selected, the user does not have to type the name and password for each print job.

[Prompt for name]

A screen for entering the user name and password will be displayed when attempting a printing. The user name and password must be entered each time a printing is attempted.

[Prompt for name and validate]

A screen for entering the user name and password will be displayed when attempting a printing. The user name and password stored in the "Login user names list" needs to be entered. The user name and password must be entered each time a printing is attempted.

[Validate user name (computer) or prompt for login user name]

When printing, the Windows user name is searched in the "Login user names" and printing is possible if the name is registered. If the name is not registered, the printing will be canceled for users with only user authority. If the user has administrator privileges, the screen to enter the user name and password will appear.

- 3 Click [OK].

**NOTE**

For other settings of job accounting, refer to the following:

- ➔ **Printer Driver User Guide**
-

Server Settings

Set the server type when network authentication is enabled.

1 Display the screen.

- 1 [Menu] key > [▲][▼] key > [User/Job Account] > [OK] key

**NOTE**

If the user authentication screen appears, log in with a user who has the privilege to configure this setting. If you do not know your login user name or password, please contact your administrator.

- 2 [▲][▼] key > [User Login Set.] > [OK] key > [User Login] > [OK] key > [Network Authentication Settings] > [OK] key > [▲][▼] key > [Server Type] > [OK] key

2 Configure the settings.

- 1 Select [NTLM], [Kerberos] or [Ext.] as the server type, and select the [OK] key.
When [NTLM] or [Kerberos] is selected, you can configure multiple authentication servers.
- 2 Enter the host name (64 characters or less) for the Authentication Server, and select the [OK] key.
When selecting [Ext.] as the server type, enter the port number.
- 3 Enter the domain name for the Authentication Server, and select the [OK] key.
If domain name is not set, select "-----" and select [Menu]. Select [Edit], select the [OK] key, and enter the domain name (up to 256 characters). Select the [OK] key to register the Default Domain Name. To edit or delete the registered domain name, select the registered domain name, and then select [Menu].



NOTE

- Up to 10 domain names can be registered.
 - If the login user name and password are rejected, check the following settings.
 - Network Authentication setting of the machine
 - User property of the Authentication Server
 - Date and time setting of the machine and the Authentication Server
-

Configure Network User Rights

Select whether or not to grant local user rights to network users. If this setting is applied, when a network user logs in, the logged in network user's information is registered as a local user. By setting the account name on the registered local user information, network users can coordinate with job accounting. Displays the "Domain Name" in the user information for local users with rights.

NOTE

For local user information, refer to the following:

→ [Adding a User \(Local User List\) \(page 252\)](#)

1 Display the screen.

- 1 [Menu] key > [▲][▼] key > [User/]job Account] > [OK] key

NOTE

If the user authentication screen appears, log in with a user who has the privilege to configure this setting. If you do not know your login user name or password, please contact your administrator.

- 2 [▲][▼] key > [User Login Set.] > [OK] key > [▲][▼] key > [NW User Auth.] > [OK] key

2 Configure the settings.

Set [Give Authority] [On] to configure the settings.

[User Full Action]

Configure the action when the number of users is exceeded when granting local user rights.

Value: [Do Not Add New], [Delete Old User]

[Offline Auth]

Set the expiration date for local user rights that have been granted and that do not require network authentication.

Value: [Always Enabled], [Enabled Period]

If you set [Enabled Period], set the restriction. (up to 180days)

[Local Auth. Def.]

Set the default local user rights that are granted.

[Print Restriction: Printer]

Value: [Off], [Reject Usage]

[Printer(Full Color)]

Value: [Off], [Reject Usage]

[Duplex Restrict.]

Value: [Off], [2-sided Only]

[EcoPrint Restr.]

Value: [Off], [EcoPrint Only]

[Storing in Box]

Value: [Off], [Reject Usage]

Displayed when the optional SSD is installed.

Obtain NW User Property

Set the required information to obtain the network user property from the LDAP server.

 **NOTE**

To obtain the network user property from the LDAP server, [Netwk Authentic.] must be selected for the user authentication method in [User Login Set.]. In addition, set [LDAP] to [On] in [ProtocolSettings].

→ [Enable User Login Administration \(page 249\)](#)

→ [ProtocolSettings \(page 212\)](#)

1 Display the screen

- 1 [Menu] key > [▲][▼] key > [User/]Job Account > [OK] key
-

 **NOTE**

If the user authentication screen appears, log in with a user who has the privilege to configure this setting. If you do not know your login user name or password, please contact your administrator.

- 2 [▲][▼] key > [User Login Set.] > [OK] key > [▲][▼] key > [NW User Property] > [OK] key

2 Configure the settings.

Set [Off/On] to [On] and configure [Authentic. Type].

[Authentic. Type]*1

Set the authentication method. Select [Simple] or [SASL]. After changing the setting, restart the system or turn the power OFF and then ON.

*1 Appears when the server type is set to "Kerberos" in [Netwk Authentic.].

3 Select [OK].

ID Card Settings

If ID card authentication is enabled, select the authentication type.

NOTE

This functions appears when the Card Authentication kit is activated.

→ [Card Authentication Kit\(B\) AC <IC card authentication kit \(Activate\)> \(page 378\)](#)

Numeric Keypad Login

When IC card authentication is enabled, select whether or not login by numeric keypad is allowed.

1 Display the screen

- 1 [Menu] key > [▲][▼] key > [User/Job Account] > [OK] key > [▲][▼] key > [User Login Set.] > [OK] key > [▲][▼] key [ID Card Settings] > [OK] key
-

NOTE

If the user authentication screen appears, log in with a user who has the privilege to configure this setting. If you do not know your login user name or password, please contact your administrator.

- 2 [▲][▼] key > [Key Login] > [OK] key

2 Configure the settings.

- 1 Select [Permit] or [Prohibit].

Additional Authentication

Select whether or not to require password entry after authenticating by ID card.

NOTE

This function is displayed when "User Login" is enabled.

1 Display the screen

- 1 [Menu] key > [▲][▼] key > [User/Job Account] > [OK] key > [▲][▼] key > [User Login Set.] > [OK] key > [▲][▼] key [ID Card Settings] > [OK] key
-

NOTE

If the user authentication screen appears, log in with a user who has the privilege to configure this setting. If you do not know your login user name or password, please contact your administrator.

- 2 [▲][▼] key > [Additional Auth.] > [OK] key

2 Configure the settings.

- 1 Select [Off], [Use Password], or [Use PIN].



NOTE

[Use PIN] is displayed only when using PIN Code Authorization.

→ [PIN Login \(page 263\)](#)

Simple Job Printing

Displays a list of print jobs saved to the Stored Job Box when logging in with an IC card via user login.



NOTE

For details on Simple Job Printing, refer to the following:

→ [Simple Job Printing \(page 126\)](#)

1 Display the screen.

- 1 [Menu] key > [▲] [▼] key > [User/Job Account] > [OK] key > [▲] [▼] key > [User Login Set.] > [OK] key



NOTE

If the user authentication screen appears, log in with a user who has the privilege to configure this setting. If you do not know your login user name or password, please contact your administrator.

- 2 [▲][▼] key > [QuickJobPrinting] > [OK] key

2 Configure the settings.

Set "DispListOnLogin" to [On] to configure the settings.

[LogoutAfterPrint]

Select whether or not to automatically log out after printing.

[Skip PIN&Copies]

Select whether or not to skip entering the PIN code and confirming the number of copies when printing when a PIN code is set.

PIN Login

NOTE

When using PIN Code Authorization, the network authentication must be enabled and [Ext.] must be selected for server type.

→ [Enable User Login Administration \(page 249\)](#)

→ [Server Settings \(page 257\)](#)

1 Display the screen.

- 1 [Menu] key > [▲] [▼] key > [User/]job Account > [OK] key > [▲] [▼] key > [User Login Set.] > [OK] key
-

NOTE

If the user authentication screen appears, log in with a user who has the privilege to configure this setting. If you do not know your login user name or password, please contact your administrator.

- 2 [▲] [▼] key [PIN Login] > [OK] key

2 Configure the function.

- 1 Select [Off] or [On]

Using User Login Administration

This section explains procedures while setting job accounting.

Login/Logout

If user login administration is enabled, the login user name and login password entry screen appears each time you use this machine. Use the procedure below to login and logout.

Login

If the login user name entry screen appears during operations, log in by referring to the following:

→ [Login \(page 42\)](#)

Logout

When the operation is complete, select the [Logout] key. You will return to the login user name/login password entry screen.

Overview of Job Accounting

Job accounting manages the print count accumulated by individual accounts by assigning an ID to each account.

- 1 Enable job accounting
 - ➔ [Enabling Job Accounting \(page 265\)](#)
- 2 Setting an account.
 - ➔ [Job Accounting \(Local\) \(page 267\)](#)
- 3 Enter the assigned account ID when performing the job.
 - ➔ [Login \(page 276\)](#)
- 4 Count the number of pages printed.

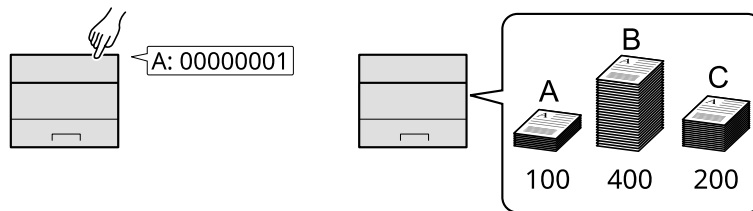

To Manage the Number of Sheets Used on Jobs Printed from a PC

To manage the number of jobs to be printed from the PC on the network, you need to configure settings by using the printer driver on the PC.

- 1 Set Job Accounting for the PC on the network by using the printer driver.
 - ➔ [Job Accounting for Printing \(page 271\)](#)
- 2 Execute printing.
- 3 Count the number of pages printed.

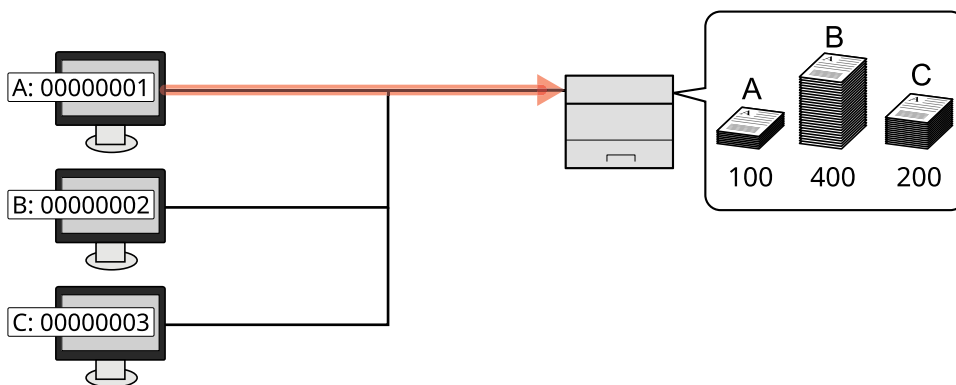

Enabling Job Accounting

1 Display the screen.

- 1 [Menu] key > [▲][▼] key > [User/Job Account] > [OK] key



NOTE

If the user authentication screen appears, log in with a user who has the privilege to configure this setting. If you do not know your login user name or password, please contact your administrator.

- 2 [▲][▼] key > [Job Account.Set.] > [OK] key > [▲][▼] key [Job Accounting] > [OK] key

2 Configure the settings.

Select [Off] to disable job accounting.



NOTE

When the display returns to System Menu default screen, logout is automatically executed and the screen to enter the Account ID appears. To continue the operation, enter the Account ID.

Job Accounting

Set the Job Accounting method.

1 Display the screen.

- 1 [Menu] key > [▲][▼] key > [User/Job Account] > [OK] key



NOTE

If the user authentication screen appears, log in with a user who has the privilege to configure this setting. If you do not know your login user name or password, please contact your administrator.

- 2 [▲][▼] key > [Job Account.Set.] > [OK] key > [▲][▼] key > [AccountingAccess] > [OK] key

2 Configure the settings.

- 1 Select [Local] or [Network].

Job Accounting (Local)

You can add, change and delete an account and set the restriction for each account.

Adding an Account

Up to 100 individual accounts can be added.

1 Display the screen.

- 1 [Menu] key > [▲][▼] key > [User/Job Account] > [OK] key
-

NOTE

If the user authentication screen appears, log in with a user who has the privilege to configure this setting. If you do not know your login user name or password, please contact your administrator.

- 2 [▲][▼] key > [Job Account.Set.] > [OK] key > [▲][▼] key > [Account.(Local)] > [OK] key > [▲][▼] key > [Account. List] > [OK] key

2 Enter the account ID.

- 1 Enter [Add] > [Account ID]

[Account ID]

Enter the account ID as many as eight digits (between 0 and 99999999).

NOTE

Any "Account ID" that has already registered cannot be used. Enter any other account ID.

- 2 Select the [OK] key.

A new account is added on the Account List.

This can prohibit printing or restrict the number of sheets to load.

➔ [Restricting the Use of the Machine \(page 268\)](#)

Restricting the Use of the Machine

This section explains how to restrict the use of the machine by account or the number of sheets available.

Restriction Items

Item	Description
[Restrict.(Total)]	Limits the total number of sheets used for printing.
[Restrict.(Color)]	Limits the total number of pages used for color printing.

Applying Restriction

Restriction can be applied in the following modes:

Item	Description
[Off]	No restriction is applied.
[Counter Limit]	Restricts the print counter in one-page increments up to 9,999,999 copies.
[Reject Usage]	Restriction is applied.

Editing an Account

1 Display the screen.

- [Menu] key > [▲][▼] key > [User/Job Account] > [OK] key



NOTE

If the user authentication screen appears, log in with a user who has the privilege to configure this setting. If you do not know your login user name or password, please contact your administrator.

- [▲][▼] key > [Job Account.Set.] > [OK] key > [▲][▼] key > [Account.(Local)] > [OK] key > [▲][▼] key > [Account. List] > [OK] key

2 Edit an account

- Select the account you want to change account information for and select the [OK] key.
- [▲][▼] key > [Detail/Edit] > [OK] key
- Select the item you wish to change, and select the [OK] key.
- Change account information by referring to procedure 2 for “Adding an Account” and “Restricting the Use of the Machine.”
 - ➔ [Adding an Account \(page 267\)](#)
 - ➔ [Restricting the Use of the Machine \(page 268\)](#)
- Select the [OK] key.
The account information is changed.

Deleting an Account

1 Display the screen.

- [Menu] key > [▲][▼] key > [User/Job Account] > [OK] key



NOTE

If the user authentication screen appears, log in with a user who has the privilege to configure this setting. If you do not know your login user name or password, please contact your administrator.

- 2 [▲][▼] key > [Job Account.Set.] > [OK] key > [▲][▼] key > [Account.(Local)] > [OK] key > [▲][▼] key > [Account. List] > [OK] key

2 Deleting

- 1 Select the account to delete and select [OK] key.

- 2 [▲][▼] key > [Delete] > [OK] key > [Yes]

The account is deleted.

Job Accounting for Printing

To manage the number of pages used for jobs to be printed from the PC, you need to configure the following settings by using the printer driver. Instructions are based on interface elements as they appear in Windows 10.

1 Display the screen.

- 1 Select the [Start] button in Windows, select → [Windows System Tools], → [Control Panel]→ [Devices and Printers].



NOTE

- For Windows 11, select the [Start] button → [All apps]→ [Windows Tools]→ [Control Panel]→ [Devices and Printers].
- For Windows 8.1, select [Settings] in the Charms Bar on Desktop → [Control Panel]→ [Devices and Printers].

- 2 Right-click the printer driver icon of the machine, and click the [Printer properties] menu of the printer driver.
- 3 Click [Administrator] on the [Device Settings] tab.

2 Configure the settings.

- 1 Select [Job accounting] on the [Job Accounting] tab.

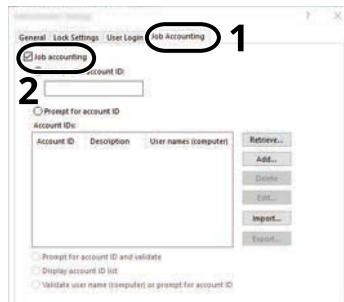

- 2 Set the Job Accounting.

[Use Specific Account ID]

Enter the Account ID. Printing will be performed using the entered Account ID. If this option is selected, the user does not have to enter the Account ID for each print job.

[Prompt for account ID]

A screen for entering the Account ID will be displayed when attempting a printing. The Account ID must be entered each time a printing is attempted.

[Prompt for account ID and validate]

A screen for entering the Account ID will be displayed when attempting a printing. The Account ID stored in the Account ID list needs to be entered. The Account ID must be entered each time a printing is attempted.

[Display account ID list]

The Account ID list is displayed when printing. The Account ID to be used needs to be selected from the list.

[Validate user name (computer) or prompt for account ID]

When printing, the Windows user name is searched in the "Account IDs" and printing is possible if the name is registered. If the Account ID is not registered, the screen for entering the Account ID will appear.

- 3 Click [OK].



NOTE

For other settings of job accounting, refer to the following:

➔ **Printer Driver User Guide**

Configuring Job Accounting

Counting the Number of Pages Printed

This counts the number of pages printed. Counts are classified into Each Job Accounting. A new count can also be started after resetting the count data which was stored for a certain period of time.

The items that can be referenced are as follows:

Item	Description
[Printed Pages]	<p>Displays the number of pages used in printing for each of the following item.</p> <p>[Total] The number of pages used for color printing, black and white printing, and the total for both is displayed.</p> <p>[Full Color] The number of pages used for color printing is displayed.</p> <p>[Black & White] The number of pages used for black and white printing is displayed.</p> <p>[Combine(None)] The number of pages used for printing without Combine.</p> <p>[Combine(2in1)] The number of pages used for Combine (2 in 1) printing is displayed.</p> <p>[Combine(4in1)] The number of pages used for Combine printing (4 in 1) is displayed.</p> <p>[Duplex(1side)] The number of pages used for one-sided printing is displayed.</p> <p>[Duplex(2side)] The number of pages used for two-sided printing is displayed.</p>
[Counter Reset]	<p>Resets the counter. Select [Yes] on the confirmation screen.</p>

Counting the Number of Pages for Each Account

This counts the number of pages for each account and resets the counts by account. When checking Each Job Accounting, select the account for which you want to check the count.

1 Display the screen.

- 1 [Menu] key > [▲][▼] key > [User/Job Account] > [OK] key > [▲][▼] key > [Job Account.Set.] > [OK] key > [▲][▼] key > [Account.(Local)] > [OK] key > [▲][▼] key > [Each Job Account] > [OK] key



NOTE

If the user authentication screen appears, log in with a user who has the privilege to configure this setting. If you do not know your login user name or password, please contact your administrator.

2 Check the number of pages.

- 1 Select the account.
- 2 Check the count.
Select [Counter Reset] to reset the counter.
- 3 Confirm the count and select the [OK] key.

Print Accounting Report

The total pages counted of all relevant accounts can be printed as an accounting report.

1 Prepare paper.

Check that A4 or Letter paper is loaded in the cassette.

2 Display the screen.

1 [Menu] key > [▲] [▼] key > [User/Job Account] > [OK] key



NOTE

If the user authentication screen appears, log in with a user who has the privilege to configure this setting. If you do not know your login user name or password, please contact your administrator.

2 [▲] [▼] key > [Job Account.Set.] > [OK] key > [▲] [▼] key > [Account.(Local)] > [OK] key

3 Print.

1 [▲] [▼] key > [Account. Report] > [OK] key > [Yes]

Accounting report is printed.

Reports have different formats depending on how the count of printers is administered. If count by paper size is being performed, then the report will be printed per size.

Using Job Accounting

This section explains procedures while setting job accounting.

Login

If job accounting is enabled, an account ID entry screen appears each time you use this machine.

1 Enter the account ID using the numeric keys > [Login]



NOTE

- If you entered a wrong character, select [Clear] key and enter the account ID again.
 - If the entered account ID does not match the registered ID, a warning beep will sound and login will fail. Enter the correct account ID.
-

If user login administration is enabled, the screen to enter the login user name and password appears instead of the screen to enter the account ID. Enter a login user name and password to login. If the user has already registered the account information, the account ID entry would be skipped.

→ [Adding a User \(Local User List\) \(page 252\)](#)

2 Proceed to complete the rest of the steps.

Logout

- 1 When the operation is complete, select the [Logout]key. Return to the Enter Account ID screen.

Apply Limit

This specifies how the machine behaves when the counter has reached the limit of restriction. The action is as follows:

Item	Description
[Immediately]	Job stops when the counter reaches its limit.
[Subsequently]	The print job currently underway will continue but the subsequent job will be rejected.

1 Display the screen.

- 1 [Menu] key > [▲] [▼] key > [User/Job Account] > [OK] key



NOTE

If the user authentication screen appears, log in with a user who has the privilege to configure this setting. If you do not know your login user name or password, please contact your administrator.

- 2 [▲] [▼] key > [Job Account.Set.] > [OK] key > [▲] [▼] key > [Apply Limit] > [OK] key

2 Configure the function.

- 1 Select [Immediately] or [Subsequently].

Unknown User Settings

Unknown ID Job

This specifies the behavior for handling the jobs sent with unknown or unsent login user names or User ID. If the User Login is set to invalid and Job Accounting is set to valid, follow the procedure when the Account ID is unknown.

1 Display the screen.

- 1 [Menu] key > [▲][▼] key > [User/Job Account] > [OK] key



NOTE

If the user authentication screen appears, log in with a user who has the privilege to configure this setting. If you do not know your login user name or password, please contact your administrator.

- 2 [▲][▼] key > [Unknown User] > [OK] key > [▲][▼] key > [Unknown ID Job] > [OK] key

2 Configure the settings.

Select [Reject] or [Permit].

[Permit]

The job is permitted to be printed.

[Reject]

The job is rejected (not printed).

Registering Information for a User whose ID is Unknown

If you register user information for a user whose ID is unknown, you can check information on the Job Status or Job History screens. In addition, you can restrict available functions.

This function is displayed when [Unknown ID Job] is set to [Permit].

➔ [Unknown ID Job \(page 278\)](#)

1 Display the screen

- 1 Menu key > [▲][▼] key > [User/Job Account] > [OK] key



NOTE

If the user authentication screen appears, log in with a user who has the privilege to configure this setting. If you do not know your login user name or password, please contact your administrator.

- 2 [▲][▼] key > [Unknown User] > [OK] key > [▲][▼] key > [User Property] > [OK] key

2 Enter the user information.

Select [Edit] or [Change], [Detail], enter each detail, then select [OK] key.

[▶]Select key to display the next page. Select the [◀] key to return to the previous screen.

[User Name]

Enter the name displayed on the user list (up to 32 characters).

[Account ID]

Register an account ID for a user whose ID is unknown.

[Auth. Rules]

Set usage authority.

The following restriction items are available:

[Print Restrict.]

Select whether or not to reject usage of print functions for the printer.

Applicable print functions are as follows:

- Print from PC

10 Troubleshooting

Regular Maintenance

Cleaning

Clean the machine regularly to ensure optimum printing quality.



CAUTION

For safety, always unplug the power cord before cleaning the machine.

Cleaning Paper Transfer Unit

The paper transfer unit should be cleaned each time the toner container and waste toner box are replaced. To maintain optimum print quality, it is also recommended that the inside of the machine be cleaned once a month as well as when the toner container is replaced.

Print problems such as soiling of the reverse side of printed pages may occur if the paper transfer unit becomes dirty.

CAUTION

Some parts are very hot inside the machine. Exercise caution as there is a risk of burn injury.

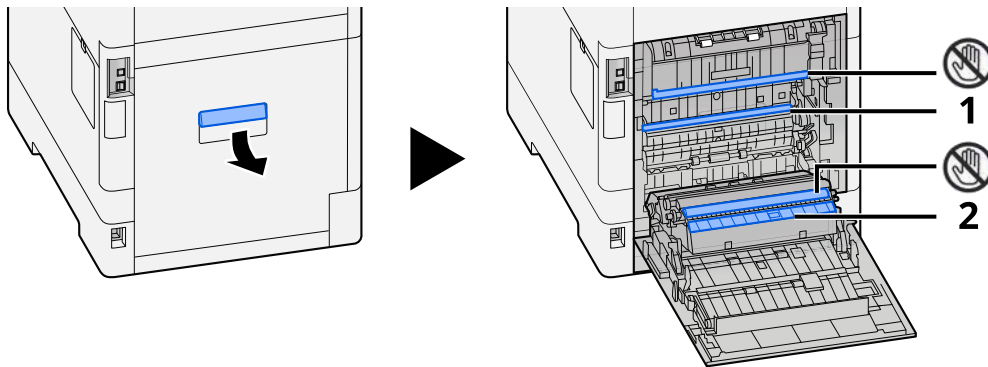

Wipe away the paper dust on paper 1 and dirt on paper 2 using a soft, dry cloth.

IMPORTANT

Be careful not to touch the  part during cleaning. It may deteriorate the print quality.

Replacing the Toner Container

When toner is empty, the following message will be displayed. Replace the toner container.

"Toner [C][M][Y][K] is empty."

When toner runs low, the following message will be displayed. Make sure you have a new toner container available for replacement.

"Toner [C][M][Y][K] is low. (Replace when empty.)"

The number of sheets that can be printed with one toner container depends on the print data (how much toner is used). Compliant with JIS X 6932 (ISO/IEC 19798), when the EcoPrint mode is turned [Off], the average number of printable sheets of the toner container is as follows: (When printing with A4.)

Toner Color	Life of the Toner Container (Printable pages)		
	ECOSYS PA4500cx	ECOSYS PA4000cx	ECOSYS PA3500cx
Black	18,000 images	13,000 images	7,000 images
Cyan	13,000 images	10,000 images	5,000 images
Magenta	13,000 images	10,000 images	5,000 images
Yellow	13,000 images	10,000 images	5,000 images

NOTE

- The average number of printable sheets of the toner container that comes with this machine is as follows:
- **ECOSYS PA4500cx**
 Black (K): 8,000 sheets.
 Cyan (C) / Magenta (M) / Yellow (Y): 6,000 sheets.
- **ECOSYS PA4000cx**
 Black (K): 6,000 sheets.
 Cyan (C) / Magenta (M) / Yellow (Y): 5,000 sheets.
- **ECOSYS PA3500cx**
 Black (K): 3,500 sheets.
 Cyan (C) / Magenta (M) / Yellow (Y): 2,500 sheets.
- For the toner container, always use a genuine toner container. Using a toner container that is not genuine may cause image defects and product failure.
- The memory chip in the toner container of this product stores information necessary for improving customer convenience, operation of the recycling system for used toner containers, and planning and development of new products. The stored information does not include information that makes it possible to identify individuals, and is only used anonymously for the above purposes.

CAUTION

Do not attempt to incinerate parts which contain toner. Dangerous sparks may cause burns.

Installation procedures of the toner container is same for every color. Here, we'll explain the procedures for the yellow toner container, as an example.

1 Open the top cover.

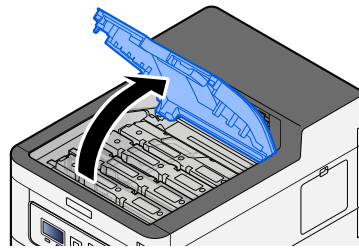

2 Remove the toner container.

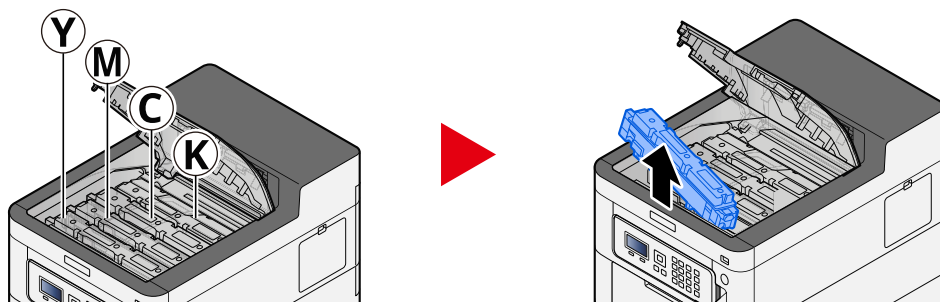

3 Put used toner container into the plastic waste bag.

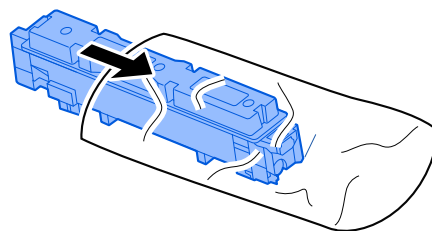

4 Remove the new toner container from the box.

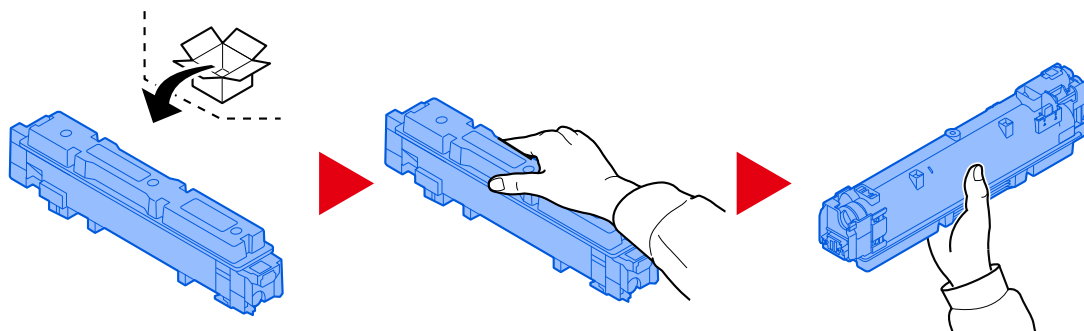

✔ **IMPORTANT**

Do not touch the points shown below.

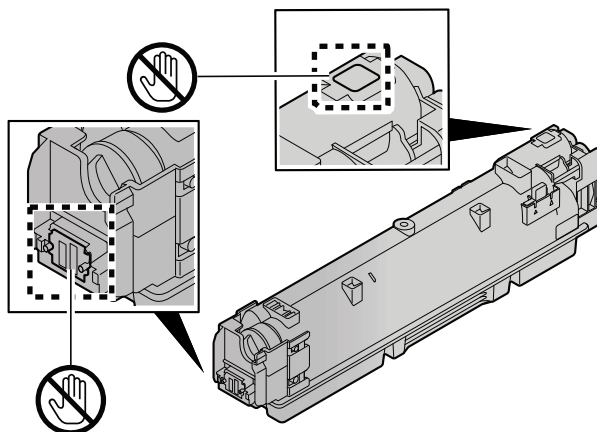

5 Shake the toner container.

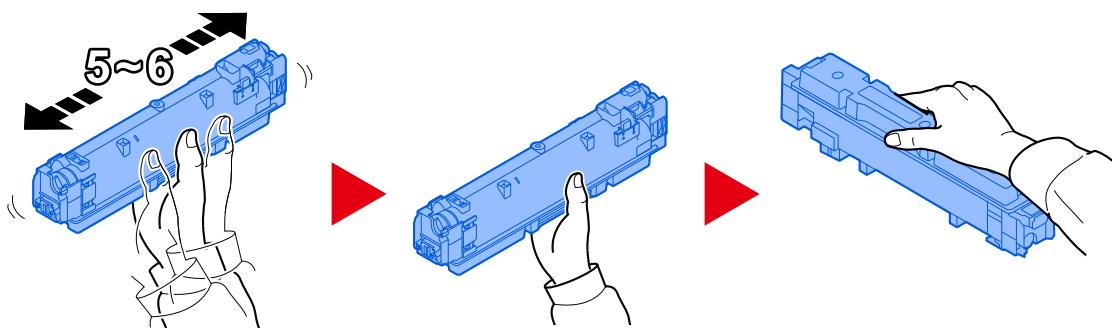

6 Install the toner container.

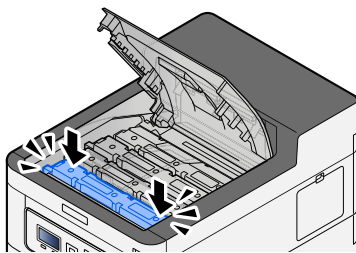

IMPORTANT

Insert the toner container all the way.

7 Close the front cover.

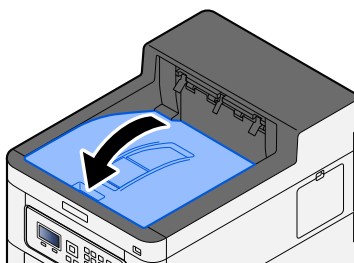

NOTE

- If the toner container cover or front cover does not close, check that the new toner container is installed correctly.
 - Return the exhausted toner container to your dealer or service representative. The collected toner container will be recycled or disposed in accordance with the relevant regulations.
-

Replacing the Waste Toner Box

When the waste toner box is full, the following message will be displayed.

"Waste Toner Box is full or placed improperly."



CAUTION

Do not attempt to incinerate parts which contain toner. Dangerous sparks may cause burns.

1 Open the Waste Toner Cover

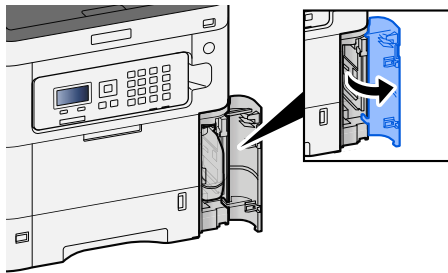

2 Remove the Waste Toner Box.

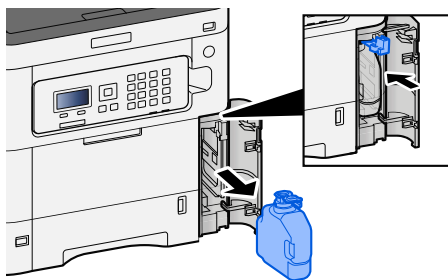

3 Put used Waste Toner Box into the plastic waste bag.

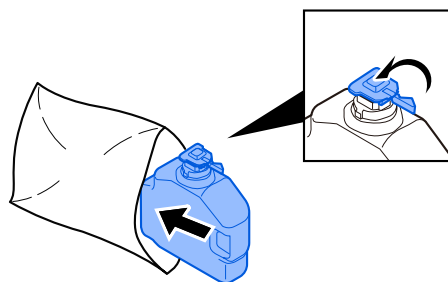

4 Remove the new Waste Toner Box.

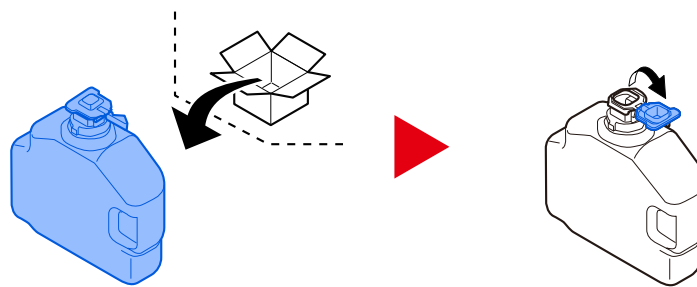

5 Install the Waste Toner Box.

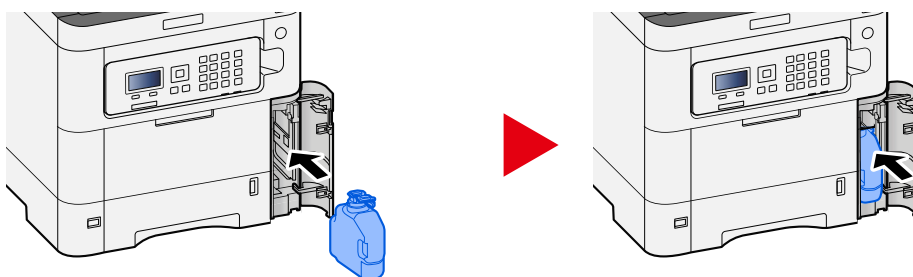

6 Close the Waste Toner Cover

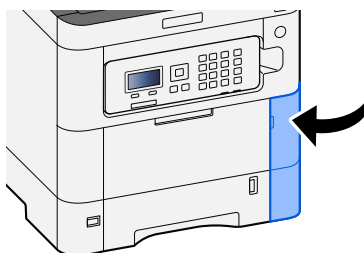

 **NOTE**

Return the exhausted waste toner box to your dealer or service representative. The collected waste toner box will be recycled or disposed in accordance with the relevant regulations.

Troubleshooting

Solving Malfunctions

If a problem occurs with your machine, look into the checkpoints and perform procedures indicated on the following pages. The table below provides general guidelines for problem solving. If the problem persists, contact your service representative.

 **NOTE**

When contacting us, the serial number will be necessary. To check the serial number, refer to the following:

➔ [Checking the Equipment's Serial Number \(page 2\)](#)

Machine Operation Trouble

The application does not start up

Is the auto panel reset setting time set too short?

Check the set time for auto panel reset.

- 1 [Menu] key > [▲] [▼] key > [Device Common] > [OK] key > [▲] [▼] key > [Timer Setting] > [OK] key > [▲] [▼] key > [PanelReset Timer] > [OK] key**
- 2 Set the panel reset time to 30 seconds or more**
It can be set in the range of 5 to 495 seconds (in 5 second increments).

The screen does not respond when the power switch is turned on

Is the machine plugged in?

1 Plug in the power cord that comes with this machine to an outlet.

Make sure the power plug is securely plugged in.

Paper often jams

Is the paper loaded correctly?

Load the paper correctly.

When loading paper in a cassette

1 Pull the cassette completely out of the machine.

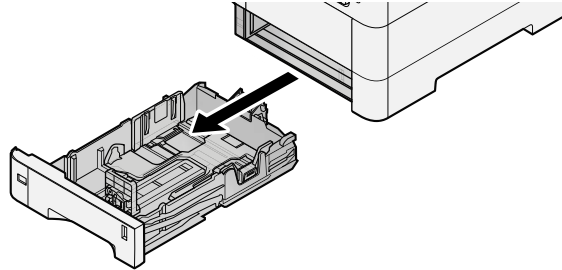

NOTE

When pulling the cassette out of the machine, ensure it is supported and does not fall out.

2 Adjust the cassette size.

- 1 Adjust the position of the paper width guides located on the left and right sides of the cassette. Press the paper width adjusting tab and slide the guides to the paper size required.

Paper sizes are marked on the cassette.

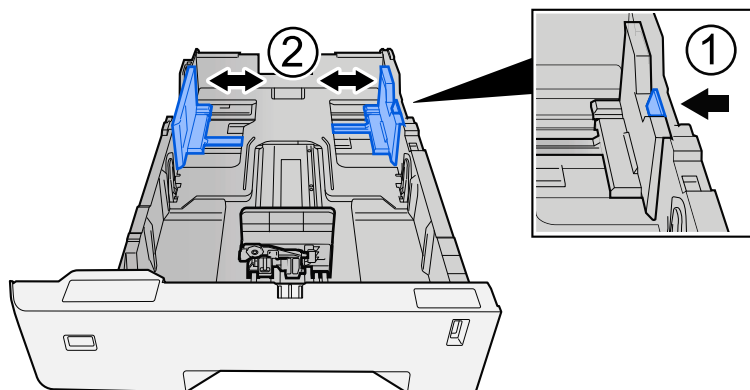

- 2 Adjust the paper length guide to the paper size required. Press the paper length adjusting tab and slide the guides to the paper size required.

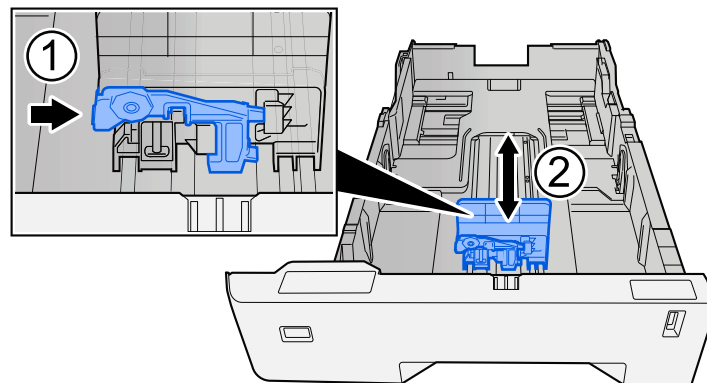

- 3 Turn the size dial so that the size of the paper you are going to use appears in the paper size window.

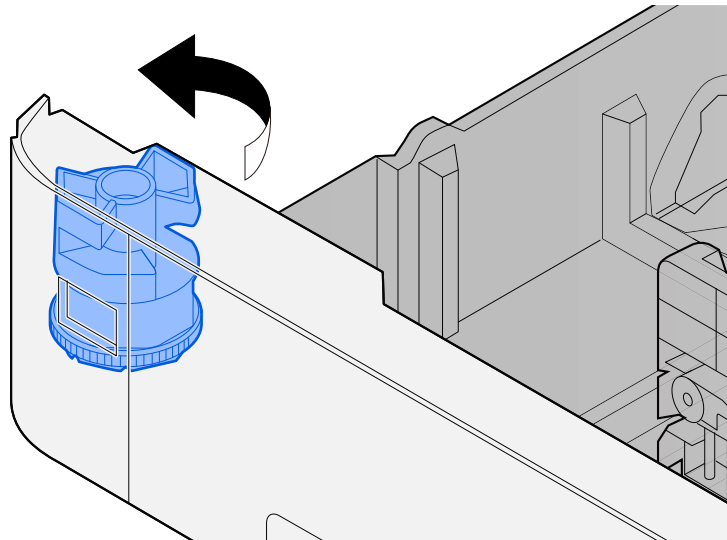

NOTE

Set the size dial to Other if you wish to use paper that is other than the Standard Size. In this case, it is necessary to set the paper size from the operation panel.

➔ [Specifying Paper Size and Media Type \(page 99\)](#)

3 Load paper.

- 1 Fan the paper, then tap it on a level surface to avoid paper jams or skewed printing.

2 Load the paper in the cassette.

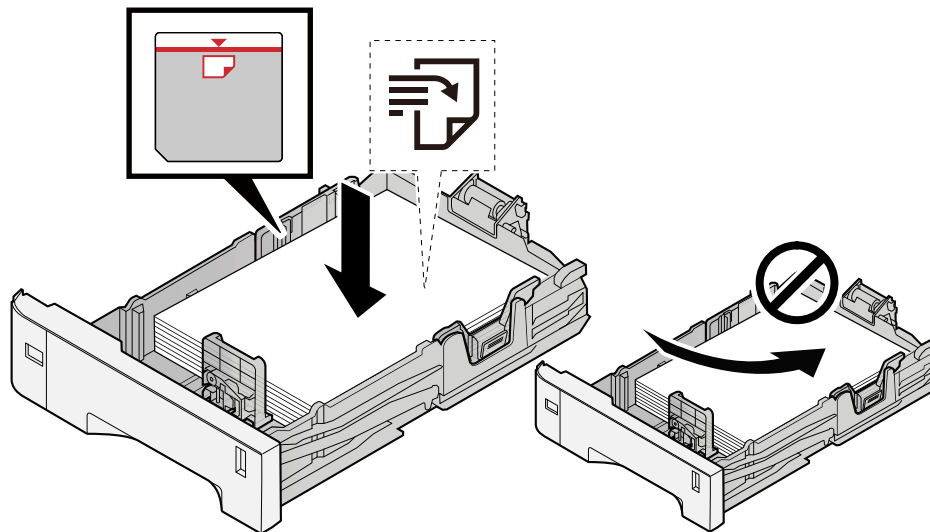

✔ **IMPORTANT**

- Load the paper with the print side facing up.
- After removing new paper from its packaging, fan out the paper before loading it in the cassettes.
➔ [Precaution for Loading Paper \(page 90\)](#)
- Before loading the paper, be sure that it is not curled or folded. Paper that is curled or folded may cause paper jams.
- Ensure that the loaded paper does not exceed the level indicator (see illustration above).
- If paper is loaded without adjusting the paper length guide and paper width guide, the paper may skew or become jammed.

4 Gently push the cassette back in.

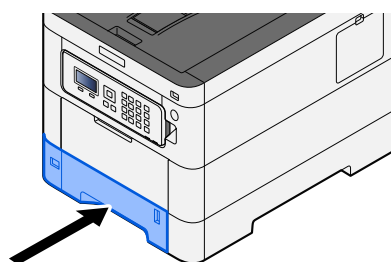



NOTE

There is a paper gauge on the right side of the front of the cassette. The display changes up and down to match the remaining amount of paper.

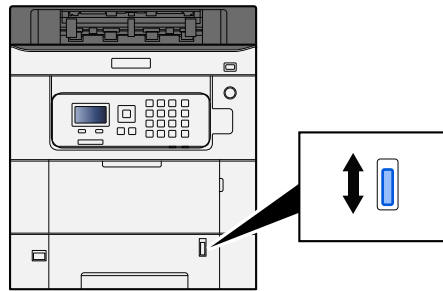

5 Specify the type of paper loaded in the cassette using the operation panel.

→ [Specifying Paper Size and Media Type \(page 99\)](#)

When loading paper in the multipurpose tray

1 Open the multipurpose tray.

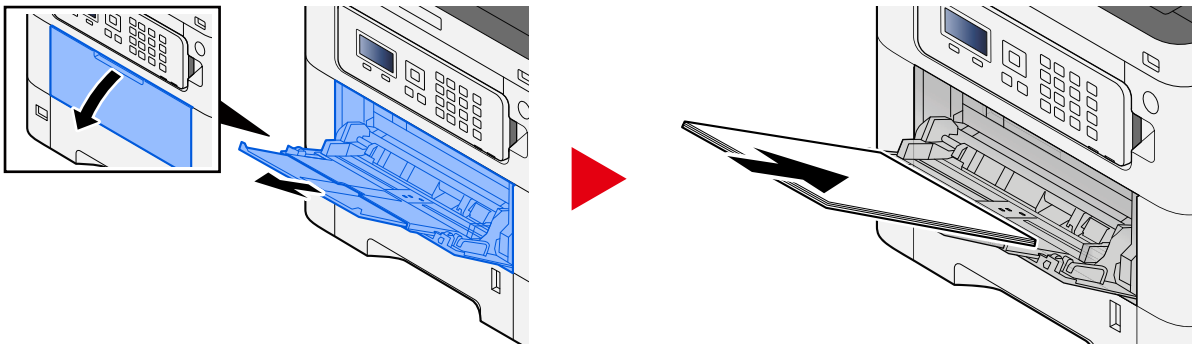

2 Adjust the multipurpose tray size.

Paper sizes are marked on the multipurpose tray.

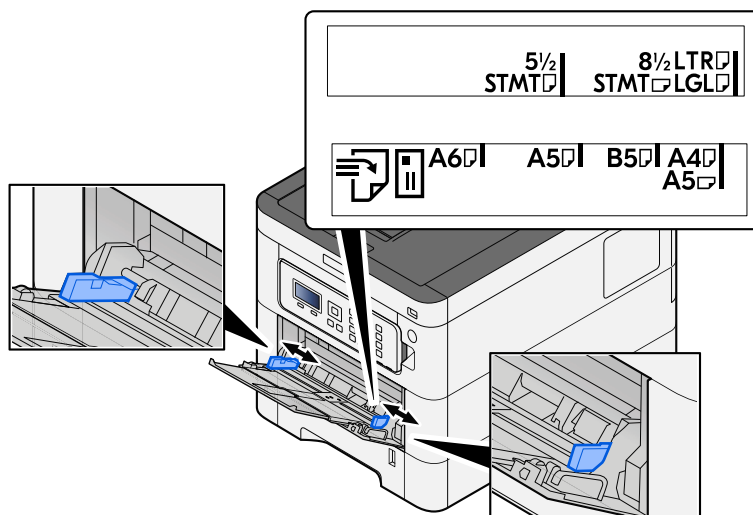

3 Load paper.

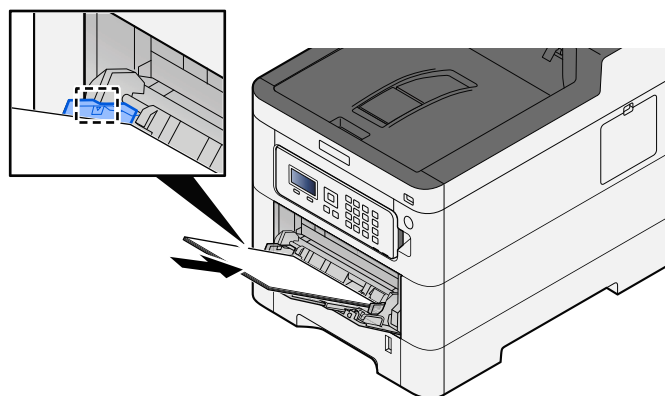

Insert the paper along the paper width guides into the tray until it stops.

After removing new paper from its packaging, fan the paper before loading it in the multipurpose tray.

➔ [Precaution for Loading Paper \(page 90\)](#)

✔ IMPORTANT

- When loading the paper, keep the print side facing up.
- Curled paper must be uncurled before use.
- When loading paper into the multipurpose tray, check that there is no paper left over in the tray from a previous job before loading the paper. If there is just a small amount of paper left over in the multipurpose tray and you want to add more, first remove the left-over paper from the tray and include it with the new paper before loading the paper back into the tray.
- If there is a gap between the paper and the paper width guides, readjust the guides to fit the paper in order to prevent skewed feeding and paper jams.
- Ensure that the loaded paper does not exceed the load limits.

When you load envelopes or cardstock in the multipurpose tray, load the paper with the print side facing up. For the procedure for printing, refer to the Printer Driver User Guide.

➔ [Printer Driver User Guide](#)

Example: When printing the address.

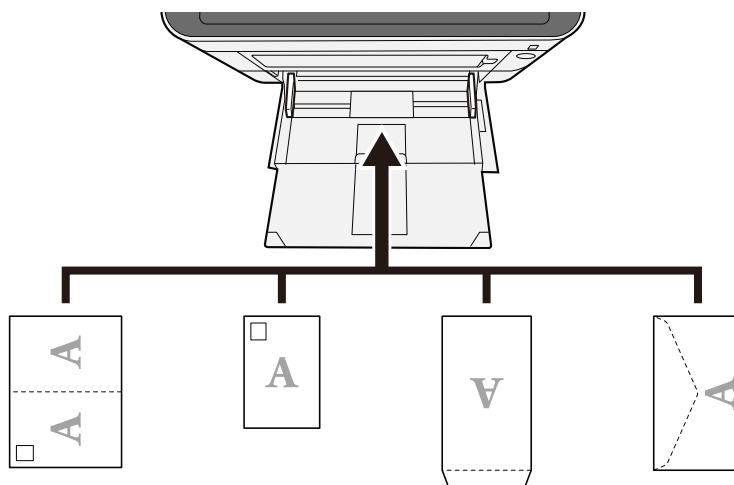

IMPORTANT

- Use unfolded Oufuku hagaki (Return postcard).
- How to load envelopes (orientation and facing) will differ depending on the type of envelope. Be sure to load it in correctly, otherwise printing may be done in the wrong direction or on the wrong face.

NOTE

When you load envelopes in the multipurpose tray, select the envelope type by referring to the following:

➔ [MP Tray Set. \(page 188\)](#)

4 Specify the type of paper loaded in the multipurpose tray using the operation panel.

➔ [Specifying Paper Size and Media Type \(page 99\)](#)

Remove the paper from the multipurpose tray once and change the loading direction by rotating the paper 180 degrees.

➔ [Precaution for Loading Paper \(page 90\)](#)

Is the paper of the supported type? Is it in good condition?

Remove the paper from the cassette, turn it over, and then reload it.

➔ [Precaution for Loading Paper \(page 90\)](#)

Is the paper curled, folded or wrinkled?

Replace the paper with new paper.

➔ [Precaution for Loading Paper \(page 90\)](#)

Are there any loose scraps or jammed paper in the machine?

Remove the jammed paper.

➔ [Clearing Paper Jams \(page 362\)](#)

Two or more sheets are overlaps when ejected (multi feeding)

ABC
123

Is the paper loaded correctly?

Load the paper correctly.

When loading paper in a cassette

1 Pull the cassette completely out of the machine.

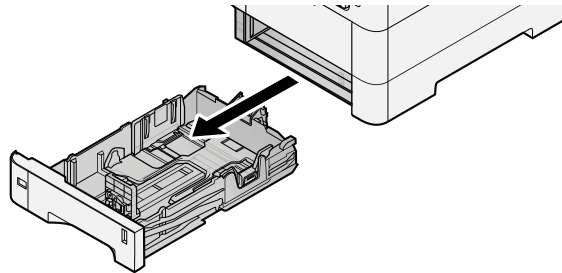

NOTE

When pulling the cassette out of the machine, ensure it is supported and does not fall out.

2 Adjust the cassette size.

- 1 Adjust the position of the paper width guides located on the left and right sides of the cassette. Press the paper width adjusting tab and slide the guides to the paper size required.

Paper sizes are marked on the cassette.

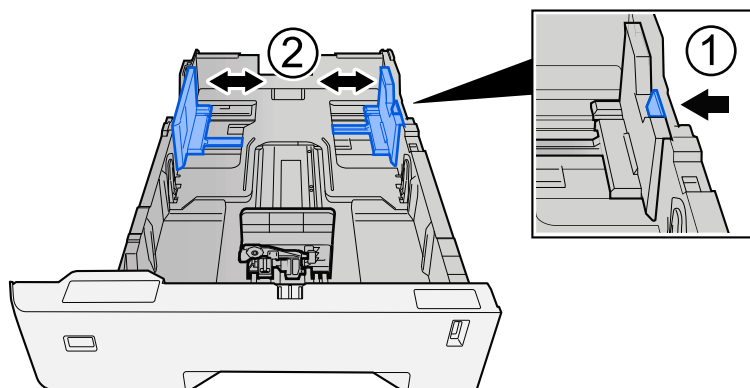

- 2 Adjust the paper length guide to the paper size required. Press the paper length adjusting tab and slide the guides to the paper size required.

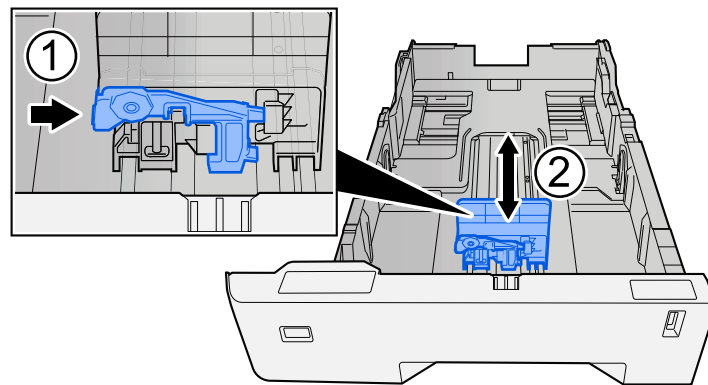

- 3 Turn the size dial so that the size of the paper you are going to use appears in the paper size window.

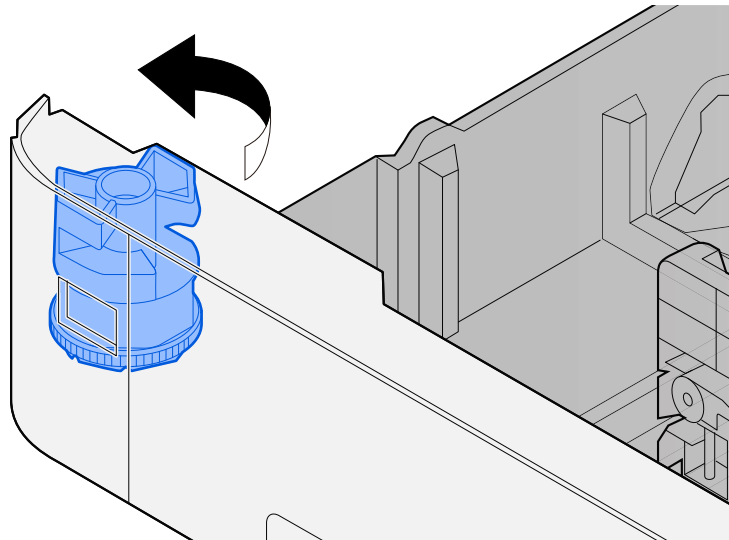

NOTE

Set the size dial to Other if you wish to use paper that is other than the Standard Size. In this case, it is necessary to set the paper size from the operation panel.

➔ [Specifying Paper Size and Media Type \(page 99\)](#)

3 Load paper.

- 1 Fan the paper, then tap it on a level surface to avoid paper jams or skewed printing.

2 Load the paper in the cassette.

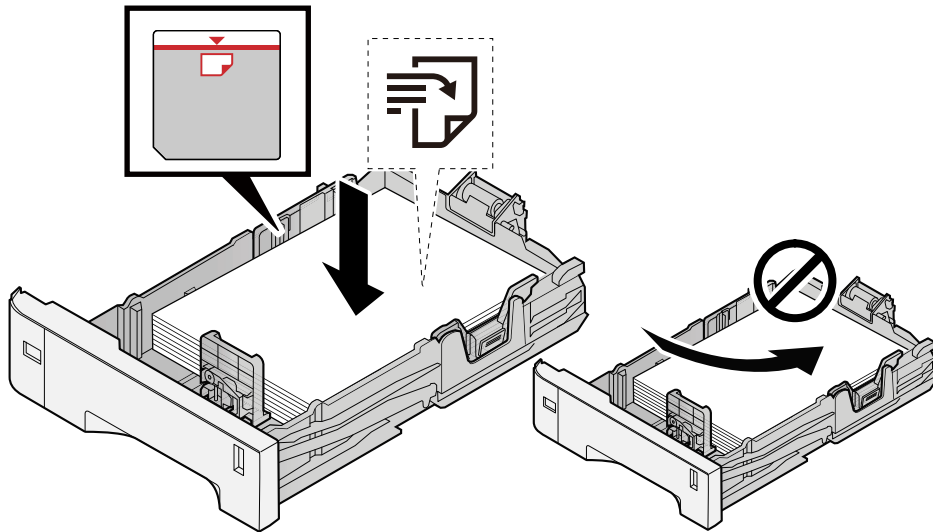

✔ **IMPORTANT**

- Load the paper with the print side facing up.
- After removing new paper from its packaging, fan out the paper before loading it in the cassettes.
➔ [Precaution for Loading Paper \(page 90\)](#)
- Before loading the paper, be sure that it is not curled or folded. Paper that is curled or folded may cause paper jams.
- Ensure that the loaded paper does not exceed the level indicator (see illustration above).
- If paper is loaded without adjusting the paper length guide and paper width guide, the paper may skew or become jammed.

4 Gently push the cassette back in.

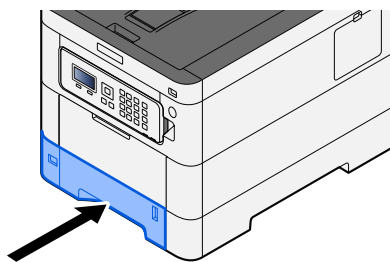



NOTE

There is a paper gauge on the right side of the front of the cassette. The display changes up and down to match the remaining amount of paper.

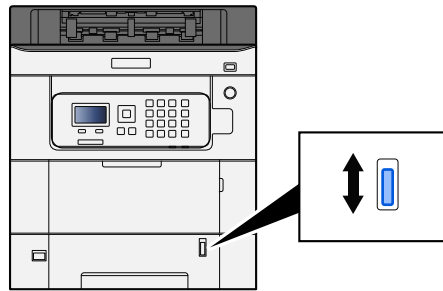

5 Specify the type of paper loaded in the cassette using the operation panel.

→ [Specifying Paper Size and Media Type \(page 99\)](#)

When loading paper in the multipurpose tray

1 Open the multipurpose tray.

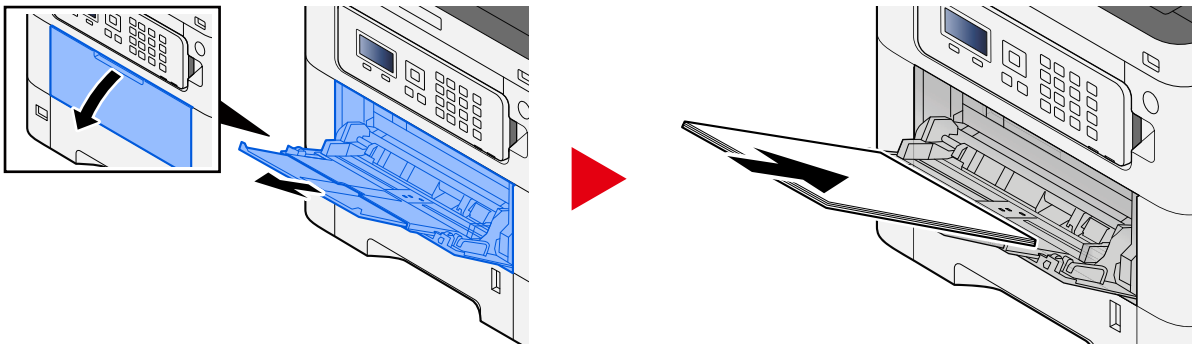

2 Adjust the multipurpose tray size.

Paper sizes are marked on the multipurpose tray.

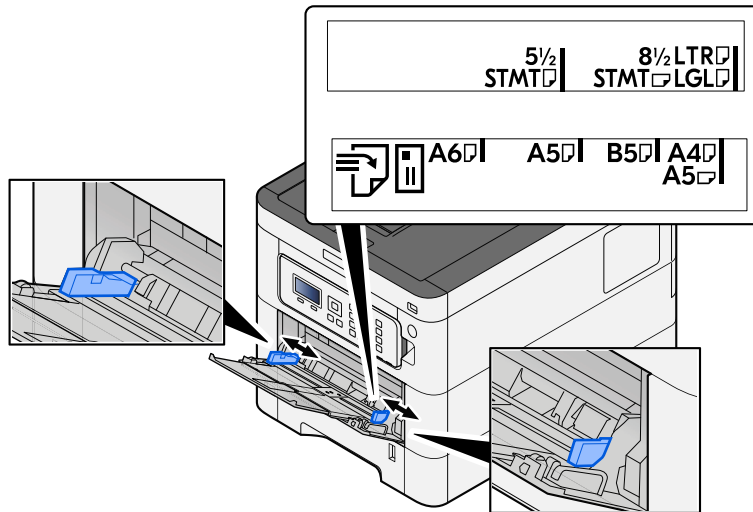

3 Load paper.

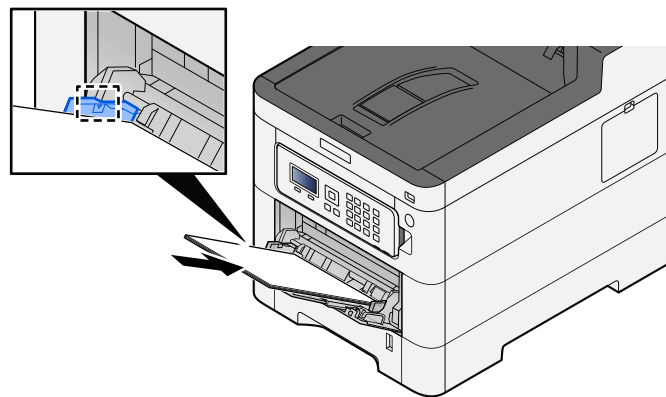

Insert the paper along the paper width guides into the tray until it stops.

After removing new paper from its packaging, fan the paper before loading it in the multipurpose tray.

➔ [Precaution for Loading Paper \(page 90\)](#)

✔ IMPORTANT

- When loading the paper, keep the print side facing up.
- Curled paper must be uncurled before use.
- When loading paper into the multipurpose tray, check that there is no paper left over in the tray from a previous job before loading the paper. If there is just a small amount of paper left over in the multipurpose tray and you want to add more, first remove the left-over paper from the tray and include it with the new paper before loading the paper back into the tray.
- If there is a gap between the paper and the paper width guides, readjust the guides to fit the paper in order to prevent skewed feeding and paper jams.
- Ensure that the loaded paper does not exceed the load limits.

When you load envelopes or cardstock in the multipurpose tray, load the paper with the print side facing up. For the procedure for printing, refer to the Printer Driver User Guide.

➔ [Printer Driver User Guide](#)

Example: When printing the address.

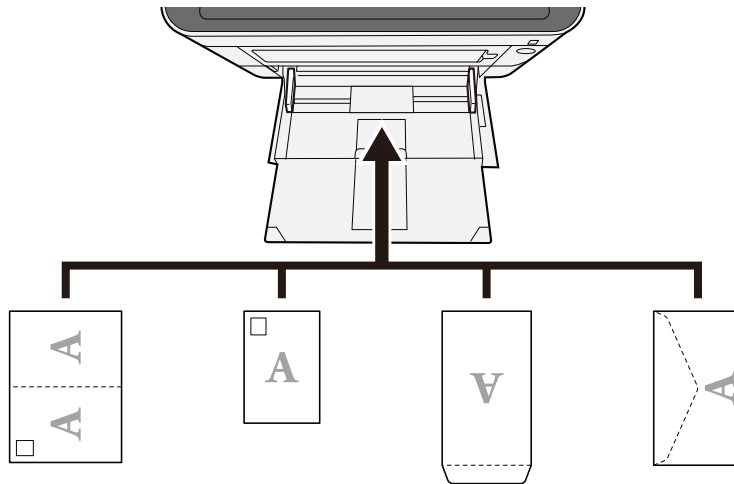

✓ IMPORTANT

- Use unfolded Oufuku hagaki (Return postcard).
 - How to load envelopes (orientation and facing) will differ depending on the type of envelope. Be sure to load it in correctly, otherwise printing may be done in the wrong direction or on the wrong face.
-

🔍 NOTE

When you load envelopes in the multipurpose tray, select the envelope type by referring to the following:

➔ [MP Tray Set. \(page 188\)](#)

4 Specify the type of paper loaded in the multipurpose tray using the operation panel.

➔ [Specifying Paper Size and Media Type \(page 99\)](#)

Printouts are wrinkled

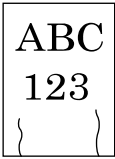

Is the paper loaded correctly?

Load the paper correctly.

When loading paper in a cassette

1 Pull the cassette completely out of the machine.

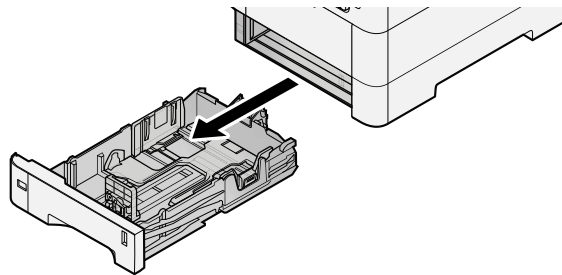

NOTE

When pulling the cassette out of the machine, ensure it is supported and does not fall out.

2 Adjust the cassette size.

- 1 Adjust the position of the paper width guides located on the left and right sides of the cassette. Press the paper width adjusting tab and slide the guides to the paper size required.

Paper sizes are marked on the cassette.

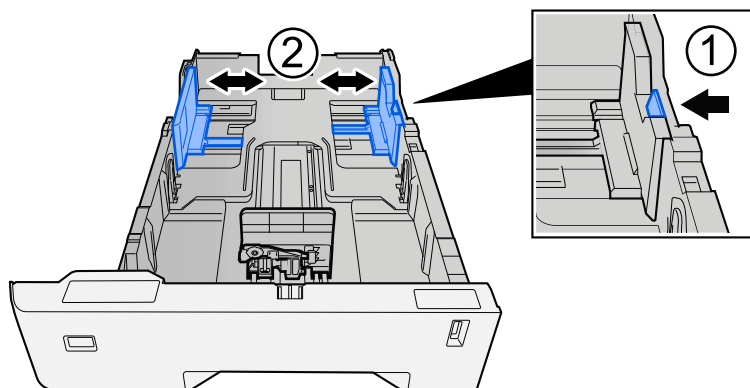

- 2 Adjust the paper length guide to the paper size required. Press the paper length adjusting tab and slide the guides to the paper size required.

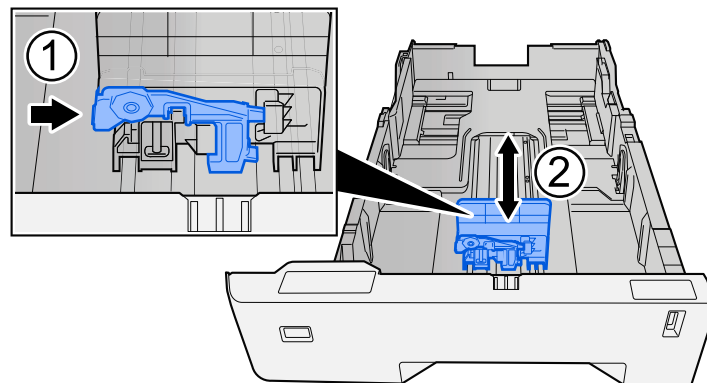

- 3 Turn the size dial so that the size of the paper you are going to use appears in the paper size window.

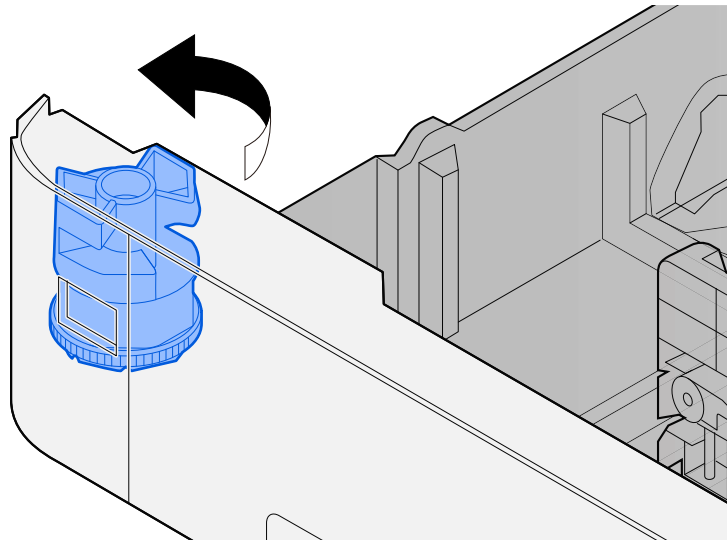

 **NOTE**

Set the size dial to Other if you wish to use paper that is other than the Standard Size. In this case, it is necessary to set the paper size from the operation panel.

➔ [Specifying Paper Size and Media Type \(page 99\)](#)

3 Load paper.

- 1 Fan the paper, then tap it on a level surface to avoid paper jams or skewed printing.

2 Load the paper in the cassette.

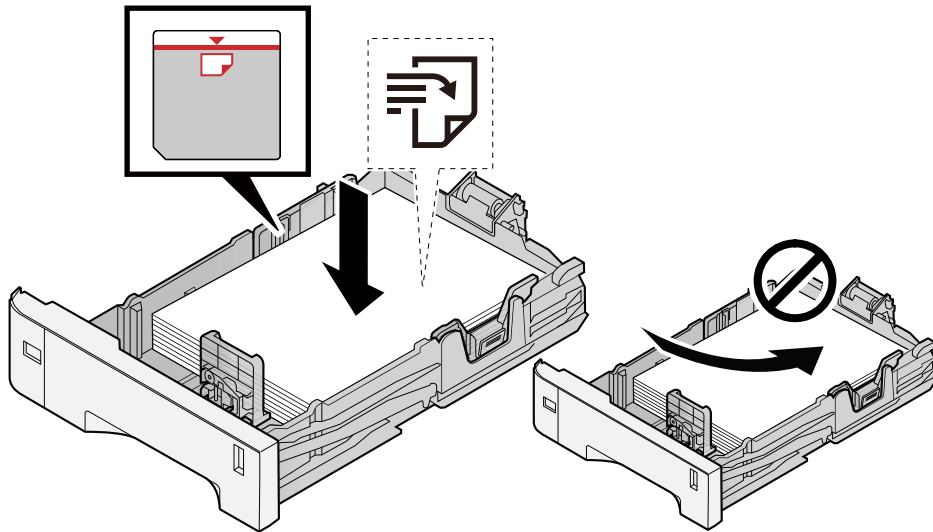

✔ **IMPORTANT**

- Load the paper with the print side facing up.
- After removing new paper from its packaging, fan out the paper before loading it in the cassettes.
➔ [Precaution for Loading Paper \(page 90\)](#)
- Before loading the paper, be sure that it is not curled or folded. Paper that is curled or folded may cause paper jams.
- Ensure that the loaded paper does not exceed the level indicator (see illustration above).
- If paper is loaded without adjusting the paper length guide and paper width guide, the paper may skew or become jammed.

4 Gently push the cassette back in.

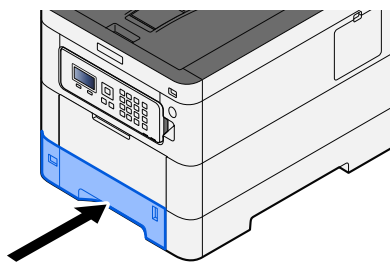



NOTE

There is a paper gauge on the right side of the front of the cassette. The display changes up and down to match the remaining amount of paper.

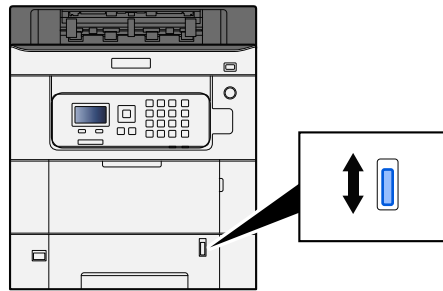

5 Specify the type of paper loaded in the cassette using the operation panel.

→ [Specifying Paper Size and Media Type \(page 99\)](#)

When loading paper in the multipurpose tray

1 Open the multipurpose tray.

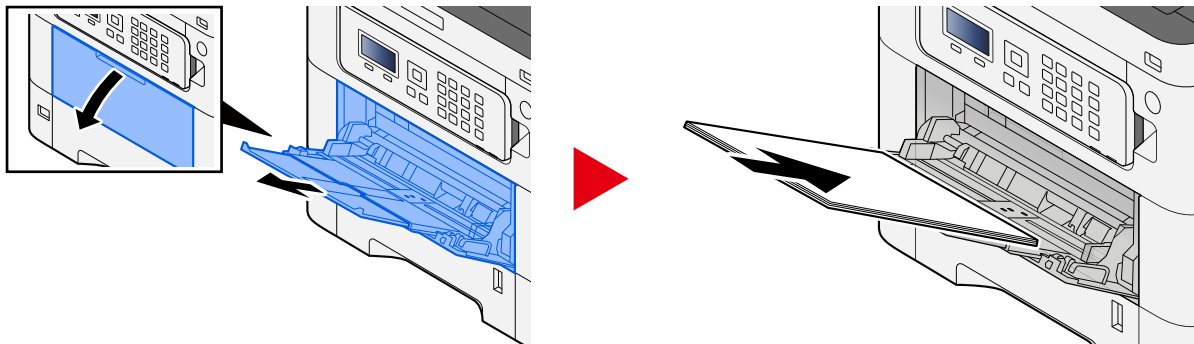

2 Adjust the multipurpose tray size.

Paper sizes are marked on the multipurpose tray.

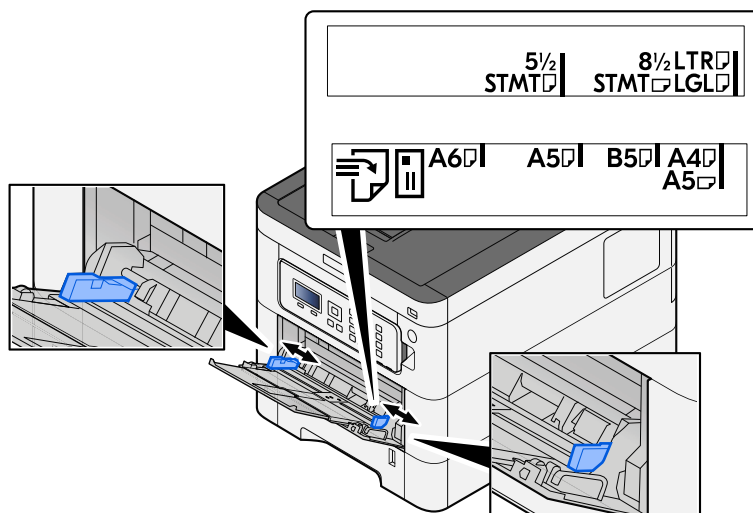

3 Load paper.

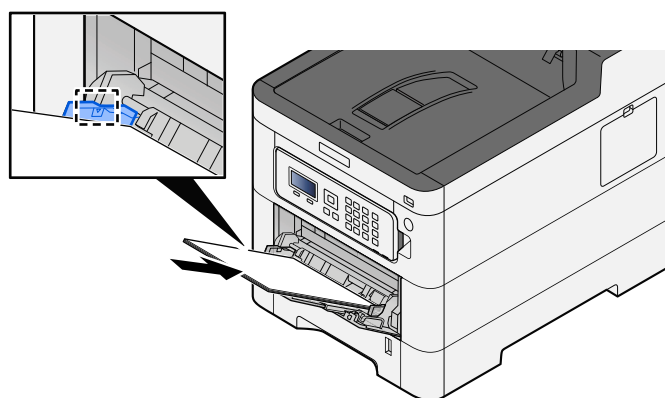

Insert the paper along the paper width guides into the tray until it stops.

After removing new paper from its packaging, fan the paper before loading it in the multipurpose tray.

➔ [Precaution for Loading Paper \(page 90\)](#)

✔ IMPORTANT

- When loading the paper, keep the print side facing up.
- Curled paper must be uncurled before use.
- When loading paper into the multipurpose tray, check that there is no paper left over in the tray from a previous job before loading the paper. If there is just a small amount of paper left over in the multipurpose tray and you want to add more, first remove the left-over paper from the tray and include it with the new paper before loading the paper back into the tray.
- If there is a gap between the paper and the paper width guides, readjust the guides to fit the paper in order to prevent skewed feeding and paper jams.
- Ensure that the loaded paper does not exceed the load limits.

When you load envelopes or cardstock in the multipurpose tray, load the paper with the print side facing up. For the procedure for printing, refer to the Printer Driver User Guide.

➔ [Printer Driver User Guide](#)

Example: When printing the address.

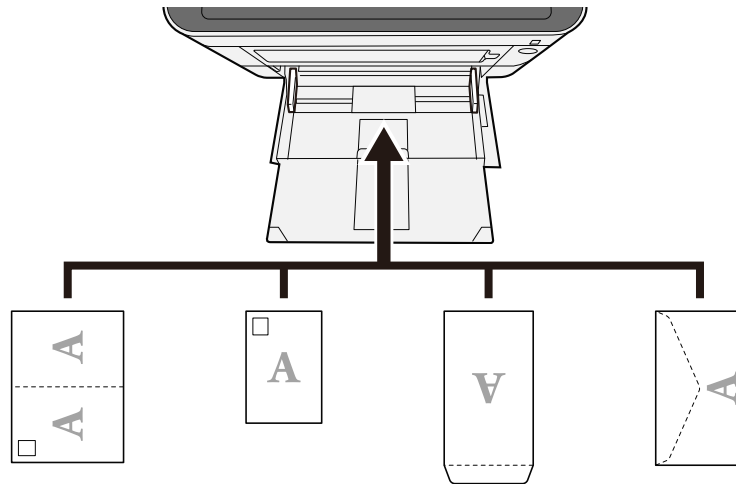

IMPORTANT

- Use unfolded Oufuku hagaki (Return postcard).
- How to load envelopes (orientation and facing) will differ depending on the type of envelope. Be sure to load it in correctly, otherwise printing may be done in the wrong direction or on the wrong face.

NOTE

When you load envelopes in the multipurpose tray, select the envelope type by referring to the following:

➔ [MP Tray Set. \(page 188\)](#)

4 Specify the type of paper loaded in the multipurpose tray using the operation panel.

➔ [Specifying Paper Size and Media Type \(page 99\)](#)

Remove the paper from the cassette once and change the loading direction by rotating the paper 180 degrees.

➔ [Precaution for Loading Paper \(page 90\)](#)

Is the paper damp?

Replace the paper with new paper.

➔ [Precaution for Loading Paper \(page 90\)](#)

Printouts are curled



Is the paper loaded correctly?

Load the paper correctly.

When loading paper in a cassette

1 Pull the cassette completely out of the machine.

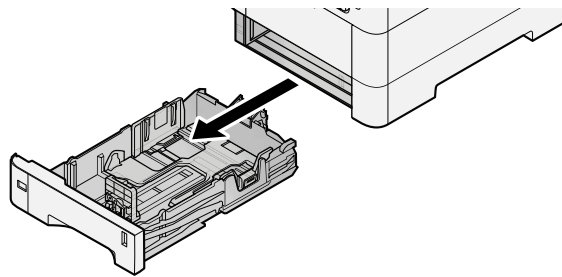

NOTE

When pulling the cassette out of the machine, ensure it is supported and does not fall out.

2 Adjust the cassette size.

- 1 Adjust the position of the paper width guides located on the left and right sides of the cassette. Press the paper width adjusting tab and slide the guides to the paper size required.

Paper sizes are marked on the cassette.

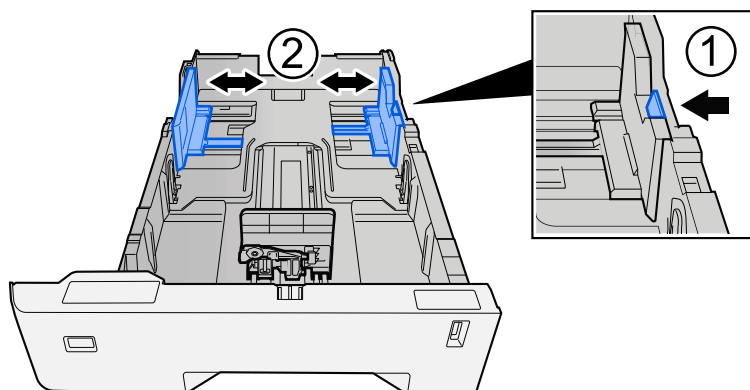

- 2 Adjust the paper length guide to the paper size required. Press the paper length adjusting tab and slide the guides to the paper size required.

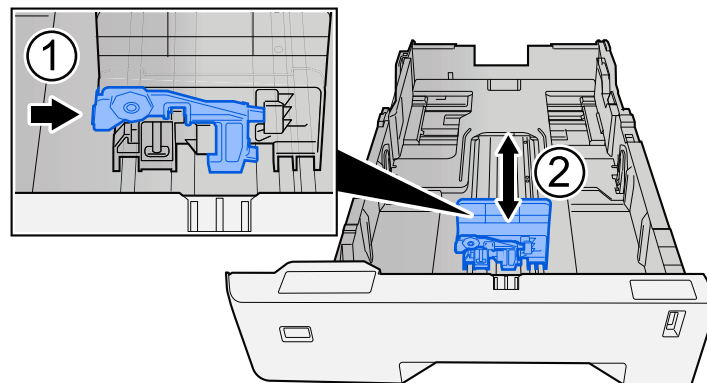

- 3 Turn the size dial so that the size of the paper you are going to use appears in the paper size window.

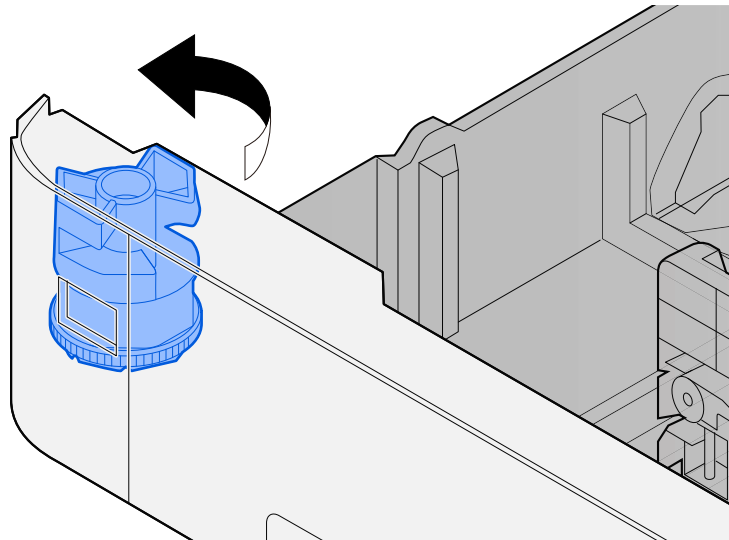

NOTE

Set the size dial to Other if you wish to use paper that is other than the Standard Size. In this case, it is necessary to set the paper size from the operation panel.

➔ [Specifying Paper Size and Media Type \(page 99\)](#)

3 Load paper.

- 1 Fan the paper, then tap it on a level surface to avoid paper jams or skewed printing.

2 Load the paper in the cassette.

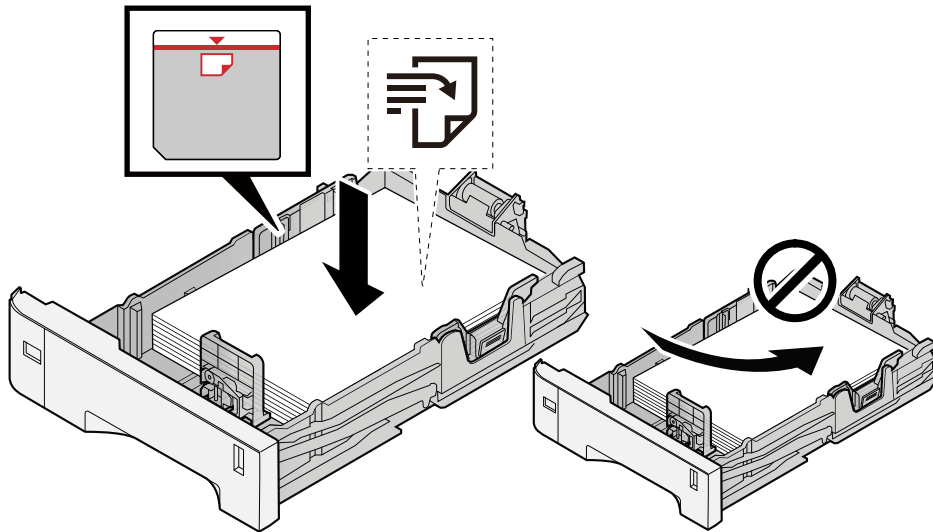

✔ **IMPORTANT**

- Load the paper with the print side facing up.
- After removing new paper from its packaging, fan out the paper before loading it in the cassettes.
➔ [Precaution for Loading Paper \(page 90\)](#)
- Before loading the paper, be sure that it is not curled or folded. Paper that is curled or folded may cause paper jams.
- Ensure that the loaded paper does not exceed the level indicator (see illustration above).
- If paper is loaded without adjusting the paper length guide and paper width guide, the paper may skew or become jammed.

4 Gently push the cassette back in.

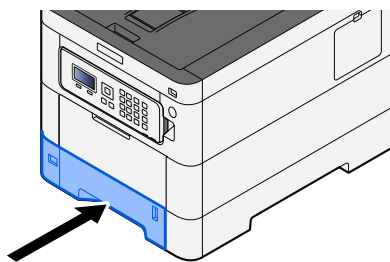



NOTE

There is a paper gauge on the right side of the front of the cassette. The display changes up and down to match the remaining amount of paper.

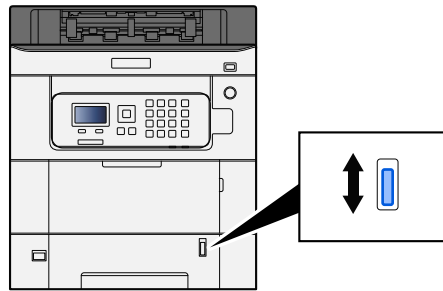

5 Specify the type of paper loaded in the cassette using the operation panel.

→ [Specifying Paper Size and Media Type \(page 99\)](#)

When loading paper in the multipurpose tray

1 Open the multipurpose tray.

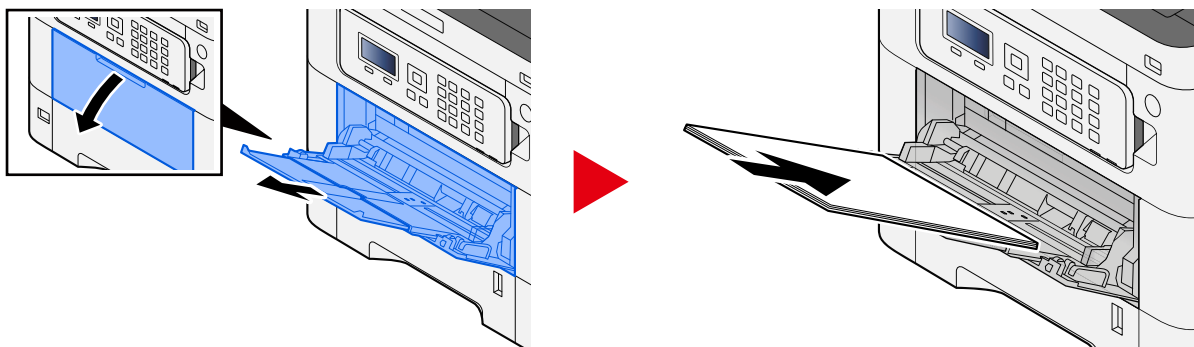

2 Adjust the multipurpose tray size.

Paper sizes are marked on the multipurpose tray.

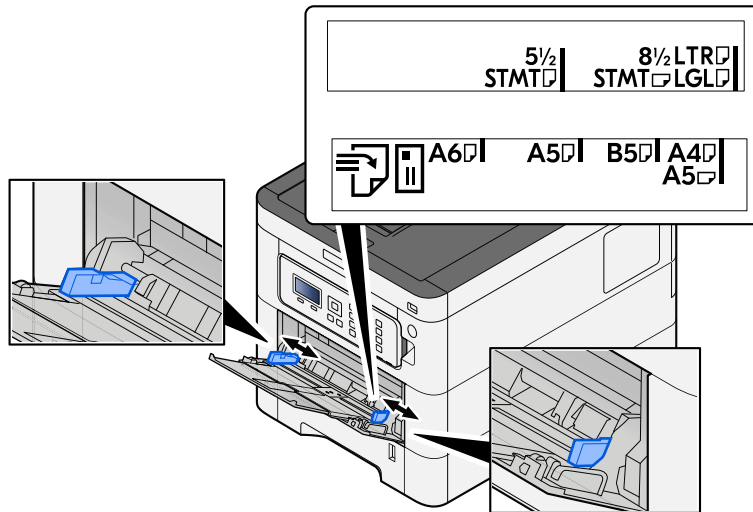

3 Load paper.

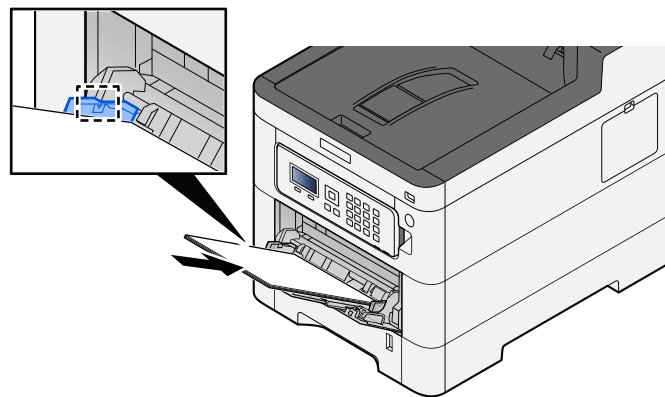

Insert the paper along the paper width guides into the tray until it stops.

After removing new paper from its packaging, fan the paper before loading it in the multipurpose tray.

➔ [Precaution for Loading Paper \(page 90\)](#)

✔ IMPORTANT

- When loading the paper, keep the print side facing up.
- Curled paper must be uncurled before use.
- When loading paper into the multipurpose tray, check that there is no paper left over in the tray from a previous job before loading the paper. If there is just a small amount of paper left over in the multipurpose tray and you want to add more, first remove the left-over paper from the tray and include it with the new paper before loading the paper back into the tray.
- If there is a gap between the paper and the paper width guides, readjust the guides to fit the paper in order to prevent skewed feeding and paper jams.
- Ensure that the loaded paper does not exceed the load limits.

When you load envelopes or cardstock in the multipurpose tray, load the paper with the print side facing up. For the procedure for printing, refer to the Printer Driver User Guide.

➔ [Printer Driver User Guide](#)

Example: When printing the address.

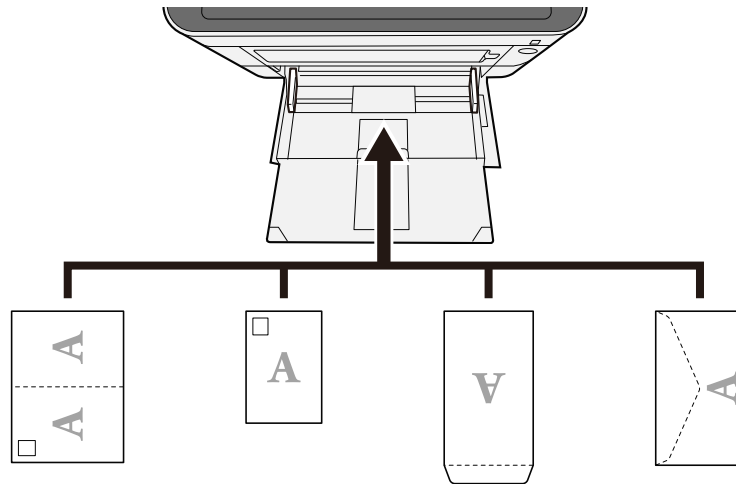

IMPORTANT

- Use unfolded Oufuku hagaki (Return postcard).
- How to load envelopes (orientation and facing) will differ depending on the type of envelope. Be sure to load it in correctly, otherwise printing may be done in the wrong direction or on the wrong face.

NOTE

When you load envelopes in the multipurpose tray, select the envelope type by referring to the following:

➔ [MP Tray Set. \(page 188\)](#)

4 Specify the type of paper loaded in the multipurpose tray using the operation panel.

➔ [Specifying Paper Size and Media Type \(page 99\)](#)

Remove the paper from the cassette once and reload the paper upside-down or change the loading direction by rotating the paper 180 degrees.

➔ [Precaution for Loading Paper \(page 90\)](#)

Is the paper damp?

Replace the paper with new paper.

Printer driver cannot be installed

Is the driver installed with the host name while Wi-Fi or Wi-Fi Direct function is available?

Specify the IP address instead of the host name.

→ [Installing Software \(page 59\)](#)

Is Level 3 selected in Security Quick Setup?

- 1** Acquire a root certificate for SSL communication from a trusted root certification authority. In Command Center RX, click [Security Settings] > [Certificates], and register the root certificate in [Root Certificate 1] to [Root Certificate 5].
- 2** After installing the certificate, restart the PC.
- 3** In Command Center RX, click [Network Settings] > [Protocols], and in [Other Protocols], set "SNMPv3" to [On].
- 4** In Command Center RX, click [Management Settings] > [SNMP], and set "SNMPv3".
- 5** Access the [Control Panel], then select [Devices and Printers], [Add a printer], and [The printer that I want isn't listed].
- 6** Check [Select a shared printer by name], and enter the address of the printer.
E.g.: https://hostname:443/printers/lp1
- 7** Select the desired printer and specify the printer driver.

Cannot start printing

Is the machine plugged in?

Plug the power cord into an AC outlet.

Is the power turned on?

Turn the power switch on.

1 Turn the power switch on.

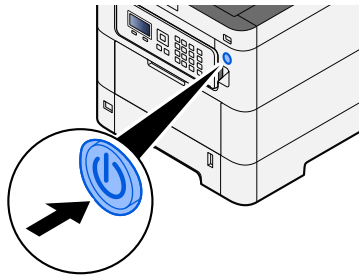

✔ IMPORTANT

When turning off the power switch, do not turn on the power switch again immediately. Wait more than 5 seconds, and then turn on the power switch.

Are the USB cable and network cable connected?

Make sure to connect the USB cable and network cable securely.

Connect the network cable

✔ IMPORTANT

If the power is on, turn the power switch off.

➔ [Power off \(page 36\)](#)

1 Connect the cable to the machine.

- 1 Connect the LAN cable to the network interface connector.

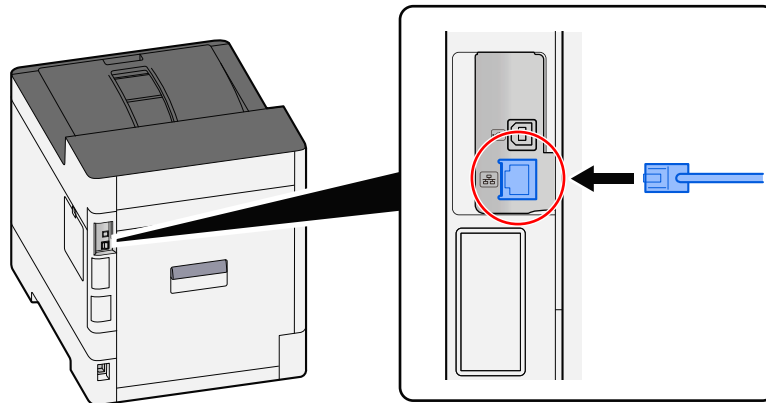

- 2 Connect the other end of the cable to the hub.

2 Power on the machine and configure the network.

- [Network Setup \(page 45\)](#)

Connect a USB cable to the machine.

✔ IMPORTANT

If the power is on, turn the power switch off.

- [Power off \(page 36\)](#)

1 Connect the cable to the machine.

- 1 Connect the USB cable to the USB interface connector.

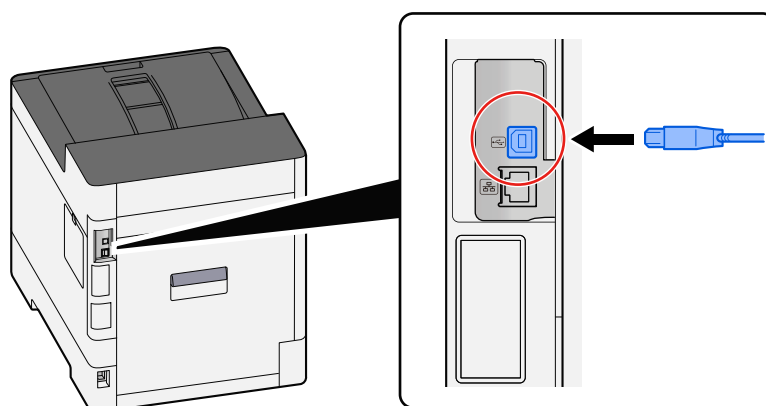

- 2 Connect the other end of the cable to the PC.

2 Power on the machine.

Are there a mixture of inaccessible addresses?

If you have configured wired and Wi-Fi networks with name resolution, you may have a mix of IP addresses (private addresses) on the other inaccessible network.

IMPORTANT

Only one host name and one domain name can be used on this machine. Please consider this limitation when setting the network operation.

1 [Menu] key > [▲] [▼] key > [Network] > [OK] key > [▲] [▼] key > [Primary Network]

Select Wi-Fi, Wired or Optional Network as the network to use without restrictions.

➔ [Primary Network \(page 219\)](#)

2 [Menu] key > [▲] [▼] key > [Network] > [OK] key > [▲] [▼] key > [ProtocolSettings]

Please [Enable] either [Wired Network] or [Wi-Fi] and [Disable] the other.

➔ [ProtocolSettings \(page 212\)](#)

3 In Command Center RX, change the settings for name resolution of NetBEUI, DNS, etc., or change the network environment settings.

➔ [Command Center RX User Guide](#)

Cannot print with USB drive / Does not recognize USB drive

Is the USB drive connected to the machine firmly?

Connect the USB drive firmly to the machine.

Are USB host settings set to [Block]?

1 Change the USB host setting to [Unblock]

[Menu] key > [▲][▼] key > [Security] > [OK] key > [▲][▼] key > [I/F Block Set.] > [OK] key

➔ [I/F Block Set. \(page 238\)](#)

Is the USB drive broken?

Use another USB drive.

While [Auto-IP] is already set to [On], the IP address is not assigned automatically

Is a value other than "0.0.0.0" entered for the link local address of TCP/IP(v4)?

1 Enter "0.0.0.0" in IP Address of TCP/IP(v4).

1 [Menu] key > [▲][▼] key > [Network] > [OK] key > [▲][▼] key > [Wired Netwk. Set] > [OK] key > [▲][▼] key > [TCP/IP Settings] > [OK] key > [▲][▼] key > [IPv4 Setting] > [OK] key

2 Enter "0.0.0.0" in IP Address.

➔ [TCP/IP \(IPv4\) setting \(page 46\)](#)

The machine is emitting steam in the area around the paper ejection slot

Is the temperature in the room where the machine is running low? Or was damp paper used?

Depending on the machine's printing environment and the condition of the paper, the moist contained in the paper may evaporate due to the heat generated during printing, and the water vapor emitted may look like smoke.

There is no problem, and you can continue printing. If the steam concerns you, raise the room temperature or replace the paper with a new dryer paper.

Printed Image Trouble

Printouts are totally too light

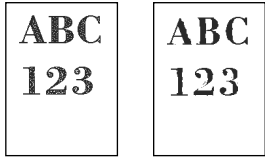

Is the paper damp?

Replace the paper with new paper.

Is the media type set correctly?

Check if the media type setting is correct.

- 1 [Menu] key > [▲][▼] key > [Paper Settings] > [OK] key > [▲][▼] key > [Media Type Set.] > [OK] key
- 2 Check the weight (paper thickness) for the paper type and change it to the correct value
→ [Media Type Set. \(page 191\)](#)

Have you set EcoPrint?

Set [EcoPrint] to [Off].

- 1 [Menu] key > [▲][▼] key > [Print Settings] > [OK] key > [▲][▼] key > [Print Quality] > [OK] key
- 2 [EcoPrint] > [Off]

Color adjustment needs to be performed.

- 1 Display the screen.
 - 1 [Menu] key > [▲][▼] key > [Adjust/Maint.] > [OK] key > [▲][▼] key > [Image Adjustment] > [OK] key
- 2 Perform the color adjustment.
 - 1 Select [ColorCalibration], and then select [Start].
Color adjustment begins.

Developer refresh needs to be performed.

1 Display the screen.

- 1 [Menu] key > [▲][▼] key > [Adjust/Maint.] > [OK] key > [▲][▼] key > [Image Adjustment] > [OK] key

2 Perform the Developer Refresh.

- 1 Select [DeveloperRefresh], then select [Start].
Developer Refresh begins.



NOTE

Waiting time may be longer when the toner is refilled during developer refresh.

Laser scanner cleaning needs to be performed.

1 Display the screen.

- 1 [Menu] key > [▲][▼] key > [Adjust/Maint.] > [OK] key > [▲][▼] key > [Image Adjustment] > [OK] key

2 Perform the Laser Scanner Cleaning.

- 1 Select [LSU], then select [Start].
Laser Scanner Cleaning begins.

Printed images are fuzzy or cut off

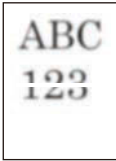

Are you using the machine in a place with high humidity or drastic temperature and humidity fluctuations?

Use the machine in an environment with appropriate humidity.

Drum refresh needs to be performed.

1 Display the screen.

1 [Menu] key > [▲] [▼] key > [Adjust/Maint.] > [OK] key > [▲] [▼] key > [Image Adjustment] > [OK] key

2 Perform the Rrum Refresh.

1 Select [Drum], then select [Start].

Drum Refresh begins.

Printed images are shifted



Is the paper loaded correctly?

Adjust the paper length guide and width guide of the cassette to fit the paper size.

➔ [Loading in the Cassettes \(page 92\)](#)

The altitude is 1000 m or higher and irregular horizontal white lines appear in the image.



- 1 Select the [Menu] key > [▲][▼]key > [Adjustment/Maintenance] > [OK] key > [▲][▼] key > [Service Settings] > [OK] key > [▲][▼] key > [Altitude Adj.] > [OK] key , and set to an elevation one level higher than the current setting.

The altitude is 1000 m or higher and dots appear in the image.



- 1 Select the [Menu] key > [▲][▼] key > [Adjustment/Maintenance] > [OK] key > [▲][▼] key > [Service Settings] > [OK] key > [▲][▼] key > [Altitude Adj.] > [OK] key , and set to an elevation one level higher than the current setting.

Printed images have vertical lines

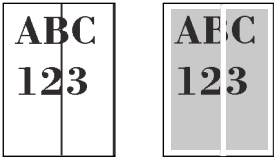

Laser scanner cleaning needs to be performed.

1 Display the screen.

- 1 [Menu] key > [▲][▼] key > [Adjust/Maint.] > [OK] key > [▲][▼] key > [Image Adjustment] > [OK] key

2 Perform the Laser Scanner Cleaning.

- 1 Select [LSU], then select [Start].
Laser Scanner Cleaning begins.

Dirt on the top edge or back of the paper

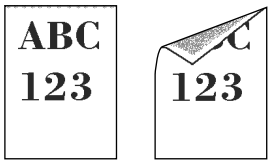

Is the inside of the machine dirty?

Open the Rear Cover 1, and if the inside of the Machine is dirty with toner or the like, wipe it off with a soft, dry cloth.

Part of the image is periodically faint or shows white lines



Is the Rear Cover 1 tightly closed?

Open the Rear Cover 1 and close it again.

Drum refresh needs to be performed.

1 Display the screen.

1 [Menu] key > [▲] [▼] key > [Adjust/Maint.] > [OK] key > [▲] [▼] key > [Image Adjustment] > [OK] key

2 Perform the Rrum Refresh.

1 Select [Drum], then select [Start].
Drum Refresh begins.

Developer refresh needs to be performed.

1 Display the screen.

1 [Menu] key > [▲] [▼] key > [Adjust/Maint.] > [OK] key > [▲] [▼] key > [Image Adjustment] > [OK] key

2 Perform the Developer Refresh.

1 Select [DeveloperRefresh], then select [Start].
Developer Refresh begins.



NOTE

Waiting time may be longer when the toner is refilled during developer refresh.

A lighter version of the previous image remains and is repeatedly printed



The GS settings need to be adjusted.

1 Configure the settings for GS.

- 1 Select the [Menu] key > [▲][▼] key > [Adjust/Maint.] > [OK] key > [▲][▼] key > [Service Setting] > [OK] key > [▲][▼] key > [GS] > [OK] key.

Increase the value one level from the current value.

- 2 Select the [Menu] key > [▲][▼] key > [Adjust/Maint.] > [OK] key > [▲][▼] key > [Image Adjustment] > [OK] key.

Perform only calibration.

- 3 Print a document and confirm the image quality.

Increase the value until the image is improved.



NOTE

If there is still no improvement, return the setting to the original value.

2 If white dots appear in the improved image, decrease the value by one level.

3 If the white background of the improved image appears colored, proceed to the next step. If there is no unnecessary coloring, finish editing.

4 Configure the settings for MC.

- 1 Select the [Menu] key > [▲][▼] key > [Adjust/Maint.] > [OK] key > [▲][▼] key > [Service Setting] > [OK] key > [▲][▼] key > [MC] > [OK] key.

Increase the value one level from the current value.

- 2 Select the [Menu] key > [▲][▼] key > [Adjust/Maint.] > [OK] key > [▲][▼] key > [Image Adjustment] > [OK] key.

Perform only calibration.

- 3 Print the document and confirm the image quality.

Increase the value until the image is improved.



NOTE

If there is still no improvement, return the setting to the original value.

- 5** If white dots or color dots appear in the improved image, decrease the value by one level.

Color Printing Trouble

Color drift occur



Color adjustment needs to be performed.

1 Display the screen.

- 1 [Menu] key > [▲][▼] key > [Adjust/Maint.] > [OK] key > [▲][▼] key > [Image Adjustment] > [OK] key

2 Perform the color adjustment.

- 1 Select [ColorCalibration], and then select [Start].
Color adjustment begins.

Color registration (standard correction) needs to be performed.

If standard registration does not resolve the problem or to perform more detailed settings, use the detailed registration.

✔ IMPORTANT

Before performing color registration, be sure to perform Color Adjustment. If color drift remains, perform color registration. By performing color registration without performing Color Adjustment, the color drift will be resolved once, however, it may cause the serious color drift later.

See the table below regarding Color Adjustment.

➔ [Color Adjustment \(page 357\)](#)

1 Load paper.

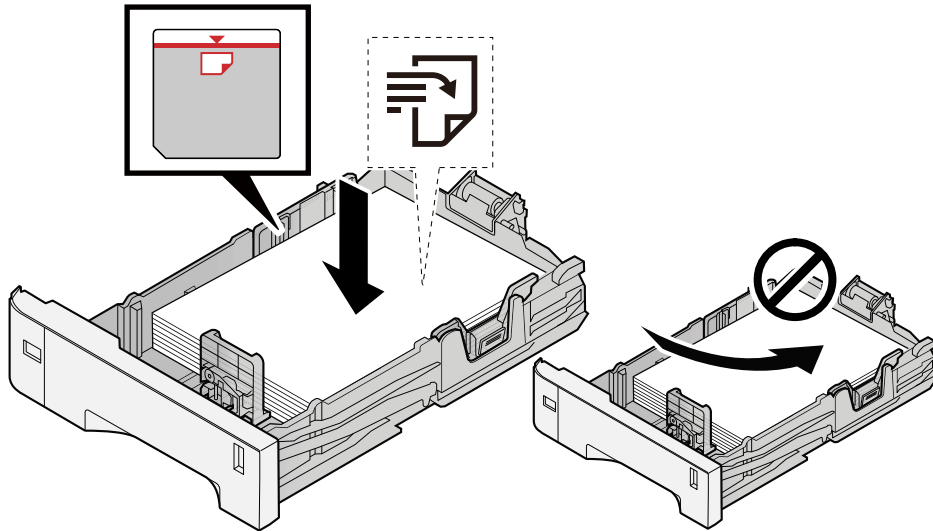

✔ IMPORTANT

- Load the paper with the print side facing up.
- After removing new paper from its packaging, fan out the paper before loading it in the cassettes.
➔ [Precaution for Loading Paper \(page 90\)](#)
- Before loading the paper, be sure that it is not curled or folded. Paper that is curled or folded may cause paper jams.
- Ensure that the loaded paper does not exceed the level indicator (see illustration above).
- If paper is loaded without adjusting the paper length guide and paper width guide, the paper may skew or become jammed.

2 Display the screen.

[Menu] key > [▲][▼] key > [Adjust/Maint.] > [OK] key > [▲][▼] key > [Color Regist.] > [OK] key > [▲][▼] key > [Normal] > [OK] key

3 Print the chart.

[▲][▼] key > [Print Chart] > [OK] key > [Yes]

A chart is printed. Three types of charts are printed on a single sheet of paper for the three colors M (Magenta), C (Cyan), and Y (Yellow): H-L (Left), V (Center), and H-R (Right).

After printing, return to the Color Printing Position Correction Standard menu.

Chart Example

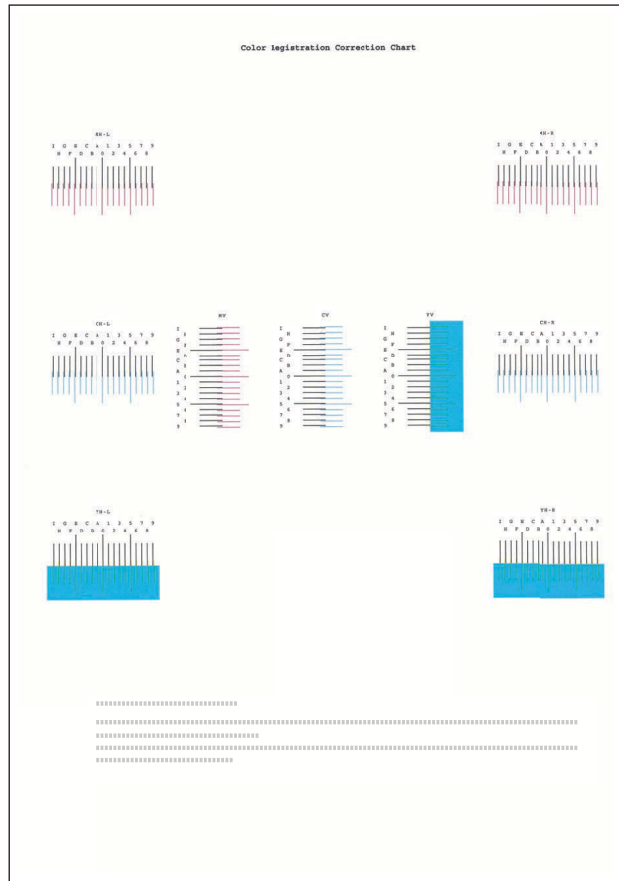

4 Displays the Correction menu.

[▲][▼] key > [Adjust Magenta] > [OK] key

The Magenta Correction menu is displayed.

5 Enter the appropriate value.

- 1 Find the location on each chart where 2 lines most closely match. If this is the 0 position, registration for that color is not required. For the illustration, B is the appropriate value.

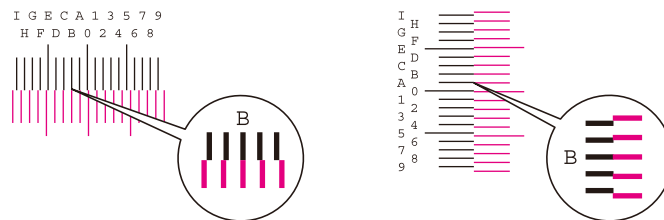

- 2 Select [◀] or the [▶] key and change items H-L, V and H-R, select [▲] or the [▼] key, input values loaded from the chart, and select the [OK] key.

Correct the Magenta, and after a short while, return to the Color Printing Position Correction Standard menu.

Select the [▲] key to advance the value from 0 to 9. Select the [▼] key to go in the opposite direction.

Select the [▼] key to change the value from 0 to the alphabet and from A to I. Select the [▲] key to go in the opposite direction.

It is not possible to enter values with the numeric keypad.

- 3 Repeat steps 3-4 to correct Cyan and Yellow.

Color registration (detailed correction) needs to be performed.

1 Load paper.

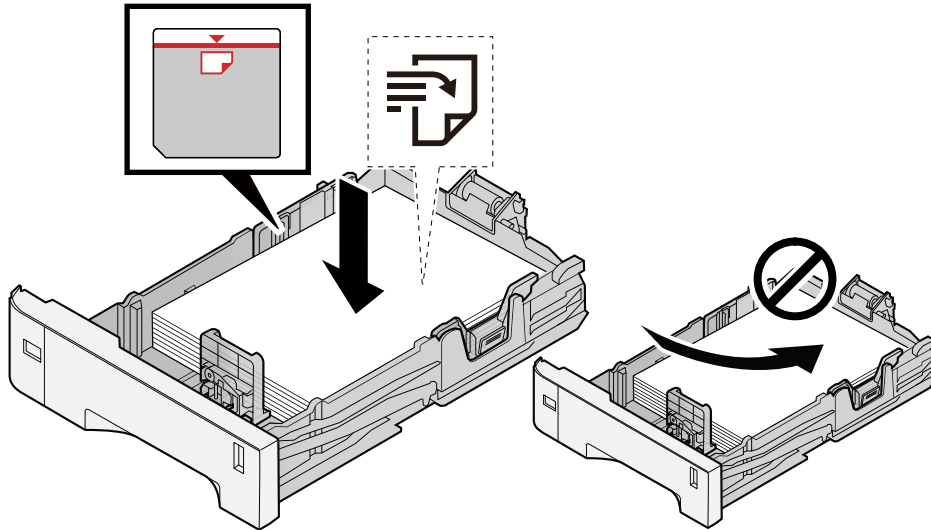

✔ IMPORTANT

- Load the paper with the print side facing up.
- After removing new paper from its packaging, fan out the paper before loading it in the cassettes.
→ [Precaution for Loading Paper \(page 90\)](#)
- Before loading the paper, be sure that it is not curled or folded. Paper that is curled or folded may cause paper jams.
- Ensure that the loaded paper does not exceed the level indicator (see illustration above).
- If paper is loaded without adjusting the paper length guide and paper width guide, the paper may skew or become jammed.

2 Display the screen.

[Menu] key > [▲][▼] key > [Adjust/Maint.] > [OK] key > [▲][▼] key > [Color Regist.] > [OK] key > [▲][▼] key > [Detail] > [OK] key

3 Print the chart.

[▲][▼] key > [Print Chart] > [OK] key > [Yes]

A chart is printed. On the chart, for each of M (magenta), C (cyan) and Y (yellow), charts for H-1 to 5 and V-1 to 5 are printed.

After printing, return to the Color Printing Position Correction Details menu.

Chart Example

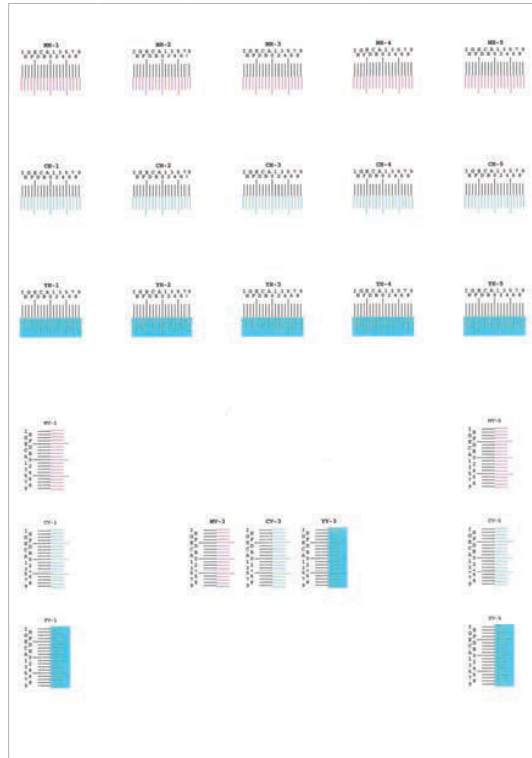

4 Displays the Correction menu.

[▲][▼] key > [Adjust Magenta] > [OK] key

The Magenta Correction menu is displayed.

5 Enter the appropriate value.

- 1 Find the location on each chart where 2 lines most closely match. If this is the 0 position, registration for that color is not required. For the illustration, B is the appropriate value.

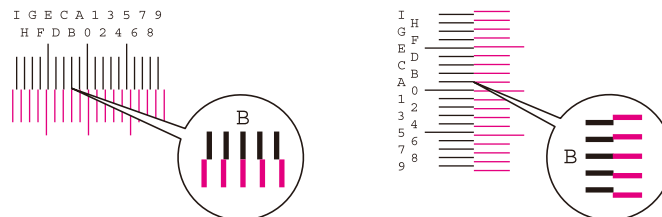

From charts H-1 to H-5, read the values from H-1 to H-5.

From charts V-1 to V-5, read only the values from V-3 (center).

- 2 Select the [◀] or the [▶] key and change items H-1 to H-5 and V-3, then select the [▲] or the [▼] key, input values loaded from the chart, and select the [OK] key.

Correct the Magenta, and after a short while, return to the Color Printing Position Correction Procedure Detail menu.

Select the [▲] key to advance the value from 0 to 9. Select the [▼] key to go in the opposite direction.

Select the [▼] key to change the value from 0 to the alphabet and from A to I. Select the [▲] key to go in the opposite direction.

It is not possible to enter values with the numeric keypad.

- 3 Repeat steps 3-4 to correct Cyan and Yellow.

Colors appear different than you anticipated

Is color copy paper set in the paper source?

Set the color copy paper.

Color adjustment needs to be performed.

1 Display the screen.

1 [Menu] key > [▲][▼] key > [Adjust/Maint.] > [OK] key > [▲][▼] key > [Image Adjustment] > [OK] key

2 Perform the color adjustment.

1 Select [ColorCalibration], and then select [Start].

Color adjustment begins.

Is the color adjustment appropriate?

Adjust the color with the printer driver.

➔ [Printer Driver User Guide](#)

The color toner is empty

If you want to continue printing in black and white, follow these steps:

Black and white printing is possible temporarily.

- 1 [Menu] key > [▲][▼] key > [Device Common] > [OK] key > [▲][▼] key > [ColorToner Empty] > [OK] key
- 2 [ColorToner Empty] > [Print in B & W]



NOTE

This setting is not valid when the optional Fiery Controller is installed.

Remote Operation

This function enables the system administrator to explain how to operate the panel and troubleshoot to user, by accessing operation panel of the machine at remote using browser and VNC software.

Executing Remote Operation from Browser

The supported Browser is as follows. We recommend the latest version of browser to use Remote Operation.

- Google Chrome (Version 21.0 or later)
- Microsoft Edge
- Mozilla Firefox (Version 14.0 or later)
- Safari (Version 5.0 or later)

This section describes the procedure for performing remote operations from Command Center RX using Google Chrome.



NOTE

To execute Remote Operation using other browsers, refer to the following:

➔ [Command Center RX User Guide](#)

1 Display the screen

- 1 [Menu] key > [▲][▼] key > [Network] > [OK] key > [▲][▼] key > [ProtocolSettings] > [OK] key

2 Set [EnhncdVNC ov TLS] to On.

➔ [ProtocolSettings \(page 212\)](#)



NOTE

You can configure the protocol settings using Command Center RX.

➔ [Command Center RX User Guide](#)

3 Configure settings for remote operation.

1 [Menu] key > [▲][▼] key > [Network] > [OK] key > [▲][▼] key > [Remote Operation] > [OK] key > [▲][▼] key > [Off/On] > [OK] key > [▲][▼] key > [On] > [OK] key

2 [▲][▼] key > [Use Restriction] > [OK] key > [▲][▼] key > [Off], select [Use Password] or [Admin. Only] > [OK] key

When you select [Use Password], enter the password in "Password" and "Confirm Password", then select [OK].

→ [Remote Operation \(page 221\)](#)



NOTE

You can configure settings for remote operation using Command Center RX.

→ [Command Center RX User Guide](#)

4 Restart the machine.

→ [Restart \(page 246\)](#)

5 Start up the browser.

Specify https:// [Host name of this Machine] and start Command Center RX.

→ [Accessing Command Center RX \(page 78\)](#)

6 [Device Information / Remote Operation] > [Remote Operation]

7 Click [Start].



NOTE

- If the user is logged in to the device, the permission confirmation screen will be displayed on the operation panel. Select [Yes].
- If pop-up blocking of the browser occurs during connection of the Remote Operation, select Always allow pop-ups from https:// [host name], and click [Completed]. Perform [Start] after waiting 1 minute or more.

When the Remote Operation is started up, the operation panel screen will be displayed on the system administrator's or user's PC screen.

Executing Remote Operation from VNC Software

1 Display the screen

1 [Menu] key > [▲][▼] key > [Network] > [OK] key > [▲][▼] key > [ProtocolSettings] > [OK] key

2 Set "Enhanced VNC (RFB)" to On.

→ [ProtocolSettings \(page 212\)](#)



NOTE

- If "VNC (RFB) over TLS" is set to On, the communication is encrypted.
- You can configure the protocol settings using Command Center RX.

➔ **Command Center RX User Guide**

3 Startup the remote operation.

- 1 Start up the VNC software.
- 2 Enter the following format separated by a colon to start up the remote operation.
"IP address: port number"



NOTE

When setting "VNC (RFB)" to On in step 2, the default port number is 9062. When "VNC (RFB) over TLS" is set to On, the default port number is 9063.

➔ [ProtocolSettings \(page 212\)](#)

Responding to Messages

If the touch panel or the computer displays any of these messages, follow the corresponding procedure.

NOTE

When contacting us, the serial number will be necessary. To check the serial number, refer to the following:

➔ [Checking the Equipment's Serial Number \(page 2\)](#)

"Access point was not detected." is displayed

Check if the access point has been set correctly.

"Add paper to cassette #." is displayed

Is the indicated paper source out of paper?

Replenish the paper.

To print with paper from another paper source, select [Alt.]. To print with the selected paper, select [OK] or [Continue].

To cancel the job, select [Cancel].

"Load paper in MP tray." is displayed

Does the paper source paper size setting not match the actual paper size that is fed?

There is no paper in the multipurpose tray that matches the print data. Set the paper. Select [OK] to resume printing.

To print from the other paper source, selecting [Alt.] will display [Alternative] and you can change the paper source. Select [Continue] to print without changing the paper source.

To cancel the job, select [Cancel].

"Box limit exceeded." is displayed

Jobs cannot be saved because the specified box is full. The job will be canceled.

Print or delete the original in the box, and then try again.

 **NOTE**

If Auto Error Clear is set to [On], the process will resume automatically after a set period of time. For details, refer to the following:

➔ [Auto Err. Clear \(page 230\)](#)

"Performing" is displayed

The machine is in adjustment mode to maintain its quality. Please wait.

"Cannot connect to Authentication Server." is displayed

Does the machine time match the server's time?

- Set the machine time to match the server's time
 - ➔ [Setting Date and Time \(page 44\)](#)

Is it properly registered with the authentication server?

- Enable User Login Administration.
 - ➔ [Enable User Login Administration \(page 249\)](#)
- Set the network authentication server.
 - Check the connection status with the server.
 - Confirm that the computer name and password for the authentication server are correct.

Is the machine connected to the network correctly?

- ➔ [Connecting LAN Cable \(page 34\)](#)
- ➔ [Network Setup \(page 45\)](#)

 **NOTE**

If Auto Error Clear is set to [On], the process will resume automatically after a set period of time. For details, refer to the following:

➔ [Auto Err. Clear \(page 230\)](#)

"Cannot connect to the server." is displayed

Check the connection status with the server.

"Cannot connect." is displayed

Wi-Fi or Wi-Fi Direct connection could not be completed.

Select [OK]. Returns to the previous screen.

Check the settings and signal conditions.

➔ [Wi-Fi Direct Set \(page 201\)](#)

➔ [Wi-Fi Settings \(page 202\)](#)

"Cannot duplex print on this paper." is displayed

Have you selected a size or type of paper that cannot be duplex printed?

To select paper that can be printed on both sides, selecting [Alt.] will display [Alternative] and you can change the paper source. Select [Continue] to cancel duplex printing and continue printing.

To cancel the job, select [Cancel] key.

"Cannot perform remote printing." is displayed

Remote printing is prohibited.

The job is canceled. Select [OK].

"No multi copies." is displayed

Only one copy is available.

- Select [OK] to continue printing.
- Select [Cancel] to cancel the job.

"Cannot execute this job. Restricted by Authorization settings." is displayed

Restricted by the authorization settings.

The job is canceled. Select [OK].

Restricted by the job accounting.

The job is canceled. Select [OK].

NOTE

If Auto Error Clear is set to [On], the process will resume automatically after a set period of time. For details, refer to the following:

→ [Auto Err. Clear \(page 230\)](#)

"Cannot read data in this ID Card." is displayed

In registration process, the ID card information was not read correctly.

Hold the IC card over the IC card reader again. If the same message is displayed again, the IC card may not be compatible with this product. Replace it with another IC card.

"Cannot recognize." is displayed

- Check if the USB connector of your IC card reader is correctly connected to the main unit.
- If [USB Host] in [I/F Block Set.] is set to [Block], change it to [Unblock].

"Cannot use the?cassette below due to?a failure." is displayed

To continue as is, select [OK]. If repair is completed, select [Next].

"Shake the toner container." is displayed

Open the top cover and take out the toner container. Shake the toner container well and set it again.

"Color toner is empty. Cannot print this document." is displayed

Replace with the toner container specified by us.

NOTE

If there is still black toner left even after color toner has run out and [ColorToner Empty] is set to [Print in B & W], black and white printing is possible temporarily.

"Account error. Press [OK]." is displayed

Failed to specify Job Accounting when processing the job externally.

The job is canceled. Select [OK].

NOTE

If Auto Error Clear is set to [On], the process will resume automatically after a set period of time. For details, refer to the following:

➔ [Auto Err. Clear \(page 230\)](#)

"Job not stored." is displayed

The job is canceled. Select [OK].

"Incorrect account ID." is displayed

The account ID was incorrect when processing the job externally.

The job is canceled. Select [OK].

"Job Accounting restriction exceeded." is displayed

Is the acceptable printing count restricted by Job Accounting exceeded?

The printing count exceeded the acceptable count restricted by Job Accounting. Cannot print any more.

The job is canceled. Select [OK].

"KPDL error." is displayed

PostScript error has occurred.

The job is canceled. Select [OK].

NOTE

If Auto Error Clear is set to [On], the process will resume automatically after a set period of time. For details, refer to the following:

➔ [Auto Err. Clear \(page 230\)](#)

"Machine failure. Call service." is displayed

Internal error has occurred.

Make a note of the error code displayed on the screen and contact service representative.

"Memory is full." is displayed

The memory is full and the job cannot be continued.

Select [OK]. The job is canceled. When insufficient memory occurred frequently, contact your dealer or service representative.

NOTE

If Auto Error Clear is set to [On], the process will resume automatically after a set period of time. For details, refer to the following:

➔ [Auto Err. Clear \(page 230\)](#)

"Paper jammed in Cassette #." is displayed

A paper jam has occurred.

If a paper jam occurs, the machine will stop and the location of the jam will be indicated on the screen. Leave the machine on and follow the instructions to remove the jammed paper.

➔ [Jam Location Indicators \(page 362\)](#)

"Refreshing drum..." is displayed

The machine is in adjustment mode to maintain quality.

Please wait.

"Please wait. Regulating the temperature..." is displayed

The machine is in adjustment mode to maintain quality.

Please wait.

"Overwriting." is displayed

You can overwrite the unnecessary data that remains on the SSD automatically. Please wait.

"SSD error." is displayed

An error has occurred on the SSD.

The job is canceled. Select [OK].

The following error code is displayed:

- 01: The amount of data that can be saved at once has been exceeded. Restart the system or turn the power OFF/ON. If the error still occurs, divide the file into smaller files.
If the error still persists, the SSD is damaged. Execute [Initialization].
- 04: Insufficient space remaining on SSD. Move data or delete unneeded data.



NOTE

Please note that the data stored on the SSD will be deleted when system initialization is performed.

"Error occurred." is displayed

System error has occurred.

Follow the instruction displayed on the screen.

"The device cannot be connected because allowed connections would be exceeded." is displayed

Are you connecting more than the maximum number of Wi-Fi Direct connections?

The job is canceled. Select [OK]. Disconnect the devices that you are not using, or set the [Disconnect Timer] of this unit to disconnect the devices.

➔ [Wi-Fi Direct Set \(page 201\)](#)

"MaliciousPRG detected Delete the program. Contact the admin." is displayed

Execution was aborted due to a possible malware program.

Please contact the administrator.

"RAM disk error." is displayed

A RAM disk error has occurred.

Select [OK].

The following error code is possible:

04: There is not enough free space on the RAM disk. If the optional RAM disk is installed, increase the RAM disk size by using [RAM Disk Setting] in the System Menu.

➔ [RAM Disk Setting \(page 226\)](#)

"Replace MK." is displayed

Contact your service representative

The maintenance kit needs to be replaced.

For ECOSYS PA4500cx

The maintenance kit needs to be replaced at every 300,000 pages of printing.

For ECOSYS PA4000cx/ECOSYS PA3500cx

The maintenance kit needs to be replaced at every 200,000 pages of printing.

"Replace XXXXX" is displayed

Contact your service representative.

After replacing the parts, follow the steps below:

- 1 [Menu]key > [▲][▼]key > [Adjust/Maint.] > [OK]key > [▲][▼]key > [Maint(Cass1)] to [Maint(Cass5)] > [OK]key

"Replace the toner. [C][M][Y][K]" is displayed

Replace the toner container to our specified toner container.

NOTE

If there is still black toner left even after color toner has run out and [ColorToner Empty] is set to [Print in B & W], black and white printing is possible temporarily.

CAUTION

Do not attempt to incinerate parts which contain toner. Dangerous sparks may cause burns.

Installation procedures of the toner container is same for every color. Here, we'll explain the procedures for the yellow toner container, as an example.

- 1 **Open the top cover.**

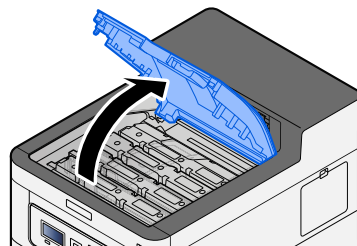

2 Remove the toner container.

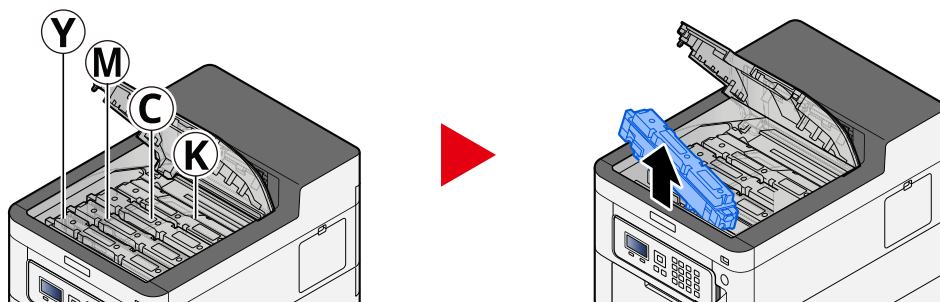

3 Put used toner container into the plastic waste bag.

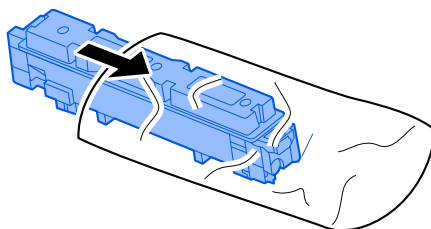

4 Remove the new toner container from the box.

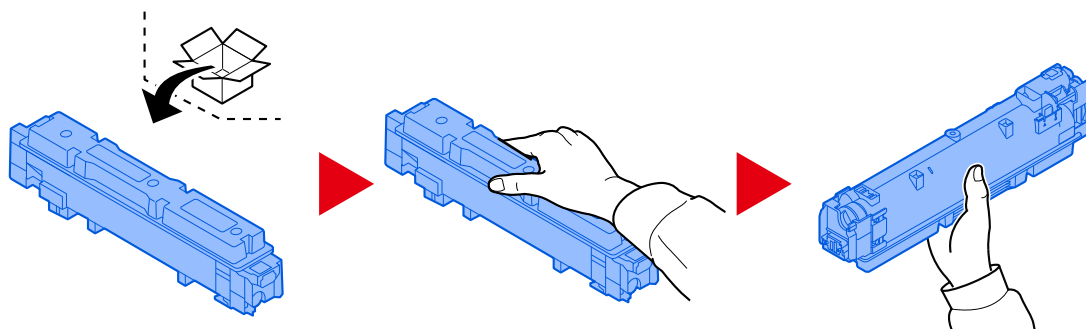

✔ **IMPORTANT**

Do not touch the points shown below.

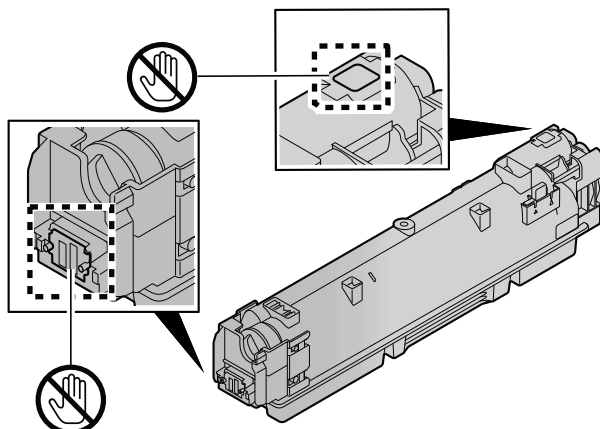

5 Shake the toner container.

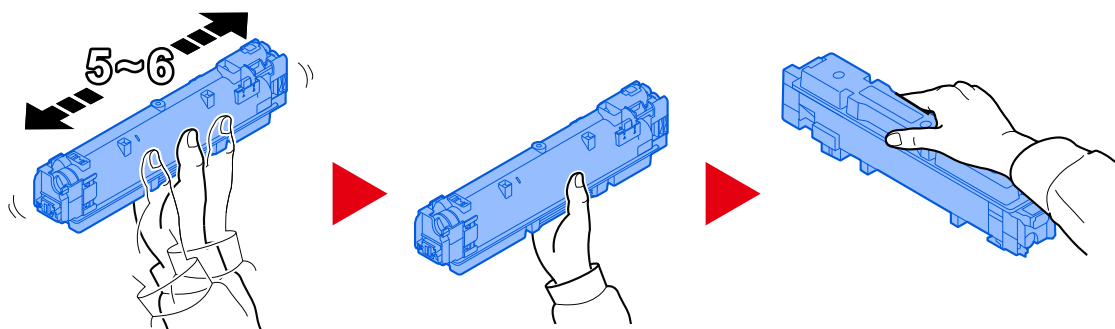

6 Install the toner container.

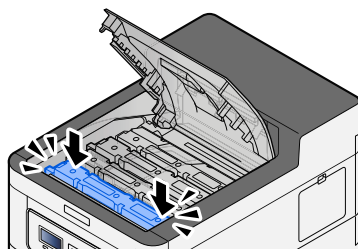

✔ **IMPORTANT**

Insert the toner container all the way.

7 Close the top cover.

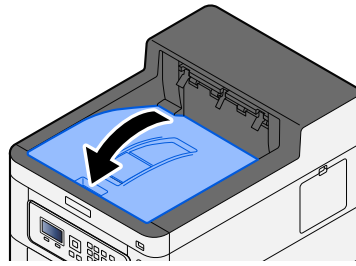

NOTE

- If the toner container cover or front cover does not close, check that the new toner container is installed correctly.
 - Return the exhausted toner container to your dealer or service representative. The collected toner container will be recycled or disposed in accordance with the relevant regulations.
-

"Toner is low[C,M,Y,K]" is displayed

It is almost time to replace the toner container.

Obtain a new toner container.

"Toner type mismatch. [C][M][Y][K]" is displayed

Does the type of toner you have match the model?

Please install correct toner.

"USB Drive error." is displayed

Is the USB drive write-protected?

An error occurred in the USB drive. The job is canceled. Select [OK].

The following error code is displayed:

01: Connect a writeable USB drive.

An error occurred in the USB drive.

The job is canceled. Select [OK].

The following error code is displayed:

01: The amount of data that can be saved at once has been exceeded. Restart the system or turn the power OFF/ON.

If the error persists, the USB drive is not compatible with the machine. Use the USB drive formatted by this machine. If the USB drive cannot be formatted, it is damaged. Connect a compatible USB drive.

 **NOTE**

If Auto Error Clear is set to [On], the process will resume automatically after a set period of time. For details, refer to the following:

➔ [Auto Err. Clear \(page 230\)](#)

"High temperature. Adjust room temp." is displayed

Print quality may be deteriorated. Adjust the temperature and the humidity of your room.

"Low temperature. Adjust room temp." is displayed

Print quality may be deteriorated. Adjust the temperature and the humidity of your room.

"Waste Toner Box is?full or placed?improperly." is displayed

Is the waste toner box full?

The waste toner box needs to be replaced.

 **CAUTION**

Do not attempt to incinerate parts which contain toner. Dangerous sparks may cause burns.

1 Open the Waste Toner Cover

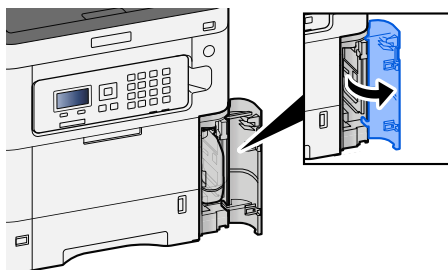

2 Remove the Waste Toner Box.

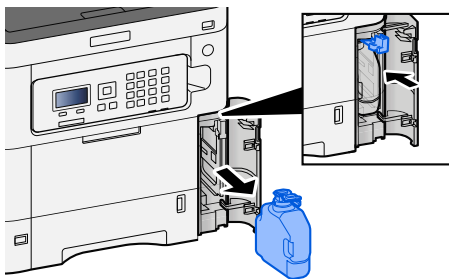

3 Put used Waste Toner Box into the plastic waste bag.

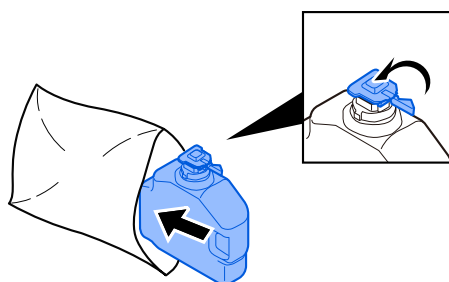

4 Remove the new Waste Toner Box.

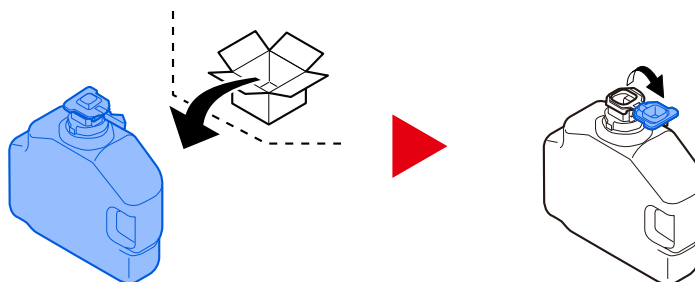

5 Install the Waste Toner Box.

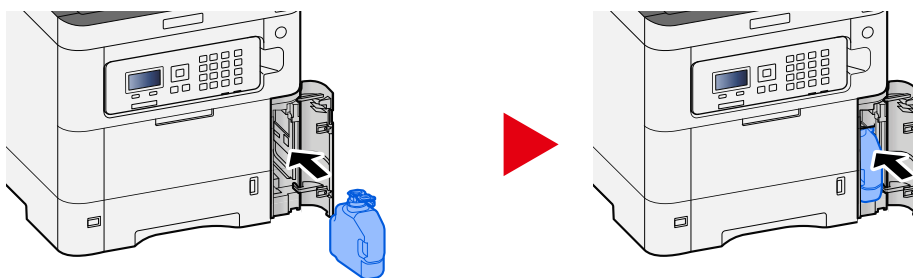

6 Close the Waste Toner Cover

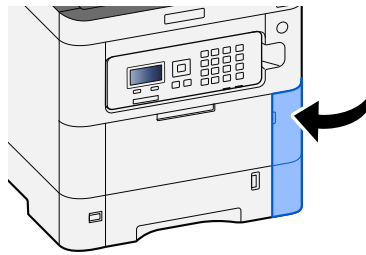

NOTE

Return the exhausted waste toner box to your dealer or service representative. The collected waste toner box will be recycled or disposed in accordance with the relevant regulations.

"You cannot use this box." is displayed

You do not have permission to use the specified box.

The job is canceled. Select [OK].

Adjustment/Maintenance

Overview of Adjustment/Maintenance

If there is an image problem and the message to run adjustment or maintenance menu appears, run Adjustment/Maintenance in the system menu.

The table below lists the item you can carry out.

Item	Description
[Color Regist.]	Correct the color position to resolve color drift. ➔ Color Registration Procedure (page 357)
[Image Adjustment]	<p>[Drum] Remove image blur and white dots from the printout. It takes about 1 minute and 20 seconds. The time required may vary depending on the usage environment.</p> <p>[DeveloperRefresh] Adjust the printed image that is too light or incomplete, even though there is enough toner.</p> <p>[LSU] Remove vertical white lines from the printout.</p> <p>[ColorCalibration] Calibrate the device to ensure correct toner overlapping and consistency with the original tone. ➔ Color Adjustment (page 357)</p> <hr/> <p> NOTE</p> <ul style="list-style-type: none"> • Drum refresh cannot be performed while printing. Execute drum refresh after the printing is done. • Waiting time may be longer when the toner is refilled during developer refresh. • When the correct toner overlapping is not ensured even after performing this color adjustment, refer to the following: ➔ Color Registration Procedure (page 357)

Color Adjustment

Due to long-term use and the influence of ambient temperature and humidity, the color tone of color output may change or color drift may occur. You can use this function to fine tune tone and color drift and enable optimized color printing. When the correct tone is not achieved or correct toner overlapping is not ensured even after performing this color adjustment, refer to the following:

➔ [Color Registration Procedure \(page 357\)](#)

1 Display the screen.

[Menu] key > [▲][▼] key > [Adjust/Maint.] > [OK] key > [▲][▼] key > [Image Adjustment] > [OK] key

2 Adjust.

[▲][▼] key > [ColorCalibration] > [OK] key

Select Color Adjustment in [Select], select [Start] to begin.

Color adjustment is performed, and when it is finished, the system returns to Adjustment/Maintenance.

Color Registration Procedure

Correct the color position to resolve color drift. If standard registration does not resolve the problem or to perform more detailed settings, use the detailed registration.



NOTE

When performing color registration, check that A4 paper is loaded in the cassette.



IMPORTANT

Before performing color registration, be sure to perform Color Adjustment. If color drift remains, perform color registration. By performing color registration without performing Color Adjustment, the color drift will be resolved once, however, it may cause the serious color drift later.

See the table below regarding Color Adjustment.

➔ [Color Adjustment \(page 357\)](#)

Performing Color Registration Procedure (Standard Registration)

1 Load paper.

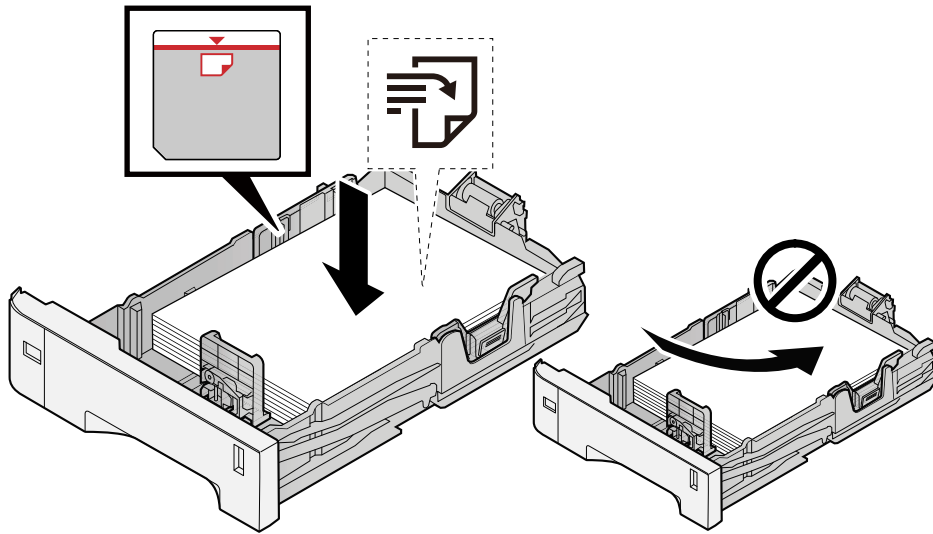

✓ IMPORTANT

- Load the paper with the print side facing up.
- After removing new paper from its packaging, fan out the paper before loading it in the cassettes.
➔ [Precaution for Loading Paper \(page 90\)](#)
- Before loading the paper, be sure that it is not curled or folded. Paper that is curled or folded may cause paper jams.
- Ensure that the loaded paper does not exceed the level indicator (see illustration above).
- If paper is loaded without adjusting the paper length guide and paper width guide, the paper may skew or become jammed.

2 Display the screen.

[Menu] key > [▲][▼] key > [Adjust/Maint.] > [OK] key > [▲][▼] key > [Color Regist.] > [OK] key > [▲][▼] key > [Normal] > [OK] key

3 Print the chart.

[▲][▼] key > [Print Chart] > [OK] key > [Yes]

A chart is printed. Three types of charts are printed on a single sheet of paper for the three colors M (Magenta), C (Cyan), and Y (Yellow): H-L (Left), V (Center), and H-R (Right).

After printing, return to the Color Printing Position Correction Standard menu.

Chart Example

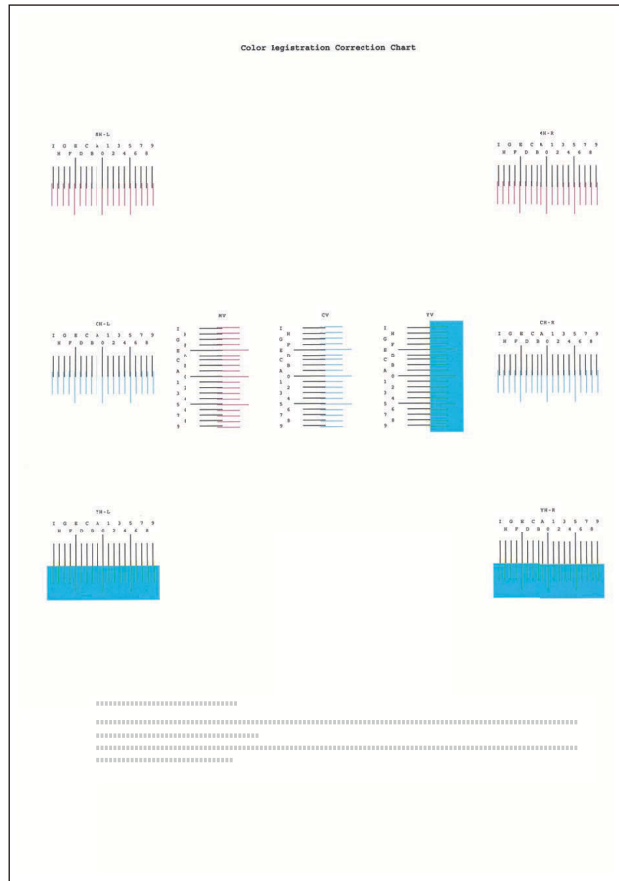

4 Displays the Correction menu.

[▲][▼] key > [Adjust Magenta] > [OK] key
 The Magenta Correction menu is displayed.

5 Enter the appropriate value.

- 1 Find the location on each chart where 2 lines most closely match. If this is the 0 position, registration for that color is not required. For the illustration, B is the appropriate value.

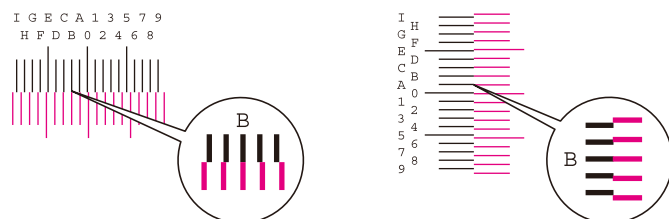

- 2 Select [◀] or the [▶] key and change items H-L, V and H-R, select [▲] or the [▼] key, input values loaded from the chart, and select the [OK] key.
 Correct the Magenta, and after a short while, return to the Color Printing Position Correction Standard menu.
 Select the [▲] key to advance the value from 0 to 9. Select the [▼] key to go in the opposite direction.
 Select the [▼] key to change the value from 0 to the alphabet and from A to I. Select the [▲] key to go in the opposite direction.

It is not possible to enter values with the numeric keypad.

- 3 Repeat steps 3-4 to correct Cyan and Yellow.

Performing Color Registration Procedure (Detailed Registration)

1 Load paper.

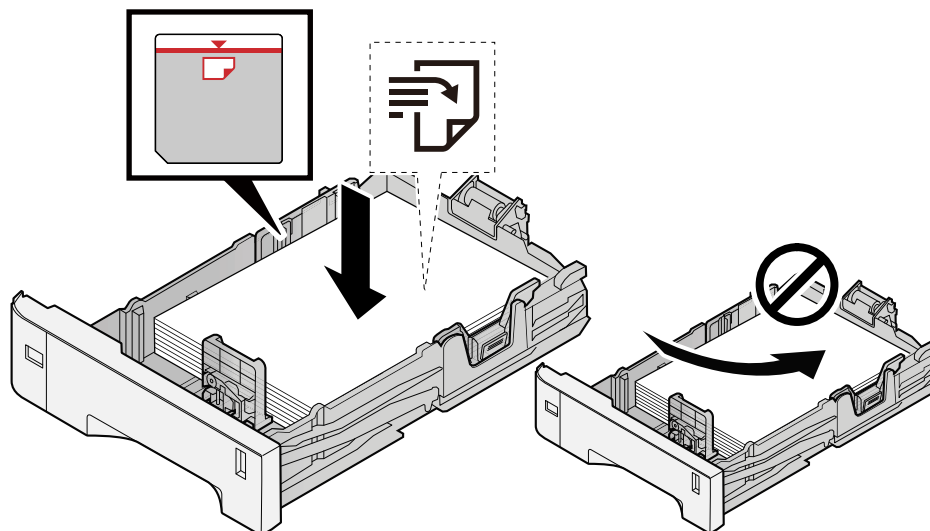

✓ IMPORTANT

- Load the paper with the print side facing up.
- After removing new paper from its packaging, fan out the paper before loading it in the cassettes.
→ [Precaution for Loading Paper \(page 90\)](#)
- Before loading the paper, be sure that it is not curled or folded. Paper that is curled or folded may cause paper jams.
- Ensure that the loaded paper does not exceed the level indicator (see illustration above).
- If paper is loaded without adjusting the paper length guide and paper width guide, the paper may skew or become jammed.

2 Display the screen.

[Menu] key > [▲][▼] key > [Adjust/Maint.] > [OK] key > [▲][▼] key > [Color Regist.] > [OK] key > [▲][▼] key > [Detail] > [OK] key

3 Print the chart.

[▲][▼] key > [Print Chart] > [OK] key > [Yes]

A chart is printed. On the chart, for each of M (magenta), C (cyan) and Y (yellow), charts for H-1 to 5 and V-1 to 5 are printed.

After printing, return to the Color Printing Position Correction Details menu.

Chart Example

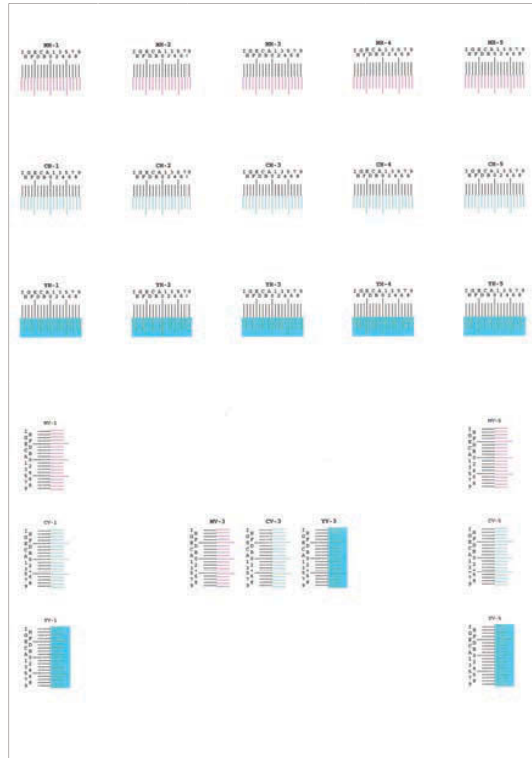

4 Displays the Correction menu.

[▲][▼] key > [Adjust Magenta] > [OK] key
 The Magenta Correction menu is displayed.

5 Enter the appropriate value.

- 1 Find the location on each chart where 2 lines most closely match. If this is the 0 position, registration for that color is not required. For the illustration, B is the appropriate value.

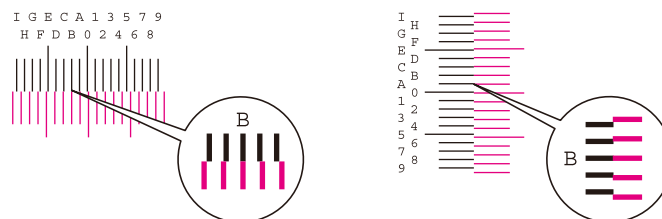

From charts H-1 to H-5, read the values from H-1 to H-5.

From charts V-1 to V-5, read only the values from V-3 (center).

- 2 Select the [◀] or the [▶] key and change items H-1 to H-5 and V-3, then select the [▲] or the [▼] key, input values loaded from the chart, and select the [OK] key.

Correct the Magenta, and after a short while, return to the Color Printing Position Correction Procedure Detail menu.

Select the [▲] key to advance the value from 0 to 9. Select the [▼] key to go in the opposite direction.

Select the [▼] key to change the value from 0 to the alphabet and from A to I. Select the [▲] key to go in the opposite direction.

It is not possible to enter values with the numeric keypad.

- 3 Repeat steps 3-4 to correct Cyan and Yellow.

Clearing Paper Jams

If a paper jam occurs, the LCD panel will display "Paper jam." and the machine will stop.

Jam Location Indicators

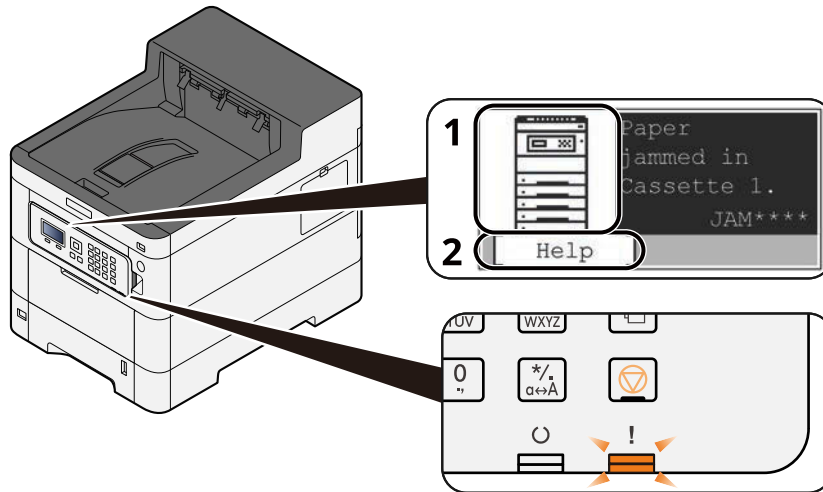

- 1 Shows the location of a paper jam.
- 2 Shows the Help screen. The Help screen shows the procedure to clear the jam.

NOTE

For the Help screen, refer to the following:

➔ [Help Screen \(page 41\)](#)

If a paper jam occurs, the location of the jam will be displayed on the LCD panel as well as the clearing instructions.

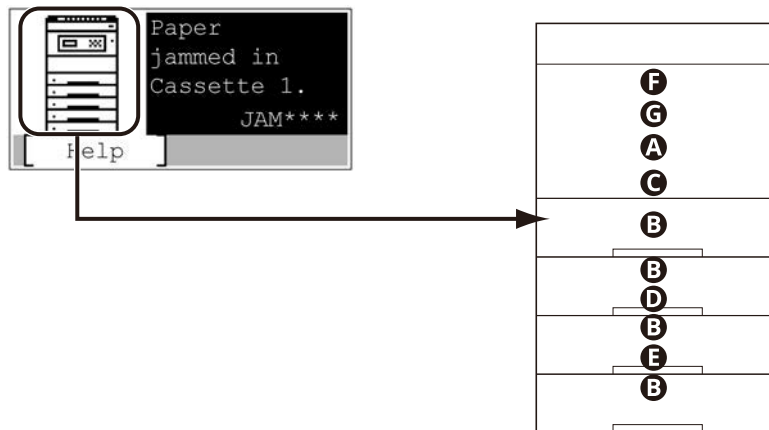

Paper Jam Location Indicator	Paper Jam Location
A	Multipurpose Tray ➔ Remove any jammed paper in the Multipurpose Tray (page 364)

Paper Jam Location Indicator	Paper Jam Location
B	Cassette 1 to 5 ➔ Remove paper jams from Cassette 1 to Cassette 5 (page 367)
C	Rear Cover 1 (Feed) ➔ Remove the paper jammed in the Rear Cover 1 (Feed) (page 369)
D	Rear Cover 2 ➔ Remove the paper jammed in the Rear Cover 2 (page 370)
E	Rear Cover 3 ➔ Remove the paper jammed in the Rear Cover 3 (page 371)
F	Rear Cover 1 ➔ Remove the paper jammed in the Rear Cover 1 (page 372)
G	Duplex Unit ➔ Remove any jammed paper in Duplex Unit (page 374)

After you remove the jam, the machine will warm up again and the error message will be cleared. The machine resumes with the page that was printing when the jam occurred.

Remove any jammed paper in the Multipurpose Tray

CAUTION

- Do not reuse jammed papers.
 - If the paper tears during removal, be sure to remove any loose scraps of paper from inside the machine. Scraps of paper left in the machine could cause subsequent jamming.
-

1 Remove any jammed paper.

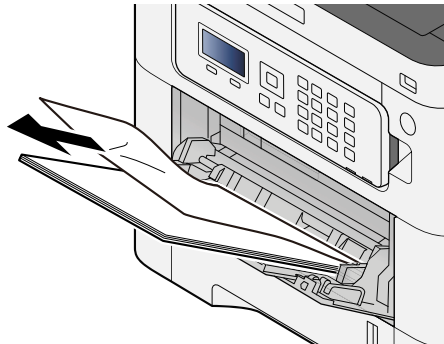

2 Remove all the paper.

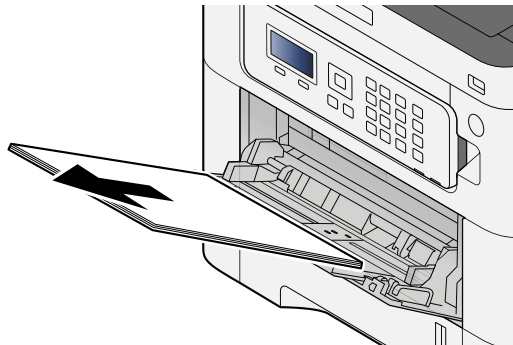

3 Close the multipurpose tray and pull out cassette 1.

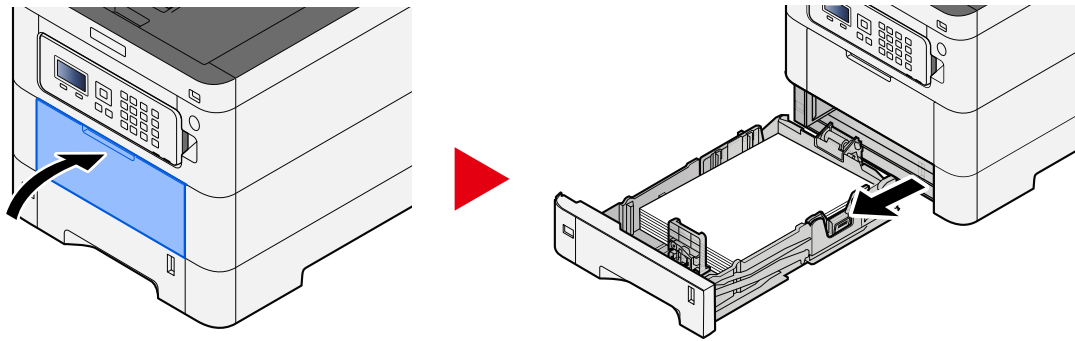

4 Open the feed cover.

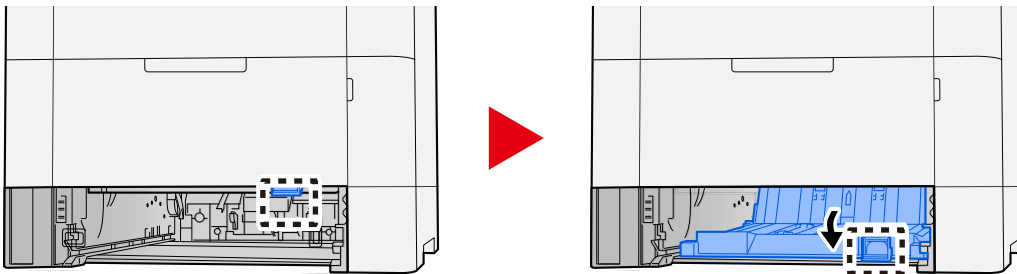

5 Remove any jammed paper.

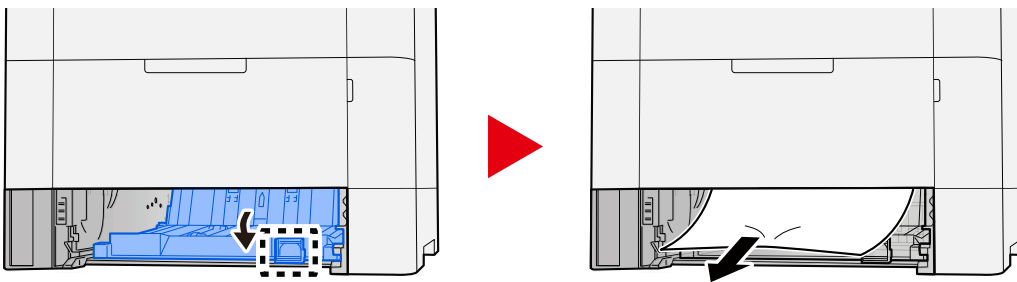

6 Return the feed cover to its original position and return cassette 1 to its original position.

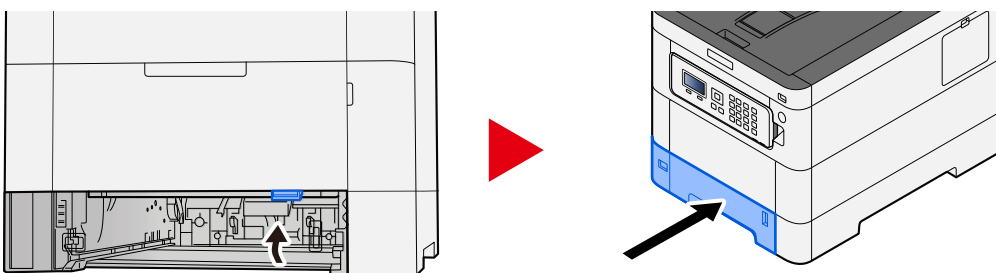

7 Open the multipurpose tray and reload the paper.

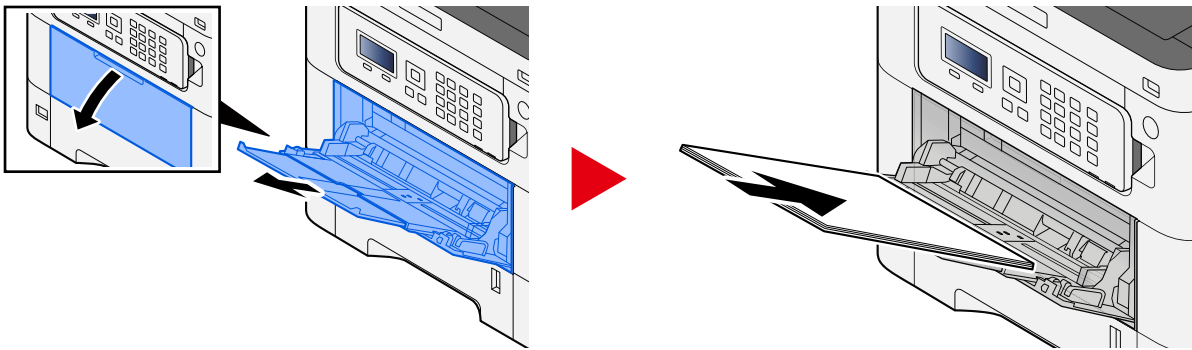

Remove paper jams from Cassette 1 to Cassette 5

The procedure for handling paper jams in cassette 1 to cassette 5 is the same. Cassette 1 is used as an example here.

CAUTION

- Do not reuse jammed papers.
- If the paper tears during removal, be sure to remove any loose scraps of paper from inside the machine. Scraps of paper left in the machine could cause subsequent jamming.

1 Pull Cassette 1 out toward you until it stops.

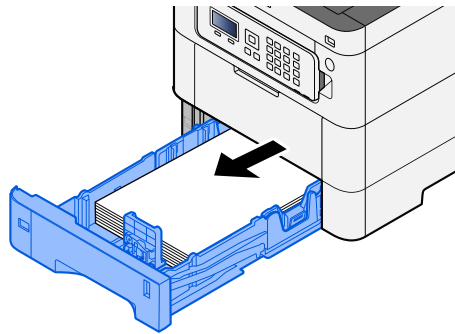

2 Remove any jammed paper.

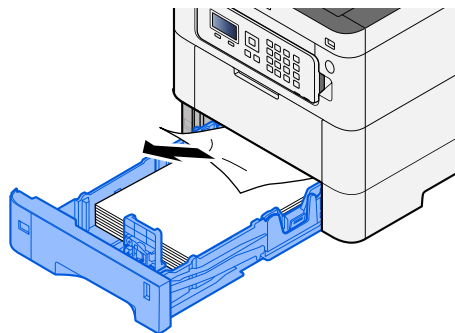

3 Push Cassette 1 back in.

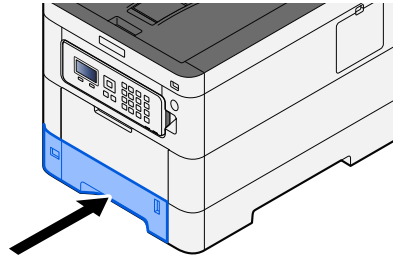

Remove the paper jammed in the Rear Cover 1 (Feed)

- 1 Open the Rear Cover 1.

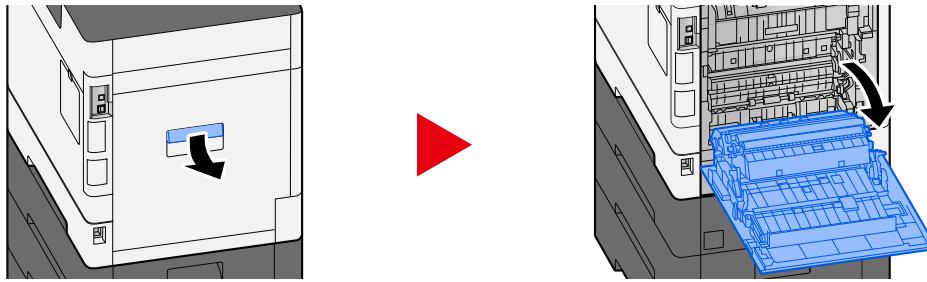

CAUTION

Some parts are very hot inside the machine. Exercise caution as there is a risk of burn injury.

- 2 Remove the jammed paper and return the Rear Cover 1 to its original position.

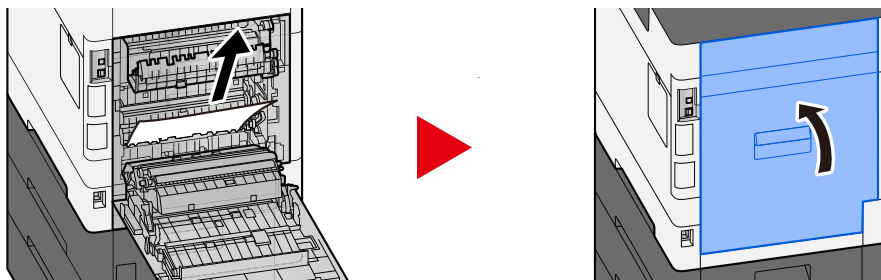

- 3 Open the Rear Cover 2 and remove the jammed paper.

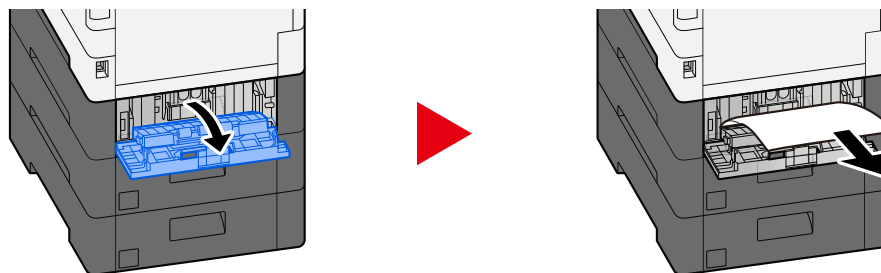

- 4 Return the Rear Cover 2 to the original position.

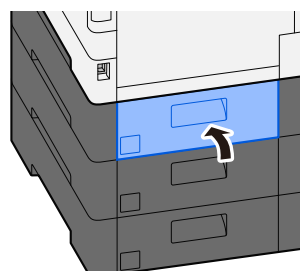

Remove the paper jammed in the Rear Cover 2

- 1 Open the Rear Cover 2 and remove the jammed paper.

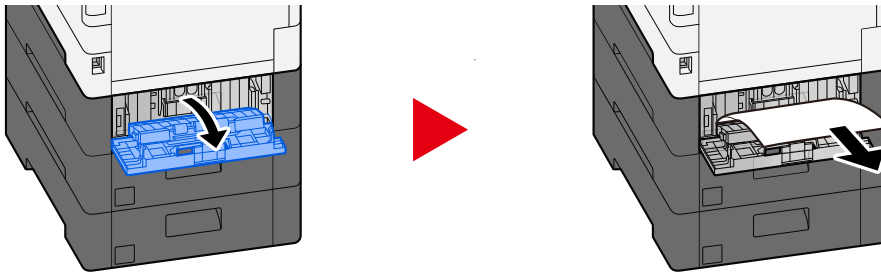

 **NOTE**

If you cannot remove the paper, do not force it out.

➔ [Remove the paper jammed in the Rear Cover 1 \(Feed\) \(page 369\)](#)

- 2 Return the Rear Cover 2 to the original position.

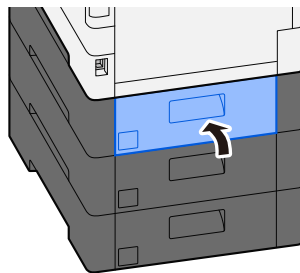

- 3 Open the Rear Cover 3 and remove the jammed paper.

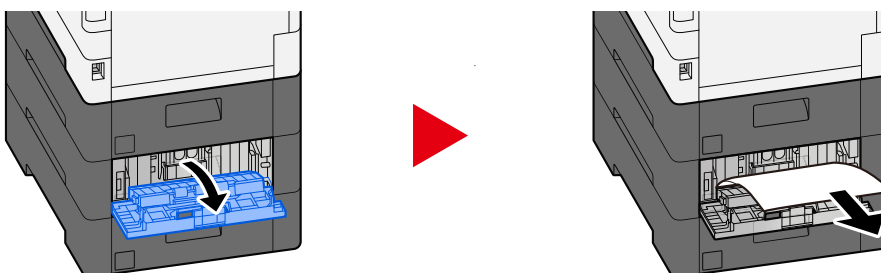

- 4 Return the Rear Cover 3 to the original position.

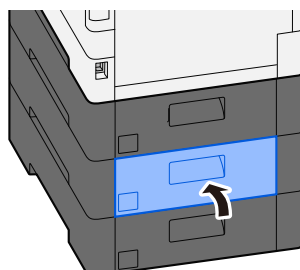

Remove the paper jammed in the Rear Cover 3

- 1 Open the Rear Cover 3 and remove the jammed paper.

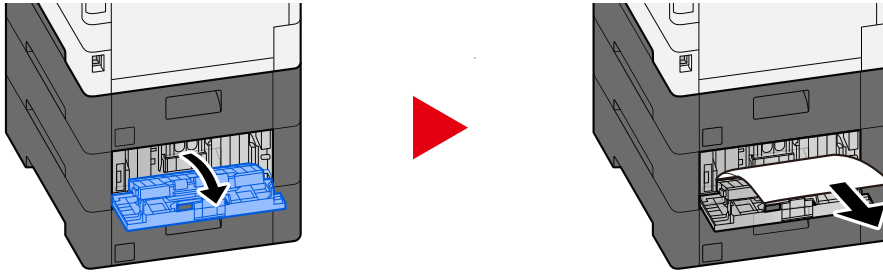

NOTE

If you cannot remove the paper, do not force it out.

➔ [Remove the paper jammed in the Rear Cover 1 \(Feed\) \(page 369\)](#)

- 2 Return the Rear Cover 3 to the original position.

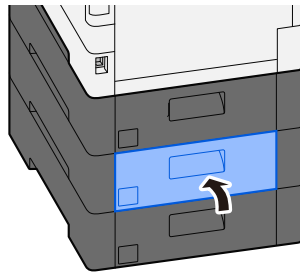

Remove the paper jammed in the Rear Cover 1

1 Open the Rear Cover 1

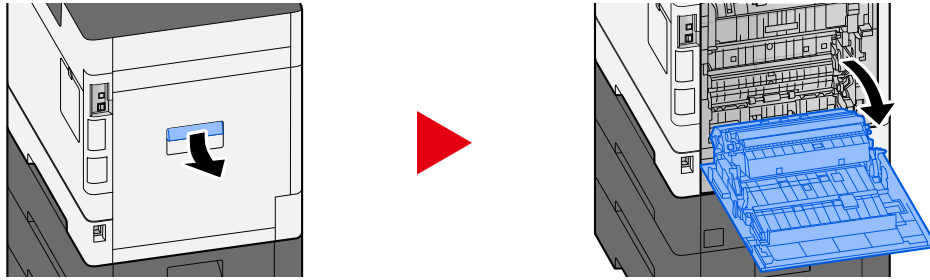

CAUTION

Some parts are very hot inside the machine. Exercise caution as there is a risk of burn injury.

2 Remove any jammed paper.

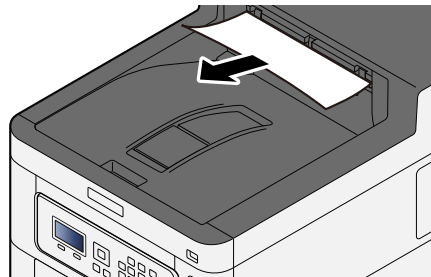

3 Open cover A1 and remove the jammed paper

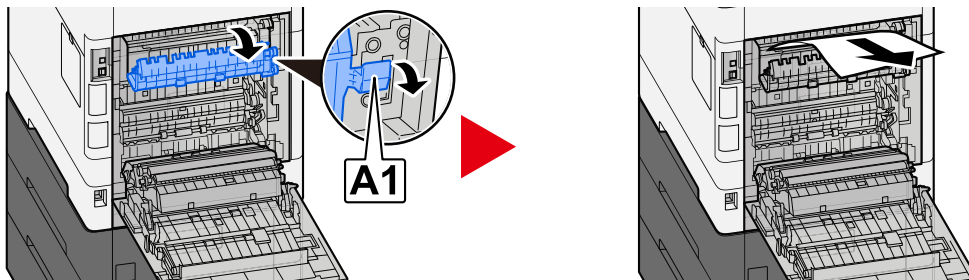

4 Remove any jammed paper.

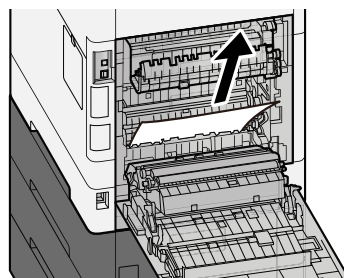

5 Open cover A2 and remove the jammed paper

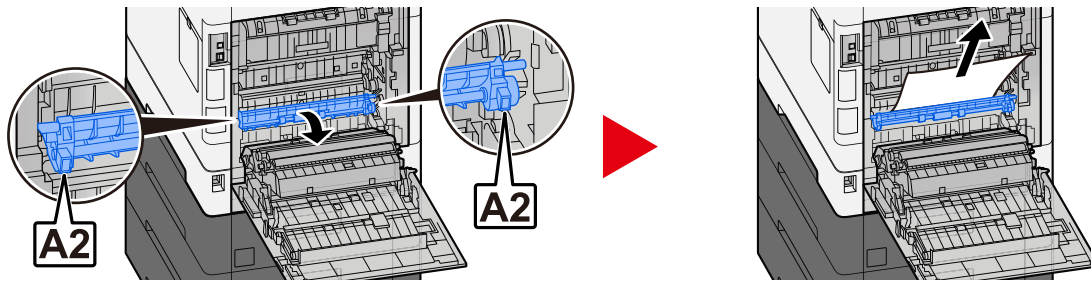

6 Return the rear cover 1 to the original position.

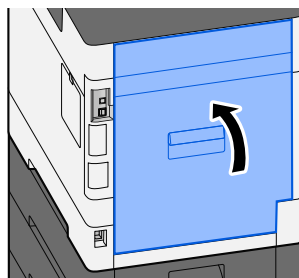

Remove any jammed paper in Duplex Unit

1 Open the Rear Cover 1

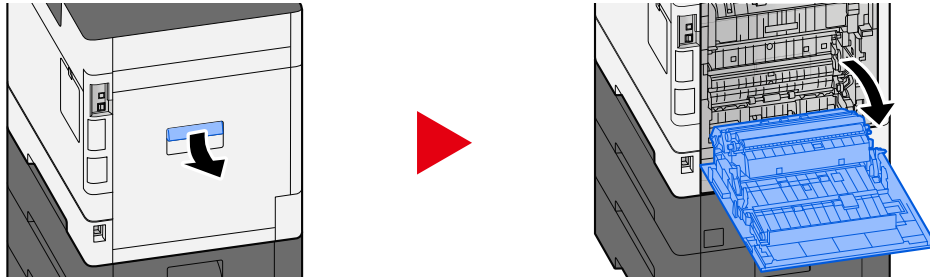

CAUTION

Some parts are very hot inside the machine. Exercise caution as there is a risk of burn injury.

2 Remove any jammed paper.

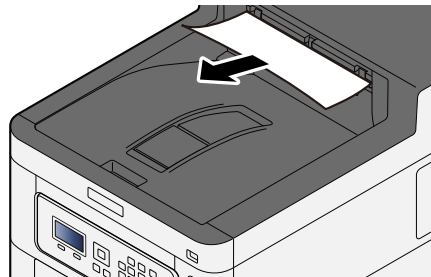

3 Open cover A1 and remove the jammed paper

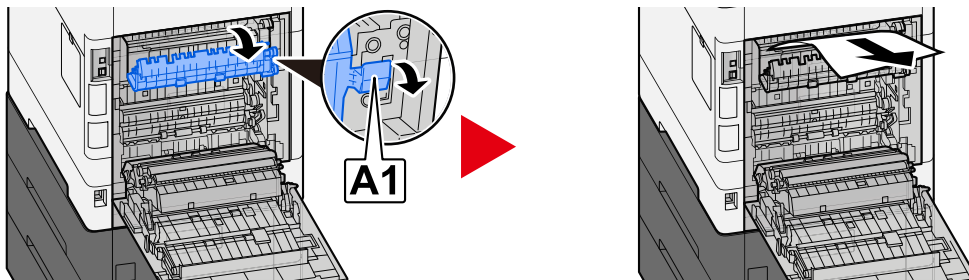

4 Remove any jammed paper.

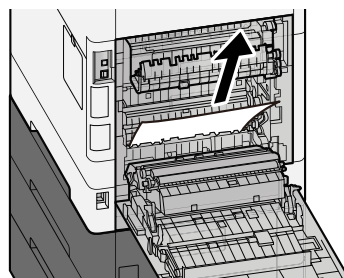

5 Open cover A2 and remove the jammed paper

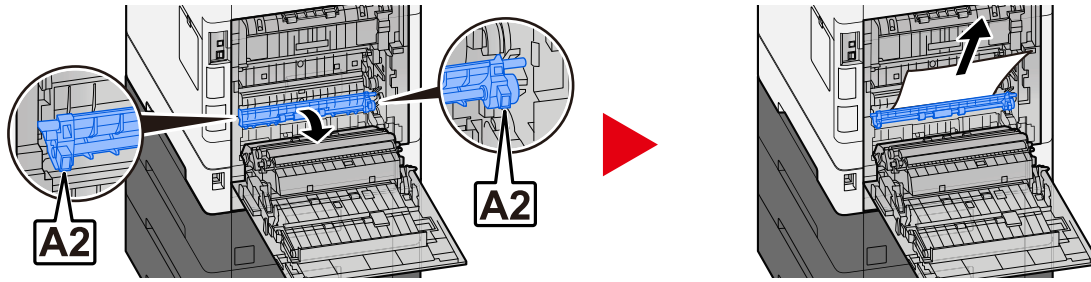

6 Return the Unit A3 to the original position

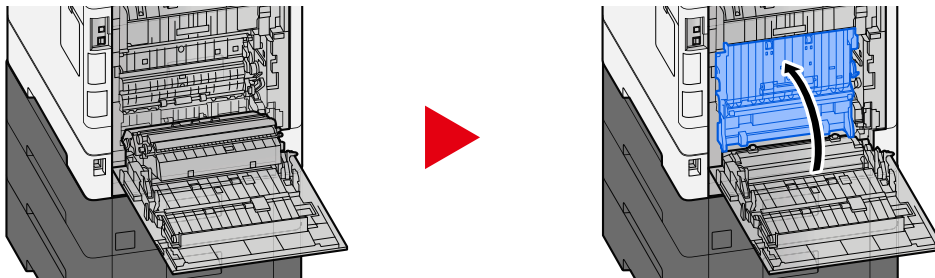

7 Remove any jammed paper.

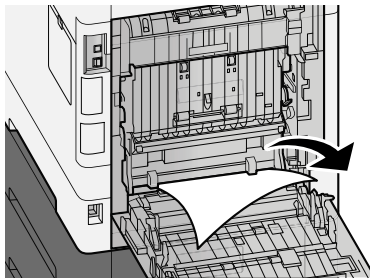

8 Return the rear cover 1 to the original position.

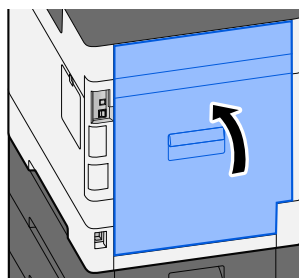

11 Appendix

Optional Equipment

Option configuration

The following enhancements are available for this model.

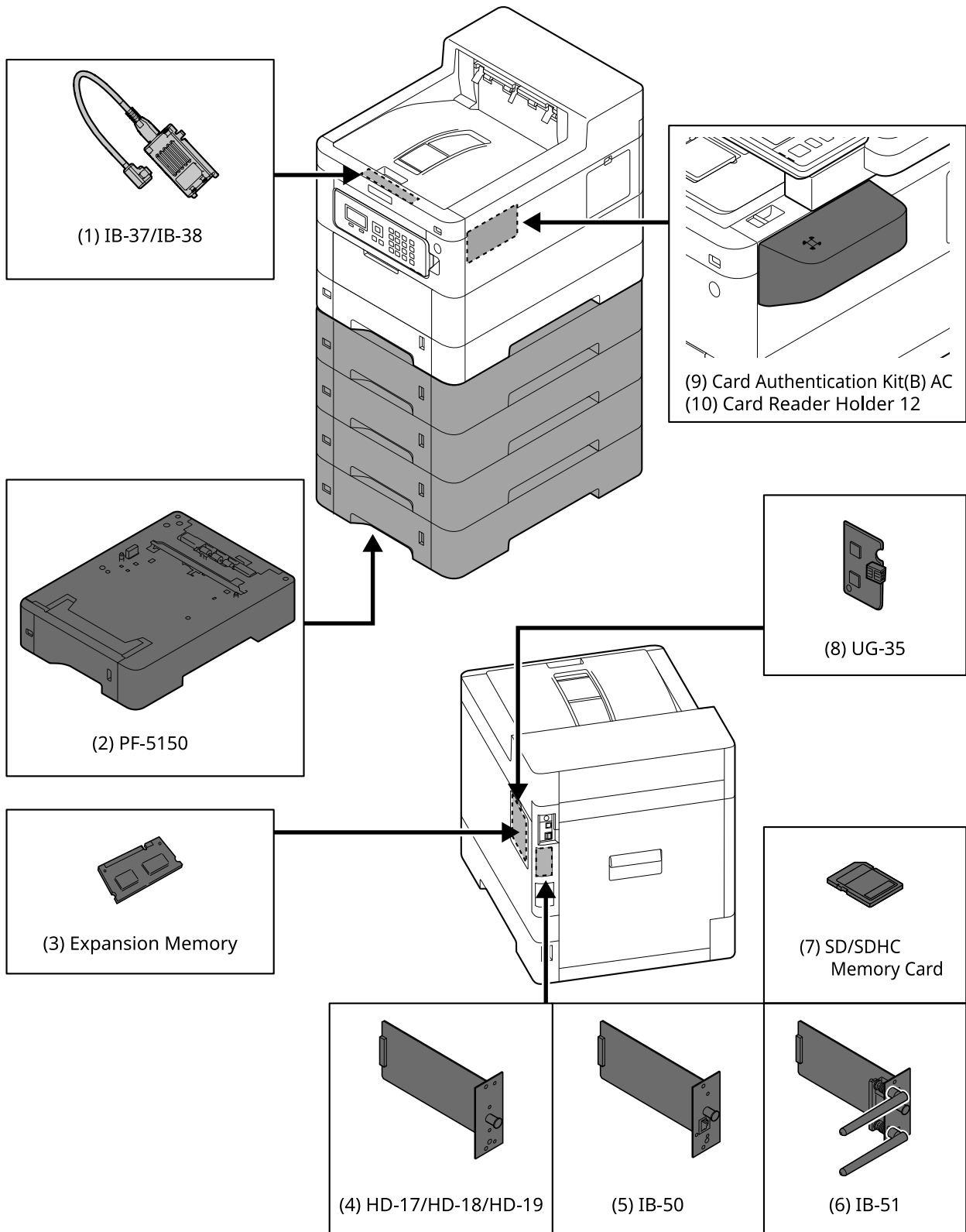

1 IB-37/IB-38 <Wireless network interface (USB: 5GHz/2.4GHz)>

A wireless network interface card that supports the wireless network (Wireless LAN) specifications IEEE802.11n (max. 65Mbps) and 11g/b. In addition, network printing is available without using the wireless LAN router since Wi-Fi Direct is supported.

2 PF-5150 <Paper feeder>

It is possible to add 4 drawers that is same as the cassette of the main unit.

It is possible to add 3 drawers that is same as the cassette of the main unit.

The way of loading paper is same as the standard cassette.

3 Expansion memory

By adding the memory, it will be possible to perform more multiple jobs at the same time. By installing the optional expansion memory, the memory can be expanded to 3,072MB as a maximum.

4 HD-17/HD-18/HD-19 <SSD>

SSD is for storing printing data. When printing the multiple prints, there are advantages such as the high speed printing with the electronic sort function. And also, it is possible to use the document box function.

5 IB-50 <Network interface>

The network interface kit is the high speed interface supported to the communication speed of 1 giga bit/sec. Since TCP/IP, NetBEUI protocol are supported, it is possible make the network printing under the various environment such as Windows, Macintosh, UNIX, etc..

➔ **IB-50 Operation Guide**

6 IB-51 <Wireless network interface (KUIO: 2.4GHz)>

A wireless LAN network interface card that supports the wireless LAN specifications IEEE802.11n (max. 300Mbps) and 11g/b. It is possible to set for various OS and network protocol with bundled utilities.

➔ **IB-51 Operation Guide**

7 SD/SDHC Memory Card

SD/SDHC memory card is the micro-chip card that the option font, macro, form, etc. can be written. Insert SDHC memory card (Max. 32GB) and SD memory card (Max. 2GB) into the memory card slot.

8 UG-35 <Trusted Platform Module>

It is possible to protect the confidential information safely with this option. The encryption key used for the encrypted confidential information is stored in the exclusive storing area of the TPM chip. Since it is not possible to scan in this storing area from the outside of the TPM, the confidential information can protect safely.

9 Card Authentication Kit(B) AC <IC card authentication kit (Activate)>

It is possible to make the user authentication with IC card. In order to perform the user authentication with IC card, IC card information has to be registered to the local user list in advance.

Refer to the following for the method of the registration.

➔ **IC CARD AUTHENTICATION KIT (B) OPERATION GUIDE**

10 Card Reader Holder 12 <Card reader attachment plate>

In order to install Card reader, it is possible to use it as a installation space.

Software option

1 UG-33 AC <ThinPrint expansion kit (Activate)>

It is possible print the print data directly even without the print driver.

2 USB Keyboard

A USB keyboard can be used to enter information into the text fields on the operation panel. A special mount is also available to install the keyboard on the machine. Please contact your dealer or service representative for information on keyboards that are compatible with your machine before you purchase one.

Reading the SD/SDHC Memory Card

Once inserted in the machine's slot, the contents of the SD/SDHC memory card can be read from the operation panel or automatically when you power on or reset the machine.

Overview of the Applications

The applications listed below are installed on this machine.

- Data Security Kit
- ThinPrint Option
This can be used on a trial basis for a limited time.
- Card Authentication Kit
This can be used on a trial basis for a limited time.

NOTE

- Restrictions such as the number of times the application can be used during the trial period differ depending on the application.
 - If you change the date/time while using the trial version of an application, you will no longer be able to use the application.
-

Starting Application Use

The procedure for starting use of the application is as follows.

1 [Menu] key > [▲][▼] key > [Op Functions] > [OK] key

NOTE

If the user authentication screen appears, log in with a user who has the privilege to configure this setting. If you do not know your login user name or password, please contact your administrator.

2 Select the desired application and select the [OK] key.

3 [▲][▼] key > [License On] > [OK] key

NOTE

You can view detailed information on the selected application by selecting [Detail].

4 [▲][▼] key > [Official] > [OK] key

To use the application as a trial, select [Trial] without entering the license key.

5 Enter the license key > [OK] key

Some applications do not require you to enter a license key. If the license key entry screen does not appear, go to step 6.

6 Select [Yes].

 **NOTE**

If you start the Security Kit or ThinPrint Option and enter the license key, you need to turn the power OFF/ON.

Checking Details of Application

The procedure for checking details of the application is as follows.

1 [Menu] key > [▲][▼] key > [Op Functions] > [OK] key

 **NOTE**

If the user authentication screen appears, log in with a user who has the privilege to configure this setting. If you do not know your login user name or password, please contact your administrator.

2 Select the desired application and select the [OK] key.

3 [▲][▼] key > [Detail] > [OK] key

You can reference detailed information for the selected application. [▶] Select key to display the next page. Select the [◀] key to return to the previous screen.

The items that can be referenced are as follows:

- Function Name
- Start Usage
- Trial Count
- Expiration Date
- Status

 **NOTE**

To extend the trial period, perform the following procedure.

[◀][▶] key > [Date of Trial] > [Extend] > [Yes]

Character Entry Method

The text entry screen used for entry of things like names is explained below.

Key used

Use the keys below to enter text.

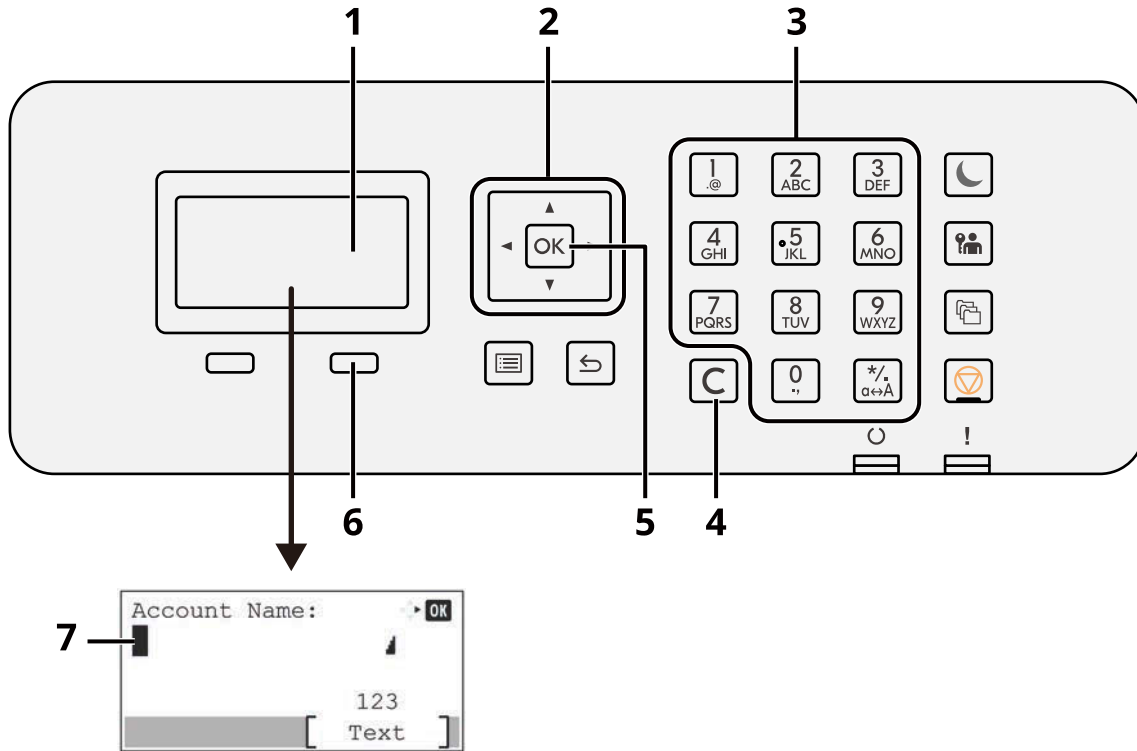

1 LCD panel

The entered text is displayed.

2 Arrow key

Select when moving the cursor of the text display portion or when selecting text from the text list.

3 Numeric Keypad

Select if entering text, values or symbols.

4 [Clear] key

Delete a character at the cursor position. Or, if the cursor is at the end of a line, delete the character to the left of the cursor.

5 [OK] key

Confirm the entered text.

6 Right selection key

Select if you are going to select the type for entered text. Only enabled when the key tab is displayed on the LCD panel.

7 Cursor

Text will be entered at the position of the cursor.

Selecting Type of Characters

To enter characters, the following three types are available:

Types	Description
ABC	To enter alphabets.
123	To enter numerals.
Symbols	To enter symbols.

In a character entry screen, select [Text] to select the type of characters you want to enter.

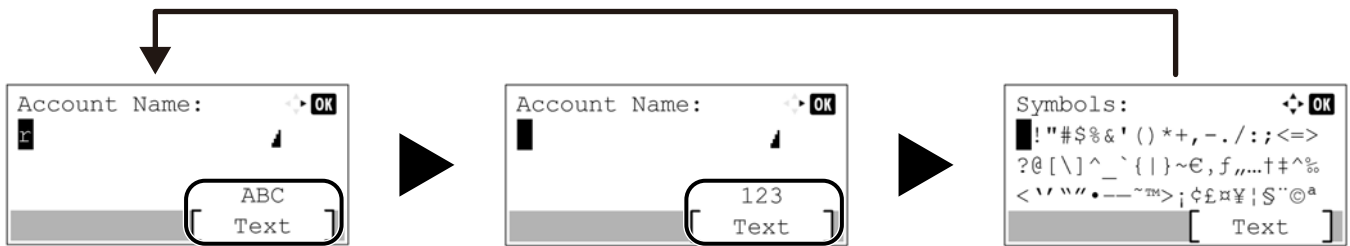



Each time you select [Text], the character type switches as follows: [ABC], [123], [Symbols], [ABC] ...

Characters That Can be Entered Using the Numeric Keys

The following table lists the characters that can be entered using the numeric keys.

Input key	Characters (Each press of a key changes the character in the order from left to right.)
1 @	. @ - _ / : ~ 1 (Repeats from the first character on the left) 1 (During number entry)
2 ABC	a b c A B C 2 (Repeats from the first character on the left) 2 (During number entry)
3 DEF	d e f D E F 3 (Repeats from the first character on the left) 3 (During number entry)
4 GHI	g h i G H I 4 (Repeats from the first character on the left) 4 (During number entry)
5 JKL	j k l J K L 5 (Repeats from the first character on the left) 5 (During number entry)
6 MNO	m n o M N O 6 (Repeats from the first character on the left) 6 (During number entry)
7 PQRS	p q r s P Q R S 7 (Repeats from the first character on the left) 7 (During number entry)
8 TUV	t u v T U V 8 (Repeats from the first character on the left) 8 (During number entry)

Input key	Characters (Each press of a key changes the character in the order from left to right.)
	w x y z W X Y Z 9 (Repeats from the first character on the left) 9 (During number entry)
	., - _ ' ! ? (space) 0 (Repeats from the first character on the left) 0 (During number entry)
	Select to change the character in the cursor position between upper case and lower case. "*" or "." (During number entry)

Entering Symbols

Symbols can be entered.

- 1 Select the [#] key. Displays the symbol list.

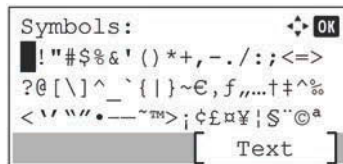

- 2 Select the [▲][▼][▶][◀] key to move the cursor and select the symbol to be entered.

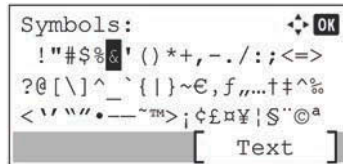

- 3 Select the [OK] key. The selected symbol is entered.

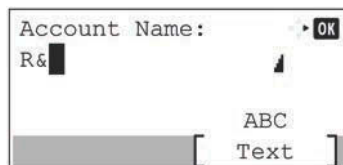

Entering Characters

Follow the steps shown below to enter "R&D" for example.

- 1 Select the [7] key three times. [r] is entered.

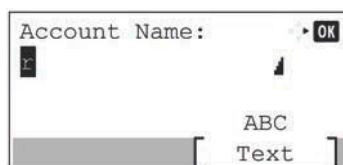

2 Select the [*/.] key. [r] changes to [R].

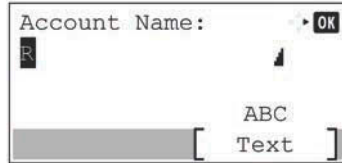

3 Select the [▶] key. The cursor moves to the right.

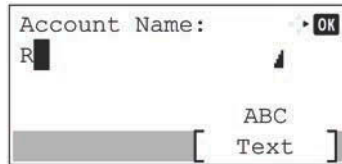

4 Select the [#] key. Displays the symbol list.

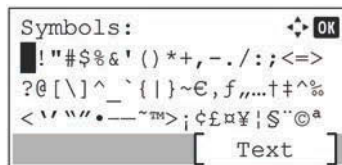

5 Select the [▲] or [▼] key to move the cursor and select [&].

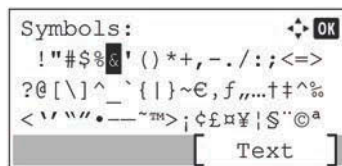

6 Select the [OK] key. [&] is entered.

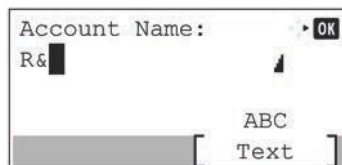

7 Select the [3] key four times. [D] is entered.

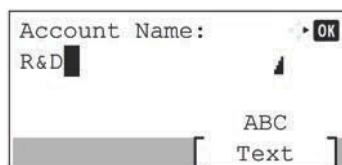

8 Select the [▶] key.

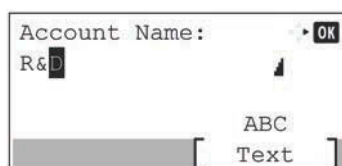

About Paper

This section explains the paper sizes and types that can be used in the paper source.

For details on the sizes, types, and number of sheets of paper that can be loaded in each paper tray, refer to the following:

→ [Specifications \(page 395\)](#)

Basic Paper Specifications

This machine is designed to print on standard copy paper as used in regular ('dry') copiers and page printers such as laser printers. It also supports a variety of other types of paper that conform to the specifications given in this appendix.

Be careful when choosing paper. Paper unsuitable for the machine may cause jams or may be wrinkled.

Supported Paper

Use standard copy paper for regular copiers or laser printers. The printing quality will be affected by the quality of paper. Poor quality paper may result in unsatisfactory output.

Basic Paper Specifications

The following table lists the specifications of paper that is supported with this machine.

Criteria	Specifications
Weight	Cassettes: 60 to 220 g/m ²
	Multipurpose tray: 60 to 220 g/m ²
Dimensional accuracy	±0.7 mm
Squareness of corners	90° ±0.2°
Moisture Content	4 to 6%
Pulp content	80% or more

NOTE

Some recycled paper does not meet requirements for use with this machine as listed in the Basic Paper Specifications shown below, such as moisture or pulp content. For this reason, we recommend purchasing a small amount of recycled paper as a sample for testing prior to use. Choose recycled paper that gives the best printing results and contains low levels of paper dust.

We are not responsible for the problems occurred from the use of paper that does not conform to our specifications.

Choosing the Appropriate Paper

This section describes guidelines for choosing paper.

Condition

Avoid using paper with bent corners or that is curled, dirty, or torn. Do not use paper that has a rough surface or paper fiber lint, or that is especially delicate. Using such paper can cause poor print quality. In addition, poor paper feeding can cause paper jams and shorten the life of the machine. Use paper with a smooth and even surface. However, do not use paper that has been surface-treated, such as coating, as it may damage the drum and fusing unit.

Ingredients

Do not use paper such as paper that has been coated or surface-treated or paper that contains plastic or carbon. Those types of paper may produce harmful fumes from the heat of printing and may damage the drum.

Be sure to use standard paper that contains at least 80% pulp. Be sure to use standard paper with 20% or less of the paper content consisting of cotton or other fibers.

Smoothness

The paper surface should be smooth, but it must be uncoated. With paper that is too smooth and slippery, several sheets may accidentally be supplied at once, causing jams.

Basis Weight

In countries that use the metric system, basis weight is the weight in grams of one sheet of paper one square meter in area. In the United States, basis weight is the weight in pounds of one ream (500 sheets) of paper cut to the standard size (or trade size) for a specific grade of paper.

Paper that is too heavy or too light may be supplied incorrectly or cause paper jams, which may cause excessive wear of the machine. Mixed paper weight (i.e., thickness) may cause several sheets to be supplied at once accidentally and may also cause blurring or other printing problems if the toner fails to adhere correctly.

Moisture Content

Paper moisture content is the ratio of moisture to dryness expressed as a percentage. Moisture affects how the paper is supplied, the electrostatic chargeability of the paper, and how the toner adheres.

Paper moisture content varies depending on the relative humidity in the room. High relative humidity causes paper to become damp, making the edges expand so it appears wavy. Low relative humidity causes paper to lose moisture, making the edges tighten and weakening print contrast.

Wavy or tight edges may cause the paper to slip when it is supplied. Try to keep the moisture content between 4 to 6%.

To maintain the right level of moisture content, bear in mind the following considerations.

- Store paper in a cool, well-ventilated place.
- Store paper flat and unopened in the package. Once the package is opened, reseal it if the paper is not to be used for a while.
- Store paper sealed in the original package and box. Put a pallet under the box to keep it raised above the floor. Especially during rainy seasons keep the paper a sufficient distance away from wooden or concrete floors.
- Before using paper that has been stored, keep it at the proper moisture level for at least 48 hours.
- Do not store paper where it is exposed to heat, sunlight, or dampness.

Other Paper Specifications

Porosity:

The density of the paper fibers.

Stiffness:

Paper must be stiff enough or it may buckle in the machine, causing jams.

Curl:

Most paper naturally tends to curl after the package is opened. When paper passes through the fixing unit, it curls upward slightly. To deliver flat printouts, load the paper so that the curl faces towards the bottom of the paper tray.

Static electricity:

During printing, paper is electrostatically charged so that the toner adheres. Choose paper that can be discharged quickly so that copies do not cling together.

Whiteness:

Paper whiteness affects print contrast. Use whiter paper for sharper, brighter copies.

Quality:

Machine problems may occur if sheet sizes are not uniform or if corners are not square, edges are rough, sheets are uncut, or edges or corners are crushed. In order to prevent these problems, be especially careful when you cut the paper yourself.

Packaging:

Choose paper that is properly packaged and stacked in boxes. Ideally, the packaging itself should have been treated with a coating to inhibit moisture.

Specially treated paper:

We do not recommend printing onto the following types of paper, even if it conforms to the basic specifications. When you use these kinds of paper, purchase a small amount first as a sample to test.

- Glossy paper
- Watermarked paper
- Paper with an uneven surface
- Perforated paper

Paper Sizes that can be Used with This Machine

Paper of the following sizes is supported by the machine.

Measurements in the table take into account a ± 0.7 mm dimensional accuracy for length and width. Corner angles must be $90^\circ \pm 0.2^\circ$.

Paper Size	Cassette 1	Cassette to 5	Multipurpose Tray
Envelope Monarch (3-7/8 × 7-1/2")	Paper of this size cannot be set	Paper of this size can be set	Paper of this size can be set
Envelope #10 (4-1/8 × 9-1/2")	Paper of this size cannot be set	Paper of this size can be set	Paper of this size can be set
Envelope DL (110 × 220 mm)	Paper of this size cannot be set	Paper of this size can be set	Paper of this size can be set

Paper Size	Cassette 1	Cassette to 5	Multipurpose Tray
Envelope C5 (162 × 229 mm)	Paper of this size cannot be set	Paper of this size can be set	Paper of this size can be set
Executive (7-1/4 × 10-1/2")	Paper of this size can be set	Paper of this size can be set	Paper of this size can be set
Letter	Paper of this size can be set	Paper of this size can be set	Paper of this size can be set
Legal	Paper of this size can be set	Paper of this size can be set	Paper of this size can be set
A4 (297 × 210 mm)	Paper of this size can be set	Paper of this size can be set	Paper of this size can be set
B5 (257 × 182 mm)	Paper of this size can be set	Paper of this size can be set	Paper of this size can be set
A5-R	Paper of this size can be set	Paper of this size can be set	Paper of this size can be set
A5 (210 × 148 mm)	Paper of this size can be set	Paper of this size cannot be set	Paper of this size can be set
A6 (148 × 105 mm)	Paper of this size can be set	Paper of this size cannot be set	Paper of this size can be set
B6 (182 × 128 mm)	Paper of this size can be set	Paper of this size can be set	Paper of this size can be set
Envelope #9 (3-7/8 × 8-7/8")	Paper of this size cannot be set	Paper of this size can be set	Paper of this size can be set
Envelope #6 (3-5/8 × 6-1/2")	Paper of this size cannot be set	Paper of this size can be set	Paper of this size can be set
ISO B5 (176 × 250 mm)	Paper of this size can be set	Paper of this size can be set	Paper of this size can be set
Hagaki (Cardstock) (100 × 148 mm)	Paper of this size cannot be set	Paper of this size cannot be set	Paper of this size can be set
Oufuku hagaki (Return postcard) (148 × 200 mm)	Paper of this size cannot be set	Paper of this size cannot be set	Paper of this size can be set
Oficio II	Paper of this size can be set	Paper of this size can be set	Paper of this size can be set
216 × 340 mm	Paper of this size can be set	Paper of this size can be set	Paper of this size can be set
16K (273 × 197 mm)	Paper of this size can be set	Paper of this size can be set	Paper of this size can be set
Statement-R	Paper of this size can be set	Paper of this size can be set	Paper of this size can be set
Statement	Paper of this size can be set	Paper of this size cannot be set	Paper of this size can be set
Folio (210 × 330 mm)	Paper of this size can be set	Paper of this size can be set	Paper of this size can be set
Youkei 4 (105 × 235 mm)	Paper of this size cannot be set	Paper of this size can be set	Paper of this size can be set

Paper Size	Cassette 1	Cassette to 5	Multipurpose Tray
Youkei 2 (114 × 162 mm)	Paper of this size cannot be set	Paper of this size can be set	Paper of this size can be set
Nagagata 3	Paper of this size cannot be set	Paper of this size can be set	Paper of this size can be set
Nagagata 4	Paper of this size cannot be set	Paper of this size can be set	Paper of this size can be set
Yougata 3	Paper of this size cannot be set	Paper of this size can be set	Paper of this size can be set
Size Input	Cassette 1: 105 × 148 to 216 × 356 mm Cassette 2 to 5: 92 × 162 to 216 × 356 mm Multipurpose Tray: 70 × 148 to 216 × 356 mm		

Special Paper

This section describes printing onto special paper and print media.

The following paper and media can be used.

- Transparencies
- Preprint
- Bond paper
- Recycled paper
- Thin paper
- Letterhead
- Colored Paper
- Prepunched paper
- Envelopes
- Hagaki (Cardstock)
- Thick Paper
- Labels
- Coated Paper
- High-quality paper

When using these paper and media, choose those that are designed specifically for copiers or page printers (such as laser printers). Use the multipurpose tray for thick paper, envelopes, cardstocks, and label paper.

Choosing Special Paper

Although special paper that meets the following requirements can be used with the machine, print quality will vary considerably due to differences in the construction and quality of special paper. Thus, special paper is more likely than regular paper to cause printing problems. Before purchasing special paper in volume, try testing a sample to ensure the print quality is satisfactory. General precautions when printing onto special paper are given below. Note that we are not responsible for any harm to the user or damage to the machine caused by moisture or specifications of special paper.

Select a cassette or multipurpose tray for special paper.

Transparencies

Transparencies must be able to withstand the heat of printing. Transparencies must meet the following conditions.

Heat resistance	Must withstand at least 190°C
Thickness	0.100 to 0.110 mm
Material	Polyester
Dimensional accuracy	±0.7 mm
Squareness of corners	90° ±0.2°

To avoid trouble, be sure to load transparencies in portrait orientation (i.e., the longer edge facing the machine). If transparencies jam frequently at output, try pulling the leading edge of sheets gently as they are ejected.

Labels

Be sure to feed labels from the multipurpose tray

For selecting labels, use extreme care so that the adhesive may not come in direct contact with any part of the machine and that the labels are not easily peeled from the carrier sheet. Adhesives that stick to the drum or rollers and peeled labels remaining in the machine may cause a failure.

When printing onto labels, you must be liable for the print quality and possible trouble.



Labels consist of three layers as shown in the illustration. The adhesive layer contains materials that are easily affected by the force applied in the machine. The carrier sheet bears the top sheet until the label is used. This composition of labels may cause more problems.

The label surface must be covered completely with the top sheet. Gaps between labels may cause peeling of labels, resulting in a serious failure.

Some label paper has large margins on the top sheet. When using such paper, do not peel these margins from the carrier sheet before completing output.

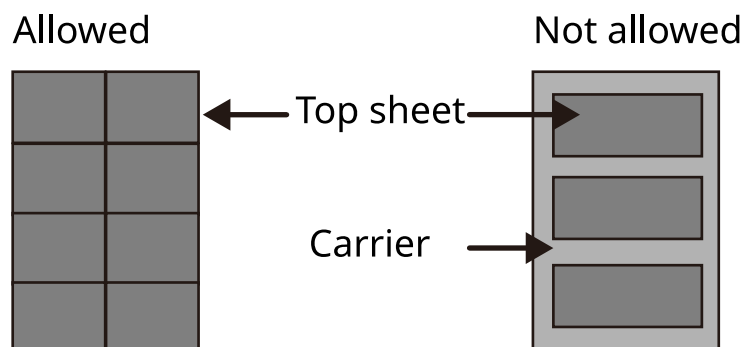

Use label paper that conforms to the following specifications.

Top sheet weight	44 to 74 g/m ²
Basis weight(overall paper weight)	104 to 151 g/m ²
Top sheet thickness	0.086 to 0.107 mm
Overall paper thickness	0.115 to 0.145 mm
Moisture Content	4 to 6 % (composite)

Hagaki (Cardstock)

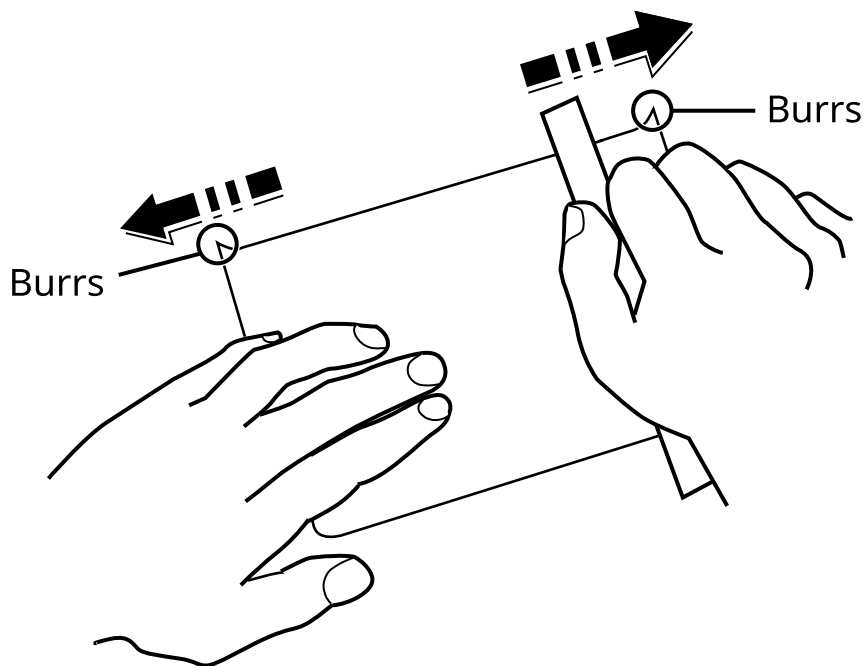

Before loading Hagaki (Cardstock) into the multipurpose tray, fan them and align the edges. If the Hagaki (Cardstock) paper is curled, straighten it before loading. Printing onto curled Hagaki (Cardstock) may cause jams.

Use unfolded Oufuku hagaki (Return postcard) (available at post offices). Some Hagaki (Cardstock) may still have rough edges developed by a paper cutter on the back side. Remove any such rough edges by placing the Hagaki (Cardstock) on a flat surface and rubbing the edges gently a few times with a ruler.

Envelopes

Envelopes should be fed from the MP tray with the print-side down or the cassette and the optional paper feeder with the print-side up.

NOTE

Do not load paper above the load limits located on the paper width guide of the cassette and the optional paper feeder.

Due to the structure of envelopes, printing evenly over the entire surface may not be possible in some cases. Thin envelopes in particular may be wrinkled by the machine in some cases as they pass through. Before purchasing envelopes in volume, try testing a sample to ensure the print quality.

Storing envelopes for a long period may cause them to become wrinkled. Thus, keep the package sealed until you are ready to use them.

Keep the following points in mind.

- Do not use envelopes with exposed adhesive. In addition, do not use the type of envelope in which the adhesive is exposed after the top layer is peeled off. Serious damage may be caused if the paper covering the adhesive comes off in the machine.
- Do not use envelopes with certain special features. For example, do not use envelopes with a grommet for winding a string to close the flap or envelopes with an open or film-covered window.
- If paper jams occur, load fewer envelopes at once.

Thick Paper

Before loading thick paper, fan it and align the edges. Some thick paper may still have rough edges developed by a paper cutter on the back side. Remove any such rough edges just as with Hagaki (Cardstock) by placing the paper on a flat surface and rubbing the edges gently a few times with a ruler. Printing onto paper with rough edges may cause jams.

NOTE

If the paper is not supplied correctly even after it is smoothed, load the paper with the leading edge raised a few millimeters.

Colored Paper

Colored paper must conform to the specifications.

➔ [Basic Paper Specifications \(page 386\)](#)

In addition, the pigments in the paper must be able to withstand the heat of printing (up to 200°C or 392°F).

Preprinted Paper

Preprinted paper must conform to the specifications

➔ [Basic Paper Specifications \(page 386\)](#)

The colored ink must be able to withstand the heat of printing. It must be resistant to silicone oil as well. Do not use paper with a treated surface such as glossy paper used for calendars.

Recycled Paper

Recycled paper must conform to the specifications; however, its whiteness may be considered separately.

➔ [Basic Paper Specifications \(page 386\)](#)

NOTE

Before purchasing recycled paper in volume, try testing a sample to ensure satisfactory print quality.

Coated Paper

Coated paper is created by treating the surface of the base paper with a coating that provides higher printing quality than plain paper. Coated paper is used for particularly high quality printing.

The surface of high-quality or medium-quality paper is coated with special agents that improve ink adhesion by making the paper surface smoother. These agents are used either to coat both sides of the paper or just one side. The coated side appears slightly glossy.

 **IMPORTANT**

When printing on coated paper in very humid environments, ensure that the paper is kept dry as moisture may cause sheets to stick together when they are fed into the machine. If printing in very humid environments, set coated paper for one sheet each.

Specifications

✔ IMPORTANT

Specifications are subject to change without notice.

Machine

Item	Specifications
Type	Desktop
Printing Method	Electrophotography by semiconductor laser
Paper Weight (Cassette)	60 to 163 g/m ²
Paper Weight (Multipurpose Tray)	60 to 220 g/m ²
Paper Type (Cassette)	Plain, Transparency (OHP film), Preprinted, Bond, Recycled, Thin, Letterhead, Color, Prepunched, Thick, High Quality, Custom (Duplex: Same as Simplex except for OHP films.)
Paper Type (Multipurpose Tray)	Plain, Preprinted, Bond, Recycled, Thin, Letterhead, Color, Prepunched, Thick, High Quality, Label, Envelope, Hagaki (Cardstock), Coated, Custom
Paper Size (Cassette)	A4, A5, A5-R, A6, B5, B6, Letter, Legal, 216×340 mm, Executive, Oficio II, 16K, Statement, Statement-R, Folio, ISO B5, Custom (105×140 to 216×356 mm)
Paper Size (Multipurpose Tray)	A4, A5, A5-R, A6, B5, B6, Letter, Legal, 216 × 340 mm, Executive, Oficio II, 16K, Statement, Statement-R, Folio, ISO B5, Envelope Monarch, Envelope #10, Envelope DL, Envelope C5, Envelope #9, Envelope #6 3/4, Hagaki (Cardstock), Oufukuhagaki (Return postcard), Yougata 2, Yougata 4, Nagagata 3, Nagagata 4, Yougata 3, Custom (70×140 to 216×356 mm)
Warm-up Time (23°C/73.4°F, 60%)	<p>ECOSYS PA4500cx 20 seconds or less (from power ON)</p> <p>ECOSYS PA4000cx 21 seconds or less (from power ON)</p> <p>ECOSYS PA3500cx 23 seconds or less (from power ON)</p>
Warm-up Time (23°C/73.4°F, 60%)	6 seconds or less (from sleep)
Paper Capacity (Cassette)	550 sheets (75 g/m ²) Up to upper limit height line in the cassette.
Paper Capacity (Multipurpose Tray)	100 sheets (75 g/m ²)

Item	Specifications
Output Tray Capacity (Inner tray)	<p>ECOSYS PA4500cx 500 sheets (80 g/m²)</p> <p>ECOSYS PA4000cx 500 sheets (80 g/m²)</p> <p>ECOSYS PA3500cx 250 sheets (80 g/m²)</p>
Image Write System	Semiconductor laser and electrophotography
Image Memory	<p>ECOSYS PA4500cx Standard: 1024 MB (On-Board) Maximum: 3072 MB (+2048 MB DIMM)</p> <p>ECOSYS PA4000cx Standard: 1024 MB (On-Board) Maximum: 3072 MB (+2048 MB DIMM)</p> <p>ECOSYS PA3500cx Standard: 1024 MB (On-Board) Maximum: 1024 MB (No DIMM)</p>
Interface (Standard)	<ul style="list-style-type: none"> • USB Interface Connector: 1 (Super-Speed USB) • Network interface: 1 (10 BASE-T, 100 BASE-TX (TCP/IP, Net BEUI)) • USB Port: 1 (Hi-Speed USB)
Interface (Option)	eKUIO:1
Operating Environment (Temperature)	10 to 32.5°C
Operating Environment (Humidity)	10 to 80%
Operating Environment (Altitude)	3,500 m/11,482 ft maximum
Operating Environment (Brightness)	1,500 lux maximum
Dimension (W × D × H)	<p>ECOSYS PA4500cx 394 × 533 × 455 mm / 15.51" × 20.98" × 17.91"</p> <p>ECOSYS PA4000cx 394 × 533 × 455 mm / 15.51" × 20.98" × 17.91"</p> <p>ECOSYS PA3500cx 394 × 533 × 392.5 mm / 15.51" × 20.98" × 15.45"</p>

Item	Specifications
Weight (without toner container)	<p>ECOSYS PA4500cx 33 kg / 72.75 lb</p> <p>ECOSYS PA4000cx 33 kg / 72.75 lb</p> <p>ECOSYS PA3500cx 32 kg / 70.55 lb</p>
Space Required (W × D) (when using multipurpose tray)	394 × 725 mm / 15.51" × 28.27"
Power Source	220-240 V AC, 50 Hz: 5.7 A
The power consumption of the product in networked standby (If all network ports are connected.)	<p>The information is available at the website below.</p> <p>https://www.kyoceradocumentsolutions.eu/en/about-us/our-brand/environmental-policy.html</p>
Options	➔ Option configuration (page 377)

Printer Function

Print Speed

ECOSYS PA4500cx

Paper Size	Black & White	Color
A4	45 sheets/min	45 sheets/min
Letter	47 sheets/min	47 sheets/min
A5-R/Statement-R	47 sheets/min	47 sheets/min
B5	15 sheets/min	15 sheets/min
A5/Statement	60 sheets/min	60 sheets/min
A6	30 sheets/min	30 sheets/min
Legal	38 sheets/min	38 sheets/min

ECOSYS PA4000cx

Paper Size	Black & White	Color
A4	40 sheets/min	40 sheets/min
Letter	42 sheets/min	42 sheets/min
A5-R/Statement-R	42 sheets/min	42 sheets/min
B5	11 sheets/min	11 sheets/min
A5/Statement	53 sheets/min	53 sheets/min
A6	26 sheets/min	26 sheets/min
Legal	34 sheets/min	34 sheets/min

ECOSYS PA3500cx

Paper Size	Black & White	Color
A4	35 sheets/min	35 sheets/min
Letter	37 sheets/min	37 sheets/min
A5-R/Statement-R	37 sheets/min	37 sheets/min
B5	11 sheets/min	11 sheets/min
A5/Statement	47 sheets/min	47 sheets/min
A6	26 sheets/min	26 sheets/min
Legal	30 sheets/min	30 sheets/min

Others

Item	Description
First Print Time (A4, feed from Cassette)	<p>ECOSYS PA4500cx</p> <p>Black & White 5.1 seconds or less</p> <p>Color 6.2 seconds or less</p> <p>ECOSYS PA4000cx</p> <p>Black & White 5.4 seconds or less</p> <p>Color 6.6 seconds or less</p> <p>ECOSYS PA3500cx</p> <p>Black & White 5.7 seconds or less</p> <p>Color 7.0 seconds or less</p>
Resolution	<ul style="list-style-type: none"> • Equivalent of 9600 dpi × 600 dpi • Equivalent of 1200 dpi × Equivalent of 1200 dpi
Operating System	<ul style="list-style-type: none"> • Windows 8.1 • Windows 10 • Windows 11 • Windows Server 2012/R2 • Windows Server 2016 • Mac OS X v10.9 or higher
Interface	<ul style="list-style-type: none"> • USB Interface Connector: 1 (Super-Speed USB) • Network interface: 1 (10 BASE-T/100 BASE-TX/1000 BASE-T) • Optional Interface (Option): 1 (For IB-50/IB-51 mounting) • Wireless LAN (Option): 1 (For IB-37/IB-38 mounting)
Page Description Language	PRESCRIBE
Emulation	<ul style="list-style-type: none"> • PCL6 (PCL5c/PCL-XL) • KPDL3 AES • PDF Direct Print • XPS

Paper Feeder (550-sheet)

Setting	Specifications
Paper Supply Method	Friction roller feeder ECOSYS PA4500cx Capacity 550 sheets (75 g/m ²) × up to 4 cassettes ECOSYS PA4000cx / ECOSYS PA3500cx Capacity 550 sheets (75 g/m ²) × up to 3 cassettes
Paper Size	A4, A5-R, B5, Letter, Legal, B6, Folio, 216 × 340 mm, Statement-R, Executive, Oficio II, 16K, ISO B5, Envelope #10, Envelope #9, Envelope #6 3/4, Envelope Monarch, Envelope DL, Envelope C5, Youkei 4, Youkei 2, Custom (92 × 162 to 216 × 356 mm)
Supported Paper	Paper thickness: 60 to 220 g/m ² Media types: Plain, Preprinted, Bond, Recycled, Thin, Letterhead, Color, Prepunched, Thick, High Quality, Custom, Label, Envelope, Coated
Dimensions (W × D × H)	394 × 532 × 116 mm / 15.51" × 20.94" × 4.56"
Weight	4.4 kg / 9.70 lb

Backing up your data

If the SSD or memory of this machine installed in the machine failed for any reason, the files in the box and various settings saved there will be deleted and cannot be restored. To prevent erasing data, make regular backups as follows.

- Take a backup using KYOCERA Net Viewer.
 - ➔ [Backing up your data using KYOCERA Net Viewer \(page 401\)](#)
- Take a backup using Command Center RX.
 - ➔ [Backing up your data using Command Center RX \(page 401\)](#)

Backing up your data using KYOCERA Net Viewer

Use KYOCERA Net Viewer to regularly back up the data below that is saved on the machine.

- System Settings
- Network Settings
- User List
- Document Box Settings (Except for the file in the Custom Box)

Backing up your data using Command Center RX

Use Command Center RX to regularly back up data saved in the Document Box to your PC.

1 Display the screen.

1

- 2 Launch your Web browser.

In the home screen [Status] > [▲][▼] key > [Network] > [OK] key[]

Click the number or name of the Custom Box in which the document is stored.

2 Download Document

- 1 Select the document data you want to download to your PC.
Only the data of one document can be downloaded at a time.
- 2 Click the [Download] icon. The selected document is displayed in [Selected Files].
- 3 Specify the [Image Quality] and [File Format] as needed.
- 4 Click [Download].

Security Quick Setup Function List

The functions configured in each level of Security Quick Setup are as follows. After selecting the security level, configure the security function according to your operating environment.

TLS

Level 1	Level 2	Level 3
On	On	On

Serverside Settings

The setting item which can be set or configured from Command Center RX.

TLS Version

Level 1	Level 2	Level 3
TLS1.2, TLS1.3	TLS1.2, TLS1.3	TLS1.2, TLS1.3

Effective Encryption

Level 1	Level 2	Level 3
3DES, AES, AES-GCM, CHACHA20/POLY1305	AES-GCM, AES, CHACHA20/POLY1305	AES-GCM, AES, CHACHA20/POLY1305

Hash

Level 1	Level 2	Level 3
SHA1, SHA-2(256/384)	SHA-2(256/384)	SHA-2(256/384)

IPP Security

Level 1	Level 2	Level 3
Secure Only (IPPS)	Secure Only (IPPS)	Secure Only (IPPS)

HTTPS Security

Level 1	Level 2	Level 3
Secure Only (HTTPS)	Secure Only (HTTPS)	Secure Only (HTTPS)

Enhanced WSD Security

Level 1	Level 2	Level 3
Secure Only (Enhanced WSD over TLS)	Secure Only (Enhanced WSD over TLS)	Secure Only (Enhanced WSD over TLS)

Clientside Settings

The setting item which can be set or configured from Command Center RX.

TLS Version

Level 1	Level 2	Level 3
TLS1.2, TLS1.3	TLS1.2, TLS1.3	TLS1.2, TLS1.3

Effective Encryption

Level 1	Level 2	Level 3
3DES, AES, AES-GCM, CHACHA20/POLY1305	AES-GCM, AES, CHACHA20/POLY1305	AES-GCM, AES, CHACHA20/POLY1305

Hash

Level 1	Level 2	Level 3
SHA1, SHA-2(256/384)	SHA-2(256/384)	SHA-2(256/384)

IPv4 Settings (Wired Network)

The setting item which can be set or configured from Command Center RX.

DNS over TLS

Level 1	Level 2	Level 3
Off	Auto	On

Certificate Auto Verification

Level 1	Level 2	Level 3
Expiration Date	Expiration Date	Expiration Date

Hash

Level 1	Level 2	Level 3
SHA-2(256/384)	SHA-2(256/384)	SHA-2(256/384)

IPv4 Settings (Wireless Network)

The setting item which can be set or configured from Command Center RX.

DNS over TLS

Level 1	Level 2	Level 3
Off	Auto	On

Certificate Auto Verification

Level 1	Level 2	Level 3
Expiration Date	Expiration Date	Expiration Date

Hash

Level 1	Level 2	Level 3
SHA-2(256/384)	SHA-2(256/384)	SHA-2(256/384)

IPv6 Settings (Wired Network)

The setting item which can be set or configured from Command Center RX.

DNS over TLS

Level 1	Level 2	Level 3
Off	Auto	On

Certificate Auto Verification

Level 1	Level 2	Level 3
Expiration Date	Expiration Date	Expiration Date

Hash

Level 1	Level 2	Level 3
SHA-2(256/384)	SHA-2(256/384)	SHA-2(256/384)

IPv6 Settings (Wireless Network)

The setting item which can be set or configured from Command Center RX.

DNS over TLS

Level 1	Level 2	Level 3
Off	Auto	On

Certificate Auto Verification

Level 1	Level 2	Level 3
Expiration Date	Expiration Date	Expiration Date

Hash

Level 1	Level 2	Level 3
SHA-2(256/384)	SHA-2(256/384)	SHA-2(256/384)

Other Protocols: HTTP (Client)

The setting item which can be set or configured from Command Center RX.

Certificate Auto Verification

Level 1	Level 2	Level 3
Expiration Date	Expiration Date	Expiration Date

Hash

Level 1	Level 2	Level 3
SHA-2(256/384)	SHA-2(256/384)	SHA-2(256/384)

Other Protocols: SOAP

The setting item which can be set or configured from Command Center RX.

Use Default Settings

Level 1	Level 2	Level 3
On	On	On

Other Protocols: LDAP

The setting item which can be set or configured from Command Center RX.

Certificate Auto Verification

Level 1	Level 2	Level 3
Expiration Date	Expiration Date	Expiration Date

Hash

Level 1	Level 2	Level 3
SHA-2(256/384)	SHA-2(256/384)	SHA-2(256/384)

Send Protocols: SMTP (E-mail TX)

The setting item which can be set or configured from Command Center RX.

Certificate Auto Verification

Level 1	Level 2	Level 3
Expiration Date	Expiration Date	Expiration Date

Hash

Level 1	Level 2	Level 3
SHA-2(256/384)	SHA-2(256/384)	SHA-2(256/384)

Email: POP3 User Settings

The setting item which can be set or configured from Command Center RX.

Certificate Auto Verification

Level 1	Level 2	Level 3
Expiration Date	Expiration Date	Expiration Date

Hash

Level 1	Level 2	Level 3
SHA-2(256/384)	SHA-2(256/384)	SHA-2(256/384)

Print protocols

NetBEUI

Level 1	Level 2	Level 3
On	Off	Off

LPD

Level 1	Level 2	Level 3
On	On	Off

FTP (Receiving)

Level 1	Level 2	Level 3
On	Off	Off

IPP

Level 1	Level 2	Level 3
On	Off	Off

IPP over TLS

Level 1	Level 2	Level 3
On	On	On

Raw

Level 1	Level 2	Level 3
On	On	Off

ThinPrint

Level 1	Level 2	Level 3
On	Off	Off

ThinPrint over TLS

Level 1	Level 2	Level 3
On	__*1	__*1

*1 If you select [Level 2] or [Level 3] in "SecurityQuickSet", this setting will disappear.

WSD Print

Level 1	Level 2	Level 3
On	Off	Off

POP (E-mail RX)

Level 1	Level 2	Level 3
Off	Off	Off

Other Protocols

SNMPv1/v2c

Level 1	Level 2	Level 3
On	On	Off

SNMPv3

Level 1	Level 2	Level 3
Off	Off	Off

HTTP

Level 1	Level 2	Level 3
On	Off	Off

HTTPS

Level 1	Level 2	Level 3
On	On	On

Enhanced WSD

Level 1	Level 2	Level 3
On	Off	Off

Enhanced WSD (TLS)

Level 1	Level 2	Level 3
On	On	On

LDAP

Level 1	Level 2	Level 3
Off	Off	Off

LLTD

Level 1	Level 2	Level 3
Off	Off	Off

VNC (RFB)

Level 1	Level 2	Level 3
Off	Off	Off

VNC (RFB) over TLS

Level 1	Level 2	Level 3
Off	Off	Off

Enhanced VNC (RFB) over TLS

Level 1	Level 2	Level 3
On	Off	Off

TCP/IP: Bonjour Settings

Bonjour

Level 1	Level 2	Level 3
On	On	Off

Network Settings

Wi-Fi Direct Settings

Level 1	Level 2	Level 3
Off	Off	Off

Connectivity

Bluetooth Settings

Level 1	Level 2	Level 3
Off	Off	Off

Interface Block Setting

USB Host

Level 1	Level 2	Level 3
Unblock	Unblock	Block

USB Device

Level 1	Level 2	Level 3
Unblock	Unblock	Block

Optional Interface

Level 1	Level 2	Level 3
Unblock	Unblock	Block

Energy Saver/Timer

Auto Panel Reset

Level 1	Level 2	Level 3
On	On	On

User Account Lockout Setting

Lockout

Level 1	Level 2	Level 3
Off	Off	On

Job Status/Job Logs Settings

Display Jobs Detail Status

Level 1	Level 2	Level 3
Show All	Show All	Hide All (Display only when Administrator)

Display Jobs Log

Level 1	Level 2	Level 3
Show All	Show All	Hide All (Display only when Administrator)

For the KYOCERA contact in your region, see Sales Sites sections here.
<https://www.kyoceradocumentsolutions.com/company/directory.html>