



#23941

Dual Monitor Arm

Dual monitor arm for maximum viewing flexibility and comfortable gaming

Key features

- Dual monitor mount to attach two screens up to 32"
- Compatible with VESA 75x75mm and 100x100mm mounting holes
- Maximum adjustability: tilt, swivel, height, front/back, portrait/landscape orientation
- Improved ergonomics with better posture to prevent neck strain
- Made for multitasking; game while operating chat/Twitch/browser
- Cable management to route cables out of sight



What's in the box

- Dual monitor arm
- Cable management clips
- Assembly materials
- Manual

System requirements

- Monitor up to 32"
- Desk up to 6cm thick



Full Overview

Whether you prefer gaming on two monitors or if you enjoy streaming, the Trust GXT 1120 Mara will help you out. This dual-monitor solution will allow you to attach two monitors, up to 32 inches each, while keeping your desk clean from cables thanks to the cable management system. It will provide you with all the flexibility you need to place your monitors just the way you'd prefer.

Double the Viewing Space

If you want to use two screens, either for gaming, streaming or editing, the Trust GXT 1120 Mara is just what you need. This dual-monitor arm will hold two screens up to 32" with a combined weight of 16kg, without them taking up any space on your desk. That leaves more room for gaming.

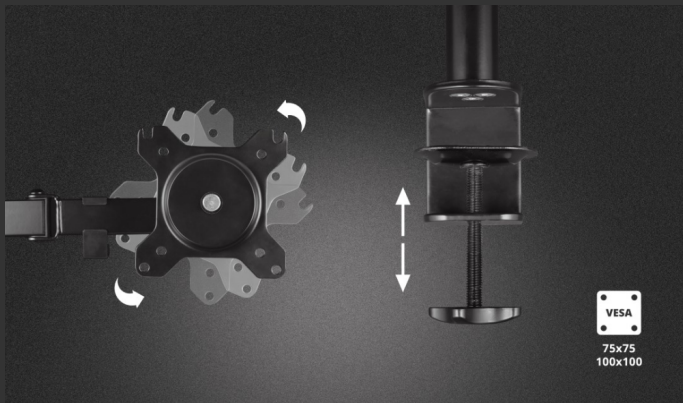
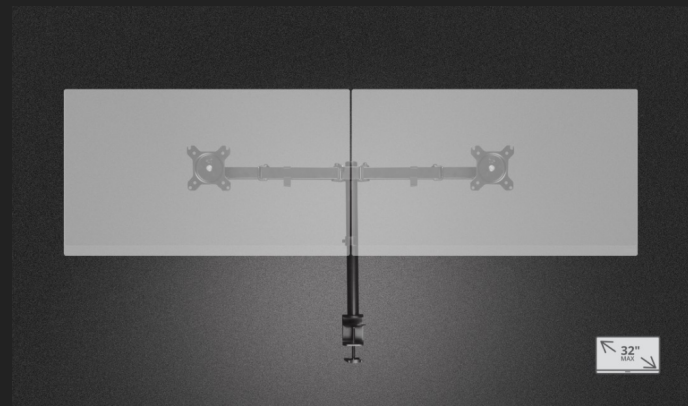

Flexibility

Thanks to the flexibility of the Mara, you'll place the monitors just how you'd prefer. Adjust the height of your monitors to improve your posture and prevent back strain, and tilt, swivel and pivot them to create the setup you want. And because this arm works with any monitor that supports VESA 75 and VESA 100 mounts, you can choose pretty much any monitors you want.

Clean

Two monitors usually mean double the cables, but the Trust GXT 1120 Mara has got you covered. The integrated cable management system will keep all of those cables out of sight. There's no need for monitor stands, so all of the real estate space of your desk remains. That's a lot of freedom of movement.

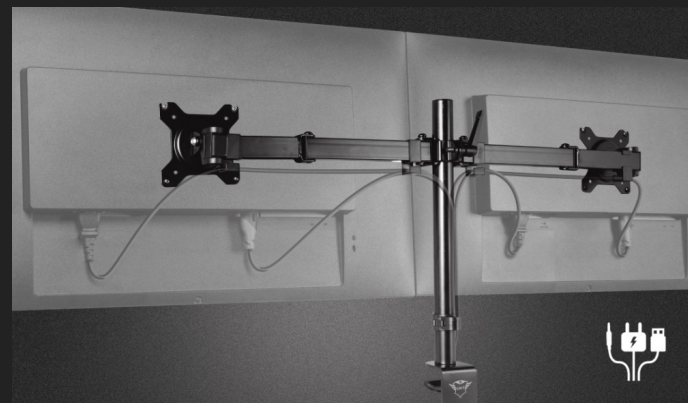

GENERAL

Height of main product (in mm)	510 mm	Width of main product (in mm)	860 mm
Depth of main product (in mm)	115 mm	Total weight	2765 g
Weight of main unit	2682 g		

FEATURES

Cable management	True
-------------------------	------

MOUNT

VESA	100x100mm, 75x75mm	Number of mounting arms	2
Mounting surface	Desk	Mounting type	Clamp
Max mounting surface thickness (cm)	6 cm	Maximum weight (kg)	16 kg

ADJUSTABILITY

Adjustability list	Height, Movability (front to back), Orientation (portrait/landscape), Swivel, Tilt
---------------------------	--

COMPATIBILITY

Maximum screen size (inch)	32 "	Compatible Device Types	Monitor
-----------------------------------	------	--------------------------------	---------



PRODUCT VISUAL 1



PRODUCT PICTORIAL 1

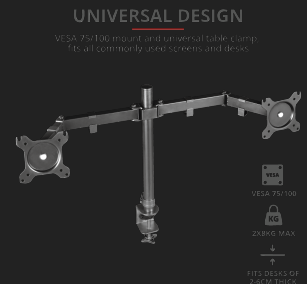

PRODUCT PICTORIAL 2

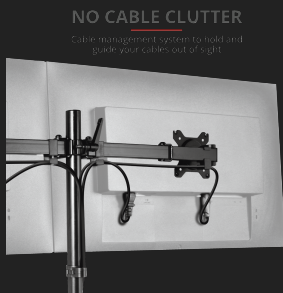

PRODUCT PICTORIAL 3

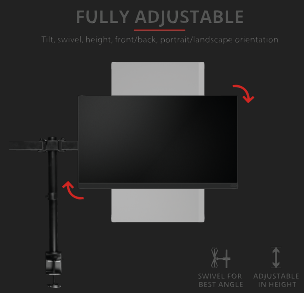

PRODUCT PICTORIAL 4

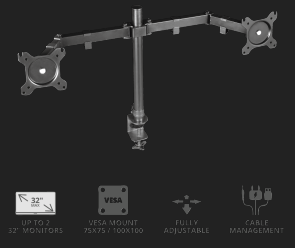

PRODUCT ESHOT 1

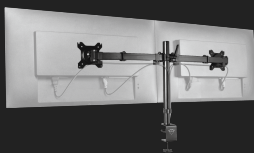

PRODUCT VISUAL 2

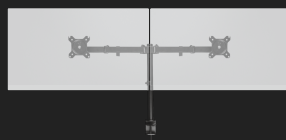

PRODUCT FRONT 1



PRODUCT EXTRA 1

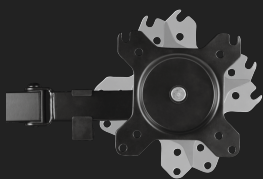

PRODUCT EXTRA 2



PACKAGE VISUAL 1



PACKAGE FRONT 1